

 **PLIEGER**

 **THERMOOORD**
Plieger groep

CATALOGUS2007

Deze catalogus bevat de prijzen per 01-01-2007.

Wij behouden het recht de prijzen te wijzigen.

Op al onze verkopen en leveringen zijn onze algemene verkoops- en betalingsvoorwaarden van toepassing, gedeponeerd bij de Kamer van Koophandel Tiel onder nr. 11089 en Kamer van Koophandel Leeuwarden onder nr. 010 44374.

U vindt de voorwaarden ook achterin deze catalogus.

Sanitair

Sanitair producten

Baden /
douchebakken /
stoomcabines

Kranen

Douchegarnituren

Accessoires
en spiegels

Douchewanden

Toebehoren
& afvoeren

Spoel- /
installatiesystemen

Badkamermeubelen
en toiletkasten

Gootstenen
Wastroggen

Utiliteit



Internet

Niet alleen in deze catalogus heeft u informatie over artikelen bij de hand. U kunt deze gegevens ook via het internet opvragen. Bovendien kunt u via internet een bestelling plaatsen en uitgebreide informatie over nettoprijzen en voorraad opvragen. Ook technische tekeningen, accessoires en alternatieven kunt u met een druk op de knop opvragen. Met de internetsite heeft u voortaan zelf controle over uw bestellingen.

Ook artikel- en conditiebestanden die u in uw calculatieprogramma wilt importeren, kunt u via de site downloaden.

Heeft u nog geen toegang? Vul het formulier in via de site, en u ontvangt de inlogcodes per omgaande. Wanneer u zich aanmeldt bij één van onderstaande sites, krijgt u automatisch toegang tot de andere site met dezelfde inlogcodes.

www.pliegeronline.nl
www.thermonoord.nl

Show-Rom

Uw gehele showroom op cd-rom formaat? Dat is de Show-Rom. Het is onmogelijk bijna 50.000 artikelen te tonen in uw showroom, maar deze zijn wel te vinden op deze unieke cd-rom. U beschikt digitaal over foto's, maatvoeringen, aanvullende artikelen en prijzen. Zonder dat u verbinding hoeft te maken met het internet.

Legenda

Prijs*: Alle genoemde prijzen zijn exclusief B.T.W.
Grp: kortingsgroep
CC: courantheidscode 0 = voorraadartikel
 1 = op bestelling

* Voor Non ferro producten gelden dagprijzen, ook voor die producten uit deze groep waarvoor prijzen vermeld zijn in deze catalogus.

Bij de samenstelling van deze catalogus is de grootst mogelijke nauwkeurigheid betracht t.a.v. de juiste vermelding van informatie en prijzen. Mochten desondanks toch nog onjuiste vermeldingen voorkomen dan zal de afnemer hieraan geen recht kunnen ontleen.

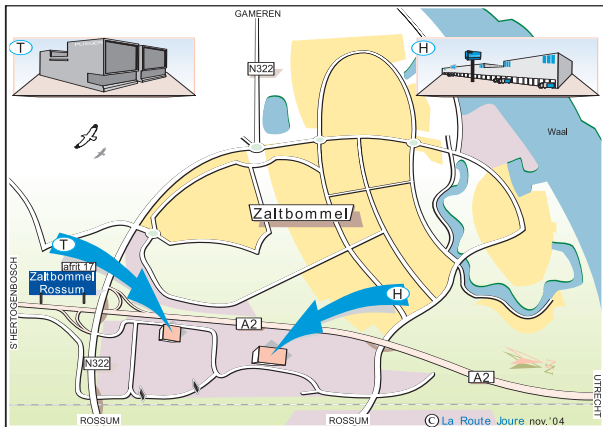

Hoofdkantoor Plieger

Koxkampseweg 6
 5301 KK Zaltbommel
 Postbus 10
 5300 AA Zaltbommel
 Telefoon: 0418 - 682 682
 Fax: 0418 - 680 207

www.plieger.nl
www.pliegeronline.nl
www.ontwerpuwbadkamer.nl
post@plieger.nl

Vanuit 's Hertogenbosch : Volg de A2 tot afrit 17 "Zaltbommel". Neem deze afrit en ga rechtdoor richting Van Voordenpark. Lees verder..*

Vanuit Utrecht : Volg de A2 tot afrit 17 "Zaltbommel" en neem deze afrit. Ga vervolgens links richting Van Voordenpark. Sla na het viaduct linksaf het Van Voordenpark op. Lees verder..*

* U rijdt nu op Van Voordenpark. Na de kruising ziet u de Plieger Toonzaal A2 aan uw rechterhand. Als u nog verder doorrijdt en de weg naar rechts en vervolgens naar links volgt, dan ziet u het Plieger Hoofdkantoor aan uw linkerhand.



Hoofdkantoor ThermoNoord

Hoofdkantoor ThermoNoord
 Tolhûsleane 7
 8401 GA Gorredijk
 Postbus 133
 8400 AC Gorredijk
 Telefoon: 0 513 - 46 99 99
 Fax: 0 513 - 46 99 09

www.thermonoord.nl
info@thermonoord.nl

Vanaf de A7, vanuit Heerenveen of Drachten neemt u afslag 27 [Tijnje - Gorredijk] richting Gorredijk (N392). Na ca. 3 km komt u voor Gorredijk en slaat u links af, richting bedrijventerrein "Overtoom". U rijdt daarna over de brug, tot aan de rotonde. Deze neemt u 3/4. Na ca. 200 meter ziet u ThermoNoord aan uw linker hand.

A Aphaalbalie **B** Eigen bezorgdienst **T** Toonzaal **E** Express zelfbedieningsafhaalmagazijn **V** Verkoop per telefoon en fax

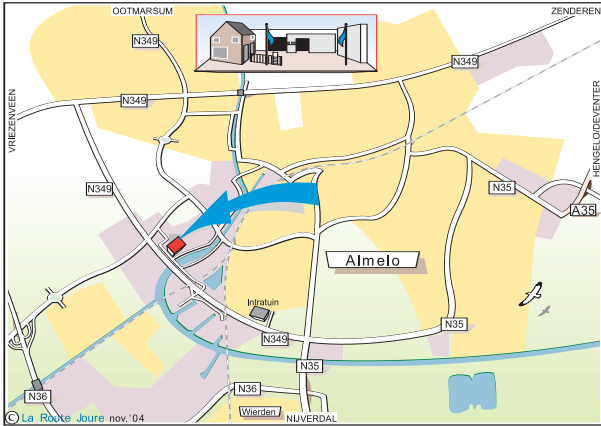

Plieger Almelo

E V

Turfkade 27a
7602 PB Almelo

Telefoon: 05 46 - 87 00 05

Fax: 05 46 - 87 00 04

Openingstijden

Express: maandag t/m vrijdag 7.30uur-17.00uur
(vrijdag tot 15.30uur)

Contactpersonen

Vestigingsleider: René Gruwel

Buitendienst: Harm Boltjes

Express: Jan Ravenhorst
Marcel Koertshuis

Vanuit Hengelo / Enschede: Volg de A35 tot het einde waarna het wegnummer verandert in N35. Volg de N35 richting Noord/Turfkade E. De weg buigt naar rechts. Bij de kruising, waar de N35 naar links afslaat, gaat u rechtdoor (N349). Lees verder.*

Vanuit Deventer: Volg de A1 tot Knooppunt Azelo en ga daar richting Almelo. De A35 rijdt u helemaal uit waarna het wegnummer verandert in N35. Volg de N35 richting Noord/Turfkade E. De weg buigt naar rechts. Bij de kruising, waar de N35 naar links afslaat, gaat u rechtdoor (N349). Lees verder.*

Vanuit Nijverdal: Volg de N35 tot Almelo. Sla na de brug linksaf (N349). Lees verder.*

* U rijdt op de "Schuilenburgsingel". U passeert Intratuin en een spoorbrug. Daarna gaat u rechtsaf richting "Slachthuisgade". Volg de weg onder de spoor-tunnel door en over de brug. Na de brug gaat u rechtsaf, waar u Plieger meteen aan uw linkerhand ziet.

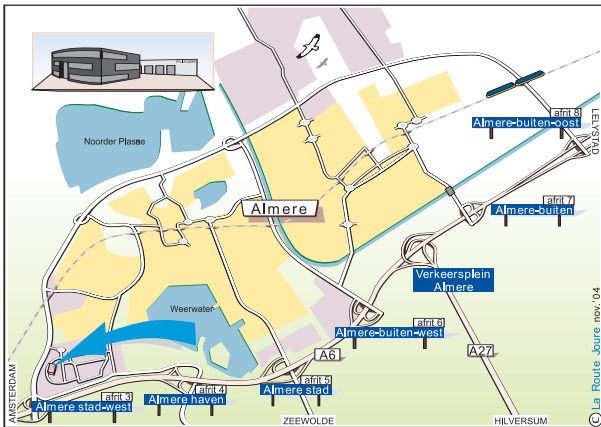

Plieger Almere

E V

Transistorstraat 108
1322 CH Almere

Telefoon: 0 36 - 536 03 85

Fax: 0 36 - 536 24 73

Openingstijden

Express: maandag t/m vrijdag 7.30uur-17.00uur
(vrijdag tot 15.30uur)

Contactpersonen

Vestigingsleider:

Buitendienst: Hans Kos

Express: Ewout van Oosterom
Barry Reijnders

Vanuit Amsterdam / Lelystad: Volg de A6 tot afrit 3 "Almere Stad-West" en volg de S101. Lees verder.*

Vanuit Hilversum: Volg de A27 tot Knooppunt Almere en ga daar richting Amsterdam. Op de A6 neemt u afrit 3 "Almere Stad-West" en volg de S101. Lees verder.*

* U rijdt nu op de Hoge Ring, neem de tweede afslag naar rechts, de Audioweg op. Neem de rotonde 1/4 over de Monitorweg, ga de eerste afslag naar rechts. Na 300 meter ziet u Plieger aan uw linkerhand.



Vanuit Leiden: Volg de N11 tot Alphen aan den Rijn en bij de verkeerslichten linksaf. Lees verder.*

Vanuit Utrecht: Volg de N11 tot Alphen aan den Rijn, onder het Aquadukt door en bij de verkeerslichten rechtdoor. Ga bij de volgende verkeerslichten rechtsaf. Lees verder.*

* U rijdt nu op de Leidse Schouw. Ga bij de verkeerslichten rechts, de Hoorn op. Na 2 kilometer ziet u Plieger aan uw linkerhand.

Plieger Alphen a/d Rijn

Hoorn 100

2404 HJ Alphen a/d Rijn

E V Telefoon: 0172 - 50 13 51

Fax: 0172 - 24 16 93

T Telefoon: 0172 - 41 80 70

Fax: 0172 - 24 16 93

Openingstijden

Express: maandag t/m vrijdag 7.30uur-17.00uur
(vrijdag tot 15.30uur)
Toonzaal: dinsdag t/m vrijdag 9.00uur-17.00uur
vrijdagavond 18.00 uur - 21.00 uur
zaterdag 10.00 uur - 15.00 uur

Contactpersonen

Vestigingsleider: Ruud Schellingerhout

Buitendienst: Henk Poldervaart
Walter Van Hattum

Toonzaal: Roy van Bommel
Joris Hermans
Edith Van Leeuwen
Jean Waeijen

Express: Ben Drager
Arjan Welman

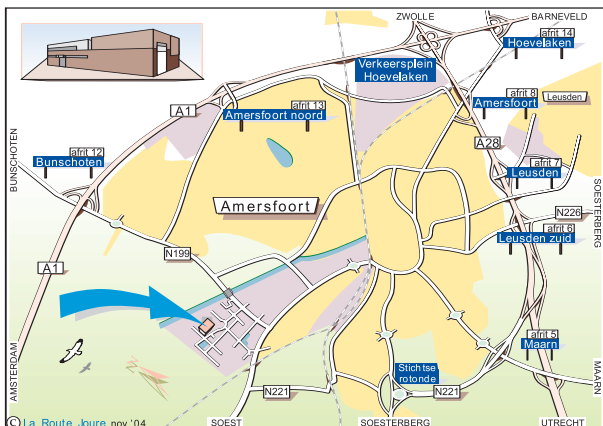

Vanuit Utrecht: Volg de A28 tot afrit 5 "Maarn" en ga daar richting Amersfoort Zuid. U rijdt over de N221 "Rondweg zuid", blijf deze weg volgen, over de Stichtse Rotonde rechtdoor. De naam van de weg verandert: N221 "Daam Fockemalaan" en vervolgens "Barchman Wuyterslaan". Blijf deze weg volgen en sla aan het einde rechtsaf de N199 "Amsterdamse weg" op. Neem de eerste afslag links, houd rechts aan over de Heliumweg. Als de weg een bocht naar rechts maakt, slaat u linksaf de Nijverheidsweg Noord op. U ziet Plieger aan uw rechterhand.

Vanuit Zwolle: Volg de A28 tot Knooppunt Hoevelaken en ga daar richting Amsterdam. Op de A1 neemt u afrit 12 "Bunschoten" en ga daar richting Amersfoort. Lees verder.*

Vanuit Amsterdam / Barneveld: Volg de A1 tot afrit 12 "Bunschoten" en ga daar richting Amersfoort. Lees verder.*

* U rijdt op de N199 Bunschoterstraat. Ga bij de rotonde rechtdoor en blijf de weg volgen. Over de brug neemt een de eerste afslag rechts (stoplichten) de Nijverheidsweg Noord op. Volg de weg en bij de bocht naar links gaat u rechts. U ziet Plieger aan uw rechthand.

Plieger Amersfoort

A B T V

Nijverheidsweg 95 N

3812 PL Amersfoort

Telefoon: 0 33 - 422 07 50

Fax: 0 33 - 461 95 77

Openingstijden

Kantoor: maandag t/m vrijdag 8.00uur-17.00uur
(vrijdag tot 15.30uur)

Balie: maandag t/m vrijdag 7.30uur-17.00uur
(vrijdag tot 15.30uur)

Toonzaal: dinsdag t/m vrijdag 9.00 uur - 17.00 uur
dinsdagavond 18.00uur - 21.00uur
zaterdag 10.00uur - 15.00uur

Contactpersonen

Vestigingsleider: Carel Kraaijenhagen

Buitendienst: Sander Achterbergh
William van Rijnsoever

Binnendienst: Gerrit Satter
Jan Evers
Chris Kuitert

Toonzaal: Nanda Elgeti
Thea Schlebaum

Balie: Albert van Hienen

A Aphaalbalie **B** Eigen bezorgdienst **T** Toonzaal **E** Express zelfbedieningsafhaalmagazijn **V** Verkoop per telefoon en fax

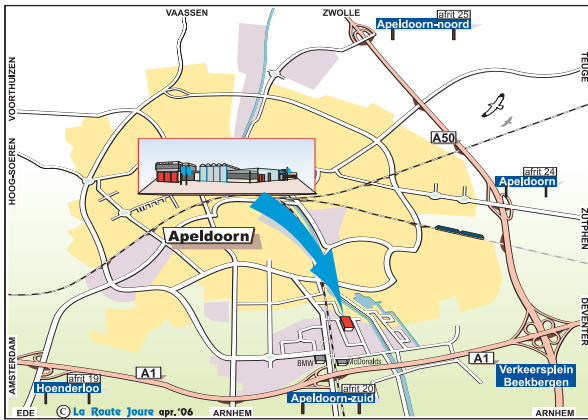

Vaait alle richtingen A1 Amersfoort / Deventer afslag Apeldoorn Zuid(afrit 20),
einde van de afrit links daarna 2e weg rechts.
U vindt Plieger aan de rechter zijde.

Plieger Apeldoorn

Aruba 5, 7332 BJ Apeldoorn

E Telefoon: 0 55 - 538 99 61/62/63

Fax: 0 55 - 538 99 66

Saba 12, 7332 BH Apeldoorn

B V T Telefoon: 0 55 - 538 99 99

Fax: 0 55 - 542 08 24

Openingstijden

Kantoor: maandag t/m vrijdag 8.00uur-16.30uur
Balie: maandag t/m vrijdag 8.00uur-16.30uur
Toonzaal: dinsdag t/m vrijdag 9.00 uur - 17.00 uur
donderdag 18.00uur - 21.00uur
zaterdag 10.00uur - 15.00uur

Contactpersonen

Vestigingsleider: Evert Haverkamp
Buitendienst: Jeroen Wonink
Binnendienst: Gerwin van Doonijwaard
Arvid van Stegeren
Angelo Taribuka
Tjeerd Looten
Gijs Marris
Toonzaal: Ernst Jan van Egten
Wout van Zandbrink
Chester Mijnhals
Express: André Wolters
Balie: Daniël van der Velde
John Mäkel
Michiel de Lange

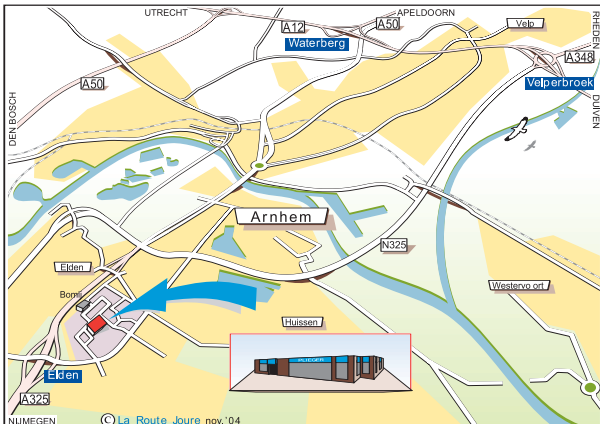

Vanuit Nijmegen: Volg de A325 tot aan knooppunt "Elden". Aan het eind van de afrit rechtsaf. Vervolgens neemt u de eerste weg links. Rij deze uit tot het eind. Hier rechtsaf. Na de volgende kruising ziet u Plieger tegenover Bomij aan uw rechterhand. Lees verder.....*

Vanuit Utrecht: Volg de A12 tot aan verkeersplein "Velperbroek". Volg de N325, over de Rijn, tot aan de A325. Ga hier richting Nijmegen, tot aan knooppunt "Elden". Aan het eind van de afrit linksaf, over de A325 heen. Vervolgens neemt u de eerste weg links. Lees verder.....*

Vanuit Rheden: Vanaf de A348 komt u bij verkeersplein Velperbroek. Neem de rotonde half, dus onder de A12 door. Dit is de N325. Volg de N325, over de Rijn, tot aan de A325. Ga hier richting Nijmegen, tot aan knooppunt "Elden". Aan het eind van de afrit linksaf, over de A325 heen. Vervolgens neemt u de eerste weg links. Lees verder.....*

Vanuit Duiven: Volg de A12 tot aan verkeersplein "Velperbroek". Volg de N325, over de Rijn, tot aan de A325. Ga hier richting Nijmegen, tot aan knooppunt "Elden". Aan het eind van de afrit linksaf, over de A325 heen. Vervolgens neemt u de eerste weg links. Lees verder.....*

Plieger Arnhem

E T V

De Overmaat 60

6831 AJ Arnhem

Telefoon: 0 26 - 3 27 29 77

Fax: 0 26 - 3 27 22 09

Openingstijden

Kantoor: maandag t/m vrijdag 8.00uur-17.00uur
(vrijdag tot 15.30uur)
Express: maandag t/m vrijdag 7.30uur-17.00uur
(vrijdag tot 15.30uur)
Toonzaal: dinsdag t/m vrijdag 9.00 uur - 17.00 uur
donderdag 18.00uur - 21.00uur
zaterdag 10.00uur - 15.00uur

Contactpersonen

Vestigingsleider: Evert Haverkamp
Buitendienst: Marc Janssen
Toonzaal: Hans Anders
Express: Danny Jansen

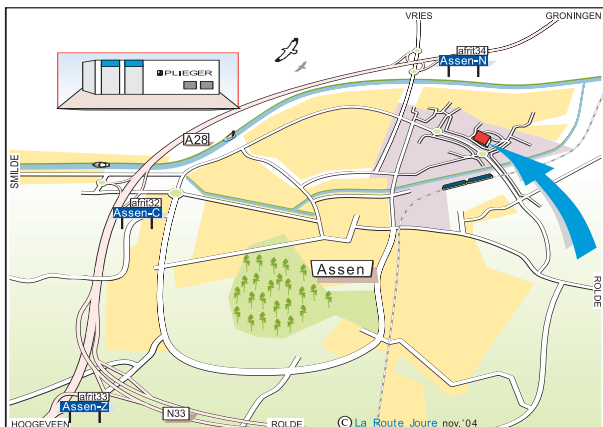

Plieger Assen

A B V

Zeilmakerstraat 4

9403 VA Assen

Telefoon: 05 92 - 34 43 44

Fax: 05 92 - 34 59 66

Openingstijden

Kantoor: maandag t/m vrijdag 8.00uur-17.00uur

Balie: maandag t/m vrijdag 7.30uur-17.00uur

Contactpersonen

Vestigingsleider: Jan Braam

Buitendienst: John van de Brink
Alex Boskers

Binnendienst: Frans Lieuwes
Willy Schuttrups
Greet Drenth
Michiel Bultstra
Martin Drenth

Balie: Johanna Kingma

Vanuit Groningen: Verlaat de A28 bij afrit 34. Ga onder de A28 door, bij de rotonde rechtdoor, richting centrum. Lees verder.....*

Vanuit Hoogeveen: Verlaat de A28 bij afrit 34. Neem de rotonde ¾, richting centrum. Lees verder.....*

Vanuit Rolde: Volg de N378 tot aan het eind. Op de kruising rechtsaf. Dit is de Europaweg-noord. Volg deze, over het spoor en het kanaal. Neem de rotonde ¼. Dan direct links af. U ziet dan Plieger aan uw rechterhand.

Vanuit Smilde: Voor de A28 rechtsaf. Op de rotonde rechtdoor en dan linksaf, onder de A28 door. Neem de oprit van de A28 richting Groningen. Verlaat de A28 bij afrit 34. Neem de rotonde ¾, richting centrum. Lees verder.....*

Over het water en op de Europaweg-noord links af. Neem de tweede rotonde ¾. Dan direct links af. U ziet dan Plieger aan uw rechterhand.

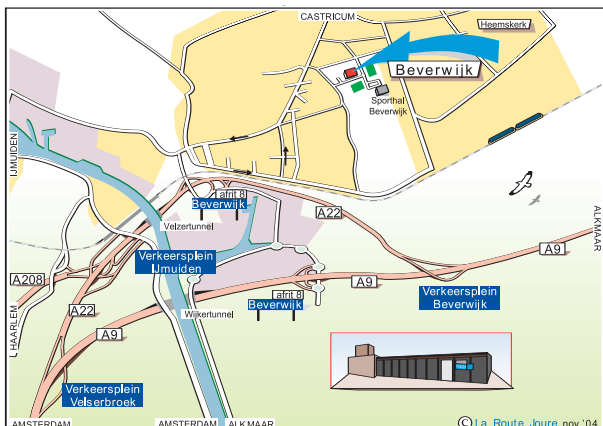

Plieger Beverwijk

E V

Laan van Meerestein 12

1945 TA Beverwijk

Telefoon: 0 251 - 23 09 56

Fax: 0 251 - 23 10 33

Openingstijden

Express: maandag t/m vrijdag 7.30uur-17.00uur
(vrijdag tot 15.30uur)

Contactpersonen

Vestigingsleider: Ko van Heijst

Buitendienst: Eric Lust
Jacco de Groot

Express: Loek Wilderom

Vanuit Amsterdam: Volg de A9 tot Knooppunt Velsbroek en ga daar richting IJmuiden/Beverwijk. Neem op de A22 afrit 8 "Beverwijk". Lees verder..*

Vanuit Alkmaar: Volg de A9 tot Knooppunt Beverwijk en ga daar richting Beverwijk/IJmuiden. Op de A22 neemt u afrit 8 "Beverwijk" en ga daar richting Beverwijk. Lees verder..*

Vanuit Haarlem: Volg de A208 tot knooppunt IJmuiden en ga daar richting Beverwijk. Op de A22 neemt u afrit 8 "Beverwijk". Lees verder..*

* U rijdt nu op de Velsertaverse, volg deze weg naar rechts. Neem de eerste afslag rechts naar de Halve Maan / Wijckermolen. U rijdt langs het station. Na het station neemt u de derde afslag naar links, de Schans. Volg deze eenrichtingsweg, die vanzelf overgaat in de de Alkmaarseweg. Na 700 meter neemt u de afslag naar rechts, de Overboslaan op. Neem vervolgens de tweede afslag naar links en na 150 meter ziet u Plieger aan uw linkerhand.

A Aphaalbalie B Eigen bezorgdienst T Toonzaal E Express zelfbedieningsafhaalmagazijn V Verkoop per telefoon en fax

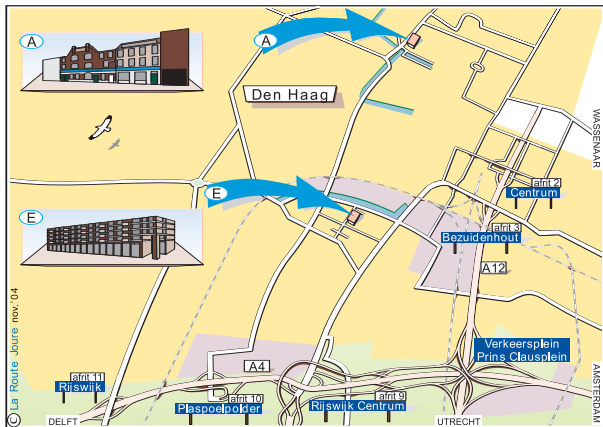

E) Slachthuisstraat

Vanuit Amsterdam / Delft A4: Volg de A4 tot afrit 10 "Plaspoelpolder" en ga daar richting Den Haag Zuid. Lees verder..*

Vanuit Utrecht: Volg de A12 tot Knooppunt Prins Clausplein. Ga daar richting Delft en neem afrit 10 "Plaspoelpolder". Sla daar rechtsaf richting Den Haag Zuid. Lees verder..*

* U rijdt nu op de Diepenhorstlaan. Blijf deze weg volgen terwijl de naam verandert in Veraartlaan, Burgemeester Eisenlaan, De Genestetlaan en Slachthuislaan. Sla voor het water rechtsaf de Neherkade op. Neem de volgende afslag rechtsaf en u rijdt op de Slachthuisstraat, waar u Plieger aan uw linkerhand ziet.

Plieger Den Haag

Slachthuisstraat 22
2521 SH Den Haag

E V Telefoon: 0 70 - 307 76 02
Fax: 0 70 - 319 13 80

Openingstijden

Express: maandag t/m vrijdag 7.30uur-17.00uur
(vrijdag tot 15.30uur)

Contactpersonen

Vestigingsleider: Ruud Schellingerhout

Buitendienst: Marcel Schoenmakers

Binnendienst: Perry Roos

Express: Deepak Ganga
Gerard Slegtenhorst

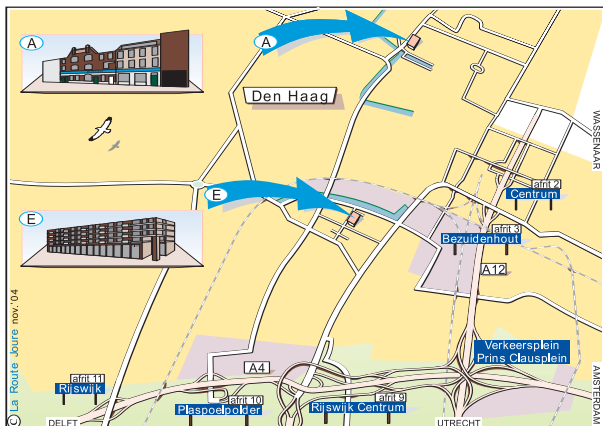

A) Waldeck Pymontkade

Vanuit Amsterdam / Delft A4: Volg de A4 tot Knooppunt Prins Clausplein. Ga daar richting Den Haag. Rijdt de A12 helemaal uit en sla linksaf richting Den Haag Centrum. Lees verder..*

Vanuit Utrecht: Volg de A12 tot het einde. Sla daar linksaf richting Den Haag Centrum. Lees verder..*

* Sla bij de T-splitsing linksaf de Koningskade / Raamweg op. Neem de tweede mogelijkheid om naar links te gaan, de Copes van Cattenburchlaan op. Volg deze weg om het Vredespaleis heen en houd vervolgens links aan (Carnegielaan). Direct daarna slaat u bij de T-splitsing rechtsaf. Op de Laan van Meerdervoort neemt u de vierde afslag links. De rechterkant van deze weg heet Koningin Emmakade en de linkerkant heet Waldeck Pymontkade. Na 700 meter zit Plieger aan de linkerkant.

Plieger Den Haag

A V
W. Pymontkade 25-27
2518 RS Den Haag
Telefoon: 0 70 - 365 69 36
Fax: 0 70 - 363 49 74

Openingstijden

Balie: maandag t/m vrijdag 7.30uur-17.00uur
(vrijdag tot 14.30uur)

Contactpersonen

Vestigingsleider: Ruud Schellingerhout

Buitendienst: Marcel Schoenmakers

Binnendienst: Perry Roos

Balie: Paul de Jong

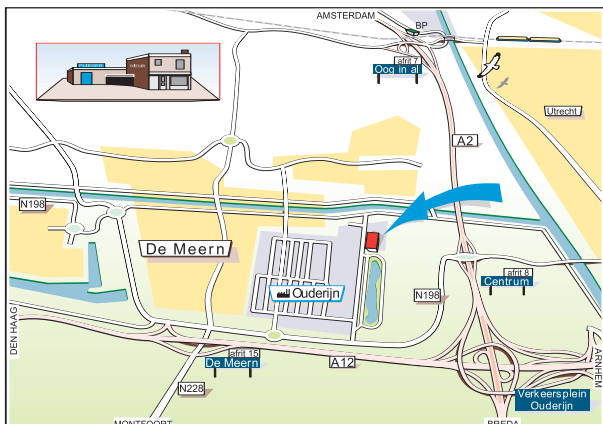

Vanuit Breda / Amsterdam: Volg de A2 tot afrit 8 "Utrecht Centrum" en ga daar richting De Meern. Lees verder.*

Vanuit Den Haag / Arnhem: Volg de A12 tot Knooppunt Ouderijn en ga daar richting Amsterdam. Op de A2 neemt u afrit 8 neem afrit "Utrecht Centrum" en ga daar richting De Meern. Lees verder.*

* Volg de N198 "C H Letschertweg" naar De Meern. Na 3 kilometer neemt de rotonde 1/3 industrieterrein Ouderijn op. Na 1 kilometer ziet u Plieger aan uw rechterhand.

Plieger De Meern

A B V

Strijkviertel 54
3454 PN De Meern

Telefoon: 0 30 - 6 66 17 77
Fax: 0 30 - 6 66 54 85

Openingstijden

Kantoor: maandag t/m vrijdag 8.00uur-17.00uur
(vrijdag tot 15.30uur)
Balie: maandag t/m vrijdag 7.30uur-17.00uur
(vrijdag tot 15.30uur)

Contactpersonen

Vestigingsleider: Rob Korpel

Buitendienst: Hendrik Achterberg
Michel van Heeswijk

Binnendienst: Frank Verheul
Ted Mourits
Jacco Bielsma

Balie: Rik Olikan
Vincent Linge

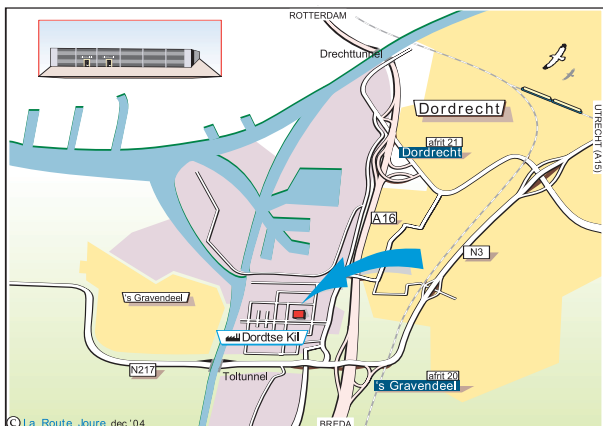

Vanuit Utrecht (A15): Neem bij afrit 23 de N3, door Dordrecht heen. Ten zuiden van Dordrecht gaat deze weg over het spoorviaduct en over het viaduct met de A16. Lees verder..*

Vanuit Rotterdam / Breda: Volg de A16 tot afrit 20, 's Gravendeel. Hier verlaat u de A16, richting 's Gravendeel en de toltunnel. Lees verder..*

* Direct hierna gaat u rechtsaf. Volg deze weg tot aan de verkeerslichten bij de afslag naar bedrijventerrein "Dordtse Kil". Hier gaat u linksaf na de volgende kruising ziet u Plieger & ThermoNoord aan uw rechter hand.

Plieger Dordrecht

Kamerlingh Onnesweg 13
3316 GK Dordrecht

A B V Telefoon: 0 78 - 6 52 16 66
Fax: 0 78 - 6 18 22 87

T Telefoon: 0 78 - 6 52 16 58 / 9
Fax: 0 78 - 6 18 22 87

Openingstijden

Kantoor: maandag t/m vrijdag 8.00uur-17.00uur
(vrijdag tot 15.30uur)
Balie: maandag t/m vrijdag 7.30uur-17.00uur
(vrijdag tot 15.30uur)
Toonzaal: dinsdag t/m vrijdag 9.00uur-17.00uur
donderdagavond 18.00 uur - 21.00 uur
zaterdag 10.00 uur - 15.00 uur

Contactpersonen

Vestigingsleider: Frits Pronk

Buitendienst: Cees Booij
Gerard Rollof

Binnendienst: Waldo Renfurm
Peter Steendam
Trudy Grootenboer

Toonzaal: Jeanine Bengtsson
Leo den Hollander

Balie: Rob Kruithof
Johan van de Vlugt

A Aphaalbalie **B** Eigen bezorgdienst **T** Toonzaal **E** Express zelfbedieningsafhaalmagazijn **V** Verkoop per telefoon en fax

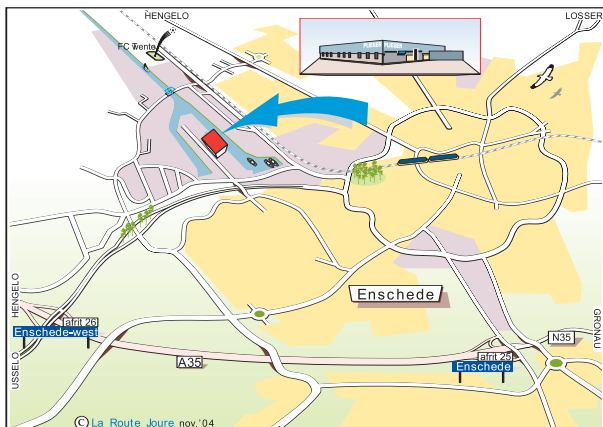

Plieger Enschede

E V

Binnenhaven 100
7547 BH Enschede
Telefoon: 053 - 4 80 31 51
Fax: 053 - 4 80 31 59

Openingstijden

Express: maandag t/m vrijdag 7.30uur-17.00uur
(vrijdag tot 15.30uur)

Contactpersonen

Vestigingsleider: René Gruwel

Buitendienst: Harm Boltjes

Express: Willem van Workum
Henk Plekkenpol

Vanuit Hengelo / Duitsland: Volg de A35/N35 tot afrit 26 "Enschede-west" en ga daar richting Enschede. U rijdt nu op de Westerval, neem de eerste afrit en sla linksaf de Aflinkstraat / Auke Vleerstraat op. Neem meteen de eerste afslag naar rechts, de Hendrik ter Kuilestraat op. De vijfde afslag naar links is de Binnenhaven, waar u na 500 meter Plieger aan uw rechterhand ziet.

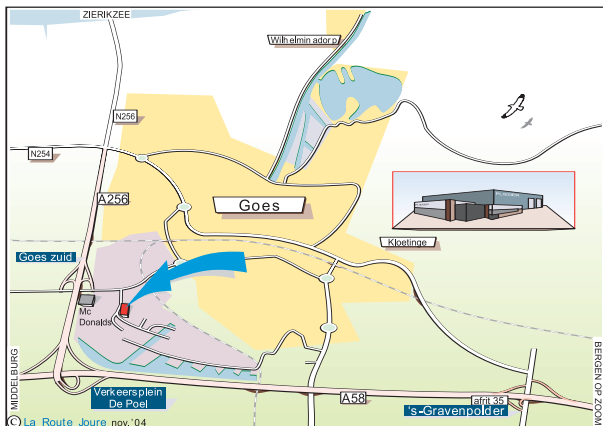

Plieger Goes

Nansenbaan 15
4462 GR Goes

E B V Telefoon: 01 13 - 24 64 64
Fax: 01 13 - 23 12 56
T Telefoon: 01 13 - 24 64 65
Fax: 01 13 - 23 12 56

Openingstijden

Kantoor: maandag t/m vrijdag 8.00uur-17.00uur
(vrijdag tot 15.30uur)

Express: maandag t/m vrijdag 7.30uur-17.00uur
(vrijdag tot 15.30uur)

Toonzaal: dinsdag t/m vrijdag 9.00 uur - 17.00 uur
donderdag 18.00uur - 21.00uur
zaterdag 10.00uur - 15.00uur

Contactpersonen

Vestigingsleider: Piet de Haze

Buitendienst: Danker Smallegange
Michel van Immerseel

Binnendienst: Koen Mertens
Peter Priem
Ad Wisse
Bas Vermeulen
Martien van der Schraaf

Toonzaal: Toon Menheere

Express: Patrick Polfliet

Vanuit Middelburg / Bergen op Zoom: Volg de A58 tot knooppunt De Poel en ga daar richting Zierikzee. Neem op de A256 afrit "Goes Zuid" en neem de rotonde 3/4 richting Industrieterrein De Poel. Lees verder..*

Vanuit Zierikzee: Volg de N256/A256 en neem afrit "Goes Zuid". Ga linksaf en bij de rotonde rechtdoor richting Industrieterrein De Poel. Lees verder..*

* U rijdt op de Anthony Fokkerlaan. Neem de eerste afslag rechts, de Nansenbaan op. Volg de weg en na de bocht ziet u Plieger aan uw linkerhand.

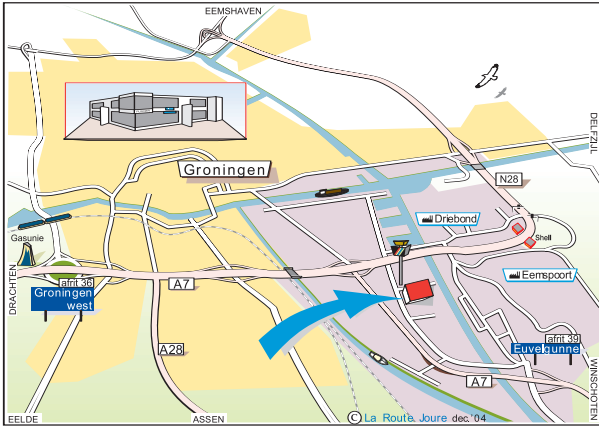

Vanuit Drachten: Volg de A7, voorbij het pand van de Gasunie, over de brug, richting Delfzijl. Voorbij de Shellstations links af, industrieterrein "Driebond" op. Lees verder.....*

Vanuit Assen: Volg de A28 tot aan de A7. Ga hier rechts af, over de brug, richting Delfzijl. Voorbij de Shellstations links af, industrieterrein "Driebond" op. Lees verder.....*

Vanuit Winschoten: Volg de A7 tot afrit 39 (Evelgunne/Westerbroek). Onder aan de afrit rechts en meteen links aanhouden. Over het kanaal. Volg de weg tot aan de reclamezuil van GHC. Juist hiervoor ziet u Plieger aan uw rechterhand.

Vanuit Delfzijl: Ga onder de N28 door en meteen links af, de N28 op richting Drachten. Over de brug rechts af, industrieterrein "Driebond" op. Lees verder.....*

*Volg de weg, over de brug. U rijdt langs de A7. Aan het eind links af, onder de snelweg door.

Aan de linkerkant staat de reclame zuil van GHC. Iets verder staan Plieger & Thermo Noord aan dezelfde kant.

Plieger Groningen

T V

Osloweg 55
9723 BH Groningen
Telefoon: 0 50 - 3 18 88 80
Fax: 0 50 - 3 18 37 74

Openingstijden

Toonzaal: dinsdag t/m vrijdag 9.00uur-17.00uur
donderdagavond 18.00 uur - 21.00 uur
zaterdag 10.00 uur - 15.00 uur

Contactpersonen

Vestigingsleider: Jan Braam

Buitendienst: John van de Brink
Alex Boskers

Toonzaal: Edwin Groenewold
Rinco Ennema
Carla Oosterhoff-Bollen

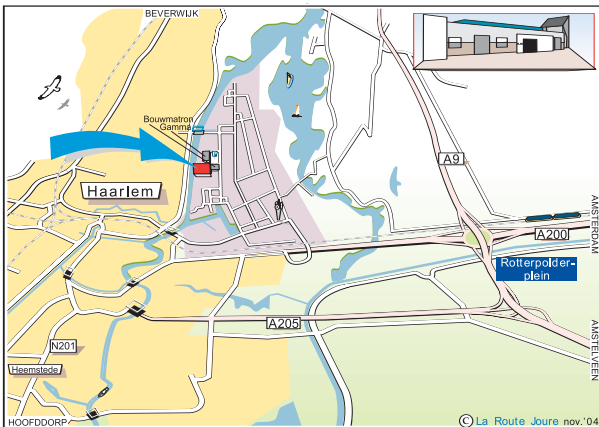

Vanuit Amsterdam: Volg de A200 tot het einde en neem bij de T-splitsing de afslag naar rechts, de Gedempte Herensingel / Gedempte Oostersingelgracht op. Lees verder..*

Vanuit Amstelveen / Beverwijk: Volg de A9 tot Knooppunt Rottelpolderplein en ga daar richting Haarlem. Rijdt de A200 helemaal uit en neemt op het einde bij de T-splitsing de afslag naar rechts de Gedempte Herensingel / Gedempte Oostersingelgracht op. Lees verder..*

* Bij de volgende T-splitsing gaat u linksaf, over de brug en meteen daarna rechts de Spaarndamseweg op. Neem de eerste afslag rechts naar Industrierweg en daarna de tweede afslag rechts naar Heringaweg. Na 300 meter ziet u rechts een parkeerterrein met Gamma. Neem de tweede afslag van dat parkeerterrein en na de Bouwmatron ziet u Plieger aan uw linkerhand.

Plieger Haarlem

E B T V

Heringaweg 6
2031 BW Haarlem
Telefoon: 0 23 - 5 53 99 55
Fax: 0 23 - 5 42 35 41

Openingstijden

Kantoor: maandag t/m vrijdag 8.00uur-17.00uur
(vrijdag tot 15.30uur)
Express: maandag t/m vrijdag 7.30uur-17.00uur
(vrijdag tot 15.30uur)
Toonzaal: dinsdag t/m zaterdag 9.00 uur - 17.00 uur

Contactpersonen

Vestigingsleider: Ko van Heijst

Buitendienst: Eric Lust
Jacco de Groot

Binnendienst: Martien de Bok
Jennifer Hoes
Simon van Kampen

Toonzaal: Paul v.d. Heijden
Michel Noordzij
Evelien Grudelbach

Express: Drazen Divcovic

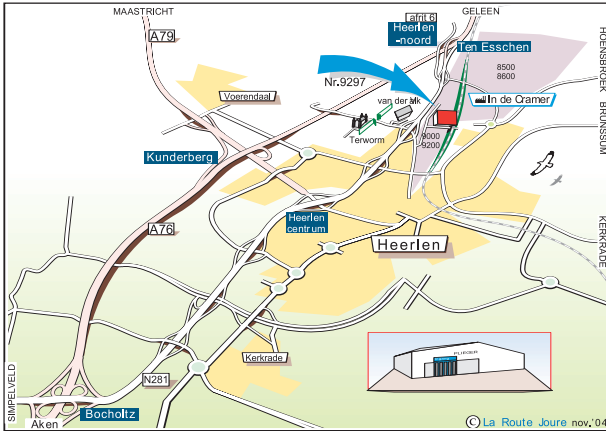

Plieger Heerlen

E V

Dudoklaan 3
6411 RT Heerlen

Telefoon: 0 45 - 57 17 866

Fax: 0 45 - 57 18 857

Openingstijden

Express: maandag t/m vrijdag 7.30uur-17.00uur
(vrijdag tot 15.30uur)

Contactpersonen

Vestigingsleider: Tom Goossen

Buitendienst: Jo van Hoof

Express: Dave Koster

Algemeen:

Volg de borden met de industrienummering. Plieger heeft nummer 9297.

Vanuit Geleen: Volg de A76 tot aan afrit 6 van verkeersplein "Ten Esschen". Verlaat hier de A76. U komt nu op de N281. Verlaat de N281 bij de 2e afrit (9000) en rij linksaf onder de N281 door. Lees verder.....*

Vanuit Maastricht: Volg de A79 tot aan de N281. Onder de N281 door en de oprit linksaf nemen. Verlaat de N281 bij de 2e afrit (9000) en rij linksaf onder de N281 door. Lees verder.....*

Vanuit Aken: Volg de A76 tot aan verkeersplein "Bocholtz", richting Heerlen. U rijdt nu op de N281. Volg deze tot aan de afrit bij Terworm en motel Van der Valk. (9000). Lees verder.....*

* Neem de eerste weg links en de eerste weg rechts. Juist voor de spoortunnel ziet u Plieger aan uw linkerhand.

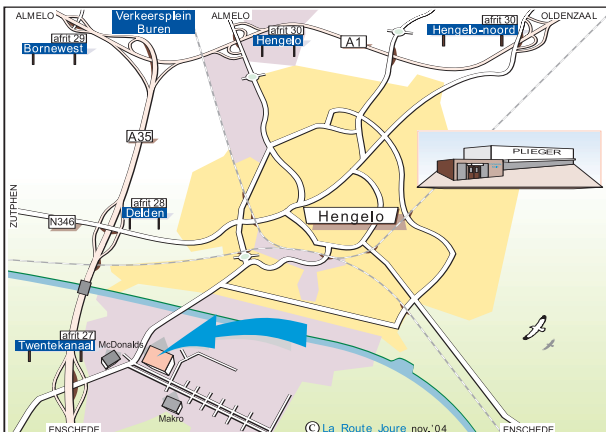

Plieger Hengelo

A B T V

Diamantstraat 5
7554 TA Hengelo

Telefoon: 0 74 - 255 65 65

Fax: 0 74 - 250 03 05

Openingstijden

Kantoor: maandag t/m vrijdag 8.00uur-17.00uur
(vrijdag tot 15.30uur)

Balie: maandag t/m vrijdag 7.30uur-17.00uur
(vrijdag tot 15.30uur)

Toonzaal: dinsdag t/m vrijdag 9.00 uur - 17.00 uur
donderdag 18.00uur - 21.00uur
zaterdag 10.00uur - 15.00uur

Contactpersonen

Vestigingsleider: René Gruwel

Buitendienst: Harm Boltjes
Jeroen Dijkhof

Binnendienst: Erwin Ruyter
Gerrit Fokker
Gerrie Kupers
Ipo Oosterhuis
Felisa Blokhuis
Rob Rolefes

Toonzaal: Mirjam Vlek
Pieter Bakker

Balie: David Lasciki

Vanuit Enschede: Volg de A35 tot afrit 27 "Twentekanaal" en ga daar richting Hengelo-Zuid. Lees verder..*

Vanuit Almelo / Oldenzaal: Volg de A1 tot Knooppunt Buren en ga daar richting Enschede. Op de A35 neemt u afrit 27 "Twentekanaal" en ga daar richting Hengelo-Zuid. Lees verder..*

* U rijdt nu op de Haaksbergerstraat, neem de eerste afslag links naar de Diamantstraat op Industrierrein "Twentekanaal-Zuid". U ziet Plieger aan uw linkerhand. Keer via de oversteek van de Granaatstraat / Robijnstraat en rijd terug.

A Afhaalbalie B Eigen bezorgdienst T Toonzaal E Express zelfbedieningsafhaal magazijn V Verkoop per telefoon en fax

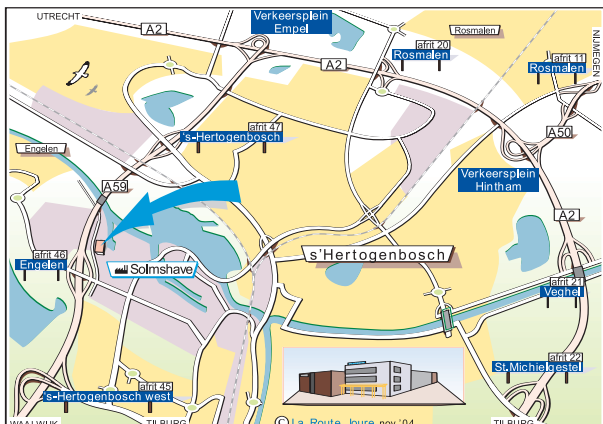

Vanuit Utrecht/Tilburg: Volg de A2 tot knooppunt Empel en ga daar de A59 op richting Waalwijk. Lees verder.*

Vanuit Nijmegen: Volg de A50 tot knooppunt Hintham volg daar de A2 richting Utrecht. Ga bij knooppunt Empel de A59 op richting Waalwijk. Lees verder.*

Vanuit Waalwijk: Volg de A50 naar 's Hertogenbosch. Lees verder.*

* Neem op de A59 afrit 46 "Engelen" ga richting 's Hertogenbosch over de "Rietveldenweg". Neem de eerste afslag links. U rijdt nu op de "Graaf van Solmsweg". Na 500 meter ziet u Plieger aan uw rechterhand.

Plieger 's-Hertogenbosch

A B V

Graaf van Solmsweg 52a
5222 BP 's-Hertogenbosch
Telefoon: 0 73 - 6 24 21 20
Fax: 0 73 - 6 21 04 89

Openingstijden

Kantoor: maandag t/m vrijdag 8.00uur-17.00uur
(vrijdag tot 15.30uur)
Balie: maandag t/m vrijdag 7.30uur-17.00uur
(vrijdag tot 15.30uur)

Contactpersonen

Vestigingsleider: Jan Willem Vos

Buitendienst: Marc van Keulen
Niels Straatman
Klaas Verrips

Binnendienst: Marco Werner
Sjef Beset
Arie Groeneveld
Peter van de Wildenberg
Roy Cornelissen

Balie: Hermen van Eck

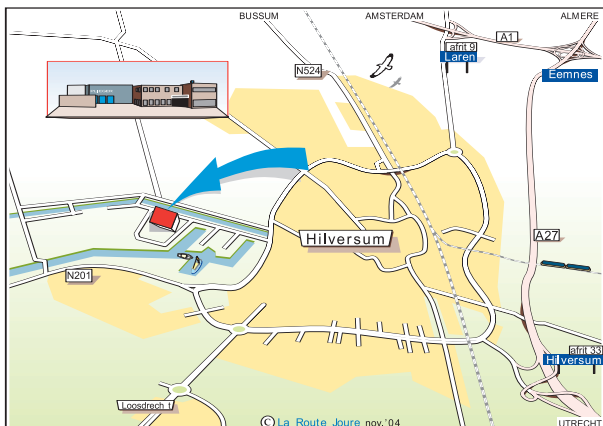

Vanuit Utrecht / Almere: Volg de A27 tot afrit 33 "Hilversum" en ga daar aan het einde van de afrit linksaf de N201 "Diependaalselaan" op. Lees verder.*

Vanuit Amsterdam / Amersfoort: Volg de A1 tot Knooppunt Eemnes en ga daar richting Utrecht. Op de A27 neemt u afrit 33 "Hilversum" en ga aan het eind van de afrit linksaf de N201 "Diependaalselaan" op. Lees verder.*

* Blijf deze weg volgen, over de rotonde rechtdoor. Bij de splitsing slaat u rechtsaf de Vreelandseweg op. Blijf ook deze weg volgen, de weg maakt een bocht naar links. Daarna neemt u de eerste afslag links. Na 700 meter ziet u Plieger aan uw linkerhand.

Plieger Hilversum

E B T V Nieuwe Havenweg 51, 1216 BL Hilversum

Telefoon: 035 - 6 23 81 40
Fax: 035 - 6 23 81 25

Openingstijden

Kantoor: maandag t/m vrijdag 8.00uur-17.00uur
(vrijdag tot 15.30uur)
Express: maandag t/m vrijdag 7.30uur-17.00uur
(vrijdag tot 15.30uur)
Toonzaal: dinsdag t/m vrijdag 9.00 uur - 17.00 uur
donderdag 18.00uur - 21.00uur
zaterdag 10.00uur - 15.00uur

Contactpersonen

Vestigingsleider:

Buitendienst: Hans Kos
Binnendienst: Jaap Post
Michiel van der Wees
Monique Klein

Express: Jacob van Amstel
Jan Bruins

Toonzaal: Karel Weinberg
Erica van Doorne
Isabel Alkay
Evelien Baas

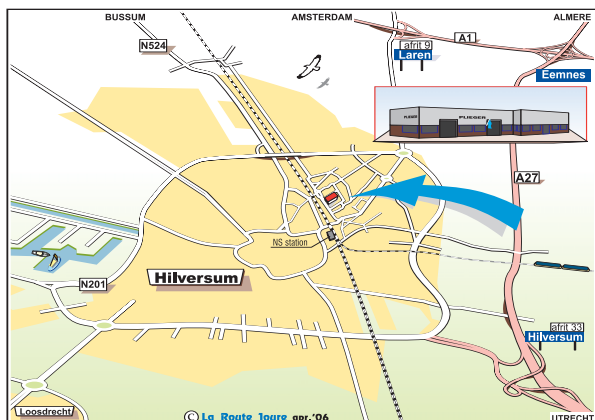

Plieger Hilversum

E V Korte Noorderweg 77, 1221 NC Hilversum

Telefoon: 035 - 6 42 16 63

Fax: 035 - 6 42 16 79

Openingstijden

Kantoor: maandag t/m vrijdag 8.00uur-17.00uur
(vrijdag tot 15.30uur)

Express: maandag t/m vrijdag 7.30uur-17.00uur
(vrijdag tot 15.30uur)

Toonzaal: dinsdag t/m vrijdag 9.00 uur - 17.00 uur
donderdag 18.00uur - 21.00uur
zaterdag 10.00uur - 15.00uur

Contactpersonen

Vestigingsleider: Evert Haverkamp

Buitendienst: Frits Tombal

Binnendienst: Petra Kleinhoven

Express: Gerald Bouwer
Richard van Ommen

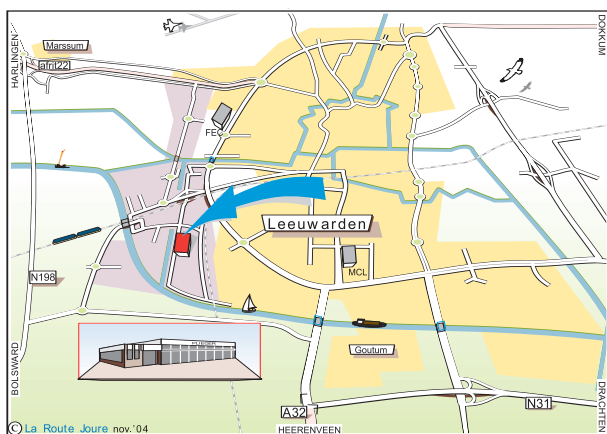

Plieger Leeuwarden

A B T V

Zwettestraat 29a

8912 AV Leeuwarden

Telefoon: 0 58 - 2 12 30 59

Fax: 0 58 - 2 15 85 32

Openingstijden

Kantoor: maandag t/m vrijdag 8.00uur-17.00uur
(vrijdag tot 15.30uur)

Balie: maandag t/m vrijdag 7.30uur-17.00uur
(vrijdag tot 15.30uur)

Toonzaal: dinsdag t/m vrijdag 9.00 uur - 17.00 uur
donderdag 18.00uur - 21.00uur
zaterdag 10.00uur - 15.00uur

Contactpersonen

Vestigingsleider: Karel van der Zwan

Buitendienst: Syb van der Wal

Binnendienst: Jan Baron
Herman de Vries

Toonzaal: Herbert van der Meer
Maaïke Zijlstra

Vanuit Drachten: Volg de N31 tot aan de A32. Hier gaat u richting Leeuwarden. Voor het kanaal links af, richting Bolsward. Neem de rotonde 1/4, richting Leeuwarden-west. Lees verder.....*

Vanuit Harlingen: Verlaat de A31bij Marssum via afrit 22, richting Bolsward (N198). Neem vervolgens de afslag richting Drachten, Heerenveen. Neem de rotonde ¾. Lees verder.....*

Vanuit Heerenveen: Volg de A32. Voor het kanaal links af, richting Bolsward. Neem de rotonde 1/4, richting Leeuwarden-west. Lees verder.....*

Vanuit Dokkum: Volg de rondweg om Leeuwarden. U passeert de rotonde met afslag harlingen en u rijdt voor het FEC langs. Over de brug direct rechts af. Vervolgens rechts aanhouden. U gaat onder de weg en de spoorlijn door. Plieger staat daarna aan de linker kant.

Vanuit Bolsward: Volg de N198. Neem de afslag richting Drachten, Heerenveen. Neem de rotonde ¾. Lees verder.....*

* Bij de volgende rotonde rechtdoor, over het kanaal. Aan het eind van de afrit links af. Neem de tweede afslag rechts. Plieger staat dan aan de linker kant.

A Afhaalbalie B Eigen bezorgdienst T Toonzaal E Express zelfbedieningsafhaal magazijn V Verkoop per telefoon en fax

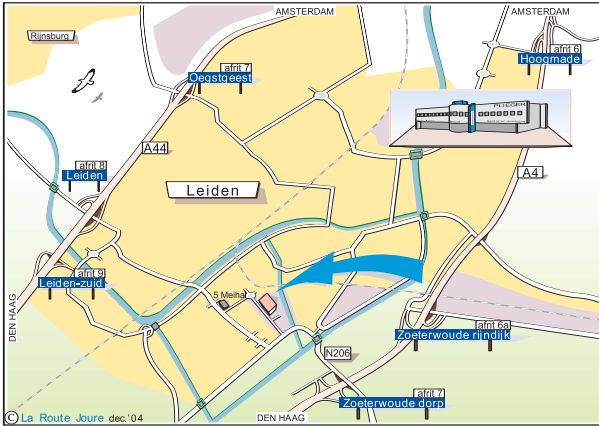

Vanuit Den Haag / Amsterdam: Volg de A4 tot afrit 7 "Zoeterwoude dorp" en ga daar richting Leiden. Volg de N206 "Europaweg" over de brug en met de weg mee naar links. Direct na de bocht en over het water neemt u de afslag naar rechts. U rijdt nu op de Rooseveltsstraat, na 700 meter ziet u Plieger aan uw rechterhand.

Plieger Leiden

A B T V

Rooseveltstraat 6

2321 BM Leiden

Telefoon: 0 71 - 535 17 00

Fax: 0 71 - 531 80 35

Openingstijden

Kantoor: maandag t/m vrijdag 8.00uur-17.00uur
(vrijdag tot 15.30uur)

Balie: maandag t/m donderdag 7.45uur-16.45uur
(vrijdag tot 14.45uur)

Toonzaal: dinsdag t/m vrijdag 9.00 uur - 17.00 uur
donderdag 18.00uur - 21.00uur
zaterdag 10.00uur - 15.00uur

Contactpersonen

Vestigingsleider: Ruud Schellinghout

Buitendienst: Henk Poldervaart
Marcel Schoenmakers

Binnendienst: Thea Van Wijland
Michael Valk
Alexander Havenaar
René van Ooijen

Balie: Rene Boekkooi
Kees v/d Plas

Toonzaal: Willem Schaap
Martien Van Bezeij
Wim Onvlee
Joke Heeren

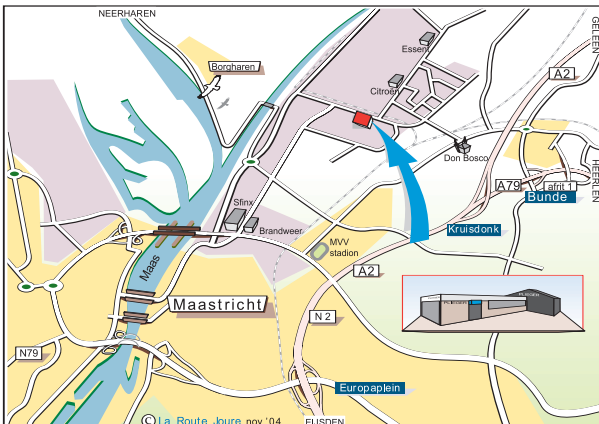

Vanuit Geleen: Volg de A2 tot voorbij kruispunt "Kruisdonk". Aan het eind van de A2, bij het stadion, rechts af. Lees verder.....*

Vanuit Heerlen: Volg de A79 tot aan afrit 1, Bunde. Aan het ein van de afrit rechts af. Neem de hierna volgende ronde ¾. Tegen over "Don Bosco" rechtsaf. Deze weg uitrijden en dan linksaf. Over het spoor rechts aanhouden, om "Office Centre" heen. Plieger ziet u dan aan uw linkerhand.

Vanuit Eijsden: Volg de A2, het Europaplein voorbij. De A2 wordt dan de N2. Aan het eind van de N2, bij het stadion linksaf. Lees verder.....*

* U rijdt steekt daarna het spoor over en daarna rechtsaf, richting Limmen. Rij deze straat uit tot voor de spoorlijn. Hier slaat u rechts af. Plieger ziet u dan aan uw rechterhand.

Plieger Maastricht

Galjoenweg 43

6222 NS Maastricht

E B V Telefoon: 0 43 - 3 69 07 90

Fax: 0 43 - 3 63 64 04

T V Telefoon: 0 43 - 3 69 07 21/22

Fax: 0 43 - 3 63 64 04

Openingstijden

Kantoor: maandag t/m vrijdag 8.00uur-17.00uur
(vrijdag tot 15.30uur)

Balie: maandag t/m vrijdag 7.30uur-17.00uur
(vrijdag tot 15.30uur)

Toonzaal: dinsdag t/m vrijdag 9.00uur-17.00uur
donderdagavond 18.00 uur - 21.00 uur
zaterdag 10.00 uur - 15.00 uur

Contactpersonen

Vestigingsleider: Tom Goossen

Buitendienst: Jo van Hoof
Pascal Purnot

Binnendienst: Astrid Moonen
Remco van Tol
Philip Fleuren
Rebecca Frissen
Desiré van der Meulen

Toonzaal: Ben Defauwes
Sindy Starreveld
Marjo Coelen

Balie: Harry Rietrae

A Afhaalbalie B Eigen bezorgdienst T Toonzaal E Express zelfbedieningsafhaalmagazijn V Verkoop per telefoon en fax

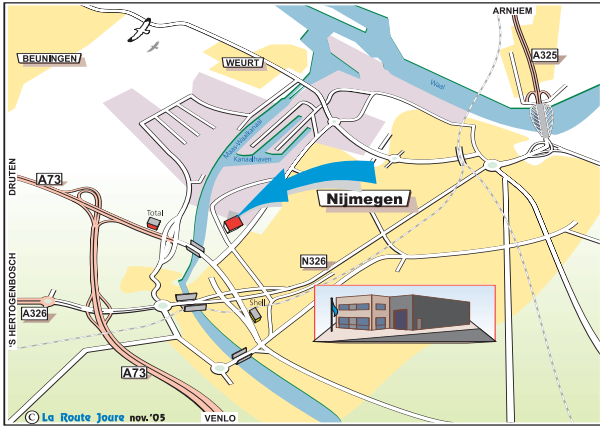

Plieger Nijmegen

E V

Dr. de Blecourtstraat 70
6541 DK Nijmegen
Telefoon: 024 - 372 7400
Fax: 024 - 372 7401

Contactpersonen

Vestigingsleider: Evert Haverkamp

Buitendienst: Marc Janssen

Express: Kees van de Geld

Openingstijden

Express: maandag t/m donderdag 7.00uur-17.00uur
(vrijdag tot 15.30uur)

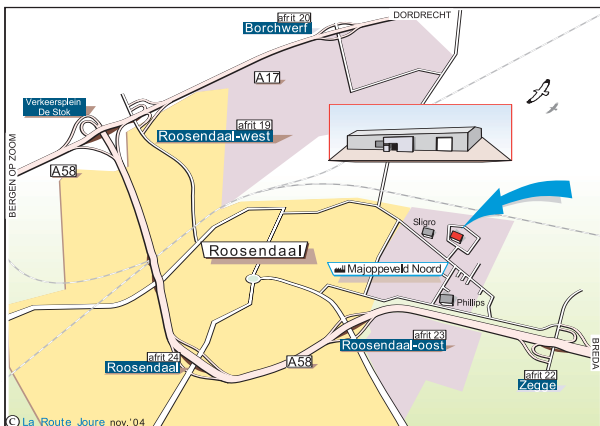

Plieger Roosendaal

E V

Boerkensleen 2
4705 RL Roosendaal
Telefoon: 01 65 - 56 10 40
Fax: 01 65 - 56 10 80

Openingstijden

Express: maandag t/m vrijdag 7.30uur-17.00uur
(vrijdag tot 15.30uur)

Contactpersonen

Vestigingsleider: Piet de Haze

Buitendienst: Danker Smallegange

Express: Marcel Claerhoudt
Peter Schuurbiens

Vanuit Dordrecht / Bergen op zoom: Volg de A17 en ga op Verkeersplein "De Stok" richting Breda (A58). Neem op de A58 afrit 22 "Zegge". Rijdt over het viaduct en neem de volgende afslag linksaf. Lees verder.*

Vanuit Breda: Volg de A58 en neem afrit 22 "Zegge". Steek de weg over. Lees verder.*

* Volg de borden "Majoppeveld Noord". U rijdt parallel aan de A58 over de "Rijksweg Noord". Neem de tweede weg rechts en direct weer links. Neem op de Leemweg de tweede afslag rechts. U rijdt nu op de Boerkensleen. Houd links aan en u ziet Plieger recht voor u.

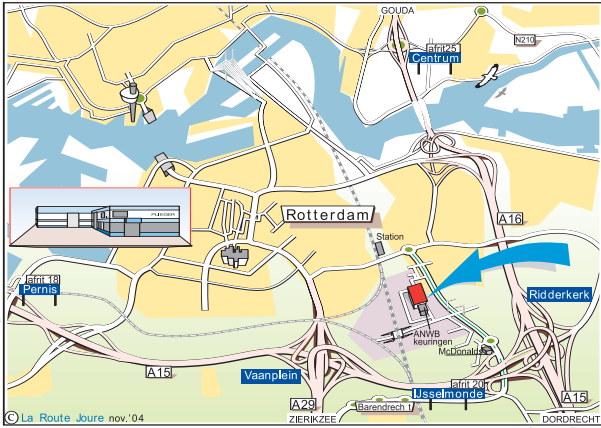

Vanuit Gouda / Dordrecht: Volg de A16 tot Knooppunt Ridderkerk. Ga de A15 op richting Pernis. Neem meteen afrit 20 "IJsselmonde" en ga richting IJsselmonde. Lees verder.*

Vanuit Zierikzee: Volg de A29 tot Knooppunt Vaanplein en ga daar richting Utrecht. Op de A15 neemt u afrit 20 "IJsselmonde" en ga daarna richting IJsselmonde. Lees verder.*

Vanuit Botlek: Volg de A15 tot afrit 20 "IJsselmonde", neem deze afslag en ga richting IJsselmonde. Lees verder..*

* U rijdt nu op de IJsselmondse Randweg. Ga bij de rotonde rechtdoor en sla bij de verkeerslichten linksaf Industrieterrein Hordijk op. De eerste afslag rechts is de Stolwijkstraat, waar u Plieger aan uw linkerhand ziet.

Plieger Rotterdam

A T V

Stolwijkstraat 41
3079 DN Rotterdam
Telefoon: 0 10 - 483 20 22
Fax: 0 10 - 479 42 62

Openingstijden

Balie: maandag t/m vrijdag 7.30uur-17.00uur
(vrijdag tot 15.30uur)
Toonzaal: dinsdag t/m vrijdag 9.00 uur - 17.00 uur
zaterdag 10.00uur - 15.00uur

Contactpersonen

Vestigingsleider: Freek de Bas
Buitendienst: Hayati Aydin
Balie: Koos Bindenga
Peter Vos
Toonzaal: Cobi Franken
Henri Vermeer

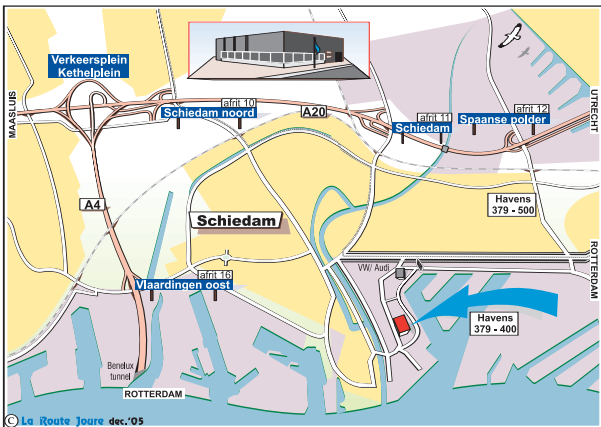

Vanuit Utrecht / Maassluis: Volg de A20 tot afrit 12 "Spaanse Polder". Neem deze afrit en volg de borden Havens 379 - 500. Lees verder..*

Vanuit Rotterdam / Europoort: Volg de A4 door de Beneluxtunnel tot Knooppunt Kethelplein. Volg daar de A20 richting Utrecht en neem afrit 12 "Spaanse Polder". Volg de borden Havens 379 - 500. Lees verder..*

* U rijdt nu op de Tjalklaan. Aan het einde van deze straat (Marconiplein) slaat u rechtsaf richting havens 379-500. De Schiedamseweg heeft een tramspoor in het midden. Neem de tweede afslag naar links richting havens 379-500. U rijdt nu op de van Deventerstraat. Neem de tweede afslag links Nieuw Mathenesserstraat na 700 meter ziet u Plieger aan uw linkerhand.

Plieger Schiedam

E B V

Nieuw Mathenesserstraat 73
3113 AE Schiedam
Telefoon: 010 - 4 27 77 40
Fax: 010 - 4 27 77 42

Openingstijden

Express: maandag t/m vrijdag 7.30uur-17.00uur
(vrijdag tot 15.30uur)

Contactpersonen

Vestigingsleider: Freek de Bas
Buitendienst: Hayati Aydin
Binnendienst: Wim Heystek
Michiel Selhorst
Express: Cor Ridderhof
Wouter van der Leeuw

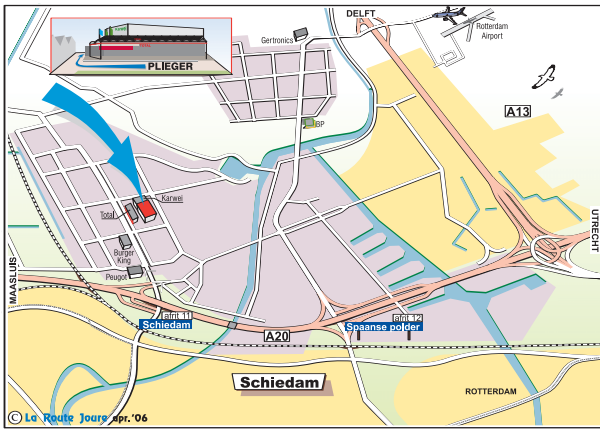

Plieger Schiedam

E V

Scholtenstraat 23
3125 BM Schiedam

Telefoon: 010 - 2 62 02 00

Fax: 010 - 2 62 06 24

Openingstijden

Express: maandag t/m vrijdag 7.30uur-17.00uur
(vrijdag tot 15.30uur)

Contactpersonen

Vestigingsleider: Evert Haverkamp

Buitendienst: Hans Hofman

Express: Ben van Zanten



Plieger Terneuzen

E V

Hughersluys 20
4536 HM Terneuzen

Telefoon: 01 15 - 63 00 77

Fax: 01 15 - 63 00 88

Openingstijden

Express: maandag t/m vrijdag 7.30uur-17.00uur
(vrijdag tot 15.30uur)

Contactpersonen

Vestigingsleider: Piet de Haze

Buitendienst: Danker Smallegange
Michel van Immerseel

Express: Marco van Huisstede
Jacco Eijzerman

Vanuit Goes / Middelburg: Volg vanuit de Westerscheldetunnel de N62 tot aan de rotonde. Neem deze 3/4 richting Terneuzen/Zaamslag. Na de brug over het kanaal van "Gent naar Terneuzen" neemt u de 3e afslag links. Lees verder..*

Vanuit Hoek: Volg de N61 en neem na de brug over het kanaal van "Gent naar Terneuzen" de 3e afslag links. Lees verder..*

Vanuit Gent: Volg de N62 naar Terneuzen en steek de N61 over. Lees verder..*

* Volg de borden 1800 - 1920. Volg de "Guido Gezellestraat" tot de rotonde. Neem deze 3/4, u rijdt op de Rooseveltlaan. Sla, na Boerenbond, rechtsaf de Hughersluys op. Rijdt om Profile Tyrecentre heen linksaf. In de bocht ziet u Plieger (nr.1907) aan uw rechter hand.

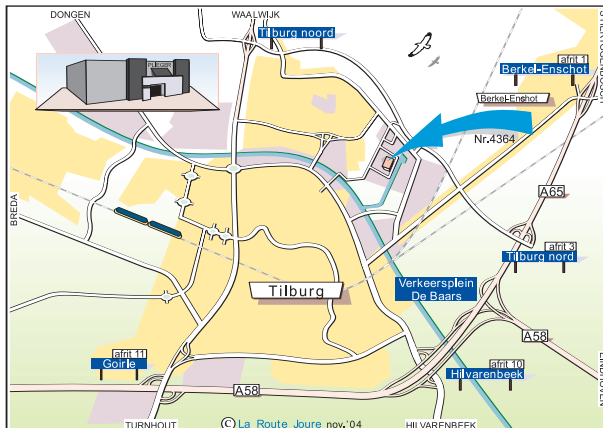

Plieger Tilburg

E V

Watermanstraat 18

5015 TE Tilburg

Telefoon: 0 13 - 4 55 09 28

Fax: 0 13 - 4 55 09 29

Openingstijden

Express: maandag t/m vrijdag 7.30uur-17.00uur
(vrijdag tot 15.30uur)

Contactpersonen

Vestigingsleider: Jan Willem Vos

Buitendienst: Marc van Keulen

Express: Roel van Schaik
Harry van Soeren
Peter Vingerhoeds

Vanuit 's Hertogenbosch / Breda: Volg de A65 en neem afrit 3 "Tilburg Noord". Volg borden 4000 - 5000. Ga richting Waalwijk over de Burgemeester Brechtweg en neem de tweede afslag links en meteen weer rechts. U rijdt nu op de Zuiderkruisweg. Neem de derde afslag links. Lees verder..*

Vanuit Waalwijk: Volg de A58 tot knooppunt De Baars volg daar de A65 richting 's Hertogenbosch. Neem afrit 3 "Tilburg Noord". Volg borden 4000 - 5000. Ga richting Waalwijk over de Burgemeester Brechtweg en neem de tweede afslag links en meteen weer rechts. U rijdt nu op de Zuiderkruisweg. Neem de derde afslag links. Lees verder..*

Vanuit Waalwijk: Volg de A261/N261 naar Tilburg en neem afslag "Tilburg Noord". Volg borden 4000 - 5000. U rijdt nu over de Burgemeester Brechtweg, neem de tweede afslag rechts en meteen weer links. Neem op de Vlashofflaan de eerste afslag rechts. Lees verder..*

* U rijdt op de Centaurusweg. Neem de eerste afslag links en na de bocht ziet u Plieger aan uw linkerhand.

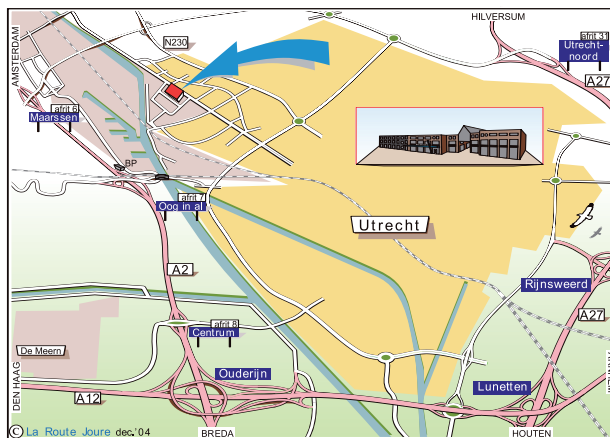

Plieger Utrecht

A B T V

Amsterdamsestraatweg 632

3555 HX Utrecht

Telefoon: 030 - 244 44 99

Fax: 030 - 244 73 04

Openingstijden

Kantoor: maandag t/m vrijdag 8.00uur-17.00uur
(vrijdag tot 15.30uur)

Toonzaal: dinsdag t/m vrijdag 9.00uur-17.00uur

Balie: maandag t/m vrijdag 7.30uur-16.30uur
(vrijdag tot 14.30uur)

Contactpersonen

Vestigingsleider: Rob Korpel

Buitendienst: Hendrik Achterberg
Michel van Heeswijk

Binnendienst: William Nagtegaal
Dymon Dupree
Sander Visser

Toonzaal: Michel Janszen
Britt van der Linden

Balie: Ben Freijters

Vanuit Breda / Amsterdam: Volg de A2 tot afrit 7 "Oog in al" en ga daar richting Zuilen. Lees verder..*

Vanuit Den Haag / Arnhem: Volg de A12 tot Knooppunt Ouderijn en ga daar richting Amsterdam. Op de A2 neemt u afrit 7 "Oog in al" en ga daar richting Zuilen. Lees verder..*

Vanuit Hilversum / Houten: Volg de A27 tot knooppunt Lunetten en ga daar richting Den Haag (A12). Op de A12 bij knooppunt Ouderijn rijdt u richting Amsterdam. Op de A2 neemt u afrit 7 "Oog in al" en ga daar richting Zuilen. Lees verder..*

* Ga over de brug en bij de volgende kruising linksaf richting Zuilen. U rijdt op de Thomas à Kempisweg / Cartesiusweg onder twee spoorbruggen door. Ga vervolgens linksaf, richting Zuilen, de Amsterdamsseweg op. Na 1 kilometer ziet u Plieger aan uw rechterhand.

A Afhaalbalie B Eigen bezorgdienst T Toonzaal E Express zelfbedieningsafhaalmagazijn V Verkoop per telefoon en fax

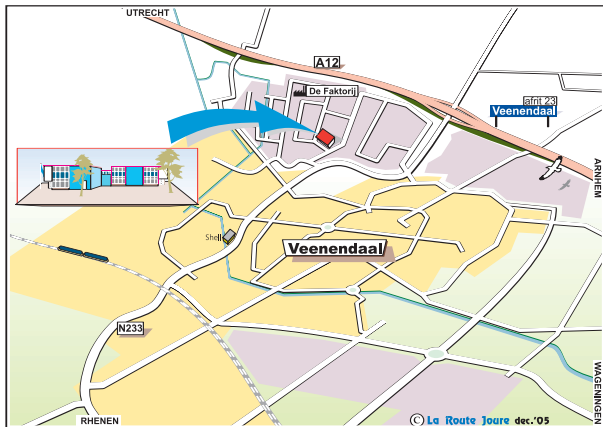

Vanuit Rhenen: volg de N233 door Veenendaal, tot u het bord "De Faktorijs" ziet. Sla bij de verkeerslichten links af. Daarna eerste straat rechts en vervolgens eerste straat links. U ziet Plieger direct aan de rechterkant.

Vanaf Ede: volg de N224 die overgaat in de N233 door Veenendaal tot u het bord "De Faktorijs" ziet. Sla bij de verkeerslichten rechts af. Daarna eerste straat rechts en vervolgens eerste straat links. U ziet Plieger direct aan de rechterkant.

Vanaf de A12: neemt u afrit 23 Veenendaal en volgt u de N224 die overgaat in de N233 door Veenendaal tot u het bord "De Faktorijs" ziet. Sla bij de verkeerslichten rechts af. Daarna eerste straat rechts en vervolgens eerste straat links. U ziet Plieger direct aan de rechterkant.

Plieger Veenendaal

E V

Standaardruiter 6
3905 PW Veenendaal
Telefoon: 0318 - 581 450
Fax: 0318 - 581 451

Openingstijden

Kantoor: maandag t/m vrijdag 8.00uur-17.00uur
(vrijdag tot 15.30uur)
Balie: maandag t/m vrijdag 7.30uur-17.00uur
(vrijdag tot 15.30uur)

Contactpersonen

Vestigingsleider: Carel Kraaijenhagen
Buitendienst: William van Rijnsoever
Express: Gijs van den Brink
Martin Visser

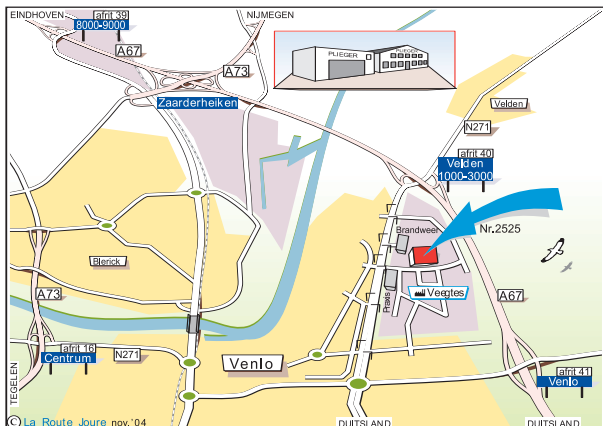

Vanuit richting Eindhoven: Volg de A67 tot aan afrit 40, Venlo-Noord, Velden. Ga onder aan de afrit richting Venlo. Sla bij de derde verkeerslichten linksaf. Plieger staat na 400 mtr. aan uw linkerhand.

Vanuit richting Tegelen: Volg de N271 tot aan de rotonde centrum Venlo. Hou rechts aan en neem de volgende rotonde ¾, richting Nijmegen. Volg deze weg tot aan de volgende rotonde. Neem ook deze ¾. Sla bij de derde verkeerslichten rechtsaf. Plieger staat na 400 mtr. aan uw linkerhand.

Vanuit richting Roermond: Volg de N273 tot aan knooppunt Zaarderheiken. Ga hier richting Venlo, Duisburg. Volg de A67 tot aan afrit 40, Venlo-Noord, Velden. Ga onder aan afrit rechtsaf richting Venlo. Sla bij de derde verkeerslichten linksaf. Plieger staat na 400 mtr. aan uw linkerhand.

Vanuit richting Nijmegen: Volg de A73 tot aan knooppunt Zaarderheiken. Ga hier richting Venlo, Duisburg. Volg de A67 tot aan afrit 40, Venlo-Noord, Velden. Ga onder aan de afrit rechtsaf richting Venlo. Sla bij de derde verkeerslichten linksaf. Plieger staat na 400 mtr. aan uw linkerhand.

Vanuit alle richtingen: volg bij Venlo industrienummer 2525. Dit staat in de regio Venlo op alle ANWB-borden aangegeven en leidt u zó tot bij ons voor de deur.

Plieger Venlo

L.J. Costerstraat 35
5916 PR Venlo
A B V Telefoon: 0 77 - 32 02 101
Fax: 0 77 - 32 02 111
T Telefoon: 0 77 - 32 02 112
Fax: 0 77 - 32 02 119

Openingstijden

Kantoor: maandag t/m vrijdag 8.00uur-17.00uur
(vrijdag tot 15.30uur)
Balie: maandag t/m vrijdag 7.30uur-17.00uur
(vrijdag tot 15.30uur)
Toonzaal: dinsdag t/m vrijdag 9.00uur-17.00uur
zaterdag 10.00 uur - 15.00 uur

Contactpersonen

Vestigingsleider: Ruud Engels
Buitendienst: Toon Loeffen
Binnendienst: Math Geurts
Jeroen Heiligers
Balie: Johan van der Sterren
Toonzaal: Piet Peeters
Chris Diaferia

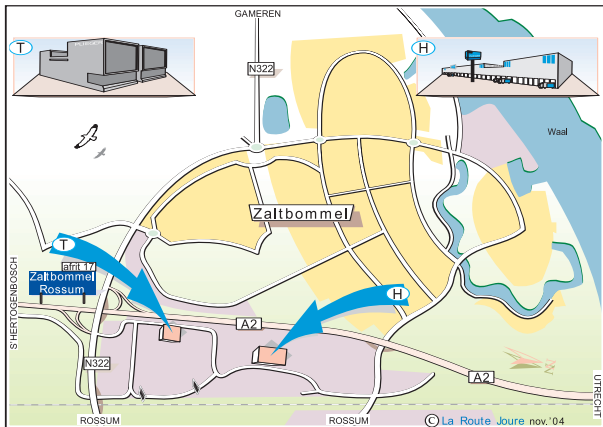

Plieger Zaltbommel

T

Van Voordenpark 19
5301 KP Zaltbommel

Telefoon: 0418 - 57 22 10

Fax: 0418 - 57 22 11

Openingstijden

Toonzaal: maandag t/m vrijdag 10.00 - 21.00 uur
zaterdag 10.00 uur - 17.00 uur

Contactpersonen

Vestigingsleider: Eric Gerads

Vanuit 's Hertogenbosch : Volg de A2 tot afrit 17 "Zaltbommel". Neem deze afrit en ga rechtdoor richting Van Voordenpark. Lees verder..*

Vanuit Utrecht : Volg de A2 tot afrit 17 "Zaltbommel" en neem deze afrit. Ga vervolgens links richting Van Voordenpark. Sla na het viaduct linksaf het Van Voordenpark op. Lees verder..*

* U rijdt nu op Van Voordenpark. Na de kruising ziet u de Plieger Toonzaal A2 aan uw rechterhand. Als u nog verder doorrijdt en de weg naar rechts en vervolgens naar links volgt, dan ziet u het Plieger Hoofdkantoor aan uw linkerhand.



Plieger Zwolle

A B T V

Voltastraat 13
8013 PM Zwolle

Telefoon: 0 38 - 4 65 65 22

Fax: 0 38 - 4 65 91 96

Openingstijden

Kantoor: maandag t/m vrijdag 8.00uur-17.00uur
(vrijdag tot 15.30uur)

Balie: maandag t/m vrijdag 7.30uur-17.00uur
(vrijdag tot 15.30uur)

Toonzaal: dinsdag t/m vrijdag 9.00 uur - 17.00 uur
donderdag 18.00uur - 21.00uur
zaterdag 10.00uur - 15.00uur

Contactpersonen

Vestigingsleider: Henri van Velzen

Buitendienst: Sjoerd de Jong
Robin Veldhuis

Binnendienst: Rob Kamp
Henk Nijland
Jan Willem Oudman
Cas Voswijk
Stefan Boers
Roland Timmerman

Balie: Hans Stapper
Teun Ubels
Klaas Wesselink

Toonzaal: Erik Meinten
Daphne Jonker
Trudy van Es

Vanuit Amersfoort: Volg de A28 tot aan afrit Zwolle-zuid. Verlaat de A28 bij afrit 18. Neem de rotonde ¼. U rijdt nu op de N337. Volg deze (= Ring Zuid). Neem afslag Deventer; dit is eveneens Ring-Zuid. U bevindt zich nu op industrieterrein "De Marslanden". Sla de eerste weg rechtsaf en meteen weer links. Plieger staat dan aan uw linkerkant.

Vanuit Meppel: Volg de A28 tot aan afrit 20, Zwolle-noord. Aan het eind van de afrit linksaf, onder de A28 door. U rijdt nu op de N35. Volg deze (= Ring Oost). Over het spoor gaat u rechtsaf, richting Wije/Olst. Dit is Ring-Zuid. U bevindt zich nu op industrieterrein "De Marslanden". Sla na de twee brugjes linksaf en meteen weer links. Plieger staat dan aan uw linkerkant.

Vanuit wije en Olst: Volg de N337 tot aan de afslag Almelo/Deventer. Hier gaat u rechtsaf. U komt dan op de Ring-Zuid. Steek deze over, richting Almelo/Deventer. U bevindt zich nu op industrieterrein "De Marslanden". Sla de eerste weg rechtsaf en meteen weer links. Plieger staat dan aan uw linkerkant.

A Aphaalbalie **B** Eigen bezorgdienst **T** Toonzaal **E** Express zelfbedieningsafhaalmagazijn **V** Verkoop per telefoon en fax



ThermoNoord Dordrecht

A B V

Kamerlingh Onnesweg 13

3316 GK Dordrecht

Telefoon: 078 - 6 52 16 66

Fax: 078 - 6 18 22 87

Openingstijden

Kantoor: maandag t/m vrijdag 8.00uur-17.00uur
(vrijdag tot 15.30uur)

Balie: maandag t/m vrijdag 7.30uur-17.00uur
(vrijdag tot 15.30uur)

Contactpersonen

Vestigingsleider: Frits Pronk

Buitendienst: Frits Pronk
Hans Hofman

Binnendienst: André van der Wel
Jan Berkhof

Balie: Johan van de Vlucht
Rob Kruithof

Vanuit Sliedrecht: Vanaf de A15 neemt u bij afslag 23 de N3, door Dordrecht heen. Ten zuiden van Dordrecht gaat deze weg over het spoorviaduct en over het viaduct met de A16. Lees verder..*

Vanuit Rotterdam/ Breda: Volg de A16 tot afslag 20, 's Gravendeel. Hier verlaat u de A16, richting 's Gravendeel en de toltunnel. Lees verder..*

* Direct hierna gaat u rechtsaf. Volg deze weg tot aan de verkeerslichten bij de afslag naar bedrijventerrein "Dordtse Kil". Hier gaat u links af en volgt u de weg tot de laatste kruising. Hier gaat u links af en ziet u ThermoNoord direct aan uw rechter hand.



ThermoNoord De Goorn

E V

Breeuwhamer 3

1648 HG De Goorn

Telefoon: 0 229 - 54 88 20

Fax: 0 229 - 54 88 29

Openingstijden

Express: maandag t/m vrijdag 7.30uur-17.00uur

Contactpersonen

Vestigingsleider: Harry Kloeze

Buitendienst: John Caspari
Peter Verplancke

Binnendienst: Richard Keizer

Express: Paul Verheul

Vanuit Alkmaar: Volg de N508 tot de T-kruising met de N243. Hier gaat u links af, richting Hoorn. Bij de afslag De Goorn / Avenhorn gaat u nog rechtdoor. Bij de volgende afslag rechts af, richting bedrijventerrein "Vredemaker-Oost". De eerstvolgende rotonde neemt u ¾, richting Avenhorn. Bij de afslag, bij het pompstation rechts af richting De Goorn. Daarna weer rechtsaf. Het pand van ThermoNoord vindt u aan uw linker hand.

Vanaf de A7: Verlaat de A7 bij afslag 7, richting Avenhorn. Bij Avenhorn de eerste afslag rechts af, richting bedrijventerrein "Vredemaker-Oost". De eerstvolgende rotonde neemt u ¾, richting Avenhorn. Bij de afslag, bij het pompstation rechts af richting De Goorn. Daarna weer rechtsaf. Het pand van ThermoNoord vindt u aan uw linker hand.



Vanaf de A7, vanuit Heerenveen of Drachten neemt u afslag 27 [Tijnje - Gorredijk] richting Gorredijk (N392). Na ca. 3 km komt u voor Gorredijk en slaat u links af, richting bedrijventerrein "Overtoom". U rijdt daarna over de brug, tot aan de rotonde. Deze neemt u 3/4. Na ca. 200 meter ziet u ThermoNoord aan uw linker hand.

ThermoNoord Gorredijk

A B V

Tolhûsleane 7

8401 GA Gorredijk

Tel. 0 513 - 46 99 99

Fax 0 513 - 46 99 09

Afdeling Klimaat

Tel. 0 513 - 46 99 99

Fax. 0 513 - 46 99 81

Openingstijden

Kantoor: maandag t/m vrijdag 8.00uur-17.00uur
(vrijdag tot 15.30uur)

Balie: maandag t/m vrijdag 7.30uur-17.00uur
(vrijdag tot 15.30uur)

Contactpersonen

Vestigingsleider: Harry Kloeze

Buitendienst: Chris Jonker
Jan Kale
Marcel Dreijer

Binnendienst: Anne Snijder
Derk Feenstra
Jan Baron
Jan van der Linde
Marcel van Stokhem
Otte Adema
Wietze van Weerden

Balie: Arie van der Heide

Afdeling klimaattechniek Plieger groep

Verkoopleider Jan Busser

| | | |
|--------------|--|---|
| Buitendienst | Jan Cornelis John Hoevers Roland Verkaik Patrick van Oosterhout | Noord Nederland Oost Nederland West Nederland Zuid Nederland |
|--------------|--|---|

Binnendienst Bart Thijseling
Jack Hazelaar
Jan Bernard Valkema
Jos van Keulen
Koos van Bleek
Sieta Jacobi

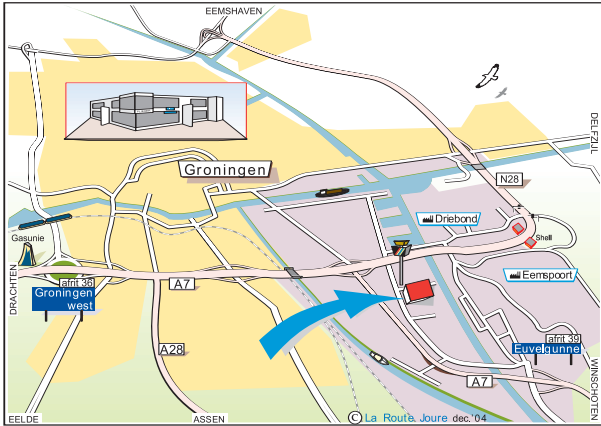

Vanuit Drachten: Volg de A7, voorbij het pand van de Gasunie, over de brug, richting Delfzijl. Voorbij de Shellstations links af, industrieterrein "Driebond" op. Lees verder.....*

Vanuit Assen: Volg de A28 tot aan de A7. Ga hier rechts af, over de brug, richting Delfzijl. Voorbij de Shellstations links af, industrieterrein "Driebond" op. Lees verder.....*

Vanuit Winschoten: Volg de A7 tot afrit 39 (Evelgunne/Westerbroek). Onder aan de afrit rechts en meteen links aanhouden. Over het kanaal. Volg de weg tot aan de reclamezuil van GHC. Juist hiervoor ziet u Plieger aan uw rechterhand.

Vanuit Delfzijl: Ga onder de N28 door en meteen links af, de N28 op richting Drachten. Over de brug rechts af, industrieterrein "Driebond" op. Lees verder.....*

*Volg de weg, over de brug. U rijdt langs de A7. Aan het eind links af, onder de snelweg door.

Aan de linkerkant staat de reclame zuil van GHC. Iets verder staan Plieger & ThermoNoord aan dezelfde kant.

ThermoNoord Groningen

E V

Osloweg 55
9723 BH Groningen
Telefoon: 050 - 3 16 87 80
Fax: 050 - 3 16 87 89

Afdeling Klimaat

Tel. 0 513 - 46 99 99
Fax. 0 513 - 46 99 81

Openingstijden

Express: maandag t/m vrijdag 7.30uur-17.00uur
(vrijdag tot 15.30uur)

Contactpersonen

Vestigingsleider: Harry Kloeze

Buitendienst: Flip Koning
Manfred Fekkes

Binnendienst: Jan Romp
Jaap de Vries

Express: Klaas Palland
Christiaan Jansen



ThermoNoord Putten

E V

Industrieweg 18
3881 LB Putten
Telefoon: 03 41 - 36 97 60
Fax: 03 41 - 36 97 69

Afdeling Klimaat

Tel. 0 513 - 46 99 99
Fax. 0 513 - 46 99 81

Openingstijden

Express: maandag t/m vrijdag 7.30uur-16.30uur

Contactpersonen

Vestigingsleider: Jacques Hazeleger

Buitendienst: Maarten Leeuwenkamp

Binnendienst: Rik de Fauw
Stef van der Zanden
Hendrie Bosch

Express: Cor Warendorff

Vanaf de A1: Verlaat de A1 bij afslag 16, Barneveld / Voorthuizen, richting Voorthuizen. Volg de N303 tot aan Putten. Bij de rotonde links af, richting bedrijventerrein "Keizerswoert". Via 2 rotondes bij de T-kruising rechtsaf, via een rotonde bij de hierna volgende rotonde links af. Volg de weg tot de volgende rotonde. Neem deze ¼. Volg deze weg tot u rechts ThermoNoord ziet staan.

Vanuit Ermelo: Volg de N303 tot u Putten in rijdt. Hier neemt u de afslag richting Nijkerk en bedrijventerrein "Keizerswoert", de N798. Bij de rotonde richting "Keizerswoert" rechtsaf. Volg de weg tot de volgende rotonde. Neem deze ¼. Volg deze weg tot u rechts ThermoNoord ziet staan. Vanaf de A28: Verlaat de A28 bij afslag 10, richting Putten. Over het spoor en bij de T-kruising links af en via een rotonde bij de hierna volgende rotonde links af. Volg de weg tot de volgende rotonde. Neem deze ¼. Volg deze weg tot u rechts ThermoNoord ziet staan.



ThermoNoord Veghel

A V

Costerweg 13
5466 AM Veghel

Telefoon: 04 13 - 31 58 00

Fax: 04 13 - 31 58 09

Afdeling Klimaat

Tel. 0 513 - 46 99 99

Fax. 0 513 - 46 99 81

Openingstijden

Balie: maandag t/m vrijdag 8.00uur-17.00uur

Contactpersonen

Vestigingsleider: Henk van Deursen

Buitendienst: Arjan van Vreede

Binnendienst: Dennis Raaijmakers
Roy Gruijters

Balie: Willy van Ooyen

Vanuit Uden/Oss: A50 richting Eindhoven en neem afslag nr. 10.

*Aan het einde van de afslag linksaf richting Veghel. Bij de stoplichten linksaf de Rooseveltlaan in.

**Doorrijden via de Marshallaan tot aan de rotonde en neem deze 3/4 de Kennedylaan in. Over het spoor linksaf de Costerweg. Volg deze weg tot u rechts ThermoNoord ziet staan.

Vanuit Den Bosch: Volg de Zuid Willemsvaart richting Helmond. Rij voor Veghel de A50 op richting Eindhoven. Neem afslag nr. 10. * Lees verder.

Vanuit Eindhoven: Neem de A50 richting Oss. Neem afslag 10 Zijtaart/Eerde. Onderaan de afslag bij de stoplichten recht door de Rooseveltlaan in rijden. **Lees verder.

Digitaal winkelen bij de Plieger groep:

Veilig, duidelijk en gemakkelijk.

Direct en foutloos in administratie en logistiek

Enorme hoeveelheid productinformatie

Technische berekeningen

Onderdelen en accessoires per product

Zoeken op alternatieve producten

Plieger maakt het u gemakkelijk met www.pliegeronline.nl



PLIEGER.nl

Sanitair producten

| | |
|------------------------------|-----|
| Sanitair Duravit | 28 |
| Sanitair Ideal Standard | 80 |
| Sanitair Keramag | 90 |
| Sanitair Laufen | 121 |
| Sanitair Plieger | 141 |
| Sanitair Sphinx | 148 |
| Sanitair Venlo | 174 |
| Sanitair Villeroy & Boch | 176 |
| Packs, complete sets in doos | 232 |
| Waskommen / Wastafels Alape | 233 |
| Wastafels Dimensione | 241 |
| Waskommen Plieger | 243 |
| Wastafels Imar | 246 |
| Wastafels Gijs Frankenhuis | 247 |

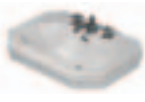
| | Art.nr | Specificaties | Kleur | Lev.nr | Ehd | Prijs | Grp | CC | | |
|-------------------------------------|---|---|-------------------------------|-------------------------------|-------------|-------------|--------|--------|-----|---|
| Sanitair producten | Duravit 1930 | | | | | | | | | |
| |  | wastafel | | | | | | | | |
| | | 0291294 | 60x41cm | wit | 0438600000 | stuk | 496,00 | 015 | 1 | |
| | | 0295606 | 60x41cm | pergamon | 0438604700 | stuk | 496,00 | 015 | 1 | |
| | | 0306754 | 60x41cm m. WG | wit | 04386000001 | stuk | 545,00 | 015 | 1 | |
| | | 0306762 | 60x41cm m. WG | pergamon | 04386047001 | stuk | 545,00 | 015 | 1 | |
| | | Baden / douchebakken / stoomcabines | 0295636 | 60x41cm m. 3 kraangaten | wit | 0438600030 | stuk | 496,00 | 015 | 1 |
| | | | 0306797 | 60x41cm m. 3 kraangaten m. WG | wit | 04386000301 | stuk | 545,00 | 015 | 1 |
| | | | 0293369 | 70x50cm | wit | 0438700000 | stuk | 595,00 | 015 | 1 |
| | | | 0299861 | 70x50cm | pergamon | 0438704700 | stuk | 595,00 | 016 | 1 |
| | | | 0306770 | 70x50cm m. WG | wit | 04387000001 | stuk | 644,00 | 015 | 1 |
| | | Kranen | 0306789 | 70x50cm m. WG | pergamon | 04387047001 | stuk | 644,00 | 015 | 1 |
| | | | 0290045 | 70x50cm m. 3 kraangaten | wit | 0438700030 | stuk | 595,00 | 015 | 1 |
| | | | 0306800 | 70x50cm m. 3 kraangaten m. WG | wit | 04387000301 | stuk | 644,00 | 015 | 1 |
| | | | 0295634 | 80x55cm m. 3 kraangaten | wit | 0438800030 | stuk | 648,00 | 015 | 1 |
| Douchegarnituur | | 0306819 | 80x55cm m. 3 kraangaten m. WG | wit | 04388000301 | stuk | 697,00 | 015 | 1 | |
| | 0830097 | bevestigingsset M10x110mm | | 0830097 | paar | 1,09 | 362 | 0 | | |
| | zuil voor wastafel | | | | | | | | | |
| Accessoires en spiegels | 0295602 | 60cm | wit | 0857910000 | stuk | 274,00 | 015 | 1 | | |
| | 0295608 | 60cm | pergamon | 0857914700 | stuk | 274,00 | 015 | 1 | | |
| | 0293385 | 70-80cm | wit | 0857900000 | stuk | 319,00 | 015 | 1 | | |
| | 0299865 | 70-80cm | pergamon | 0857904700 | stuk | 319,00 | 016 | 1 | | |
| Douchewanden | opbouwastafel | | | | | | | | | |
| | 0296899 | 58x47cm | wit | 0476580000 | stuk | 484,00 | 015 | 1 | | |
| | 0299862 | 58x47cm | pergamon | 0476584700 | stuk | 484,00 | 016 | 1 | | |
| | Toebehoren & afvoeren | 0306827 | 58x47cm m. WG | wit | 04765800001 | stuk | 533,00 | 015 | 1 | |
| | | 0306835 | 58x47cm m. WG | pergamon | 04765847001 | stuk | 533,00 | 015 | 1 | |
| Spoel- & installatiesystemen | planchet | | | | | | | | | |
| | 0296910 | 45x13cm | wit | 0892450000 | stuk | 78,00 | 015 | 1 | | |
| | 0299874 | 45x13cm | pergamon | 0892454700 | stuk | 78,00 | 016 | 1 | | |
| | 0293377 | 65x13cm | wit | 0892650000 | stuk | 127,00 | 015 | 1 | | |
| | 0299873 | 65x13cm | pergamon | 0892654700 | stuk | 127,00 | 016 | 1 | | |
| Badkamermeubelen en toiletkasten | 0830453 | set potschroeven 5.5x60mm chroom | | 0830453 | stuk | 2,28 | 362 | 0 | | |
| | fontein | | | | | | | | | |
| | 0293288 | 50x36.5cm | wit | 0785500000 | stuk | 352,00 | 015 | 1 | | |
| | 0299863 | 50x36.5cm | pergamon | 0785504700 | stuk | 352,00 | 016 | 1 | | |
| | 0306843 | 50x36.5cm m. WG | wit | 07855000001 | stuk | 401,00 | 015 | 1 | | |
| Gootstenen en wastroggen | 0306851 | 50x36.5cm m. WG | pergamon | 07855047001 | stuk | 401,00 | 015 | 1 | | |
| | 0830240 | bevestigingsset voor fontein M8x90mm | | 0830240 | stuk | 0,85 | 362 | 0 | | |
| Utiliteit | hoekfontein | | | | | | | | | |
| | 0296872 | 60x45.5cm | wit | 0793420000 | stuk | 356,00 | 015 | 1 | | |
| | 0299864 | 60x45.5cm | pergamon | 0793424700 | stuk | 356,00 | 016 | 1 | | |
| | 0306606 | 60x45.5cm m. WG | wit | 07934200001 | stuk | 405,00 | 016 | 1 | | |
| | 0306614 | 60x45.5cm m. WG | pergamon | 07934247001 | stuk | 405,00 | 016 | 1 | | |
| 0830240 | bevestigingsset voor fontein M8x90mm | | 0830240 | stuk | 0,85 | 362 | 0 | | | |
| | staand bidet | | | | | | | | | |
| | 0296937 | | wit | 0267100000 | stuk | 447,00 | 015 | 1 | | |
| | 0299866 | | pergamon | 0267104700 | stuk | 447,00 | 016 | 1 | | |
| | 0306622 | m. WG | wit | 02671000001 | stuk | 496,00 | 016 | 1 | | |
| | 0306630 | m. WG | pergamon | 02671047001 | stuk | 496,00 | 016 | 1 | | |
| 0830453 | set potschroeven 5.5x60mm chroom | | 0830453 | stuk | 2,28 | 362 | 0 | | | |
| | wandbidet | | | | | | | | | |
| | 0299843 | | wit | 0266100000 | stuk | 653,00 | 016 | 1 | | |
| | 0299867 | | pergamon | 0266104700 | stuk | 653,00 | 016 | 1 | | |
| | 0306649 | m. WG | wit | 02661000001 | stuk | 702,00 | 016 | 1 | | |
| 0306657 | m. WG | pergamon | 02661047001 | stuk | 702,00 | 016 | 1 | | | |
| | wandclosetpot diepspoel | | | | | | | | | |
| | 0293350 | | wit | 0182090000 | stuk | 584,00 | 015 | 0 | | |
| | 0299868 | | pergamon | 0182094700 | stuk | 584,00 | 016 | 1 | | |
| | 0306665 | m. WG | wit | 01820900001 | stuk | 633,00 | 016 | 1 | | |
| 0306673 | m. WG | pergamon | 01820947001 | stuk | 633,00 | 016 | 1 | | | |

| Art.nr | Specificaties | Kleur | Lev.nr | Ehd | Prijs | Grp | CC | |
|---|---------------------------|-------------------------|-------------|------------|---------|------|-----|---|
| Duravit 1930 | | | | | | | | |
| closetcombinatie diepspoel AO | | | | | | | | |
| 0297550 | | wit | 1930 | stuk | 879,00 | 015 | 1 | |
| 0299885 | | pergamon | 1930 | stuk | 879,00 | 016 | 1 | |
| 0297569 | | edelweiss | 1930 | stuk | 1126,00 | 016 | 1 | |
| 0307939 | m. WG | wit | 1930 | stuk | 928,00 | 015 | 1 | |
| 0307947 | m. WG | pergamon | 1930 | stuk | 928,00 | 015 | 1 | |
| 0830453 | set potschroeven 5.5x60mm | chroom | 0830453 | stuk | 2,28 | 362 | 0 | |
| closetcombinatie diepspoel PK | | | | | | | | |
| 0297577 | | wit | 1930 | stuk | 879,00 | 016 | 1 | |
| 0299886 | | pergamon | 1930 | stuk | 879,00 | 016 | 1 | |
| 0297585 | | edelweiss | 1930 | stuk | 1126,00 | 016 | 1 | |
| 0307955 | m. WG | wit | 1930 | stuk | 928,00 | 015 | 1 | |
| 0307963 | m. WG | pergamon | 1930 | stuk | 928,00 | 015 | 1 | |
| 0830453 | set potschroeven 5.5x60mm | chroom | 0830453 | stuk | 2,28 | 362 | 0 | |
| closetzitting dubbel | | | | | | | | |
| 0293326 | | wit | 0064810000 | stuk | 140,00 | 015 | 0 | |
| 0299894 | | pergamon | 0064814700 | stuk | 140,00 | 016 | 1 | |
| duoblokpot diepspoel AO z. reservoir | | | | | | | | |
| 0293296 | | wit | 0227010000 | stuk | 539,00 | 015 | 1 | |
| 0299869 | | pergamon | 0227014700 | stuk | 539,00 | 016 | 1 | |
| 0307890 | m. WG | wit | 02270100001 | stuk | 588,00 | 015 | 1 | |
| 0307904 | m. WG | pergamon | 02270147001 | stuk | 588,00 | 015 | 1 | |
| duoblokpot diepspoel PK z. reservoir | | | | | | | | |
| 0293318 | | wit | 0227090000 | stuk | 539,00 | 015 | 1 | |
| 0299870 | | pergamon | 0227094700 | stuk | 539,00 | 016 | 1 | |
| 0307912 | m. WG | wit | 02270900001 | stuk | 588,00 | 015 | 1 | |
| 0307920 | m. WG | pergamon | 02270947001 | stuk | 588,00 | 015 | 1 | |
| duoblokreservoir + binnenwerk | | | | | | | | |
| 0293334 | | wit | 0872200005 | stuk | 340,00 | 015 | 1 | |
| 0299871 | | pergamon | 0872204705 | stuk | 340,00 | 016 | 1 | |
| urinoir z. deksel | | | | | | | | |
| 0290087 | | wit | 0846300000 | stuk | 477,00 | 015 | 1 | |
| 0293253 | urinoirsifon | horizontaal | 0050120000 | stuk | 25,50 | 017 | 0 | |
| 0299853 | bevestigingsset | v. bidet/urinoir/closet | chroom | 0067011000 | stuk | 5,00 | 017 | 0 |
| deksel voor urinoir | | | | | | | | |
| 0290086 | | chroom/wit | 0065410000 | stuk | 88,00 | 015 | 1 | |



Sanitair producten

Baden /
douchebakken /
stoomcabines

Kranen

Douchegarnituur

Accessoires en
spiegels

Douchewanden

Toebehoren &
afvoerenSpoel- &
installatiesystemenBadkamermeubelen
en toiletkastenGootstenen en
wastroggen

Utiliteit

Inspiratie bron!

Voor uw
badkamer

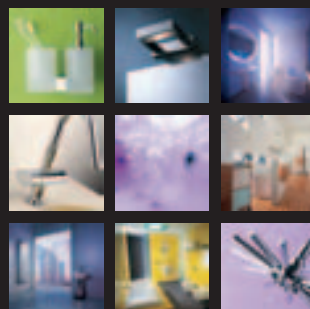

PLIEGER

| Art.nr | Specificaties | Kleur | Lev.nr | Ehd | Prijs | Grp | CC |
|--------------------------|--|---------|------------|------|--------|-----|----|
| Duravit 2nd floor | | | | | | | |
| wastafel | | | | | | | |
| 0290347 | 60x43cm m. 1 kraangat | wit | 491600000 | stuk | 225,00 | 015 | 0 |
| 0290349 | 60x43cm m. 1 kraangat | wit/RVS | 491606600 | stuk | 365,00 | 015 | 1 |
| 0290348 | 60x43cm m. 1 kraangat m. WG | wit | 4916000001 | stuk | 274,00 | 015 | 1 |
| 0290350 | 60x43cm m. 1 kraangat m. WG | wit/RVS | 4916066001 | stuk | 414,00 | 015 | 1 |
| 0290351 | 60x43cm m. 3 kraangaten | wit | 491600030 | stuk | 225,00 | 015 | 1 |
| 0290353 | 60x43cm m. 3 kraangaten | wit/RVS | 491606630 | stuk | 365,00 | 015 | 1 |
| 0290352 | 60x43cm m. 3 kraangaten m. WG | wit | 4916000301 | stuk | 274,00 | 015 | 1 |
| 0290354 | 60x43cm m. 3 kraangaten m. WG | wit/RVS | 4916066301 | stuk | 414,00 | 015 | 1 |
| 0290339 | 70x46cm m. 1 kraangat | wit | 491700000 | stuk | 320,00 | 015 | 0 |
| 0290341 | 70x46cm m. 1 kraangat | wit/RVS | 491706600 | stuk | 520,00 | 015 | 1 |
| 0290340 | 70x46cm m. 1 kraangat m. WG | wit | 4917000001 | stuk | 369,00 | 015 | 1 |
| 0290342 | 70x46cm m. 1 kraangat m. WG | wit/RVS | 4917066001 | stuk | 569,00 | 015 | 1 |
| 0290343 | 70x46cm m. 3 kraangaten | wit | 491700030 | stuk | 320,00 | 015 | 1 |
| 0290345 | 70x46cm m. 3 kraangaten | wit/RVS | 491706630 | stuk | 520,00 | 015 | 1 |
| 0290344 | 70x46cm m. 3 kraangaten m. WG | wit | 4917000301 | stuk | 369,00 | 015 | 1 |
| 0290346 | 70x46cm m. 3 kraangaten m. WG | wit/RVS | 4917066301 | stuk | 569,00 | 015 | 1 |
| 0291317 | 70x47cm geslepen m. 1 kraangat | wit | 491700027 | stuk | 370,00 | 015 | 1 |
| 0291319 | 70x47cm geslepen m. 1 kraangat | wit/rvs | 491706627 | stuk | 570,00 | 015 | 1 |
| 0291318 | 70x47cm geslepen m. 1 kraangat m. WG | wit | 4917000271 | stuk | 420,00 | 015 | 1 |
| 0291320 | 70x47cm geslepen m. 1 kraangat m. WG | wit/rvs | 4917066271 | stuk | 620,00 | 015 | 1 |
| 0291321 | 70x47cm geslepen m. 3 kraangaten | wit | 491700025 | stuk | 370,00 | 015 | 1 |
| 0291323 | 70x47cm geslepen m. 3 kraangaten | wit/rvs | 491706625 | stuk | 570,00 | 015 | 1 |
| 0291322 | 70x47cm geslepen m. 3 kraangaten m. WG | wit | 4917000251 | stuk | 420,00 | 015 | 1 |
| 0291324 | 70x47cm geslepen m. 3 kraangaten m. WG | wit/rvs | 4917066251 | stuk | 620,00 | 015 | 1 |
| 0830097 | bevestigingsset M10x110mm | | 0830097 | paar | 1,09 | 362 | 0 |

zuil voor wastafel

| | | | | | | | |
|---------|---------|-----|-----------|------|--------|-----|---|
| 0290355 | 60-70cm | wit | 863180000 | stuk | 115,00 | 015 | 0 |
|---------|---------|-----|-----------|------|--------|-----|---|

sifonkap voor wastafel

| | | | | | | | |
|---------|-----------------------------------|-----|------------|------|--------|-----|---|
| 0290356 | 60-70cm | wit | 857160000 | stuk | 110,00 | 015 | 0 |
| 0290963 | snelbevestigingsset voor sifonkap | | 0055030000 | stuk | 25,00 | 016 | 0 |



Sanitair producten

Baden /
douchebakken /
stoomcabines

Kranen

Douchegarnituur

Accessoires en
spiegels

Douchewanden

Toebehoren &
afvoerenSpoel- &
installatiesystemenBadkamermeubelen
en toiletkastenGootstenen en
wastroggen

Utiliteit

| | Art.nr | Specificaties | Kleur | Lev.nr | Ehd | Prijs | Grp | CC |
|---|---------|---|---------|------------|------|---------|-----|----|
| Duravit 2nd floor | | | | | | | | |
| wastafel | | | | | | | | |
| Sanitair producten | 0290329 | 80x50cm m. 1 kraangat | wit | 491800000 | stuk | 370,00 | 015 | 0 |
| | 0290331 | 80x50cm m. 1 kraangat | wit/RVS | 491806600 | stuk | 570,00 | 015 | 1 |
| Baden / douchebakken / stoomcabines | 0290330 | 80x50cm m. 1 kraangat m. WG | wit | 491800001 | stuk | 419,00 | 015 | 1 |
| | 0290332 | 80x50cm m. 1 kraangat m. WG | wit/RVS | 491806600 | stuk | 619,00 | 015 | 1 |
| | 0290333 | 80x50cm m. 3 kraangaten | wit | 491800030 | stuk | 370,00 | 015 | 1 |
| | 0290335 | 80x50cm m. 3 kraangaten | wit/RVS | 491806630 | stuk | 570,00 | 015 | 1 |
| | 0290334 | 80x50cm m. 3 kraangaten m. WG | wit | 491800030 | stuk | 419,00 | 015 | 1 |
| | 0290336 | 80x50cm m. 3 kraangaten m. WG | wit/RVS | 491806630 | stuk | 619,00 | 015 | 1 |
| Kranen | 0291309 | 80x50cm geslepen m. 1 kraangat | wit | 491800027 | stuk | 430,00 | 015 | 1 |
| | 0291311 | 80x50cm geslepen m. 1 kraangat | wit/rvs | 491806627 | stuk | 630,00 | 015 | 1 |
| | 0291310 | 80x50cm geslepen m. 1 kraangat m. WG | wit | 491800027 | stuk | 480,00 | 015 | 1 |
| Douchegarnituur | 0291312 | 80x50cm geslepen m. 1 kraangat m. WG | wit/rvs | 491806627 | stuk | 680,00 | 015 | 1 |
| | 0291313 | 80x50cm geslepen m. 3 kraangaten | wit | 491800025 | stuk | 430,00 | 015 | 1 |
| | 0291315 | 80x50cm geslepen m. 3 kraangaten | wit/rvs | 491806625 | stuk | 630,00 | 015 | 1 |
| | 0291314 | 80x50cm geslepen m. 3 kraangaten m. WG | wit | 491800025 | stuk | 480,00 | 015 | 1 |
| | 0291316 | 80x50cm geslepen m. 3 kraangaten m. WG | wit/rvs | 491806625 | stuk | 680,00 | 015 | 1 |
| | 0290317 | 120x50.5cm m. 1 kraangat | wit | 491120000 | stuk | 740,00 | 015 | 1 |
| Accessoires en spiegels | 0290319 | 120x50.5cm m. 1 kraangat | wit/RVS | 491126600 | stuk | 970,00 | 015 | 1 |
| | 0290318 | 120x50.5cm m. 1 kraangat m. WG | wit | 491120001 | stuk | 789,00 | 015 | 1 |
| | 0290320 | 120x50.5cm m. 1 kraangat m. WG | wit/RVS | 491126601 | stuk | 1019,00 | 015 | 1 |
| Douchewanden | 0290321 | 120x50.5cm m. 3 kraangaten | wit | 491120030 | stuk | 740,00 | 015 | 1 |
| | 0290323 | 120x50.5cm m. 3 kraangaten | wit/RVS | 491126630 | stuk | 970,00 | 015 | 1 |
| | 0290322 | 120x50.5cm m. 3 kraangaten m. WG | wit | 491120030 | stuk | 789,00 | 015 | 1 |
| | 0290324 | 120x50.5cm m. 3 kraangaten m. WG | wit/RVS | 491126630 | stuk | 1019,00 | 015 | 1 |
| | 0290325 | 120x50.5cm m. 2 kraangaten | wit | 491120024 | stuk | 740,00 | 015 | 0 |
| | 0290327 | 120x50.5cm m. 2 kraangaten | wit/RVS | 491126624 | stuk | 970,00 | 015 | 1 |
| Toebehoren & afvoeren | 0290326 | 120x50.5cm m. 2 kraangaten m. WG | wit | 491120024 | stuk | 789,00 | 015 | 1 |
| | 0290328 | 120x50.5cm m. 2 kraangaten m. WG | wit/RVS | 491126624 | stuk | 1019,00 | 015 | 1 |
| | 0291297 | 120x50.5cm geslepen m. 1 kraangat | wit | 491120027 | stuk | 745,00 | 015 | 1 |
| Spoel- & installatiesystemen | 0291299 | 120x50.5cm geslepen m. 1 kraangat | wit/rvs | 491126627 | stuk | 975,00 | 015 | 1 |
| | 0291298 | 120x50.5cm geslepen m. 1 kraangat m. WG | wit | 491120027 | stuk | 795,00 | 015 | 1 |
| | 0291300 | 120x50.5cm geslepen m. 1 kraangat m. WG | wit/rvs | 491126627 | stuk | 1025,00 | 015 | 1 |
| | 0291301 | 120x50.5cm geslepen m. 3 kraangaten | wit | 491120025 | stuk | 745,00 | 015 | 1 |
| | 0291303 | 120x50.5cm geslepen m. 3 kraangaten | wit/rvs | 491126625 | stuk | 975,00 | 015 | 1 |
| Badkamermeubelen en toiletkasten | 0291302 | 120x50.5cm geslepen m. 3 kraangaten m. WG | wit | 491120025 | stuk | 795,00 | 015 | 1 |
| | 0291304 | 120x50.5cm geslepen m. 3 kraangaten m. WG | wit/rvs | 491126625 | stuk | 1025,00 | 015 | 1 |
| | 0291305 | 120x50.5cm geslepen m. 2 kraangaten | wit | 491120026 | stuk | 745,00 | 015 | 1 |
| | 0291307 | 120x50.5cm geslepen m. 2 kraangaten | wit/rvs | 491126626 | stuk | 975,00 | 015 | 1 |
| Gootstenen en wastroggen | 0291306 | 120x50.5cm geslepen m. 2 kraangaten m. WG | wit | 491120026 | stuk | 795,00 | 015 | 1 |
| | 0291308 | 120x50.5cm geslepen m. 2 kraangaten m. WG | wit/rvs | 491126626 | stuk | 1025,00 | 015 | 1 |
| Utiliteit | 0830097 | bevestigingsset M10x110mm | | 0830097 | paar | 1,09 | 362 | 0 |
| | | zuil voor wastafel | | | | | | |
| | 0290337 | 80-120cm | wit | 863190000 | stuk | 140,00 | 015 | 0 |
| sifonkap voor wastafel | | | | | | | | |
| | 0290338 | 80-120cm | wit | 857140000 | stuk | 115,00 | 015 | 0 |
| | 0290963 | snelbevestigingsset voor sifonkap | | 0055030000 | stuk | 25,00 | 016 | 0 |

| Art.nr | Specificaties | Kleur | Lev.nr | Ehd | Prijs | Grp | CC |
|--------|---------------|-------|--------|-----|-------|-----|----|
|--------|---------------|-------|--------|-----|-------|-----|----|

Duravit 2nd floor

fontein z. overloop

| | | | | | | | |
|---------|--------------------------------------|---------------------|-----|-----------|------|--------|-------|
| 0290361 | 40x30cm | m. 1 kraangat | wit | 790400000 | stuk | 125,00 | 015 0 |
| 0290362 | 40x30cm | m. 1 kraangat m. WG | wit | 790400001 | stuk | 174,00 | 015 1 |
| 0290357 | 50x40cm | m. 1 kraangat | wit | 790500000 | stuk | 145,00 | 015 0 |
| 0290358 | 50x40cm | m. 1 kraangat m. WG | wit | 790500001 | stuk | 194,00 | 015 1 |
| 0830240 | bevestigingsset voor fontein M8x90mm | | | 0830240 | stuk | 0,85 | 362 0 |

**sifonkap voor fontein**

| | | | | | | | |
|---------|--------------------------------------|--|-----|-----------|------|--------|-------|
| 0290359 | 50cm | | wit | 857130000 | stuk | 110,00 | 015 1 |
| 0290360 | bevestigingsset voor sifonkap 085713 | | | 55050000 | stuk | 25,00 | 015 1 |

**bevestigingsset voor sifonkap 085713**

| | | | | | | | |
|---------|--|--|--|----------|------|-------|-------|
| 0290360 | | | | 55050000 | stuk | 25,00 | 015 1 |
|---------|--|--|--|----------|------|-------|-------|

opbouw wastafel z. overloop z. kraangat

| | | | | | | | |
|---------|-----------|-------|---------|-----------|------|--------|-------|
| 0290363 | 58x41.5cm | | wit | 317580000 | stuk | 215,00 | 015 1 |
| 0290365 | 58x41.5cm | | wit/RVS | 317586600 | stuk | 355,00 | 015 1 |
| 0290364 | 58x41.5cm | m. WG | wit | 317580001 | stuk | 264,00 | 015 1 |
| 0290366 | 58x41.5cm | m. WG | wit/RVS | 317586601 | stuk | 404,00 | 015 1 |

**inbouw wastafel z. overloop z. kraangat**

| | | | | | | | |
|---------|-----------|-------|---------|------------|------|--------|-------|
| 0290367 | 58x41.5cm | | wit | 317580029 | stuk | 170,00 | 015 1 |
| 0290369 | 58x41.5cm | | wit/RVS | 317586629 | stuk | 310,00 | 015 1 |
| 0290368 | 58x41.5cm | m. WG | wit | 3175800291 | stuk | 219,00 | 015 1 |
| 0290370 | 58x41.5cm | m. WG | wit/RVS | 3175866291 | stuk | 359,00 | 015 1 |

**onderbouw wastafel z. kraangat m. bevestiging**

| | | | | | | | |
|---------|-----------|-------|---------|-----------|------|--------|-------|
| 0290371 | 55.5x38cm | | wit | 316530000 | stuk | 180,00 | 015 1 |
| 0290373 | 55.5x38cm | | wit/RVS | 316536600 | stuk | 320,00 | 015 1 |
| 0290372 | 55.5x38cm | m. WG | wit | 316530001 | stuk | 229,00 | 015 1 |
| 0290374 | 55.5x38cm | m. WG | wit/RVS | 316536601 | stuk | 369,00 | 015 1 |

**bevestigingsset in- onderbouw wastafel voor montage in stenen blad**

| | | | | | | | |
|---------|--|--|--|------------|------|-------|-------|
| 0290375 | | | | 0050280000 | stuk | 13,00 | 015 1 |
|---------|--|--|--|------------|------|-------|-------|

wandbidet

| | | | | | | | |
|---------|--|-------|-----|------------|------|--------|-------|
| 0290378 | | | wit | 2235150000 | stuk | 275,00 | 015 1 |
| 0290379 | | m. WG | wit | 2235150001 | stuk | 324,00 | 015 1 |



Sanitair producten

Baden /
douchebakken /
stoomcabines

Kranen

Douchegarnituur

Accessoires en
spiegels

Douchewanden

Toebehoren &
afvoerenSpoel- &
installatiesystemenBadkamermeubelen
en toiletkastenGootstenen en
wastroggen

Utiliteit

| Art.nr | Specificaties | Kleur | Lev.nr | Ehd | Prijs | Grp | CC |
|--|-------------------|---|-------------|-------------|-------|--------|-------|
| Duravit 2nd floor | | | | | | | |
| bidet m. bevestiging | | | | | | | |
| | 0290382 57x35cm | m. 1 kraangat | wit | 136100000 | stuk | 295,00 | 015 1 |
| | 0290383 57x35cm | m. 1 kraangat m. WG | wit | 136100001 | stuk | 344,00 | 015 1 |
| | 0290384 57x35cm | m. 3 kraangaten | wit | 136100030 | stuk | 295,00 | 015 1 |
| | 0290385 57x35cm | m. 3 kraangaten m. WG | wit | 1361000301 | stuk | 344,00 | 015 1 |
| | 0290386 66.5x35cm | m. 1 kraangat | wit | 137100000 | stuk | 295,00 | 015 1 |
| | 0290387 66.5x35cm | m. 1 kraangat m. WG | wit | 137100001 | stuk | 344,00 | 015 1 |
| | 0290388 66.5x35cm | m. 3 kraangaten | wit | 137100030 | stuk | 295,00 | 015 1 |
| | 0290389 66.5x35cm | m. 3 kraangaten m. WG | wit | 1371000301 | stuk | 344,00 | 015 1 |
| closetpot diepspoel staand m. bevestiging | | | | | | | |
| | 0290380 | | wit | 110090000 | stuk | 360,00 | 015 1 |
| | 0290381 | m. WG | wit | 110090001 | stuk | 409,00 | 015 1 |
| duoblokpot diepspoel vario z. reservoir | | | | | | | |
| | 0290390 | | wit | 2106090000 | stuk | 440,00 | 015 0 |
| | 0290391 | m. WG | wit | 21060900001 | stuk | 489,00 | 015 1 |
| | 0290394 | duoblokreservoir m. binnenwerk zijaansluiting wit | | 876000005 | stuk | 260,00 | 015 0 |
| duoblokpot diepspoel PK z. reservoir | | | | | | | |
| | 0290392 | | wit | 2107090000 | stuk | 340,00 | 015 1 |
| | 0290393 | m. WG | wit | 21070900001 | stuk | 389,00 | 015 1 |
| | 0290394 | duoblokreservoir m. binnenwerk zijaansluiting wit | | 876000005 | stuk | 260,00 | 015 0 |
| duoblokreservoir m. binnenwerk | | | | | | | |
| | 0290394 | zijaansluiting | wit | 876000005 | stuk | 260,00 | 015 0 |
| | 0290395 | onder aansluiting | wit | 876100005 | stuk | 260,00 | 015 0 |
| wandclosetpot diepspoel | | | | | | | |
| | 0290376 | | wit | 2205090000 | stuk | 360,00 | 015 0 |
| | 0290377 | m. WG | wit | 22050900001 | stuk | 409,00 | 015 1 |
| closetzitting dubbel m. softclose | | | | | | | |
| | 0290396 | | wit | 0068990000 | stuk | 140,00 | 015 0 |
| onderbouwrand v. fontein | | | | | | | |
| | 0290573 38x29cm | | palissander | 640567 | stuk | 170,00 | 304 1 |
| | 0290574 38x29cm | | eiken | 640565 | stuk | 190,00 | 304 1 |

| Art.nr | Specificaties | Kleur | Lev.nr | Ehd | Prijs | Grp | CC | |
|--|---------------|-----------------------|-------------|---------|--------|---------|-----|---|
| Duravit 2nd floor | | | | | | | | |
| onderbouwrand v. wastafel | | | | | | | | |
| 0290575 | 58x42cm | palissander | 640667 | stuk | 180,00 | 304 | 1 | |
| 0290576 | 58x42cm | eiken | 640665 | stuk | 210,00 | 304 | 1 | |
| 0290577 | 78x49cm | palissander | 640767 | stuk | 190,00 | 304 | 1 | |
| 0290578 | 78x49cm | eiken | 640765 | stuk | 230,00 | 304 | 1 | |
| 0290579 | 118x49cm | palissander | 640867 | stuk | 210,00 | 304 | 1 | |
| 0290580 | 118x49cm | eiken | 640865 | stuk | 250,00 | 304 | 1 | |
| planchet | | | | | | | | |
| 0290581 | 38x27cm | v. onderbouwrand 6405 | palissander | 644067 | stuk | 250,00 | 304 | 1 |
| 0290582 | 38x27cm | v. onderbouwrand 6405 | eiken | 644065 | stuk | 285,00 | 304 | 1 |
| 0290583 | 58x40cm | v. onderbouwrand 6406 | palissander | 644167 | stuk | 270,00 | 304 | 1 |
| 0290584 | 58x40cm | v. onderbouwrand 6406 | eiken | 644165 | stuk | 335,00 | 304 | 1 |
| 0290585 | 78x44cm | v. onderbouwrand 6407 | palissander | 644267 | stuk | 300,00 | 304 | 1 |
| 0290586 | 78x44cm | v. onderbouwrand 6407 | eiken | 644265 | stuk | 405,00 | 304 | 1 |
| 0290587 | 118x44cm | v. onderbouwrand 6408 | palissander | 644367 | stuk | 340,00 | 304 | 1 |
| 0290588 | 118x44cm | v. onderbouwrand 6408 | eiken | 644365 | stuk | 480,00 | 304 | 1 |
| onderbouwkast v. fontein | | | | | | | | |
| 0290591 | 38x29cm | scharnier links | palissander | 6445L67 | stuk | 390,00 | 304 | 1 |
| 0290592 | 38x29cm | scharnier links | eiken | 6445L65 | stuk | 485,00 | 304 | 1 |
| 0290593 | 38x29cm | scharnier rechts | palissander | 6445R67 | stuk | 390,00 | 304 | 1 |
| 0290594 | 38x29cm | scharnier rechts | eiken | 6445R65 | stuk | 485,00 | 304 | 1 |
| onderbouwkast m. lade v. wastafel | | | | | | | | |
| 0290595 | 58x42cm | | palissander | 644667 | stuk | 530,00 | 304 | 1 |
| 0290596 | 58x42cm | | eiken | 644665 | stuk | 660,00 | 304 | 1 |
| 0290597 | 78x49cm | | palissander | 644767 | stuk | 660,00 | 304 | 1 |
| 0290598 | 78x49cm | | eiken | 644765 | stuk | 810,00 | 304 | 1 |
| 0290599 | 118x49cm | | palissander | 644867 | stuk | 800,00 | 304 | 1 |
| 0290600 | 118x49cm | | eiken | 644865 | stuk | 1050,00 | 304 | 1 |
| spiegel m. verlichting | | | | | | | | |
| 0290601 | 40x62cm | | palissander | 964567 | stuk | 740,00 | 304 | 1 |
| 0290602 | 40x62cm | | eiken | 964565 | stuk | 760,00 | 304 | 1 |
| 0290603 | 60x62cm | | palissander | 964667 | stuk | 760,00 | 304 | 1 |
| 0290604 | 60x62cm | | eiken | 964665 | stuk | 780,00 | 304 | 1 |
| 0290605 | 80x62cm | | palissander | 964767 | stuk | 770,00 | 304 | 1 |
| 0290606 | 80x62cm | | eiken | 964765 | stuk | 790,00 | 304 | 1 |
| 0290607 | 120x62cm | | palissander | 964867 | stuk | 830,00 | 304 | 1 |
| 0290608 | 120x62cm | | eiken | 964865 | stuk | 850,00 | 304 | 1 |
| spiegelkast m. verlichting | | | | | | | | |
| 0290609 | 40x62cm | scharnier links | palissander | 9650L67 | stuk | 850,00 | 304 | 1 |
| 0290610 | 40x62cm | scharnier links | eiken | 9650L65 | stuk | 920,00 | 304 | 1 |
| 0290611 | 40x62cm | scharnier rechts | palissander | 9650R67 | stuk | 850,00 | 304 | 1 |
| 0290612 | 40x62cm | scharnier rechts | eiken | 9650R65 | stuk | 920,00 | 304 | 1 |
| 0290613 | 60x62cm | | palissander | 965167 | stuk | 980,00 | 304 | 1 |
| 0290614 | 60x62cm | | eiken | 965165 | stuk | 1050,00 | 304 | 1 |
| 0290615 | 80x62cm | | palissander | 965267 | stuk | 1060,00 | 304 | 1 |
| 0290616 | 80x62cm | | eiken | 965265 | stuk | 1150,00 | 304 | 1 |
| 0290617 | 120x62cm | scharnier links | palissander | 9653L67 | stuk | 1190,00 | 304 | 1 |
| 0290618 | 120x62cm | scharnier links | eiken | 9653L65 | stuk | 1390,00 | 304 | 1 |
| 0290264 | 120x62cm | scharnier rechts | palissander | 9653R67 | stuk | 1190,00 | 304 | 1 |
| 0290265 | 120x62cm | scharnier rechts | eiken | 9653R65 | stuk | 1390,00 | 304 | 1 |
| wandkast m. lade | | | | | | | | |
| 0290619 | 60x36x43xm | | palissander | 926667 | stuk | 620,00 | 304 | 1 |
| 0290620 | 60x36x43xm | | eiken | 926665 | stuk | 790,00 | 304 | 1 |
| 0290621 | 80x36x43xm | | palissander | 926767 | stuk | 720,00 | 304 | 1 |
| 0290622 | 80x36x43xm | | eiken | 926765 | stuk | 890,00 | 304 | 1 |
| rolcontainer m. lade | | | | | | | | |
| 0290623 | 50x36x62cm | | palissander | 9272L67 | stuk | 640,00 | 304 | 1 |
| 0290624 | 50x36x62cm | | eiken | 9272L65 | stuk | 870,00 | 304 | 1 |
| hoge kast m. 1 deur | | | | | | | | |
| 0290625 | 50x180x36cm | scharnier links | palissander | 9156L67 | stuk | 670,00 | 304 | 1 |
| 0290626 | 50x180x36cm | scharnier links | eiken | 9156L65 | stuk | 1150,00 | 304 | 1 |
| 0290627 | 50x180x36cm | scharnier rechts | palissander | 9156R67 | stuk | 670,00 | 304 | 1 |
| 0290628 | 50x180x36cm | scharnier rechts | eiken | 9156R65 | stuk | 1150,00 | 304 | 1 |
| hoge kast m. 1 spiegeldeur | | | | | | | | |
| 0290629 | 50x180x36cm | scharnier links | palissander | 9157L67 | stuk | 1250,00 | 304 | 1 |
| 0290630 | 50x180x36cm | scharnier links | eiken | 9157L65 | stuk | 1550,00 | 304 | 1 |
| 0290631 | 50x180x36cm | scharnier rechts | palissander | 9157R67 | stuk | 1250,00 | 304 | 1 |
| 0290632 | 50x180x36cm | scharnier rechts | eiken | 9157R65 | stuk | 1550,00 | 304 | 1 |

Sanitair producten

Baden /
douchebakken /
stoomcabines

Kranen

Douchegarnituur

Accessoires en
spiegels

Douchewanden

Toebehoren &
afvoerenSpoel- &
installatiesystemenBadkamermeubelen
en toiletkastenGootstenen en
wastroggen

Utiliteit

| Art.nr | Specificaties | Kleur | Lev.nr | Ehd | Prijs | Grp | CC |
|--------|---------------|-------|--------|-----|-------|-----|----|
|--------|---------------|-------|--------|-----|-------|-----|----|

Duravit 2nd floor

handdoekhouder v. 6406-6408

| | | | | | | | |
|---------|------|--------|------|------|--------|-----|---|
| 0290589 | 50cm | chroom | 9985 | stuk | 105,00 | 304 | 1 |
|---------|------|--------|------|------|--------|-----|---|

handdoekhouder v. planchet 6408

| | | | | | | | |
|---------|-------|--------|------|------|--------|-----|---|
| 0290590 | 100cm | chroom | 9986 | stuk | 139,00 | 304 | 1 |
|---------|-------|--------|------|------|--------|-----|---|

Duravit Caro

wastafel

| | | | | | | | |
|---------|---------|-----|------------|------|--------|-----|---|
| 0293407 | 60x47cm | wit | 0434600000 | stuk | 296,00 | 015 | 1 |
|---------|---------|-----|------------|------|--------|-----|---|

| | | | | | | | |
|---------|---------|----------|------------|------|--------|-----|---|
| 0293425 | 60x47cm | pergamon | 0434604700 | stuk | 296,00 | 015 | 1 |
|---------|---------|----------|------------|------|--------|-----|---|

| | | | | | | | |
|---------|---------|-----------|------------|------|--------|-----|---|
| 0293431 | 60x47cm | greenwich | 0434605200 | stuk | 296,00 | 015 | 1 |
|---------|---------|-----------|------------|------|--------|-----|---|

| | | | | | | | | |
|---------|---------|-------|-----|------------|------|--------|-----|---|
| 0306983 | 60x47cm | m. WG | wit | 0434600001 | stuk | 345,00 | 015 | 1 |
|---------|---------|-------|-----|------------|------|--------|-----|---|

| | | | | | | | | |
|---------|---------|-------|----------|-------------|------|--------|-----|---|
| 0306991 | 60x47cm | m. WG | pergamon | 04346047001 | stuk | 345,00 | 015 | 1 |
|---------|---------|-------|----------|-------------|------|--------|-----|---|

| | | | | | | | | |
|---------|-----------|--|-----|------------|------|--------|-----|---|
| 0293237 | 70x50.5cm | | wit | 0434700000 | stuk | 458,00 | 015 | 1 |
|---------|-----------|--|-----|------------|------|--------|-----|---|

| | | | | | | | | |
|---------|-----------|--|----------|------------|------|--------|-----|---|
| 0293712 | 70x50.5cm | | pergamon | 0434704700 | stuk | 458,00 | 015 | 1 |
|---------|-----------|--|----------|------------|------|--------|-----|---|

| | | | | | | | | |
|---------|-----------|--|-----------|------------|------|--------|-----|---|
| 0293342 | 70x50.5cm | | greenwich | 0434705200 | stuk | 458,00 | 015 | 1 |
|---------|-----------|--|-----------|------------|------|--------|-----|---|

| | | | | | | | | |
|---------|-----------|-------|-----|------------|------|--------|-----|---|
| 0307009 | 70x50.5cm | m. WG | wit | 0434700001 | stuk | 507,00 | 015 | 1 |
|---------|-----------|-------|-----|------------|------|--------|-----|---|

| | | | | | | | | |
|---------|-----------|-------|----------|-------------|------|--------|-----|---|
| 0307017 | 70x50.5cm | m. WG | pergamon | 04347047001 | stuk | 507,00 | 015 | 1 |
|---------|-----------|-------|----------|-------------|------|--------|-----|---|

| | | | | | | | | |
|---------|-----------|--|-----|------------|------|--------|-----|---|
| 0290769 | 90x59.5cm | | wit | 0434900000 | stuk | 708,00 | 015 | 1 |
|---------|-----------|--|-----|------------|------|--------|-----|---|

| | | | | | | | | |
|---------|-----------|--|----------|------------|------|--------|-----|---|
| 0293210 | 90x59.5cm | | pergamon | 0434904700 | stuk | 708,00 | 015 | 1 |
|---------|-----------|--|----------|------------|------|--------|-----|---|

| | | | | | | | | |
|---------|-----------|--|-----------|------------|------|--------|-----|---|
| 0293229 | 90x59.5cm | | greenwich | 0434905200 | stuk | 708,00 | 015 | 1 |
|---------|-----------|--|-----------|------------|------|--------|-----|---|

| | | | | | | | | |
|---------|-----------|-------|-----|------------|------|--------|-----|---|
| 0307025 | 90x59.5cm | m. WG | wit | 0434900001 | stuk | 757,00 | 015 | 1 |
|---------|-----------|-------|-----|------------|------|--------|-----|---|

| | | | | | | | | |
|---------|-----------|-------|----------|-------------|------|--------|-----|---|
| 0307033 | 90x59.5cm | m. WG | pergamon | 04349047001 | stuk | 757,00 | 015 | 1 |
|---------|-----------|-------|----------|-------------|------|--------|-----|---|

| | | | | | | | |
|---------|---------------------------|--|---------|------|------|-----|---|
| 0830097 | bevestigingsset M10x110mm | | 0830097 | paar | 1,09 | 362 | 0 |
|---------|---------------------------|--|---------|------|------|-----|---|

sifonkap voor wastafel

| | | | | | | | |
|---------|---------|-----|------------|------|--------|-----|---|
| 0293695 | 60-70cm | wit | 0863260000 | stuk | 192,00 | 015 | 1 |
|---------|---------|-----|------------|------|--------|-----|---|

| | | | | | | | |
|---------|---------|----------|------------|------|--------|-----|---|
| 0293713 | 60-70cm | pergamon | 0863264700 | stuk | 192,00 | 015 | 1 |
|---------|---------|----------|------------|------|--------|-----|---|

| | | | | | | | |
|---------|---------|-----------|------------|------|--------|-----|---|
| 0293768 | 60-70cm | greenwich | 0863265200 | stuk | 192,00 | 015 | 1 |
|---------|---------|-----------|------------|------|--------|-----|---|

| | | | | | | | |
|---------|------|-----|------------|------|--------|-----|---|
| 0293466 | 90cm | wit | 0863250000 | stuk | 202,00 | 015 | 1 |
|---------|------|-----|------------|------|--------|-----|---|

| | | | | | | | |
|---------|------|----------|------------|------|--------|-----|---|
| 0293490 | 90cm | pergamon | 0863254700 | stuk | 202,00 | 015 | 1 |
|---------|------|----------|------------|------|--------|-----|---|

| | | | | | | | |
|---------|------|-----------|------------|------|--------|-----|---|
| 0293563 | 90cm | greenwich | 0863255200 | stuk | 202,00 | 015 | 1 |
|---------|------|-----------|------------|------|--------|-----|---|

| | | | | | | | |
|---------|-----------------------------------|--|------------|------|-------|-----|---|
| 0290963 | snelbevestigingsset voor sifonkap | | 0055030000 | stuk | 25,00 | 016 | 0 |
|---------|-----------------------------------|--|------------|------|-------|-----|---|

zuil voor wastafel

| | | | | | | | |
|---------|---------|-----|------------|------|--------|-----|---|
| 0293806 | 60-70cm | wit | 0863210000 | stuk | 237,00 | 015 | 1 |
|---------|---------|-----|------------|------|--------|-----|---|

| | | | | | | | |
|---------|---------|----------|------------|------|--------|-----|---|
| 0293814 | 60-70cm | pergamon | 0863214700 | stuk | 237,00 | 015 | 1 |
|---------|---------|----------|------------|------|--------|-----|---|

| | | | | | | | |
|---------|---------|-----------|------------|------|--------|-----|---|
| 0293822 | 60-70cm | greenwich | 0863215200 | stuk | 237,00 | 015 | 1 |
|---------|---------|-----------|------------|------|--------|-----|---|

| | | | | | | | |
|---------|------|-----|------------|------|--------|-----|---|
| 0293776 | 90cm | wit | 0863200000 | stuk | 261,00 | 015 | 1 |
|---------|------|-----|------------|------|--------|-----|---|

| | | | | | | | |
|---------|------|----------|------------|------|--------|-----|---|
| 0293784 | 90cm | pergamon | 0863204700 | stuk | 261,00 | 015 | 1 |
|---------|------|----------|------------|------|--------|-----|---|

| | | | | | | | |
|---------|------|-----------|------------|------|--------|-----|---|
| 0293792 | 90cm | greenwich | 0863205200 | stuk | 261,00 | 015 | 1 |
|---------|------|-----------|------------|------|--------|-----|---|

meubelwastafel

| | | | | | | | |
|---------|-----------|-----|------------|------|--------|-----|---|
| 0307041 | 90x59.5cm | wit | 0461900000 | stuk | 541,00 | 015 | 1 |
|---------|-----------|-----|------------|------|--------|-----|---|

| | | | | | | | |
|---------|-----------|----------|------------|------|--------|-----|---|
| 0307866 | 90x59.5cm | pergamon | 0461904700 | stuk | 541,00 | 015 | 1 |
|---------|-----------|----------|------------|------|--------|-----|---|

| | | | | | | | | |
|---------|-----------|-------|-----|------------|------|--------|-----|---|
| 0305391 | 90x59.5cm | m. WG | wit | 0461900001 | stuk | 590,00 | 016 | 1 |
|---------|-----------|-------|-----|------------|------|--------|-----|---|

| | | | | | | | | |
|---------|-----------|-------|----------|-------------|------|--------|-----|---|
| 0307874 | 90x59.5cm | m. WG | pergamon | 04619047001 | stuk | 590,00 | 015 | 1 |
|---------|-----------|-------|----------|-------------|------|--------|-----|---|

| | | | | | | | |
|---------|---------------------------|--|---------|------|------|-----|---|
| 0830097 | bevestigingsset M10x110mm | | 0830097 | paar | 1,09 | 362 | 0 |
|---------|---------------------------|--|---------|------|------|-----|---|

wastafelonderbouw links

| | | | | | | | |
|---------|--|--------------|----------|------|--------|-----|---|
| 0305405 | | ahorn/laguna | 95840391 | stuk | 843,00 | 304 | 1 |
|---------|--|--------------|----------|------|--------|-----|---|

| | | | | | | | |
|---------|--|-------------|----------|------|--------|-----|---|
| 0305413 | | ahorn/cocos | 95840392 | stuk | 955,00 | 304 | 1 |
|---------|--|-------------|----------|------|--------|-----|---|

| | | | | | | | |
|---------|------------------------------|-----|--------|------|-------|-----|---|
| 0294810 | meubelvoet keramiek per stuk | wit | 993500 | stuk | 43,00 | 304 | 1 |
|---------|------------------------------|-----|--------|------|-------|-----|---|

| | | | | | | | |
|---------|------------------------------|----------|--------|------|-------|-----|---|
| 0294829 | meubelvoet keramiek per stuk | pergamon | 993547 | stuk | 43,00 | 304 | 1 |
|---------|------------------------------|----------|--------|------|-------|-----|---|

| | | | | | | | |
|---------|------------------------------|-----------|--------|------|-------|-----|---|
| 0294837 | meubelvoet keramiek per stuk | greenwich | 993552 | stuk | 43,00 | 304 | 1 |
|---------|------------------------------|-----------|--------|------|-------|-----|---|

meubelwastafel

| | | | | | | | |
|---------|----------|-----|------------|------|---------|-----|---|
| 0294438 | 140x52cm | wit | 0461140000 | stuk | 1477,00 | 015 | 1 |
|---------|----------|-----|------------|------|---------|-----|---|

| | | | | | | | |
|---------|----------|----------|------------|------|---------|-----|---|
| 0294446 | 140x52cm | pergamon | 0461144700 | stuk | 1477,00 | 015 | 1 |
|---------|----------|----------|------------|------|---------|-----|---|

| | | | | | | | |
|---------|----------|-----------|------------|------|---------|-----|---|
| 0294462 | 140x52cm | greenwich | 0461145200 | stuk | 1477,00 | 015 | 1 |
|---------|----------|-----------|------------|------|---------|-----|---|

| | | | | | | | | |
|---------|----------|-------|-----|------------|------|---------|-----|---|
| 0307068 | 140x52cm | m. WG | wit | 0461140001 | stuk | 1526,00 | 015 | 1 |
|---------|----------|-------|-----|------------|------|---------|-----|---|

| | | | | | | | | |
|---------|----------|-------|----------|-------------|------|---------|-----|---|
| 0307076 | 140x52cm | m. WG | pergamon | 04611447001 | stuk | 1526,00 | 015 | 1 |
|---------|----------|-------|----------|-------------|------|---------|-----|---|

| | | | | | | | |
|---------|---------------------------|--|---------|------|------|-----|---|
| 0830097 | bevestigingsset M10x110mm | | 0830097 | paar | 1,09 | 362 | 0 |
|---------|---------------------------|--|---------|------|------|-----|---|

wastafelonderbouw

| | | | | | | | |
|---------|--|-------------|----------|------|---------|-----|---|
| 0294489 | | ahorn/cocos | 95830392 | stuk | 1633,00 | 304 | 1 |
|---------|--|-------------|----------|------|---------|-----|---|

| | | | | | | | |
|---------|--|--------------|----------|------|---------|-----|---|
| 0294470 | | ahorn/lagune | 95830391 | stuk | 1448,00 | 304 | 1 |
|---------|--|--------------|----------|------|---------|-----|---|







| | | | | | | | |
|---------|--|----------------|----------|------|---------|-----|---|
| 0294500 | | ahorn-li/cocos | 95833492 | stuk | 1633,00 | 304 | 1 |
|---------|--|----------------|----------|------|---------|-----|---|

| | | | | | | | |
|---------|--|-----------------|----------|------|---------|-----|---|
| 0294497 | | ahorn-li/lagune | 95833491 | stuk | 1448,00 | 304 | 1 |
|---------|--|-----------------|----------|------|---------|-----|---|

| | | | | | | | |
|---------|------------------------------|-----|--------|------|-------|-----|---|
| 0294810 | meubelvoet keramiek per stuk | wit | 993500 | stuk | 43,00 | 304 | 1 |
|---------|------------------------------|-----|--------|------|-------|-----|---|

| | | | | | | | |
|---------|------------------------------|----------|--------|------|-------|-----|---|
| 0294829 | meubelvoet keramiek per stuk | pergamon | 993547 | stuk | 43,00 | 304 | 1 |
|---------|------------------------------|----------|--------|------|-------|-----|---|

| | | | | | | | |
|---------|------------------------------|-----------|--------|------|-------|-----|---|
| 0294837 | meubelvoet keramiek per stuk | greenwich | 993552 | stuk | 43,00 | 304 | 1 |
|---------|------------------------------|-----------|--------|------|-------|-----|---|

| Art.nr | Specificaties | Kleur | Lev.nr | Ehd | Prijs | Grp | CC | |
|---|--------------------------------------|-----------|-------------|------|---------|-----|----|---|
| Duravit Caro | | | | | | | | |
| fontein | | | | | | | |  |
| 0294276 | 50x36.5cm | wit | 0791500000 | stuk | 223,00 | 015 | 1 | |
| 0292205 | 50x36.5cm | pergamon | 0791504700 | stuk | 223,00 | 015 | 1 | |
| 0294284 | 50x36.5cm | greenwich | 0791505200 | stuk | 223,00 | 015 | 1 | |
| 0307084 | 50x36.5cm m. WG | wit | 07915000001 | stuk | 272,00 | 015 | 1 | |
| 0307092 | 50x36.5cm m. WG | pergamon | 07915047001 | stuk | 272,00 | 015 | 1 | |
| 0830240 | bevestigingsset voor fontein M8x90mm | | 0830240 | stuk | 0,85 | 362 | 0 | |
| sifonkap voor fontein | | | | | | | | |
| 0294292 | | wit | 0863220000 | stuk | 156,00 | 015 | 1 | |
| 0292225 | | pergamon | 0863224700 | stuk | 156,00 | 015 | 1 | |
| 0294322 | | greenwich | 0863225200 | stuk | 156,00 | 015 | 1 | |
| 0290963 | snelbevestigingsset voor sifonkap | | 0055030000 | stuk | 25,00 | 016 | 0 | |
| staand bidet | | | | | | | |  |
| 0293903 | | wit | 0290100000 | stuk | 427,00 | 015 | 1 | |
| 0293911 | | pergamon | 0290104700 | stuk | 427,00 | 015 | 1 | |
| 0293962 | | greenwich | 0290105200 | stuk | 427,00 | 015 | 1 | |
| 0307106 | m. WG | wit | 02901000001 | stuk | 476,00 | 015 | 1 | |
| 0307114 | m. WG | pergamon | 02901047001 | stuk | 476,00 | 015 | 1 | |
| wandbidet | | | | | | | |  |
| 0293865 | | wit | 0290150000 | stuk | 445,00 | 015 | 1 | |
| 0293873 | | pergamon | 0290154700 | stuk | 445,00 | 015 | 1 | |
| 0293881 | | greenwich | 0290155200 | stuk | 445,00 | 015 | 1 | |
| 0307122 | m. WG | wit | 02901500001 | stuk | 494,00 | 015 | 1 | |
| 0307130 | m. WG | pergamon | 02901547001 | stuk | 494,00 | 015 | 1 | |
| wandclosetpot diepspoel | | | | | | | |  |
| 0294004 | | wit | 0198090000 | stuk | 596,00 | 015 | 1 | |
| 0293710 | | pergamon | 0198094700 | stuk | 596,00 | 015 | 1 | |
| 0294012 | | greenwich | 0198095200 | stuk | 596,00 | 015 | 1 | |
| 0307149 | m. WG | wit | 01980900001 | stuk | 645,00 | 015 | 1 | |
| 0307157 | m. WG | pergamon | 01980947001 | stuk | 645,00 | 015 | 1 | |
| closetcombinatie universeel | | | | | | | |  |
| 0294039 | | wit | CARO | stuk | 1160,00 | 015 | 1 | |
| 0294047 | | pergamon | CARO | stuk | 1160,00 | 015 | 1 | |
| 0294055 | | greenwich | CARO | stuk | 1160,00 | 015 | 1 | |
| 0308005 | m. WG | wit | CARO | stuk | 1209,00 | 015 | 1 | |
| 0308013 | m. WG | pergamon | CARO | stuk | 1209,00 | 015 | 1 | |
| 0293709 | vario aansluitset verstelbaar 7-18cm | | 0014220000 | stuk | 46,00 | 016 | 0 | |
| closetzitting dubbel | | | | | | | | |
| 0294241 | | wit | 0065610000 | stuk | 159,00 | 015 | 1 | |
| 0293711 | | pergamon | 0065614700 | stuk | 159,00 | 015 | 1 | |
| 0294268 | | greenwich | 0065615200 | stuk | 159,00 | 015 | 1 | |
| duoblokpot diepspoel universeel z. reservoir | | | | | | | | |
| 0294063 | | wit | 0225090000 | stuk | 590,00 | 015 | 1 | |
| 0294071 | | pergamon | 0225094700 | stuk | 590,00 | 015 | 1 | |
| 0294098 | | greenwich | 0225095200 | stuk | 590,00 | 015 | 1 | |
| 0307971 | m. WG | wit | 02250900001 | stuk | 639,00 | 015 | 1 | |
| 0307998 | m. WG | pergamon | 02250947001 | stuk | 639,00 | 015 | 1 | |
| duoblokreservoir + binnenwerk | | | | | | | | |
| 0294101 | | wit | 0872500001 | stuk | 570,00 | 015 | 1 | |
| 0294136 | | pergamon | 0872504701 | stuk | 570,00 | 015 | 1 | |
| 0294233 | | greenwich | 0872505201 | stuk | 570,00 | 015 | 1 | |
| wandurinoir voor deksel achterinlaat | | | | | | | |  |
| 0294357 | | wit | 0836300000 | stuk | 434,00 | 015 | 1 | |
| 0294365 | | pergamon | 0836304700 | stuk | 434,00 | 015 | 1 | |
| 0294381 | | greenwich | 0836305200 | stuk | 434,00 | 015 | 1 | |
| 0307165 | m. WG | wit | 08363000001 | stuk | 483,00 | 015 | 1 | |
| 0307173 | m. WG | pergamon | 08363047001 | stuk | 483,00 | 015 | 1 | |
| 0293253 | urinoirsifon horizontaal | | 0050120000 | stuk | 25,50 | 017 | 0 | |
| deksel voor wandurinoir | | | | | | | | |
| 0294403 | | wit | 0065510000 | stuk | 129,00 | 015 | 1 | |
| 0292222 | | pergamon | 0065514700 | stuk | 129,00 | 015 | 1 | |
| 0294411 | | greenwich | 0065515200 | stuk | 129,00 | 015 | 1 | |

Sanitair producten

Baden /
douchebakken /
stoomcabines

Kranen

Douchegarnituur

Accessoires en
spiegels

Douchewanden

Toebehoren &
afvoerenSpoel- &
installatiesystemenBadkamermeubelen
en toiletkastenGootstenen en
wastroggen

Utiliteit

| Art.nr | Specificaties | Kleur | Lev.nr | Ehd | Prijs | Grp | CC |
|--------|---------------|-------|--------|-----|-------|-----|----|
|--------|---------------|-------|--------|-----|-------|-----|----|

Duravit Caro

spiegel



| | | | | | | | |
|---------|---------|--------------|----------|------|--------|-----|---|
| 0308811 | 55x81cm | ahorn/lagune | 97800391 | stuk | 341,00 | 304 | 1 |
| 0308927 | 55x81cm | ahorn/cocos | 97800392 | stuk | 341,00 | 304 | 1 |
| 0308870 | 55x81cm | wit/lagune | 97803491 | stuk | 341,00 | 304 | 1 |
| 0308986 | 55x81cm | wit/cocos | 97803492 | stuk | 341,00 | 304 | 1 |

Sanitair producten

Baden /
douchebakken /
stoomcabines

spiegel m. verlichting



| | | | | | | | |
|---------|---------|--------------|----------|------|--------|-----|---|
| 0308838 | 55x81cm | ahorn/lagune | 97810391 | stuk | 822,00 | 304 | 1 |
| 0308935 | 55x81cm | ahorn/cocos | 97810392 | stuk | 822,00 | 304 | 1 |
| 0308889 | 55x81cm | wit/lagune | 97813491 | stuk | 822,00 | 304 | 1 |
| 0308994 | 55x81cm | wit/cocos | 97813492 | stuk | 822,00 | 304 | 1 |

Kranen

Douchegarnituur

spiegelkast m. verlichting



| | | | | | | | |
|---------|---------|--------------|----------|------|---------|-----|---|
| 0308846 | 55x81cm | ahorn/lagune | 97820391 | stuk | 1283,00 | 304 | 1 |
| 0308943 | 55x81cm | ahorn/cocos | 97820392 | stuk | 1283,00 | 304 | 1 |
| 0308897 | 55x81cm | wit/lagune | 97823491 | stuk | 1283,00 | 304 | 1 |
| 0309001 | 55x81cm | wit/cocos | 97823492 | stuk | 1283,00 | 304 | 1 |

Accessoires en
spiegels

Douchewanden

spiegelkast



| | | | | | | | |
|---------|------------|--------------|----------|------|---------|-----|---|
| 0308854 | 80x81x16.5 | ahorn/lagune | 97830391 | stuk | 1764,00 | 304 | 1 |
| 0308951 | 80x81x16.5 | ahorn/cocos | 97830392 | stuk | 1764,00 | 304 | 1 |
| 0308900 | 80x81x16.5 | wit/lagune | 97833491 | stuk | 1764,00 | 304 | 1 |
| 0309028 | 80x81x16.5 | wit/cocos | 97833492 | stuk | 1764,00 | 304 | 1 |
| 0308862 | 110x81cm | ahorn/lagune | 97840391 | stuk | 1942,00 | 304 | 1 |
| 0308978 | 110x81cm | ahorn/cocos | 97840392 | stuk | 1942,00 | 304 | 1 |
| 0308919 | 110x81cm | wit/lagune | 97843491 | stuk | 1942,00 | 304 | 1 |
| 0309036 | 110x81cm | wit/cocos | 97843492 | stuk | 1942,00 | 304 | 1 |

Toebehoren &
afvoeren

Spoel- &
installatiesystemen



Badkamermeubelen
en toiletkasten

hoge kast 40x176cm links m. glasdeur



| | | | | | | | |
|---------|--|-----------------|-----------|------|---------|-----|---|
| 0294551 | | ahorn/cocos | 9121L0392 | stuk | 1315,00 | 304 | 1 |
| 0294527 | | ahorn/lagune | 9121L0391 | stuk | 1107,00 | 304 | 1 |
| 0294608 | | ahorn-li/cocos | 9121L3492 | stuk | 1315,00 | 304 | 1 |
| 0294594 | | ahorn-li/lagune | 9121L3491 | stuk | 1107,00 | 304 | 1 |

Gootstenen en
wastroggen

Utiliteit

hoge kast 40x176cm links m. glasdeur m. verlichting



| | | | | | | | |
|---------|--|----------------|-----------|------|---------|-----|---|
| 0294675 | | ahorn-li/cocos | 9120L3492 | stuk | 1514,00 | 304 | 1 |
|---------|--|----------------|-----------|------|---------|-----|---|

| Art.nr | Specificaties | Kleur | Lev.nr | Ehd | Prijs | Grp | CC |
|---------------------------|---------------|--------------|-----------|------|---------|-----|----|
| Duravit Caro | | | | | | | |
| kolomkast 40x176cm | | | | | | | |
| 0305421 | links | ahorn/lagune | 9116L0391 | stuk | 1437,00 | 304 | 1 |
| 0305448 | links | ahorn/cocos | 9116L0392 | stuk | 1698,00 | 304 | 1 |
| 0305456 | rechts | ahorn/lagune | 9116R0391 | stuk | 1437,00 | 304 | 1 |
| 0305464 | rechts | ahorn/cocos | 9116R0392 | stuk | 1698,00 | 304 | 1 |
| 0305472 | links | ahorn/lagune | 9117L0391 | stuk | 1437,00 | 304 | 1 |
| 0305480 | links | ahorn/cocos | 9117L0392 | stuk | 1672,00 | 304 | 1 |
| 0305499 | rechts | ahorn/lagune | 9117R0391 | stuk | 1437,00 | 304 | 1 |
| 0305502 | rechts | ahorn/cocos | 9117R0392 | stuk | 1672,00 | 304 | 1 |
| 0305510 | links | ahorn/lagune | 9118L0391 | stuk | 1310,00 | 304 | 1 |
| 0305529 | links | ahorn/cocos | 9118L0392 | stuk | 1563,00 | 304 | 1 |
| 0305537 | rechts | ahorn/lagune | 9118R0391 | stuk | 1310,00 | 304 | 1 |
| 0305545 | rechts | ahorn/cocos | 9118R0392 | stuk | 1563,00 | 304 | 1 |
| 0305553 | links | ahorn/lagune | 9119L0391 | stuk | 1413,00 | 304 | 1 |
| 0305561 | links | ahorn/cocos | 9119L0392 | stuk | 1651,00 | 304 | 1 |
| 0305588 | rechts | ahorn/lagune | 9119R0391 | stuk | 1413,00 | 304 | 1 |
| 0305596 | rechts | ahorn/cocos | 9119R0392 | stuk | 1651,00 | 304 | 1 |

**hoge kast m. verlichting**

| | | | | | | | |
|---------|--------|----------------|-----------|------|---------|-----|---|
| 0305618 | rechts | ahorn/lagune | 9120R0391 | stuk | 1302,00 | 304 | 1 |
| 0305626 | rechts | ahorn/cocos | 9120R0392 | stuk | 1514,00 | 304 | 1 |
| 0305634 | rechts | esdoorn/lagune | 9120R3491 | stuk | 1302,00 | 304 | 1 |
| 0305642 | rechts | esdoorn/cocos | 9120R3492 | stuk | 1514,00 | 304 | 1 |

**meubelvoet keramiek per stuk**

| | | | | | | | |
|---------|--|-----------|--------|------|-------|-----|---|
| 0294810 | | wit | 993500 | stuk | 43,00 | 304 | 1 |
| 0294829 | | pergamon | 993547 | stuk | 43,00 | 304 | 1 |
| 0294837 | | greenwich | 993552 | stuk | 43,00 | 304 | 1 |



| | | | | | | | |
|------------------------|---------------------------|-----------|-------------|------|--------|-----|---|
| Duravit Darling | | | | | | | |
| wastafel | | | | | | | |
| 0301337 | 55x48cm | wit | 0400550000 | stuk | 143,00 | 016 | 1 |
| 0301361 | 55x48cm | pergamon | 0400554700 | stuk | 179,00 | 016 | 1 |
| 0301345 | 55x48cm | manhattan | 0400551100 | stuk | 179,00 | 016 | 1 |
| 0290314 | 55x48cm | m. WG | 0400550001 | stuk | 192,00 | 016 | 1 |
| 0295498 | 55x48cm | m. WG | 04005547001 | stuk | 228,00 | 016 | 1 |
| 0301264 | 60x52cm | wit | 0400600000 | stuk | 159,00 | 016 | 0 |
| 0301299 | 60x52cm | pergamon | 0400604700 | stuk | 200,00 | 016 | 0 |
| 0301272 | 60x52cm | manhattan | 0400601100 | stuk | 200,00 | 016 | 1 |
| 0295492 | 60x52cm | m. WG | 0400600001 | stuk | 208,00 | 016 | 1 |
| 0295494 | 60x52cm | m. WG | 04006047001 | stuk | 249,00 | 016 | 1 |
| 0301183 | 65x54.5cm | wit | 0400650000 | stuk | 196,00 | 016 | 1 |
| 0301213 | 65x54.5cm | pergamon | 0400654700 | stuk | 246,00 | 016 | 1 |
| 0301191 | 65x54.5cm | manhattan | 0400651100 | stuk | 246,00 | 016 | 1 |
| 0295488 | 65x54.5cm | m. WG | 0400650001 | stuk | 245,00 | 016 | 1 |
| 0295490 | 65x54.5cm | m. WG | 04006547001 | stuk | 295,00 | 016 | 1 |
| 0307882 | 70x57cm | pergamon | 0400704700 | stuk | 322,00 | 016 | 1 |
| 0295484 | 70x57cm | m. WG | 0400700001 | stuk | 318,00 | 016 | 1 |
| 0295486 | 70x57cm | m. WG | 04007047001 | stuk | 371,00 | 016 | 1 |
| 0830097 | bevestigingsset M10x110mm | | 0830097 | paar | 1,09 | 362 | 0 |



Sanitair producten

Baden /
douchebakken /
stoomcabines

Kranen

Douchegarnituur











Accessoires en
spiegels

Douchewanden

Toebehoren &
afvoerenSpoel- &
installatiesystemenBadkamermeubelen
en toiletkastenGootstenen en
wastroggen

Utiliteit

| Art.nr | Specificaties | Kleur | Lev.nr | Ehd | Prijs | Grp | CC |
|--------------------------------------|-----------------------------------|-----------|-------------|------|---------|-----|----|
| Duravit Darling | | | | | | | |
| zuil voor wastafel | | | | | | | |
| 0302112 | | wit | 0863400000 | stuk | 109,00 | 016 | 1 |
| 0302147 | | pergamon | 0863404700 | stuk | 133,00 | 016 | 1 |
| 0302120 | | manhattan | 0863401100 | stuk | 133,00 | 016 | 1 |
| sifonkap voor wastafel | | | | | | | |
| 0302503 | | wit | 0863450000 | stuk | 100,00 | 016 | 0 |
| 0302546 | | pergamon | 0863454700 | stuk | 124,00 | 016 | 0 |
| 0302511 | | manhattan | 0863451100 | stuk | 124,00 | 016 | 1 |
| 0290963 | snelbevestigingsset voor sifonkap | | 0055030000 | stuk | 25,00 | 016 | 0 |
| inbouw wastafel opbouw | | | | | | | |
| 0290811 | 56x48cm | wit | 0464560000 | stuk | 184,00 | 016 | 1 |
| 0308471 | 56x48cm | pergamon | 0464564700 | stuk | 220,00 | 016 | 1 |
| 0295564 | 56x48cm m. WG | wit | 04645600001 | stuk | 233,00 | 016 | 1 |
| 0295568 | 56x48cm m. WG | pergamon | 04645647001 | stuk | 269,00 | 016 | 1 |
| halfinbouw wastafel | | | | | | | |
| 0315664 | 65x49.5cm | wit | 0464650000 | stuk | 201,00 | 016 | 1 |
| 0315672 | 65x49.5cm | pergamon | 0464654700 | stuk | 238,00 | 016 | 1 |
| meubel wastafel halfinbouw | | | | | | | |
| 0301957 | 61.5x54.5x21 | wit | 0401610000 | stuk | 304,00 | 016 | 1 |
| 0301981 | 61.5x54.5x21 | pergamon | 0401614700 | stuk | 364,00 | 016 | 1 |
| 0301965 | 61.5x54.5x21 | manhattan | 0401611100 | stuk | 364,00 | 016 | 1 |
| 0295578 | 61.5x54.5x21 m. WG | wit | 04016100001 | stuk | 353,00 | 016 | 1 |
| 0295580 | 61.5x54.5x21 m. WG | pergamon | 04016147001 | stuk | 413,00 | 016 | 1 |
| 0830097 | bevestigingsset M10x110mm | | 0830097 | paar | 1,09 | 362 | 0 |
| meubel wastafel | | | | | | | |
| 0299713 | 81.5x54.5cm | wit | 0401810000 | stuk | 473,00 | 016 | 1 |
| 0299714 | 81.5x54.5cm | pergamon | 0401814700 | stuk | 567,00 | 016 | 1 |
| 0295584 | 81.5x54.5cm m. WG | wit | 04018100001 | stuk | 522,00 | 016 | 1 |
| 0295586 | 81.5x54.5cm m. WG | pergamon | 04018147001 | stuk | 616,00 | 016 | 1 |
| 0299717 | 101.5x54.5cm | wit | 0401100000 | stuk | 626,00 | 016 | 1 |
| 0299718 | 101.5x54.5cm | pergamon | 0401104700 | stuk | 751,00 | 016 | 1 |
| 0295588 | 101.5x54.5cm m. WG | wit | 04011000001 | stuk | 675,00 | 016 | 1 |
| 0295592 | 101.5x54.5cm m. WG | pergamon | 04011047001 | stuk | 800,00 | 016 | 1 |
| 0315869 | 141,5x55cm | wit | 0401140000 | stuk | 892,00 | 016 | 1 |
| 0315885 | 141,5x55cm | pergamon | 0401144700 | stuk | 1072,00 | 016 | 1 |
| 0315850 | 141,5x55cm m. WG | wit | 04011400001 | stuk | 941,00 | 016 | 1 |
| 0315877 | 141,5x55cm m. WG | pergamon | 04011447001 | stuk | 1121,00 | 016 | 1 |
| 0299721 | 201.5x54.5cm | wit | 0401200000 | stuk | 1016,00 | 016 | 1 |
| 0299722 | 201.5x54.5cm | pergamon | 0401204700 | stuk | 1212,00 | 016 | 1 |
| 0295594 | 201.5x54,5cm m. WG | wit | 04012000001 | stuk | 1065,00 | 016 | 1 |
| 0295596 | 201,5x54,5cm m. WG | pergamon | 04012047001 | stuk | 1261,00 | 016 | 1 |
| 0830097 | bevestigingsset M10x110mm | | 0830097 | paar | 1,09 | 362 | 0 |
| meubel wastafel dubbel | | | | | | | |
| 0299896 | 124x55cm | pergamon | 0401124700 | stuk | 364,00 | 016 | 1 |
| 0295576 | 124x55cm m. WG | pergamon | 04011247001 | stuk | 413,00 | 016 | 1 |
| 0830097 | bevestigingsset M10x110mm | | 0830097 | paar | 1,09 | 362 | 0 |
| sifonkap voor meubel wastafel | | | | | | | |
| 0299725 | | wit | 0863460000 | stuk | 224,00 | 016 | 1 |
| 0299726 | | pergamon | 0863464700 | stuk | 267,00 | 016 | 1 |
| 0830453 | set potschroeven 5.5x60mm chroom | | 0830453 | stuk | 2,28 | 362 | 0 |

| Art.nr | Specificaties | Kleur | Lev.nr | Ehd | Prijs | Grp | CC | | | |
|--------------------------------------|-----------------------------------|-----------|--------------|-------------|--------|--------|-----|---|----------------------------------|---|
| | | | | | | | | Duravit Darling | | |
| planchet keramisch | | | | | | | | | | |
| 0301809 | 50x14.5cm | wit | 0904500000 | stuk | 56,00 | 016 | 1 |  | Sanitair producten | |
| 0301833 | 50x14.5cm | pergamon | 0904504700 | stuk | 66,00 | 016 | 1 | | | |
| 0301817 | 50x14.5cm | manhattan | 0904501100 | stuk | 66,00 | 016 | 1 | | | |
| 0301884 | 60x14.5cm | wit | 0904600000 | stuk | 64,00 | 016 | 1 | | | |
| 0301914 | 60x14.5cm | pergamon | 0904604700 | stuk | 76,00 | 016 | 1 | | | |
| 0301892 | 60x14.5cm | manhattan | 0904601100 | stuk | 76,00 | 016 | 1 | | | |
| 0830453 | set potschroeven 5.5x60mm | chroom | 0830453 | stuk | 2,28 | 362 | 0 | | | |
| fontein | | | | | | | | | | |
| 0301493 | 47x35cm | wit | 0763470000 | stuk | 96,00 | 016 | 1 |  | Kranen | |
| 0301523 | 47x35cm | pergamon | 0763474700 | stuk | 120,00 | 016 | 1 | | | |
| 0301507 | 47x35cm | manhattan | 0763471100 | stuk | 120,00 | 016 | 1 | | | |
| 0295552 | 47x35cm | m. WG | wit | 07634700001 | stuk | 145,00 | 016 | | | 1 |
| 0295554 | 47x35cm | m. WG | pergamon | 07634747001 | stuk | 169,00 | 016 | | | 1 |
| 0830240 | bevestigingsset voor fontein | M8x90mm | 0830240 | stuk | 0,85 | 362 | 0 | | | |
| sifonkap voor fontein | | | | | | | | | | |
| 0302589 | | wit | 0863420000 | stuk | 90,00 | 016 | 1 |  | Accessoires en spiegels | |
| 0302619 | | pergamon | 0863424700 | stuk | 112,00 | 016 | 1 | | | |
| 0302597 | | manhattan | 0863421100 | stuk | 112,00 | 016 | 1 | | | |
| 0290963 | snelbevestigingsset voor sifonkap | | 0055030000 | stuk | 25,00 | 016 | 0 | | | |
| staand bidet | | | | | | | | | | |
| 0301647 | | wit | 0265100000 | stuk | 240,00 | 016 | 1 |  | Douchewanden | |
| 0301671 | | pergamon | 0265104700 | stuk | 300,00 | 016 | 1 | | | |
| 0301655 | | manhattan | 0265101100 | stuk | 300,00 | 016 | 1 | | | |
| 0295520 | | m. WG | wit | 02651000001 | stuk | 289,00 | 016 | | | 1 |
| 0295522 | | m. WG | pergamon | 02651047001 | stuk | 349,00 | 016 | | | 1 |
| 0830453 | set potschroeven 5.5x60mm | chroom | 0830453 | stuk | 2,28 | 362 | 0 | | | |
| wandbidet | | | | | | | | | | |
| 0301736 | | wit | 0265150000 | stuk | 226,00 | 016 | 1 |  | Spoeel- & installatiesystemen | |
| 0301760 | | pergamon | 0265154700 | stuk | 266,00 | 016 | 1 | | | |
| 0301744 | | manhattan | 0265151100 | stuk | 266,00 | 016 | 1 | | | |
| 0295516 | | m. WG | wit | 02651500001 | stuk | 275,00 | 016 | | | 1 |
| 0295518 | | m. WG | pergamon | 02651547001 | stuk | 315,00 | 016 | | | 1 |
| wandclosetpot diepspoel | | | | | | | | | | |
| 0302953 | | wit | 0207090000 | stuk | 248,00 | 016 | 0 |  | Badkamermeubelen en toiletkasten | |
| 0302996 | | pergamon | 0207094700 | stuk | 309,00 | 016 | 0 | | | |
| 0302961 | | manhattan | 0207091100 | stuk | 309,00 | 016 | 1 | | | |
| 0295528 | | m. WG | wit | 02070900001 | stuk | 297,00 | 016 | | | 0 |
| 0295530 | | m. WG | pergamon | 02070947001 | stuk | 358,00 | 016 | | | 1 |
| wandclosetpot vlakspoel | | | | | | | | | | |
| 0301648 | | wit | 0213090000 | stuk | 276,00 | 016 | 1 |  | Utiliteit | |
| 0301649 | | pergamon | 0213094700 | stuk | 345,00 | 016 | 1 | | | |
| 0295524 | | m. WG | wit | 02130900001 | stuk | 325,00 | 016 | | | 1 |
| 0295526 | | m. WG | pergamon | 02130947001 | stuk | 394,00 | 016 | | | 1 |
| closetcombinatie diepspoel AO | | | | | | | | | | |
| 0302805 | | wit | DARLING | stuk | 443,00 | 016 | 1 |  | | |
| 0302848 | | pergamon | DARLING | stuk | 535,00 | 016 | 1 | | | |
| 0302813 | | manhattan | DARLING | stuk | 535,00 | 016 | 1 | | | |
| 0295544 | | m. WG | wit | DARLING | stuk | 541,00 | 016 | | | 1 |
| 0295546 | | m. WG | pergamon | DARLING | stuk | 633,00 | 016 | | | 1 |
| 0830453 | set potschroeven 5.5x60mm | chroom | 0830453 | stuk | 2,28 | 362 | 0 | | | |
| closetcombinatie diepspoel PK | | | | | | | | | | |
| 0302880 | | wit | DARLING | stuk | 443,00 | 016 | 1 |  | | |
| 0302910 | | pergamon | DARLING | stuk | 535,00 | 016 | 1 | | | |
| 0302899 | | manhattan | DARLING | stuk | 535,00 | 016 | 1 | | | |
| 0295548 | | m. WG | wit | DARLING | stuk | 541,00 | 016 | | | 1 |
| 0295550 | | m. WG | pergamon | DARLING | stuk | 633,00 | 016 | | | 1 |
| 0830453 | set potschroeven 5.5x60mm | chroom | 0830453 | stuk | 2,28 | 362 | 0 | | | |
| closetzitting dubbel | | | | | | | | | | |
| 0297380 | Darling/Duraplus/Architec | wit | B4C101E0102Y | stuk | 38,75 | 016 | 0 |  | | |
| 0297399 | Darling/Duraplus/Architec | pergamon | B4C204E0102Y | stuk | 43,75 | 016 | 0 | | | |
| 0297402 | Darling/Duraplus/Architec | manhattan | 0064201100 | stuk | 141,00 | 016 | 1 | | | |

| Art.nr | Specificaties | Kleur | Lev.nr | Ehd | Prijs | Grp | CC |
|--------|---------------|-------|--------|-----|-------|-----|----|
|--------|---------------|-------|--------|-----|-------|-----|----|

Duravit Darling

duoblokpot diepspoel AO z. reservoir

| | | | | | | | |
|---------|-------|-----------|-------------|------|--------|-----|---|
| 0303046 | | wit | 0232010000 | stuk | 263,00 | 016 | 1 |
| 0303070 | | pergamon | 0232014700 | stuk | 328,00 | 016 | 1 |
| 0303054 | | manhattan | 0232011100 | stuk | 328,00 | 016 | 1 |
| 0295532 | m. WG | wit | 02320100001 | stuk | 312,00 | 016 | 1 |
| 0295534 | m. WG | pergamon | 02320147001 | stuk | 377,00 | 016 | 1 |



duoblokpot diepspoel PK z. reservoir

| | | | | | | | |
|---------|-------|-----------|-------------|------|--------|-----|---|
| 0303119 | | wit | 0232090000 | stuk | 263,00 | 016 | 1 |
| 0303143 | | pergamon | 0232094700 | stuk | 328,00 | 016 | 1 |
| 0303127 | | manhattan | 0232091100 | stuk | 328,00 | 016 | 1 |
| 0295536 | m. WG | wit | 02320900001 | stuk | 312,00 | 016 | 1 |
| 0295538 | m. WG | pergamon | 02320947001 | stuk | 377,00 | 016 | 1 |

duoblokreervoir + binnenwerk

| | | | | | | | |
|---------|--|-----------|------------|------|--------|-----|---|
| 0303194 | | wit | 8726000001 | stuk | 180,00 | 016 | 1 |
| 0303224 | | pergamon | 8726004701 | stuk | 207,00 | 016 | 1 |
| 0303208 | | manhattan | 8726001101 | stuk | 207,00 | 016 | 1 |



duoblokpot diepspoel z. reservoir

| | | | | | | | |
|---------|-------|-----|------------|------|--------|-----|---|
| 0290007 | | wit | 138090000 | stuk | 200,00 | 016 | 1 |
| 0290018 | m. WG | wit | 1380900001 | stuk | 249,00 | 016 | 1 |

duoblokreervoir + binnenwerk aansluiting achter

| | | | | | | | |
|---------|--|-----|-----------|------|--------|-----|---|
| 0290019 | | wit | 922000001 | stuk | 130,00 | 016 | 1 |
|---------|--|-----|-----------|------|--------|-----|---|

closetzitting m. deksel

| | | | | | | | |
|---------|--|-----|----------|------|-------|-----|---|
| 0290023 | | wit | 63510000 | stuk | 78,00 | 016 | 1 |
|---------|--|-----|----------|------|-------|-----|---|

deksel voor wandurinoir

| | | | | | | | |
|---------|--|-----|------------|------|--------|-----|---|
| 0299678 | | wit | 0066410000 | stuk | 105,00 | 016 | 1 |
|---------|--|-----|------------|------|--------|-----|---|



Duravit Dellarco

wastafel

| | | | | | | | |
|---------|---------------------------|-----------|-------------|------|--------|-----|---|
| 0296988 | 60x50cm | wit | 0412600000 | stuk | 241,00 | 016 | 1 |
| 0296981 | 60x50cm | pergamon | 0412604700 | stuk | 241,00 | 016 | 1 |
| 0307181 | 60x50cm | m. WG | 04126000001 | stuk | 290,00 | 016 | 1 |
| 0307203 | 60x50cm | m. WG | 04126047001 | stuk | 290,00 | 016 | 1 |
| 0293601 | 65x53cm | wit | 0412650000 | stuk | 281,00 | 016 | 1 |
| 0296422 | 65x53cm | pergamon | 0412654700 | stuk | 281,00 | 016 | 1 |
| 0294845 | 65x53cm | manhattan | 0412651100 | stuk | 281,00 | 016 | 1 |
| 0307211 | 65x53cm | m. WG | 04126500001 | stuk | 330,00 | 016 | 1 |
| 0307238 | 65x53cm | m. WG | 04126547001 | stuk | 330,00 | 016 | 1 |
| 0830097 | bevestigingsset M10x110mm | | 0830097 | paar | 1,09 | 362 | 0 |



sifonkap voor wastafel









| | | | | | | | |
|---------|-----------------------------------|-----------|------------|------|--------|-----|---|
| 0293628 | | wit | 0857750000 | stuk | 164,00 | 016 | 1 |
| 0296465 | | pergamon | 0857754700 | stuk | 164,00 | 016 | 1 |
| 0294888 | | manhattan | 0857751100 | stuk | 164,00 | 016 | 1 |
| 0290963 | snelbevestigingsset voor sifonkap | | 0055030000 | stuk | 25,00 | 016 | 0 |









zuil voor wastafel

| | | | | | | | |
|---------|--|-----------|------------|------|--------|-----|---|
| 0293636 | | wit | 0857700000 | stuk | 193,00 | 016 | 1 |
| 0296481 | | pergamon | 0857704700 | stuk | 193,00 | 016 | 1 |
| 0294926 | | manhattan | 0857701100 | stuk | 193,00 | 016 | 1 |



| Art.nr | Specificaties | Kleur | Lev.nr | Ehd | Prijs | Grp | CC | | | | |
|-----------------------------------|--------------------------------------|-----------|------------|-------------|---------|---------|-----|---|---|----------------------------|---|
| | | | | | | | | Duravit Dellarco | | | |
| dubbele wastafel | | | | | | | | | | | |
| 0294950 | 120x57cm | wit | 0479120000 | stuk | 1209,00 | 016 | 1 |  | Sanitair producten | | |
| 0296430 | 120x57cm | pergamon | 0479124700 | stuk | 1209,00 | 016 | 1 | | | | |
| 0294969 | 120x57cm | manhattan | 0479121100 | stuk | 1209,00 | 016 | 1 | | | | |
| 0307246 | 120x57cm | m. WG | wit | 04791200001 | stuk | 1258,00 | 016 | | | 1 | |
| 0307254 | 120x57cm | m. WG | pergamon | 04791247001 | stuk | 1258,00 | 016 | | | 1 | |
| 0830097 | bevestigingsset M10x110mm | | 0830097 | paar | 1,09 | 362 | 0 | | | | Baden / douchebakken / stoomcabines |
| zuil voor dubbele wastafel | | | | | | | | | | | |
| 0294993 | | wit | 0857800000 | stuk | 483,00 | 016 | 1 |  | Kranen | | |
| 0296473 | | pergamon | 0857804700 | stuk | 483,00 | 016 | 1 | | | | |
| 0295000 | | manhattan | 0857801100 | stuk | 483,00 | 016 | 1 | | | | |
| wastafel halfinbouw | | | | | | | | | | | |
| 0315931 | 60x51cm | | pergamon | 0459604700 | stuk | 458,00 | 016 | 1 |  | Douchegarnituur | |
| 0315966 | 60x51cm | m. WG | pergamon | 04596047001 | stuk | 507,00 | 016 | 1 | | | |
| opbouw inbouwwastafel | | | | | | | | | | | |
| 0315923 | 60cm | | pergamon | 0460604700 | stuk | 383,00 | 016 | 1 |  | Accessoires en spiegels | |
| 0315915 | 60cm | m. WG | pergamon | 04606047001 | stuk | 432,00 | 016 | 1 | | | |
| meubelwastafel | | | | | | | | | | | |
| 0294439 | 85x57cm | wit | 0460850000 | stuk | 693,00 | 017 | 1 |  | Toebehoren & afvoeren | | |
| 0316016 | 85x57cm | pergamon | 0460854700 | stuk | 693,00 | 016 | 1 | | | | |
| 0316032 | 85x57cm | m. WG | wit | 04608500001 | stuk | 742,00 | 016 | | | 1 | |
| 0316024 | 85x57cm | m. WG | pergamon | 04608547001 | stuk | 742,00 | 016 | | | 1 | |
| 0315974 | 105x57cm | | wit | 0460100000 | stuk | 786,00 | 016 | | | 1 | |
| 0315991 | 105x57cm | | pergamon | 0460104700 | stuk | 786,00 | 016 | | | 1 | |
| 0315982 | 105x57cm | m. WG | wit | 04601000001 | stuk | 835,00 | 016 | | | 1 | |
| 0316008 | 105x57cm | m. WG | pergamon | 04601047001 | stuk | 835,00 | 016 | | | 1 | |
| 0830097 | bevestigingsset M10x110mm | | 0830097 | paar | 1,09 | 362 | 0 | | | | Badkamermeubelen en toiletkasten |
| fontein | | | | | | | | | | | |
| 0293415 | 45x33cm | wit | 0777450000 | stuk | 148,00 | 016 | 1 |  | Gootstenen en wastroggen | | |
| 0296309 | 45x33cm | pergamon | 0777454700 | stuk | 148,00 | 016 | 1 | | | | |
| 0294306 | 45x33cm | manhattan | 0777451100 | stuk | 148,00 | 016 | 1 | | | | |
| 0307262 | 45x33cm | m. WG | wit | 07774500001 | stuk | 197,00 | 016 | | | 1 | |
| 0307270 | 45x33cm | m. WG | pergamon | 07774547001 | stuk | 197,00 | 016 | | | 1 | |
| 0830240 | bevestigingsset voor fontein M8x90mm | | 0830240 | stuk | 0,85 | 362 | 0 | | | | |
| sifonkap voor fontein | | | | | | | | | | | |
| 0293423 | | wit | 0857720000 | stuk | 138,00 | 016 | 1 |  | Utiliteit | | |
| 0296368 | | pergamon | 0857724700 | stuk | 138,00 | 016 | 1 | | | | |
| 0294330 | | manhattan | 0857721100 | stuk | 138,00 | 016 | 1 | | | | |
| 0290963 | snelbevestigingsset voor sifonkap | | 0055030000 | stuk | 25,00 | 016 | 0 | | | | |
| staand bidet | | | | | | | | | | | |
| 0297054 | | wit | 0269100000 | stuk | 311,00 | 016 | 1 |  | | | |
| 0299682 | | pergamon | 0269104700 | stuk | 311,00 | 016 | 1 | | | | |
| 0307289 | | m. WG | wit | 02691000001 | stuk | 311,00 | 016 | | | 1 | |
| 0307297 | | m. WG | pergamon | 02691047001 | stuk | 311,00 | 016 | | | 1 | |
| 0830453 | set potschroeven 5.5x60mm chroom | | 0830453 | stuk | 2,28 | 362 | 0 | | | | |
| wandbidet | | | | | | | | | | | |
| 0297038 | | wit | 0268100000 | stuk | 335,00 | 016 | 1 |  | | | |
| 0299683 | | pergamon | 0268104700 | stuk | 335,00 | 016 | 1 | | | | |
| 0307300 | | m. WG | wit | 02681000001 | stuk | 384,00 | 016 | | | 1 | |
| 0307319 | | m. WG | pergamon | 02681047001 | stuk | 384,00 | 016 | | | 1 | |

| Art.nr | Specificaties | Kleur | Lev.nr | Ehd | Prijs | Grp | CC | |
|---|---------------|----------------------------------|------------|-------------|--------|--------|-----|---|
| Duravit Dellarco | | | | | | | | |
| wandclosetpot diepspoel | | | | | | | | |
|  | 0293571 | wit | 0217090000 | stuk | 415,00 | 016 | 1 | |
| | 0296414 | pergamon | 0217094700 | stuk | 415,00 | 016 | 1 | |
| | 0294780 | manhattan | 0217091100 | stuk | 415,00 | 016 | 1 | |
| | 0307327 | m. WG | wit | 02170900001 | stuk | 464,00 | 016 | 1 |
| | 0307335 | m. WG | pergamon | 02170947001 | stuk | 464,00 | 016 | 1 |
| wandclosetpot vlakspoel | | | | | | | | |
|  | 0297070 | wit | 0215090000 | stuk | 427,00 | 016 | 1 | |
| | 0299685 | pergamon | 0215094700 | stuk | 427,00 | 016 | 1 | |
| | 0307343 | m. WG | wit | 02150900001 | stuk | 476,00 | 016 | 1 |
| | 0307351 | m. WG | pergamon | 02150947001 | stuk | 476,00 | 016 | 1 |
| closetcombinatie diepspoel AO | | | | | | | | |
|  | 0297615 | wit | DELLARCO | stuk | 722,00 | 016 | 1 | |
| | 0297623 | pergamon | DELLARCO | stuk | 722,00 | 016 | 1 | |
| | 0297631 | manhattan | DELLARCO | stuk | 722,00 | 016 | 1 | |
| | 0297658 | edelweiss | DELLARCO | stuk | 879,00 | 016 | 1 | |
| | 0308072 | m. WG | wit | DELLARCO | stuk | 771,00 | 016 | 1 |
| | 0308080 | m. WG | pergamon | DELLARCO | stuk | 771,00 | 016 | 1 |
| | 0830453 | set potschroeven 5.5x60mm chroom | 0830453 | stuk | 2,28 | 362 | 0 | |
| closetcombinatie diepspoel PK | | | | | | | | |
| | 0297674 | wit | DELLARCO | stuk | 722,00 | 016 | 1 | |
| | 0297682 | pergamon | DELLARCO | stuk | 722,00 | 016 | 1 | |
| | 0297690 | manhattan | DELLARCO | stuk | 722,00 | 016 | 1 | |
| | 0297704 | edelweiss | DELLARCO | stuk | 879,00 | 016 | 1 | |
| | 0308099 | m. WG | wit | DELLARCO | stuk | 771,00 | 016 | 1 |
| | 0308102 | m. WG | pergamon | DELLARCO | stuk | 771,00 | 016 | 1 |
| | 0830453 | set potschroeven 5.5x60mm chroom | 0830453 | stuk | 2,28 | 362 | 0 | |
| closetcombinatie diepspoel universeel | | | | | | | | |
|  | 0297720 | wit | DELLARCO | stuk | 756,00 | 016 | 1 | |
| | 0297739 | pergamon | DELLARCO | stuk | 756,00 | 016 | 1 | |
| | 0297747 | manhattan | DELLARCO | stuk | 756,00 | 016 | 1 | |
| | 0297755 | edelweiss | DELLARCO | stuk | 961,00 | 016 | 1 | |
| | 0830453 | set potschroeven 5.5x60mm chroom | 0830453 | stuk | 2,28 | 362 | 0 | |
| closetzitting dubbel | | | | | | | | |
|  | 0293539 | wit | 0064910000 | stuk | 158,00 | 016 | 1 | |
| | 0296392 | pergamon | 0064914700 | stuk | 158,00 | 016 | 1 | |
| | 0294632 | manhattan | 0064911100 | stuk | 158,00 | 016 | 1 | |
| duoblokpot diepspoel AO z. reservoir | | | | | | | | |
|  | 0293504 | wit | 0218010000 | stuk | 427,00 | 016 | 1 | |
| | 0296376 | pergamon | 0218014700 | stuk | 427,00 | 016 | 1 | |
| | 0294535 | manhattan | 0218011100 | stuk | 427,00 | 016 | 1 | |
| | 0308021 | m. WG | wit | 02180100001 | stuk | 476,00 | 016 | 1 |
| | 0308048 | m. WG | pergamon | 02180147001 | stuk | 476,00 | 016 | 1 |
| duoblokpot diepspoel PK z. reservoir | | | | | | | | |
| | 0293512 | wit | 0218090000 | stuk | 427,00 | 016 | 1 | |
| | 0296384 | pergamon | 0218094700 | stuk | 427,00 | 016 | 1 | |
| | 0294578 | manhattan | 0218091100 | stuk | 427,00 | 016 | 1 | |
| | 0308056 | m. WG | wit | 02180900001 | stuk | 476,00 | 016 | 1 |
| | 0308064 | m. WG | pergamon | 02180947001 | stuk | 476,00 | 016 | 1 |
| duoblokpot diepspoel universeel z. reservoir | | | | | | | | |
| | 0297097 | wit | 0219090000 | stuk | 461,00 | 016 | 1 | |
| | 0297771 | pergamon | 0219094700 | stuk | 461,00 | 016 | 1 | |
| | 0297798 | manhattan | 0219091100 | stuk | 461,00 | 016 | 1 | |
| duoblokreervoir + binnenwerk | | | | | | | | |
|  | 0293555 | wit | 0873000001 | stuk | 295,00 | 016 | 1 | |
| | 0296406 | pergamon | 0873004701 | stuk | 295,00 | 016 | 1 | |
| | 0294721 | manhattan | 0873001101 | stuk | 295,00 | 016 | 1 | |

| Art.nr | Specificaties | Kleur | Lev.nr | Ehd | Prijs | Grp | CC |
|--------|---------------|-------|--------|-----|-------|-----|----|
|--------|---------------|-------|--------|-----|-------|-----|----|

Duravit Dellarco

wandurinoir achterinlaat z. sifon

| | | | | | | | |
|---------|--|----------|-------------|------|--------|-----|---|
| 0297151 | | wit | 0856300000 | stuk | 417,00 | 016 | 1 |
| 0297177 | | pergamon | 0856304700 | stuk | 417,00 | 016 | 1 |
| 0307378 | m. WG | wit | 08563000001 | stuk | 466,00 | 016 | 1 |
| 0307386 | m. WG | pergamon | 08563047001 | stuk | 466,00 | 016 | 1 |
| 0293253 | urinoirsifon horizontaal | | 0050120000 | stuk | 25,50 | 017 | 0 |
| 0299853 | bevestigingsset v. bidet/urinoir/closet chroom | | 0067011000 | stuk | 5,00 | 017 | 0 |



Sanitair producten

Baden /
douchebakken /
stoomcabines**deksel voor wandurinoir**

| | | | | | | | |
|---------|--|----------|------------|------|--------|-----|---|
| 0297135 | | wit | 0065110000 | stuk | 117,00 | 016 | 1 |
| 0308269 | | pergamon | 0065114700 | stuk | 117,00 | 016 | 1 |



Kranen

Douchegarnituur

spiegel m. 2 halogeen spots

| | | | | | | | |
|---------|---------|--|--------|------|--------|-----|---|
| 0297186 | 93x50cm | | 775506 | stuk | 689,00 | 304 | 1 |
|---------|---------|--|--------|------|--------|-----|---|

Accessoires en
spiegels

Duravit Design Variations

Bagnella wastafel

| | | | | | | | |
|---------|---------------------------|-----|-------------|------|--------|-----|---|
| 0299582 | 49x57cm | wit | 0340490000 | stuk | 506,00 | 016 | 1 |
| 0306975 | 49x57cm m. WG | wit | 03404900001 | stuk | 555,00 | 016 | 1 |
| 0830097 | bevestigingsset M10x110mm | | 0830097 | paar | 1,09 | 362 | 0 |



Douchewanden

Toebehoren &
afvoeren**Bagnella Giulia zuil voor wastafel**

| | | | | | | | |
|---------|--|---------|------------|------|--------|-----|---|
| 0299585 | | wit/wit | 0863080000 | stuk | 363,00 | 016 | 1 |
|---------|--|---------|------------|------|--------|-----|---|

Spoel- &
installatiesystemenBadkamermeubelen
en toiletkasten**Bagnella Aldo zuil voor wastafel**

| | | | | | | | |
|---------|--|--------------|------------|------|--------|-----|---|
| 0299584 | | chroom/zwart | 0030010000 | stuk | 854,00 | 016 | 1 |
|---------|--|--------------|------------|------|--------|-----|---|

Gootstenen en
wastroggen

Utiliteit

Bagnella opbouw wastafel 40cm z. overloop

| | | | | | | | |
|---------|-------|-----|-------------|------|--------|-----|---|
| 0290060 | | wit | 45140000 | stuk | 235,00 | 016 | 1 |
| 0290064 | m. WG | wit | 04514000001 | stuk | 284,00 | 016 | 1 |

**Bagnella opbouw wastafel 48cm z. overloop**







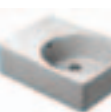

| | | | | | | | |
|---------|-------|-----|------------|------|--------|-----|---|
| 0290066 | | wit | 451480000 | stuk | 265,00 | 016 | 1 |
| 0290067 | m. WG | wit | 4514800001 | stuk | 314,00 | 016 | 1 |

**Scola wastafel bak links**

| | | | | | | | |
|---------|-----------------------------|-----|-------------|------|--------|-----|---|
| 0304115 | 61,5x46cm z. kraangat | wit | 0684600000 | stuk | 341,00 | 017 | 0 |
| 0304126 | 61,5x46cm z. kraangat m. WG | wit | 06846000001 | stuk | 390,00 | 017 | 1 |
| 0304514 | 61,5x46cm m. kraangat | wit | 0684600011 | stuk | 341,00 | 017 | 0 |
| 0307807 | 61,5x46cm m. kraangat m. WG | wit | 06846000111 | stuk | 390,00 | 017 | 0 |
| 0830097 | bevestigingsset M10x110mm | | 0830097 | paar | 1,09 | 362 | 0 |

**Scola wastafel bak rechts**

| | | | | | | | |
|---------|-----------------------------|-----|-------------|------|--------|-----|---|
| 0304123 | 61,5x46cm z. kraangat | wit | 0685600000 | stuk | 341,00 | 017 | 0 |
| 0304125 | 61,5x46cm z. kraangat m. WG | wit | 06856000001 | stuk | 390,00 | 017 | 1 |
| 0304522 | 61,5x46cm m. kraangat | wit | 0685600011 | stuk | 341,00 | 017 | 0 |
| 0307815 | 61,5x46cm m. kraangat m. WG | wit | 06856000111 | stuk | 390,00 | 017 | 1 |
| 0830097 | bevestigingsset M10x110mm | | 0830097 | paar | 1,09 | 362 | 0 |

| Art.nr | Specificaties | Kleur | Lev.nr | Ehd | Prijs | Grp | CC |
|---|---|-------|-------------|------|--------|-----|----|
| Duravit Design Variations | | | | | | | |
| Scola onderstel voor wastafel 068460/560 | | | | | | | |
| | 0307858 | chrom | 0030591000 | stuk | 297,00 | 016 | 1 |
| Sanitair producten |  | | | | | | |
| Baden / douchebakken / stoomcabines | | | | | | | |
| Vero wastafel m. achterwand | | | | | | | |
| | 0308374 60x46.5cm | wit | 0453600000 | stuk | 486,00 | 016 | 1 |
| | 0305324 60x46.5cm m. WG | wit | 0453600001 | stuk | 535,00 | 016 | 1 |
| Kranen |  | | | | | | |
| Douchegarnituur | | | | | | | |
| | 0290071 bevestigingshaak set à 2stuks | | 0050000000 | stuk | 7,00 | 017 | 0 |
| Vero meubelwastafel geslepen m. achterwand | | | | | | | |
| | 0290070 60cm | wit | 453600025 | stuk | 519,00 | 016 | 1 |
| | 0290075 60cm m. WG | wit | 4536000251 | stuk | 568,00 | 016 | 1 |
| Accessoires en spiegels |  | | | | | | |
| Douchewanden | | | | | | | |
| Vero wastafel | | | | | | | |
| | 0305328 50x47cm m. kraangat | wit | 0454500000 | stuk | 229,00 | 016 | 0 |
| | 0305329 50x47cm m. kraangat m. WG | wit | 0454500001 | stuk | 278,00 | 016 | 1 |
| | 0305330 50x47cm m. 3 kraangaten | wit | 0454500030 | stuk | 229,00 | 016 | 1 |
| | 0305331 50x47cm m. 3 kraangaten m. WG | wit | 04545000301 | stuk | 278,00 | 016 | 1 |
| | 0305333 50x47cm z. kraangat | wit | 0454500060 | stuk | 229,00 | 016 | 1 |
| | 0305334 50x47cm z. kraangat m. WG | wit | 04545000601 | stuk | 278,00 | 016 | 1 |
| Toebehoren & afvoeren |  | | | | | | |
| | 0830097 bevestigingsset M10x110mm | | 0830097 | paar | 1,09 | 362 | 0 |
| Vero meubelwastafel geslepen | | | | | | | |
| | 0290077 50cm m. kraangat | wit | 454500027 | stuk | 234,00 | 016 | 1 |
| | 0290078 50cm m. kraangat m. WG | wit | 4545000271 | stuk | 283,00 | 016 | 1 |
| | 0290079 50cm m. 3 kraangaten | wit | 454500025 | stuk | 234,00 | 016 | 1 |
| | 0290090 50cm m. 3 kraangaten m. WG | wit | 4545000251 | stuk | 283,00 | 016 | 1 |
| | 0290107 50cm z. kraangat | wit | 454500028 | stuk | 234,00 | 016 | 1 |
| | 0290108 50cm z. kraangat m. WG | wit | 4545000281 | stuk | 283,00 | 016 | 1 |
| Spoel- & installatiesystemen |  | | | | | | |
| | 0830097 bevestigingsset M10x110mm | | 0830097 | paar | 1,09 | 362 | 0 |
| Badkamermeubelen en toiletkasten | | | | | | | |
| Vero wastafel | | | | | | | |
| | 0308382 60x47cm m. kraangat | wit | 0454600000 | stuk | 304,00 | 016 | 0 |
| | 0305332 60x47cm m. kraangat m. WG | wit | 0454600001 | stuk | 353,00 | 016 | 0 |
| | 0305335 60x47cm m. 3 kraangaten | wit | 0454600030 | stuk | 304,00 | 016 | 1 |
| | 0293202 60x47cm m. 3 kraangaten m. WG | wit | 04546000301 | stuk | 353,00 | 016 | 1 |
| | 0305336 60x47cm z. kraangat | wit | 0454600060 | stuk | 304,00 | 016 | 1 |
| | 0305337 60x47cm z. kraangat m. WG | wit | 04546000601 | stuk | 353,00 | 016 | 0 |
| Gootstenen en wastroggen |  | | | | | | |
| | 0830097 bevestigingsset M10x110mm | | 0830097 | paar | 1,09 | 362 | 0 |
| Utiliteit | | | | | | | |
| Vero meubelwastafel geslepen | | | | | | | |
| | 0290091 60cm m. kraangat | wit | 454600027 | stuk | 309,00 | 016 | 1 |
| | 0290104 60cm m. kraangat m. WG | wit | 4546000271 | stuk | 358,00 | 016 | 1 |
| | 0290105 60cm m. 3 kraangaten | wit | 454600025 | stuk | 309,00 | 016 | 1 |
| | 0290106 60cm m. 3 kraangaten m. WG | wit | 4546000251 | stuk | 358,00 | 016 | 1 |
| | 0290109 60cm z. kraangat | wit | 454600028 | stuk | 309,00 | 016 | 1 |
| | 0290110 60cm z. kraangat m. WG | wit | 4546000281 | stuk | 358,00 | 016 | 1 |
| | 0830097 bevestigingsset M10x110mm | | 0830097 | paar | 1,09 | 362 | 0 |
| |  | | | | | | |
| Vero wastafel | | | | | | | |
| | 0305309 80x47cm m. kraangat | wit | 0454800000 | stuk | 349,00 | 016 | 0 |
| | 0305310 80x47cm m. kraangat m. WG | wit | 0454800001 | stuk | 398,00 | 016 | 1 |
| | 0305311 80x47cm m. 3 kraangaten | wit | 0454800030 | stuk | 349,00 | 016 | 1 |
| | 0305312 80x47cm m. 3 kraangaten m. WG | wit | 04548000301 | stuk | 398,00 | 016 | 1 |
| | 0305313 80x47cm z. kraangat | wit | 0454800060 | stuk | 349,00 | 016 | 1 |
| | 0305314 80x47cm z. kraangat m. WG | wit | 04548000601 | stuk | 398,00 | 016 | 1 |
| | 0830097 bevestigingsset M10x110mm | | 0830097 | paar | 1,09 | 362 | 0 |
| |  | | | | | | |

| Art.nr | Specificaties | Kleur | Lev.nr | Ehd | Prijs | Grp | CC |
|--------|---------------|-------|--------|-----|-------|-----|----|
|--------|---------------|-------|--------|-----|-------|-----|----|

Duravit Design Variations

Vero meubelwastafel geslepen

| | | | | | | | |
|---------|----------------------------|-----|------------|------|--------|-----|---|
| 0290112 | 80cm m. kraangat | wit | 454800027 | stuk | 354,00 | 016 | 1 |
| 0290113 | 80cm m. kraangat m. WG | wit | 4548000271 | stuk | 403,00 | 016 | 1 |
| 0290114 | 80cm m. 3 kraangaten | wit | 454800025 | stuk | 354,00 | 016 | 1 |
| 0290115 | 80cm m. 3 kraangaten m. WG | wit | 4548000251 | stuk | 403,00 | 016 | 1 |
| 0290122 | 80cm z. kraangat | wit | 454800028 | stuk | 354,00 | 016 | 1 |
| 0290123 | 80cm z. kraangat m. WG | wit | 4548000281 | stuk | 403,00 | 016 | 1 |
| 0830097 | bevestigingsset M10x110mm | | 0830097 | paar | 1,09 | 362 | 0 |



Sanitair producten

Baden /
douchebakken /
stoomcabines**Vero meubelwastafel**

| | | | | | | | |
|---------|-------------------------------|-----|------------|------|--------|-----|---|
| 0291349 | 85x49cm m. 1 kraangat | wit | 329850000 | stuk | 421,00 | 016 | 1 |
| 0291350 | 85x49cm m. 1 kraangat m. WG | wit | 3298500001 | stuk | 470,00 | 016 | 1 |
| 0291351 | 85x49cm m. 3 kraangaten | wit | 329850030 | stuk | 721,00 | 016 | 1 |
| 0291352 | 85x49cm m. 3 kraangaten m. WG | wit | 3298500301 | stuk | 471,00 | 016 | 1 |

Kranen

Vero wastafel

| | | | | | | | |
|---------|--------------------------------|-----|-------------|------|--------|-----|---|
| 0305315 | 100x47cm m. kraangat | wit | 0454100000 | stuk | 462,00 | 016 | 0 |
| 0305317 | 100x47cm m. kraangat m. WG | wit | 04541000001 | stuk | 511,00 | 016 | 1 |
| 0305318 | 100x47cm m. 2 kraangaten | wit | 0454100024 | stuk | 462,00 | 016 | 0 |
| 0305319 | 100x47cm m. 2 kraangaten m. WG | wit | 04541000241 | stuk | 511,00 | 016 | 0 |
| 0305320 | 100x47cm m. 3 kraangaten | wit | 0454100030 | stuk | 462,00 | 016 | 1 |
| 0305321 | 100x47cm m. 3 kraangaten m. WG | wit | 04541000301 | stuk | 511,00 | 016 | 1 |
| 0305322 | 100x47cm z. kraangat | wit | 0454100060 | stuk | 462,00 | 016 | 0 |
| 0305323 | 100x47cm z. kraangat m. WG | wit | 04541000601 | stuk | 511,00 | 016 | 1 |
| 0830097 | bevestigingsset M10x110mm | | 0830097 | paar | 1,09 | 362 | 0 |



Douchegarnituur

Accessoires en
spiegels**Vero meubelwastafel geslepen**

| | | | | | | | |
|---------|-----------------------------|-----|------------|------|--------|-----|---|
| 0290116 | 100cm m. kraangat | wit | 454100027 | stuk | 467,00 | 016 | 1 |
| 0290117 | 100cm m. kraangat m. WG | wit | 4541000271 | stuk | 516,00 | 016 | 1 |
| 0290118 | 100cm m. 2 kraangaten | wit | 454100026 | stuk | 462,00 | 016 | 0 |
| 0290119 | 100cm m. 2 kraangaten m. WG | wit | 4541000261 | stuk | 511,00 | 016 | 1 |
| 0290120 | 100cm m. 3 kraangaten | wit | 454100025 | stuk | 467,00 | 016 | 1 |
| 0290121 | 100cm m. 3 kraangaten m. WG | wit | 4541000251 | stuk | 516,00 | 016 | 1 |
| 0290124 | 100cm z. kraangat | wit | 454100028 | stuk | 467,00 | 016 | 1 |
| 0290125 | 100cm z. kraangat m. WG | wit | 4541000281 | stuk | 516,00 | 016 | 1 |
| 0830097 | bevestigingsset M10x110mm | | 0830097 | paar | 1,09 | 362 | 0 |



Douchewanden

Toebehoren &
afvoerenSpoel- &
installatiesystemen**Vero meubelwastafel**

| | | | | | | | |
|---------|--------------------------------|-----|------------|------|--------|-----|---|
| 0291353 | 105x49cm m. 1 kraangat | wit | 329100000 | stuk | 519,00 | 016 | 1 |
| 0291354 | 105x49cm m. 1 kraangat m. WG | wit | 3291000001 | stuk | 568,00 | 016 | 1 |
| 0291355 | 105x49cm m. 3 kraangaten | wit | 329100030 | stuk | 519,00 | 016 | 1 |
| 0291356 | 105x49cm m. 3 kraangaten m. WG | wit | 3291000301 | stuk | 569,00 | 016 | 1 |
| 0291357 | 125x49cm m. 1 kraangat | wit | 329120000 | stuk | 625,00 | 016 | 1 |
| 0291358 | 125x49cm m. 1 kraangat m. WG | wit | 3291200001 | stuk | 674,00 | 016 | 1 |
| 0291359 | 125x49cm m. 3 kraangaten | wit | 329120030 | stuk | 625,00 | 016 | 1 |
| 0291360 | 125x49cm m. 3 kraangaten m. WG | wit | 3291200301 | stuk | 675,00 | 016 | 1 |

Badkamermeubelen
en toiletkastenGootstenen en
wastroggen**Vero onderstel**

| | | | | | | | |
|---------|---------------------------|--------|------------|------|--------|-----|---|
| 0305359 | v. wastafel 045360/045460 | chroom | 0030631000 | stuk | 327,00 | 016 | 0 |
| 0305325 | v. wastafel 045450 | chroom | 0030651000 | stuk | 319,00 | 016 | 1 |
| 0305326 | v. wastafel 045480 | chroom | 0030661001 | stuk | 334,00 | 016 | 0 |
| 0305327 | v. wastafel 045410 | chroom | 0030671000 | stuk | 347,00 | 016 | 0 |

Utiliteit

Vero handdoekhouder voor wastafel 045460

| | | | | | | | |
|---------|--|--------|------------|------|--------|-----|---|
| 0296113 | | chroom | 0030371000 | stuk | 112,00 | 016 | 0 |
|---------|--|--------|------------|------|--------|-----|---|

Vero handdoekhouder voor wastafel 045480

| | | | | | | | |
|---------|--|--------|------------|------|--------|-----|---|
| 0296114 | | chroom | 0030381000 | stuk | 125,00 | 016 | 0 |
|---------|--|--------|------------|------|--------|-----|---|

Vero handdoekhouder voor wastafel 045410

| | | | | | | | |
|---------|--|--------|------------|------|--------|-----|---|
| 0296115 | | chroom | 0030391000 | stuk | 139,00 | 016 | 0 |
|---------|--|--------|------------|------|--------|-----|---|

Vero opbouw wastafel z. kraangat

| | | | | | | | |
|---------|---------------|-----|-------------|------|--------|-----|---|
| 0291341 | 50x38cm | wit | 455500000 | stuk | 175,00 | 016 | 1 |
| 0291342 | 50x38cm m. WG | wit | 4555000001 | stuk | 224,00 | 016 | 1 |
| 0308390 | 60x38cm | wit | 0455600000 | stuk | 208,00 | 016 | 0 |
| 0305340 | 60x38cm m. WG | wit | 04556000001 | stuk | 257,00 | 016 | 0 |

**Vero onderbouw wastafel z. kraanplateau**

| | | | | | | | |
|---------|---------------|-----|------------|------|--------|-----|---|
| 0291361 | 48x31cm | wit | 330480000 | stuk | 175,00 | 016 | 1 |
| 0291362 | 48x31cm m. WG | wit | 3304800001 | stuk | 224,00 | 016 | 1 |

| Art.nr | Specificaties | Kleur | Lev.nr | Ehd | Prijs | Grp | CC |
|--------|---------------|-------|--------|-----|-------|-----|----|
|--------|---------------|-------|--------|-----|-------|-----|----|

Duravit Design Variations

Vero fontein

| | | | | | | | |
|---------|---------|--|-----|------------|------|--------|-----|
| 0291343 | 50x25cm | m. voorgestoken kraangat links en rechts | wit | 703500000 | stuk | 175,00 | 016 |
| 0291344 | 50x25cm | m. voorgestoken kraangat links en rechts m. WG | wit | 703500000 | stuk | 224,00 | 016 |
| 0291345 | 25x45cm | m.1 kraangat | wit | 702250000 | stuk | 150,00 | 016 |
| 0291346 | 25x45cm | m.1 kraangat m. WG | wit | 702250000 | stuk | 199,00 | 016 |
| 0291347 | 45x35cm | m.1 kraangat | wit | 0704450000 | stuk | 165,00 | 016 |
| 0291348 | 45x35cm | m.1 kraangat m. WG | wit | 0704450000 | stuk | 214,00 | 016 |

Duravit Duraplus

wastafel

| | | | | | | | | |
|---------|---------------------------|-------|-----------|------------|------|--------|-----|---|
| 0301116 | 50x38.5cm | | wit | 0344500000 | stuk | 81,00 | 017 | 0 |
| 0301140 | 50x38.5cm | | pergamon | 0344504700 | stuk | 114,00 | 017 | 1 |
| 0301124 | 50x38.5cm | | manhattan | 0344501100 | stuk | 114,00 | 017 | 1 |
| 0307432 | 50x38.5cm | m. WG | wit | 0344500000 | stuk | 130,00 | 017 | 1 |
| 0307440 | 50x38.5cm | m. WG | pergamon | 0344504700 | stuk | 163,00 | 017 | 1 |
| 0301035 | 55x44cm | | wit | 0344500000 | stuk | 85,00 | 017 | 1 |
| 0301078 | 55x44cm | | pergamon | 0344554700 | stuk | 121,00 | 017 | 0 |
| 0301043 | 55x44cm | | manhattan | 0344551100 | stuk | 121,00 | 017 | 1 |
| 0307459 | 55x44cm | m. WG | wit | 0344550000 | stuk | 134,00 | 017 | 1 |
| 0307467 | 55x44cm | m. WG | pergamon | 0344554700 | stuk | 170,00 | 017 | 1 |
| 0300969 | 60x49cm | | wit | 0344600000 | stuk | 94,00 | 017 | 0 |
| 0300993 | 60x49cm | | pergamon | 0344604700 | stuk | 131,00 | 017 | 0 |
| 0300977 | 60x49cm | | manhattan | 0344601100 | stuk | 131,00 | 017 | 1 |
| 0307475 | 60x49cm | m. WG | wit | 0344600000 | stuk | 143,00 | 017 | 1 |
| 0307483 | 60x49cm | m. WG | pergamon | 0344604700 | stuk | 180,00 | 017 | 1 |
| 0300888 | 65x51cm | | wit | 0344650000 | stuk | 114,00 | 017 | 1 |
| 0300926 | 65x51cm | | pergamon | 0344654700 | stuk | 161,00 | 017 | 1 |
| 0300896 | 65x51cm | | manhattan | 0344651100 | stuk | 161,00 | 017 | 1 |
| 0307491 | 65x51cm | m. WG | wit | 0344650000 | stuk | 163,00 | 017 | 1 |
| 0307505 | 65x51cm | m. WG | pergamon | 0344654700 | stuk | 210,00 | 017 | 1 |
| 0830097 | bevestigingsset M10x110mm | | | 0830097 | paar | 1,09 | 362 | 0 |

sifonkap voor wastafel 65-60-55cm

| | | | | | | | | |
|---------|-----------------------------------|--|-----------|------------|------|--------|-----|---|
| 0302651 | | | wit | 0863350000 | stuk | 85,00 | 017 | 0 |
| 0302694 | | | pergamon | 0863354700 | stuk | 108,00 | 017 | 0 |
| 0302678 | | | manhattan | 0863351100 | stuk | 108,00 | 017 | 1 |
| 0290963 | snelbevestigingsset voor sifonkap | | | 0055030000 | stuk | 25,00 | 016 | 0 |

sifonkap voor fontein/wastafel 45-50cm

| | | | | | | | | |
|---------|-----------------------------------|--|-----------|------------|------|--------|-----|---|
| 0302732 | | | wit | 0863320000 | stuk | 76,00 | 017 | 1 |
| 0302767 | | | pergamon | 0863324700 | stuk | 106,00 | 017 | 1 |
| 0302740 | | | manhattan | 0863321100 | stuk | 106,00 | 017 | 1 |
| 0290963 | snelbevestigingsset voor sifonkap | | | 0055030000 | stuk | 25,00 | 016 | 0 |

zuil voor wastafel 65-60cm

| | | | | | | | | |
|---------|--|--|-----------|------------|------|-------|-----|---|
| 0302031 | | | wit | 0863300000 | stuk | 72,00 | 017 | 1 |
| 0302074 | | | pergamon | 0863304700 | stuk | 93,00 | 017 | 1 |
| 0302058 | | | manhattan | 0863301100 | stuk | 93,00 | 017 | 1 |

planchet

| | | | | | | | | |
|---------|---------------------------|-------|-----------|------------|------|-------|-----|---|
| 0302341 | 50x13.5cm | | wit | 0893500000 | stuk | 40,25 | 017 | 1 |
| 0302384 | 50x13.5cm | | pergamon | 0893504700 | stuk | 55,00 | 017 | 1 |
| 0302368 | 50x13.5cm | | manhattan | 0893501100 | stuk | 53,00 | 017 | 1 |
| 0302279 | 60x13.5cm | | wit | 0893600000 | stuk | 47,50 | 017 | 0 |
| 0302309 | 60x13.5cm | | pergamon | 0893604700 | stuk | 66,00 | 017 | 1 |
| 0302287 | 60x13.5cm | | manhattan | 0893601100 | stuk | 64,00 | 017 | 1 |
| 0302198 | 70x13.5cm | | wit | 0893700000 | stuk | 58,00 | 017 | 1 |
| 0302236 | 70x13.5cm | | pergamon | 0893704700 | stuk | 77,00 | 017 | 1 |
| 0830453 | set potschroeven 5.5x60mm | chrom | | 0830453 | stuk | 2,28 | 362 | 0 |

fontein

| | | | | | | | | |
|---------|--------------------------------------|-------|----------|------------|------|--------|-----|---|
| 0301426 | 45x33.5cm | | wit | 0781450000 | stuk | 64,00 | 017 | 0 |
| 0301450 | 45x33.5cm | | pergamon | 0781454700 | stuk | 87,00 | 017 | 1 |
| 0307513 | 45x33.5cm | m. WG | wit | 0781450000 | stuk | 113,00 | 017 | 1 |
| 0307521 | 45x33.5cm | m. WG | pergamon | 0781454700 | stuk | 136,00 | 017 | 1 |
| 0830240 | bevestigingsset voor fontein M8x90mm | | | 0830240 | stuk | 0,85 | 362 | 0 |

| Art.nr | Specificaties | Kleur | Lev.nr | Ehd | Prijs | Grp | CC |
|---|---|-----------|--------------|------|--------|-----|----|
| Duravit Duraplus | | | | | | | |
| sifonkap voor fontein/wastafel 45-50cm | | | | | | | |
| 0302732 | | wit | 0863320000 | stuk | 76,00 | 017 | 1 |
| 0302767 | | pergamon | 0863324700 | stuk | 106,00 | 017 | 1 |
| 0302740 | | manhattan | 0863321100 | stuk | 106,00 | 017 | 1 |
| 0290963 | snelbevestigingsset voor sifonkap | | 0055030000 | stuk | 25,00 | 016 | 0 |
| staand bidet | | | | | | | |
| 0301574 | | wit | 0298100000 | stuk | 124,00 | 017 | 0 |
| 0301604 | | pergamon | 0298104700 | stuk | 173,00 | 017 | 1 |
| 0301582 | | manhattan | 0298101100 | stuk | 173,00 | 017 | 1 |
| 0307548 | m. WG | wit | 02981000001 | stuk | 173,00 | 017 | 1 |
| 0307556 | m. WG | pergamon | 02981047001 | stuk | 222,00 | 017 | 1 |
| 0830453 | set potschroeven 5.5x60mm chroom | | 0830453 | stuk | 2,28 | 362 | 0 |
| wandbidet | | | | | | | |
| 0310703 | | wit | 2532100000 | stuk | 185,00 | 017 | 1 |
| 0301705 | | pergamon | 2532104700 | stuk | 239,00 | 017 | 1 |
| 0307564 | m. WG | wit | 25321000001 | stuk | 234,00 | 017 | 1 |
| 0307572 | m. WG | pergamon | 25321047001 | stuk | 288,00 | 017 | 1 |
| wandclosetpot diepspoel | | | | | | | |
| 0294691 | | wit | 2547090000 | stuk | 189,00 | 017 | 0 |
| 0299849 | | pergamon | 2547094700 | stuk | 257,00 | 017 | 0 |
| 0294705 | | beige | 2547094100 | stuk | 257,00 | 017 | 1 |
| 0299847 | | manhattan | 2547091100 | stuk | 257,00 | 017 | 1 |
| 0307580 | m. WG | wit | 25470900001 | stuk | 138,00 | 017 | 1 |
| 0307599 | m. WG | pergamon | 25470947001 | stuk | 306,00 | 017 | 1 |
| wandclosetpot vlakspoel | | | | | | | |
| 0304093 | | wit | 0196090000 | stuk | 217,00 | 017 | 0 |
| 0304092 | | pergamon | 0196094700 | stuk | 294,00 | 017 | 1 |
| 0307602 | m. WG | wit | 01960900001 | stuk | 266,00 | 017 | 1 |
| 0316105 | m. WG | pergamon | 01960947001 | stuk | 343,00 | 017 | 1 |
| closetcombinatie diepspoel AO | | | | | | | |
| 0303275 | | wit | DURAPLUS | stuk | 262,00 | 017 | 0 |
| 0303305 | | pergamon | DURAPLUS | stuk | 359,00 | 017 | 0 |
| 0303283 | | manhattan | DURAPLUS | stuk | 359,00 | 017 | 1 |
| 0308153 | m. WG | wit | DURAPLUS | stuk | 311,00 | 017 | 1 |
| 0308161 | m. WG | pergamon | DURAPLUS | stuk | 408,00 | 017 | 1 |
| 0830453 | set potschroeven 5.5x60mm chroom | | 0830453 | stuk | 2,28 | 362 | 0 |
| closetcombinatie diepspoel PK | | | | | | | |
| 0303356 | | wit | DURAPLUS | stuk | 262,00 | 017 | 0 |
| 0303380 | | pergamon | DURAPLUS | stuk | 359,00 | 017 | 0 |
| 0303364 | | manhattan | DURAPLUS | stuk | 359,00 | 017 | 1 |
| 0308188 | m. WG | wit | DURAPLUS | stuk | 311,00 | 017 | 1 |
| 0308196 | m. WG | pergamon | DURAPLUS | stuk | 408,00 | 017 | 1 |
| 0830453 | set potschroeven 5.5x60mm chroom | | 0830453 | stuk | 2,28 | 362 | 0 |
| closetcombinatie universeel | | | | | | | |
| 0290169 | m. WG | wit | DURAPLUS | stuk | 472,00 | 016 | 1 |
| 0290170 | m. WG | pergamon | DURAPLUS | stuk | 590,00 | 016 | 1 |
| 0830453 | set potschroeven 5.5x60mm chroom | | 0830453 | stuk | 2,28 | 362 | 0 |
| closetzitting dubbel | | | | | | | |
| 0297380 | Darling/Duraplus/Architec | wit | B4C101E0102Y | stuk | 38,75 | 016 | 0 |
| 0297399 | Darling/Duraplus/Architec | pergamon | B4C204E0102Y | stuk | 43,75 | 016 | 0 |
| 0297402 | Darling/Duraplus/Architec | manhattan | 0064201100 | stuk | 141,00 | 016 | 1 |
| closetcombinatie universeel | | | | | | | |
| 0295949 | | wit | DURAPLUS | stuk | 423,00 | 016 | 1 |
| 0295965 | | pergamon | DURAPLUS | stuk | 541,00 | 016 | 1 |
| 0295957 | | manhattan | DURAPLUS | stuk | 541,00 | 016 | 1 |
| 0290058 | vario aansluitset verstelbaar 20.5-24.5cm | | 8990250006 | stuk | 44,00 | 016 | 0 |
| 0293709 | vario aansluitset verstelbaar 7-18cm | | 0014220000 | stuk | 46,00 | 016 | 0 |
| 0830453 | set potschroeven 5.5x60mm chroom | | 0830453 | stuk | 2,28 | 362 | 0 |



Sanitair producten

Baden /
douchebakken /
stoomcabines

Kranen









Douchegarnituur









Accessoires en
spiegels

Douchewanden

Toebehoren &
afvoerenSpoel- &
installatiesystemenBadkamermeubelen
en toiletkastenGootstenen en
wastroggen

Utiliteit

| | Art.nr | Specificaties | Kleur | Lev.nr | Ehd | Prijs | Grp | CC | |
|---|---|---|--------------------------------------|------------|-------------|------------|--------|--------|-------|
| Sanitair producten | Duravit Duraplus | | | | | | | | |
| | duoblokpot universeel z. reservoir | | | | | | | | |
| |  | 0295981 | | wit | 0224090000 | stuk | 246,00 | 016 1 | |
| | | 0296015 | | pergamon | 0224094700 | stuk | 332,00 | 016 1 | |
| | | 0296007 | | manhattan | 0224091100 | stuk | 332,00 | 016 1 | |
| | | 0290162 | m. WG | wit | 02240900001 | stuk | 295,00 | 016 1 | |
| Baden / douchebakken / stoomcabines | | 0290163 | m. WG | pergamon | 02240947001 | stuk | 381,00 | 016 1 | |
| Kranen | duoblokreervoir + binnenwerk | | | | | | | | |
| |  | 0296031 | | wit | 0886300001 | stuk | 177,00 | 016 1 | |
| | | 0296066 | | pergamon | 0886304701 | stuk | 209,00 | 016 1 | |
| | | 0296058 | | manhattan | 0886301101 | stuk | 209,00 | 016 1 | |
| Douchegarnituur | duoblokpot diepspoel AO z. reservoir | | | | | | | | |
| Accessoires en spiegels |  | 0298096 | | wit | 0229010000 | stuk | 142,00 | 017 0 | |
| | | 0303453 | | pergamon | 0229014700 | stuk | 185,00 | 017 1 | |
| | | 0303437 | | manhattan | 0229011100 | stuk | 185,00 | 017 1 | |
| | | 0308110 | m. WG | wit | 02290100001 | stuk | 191,00 | 017 1 | |
| | | 0308129 | m. WG | pergamon | 02290147001 | stuk | 234,00 | 017 1 | |
| Douchewanden | duoblokpot diepspoel PK z. reservoir | | | | | | | | |
| | | 0298108 | | wit | 0229090000 | stuk | 142,00 | 017 0 | |
| | | 0303542 | | pergamon | 0229094700 | stuk | 185,00 | 017 1 | |
| | | 0303526 | | manhattan | 0229091100 | stuk | 185,00 | 017 1 | |
| | | 0308137 | m. WG | wit | 02290900001 | stuk | 191,00 | 017 1 | |
| Toebehoren & afvoeren | | 0308145 | m. WG | pergamon | 02290947001 | stuk | 234,00 | 017 1 | |
| Spoel- & installatiesystemen | duoblokreervoir + binnenwerk | | | | | | | | |
| |  | 0303585 | | wit | 0879200001 | stuk | 120,00 | 017 0 | |
| | | 0303615 | | pergamon | 0879204701 | stuk | 174,00 | 017 1 | |
| | | 0303593 | | manhattan | 0879201101 | stuk | 174,00 | 017 1 | |
| Badkamermeubelen en toiletkasten | urinoir m. verdekte afvoer | | | | | | | | |
| |  | 0308463 | | wit | 0830360000 | stuk | 271,00 | 017 1 | |
| | | 0305383 | m. WG | wit | 8303600001 | stuk | 320,00 | 017 1 | |
| | | 0293253 | urinoirsifon horizontaal | | 0050120000 | stuk | 25,50 | 017 0 | |
| | | 0293261 | urinoirsifon verticaal | | 0050110000 | stuk | 25,50 | 017 0 | |
| Gootstenen en wastroggen | | 0830097 | bevestigingsset M10x110mm | 0830097 | paar | 1,09 | 362 0 | | |
| Utiliteit | Duravit Duraplus Compact | | | | | | | | |
| | wastafel m. overloop z. kraangat | | | | | | | | |
| |  | 0303763 | 60x43,5cm | wit | 0354600010 | stuk | 94,00 | 017 1 | |
| | | 0830097 | bevestigingsset M10x110mm | | 0830097 | paar | 1,09 | 362 0 | |
| | wastafel m. overloop m. kraangat | | | | | | | | |
| | | 0303720 | 55x39,5cm | wit | 0354550000 | stuk | 85,00 | 017 1 | |
| | | 0303828 | 65x47cm | wit | 0354650000 | stuk | 114,00 | 017 1 | |
| | | 0830097 | bevestigingsset M10x110mm | | 0830097 | paar | 1,09 | 362 0 | |
| | fontein m. overloop z. kraangat | | | | | | | | |
| |  | 0303882 | 35x26,5cm | wit | 0797350000 | stuk | 59,00 | 017 1 | |
| | | 0303887 | 45x31cm | wit | 0797450010 | stuk | 65,00 | 017 1 | |
| | | 0830240 | bevestigingsset voor fontein M8x90mm | | 0830240 | stuk | 0,85 | 362 0 | |
| | Utiliteit | wandclosetpot diepspoel | | | | | | | |
| | |  | 0299897 | | wit | 0228090000 | stuk | 208,00 | 017 0 |
| | | | 0299899 | | pergamon | 0228094700 | stuk | 364,00 | 017 0 |
| | | 0299900 | | manhattan | 0228091100 | stuk | 364,00 | 017 1 | |
| | | 0295333 | m. WG | wit | 02280900001 | stuk | 257,00 | 017 1 | |
| | | 0299830 | m. WG | pergamon | 02280947001 | stuk | 413,00 | 017 1 | |
| closetzitting dubbel | | | | | | | | | |
| | 0299898 | | wit | 0066810000 | stuk | 58,00 | 017 0 | | |
| | 0299901 | | pergamon | 0066814700 | stuk | 70,00 | 017 0 | | |
| | 0299902 | | manhattan | 0066811100 | stuk | 70,00 | 017 1 | | |

| Art.nr | Specificaties | Kleur | Lev.nr | Ehd | Prijs | Grp | CC | | |
|--|--------------------------------------|-------|-------------|------|--------|-----|----|---|----------------------------------|
| | | | | | | | | Duravit Foster | |
| wastafel | | | | | | | | | |
| 0308331 | 55x44.5cm | wit | 0419550000 | stuk | 181,00 | 016 | 1 |  | Sanitair producten |
| 0306681 | 55x44.5cm m. WG | wit | 04195500001 | stuk | 230,00 | 016 | 1 | | |
| 0308323 | 60x49cm | wit | 0419600000 | stuk | 215,00 | 016 | 1 | | |
| 0306703 | 60x49cm m. WG | wit | 04196000001 | stuk | 264,00 | 016 | 1 | | |
| 0308315 | 70x53cm | wit | 0419700000 | stuk | 267,00 | 016 | 1 | | |
| 0304840 | 70x53cm m. WG | wit | 04197000001 | stuk | 316,00 | 016 | 1 | | |
| 0830097 | bevestigingsset M10x110mm | | 0830097 | paar | 1,09 | 362 | 0 | | |
| 0830097 | bevestigingsset M10x110mm | | 0830097 | paar | 1,09 | 362 | 0 | | |
| zuil voor wastafel | | | | | | | | | |
| 0304859 | 55/60/70cm | wit | 0863980000 | stuk | 118,00 | 016 | 1 |  | Kranen |
| sifonkap voor wastafel | | | | | | | | | |
| 0304867 | 55/60/70cm | wit | 0863970000 | stuk | 114,00 | 016 | 0 |  | Douchegarnituur |
| 0290963 | snelbevestigingsset voor sifonkap | | 0055030000 | stuk | 25,00 | 016 | 0 | | |
| fontein | | | | | | | | | |
| 0308358 | 47x39cm | wit | 0419470000 | stuk | 126,00 | 016 | 1 |  | Toehoren & afvoeren |
| 0304883 | 47x39cm m. WG | wit | 04194700001 | stuk | 175,00 | 016 | 1 | | |
| 0830240 | bevestigingsset voor fontein M8x90mm | | 0830240 | stuk | 0,85 | 362 | 0 | | |
| sifonkap voor fontein | | | | | | | | | |
| 0304891 | | wit | 0863990000 | stuk | 111,00 | 016 | 1 |  | Spool- & installatiesystemen |
| 0290963 | snelbevestigingsset voor sifonkap | | 0055030000 | stuk | 25,00 | 016 | 0 | | |
| wandbidet | | | | | | | | | |
| 0308420 | | wit | 0134150000 | stuk | 267,00 | 016 | 1 |  | Badkamermeubelen en toiletkasten |
| 0304905 | m. WG | wit | 01341500001 | stuk | 316,00 | 016 | 1 | | |
| staand bidet m. bevestiging | | | | | | | | | |
| 0308439 | | wit | 0134100000 | stuk | 291,00 | 016 | 1 |  | Utiliteit |
| 0304913 | m. WG | wit | 01341000001 | stuk | 340,00 | 016 | 1 | | |
| wandclosetpot diepspoel | | | | | | | | | |
| 0308447 | | wit | 0175090000 | stuk | 315,00 | 016 | 1 |  | |
| 0305014 | m. WG | wit | 01750900001 | stuk | 364,00 | 016 | 0 | | |
| duoblokpot diepspoel z. reservoir | | | | | | | | | |
| 0290167 | | wit | 0176090000 | stuk | 381,00 | 016 | 1 |  | |
| 0305022 | m. WG | wit | 01760900001 | stuk | 430,00 | 016 | 1 | | |
| duoblokreservoir + binnenwerk | | | | | | | | | |
| 0308455 | | wit | 0912000051 | stuk | 287,00 | 016 | 1 | | |

| Art.nr | Specificaties | Kleur | Lev.nr | Ehd | Prijs | Grp | CC |
|--------|---------------|-------|--------|-----|-------|-----|----|
|--------|---------------|-------|--------|-----|-------|-----|----|

Duravit Foster

closetzitting dubbel
0305057



| | | | | | |
|-----|------------|------|--------|-----|---|
| wit | 0060210000 | stuk | 103,00 | 016 | 0 |
|-----|------------|------|--------|-----|---|

Duravit Happy-D

wastafel



| | | | | | | | | |
|---------|---------------------------|-----------------------|-----|-------------|------|--------|-----|---|
| 0295622 | 60x48cm | m. 1 kraangat | wit | 0417600000 | stuk | 118,00 | 016 | 0 |
| 0306584 | 60x48cm | m. 1 kraangat m. WG | wit | 4176000001 | stuk | 167,00 | 016 | 1 |
| 0290267 | 60x48cm | m. 3 kraangaten | wit | 4176000300 | stuk | 118,00 | 016 | 1 |
| 0290268 | 60x48cm | m. 3 kraangaten m. WG | wit | 4176000301 | stuk | 167,00 | 016 | 1 |
| 0290505 | 65x52cm | m. 1 kraangat | wit | 0417650000 | stuk | 186,00 | 016 | 0 |
| 0295400 | 65x52cm | m. 1 kraangat m. WG | wit | 04176500001 | stuk | 235,00 | 016 | 0 |
| 0290261 | 65x52cm | m. 3 kraangaten | wit | 4176500300 | stuk | 186,00 | 016 | 1 |
| 0290266 | 65x52cm | m. 3 kraangaten m. WG | wit | 4176500301 | stuk | 235,00 | 016 | 1 |
| 0290500 | 75x52,5cm | m. 1 kraangat | wit | 0417750000 | stuk | 271,00 | 016 | 0 |
| 0295398 | 75x52,5cm | m. 1 kraangat m. WG | wit | 04177500001 | stuk | 320,00 | 016 | 1 |
| 0290258 | 75x52,5cm | m. 3 kraangaten | wit | 4177500300 | stuk | 271,00 | 016 | 1 |
| 0290259 | 75x52,5cm | m. 3 kraangaten m. WG | wit | 4177500301 | stuk | 320,00 | 016 | 1 |
| 0315275 | 80x52,5cm | m. 1 kraangat | wit | 0417800000 | stuk | 356,00 | 016 | 0 |
| 0315279 | 80x52,5cm | m. 1 kraangat m. WG | wit | 04178000001 | stuk | 405,00 | 016 | 1 |
| 0315276 | 80x52,5cm | m. 3 kraangaten | wit | 04178000300 | stuk | 356,00 | 016 | 1 |
| 0315280 | 80x52,5cm | m. 3 kraangaten m. WG | wit | 04178000301 | stuk | 405,00 | 016 | 1 |
| 0315272 | 100x52,5cm | m. 1 kraangat | wit | 0417100000 | stuk | 476,00 | 016 | 0 |
| 0315277 | 100x52,5cm | m. 1 kraangat m. WG | wit | 04171000001 | stuk | 525,00 | 016 | 1 |
| 0315274 | 100x52,5cm | m. 3 kraangaten | wit | 04171000300 | stuk | 476,00 | 016 | 1 |
| 0315278 | 100x52,5cm | m. 3 kraangaten m. WG | wit | 04171000301 | stuk | 525,00 | 016 | 1 |
| 0830097 | bevestigingsset M10x110mm | | | 0830097 | paar | 1,09 | 362 | 0 |

sifonkap voor wastafel



| | | | | | | | | |
|---------|-----------------------------------|-------|-----|-------------|------|--------|-----|---|
| 0290515 | | | wit | 0863850000 | stuk | 97,00 | 016 | 0 |
| 0295402 | | m. WG | wit | 08638500001 | stuk | 146,00 | 016 | 1 |
| 0290963 | snelbevestigingsset voor sifonkap | | | 0055030000 | stuk | 25,00 | 016 | 0 |

zuil voor wastafel



| | | | | | | | | |
|---------|--|--|-----|------------|------|--------|-----|---|
| 0290520 | | | wit | 0863860000 | stuk | 103,00 | 016 | 1 |
|---------|--|--|-----|------------|------|--------|-----|---|

onderstel



| | | | | | | | | |
|---------|-------------------------|----------------------|-------|------------|------|--------|-----|---|
| 0290480 | 65cm | voor wastafel 041765 | chrom | 0030611000 | stuk | 333,00 | 016 | 0 |
| 0290501 | 75cm | voor wastafel 041775 | chrom | 0030601000 | stuk | 333,00 | 016 | 1 |
| 0315363 | 80cm | voor wastafel 041780 | chrom | 0030691000 | stuk | 317,00 | 016 | 1 |
| 0315302 | 100cm | voor wastafel 041710 | chrom | 0030701000 | stuk | 321,00 | 016 | 0 |
| 0290507 | designsifon m. muurbuis | | chrom | 0050361000 | stuk | 132,00 | 016 | 0 |

designsifon m. muurbuis

| | | | | | | | | |
|---------|--|--|-------|------------|------|--------|-----|---|
| 0290507 | | | chrom | 0050361000 | stuk | 132,00 | 016 | 0 |
|---------|--|--|-------|------------|------|--------|-----|---|

wastafel z. kraanplateau

| | | | | | | | | |
|---------|---------|-------|-----|-------------|------|--------|-----|---|
| 0290510 | 65x44cm | | wit | 0418650000 | stuk | 186,00 | 016 | 0 |
| 0295406 | 65x44cm | m. WG | wit | 04186500001 | stuk | 235,00 | 016 | 1 |

sifonkap voor wastafel 418.65 / fontein 417.46



| | | | | | | | | |
|---------|-----------------------------------|--|-----|------------|------|-------|-----|---|
| 0295624 | | | wit | 0863870000 | stuk | 78,00 | 016 | 1 |
| 0290970 | snelbevestigingsset voor sifonkap | | | 0055040000 | stuk | 25,00 | 016 | 0 |

| Art.nr | Specificaties | Kleur | Lev.nr | Ehd | Prijs | Grp | CC |
|--------|---------------|-------|--------|-----|-------|-----|----|
|--------|---------------|-------|--------|-----|-------|-----|----|

Duravit Happy-D

onderstel

| | | | | | | | |
|---------|-------------------------------|-------|------------|------|--------|-----|---|
| 0290503 | voor wastafel 041865 | chrom | 0030621000 | stuk | 330,00 | 016 | 0 |
| 0290507 | designsifon m. muurbuis chrom | | 0050361000 | stuk | 132,00 | 016 | 0 |



Sanitair producten

Baden /
douchebakken /
stoomcabines**wastafel m. geslepen rand**

| | | | | | | | |
|---------|----------------------------------|-----|-------------|------|--------|-----|---|
| 0315298 | 60x52.5cm m. 1 kraangat | wit | 0417600027 | stuk | 123,00 | 016 | 1 |
| 0315300 | 60x52.5cm m. 1 kraangat m. WG | wit | 04176000271 | stuk | 172,00 | 016 | 1 |
| 0315299 | 60x52.5cm m. 3 kraangaten | wit | 0417600025 | stuk | 123,00 | 016 | 1 |
| 0315301 | 60x52.5cm m. 3 kraangaten m. WG | wit | 04176000251 | stuk | 172,00 | 016 | 1 |
| 0315294 | 65x52.5cm m. 1 kraangat | wit | 0417650027 | stuk | 191,00 | 016 | 1 |
| 0315296 | 65x52.5cm m. 1 kraangat m. WG | wit | 04176500271 | stuk | 240,00 | 016 | 1 |
| 0315295 | 65x52.5cm m. 3 kraangaten | wit | 0417650025 | stuk | 191,00 | 016 | 1 |
| 0315297 | 65x52.5cm m. 3 kraangaten m. WG | wit | 04176500251 | stuk | 240,00 | 016 | 1 |
| 0315290 | 75x52.5cm m. 1 kraangat | wit | 0417750027 | stuk | 276,00 | 016 | 1 |
| 0315292 | 75x52.5cm m. 1 kraangat m. WG | wit | 04177500271 | stuk | 325,00 | 016 | 1 |
| 0315291 | 75x52.5cm m. 3 kraangaten | wit | 0417750025 | stuk | 276,00 | 016 | 1 |
| 0315293 | 75x52.5cm m. 3 kraangaten m. WG | wit | 04177500251 | stuk | 325,00 | 016 | 1 |
| 0315284 | 80x52.5cm m. 1 kraangat | wit | 0417800027 | stuk | 361,00 | 016 | 1 |
| 0315288 | 80x52.5cm m. 1 kraangat m. WG | wit | 04178000271 | stuk | 410,00 | 016 | 1 |
| 0315285 | 80x52.5cm m. 3 kraangaten | wit | 0417800025 | stuk | 361,00 | 016 | 1 |
| 0315289 | 80x52.5cm m. 3 kraangaten m. WG | wit | 04178000251 | stuk | 410,00 | 016 | 1 |
| 0315282 | 100x52.5cm m. 1 kraangat | wit | 0417100027 | stuk | 481,00 | 016 | 1 |
| 0315286 | 100x52.5cm m. 1 kraangat m. WG | wit | 04171000271 | stuk | 530,00 | 016 | 1 |
| 0315283 | 100x52.5cm m. 3 kraangaten | wit | 0417100025 | stuk | 481,00 | 016 | 1 |
| 0315287 | 100x52.5cm m. 3 kraangaten m. WG | wit | 04171000251 | stuk | 530,00 | 016 | 1 |



Kranen

Douchegarnituur

Accessoires en
spiegels

Douchewanden

Toebehoren &
afvoeren**wastafel m. geslepen rand m. overloop z. kraangat**

| | | | | | | | |
|---------|---------------|-----|-------------|------|--------|-----|---|
| 0315364 | 40x40cm | wit | 0458400028 | stuk | 271,00 | 016 | 0 |
| 0315365 | 40x40cm m. WG | wit | 04584000281 | stuk | 320,00 | 016 | 1 |

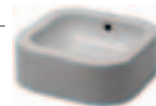
Spoel- &
installatiesystemen**push-open ventiel**

| | | | | | | | |
|---------|--|--|------------|------|-------|-----|---|
| 0315366 | | | 0050521000 | stuk | 49,00 | 016 | 1 |
|---------|--|--|------------|------|-------|-----|---|

Badkamermeubelen
en toiletkasten**wastafel m. geslepen rand m. overloop z. kraangat**

| | | | | | | | |
|---------|---------------|-----|-------------|------|--------|-----|---|
| 0315367 | 60x40cm | wit | 0458600028 | stuk | 313,00 | 016 | 1 |
| 0315368 | 60x40cm m. WG | wit | 04586000281 | stuk | 362,00 | 016 | 1 |

Gootstenen en
wastroggen**opbouwastafel**

| | | | | | | | |
|---------|---------------------------------|-----|-------------|------|--------|-----|---|
| 0315369 | 54x43.5cm m. 1 kraangat | wit | 0423540000 | stuk | 250,00 | 016 | 1 |
| 0315544 | 54x43.5cm m. 1 kraangat m. WG | wit | 04235400001 | stuk | 299,00 | 016 | 1 |
| 0315371 | 54x43.5cm m. 3 kraangaten | wit | 0423540030 | stuk | 250,00 | 016 | 1 |
| 0315372 | 54x43.5cm m. 3 kraangaten m. WG | wit | 04235400301 | stuk | 299,00 | 016 | 1 |



Utiliteit

onderbouwastafel

| | | | | | | | |
|---------|---------------------------------|-----|-------------|------|--------|-----|---|
| 0315373 | 48x43.5cm m. 1 kraangat | wit | 0441480000 | stuk | 246,00 | 016 | 1 |
| 0315374 | 48x43.5cm m. 1 kraangat m. WG | wit | 04414800001 | stuk | 295,00 | 016 | 1 |
| 0315375 | 48x43.5cm m. 3 kraangaten | wit | 0441480030 | stuk | 246,00 | 016 | 1 |
| 0315376 | 48x43.5cm m. 3 kraangaten m. WG | wit | 04414800301 | stuk | 295,00 | 016 | 1 |

**onderbouwastafel z. kraangat**

| | | | | | | | |
|---------|---------------|-----|-------------|------|--------|-----|---|
| 0315377 | 48x34cm | wit | 0457470000 | stuk | 286,00 | 016 | 1 |
| 0315378 | 48x34cm m. WG | wit | 04574700001 | stuk | 333,00 | 016 | 1 |

**fontein**

| | | | | | | | |
|---------|--------------------------------------|-----|-------------|------|--------|-----|---|
| 0295630 | 46x34,5cm | wit | 0417460000 | stuk | 72,00 | 016 | 0 |
| 0308412 | 46x34,5cm m. WG | wit | 04174600001 | stuk | 121,00 | 016 | 1 |
| 0830240 | bevestigingsset voor fontein M8x90mm | | 0830240 | stuk | 0,85 | 362 | 0 |



| Art.nr | Specificaties | Kleur | Lev.nr | Ehd | Prijs | Grp | CC |
|--------|---------------|-------|--------|-----|-------|-----|----|
|--------|---------------|-------|--------|-----|-------|-----|----|

Duravit Happy-D

sifonkap voor wastafel 418.65 / fontein 417.46

| | | | | | | | |
|---------|-----------------------------------|-----|------------|------|-------|-----|---|
| 0295624 | | wit | 0863870000 | stuk | 78,00 | 016 | 1 |
| 0290970 | snelbevestigingsset voor sifonkap | | 0055040000 | stuk | 25,00 | 016 | 0 |



Sanitair producten

Baden /
douchebakken /
stoomcabines

Kranen

Douchegarnituur

Accessoires en
spiegels

Douchewanden

Toebehoren &
afvoeren

Spoel- &
installatiesystemen

Badkamermeubelen
en toiletkasten

Gootstenen en
wastroggen

Utiliteit

fontein

| | | | | | | | |
|---------|--------------------------------------|-----|------------|------|--------|-----|---|
| 0295626 | 50x25cm | wit | 0418500000 | stuk | 84,00 | 016 | 0 |
| 0308404 | 50x25cm m. WG | wit | 0418500001 | stuk | 133,00 | 016 | 1 |
| 0830240 | bevestigingsset voor fontein M8x90mm | | 0830240 | stuk | 0,85 | 362 | 0 |



sifonkap voor fontein 418.50

| | | | | | | | |
|---------|-----------------------------------|-----|------------|------|-------|-----|---|
| 0295628 | | wit | 0863880000 | stuk | 78,00 | 016 | 0 |
| 0290970 | snelbevestigingsset voor sifonkap | | 0055040000 | stuk | 25,00 | 016 | 0 |



staand bidet

| | | | | | | | |
|---------|-------|-----|------------|------|--------|-----|---|
| 0295632 | | wit | 0257100000 | stuk | 188,00 | 016 | 1 |
| 0290245 | m. WG | wit | 0257100001 | stuk | 237,00 | 016 | 1 |



wandbidet

| | | | | | | | |
|---------|-------|-----|------------|------|--------|-----|---|
| 0290550 | | wit | 0256150000 | stuk | 208,00 | 016 | 0 |
| 0295408 | m. WG | wit | 0256150001 | stuk | 257,00 | 016 | 1 |



wandclosetpot diepspoel

| | | | | | | | |
|---------|-------|-----|------------|------|--------|-----|---|
| 0290545 | | wit | 0171090000 | stuk | 272,00 | 016 | 0 |
| 0296130 | m. WG | wit | 0171090001 | stuk | 321,00 | 016 | 0 |



duoblokpot diepspoel universeel z. reservoir

| | | | | | | | |
|---------|-------|-----|------------|------|--------|-----|---|
| 0290530 | | wit | 0172090000 | stuk | 245,00 | 016 | 1 |
| 0295410 | m. WG | wit | 0172090001 | stuk | 294,00 | 016 | 1 |



duoblokpot diepspoel vario z. reservoir

| | | | | | | | |
|---------|-------|-----|------------|------|--------|-----|---|
| 0290525 | | wit | 0170090000 | stuk | 245,00 | 016 | 0 |
| 0295412 | m. WG | wit | 0170090001 | stuk | 294,00 | 016 | 1 |



duoblokreervoir + binnenwerk

| | | | | | | | |
|---------|--|-----|------------|------|--------|-----|---|
| 0290535 | | wit | 0910000005 | stuk | 170,00 | 016 | 0 |
|---------|--|-----|------------|------|--------|-----|---|

closetzitting dubbel

| | | | | | | | |
|---------|-----------|-----|-------------|------|--------|-----|---|
| 0299924 | | wit | 00669100000 | stuk | 102,00 | 015 | 0 |
| 0290271 | softclose | wit | 66990000 | stuk | 139,00 | 015 | 0 |

| Art.nr | Specificaties | Kleur | Lev.nr | Ehd | Prijs | Grp | CC |
|-------------------------------------|------------------|-----------|---------|------|--------|-----|----|
| Duravit Happy-D | | | | | | | |
| onderbouw voor wastafel 40cm | | | | | | | |
| 0315381 | 39x34.6cm links | wit | 628422L | stuk | 766,00 | 304 | 1 |
| 0315379 | 39x34.6cm links | bergahorn | 628421L | stuk | 747,00 | 304 | 1 |
| 0315383 | 39x34.6cm links | kersen | 628426L | stuk | 832,00 | 304 | 1 |
| 0315545 | 39x34.6cm links | macassar | 628424L | stuk | 832,00 | 304 | 1 |
| 0315385 | 39x34.6cm links | noten | 628413L | stuk | 832,00 | 304 | 1 |
| 0315387 | 39x34.6cm links | zebrano | 628444L | stuk | 832,00 | 304 | 1 |
| 0315382 | 39x34.6cm rechts | wit | 628422R | stuk | 766,00 | 304 | 1 |
| 0315380 | 39x34.6cm rechts | bergahorn | 628421R | stuk | 747,00 | 304 | 1 |
| 0315384 | 39x34.6cm rechts | kersen | 628426R | stuk | 832,00 | 304 | 1 |
| 0315390 | 39x34.6cm rechts | macassar | 628424R | stuk | 832,00 | 304 | 1 |
| 0315386 | 39x34.6cm rechts | noten | 628413R | stuk | 832,00 | 304 | 1 |
| 0315388 | 39x34.6cm rechts | zebrano | 628444R | stuk | 832,00 | 304 | 1 |



| | | | | | | | |
|-------------------------------------|-----------|-----------|--------|------|--------|-----|---|
| onderbouw voor wastafel 60cm | | | | | | | |
| 0315393 | 59x34.6cm | wit | 628522 | stuk | 923,00 | 304 | 1 |
| 0315391 | 59x34.6cm | bergahorn | 628521 | stuk | 895,00 | 304 | 1 |
| 0315395 | 59x34.6cm | kersen | 628526 | stuk | 980,00 | 304 | 1 |
| 0315546 | 59x34.6cm | noten | 628513 | stuk | 980,00 | 304 | 1 |



| | | | | | | | |
|-------------------------------------|-----------|-----------|--------|------|--------|-----|---|
| onderbouw voor wastafel 65cm | | | | | | | |
| 0315401 | 63x34,9cm | wit | 628622 | stuk | 743,00 | 304 | 1 |
| 0315399 | 63x34,9cm | bergahorn | 628621 | stuk | 698,00 | 304 | 1 |
| 0315403 | 63x34,9cm | kersen | 628626 | stuk | 781,00 | 304 | 1 |
| 0315405 | 63x34,9cm | noten | 628613 | stuk | 781,00 | 304 | 1 |

| | | | | | | | |
|-------------------------------------|-----------|-----------|--------|------|--------|-----|---|
| onderbouw voor wastafel 80cm | | | | | | | |
| 0315409 | 78x34,9cm | wit | 628722 | stuk | 761,00 | 304 | 1 |
| 0315407 | 78x34,9cm | bergahorn | 628721 | stuk | 708,00 | 304 | 1 |
| 0315411 | 78x34,9cm | kersen | 628726 | stuk | 790,00 | 304 | 1 |
| 0315413 | 78x34,9cm | noten | 628713 | stuk | 790,00 | 304 | 1 |

| | | | | | | | |
|--------------------------------------|-----------|-----------|--------|------|--------|-----|---|
| onderbouw voor wastafel 100cm | | | | | | | |
| 0315417 | 98x34,9cm | wit | 628822 | stuk | 917,00 | 304 | 1 |
| 0315415 | 98x34,9cm | bergahorn | 628821 | stuk | 847,00 | 304 | 1 |
| 0315548 | 98x34,9cm | kersen | 628826 | stuk | 981,00 | 304 | 1 |
| 0315421 | 98x34,9cm | noten | 628813 | stuk | 981,00 | 304 | 1 |



| | | | | | | | |
|----------------|---------|-----------|--------|------|--------|-----|---|
| spiegel | | | | | | | |
| 0315424 | 35x66cm | wit | 962622 | stuk | 172,00 | 304 | 1 |
| 0315423 | 35x66cm | bergahorn | 962621 | stuk | 172,00 | 304 | 1 |
| 0315425 | 35x66cm | kersen | 962626 | stuk | 172,00 | 304 | 1 |
| 0315426 | 35x66cm | noten | 962613 | stuk | 172,00 | 304 | 1 |
| 0315428 | 50x66cm | wit | 962722 | stuk | 190,00 | 304 | 1 |
| 0315549 | 50x66cm | bergahorn | 962721 | stuk | 190,00 | 304 | 1 |
| 0315429 | 50x66cm | kersen | 962726 | stuk | 190,00 | 304 | 1 |
| 0315430 | 50x66cm | noten | 962713 | stuk | 190,00 | 304 | 1 |
| 0315432 | 70x66cm | wit | 962822 | stuk | 201,00 | 304 | 1 |
| 0315431 | 70x66cm | bergahorn | 962821 | stuk | 201,00 | 304 | 1 |
| 0315433 | 70x66cm | kersen | 962826 | stuk | 201,00 | 304 | 1 |
| 0315434 | 70x66cm | noten | 962813 | stuk | 201,00 | 304 | 1 |

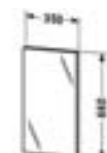

Sanitair producten

Baden /
douchebakken /
stoomcabines

Kranen

Douchegarnituur

Accessoires en
spiegels

Douchewanden

Toebehoren &
afvoerenSpoel- &
installatiesystemenBadkamermeubelen
en toiletkastenGootstenen en
wastroggen

Utiliteit

| Art.nr | Specificaties | Kleur | Lev.nr | Ehd | Prijs | Grp | CC |
|--------|---------------|-------|--------|-----|-------|-----|----|
|--------|---------------|-------|--------|-----|-------|-----|----|

Duravit Happy-D

spiegel m. verlichting

| | | | | | | | |
|---------|----------|-----------|--------|------|--------|-----|---|
| 0315550 | 50x66cm | alu/wit | 963037 | stuk | 455,00 | 304 | 1 |
| 0315436 | 70x66cm | alu/wit | 963137 | stuk | 467,00 | 304 | 1 |
| 0315437 | 80x66cm | alu/wit | 963237 | stuk | 472,00 | 304 | 1 |
| 0315439 | 100x66cm | wit | 963322 | stuk | 605,00 | 304 | 1 |
| 0315438 | 100x66cm | bergahorn | 963321 | stuk | 605,00 | 304 | 1 |
| 0315440 | 100x66cm | kersen | 963326 | stuk | 605,00 | 304 | 1 |
| 0315441 | 100x66cm | noten | 963313 | stuk | 605,00 | 304 | 1 |



Sanitair producten

Baden /
douchebakken /
stoomcabines

Kranen

Douchegarnituur

Accessoires en
spiegels

Douchewanden

Toebehoren &
afvoeren

Spoel- &
installatiesystemen

Badkamermeubelen
en toiletkasten

Gootstenen en
wastroggen

Utiliteit

spiegelkast m. verlichting

| | | | | | | | | |
|---------|----------|--------|-----------|---------|------|---------|-----|---|
| 0315551 | 50x66cm | links | wit | 963422L | stuk | 583,00 | 304 | 1 |
| 0315442 | 50x66cm | links | bergahorn | 963421L | stuk | 563,00 | 304 | 1 |
| 0315444 | 50x66cm | links | kersen | 963426L | stuk | 585,00 | 304 | 1 |
| 0315445 | 50x66cm | links | noten | 963413L | stuk | 585,00 | 304 | 1 |
| 0315447 | 50x66cm | rechts | wit | 963422R | stuk | 583,00 | 304 | 1 |
| 0315446 | 50x66cm | rechts | bergahorn | 963421R | stuk | 563,00 | 304 | 1 |
| 0315448 | 50x66cm | rechts | kersen | 963426R | stuk | 585,00 | 304 | 1 |
| 0315449 | 50x66cm | rechts | noten | 963413R | stuk | 585,00 | 304 | 1 |
| 0315552 | 70x66cm | | wit | 963522 | stuk | 734,00 | 304 | 1 |
| 0315450 | 70x66cm | | bergahorn | 963521 | stuk | 707,00 | 304 | 1 |
| 0315452 | 70x66cm | | kersen | 963526 | stuk | 740,00 | 304 | 1 |
| 0315453 | 70x66cm | | noten | 963513 | stuk | 740,00 | 304 | 1 |
| 0315459 | 80x66cm | | wit | 963622 | stuk | 747,00 | 304 | 1 |
| 0315458 | 80x66cm | | bergahorn | 963621 | stuk | 715,00 | 304 | 1 |
| 0315460 | 80x66cm | | kersen | 963626 | stuk | 753,00 | 304 | 1 |
| 0315461 | 80x66cm | | noten | 963613 | stuk | 753,00 | 304 | 1 |
| 0315467 | 100x66cm | | wit | 963722L | stuk | 1176,00 | 304 | 1 |
| 0315466 | 100x66cm | | bergahorn | 963721L | stuk | 1104,00 | 304 | 1 |
| 0315468 | 100x66cm | | kersen | 963726L | stuk | 1202,00 | 304 | 1 |
| 0315469 | 100x66cm | | noten | 963713L | stuk | 1202,00 | 304 | 1 |



bovenkast

| | | | | | | | | |
|---------|---------|--------|-----------|---------|------|--------|-----|---|
| 0315475 | 35x66cm | links | wit | 947422L | stuk | 386,00 | 304 | 1 |
| 0315474 | 35x66cm | links | bergahorn | 947421L | stuk | 347,00 | 304 | 1 |
| 0315476 | 35x66cm | links | kersen | 947426L | stuk | 397,00 | 304 | 1 |
| 0315477 | 35x66cm | links | noten | 947413L | stuk | 397,00 | 304 | 1 |
| 0315479 | 35x66cm | rechts | wit | 947422R | stuk | 386,00 | 304 | 1 |
| 0315553 | 35x66cm | rechts | bergahorn | 947421R | stuk | 347,00 | 304 | 1 |
| 0315480 | 35x66cm | rechts | kersen | 947426R | stuk | 397,00 | 304 | 1 |
| 0315481 | 35x66cm | rechts | noten | 947413R | stuk | 397,00 | 304 | 1 |
| 0315483 | 50x66cm | links | wit | 947522L | stuk | 416,00 | 304 | 1 |
| 0315482 | 50x66cm | links | bergahorn | 947521L | stuk | 374,00 | 304 | 1 |
| 0315484 | 50x66cm | links | kersen | 947526L | stuk | 431,00 | 304 | 1 |
| 0315485 | 50x66cm | links | noten | 947513L | stuk | 431,00 | 304 | 1 |
| 0315487 | 50x66cm | rechts | wit | 947522R | stuk | 416,00 | 304 | 1 |
| 0315554 | 50x66cm | rechts | bergahorn | 947521R | stuk | 374,00 | 304 | 1 |
| 0315488 | 50x66cm | rechts | kersen | 947526R | stuk | 431,00 | 304 | 1 |
| 0315489 | 50x66cm | rechts | noten | 947513R | stuk | 431,00 | 304 | 1 |
| 0315491 | 70x66cm | | wit | 947622L | stuk | 588,00 | 304 | 1 |
| 0315490 | 70x66cm | | bergahorn | 947621L | stuk | 535,00 | 304 | 1 |
| 0315492 | 70x66cm | | kersen | 947626L | stuk | 600,00 | 304 | 1 |
| 0315493 | 70x66cm | | noten | 947613L | stuk | 600,00 | 304 | 1 |



| Art.nr | Specificaties | Kleur | Lev.nr | Ehd | Prijs | Grp | CC |
|--------|---------------|-------|--------|-----|-------|-----|----|
|--------|---------------|-------|--------|-----|-------|-----|----|

Duravit Happy-D

bovenkast open m. verlichting m. planchet

| | | | | | | | |
|---------|---------|-----------|--------|------|--------|-----|---|
| 0315499 | 50x66cm | wit | 947722 | stuk | 434,00 | 304 | 1 |
| 0315498 | 50x66cm | bergahorn | 947721 | stuk | 412,00 | 304 | 1 |
| 0315500 | 50x66cm | kersen | 947726 | stuk | 525,00 | 304 | 1 |
| 0315501 | 50cm | noten | 947713 | stuk | 525,00 | 304 | 1 |
| 0315506 | 70x66cm | wit | 947822 | stuk | 490,00 | 304 | 1 |
| 0315505 | 70x66cm | bergahorn | 947821 | stuk | 466,00 | 304 | 1 |
| 0315507 | 70x66cm | kersen | 947826 | stuk | 608,00 | 304 | 1 |
| 0315556 | 70x66cm | noten | 947813 | stuk | 608,00 | 304 | 1 |

**lichtregaal m. verlichting**

| | | | | | | | |
|---------|---------|-----------|--------|------|--------|-----|---|
| 0315510 | 50x66cm | wit | 948022 | stuk | 500,00 | 304 | 1 |
| 0315509 | 50x66cm | bergahorn | 948021 | stuk | 489,00 | 304 | 1 |
| 0315511 | 50x66cm | kersen | 948026 | stuk | 526,00 | 304 | 1 |
| 0315512 | 50x66cm | noten | 948013 | stuk | 526,00 | 304 | 1 |
| 0315514 | 70x66cm | wit | 948122 | stuk | 724,00 | 304 | 1 |
| 0315513 | 70x66cm | bergahorn | 948121 | stuk | 526,00 | 304 | 1 |
| 0315515 | 70x66cm | kersen | 948126 | stuk | 579,00 | 304 | 1 |
| 0315557 | 70x66cm | noten | 948113 | stuk | 579,00 | 304 | 1 |

**hoge kast 2x deuren 1x lade**

| | | | | | | | | |
|---------|----------|--------|-----------|---------|------|---------|-----|---|
| 0315518 | 50x176cm | links | wit | 924522L | stuk | 854,00 | 304 | 1 |
| 0315517 | 50x176cm | links | bergahorn | 924521L | stuk | 649,00 | 304 | 1 |
| 0315519 | 50x176cm | links | kersen | 924526L | stuk | 1025,00 | 304 | 1 |
| 0315520 | 50x176cm | links | noten | 924513L | stuk | 1025,00 | 304 | 1 |
| 0315522 | 50x176cm | rechts | wit | 924522R | stuk | 854,00 | 304 | 1 |
| 0315521 | 50x176cm | rechts | bergahorn | 924521R | stuk | 649,00 | 304 | 1 |
| 0315523 | 50x176cm | rechts | kersen | 924526R | stuk | 1025,00 | 304 | 1 |
| 0315558 | 50x176cm | rechts | noten | 924513R | stuk | 1025,00 | 304 | 1 |

**hoge kast 1x deur 4x laden**

| | | | | | | | | |
|---------|----------|--------|-----------|---------|------|---------|-----|---|
| 0315526 | 50x176cm | links | wit | 924622L | stuk | 1062,00 | 304 | 1 |
| 0315525 | 50x176cm | links | bergahorn | 924621L | stuk | 900,00 | 304 | 1 |
| 0315527 | 50x176cm | links | kersen | 924626L | stuk | 1202,00 | 304 | 1 |
| 0315528 | 50x176cm | links | noten | 924613L | stuk | 1202,00 | 304 | 1 |
| 0315530 | 50x176cm | rechts | wit | 924622R | stuk | 1062,00 | 304 | 1 |
| 0315529 | 50x176cm | rechts | bergahorn | 924621R | stuk | 900,00 | 304 | 1 |
| 0315531 | 50x176cm | rechts | kersen | 924626R | stuk | 1202,00 | 304 | 1 |
| 0315560 | 50x176cm | rechts | noten | 924613R | stuk | 1202,00 | 304 | 1 |

**trolley m. 2x laden 1x deur**

| | | | | | | | | |
|---------|---------|--------|-----------|---------|------|--------|-----|---|
| 0315534 | 50x66cm | links | wit | 939622L | stuk | 733,00 | 304 | 1 |
| 0315533 | 50x66cm | links | bergahorn | 939621L | stuk | 639,00 | 304 | 1 |
| 0315535 | 50x66cm | links | kersen | 939626L | stuk | 806,00 | 304 | 1 |
| 0315536 | 50x66cm | links | noten | 939613L | stuk | 806,00 | 304 | 1 |
| 0315538 | 50x66cm | rechts | wit | 939622R | stuk | 733,00 | 304 | 1 |
| 0315537 | 50x66cm | rechts | bergahorn | 939621R | stuk | 639,00 | 304 | 1 |
| 0315539 | 50x66cm | rechts | kersen | 939626R | stuk | 806,00 | 304 | 1 |
| 0315541 | 50x66cm | rechts | noten | 939613R | stuk | 806,00 | 304 | 1 |

**schuiflade**

| | | | | | | | | |
|---------|---------|-------|--|------|------|------|-----|---|
| 0315542 | 8x12cm | klein | | 9914 | stuk | 7,00 | 304 | 1 |
| 0315543 | 16x12cm | groot | | 9913 | stuk | 8,00 | 304 | 1 |

Duravit Starck 1

wastafel

| | | | | | | | | |
|---------|---------|-------|-----|-------------|------|--------|-----|---|
| 0299620 | 57x57cm | | wit | 0405570000 | stuk | 531,00 | 015 | 1 |
| 0295426 | 57x57cm | m. WG | wit | 04055700001 | stuk | 580,00 | 015 | 0 |



Sanitair producten

Baden /
douchebakken /
stoomcabines

Kranen

Douchegarnituur

Accessoires en
spiegels

Douchewanden

Toebehoren &
afvoerenSpoel- &
installatiesystemenBadkamermeubelen
en toiletkastenGootstenen en
wastroggen

Utiliteit

| Art.nr | Specificaties | Kleur | Lev.nr | Ehd | Prijs | Grp | CC |
|--------|---------------|-------|--------|-----|-------|-----|----|
|--------|---------------|-------|--------|-----|-------|-----|----|

Duravit Starck 1

sifonkap voor wastafel 57cm

| | | | | | | | |
|---------|---|--------|------------|------|--------|-----|---|
| 0299641 | | wit | 0863520000 | stuk | 278,00 | 015 | 0 |
| 0299669 | m. chroom handdoekhouders | wit | STARCK1 | stuk | 381,00 | 015 | 0 |
| 0299856 | bevestigingsset voor sifonkap Philippe Starck | chroom | 0067041000 | paar | 6,00 | 015 | 0 |



Sanitair producten

Baden /
douchebakken /
stoomcabines

Kranen

Douchegarnituur



wastafel

| | | | | | | | |
|---------|---------------------------------|-----|-------------|------|--------|-----|---|
| 0299859 | 75x54.5cm | wit | 0405750000 | stuk | 695,00 | 015 | 1 |
| 0295416 | 75x54.5cm m. WG | wit | 0405750001 | stuk | 744,00 | 015 | 1 |
| 0299990 | 75x54.5cm m. 3 kraangaten | wit | 0405750030 | stuk | 695,00 | 015 | 1 |
| 0299991 | 75x54.5cm m. 3 kraangaten m. WG | wit | 04057500301 | stuk | 744,00 | 015 | 1 |
| 0299618 | 90x55cm | wit | 0405900000 | stuk | 832,00 | 015 | 1 |
| 0295414 | 90x55cm m. WG | wit | 0405900001 | stuk | 881,00 | 015 | 1 |
| 0299992 | 90x55cm m. 3 kraangaten m. WG | wit | 04059000301 | stuk | 881,00 | 015 | 1 |
| 0830097 | bevestigingsset M10x110mm | | 0830097 | paar | 1,09 | 362 | 0 |



Accessoires en
spiegels

Douchewanden

sifonkap voor wastafel 75-90cm

| | | | | | | | |
|---------|-----------------------------------|----------|------------|------|--------|-----|---|
| 0299635 | | wit | 0863550000 | stuk | 264,00 | 015 | 1 |
| 0299637 | m. handdoekhouder | chr./wit | STARCK1 | stuk | 365,00 | 015 | 0 |
| 0299639 | m. gaten | wit | 0863560000 | stuk | 300,00 | 015 | 0 |
| 0290963 | snelbevestigingsset voor sifonkap | | 0055030000 | stuk | 25,00 | 016 | 0 |



Toebehoren &
afvoeren

Spoel- &
installatiesystemen



Badkamermeubelen
en toiletkasten

zuil voor wastafel 75-90cm

| | | | | | | | |
|---------|--------------------------------------|----------|------------|------|--------|-----|---|
| 0299628 | | wit | 0863500000 | stuk | 306,00 | 015 | 1 |
| 0299630 | m. handdoekhouder | chr./wit | STARCK1 | stuk | 407,00 | 015 | 1 |
| 0299855 | bevestigingsset m. sierknop per paar | chroom | 0067001000 | paar | 13,00 | 017 | 1 |



Gootstenen en
wastroggen

Utiliteit



handdoekhouders per paar

| | | | | | | | |
|---------|--|--------|------------|------|-------|-----|---|
| 0299632 | | chroom | 0030501000 | paar | 65,00 | 015 | 0 |
|---------|--|--------|------------|------|-------|-----|---|

inbouwwastafel

| | | | | | | | |
|---------|------------|-----|-------------|------|--------|-----|---|
| 0292224 | 53cm | wit | 0407530000 | stuk | 584,00 | 016 | 1 |
| 0295432 | 53cm m. WG | wit | 04075300001 | stuk | 633,00 | 015 | 1 |



opbouwwastafel z. kraangat z. overloop

| | | | | | | | |
|---------|-------------|-----|-------------|------|--------|-----|---|
| 0308307 | Ø46cm | wit | 0445460000 | stuk | 532,00 | 016 | 1 |
| 0305235 | Ø46cm m. WG | wit | 04454600001 | stuk | 581,00 | 016 | 1 |



| Art.nr | Specificaties | Kleur | Lev.nr | Ehd | Prijs | Grp | CC |
|--------|---------------|-------|--------|-----|-------|-----|----|
|--------|---------------|-------|--------|-----|-------|-----|----|

Duravit Starck 1

opbouwastafel m. kraangat z. overloop

| | | | | | | | |
|---------|-------------|-----|-------------|------|--------|-----|---|
| 0308293 | Ø48cm | wit | 0446480000 | stuk | 610,00 | 016 | 1 |
| 0305243 | Ø48cm m. WG | wit | 04464800001 | stuk | 659,00 | 016 | 1 |



Sanitair producten

Baden /
douchebakken /
stoomcabines

Kranen

Douchegarnituur

Accessoires en
spiegels

Douchewanden

Toebehoren &
afvoerenSpoel- &
installatiesystemenBadkamermeubelen
en toiletkastenGootstenen en
wastroggen

Utiliteit

sifonkap voor wastafel 044648

| | | | | | | | |
|---------|--|---------|------------|------|-------|-----|---|
| 0305308 | | chroom | 0050401000 | stuk | 23,00 | 017 | 1 |
| 0305316 | | satinox | 0050406500 | stuk | 39,00 | 017 | 1 |

opbouwastafel m. overloop

| | | | | | | | |
|---------|-------------|-----|-------------|------|--------|-----|---|
| 0308285 | Ø53cm | wit | 0447530000 | stuk | 562,00 | 016 | 1 |
| 0305251 | Ø53cm m. WG | wit | 04475300001 | stuk | 611,00 | 016 | 1 |

**wastafel losse kom**

| | | | | | | | |
|---------|-------------|-----|-------------|------|--------|-----|---|
| 0298995 | Ø53cm | wit | 0408530000 | stuk | 615,00 | 015 | 0 |
| 0295458 | Ø53cm m. WG | wit | 04085300001 | stuk | 664,00 | 015 | 1 |

**meubelwastafel**

| | | | | | | | |
|---------|---------------|-----|-------------|------|--------|-----|---|
| 0299622 | 58x58cm | wit | 0406580000 | stuk | 531,00 | 015 | 1 |
| 0295456 | 58x58cm m. WG | wit | 04065800001 | stuk | 580,00 | 015 | 1 |

**wastafelonderbouw 60x55cm voor wastafel 40658**

| | | | | | | | |
|---------|--|----------|--------|------|---------|-----|---|
| 0299663 | | kersen | 952053 | stuk | 2421,00 | 304 | 1 |
| 0290160 | | macassar | 952024 | stuk | 2494,00 | 304 | 1 |

wastafel m. houten onderstel

| | | | | | | | |
|---------|-------------------------|-----|-------------|------|---------|-----|---|
| 0299887 | z. kraangat | wit | 0409000000 | stuk | 2681,00 | 015 | 1 |
| 0295462 | z. kraangat m. WG | wit | 04090000001 | stuk | 2730,00 | 015 | 1 |
| 0299888 | m. kraangat rechts | wit | 0409000008 | stuk | 2681,00 | 015 | 1 |
| 0295464 | m. kraangat recht m. WG | wit | 04090000081 | stuk | 2730,00 | 015 | 1 |
| 0299889 | m. kraangat links | wit | 0409000009 | stuk | 2681,00 | 015 | 1 |
| 0295466 | m. kraangat links m. WG | wit | 04090000091 | stuk | 2730,00 | 015 | 1 |

**wastafel m. chroom onderstel**

| | | | | | | | |
|---------|--------------------------|-----|-------------|------|---------|-----|---|
| 0299890 | z. kraangat | wit | 0410000000 | stuk | 2169,00 | 015 | 1 |
| 0295468 | z. kraangat m. WG | wit | 04100000001 | stuk | 2218,00 | 015 | 1 |
| 0299891 | m. kraangat rechts | wit | 0410000008 | stuk | 2169,00 | 015 | 1 |
| 0295470 | m. kraangat rechts m. WG | wit | 04100000081 | stuk | 2218,00 | 015 | 1 |
| 0299892 | m. kraangat links | wit | 0410000009 | stuk | 2169,00 | 015 | 1 |
| 0295472 | m. kraangat links m. WG | wit | 04100000091 | stuk | 2218,00 | 015 | 1 |

**fontein losse kom**

| | | | | | | | |
|---------|-------------|-----|-------------|------|--------|-----|---|
| 0299903 | Ø33cm | wit | 0408330000 | stuk | 320,00 | 015 | 0 |
| 0295460 | Ø33cm m. WG | wit | 04083300001 | stuk | 369,00 | 015 | 1 |

**fontein m. houten onderstel**

| | | | | | | | |
|---------|--------------------------|-----|-------------|------|---------|-----|---|
| 0299904 | z. kraangat | wit | 0412000000 | stuk | 1518,00 | 015 | 1 |
| 0299905 | m. kraangat rechts | wit | 0412000008 | stuk | 1518,00 | 015 | 1 |
| 0299906 | m. kraangat links | wit | 0412000009 | stuk | 1518,00 | 015 | 1 |
| 0295474 | z. kraangat m. WG | wit | 04120000001 | stuk | 1567,00 | 015 | 1 |
| 0295476 | m. kraangat rechts m. WG | wit | 04120000081 | stuk | 1567,00 | 015 | 1 |
| 0295478 | m. kraangat links m. WG | wit | 04120000091 | stuk | 1567,00 | 015 | 1 |

**staand bidet**

| | | | | | | | |
|---------|---|-----|-------------|------|--------|-----|---|
| 0299624 | | wit | 0274100000 | stuk | 572,00 | 015 | 1 |
| 0295436 | m. WG | wit | 02741000001 | stuk | 621,00 | 015 | 1 |
| 0299857 | bidetbuis sifon m. muurbuis 215mm 5/4" m. rozet | | 0050270000 | stuk | 22,00 | 015 | 1 |



| Art.nr | Specificaties | Kleur | Lev.nr | Ehd | Prijs | Grp | CC |
|--------|---------------|-------|--------|-----|-------|-----|----|
|--------|---------------|-------|--------|-----|-------|-----|----|

Duravit Starck 1

wandbidet



| | | | | | | | |
|---------|---|-----|-------------|------|--------|-----|---|
| 0299626 | | wit | 0274150000 | stuk | 576,00 | 015 | 1 |
| 0295434 | m. WG | wit | 02741500001 | stuk | 625,00 | 015 | 1 |
| 0299857 | bidetbuis sifon m. muurbuis 215mm 5/4" m. rozet | | 0050270000 | stuk | 22,00 | 015 | 1 |

Sanitair producten

Baden /
douchebakken /
stoomcabines

wandclosetpot diepspoel



| | | | | | | | |
|---------|-------|-----|-------------|------|--------|-----|---|
| 0299657 | | wit | 0210090000 | stuk | 793,00 | 015 | 0 |
| 0295438 | m. WG | wit | 02100900001 | stuk | 842,00 | 015 | 0 |

Kranen

Douchegarnituur

closetcombinatie diepspoel universeel



| | | | | | | | |
|---------|--------------------------------------|-----|------------|------|---------|-----|---|
| 0299655 | | wit | STARCK1 | stuk | 1444,00 | 015 | 1 |
| 0295444 | m. WG | wit | STARCK1 | stuk | 1493,00 | 015 | 0 |
| 0293709 | vario aansluitset verstelbaar 7-18cm | | 0014220000 | stuk | 46,00 | 016 | 0 |

Accessoires en
spiegels

Douchewanden

closetzitting dubbel



| | | | | | | | |
|---------|-----------|-----|------------|------|--------|-----|---|
| 0299653 | | wit | 0065810000 | stuk | 166,00 | 015 | 0 |
| 0290270 | softclose | wit | 65880000 | stuk | 194,00 | 015 | 0 |

Toebehoren &
afvoeren

duoblokpot diepspoel universeel z. reservoir



| | | | | | | | |
|---------|-------|-----|-------------|------|--------|-----|---|
| 0299659 | | wit | 0233090000 | stuk | 681,00 | 015 | 1 |
| 0295440 | m. WG | wit | 02330900001 | stuk | 730,00 | 015 | 0 |

Spoel- &
installatiesystemen

Badkamermeubelen
en toiletkasten

duoblokreervoir + binnenwerk



| | | | | | | | |
|---------|--|-----|------------|------|--------|-----|---|
| 0299661 | | wit | 8727000001 | stuk | 763,00 | 015 | 0 |
|---------|--|-----|------------|------|--------|-----|---|

Gootstenen en
wastroggen

wandurinoir achterinlaat



| | | | | | | | |
|---------|-------|-----|-------------|------|--------|-----|---|
| 0299647 | | wit | 0834320000 | stuk | 470,00 | 015 | 1 |
| 0295446 | m. WG | wit | 08343200001 | stuk | 519,00 | 015 | 1 |

Utiliteit

wandurinoir voor deksel achterinlaat



| | | | | | | | |
|---------|-------|-----|-------------|------|--------|-----|---|
| 0299649 | | wit | 0835320000 | stuk | 470,00 | 015 | 0 |
| 0295448 | m. WG | wit | 08353200001 | stuk | 519,00 | 015 | 1 |

deksel voor wandurinoir

| | | | | | | | |
|---------|--|-----|------------|------|--------|-----|---|
| 0299650 | | wit | 0065910000 | stuk | 107,00 | 015 | 0 |
|---------|--|-----|------------|------|--------|-----|---|

spiegel 107.5x32.5cm



| | | | | | | | |
|---------|----------------|--|------|------|--------|-----|---|
| 0299664 | z. verlichting | | 9712 | stuk | 243,00 | 304 | 1 |
| 0299665 | m. verlichting | | 9713 | stuk | 593,00 | 304 | 0 |

| Art.nr | Specificaties | Kleur | Lev.nr | Ehd | Prijs | Grp | CC |
|--------|---------------|-------|--------|-----|-------|-----|----|
|--------|---------------|-------|--------|-----|-------|-----|----|

Duravit Starck 1

hoge kast 200x52cm 1xvitriedeur

| | | | | | | | |
|---------|--|--|-------|------|---------|-----|---|
| 0299909 | | | 9107L | stuk | 2192,00 | 304 | 1 |
|---------|--|--|-------|------|---------|-----|---|



Sanitair producten

Baden /
douchebakken /
stoomcabines

Duravit Starck 2

wastafel

| | | | | | | | | |
|---------|---------------------------|-------|-----|-------------|------|--------|-----|---|
| 0299910 | 55x47cm | | wit | 0411550000 | stuk | 174,00 | 015 | 0 |
| 0295372 | 55x47cm | m. WG | wit | 04115500001 | stuk | 223,00 | 015 | 1 |
| 0299911 | 60x50cm | | wit | 0411600000 | stuk | 201,00 | 015 | 0 |
| 0295370 | 60x50cm | m. WG | wit | 04116000001 | stuk | 250,00 | 015 | 1 |
| 0299912 | 65x51cm | | wit | 0411650000 | stuk | 233,00 | 015 | 0 |
| 0295368 | 65x51cm | m. WG | wit | 04116500001 | stuk | 282,00 | 015 | 1 |
| 0830097 | bevestigingsset M10x110mm | | | 0830097 | paar | 1,09 | 362 | 0 |



Kranen

Douchegarnituur

sifonkap voor wastafel

| | | | | | | | | |
|---------|-----------------------------------|--|-----|------------|------|--------|-----|---|
| 0299918 | | | wit | 0863810000 | stuk | 102,00 | 015 | 0 |
| 0290963 | snelbevestigingsset voor sifonkap | | | 0055030000 | stuk | 25,00 | 016 | 0 |

Accessoires en
spiegels

Douchewanden

zuil voor wastafel

| | | | | | | | | |
|---------|--|--|-----|------------|------|--------|-----|---|
| 0299917 | | | wit | 0863800000 | stuk | 108,00 | 015 | 1 |
|---------|--|--|-----|------------|------|--------|-----|---|

Toebehoren &
afvoerenSpoel- &
installatiesystemen**inbouw wastafel opbouw**

| | | | | | | | | |
|---------|--------|-------|-----|-------------|------|--------|-----|---|
| 0299913 | 47.5cm | | wit | 0478470000 | stuk | 197,00 | 015 | 0 |
| 0295382 | 47.5cm | m. WG | wit | 04784700001 | stuk | 246,00 | 015 | 1 |

Badkamermeubelen
en toiletkasten**fontein**

| | | | | | | | | |
|---------|--------------------------------------|--------------------|-----|-------------|------|--------|-----|---|
| 0306592 | 38x26cm | z. overloop | wit | 0761380000 | stuk | 109,00 | 015 | 0 |
| 0305278 | 38x26cm | z. overloop m. WG | wit | 07613800001 | stuk | 150,00 | 016 | 0 |
| 0305287 | 38x26cm | m. kraangat links | wit | 0761380009 | stuk | 109,00 | 015 | 1 |
| 0305288 | 38x26cm | m. kraangat rechts | wit | 0761380008 | stuk | 109,00 | 015 | 0 |
| 0830240 | bevestigingsset voor fontein M8x90mm | | | 0830240 | stuk | 0,85 | 362 | 0 |

Gootstenen en
wastroggen

Utiliteit

sifonkap voor fontein 38cm

| | | | | | | | | |
|---------|-----------------------------------|--|-----|------------|------|-------|-----|---|
| 0305286 | | | wit | 0863830000 | stuk | 85,00 | 016 | 0 |
| 0290970 | snelbevestigingsset voor sifonkap | | | 0055040000 | stuk | 25,00 | 016 | 0 |

fontein

| | | | | | | | | |
|---------|---------------------------|-------|-----|-------------|------|--------|-----|---|
| 0299914 | 50x41cm | | wit | 0761500000 | stuk | 123,00 | 015 | 0 |
| 0295378 | 50x41cm | m. WG | wit | 07615000001 | stuk | 172,00 | 015 | 1 |
| 0830097 | bevestigingsset M10x110mm | | | 0830097 | paar | 1,09 | 362 | 0 |





**sifonkap voor fontein 50cm**

| | | | | | | | | |
|---------|-----------------------------------|--|-----|------------|------|--------|-----|---|
| 0299919 | | | wit | 0863820000 | stuk | 115,00 | 015 | 0 |
| 0290963 | snelbevestigingsset voor sifonkap | | | 0055030000 | stuk | 25,00 | 016 | 0 |

staand bidet



| | | | | | | | | |
|---------|--|-------|-----|-------------|------|--------|-----|---|
| 0299915 | | | wit | 0263100000 | stuk | 254,00 | 015 | 1 |
| 0295386 | | m. WG | wit | 02631000001 | stuk | 303,00 | 015 | 1 |
| 0299857 | bidetbuissifon m. muurbuis 215mm 5/4" m. rozet | | | 0050270000 | stuk | 22,00 | 015 | 1 |









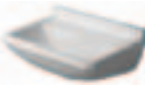
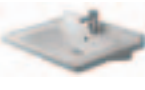











| | Art.nr | Specificaties | Kleur | Lev.nr | Ehd | Prijs | Grp | CC |
|---|---|--|-----------|------------|-------------|-------|--------|-------|
| Sanitair producten | Duravit Starck 2 | | | | | | | |
| | wandbidet | | | | | | | |
| | | 0299916 | | wit | 0263150000 | stuk | 225,00 | 015 0 |
| | | 0295384 | m. WG | wit | 0263150001 | stuk | 274,00 | 015 1 |
| | 0299857 | bidetbuissifon m. muurbuis 215mm 5/4" m. rozet | | 0050270000 | stuk | 22,00 | 015 1 | |
| Baden / douchebakken / stoomcabines |  | | | | | | | |
| Kranen | wandclosetpot diepspoel | | | | | | | |
| | | 0299920 | | wit | 0160090000 | stuk | 271,00 | 015 0 |
| | | 0295388 | m. WG | wit | 0160090001 | stuk | 320,00 | 015 0 |
| |  | | | | | | | |
| Douchegarnituur | wandclosetpot vlakspoel | | | | | | | |
| | | 0299921 | | wit | 0161090000 | stuk | 368,00 | 015 0 |
| | | 0295390 | m. WG | wit | 0161090001 | stuk | 417,00 | 015 1 |
| |  | | | | | | | |
| Accessoires en spiegels | | | | | | | | |
| Douchewanden | closetcombinatie diepspoel universeel | | | | | | | |
| | | 0299926 | | wit | STARCK2 | stuk | 528,00 | 015 0 |
| | | 0295396 | m. WG | wit | STARCK2 | stuk | 577,00 | 015 1 |
| |  | | | | | | | |
| Toebehoren & afvoeren | closetzitting dubbel | | | | | | | |
| | | 0299924 | | wit | 00669100000 | stuk | 102,00 | 015 0 |
| | | 0290271 | softclose | wit | 66990000 | stuk | 139,00 | 015 0 |
| Spoel- & installatiesystemen | laterale bekleding voor closetcombinatie | | | | | | | |
| | | 0299927 | | wit | 0050320000 | stuk | 53,00 | 015 0 |
| Badkamermeubelen en toiletkasten | duoblokpot diepspoel universeel z. reservoir | | | | | | | |
| | | 0299922 | | wit | 0238090000 | stuk | 322,00 | 015 0 |
| | | 0295392 | m. WG | wit | 0238090001 | stuk | 371,00 | 015 1 |
| Gootstenen en wastroggen | duoblokreervoir + binnenwerk | | | | | | | |
| | | 0299923 | | wit | 8729000005 | stuk | 206,00 | 015 0 |
| |  | | | | | | | |
| Utiliteit | | | | | | | | |



Living bathrooms. Sanitairkeramiek, badmeubelen, douchebakken, ligbaden, whirl- en wellnessystemen, accessoires: de weg naar een complete badkamer? Duravit maakt het mogelijk. Badmagazin? DURAVIT Nederland B.V., Ruwekampweg 2, 5222 AT 's-Hertogenbosch, Phone +31 73 6131970, Fax +31 73 6100983, info@nl.duravit.com

| | Art.nr | Specificaties | Kleur | Lev.nr | Ehd | Prijs | Grp | CC | |
|--|---|---|--------------------------------|----------------------------------|-------------|-------------|--------|--------|-------|
| Sanitair producten | Duravit Starck 3 wastafel | | | | | | | | |
| |  | 0312452 | 50x36cm | wit | 0300500000 | stuk | 74,00 | 017 0 | |
| | | 0312436 | 50x36cm m. WG | wit | 0300500001 | stuk | 123,00 | 017 1 | |
| | | 0312444 | 50x36cm | pergamon | 0300504700 | stuk | 92,00 | 017 1 | |
| | | 0312428 | 50x36cm m. WG | pergamon | 03005047001 | stuk | 141,00 | 017 1 | |
| | Baden / douchebakken / stoomcabines | | 0312509 | 55x42cm | wit | 0300550000 | stuk | 74,00 | 017 0 |
| | | | 0312479 | 55x42cm m. WG | wit | 0300550001 | stuk | 123,00 | 017 1 |
| | | | 0312495 | 55x42cm | pergamon | 0300554700 | stuk | 92,00 | 017 1 |
| | | | 0312460 | 55x42cm m. WG | pergamon | 03005547001 | stuk | 141,00 | 017 1 |
| | | | 0312541 | 60x45cm | wit | 0300600000 | stuk | 80,00 | 017 0 |
| Kranen | | 0312525 | 60x45cm m. WG | wit | 0300600001 | stuk | 121,00 | 017 0 | |
| | | 0312533 | 60x45cm | pergamon | 0300604700 | stuk | 99,00 | 017 0 | |
| | | 0312517 | 60x45cm m. WG | pergamon | 03006047001 | stuk | 148,00 | 017 1 | |
| Douchegarnituur | | 0312398 | 65x48cm | wit | 0300650000 | stuk | 101,00 | 017 0 | |
| | | 0312576 | 65x48cm m. WG | wit | 0300650001 | stuk | 150,00 | 017 1 | |
| | | 0312584 | 65x48cm | pergamon | 0300654700 | stuk | 125,00 | 017 1 | |
| | | 0312568 | 65x48cm m. WG | pergamon | 03006547001 | stuk | 174,00 | 017 1 | |
| | | 0830097 | bevestigingsset M10x110mm | | 0830097 | paar | 1,09 | 362 0 | |
| Accessoires en spiegels | dubbele wastafel | | | | | | | | |
| | | 0291329 | 130x48.5cm m. 1 kraangat | wit | 0332130000 | stuk | 615,00 | 017 1 | |
| | | 0291331 | 130x48.5cm m. 1 kraangat m. WG | wit | 0332130001 | stuk | 664,00 | 017 1 | |
| | | 0291330 | 130x48.5cm m. 1 kraangat | pergamon | 0332134700 | stuk | 615,00 | 017 1 | |
| | Douchewanden | | 0291332 | 130x48.5cm m. 1 kraangat m. WG | pergamon | 03321347001 | stuk | 664,00 | 017 1 |
| | | | 0291333 | 130x48.5cm m. 3 kraangaten | wit | 0332130030 | stuk | 615,00 | 017 1 |
| | | | 0291335 | 130x48.5cm m. 3 kraangaten m. WG | wit | 03321300301 | stuk | 664,00 | 017 1 |
| | | | 0291334 | 130x48.5cm m. 3 kraangaten | pergamon | 0332134730 | stuk | 615,00 | 017 1 |
| | | | 0291336 | 130x48.5cm m. 3 kraangaten m. WG | pergamon | 03321347301 | stuk | 664,00 | 017 1 |
| | Toebehoren & afvoeren | | 0830097 | bevestigingsset M10x110mm | | 0830097 | paar | 1,09 | 362 0 |
| Compact wastafel | | | | | | | | | |
|  | | 0312908 | 55x37cm | wit | 0301550000 | stuk | 77,00 | 017 0 | |
| | | 0312894 | 55x37cm | pergamon | 0301554700 | stuk | 95,00 | 017 1 | |
| | | 0312886 | 55x37cm m. WG | wit | 0301550001 | stuk | 126,00 | 017 1 | |
| Spoel- & installatiesystemen | | | 0312878 | 55x37cm m. WG | pergamon | 03015547001 | stuk | 144,00 | 017 1 |
| | | | 0312762 | 60x37cm | wit | 0301600000 | stuk | 80,00 | 017 0 |
| | | | 0312932 | 60x37cm | pergamon | 0301604700 | stuk | 99,00 | 017 1 |
| | | | 0312924 | 60x37cm m. WG | wit | 0301600001 | stuk | 129,00 | 017 1 |
| | | | 0312916 | 60x37cm m. WG | pergamon | 03016047001 | stuk | 146,00 | 017 1 |
| Badkamermeubelen en toiletkasten | | 0830097 | bevestigingsset M10x110mm | | 0830097 | paar | 1,09 | 362 0 | |
| | Med Compact wastafel z. kraangat | | | | | | | | |
| |  | 0312819 | 55x37cm | wit | 0308550000 | stuk | 89,00 | 017 1 | |
| | | 0312797 | 55x37cm m. WG | wit | 0308550001 | stuk | 138,00 | 017 1 | |
| | | 0312851 | 60x37cm | wit | 0308600000 | stuk | 98,00 | 017 1 | |
| | | 0312835 | 60x37cm m. WG | wit | 0308600001 | stuk | 147,00 | 017 1 | |
| | | 0830097 | bevestigingsset M10x110mm | | 0830097 | paar | 1,09 | 362 0 | |
| | Gootstenen en wastroggen | Med wastafel z. kraangat | | | | | | | |
| | |  | 0312711 | 50x36cm | wit | 0307500000 | stuk | 84,00 | 017 1 |
| | | | 0312746 | 50x36cm m. WG | wit | 0307500001 | stuk | 133,00 | 017 1 |
| | | 0312665 | 55x42cm | wit | 0307550000 | stuk | 84,00 | 017 1 | |
| | | 0312681 | 55x42cm m. WG | wit | 0307550001 | stuk | 133,00 | 017 1 | |
| | | 0312622 | 60x45cm | wit | 0307600000 | stuk | 91,00 | 017 1 | |
| | | 0312649 | 60x45cm m. WG | wit | 0307600001 | stuk | 140,00 | 017 1 | |
| | | 0312401 | 65x48cm | wit | 0307650000 | stuk | 113,00 | 017 1 | |
| | | 0312606 | 65x48cm m. WG | wit | 0307650001 | stuk | 162,00 | 017 1 | |
| | | 0830097 | bevestigingsset M10x110mm | | 0830097 | paar | 1,09 | 362 0 | |
| Utiliteit | Vital wastafel | | | | | | | | |
| |  | 0291337 | 60x54.5cm | wit | 0309600000 | stuk | 255,00 | 017 1 | |
| | | 0291339 | 60x54.5cm m. WG | wit | 0309600001 | stuk | 304,00 | 017 1 | |
| | | 0291338 | 60x54.5cm | pergamon | 0309604700 | stuk | 255,00 | 017 1 | |
| | | 0291340 | 60x54.5cm m. WG | pergamon | 03096047001 | stuk | 304,00 | 017 1 | |
| | | 0316318 | 70x54.5cm | wit | 0309700000 | stuk | 253,00 | 017 1 | |
| | | 0316326 | 70x54.5cm m. WG | wit | 0309700001 | stuk | 302,00 | 017 1 | |
| | | 0316334 | 70x54.5cm | pergamon | 0309704700 | stuk | 304,00 | 017 1 | |
| | | 0316342 | 70x54.5cm m. WG | pergamon | 03097047001 | stuk | 353,00 | 017 1 | |
| | | 0830097 | bevestigingsset M10x110mm | | 0830097 | paar | 1,09 | 362 0 | |

| Art.nr | Specificaties | Kleur | Lev.nr | Ehd | Prijs | Grp | CC | | |
|---|-----------------------------------|----------|------------|------|--------|-----|----|---|-------------------------------------|
| | | | | | | | | Duravit Starck 3 | |
| Vital Med wastafel z. overloop | | | | | | | | | |
| 0316350 | 70x54.5cm | wit | 0312700000 | stuk | 266,00 | 017 | 1 |  | Sanitair producten |
| 0316369 | 70x54.5cm m. WG | wit | 0312700001 | stuk | 315,00 | 017 | 1 | | |
| 0316377 | 70x54.5cm | pergamon | 0312704700 | stuk | 319,00 | 017 | 1 | | |
| 0316385 | 70x54.5cm m. WG | pergamon | 0312704701 | stuk | 368,00 | 017 | 1 | | |
| 0830097 | bevestigingsset M10x110mm | | 0830097 | paar | 1,09 | 362 | 0 | | |
| Vital Med afvoerventiel 80mm voor wastafel | | | | | | | | | |
| 0316393 | | | 0050381000 | stuk | 50,00 | 017 | 1 | | |
| sifonkap 1 030065/60/55-030480-030410-030970 | | | | | | | | | |
| 0312770 | | wit | 0865150000 | stuk | 68,00 | 017 | 0 |  | Kranen |
| 0313564 | | pergamon | 0865154700 | stuk | 83,00 | 017 | 0 | | |
| 0290963 | snelbevestigingsset voor sifonkap | | 0055030000 | stuk | 25,00 | 016 | 0 | | |
| sifonkap 2 | | | | | | | | | |
| 0313572 | 030050-075045-030160/55 | wit | 0865170000 | stuk | 68,00 | 017 | 0 |  | Accessoires en spiegels |
| 0313580 | 030050-075045-030160/55 | pergamon | 0865174700 | stuk | 83,00 | 017 | 0 | | |
| 0290963 | snelbevestigingsset voor sifonkap | | 0055030000 | stuk | 25,00 | 016 | 0 | | |
| zuil voor wastafel | | | | | | | | | |
| 0313599 | | wit | 0865160000 | stuk | 71,00 | 017 | 0 |  | Toebehoren & afvoeren |
| 0315230 | | pergamon | 0865164700 | stuk | 88,00 | 017 | 1 | | |
| onderbouwwastafel | | | | | | | | | |
| 0313866 | 49x36cm | wit | 0302490000 | stuk | 160,00 | 017 | 1 |  | Badkamermeubelen en toiletkasten |
| 0313874 | 49x36cm | pergamon | 0302494700 | stuk | 192,00 | 017 | 1 | | |
| 0313882 | 49x36cm m. WG | wit | 0302490001 | stuk | 209,00 | 017 | 1 | | |
| 0313890 | 49x36cm m. WG | pergamon | 0302494701 | stuk | 241,00 | 017 | 1 | | |
| opbouw wastafel | | | | | | | | | |
| 0313815 | 56x46cm | wit | 0302560000 | stuk | 113,00 | 017 | 1 |  | Gootstenen en wastroggen |
| 0313823 | 56x46cm | pergamon | 0302564700 | stuk | 139,00 | 017 | 1 | | |
| 0313831 | 56x46cm m. WG | wit | 0302560001 | stuk | 162,00 | 017 | 1 | | |
| 0313858 | 56x46cm m. WG | pergamon | 0302564701 | stuk | 188,00 | 017 | 1 | | |
| onderbouwwastafel z. kraangat | | | | | | | | | |
| 0313904 | 49x36cm | wit | 0305490000 | stuk | 195,00 | 017 | 0 |  | Utiliteit |
| 0313912 | 49x36cm | pergamon | 0305494700 | stuk | 234,00 | 017 | 1 | | |
| 0313920 | 49x36cm m. WG | wit | 0305490001 | stuk | 244,00 | 017 | 1 | | |
| 0313939 | 49x36cm m. WG | pergamon | 0305494701 | stuk | 283,00 | 017 | 1 | | |
| halfinbouw wastafel | | | | | | | | | |
| 0316415 | 55x46cm | wit | 0310550000 | stuk | 124,00 | 017 | 1 |  | |
| 0316431 | 55x46cm | pergamon | 0310554700 | stuk | 172,00 | 017 | 1 | | |
| 0316423 | 55x46cm m. WG | wit | 0310550001 | stuk | 173,00 | 017 | 1 | | |
| 0316458 | 55x46cm m. WG | pergamon | 0310554701 | stuk | 221,00 | 017 | 1 | | |
| meubelwastafel | | | | | | | | | |
| 0313947 | 48x46.5cm | wit | 0303480000 | stuk | 152,00 | 017 | 1 |  | |
| 0313955 | 48x46.5cm | pergamon | 0303484700 | stuk | 187,00 | 017 | 1 | | |
| 0313963 | 48x46.5cm m. WG | wit | 0303480001 | stuk | 201,00 | 017 | 1 | | |
| 0313971 | 48x46.5cm m. WG | pergamon | 0303484701 | stuk | 236,00 | 017 | 1 | | |
| meubelwastafel m. achterwand | | | | | | | | | |
| 0313998 | 48x48cm | wit | 0306480000 | stuk | 183,00 | 017 | 1 |  | |
| 0314005 | 48x48cm | pergamon | 0306484700 | stuk | 226,00 | 017 | 1 | | |
| 0314013 | 48x48cm m. WG | wit | 0306480001 | stuk | 232,00 | 017 | 1 | | |
| 0314021 | 48x48cm m. WG | pergamon | 0306484701 | stuk | 275,00 | 017 | 1 | | |

| | Art.nr | Specificaties | Kleur | Lev.nr | Ehd | Prijs | Grp | CC |
|---|---|--|-------------|-------------|--------|--------|-----|----|
| Duravit Starck 3 | | | | | | | | |
| Sanitair producten | onderstel voor wastafel 030348+030648 | | | | | | | |
| | 0316407 | | chrom | 0030641000 | stuk | 228,00 | 017 | 1 |
| meubelwastafel | | | | | | | | |
| Baden / douchebakken / stoomcabines |  | 0316466 70x49cm | wit | 0304700000 | stuk | 221,00 | 017 | 1 |
| | | 0316482 70x49cm | pergamon | 0304704700 | stuk | 266,00 | 017 | 1 |
| | | 0316474 70x49cm m. WG | wit | 03047000001 | stuk | 270,00 | 017 | 1 |
| | | 0316490 70x49cm m. WG | pergamon | 03047047001 | stuk | 315,00 | 017 | 1 |
| Kranen |  | 0314080 85x48.5cm | wit | 0304800000 | stuk | 288,00 | 017 | 0 |
| | | 0314099 85x48.5cm | pergamon | 0304804700 | stuk | 354,00 | 017 | 0 |
| | | 0314102 85x48.5cm m. WG | wit | 03048000001 | stuk | 337,00 | 017 | 1 |
| | | 0314110 85x48.5cm m. WG | pergamon | 03048047001 | stuk | 403,00 | 017 | 1 |
| Douchegarnituur | | 0314048 105x48.5cm | wit | 0304100000 | stuk | 391,00 | 017 | 0 |
| | | 0314056 105x48.5cm | pergamon | 0304104700 | stuk | 481,00 | 017 | 1 |
| | | 0314064 105x48.5cm m. WG | wit | 03041000001 | stuk | 440,00 | 017 | 1 |
| | | 0314072 105x48.5cm m. WG | pergamon | 03041047001 | stuk | 530,00 | 017 | 1 |
| | | 0830097 bevestigingsset M10x110mm | | 0830097 | paar | 1,09 | 362 | 0 |
| fontein | | | | | | | | |
| Accessoires en spiegels |  | 0313602 45x32cm | wit | 0750450000 | stuk | 60,00 | 017 | 0 |
| | | 0313610 45x32cm | pergamon | 0750454700 | stuk | 73,00 | 017 | 1 |
| | | 0313629 45x32cm m. WG | wit | 07504500001 | stuk | 101,00 | 017 | 1 |
| | | 0315249 45x32cm m. WG | pergamon | 07504547001 | stuk | 122,00 | 017 | 1 |
| Douchewanden | | 0313637 45x32cm z. kraangat | wit | 0750450010 | stuk | 60,00 | 017 | 1 |
| | | 0313645 45x32cm z. kraangat | pergamon | 0750454710 | stuk | 73,00 | 017 | 1 |
| | | 0313653 45x32cm z. kraangat m. WG | wit | 07504500101 | stuk | 101,00 | 017 | 1 |
| | | 0313661 45x32cm z. kraangat m. WG | pergamon | 07504547101 | stuk | 122,00 | 017 | 1 |
| | | 0830240 bevestigingsset voor fontein M8x90mm | | 0830240 | stuk | 0,85 | 362 | 0 |
| sifonkap 2 | | | | | | | | |
| Toebehoren & afvoeren |  | 0313572 030050-075045-030160/55 | wit | 0865170000 | stuk | 68,00 | 017 | 0 |
| | | 0313580 030050-075045-030160/55 | pergamon | 0865174700 | stuk | 83,00 | 017 | 0 |
| | | 0290963 snelbevestigingsset voor sifonkap | | 0055030000 | stuk | 25,00 | 016 | 0 |
| fontein m. voorgestoken gat links/rechts | | | | | | | | |
| Badkamermeubelen en toiletkasten |  | 0313688 50x26cm | wit | 0751500000 | stuk | 67,00 | 017 | 0 |
| | | 0313696 50x26cm | pergamon | 0751504700 | stuk | 82,00 | 017 | 0 |
| | | 0313718 50x26cm m. WG | wit | 07515000001 | stuk | 116,00 | 017 | 1 |
| | | 0313726 50x26cm m. WG | pergamon | 07515047001 | stuk | 131,00 | 017 | 1 |
| Gootstenen en wastroggen | | 0830240 bevestigingsset voor fontein M8x90mm | | 0830240 | stuk | 0,85 | 362 | 0 |
| | sifonkap voor fontein 075150 | | | | | | | |
| Utiliteit |  | 0313742 | wit | 0865180000 | stuk | 67,00 | 017 | 0 |
| | | 0313769 | pergamon | 0865184700 | stuk | 82,00 | 017 | 1 |
| | | 0290970 snelbevestigingsset voor sifonkap | | 0055040000 | stuk | 25,00 | 016 | 0 |
| hoekfontein | | | | | | | | |
|  | 0313777 44x38.5cm | wit | 0752440000 | stuk | 76,00 | 017 | 0 | |
| | 0313785 44x38.5cm | pergamon | 0752444700 | stuk | 94,00 | 017 | 0 | |
| | 0313795 44x38.5cm m. WG | wit | 07524400001 | stuk | 125,00 | 017 | 1 | |
| | 0313807 44x38.5cm m. WG | pergamon | 07524447001 | stuk | 143,00 | 017 | 1 | |
| | 0290071 bevestigingshaak set à 2stuks | | 0050000000 | stuk | 7,00 | 017 | 0 | |
| wandclosetpot diepspoel | | | | | | | | |
|  | 0314714 | wit | 2200090000 | stuk | 175,00 | 017 | 0 | |
| | 0314722 | pergamon | 2200094700 | stuk | 215,00 | 017 | 0 | |
| | 0314730 m. WG | wit | 22000900001 | stuk | 224,00 | 017 | 0 | |
| | 0314749 m. WG | pergamon | 22000947001 | stuk | 264,00 | 017 | 1 | |
| wandclosetpot vlakspoel | | | | | | | | |
| | 0314757 | wit | 2201090000 | stuk | 227,00 | 017 | 0 | |
| | 0314762 | pergamon | 2201094700 | stuk | 279,00 | 017 | 1 | |
| | 0314773 m. WG | wit | 22010900001 | stuk | 276,00 | 017 | 1 | |
| | 0314781 m. WG | pergamon | 22010947001 | stuk | 328,00 | 017 | 1 | |

| Art.nr | Specificaties | Kleur | Lev.nr | Ehd | Prijs | Grp | CC |
|--------|---------------|-------|--------|-----|-------|-----|----|
|--------|---------------|-------|--------|-----|-------|-----|----|

Duravit Starck 3

Compact wandclosetpot diepspoel

| | | | | | | | |
|---------|-------|----------|-------------|------|--------|-----|---|
| 0314161 | | wit | 2202090000 | stuk | 185,00 | 017 | 0 |
| 0314269 | | pergamon | 2202094700 | stuk | 228,00 | 017 | 0 |
| 0314358 | m. WG | wit | 22020900001 | stuk | 234,00 | 017 | 0 |
| 0314420 | m. WG | pergamon | 22020947001 | stuk | 277,00 | 017 | 1 |



Sanitair producten

Baden /
douchebakken /
stoomcabines

Kranen

Douchegarnituur

Accessoires en
spiegels

Douchewanden

Toebehoren &
afvoerenSpoel- &
installatiesystemenBadkamermeubelen
en toiletkastenGootstenen en
wastroggen

Utiliteit

closetcombinatie diepspoel AO

| | | | | | | | |
|---------|-------|----------|---------|------|--------|-----|---|
| 0314501 | | wit | STARCK3 | stuk | 273,00 | 017 | 1 |
| 0314544 | | pergamon | STARCK3 | stuk | 335,00 | 017 | 1 |
| 0314579 | m. WG | wit | STARCK3 | stuk | 322,00 | 017 | 1 |
| 0314609 | m. WG | pergamon | STARCK3 | stuk | 384,00 | 017 | 1 |

**closetcombinatie diepspoel PK**

| | | | | | | | |
|---------|-------|----------|---------|------|--------|-----|---|
| 0314528 | | wit | STARCK3 | stuk | 263,00 | 017 | 1 |
| 0314552 | | pergamon | STARCK3 | stuk | 323,00 | 017 | 1 |
| 0314587 | m. WG | wit | STARCK3 | stuk | 312,00 | 017 | 1 |
| 0314617 | m. WG | pergamon | STARCK3 | stuk | 372,00 | 017 | 1 |

closetcombinatie diepspoel vario

| | | | | | | | |
|---------|-------|----------|---------|------|--------|-----|---|
| 0314536 | | wit | STARCK3 | stuk | 340,00 | 017 | 0 |
| 0314560 | | pergamon | STARCK3 | stuk | 418,00 | 017 | 1 |
| 0314595 | m. WG | wit | STARCK3 | stuk | 389,00 | 017 | 1 |
| 0314625 | m. WG | pergamon | STARCK3 | stuk | 467,00 | 017 | 1 |

**closetpot vlakspoel PK**

| | | | | | | | |
|---------|-------|----------|-------------|------|--------|-----|---|
| 0314196 | | wit | 0125090000 | stuk | 132,00 | 017 | 1 |
| 0314285 | | pergamon | 0125094700 | stuk | 162,00 | 017 | 1 |
| 0314374 | m. WG | wit | 01250900001 | stuk | 181,00 | 017 | 1 |
| 0314447 | m. WG | pergamon | 01250947001 | stuk | 211,00 | 017 | 1 |

**closetpot vlakspoel +10 PK**

| | | | | | | | |
|---------|-------|----------|-------------|------|--------|-----|---|
| 0314234 | | wit | 0127090000 | stuk | 227,00 | 017 | 1 |
| 0314315 | | pergamon | 0127094700 | stuk | 279,00 | 017 | 1 |
| 0314404 | m. WG | wit | 01270900001 | stuk | 276,00 | 017 | 1 |
| 0314471 | m. WG | pergamon | 01270947001 | stuk | 328,00 | 017 | 1 |

**duoblokpot diepspoel AO z. reservoir**

| | | | | | | | |
|---------|-------|----------|-------------|------|--------|-----|---|
| 0314218 | | wit | 0126010000 | stuk | 149,00 | 017 | 0 |
| 0314293 | | pergamon | 0126014700 | stuk | 183,00 | 017 | 1 |
| 0314382 | m. WG | wit | 01260100001 | stuk | 198,00 | 017 | 1 |
| 0314455 | m. WG | pergamon | 01260147001 | stuk | 232,00 | 017 | 1 |

duoblokpot diepspoel PK z. reservoir

| | | | | | | | |
|---------|-------|----------|-------------|------|--------|-----|---|
| 0314226 | | wit | 0126090000 | stuk | 139,00 | 017 | 0 |
| 0314307 | | pergamon | 0126094700 | stuk | 171,00 | 017 | 1 |
| 0314390 | m. WG | wit | 01260900001 | stuk | 188,00 | 017 | 1 |
| 0314463 | m. WG | pergamon | 01260947001 | stuk | 220,00 | 017 | 1 |







duoblokpot diepspoel vario z. reservoir

| | | | | | | | |
|---------|-------|----------|-------------|------|--------|-----|---|
| 0314242 | | wit | 0128090000 | stuk | 216,00 | 017 | 0 |
| 0314323 | | pergamon | 0128094700 | stuk | 266,00 | 017 | 1 |
| 0314412 | m. WG | wit | 01280900001 | stuk | 265,00 | 017 | 1 |
| 0314498 | m. WG | pergamon | 01280947001 | stuk | 315,00 | 017 | 1 |

duoblokreervoir + binnenwerk

| | | | | | | | |
|---------|--|----------|------------|------|--------|-----|---|
| 0314250 | | wit | 0920000005 | stuk | 124,00 | 017 | 0 |
| 0314331 | | pergamon | 0920004705 | stuk | 152,00 | 017 | 1 |



| | Art.nr | Specificaties | Kleur | Lev.nr | Ehd | Prijs | Grp | CC |
|---|---|--|----------------------------------|-------------|-------------|--------|--------|-------|
| Sanitair producten | Duravit Starck 3 | | | | | | | |
| | closetzitting dubbel | | | | | | | |
| |  | 0314994 | | wit | 0063810000 | stuk | 72,00 | 017 0 |
| | | 0315001 | | pergamon | 0063814700 | stuk | 89,00 | 017 0 |
| | | 0290272 | softclose | wit | 0063890000 | stuk | 125,00 | 017 0 |
| | 0314723 | softclose | pergamon | 63894700 | stuk | 144,00 | 017 0 | |
| Baden / douchebakken / stoomcabines | wandclosetpot diepspoel 70cm | | | | | | | |
| |  | 0290126 | | wit | 2203090000 | stuk | 345,00 | 017 1 |
| | | 0290128 | | pergamon | 2203094700 | stuk | 414,00 | 017 1 |
| | | 0290127 | m. WG | wit | 22030900001 | stuk | 394,00 | 017 1 |
| | | 0290129 | m. WG | pergamon | 22030947001 | stuk | 463,00 | 017 1 |
| Kranen | closetzitting dubbel | | | | | | | |
| | | 0290131 | Vital m. doorlopende scharnieren | wit | 62410000 | stuk | 100,00 | 017 0 |
| | | 0290132 | Vital m. doorlopende scharnieren | pergamon | 26414700 | stuk | 119,00 | 017 1 |
| | closetzitting enkel | | | | | | | |
| | | 0290133 | Vital m. doorlopende scharnieren | wit | 62610000 | stuk | 77,00 | 017 1 |
| Douchegarnituur | | 0290135 | Vital m. doorlopende scharnieren | pergamon | 62614700 | stuk | 92,00 | 017 1 |
| Accessoires en spiegels | wandbidet | | | | | | | |
| |  | 0314129 | | wit | 2230150000 | stuk | 144,00 | 017 0 |
| | | 0314137 | | pergamon | 2230154700 | stuk | 177,00 | 017 1 |
| | | 0314145 | m. WG | wit | 22301500001 | stuk | 193,00 | 017 1 |
| | | 0314153 | m. WG | pergamon | 22301547001 | stuk | 226,00 | 017 1 |
| Douchewanden | Compact wandbidet | | | | | | | |
|  | 0314633 | | wit | 2231150000 | stuk | 114,00 | 017 1 | |
| | 0314641 | | pergamon | 2231154700 | stuk | 177,00 | 017 1 | |
| | 0314668 | m. WG | wit | 22311500001 | stuk | 163,00 | 017 1 | |
| | 0314676 | m. WG | pergamon | 22311547001 | stuk | 226,00 | 017 1 | |
| Toebehoren & afvoeren | staand bidet | | | | | | | |
| |  | 0314684 | | wit | 2230100000 | stuk | 113,00 | 017 1 |
| | | 0315257 | | pergamon | 2230104700 | stuk | 139,00 | 017 1 |
| | | 0314692 | m. WG | wit | 22301000001 | stuk | 162,00 | 017 1 |
| | | 0314706 | m. WG | pergamon | 22301047001 | stuk | 188,00 | 017 1 |
| Badkamermeubelen en toiletkasten | | 0263024 | | wit | 2234100000 | stuk | 154,00 | 017 1 |
| | | 0263025 | | pergamon | 2234104700 | stuk | 190,00 | 017 1 |
| | | 0263083 | m. WG | wit | 22341000001 | stuk | 203,00 | 017 1 |
| | | 0263084 | m. WG | pergamon | 22341047001 | stuk | 237,00 | 017 1 |
| | Gootstenen en wastroggen | urinoir m. bevestiging wandinlaat | | | | | | |
|  | | 0314803 | | wit | 0821350000 | stuk | 203,00 | 017 0 |
| | | 0314811 | | pergamon | 0821354700 | stuk | 249,00 | 017 1 |
| | | 0314838 | m. WG | wit | 08213500001 | stuk | 252,00 | 017 1 |
| | | 0314846 | m. WG | pergamon | 08213547001 | stuk | 298,00 | 017 1 |
| Utiliteit | | 0314854 | m. vlieg | wit | 0821350007 | stuk | 225,00 | 017 1 |
| | | 0314862 | m. vlieg | pergamon | 0821354707 | stuk | 271,00 | 017 1 |
| | | 0314870 | m. vlieg m. WG | wit | 08213500071 | stuk | 274,00 | 017 1 |
| | | 0314889 | m. vlieg m. WG | pergamon | 08213547071 | stuk | 320,00 | 017 1 |
| | | 0293253 | urinoirsifon horizontaal | | 0050120000 | stuk | 25,50 | 017 0 |
| | | 0293261 | urinoirsifon verticaal | | 0050110000 | stuk | 25,50 | 017 0 |
| | urinoir m. bevestiging boveninlaat | | | | | | | |
| |  | 0314897 | | wit | 0822350000 | stuk | 203,00 | 017 1 |
| | | 0314900 | | pergamon | 0822354700 | stuk | 249,00 | 017 1 |
| | | 0314919 | m. WG | wit | 08223500001 | stuk | 252,00 | 017 1 |
| | | 0314927 | m. WG | pergamon | 08223547001 | stuk | 298,00 | 017 1 |
| | | 0314935 | m. vlieg | wit | 0822350007 | stuk | 225,00 | 017 1 |
| | 0314943 | m. vlieg | pergamon | 0822354707 | stuk | 271,00 | 017 1 | |
| | 0314951 | m. vlieg m. WG | wit | 08223500071 | stuk | 274,00 | 017 1 | |
| | 0314978 | m. vlieg m. WG | pergamon | 08223547071 | stuk | 320,00 | 017 1 | |
| | 0293253 | urinoirsifon horizontaal | | 0050120000 | stuk | 25,50 | 017 0 | |
| | 0293261 | urinoirsifon verticaal | | 0050110000 | stuk | 25,50 | 017 0 | |
| rooster voor urinoir | | | | | | | | |
| | 0314986 | | | 0050421000 | stuk | 34,00 | 017 1 | |

| Art.nr | Specificaties | Kleur | Lev.nr | Ehd | Prijs | Grp | CC |
|--------|---------------|-------|--------|-----|-------|-----|----|
|--------|---------------|-------|--------|-----|-------|-----|----|

Duravit Starck 3

urinoirschot

| | | | | | | | |
|---------|---------|----------|------------|------|--------|-----|---|
| 0315028 | 70x40cm | wit | 8500000000 | stuk | 164,00 | 017 | 0 |
| 0315036 | 70x40cm | pergamon | 8500004700 | stuk | 202,00 | 017 | 1 |



Sanitair producten

Baden /
douchebakken /
stoomcabines

spiegel

| | | | | | | | |
|---------|------------|----------------|----------|------|--------|-----|---|
| 0313009 | 45x107.5cm | z. verlichting | 97663200 | stuk | 237,00 | 304 | 1 |
| 0313017 | 45x107.5cm | m. verlichting | 97673200 | stuk | 574,00 | 304 | 1 |



Kranen

Douchegarnituur

XL wastafelonderbouw 3xdeuren

| | | | | | | | |
|---------|------------|----------|------------|------|--------|-----|---|
| 0315066 | 100x66.8cm | glanswit | 6084222220 | stuk | 630,00 | 304 | 1 |
| 0315176 | 100x66.8cm | berken | 6084303020 | stuk | 630,00 | 304 | 1 |
| 0315109 | 100x66.8cm | esdoorn | 6084343420 | stuk | 630,00 | 304 | 1 |
| 0315065 | 100x44.8cm | glanswit | 6085222220 | stuk | 594,00 | 304 | 1 |
| 0315184 | 100x44.8cm | berken | 6085303020 | stuk | 594,00 | 304 | 1 |
| 0315117 | 100x44.8cm | esdoorn | 6085343420 | stuk | 594,00 | 304 | 1 |

Accessoires en
spiegels

Douchewanden

XL wastafelonderbouw 2xdeuren

| | | | | | | | |
|---------|-----------|----------|------------|------|--------|-----|---|
| 0315063 | 80x66.8cm | glanswit | 6086222220 | stuk | 535,00 | 304 | 1 |
| 0315192 | 80x66.8cm | berken | 6086303020 | stuk | 535,00 | 304 | 1 |
| 0315125 | 80x66.8cm | esdoorn | 6086343420 | stuk | 535,00 | 304 | 1 |
| 0315064 | 80x44.8cm | glanswit | 6087222220 | stuk | 499,00 | 304 | 1 |
| 0315206 | 80x44.8cm | berken | 6087303020 | stuk | 499,00 | 304 | 1 |
| 0315133 | 80x44.8cm | esdoorn | 6087343420 | stuk | 499,00 | 304 | 1 |
| 0315061 | 60x66.8cm | glanswit | 6088222220 | stuk | 517,00 | 304 | 1 |
| 0315214 | 60x66.8cm | berken | 6088303020 | stuk | 517,00 | 304 | 1 |
| 0315141 | 60x66.8cm | esdoorn | 6088343420 | stuk | 517,00 | 304 | 1 |
| 0315062 | 60x44.8cm | glanswit | 6089222220 | stuk | 482,00 | 304 | 1 |
| 0315222 | 60x44.8cm | berken | 6089303020 | stuk | 482,00 | 304 | 1 |
| 0315168 | 60x44.8cm | esdoorn | 6089343420 | stuk | 482,00 | 304 | 1 |

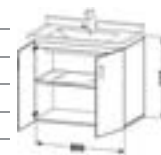
Toebehoren &
afvoerenSpoel- &
installatiesystemenBadkamermeubelen
en toiletkastenGootstenen en
wastroggen

Utiliteit

wastafelonderbouw 2xladen 1xdeur

| | | | | | | | |
|---------|---------|------|------------|------|--------|-----|---|
| 0312940 | 45x87cm | wit | 6164457700 | stuk | 514,00 | 304 | 1 |
| 0313025 | 45x87cm | blue | 6164457800 | stuk | 514,00 | 304 | 1 |



kolomkast 4xladen 2xdeuren

| | | | | | | | |
|---------|----------|------|------------|------|--------|-----|---|
| 0312967 | 45x155cm | wit | 9243457700 | stuk | 820,00 | 304 | 1 |
| 0313041 | 45x155cm | blue | 9243457800 | stuk | 820,00 | 304 | 1 |



| Art.nr | Specificaties | Kleur | Lev.nr | Ehd | Prijs | Grp | CC |
|--------|---------------|-------|--------|-----|-------|-----|----|
|--------|---------------|-------|--------|-----|-------|-----|----|

Duravit Starck 3

onderkast 2xladen m. dubbele deuren

| | | | | | | | |
|---------|---------|------|------------|------|--------|-----|---|
| 0312975 | 45x91cm | wit | 9384457700 | stuk | 432,00 | 304 | 1 |
| 0313068 | 45x91cm | blue | 9384457800 | stuk | 432,00 | 304 | 1 |



Sanitair producten

Baden /
douchebakken /
stoomcabines

onderkast 4xladen

| | | | | | | | |
|---------|---------|------|------------|------|--------|-----|---|
| 0312983 | 45x91cm | wit | 9385457700 | stuk | 455,00 | 304 | 1 |
| 0313076 | 45x91cm | blue | 9385457800 | stuk | 455,00 | 304 | 1 |

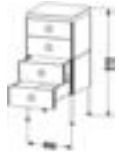

Kranen

Douchegarnituur

rolwagen 2xladen 1x deur

| | | | | | | | |
|---------|---------|------|------------|------|--------|-----|---|
| 0312991 | 45x91cm | wit | 9391457700 | stuk | 509,00 | 304 | 1 |
| 0313084 | 45x91cm | blue | 9391457800 | stuk | 509,00 | 304 | 1 |



Accessoires en
spiegels

Douchewanden

Toebehoren &
afvoeren

Spoel- &
installatiesystemen

Badkamermeubelen
en toiletkasten





Gootstenen en
wastroggen

Utiliteit



Starck X, Design by Philippe Starck

Sanitairkeramiek, badmeubelen, ligbaden, wellnessproducten en accessoires: alles wat het leven in de badkamer een beetje mooier maakt, u vindt het bij Duravit. Net als Starck X, het badkamerprogramma, dat luxe opnieuw definieert. Catalogus gratis van Duravit Nederland B.V., Ruwekampweg 2, 5222 AT's-Hertogenbosch, Phone +31 73 6131970, Fax +31 73 6100983, info@nl.duravit.com

| | Art.nr | Specificaties | Kleur | Lev.nr | Ehd | Prijs | Grp | CC | | |
|---|---|---|---|-------------|------------|---------|---------|---------|-----|---|
| Sanitair producten | Duravit Starck X | | | | | | | | | |
| |  | wastafel staand m. kom Ø40cm cylinder | | | | | | | | |
| | | 0263110 | 40x57.5cm | wit | 2300400000 | stuk | 895,00 | 015 | 1 | |
| | | 0263112 | 40x57.5cm | platina/wit | 2300403500 | stuk | 1075,00 | 015 | 1 | |
| | | 0263114 | 40x57.5cm | geel/wit | 2300408000 | stuk | 985,00 | 015 | 1 | |
| | | 0263109 | 40x57.5cm m. WG | wit | 2300400001 | stuk | 944,00 | 015 | 1 | |
| | | 0263111 | 40x57.5cm m. WG | platina/wit | 2300403501 | stuk | 1124,00 | 015 | 1 | |
| | | 0263113 | 40x57.5cm m. WG | geel/wit | 2300408001 | stuk | 1034,00 | 015 | 1 | |
| | | wastafel staand m. kom Ø49.5cm conisch | | | | | | | | |
| | | 0263108 | 49.5x59.5cm | wit | 2300500000 | stuk | 895,00 | 015 | 1 | |
| 0263107 | | 49.5x59.5cm m. WG | wit | 2300500001 | stuk | 944,00 | 015 | 1 | | |
| Baden / douchebakken / stoomcabines | wastafel wand m. kom Ø40cm cylinder | | | | | | | | | |
| |  | 0263118 | 40x57.5cm | wit | 2301400000 | stuk | 875,00 | 015 | 1 | |
| | | 0263120 | 40x57.5cm | platina/wit | 2301403500 | stuk | 1055,00 | 015 | 1 | |
| | | 0263122 | 40x57.5cm | geel/wit | 2301408000 | stuk | 965,00 | 015 | 1 | |
| | | 0263117 | 40x57.5cm m. WG | wit | 2301400001 | stuk | 924,00 | 015 | 1 | |
| | | 0263119 | 40x57.5cm m. WG | platina/wit | 2301403501 | stuk | 1104,00 | 015 | 1 | |
| | | 0263121 | 40x57.5cm m. WG | geel/wit | 2301408001 | stuk | 1014,00 | 015 | 1 | |
| | | wastafel wand m. kom Ø49.5cm conisch | | | | | | | | |
| | | 0263116 | 49.5x59.5cm | wit | 2301500000 | stuk | 875,00 | 015 | 1 | |
| | | 0263115 | 49.5x59.5cm m. WG | wit | 2301500001 | stuk | 924,00 | 015 | 1 | |
| Kranen | | wastafel | | | | | | | | |
| |  | 0263053 | 70.5x52cm z. overloop m. kraangat | wit | 2303700000 | stuk | 635,00 | 015 | 1 | |
| | | 0263103 | 70.5x52cm z. overloop m. kraangat m. WG | wit | 2303700001 | stuk | 684,00 | 015 | 1 | |
| | | 0263054 | 70.5x52cm z. overloop z. kraangat | wit | 2303700070 | stuk | 635,00 | 015 | 1 | |
| | | 0263104 | 70.5x52cm z. overloop z. kraangat m. WG | wit | 2303700071 | stuk | 684,00 | 015 | 1 | |
| | | wastafelonderbouw voor wastafel 230370 | | | | | | | | |
| | | Douchegarnituur | 0290183 | 51x69.5cm | wit | 629722 | stuk | 1900,00 | 304 | 1 |
| | | | 0290184 | 51x69.5cm | geel | 629780 | stuk | 1900,00 | 304 | 1 |
| | | | 0290185 | 51x69.5cm | platina | 629735 | stuk | 2180,00 | 304 | 1 |
| | | | 0290186 | 51x69.5cm | zwart | 629740 | stuk | 2060,00 | 304 | 1 |
| wastafel | | | | | | | | | | |
| Accessoires en spiegels | 0263055 | | 57x57cm z. overloop m. kraangat | wit | 2305570000 | stuk | 445,00 | 015 | 1 | |
| | 0263105 | | 57x57cm z. overloop m. kraangat m. WG | wit | 2305570001 | stuk | 494,00 | 015 | 1 | |
| | 0263056 | | 57x57cm z. overloop z. kraangat | wit | 2305570070 | stuk | 445,00 | 015 | 1 | |
| | 0263106 | | 57x57cm z. overloop z. kraangat m. WG | wit | 2305570071 | stuk | 494,00 | 015 | 1 | |
| | onderstel voor wastafel 230557 | | | | | | | | | |
| | Douchewanden | 0263057 | | chrom | 30491000 | stuk | 332,00 | 016 | 1 | |
| | | 0263058 | | platina | 30493500 | stuk | 839,00 | 016 | 1 | |
| | | wastafelonderbouw voor wastafel 230557 | | | | | | | | |
| | | 0290179 | 55.5x60cm | wit | 629622 | stuk | 1700,00 | 304 | 1 | |
| | | 0290180 | 55.5x60cm | geel | 629680 | stuk | 1700,00 | 304 | 1 | |
| 0290181 | | 55.5x60cm | platina | 629635 | stuk | 1990,00 | 304 | 1 | | |
| 0290182 | | 55.5x60cm | zwart | 629640 | stuk | 1850,00 | 304 | 1 | | |
| Toebehoren & afvoeren | | | | | | | | | | |
| Spoel- & installatiesystemen | | Badkamermeubelen en toiletkasten | | | | | | | | |
| | |  | Gootstenen en wastroggen | | | | | | | |
| | Utiliteit | | | | | | | | | |

| Art.nr | Specificaties | Kleur | Lev.nr | Ehd | Prijs | Grp | CC |
|-------------------------|-----------------------------------|-------------------|-------------|------|---------|-----|----|
| Duravit Starck X | | | | | | | |
| wastafel | | | | | | | |
| 0263043 | 110x57cm m. kraangat links | (L)wit/(R)wit | 2307100000 | stuk | 785,00 | 015 | 1 |
| 0263044 | 110x57cm m. kraangat links | (L)wit/(R)platina | 2307103500 | stuk | 965,00 | 015 | 1 |
| 0263045 | 110x57cm m. kraangat links | (L)wit/(R)geel | 2307108000 | stuk | 875,00 | 015 | 1 |
| 0263097 | 110x57cm m. kraangat links m. WG | (L)wit/(R)wit | 23071000001 | stuk | 834,00 | 015 | 1 |
| 0263098 | 110x57cm m. kraangat links m. WG | (L)wit/(R)platina | 23071035001 | stuk | 1014,00 | 015 | 1 |
| 0263099 | 110x57cm m. kraangat links m. WG | (L)wit/(R)geel | 23071080001 | stuk | 924,00 | 015 | 1 |
| 0263046 | 110x57cm z. kraangat links | (L)wit/(R)wit | 2307100070 | stuk | 785,00 | 015 | 1 |
| 0263047 | 110x57cm z. kraangat links | (L)wit/(R)platina | 2307103570 | stuk | 965,00 | 015 | 1 |
| 0263048 | 110x57cm z. kraangat links | (L)wit/(R)geel | 2307108070 | stuk | 875,00 | 015 | 1 |
| 0263100 | 110x57cm z. kraangat links m. WG | (L)wit/(R)wit | 23071000701 | stuk | 834,00 | 015 | 1 |
| 0263101 | 110x57cm z. kraangat links m. WG | (L)wit/(R)platina | 23071035701 | stuk | 1014,00 | 015 | 1 |
| 0263102 | 110x57cm z. kraangat links m. WG | (L)wit/(R)geel | 23071080701 | stuk | 924,00 | 015 | 1 |
| 0263037 | 110x57cm m. kraangat rechts | (R)wit/(L)wit | 2309100000 | stuk | 785,00 | 015 | 1 |
| 0263038 | 110x57cm m. kraangat rechts | (R)wit/(L)platina | 2309103500 | stuk | 965,00 | 015 | 1 |
| 0263039 | 110x57cm m. kraangat rechts | (R)wit/(L)geel | 2309108000 | stuk | 875,00 | 015 | 1 |
| 0263091 | 110x57cm m. kraangat rechts m. WG | (R)wit/(L)wit | 23091000001 | stuk | 834,00 | 015 | 1 |
| 0263092 | 110x57cm m. kraangat rechts m. WG | (R)wit/(L)platina | 23091035001 | stuk | 1014,00 | 015 | 1 |
| 0263093 | 110x57cm m. kraangat rechts m. WG | (R)wit/(L)geel | 23091080001 | stuk | 924,00 | 015 | 1 |
| 0263040 | 110x57cm z. kraangat rechts | (R)wit/(L)wit | 2309100070 | stuk | 785,00 | 015 | 1 |
| 0263041 | 110x57cm z. kraangat rechts | (R)wit/(L)platina | 2309103570 | stuk | 965,00 | 015 | 1 |
| 0263042 | 110x57cm z. kraangat rechts | (R)wit/(L)geel | 2309108070 | stuk | 875,00 | 015 | 1 |
| 0263094 | 110x57cm z. kraangat rechts m. WG | (R)wit/(L)wit | 23091000701 | stuk | 834,00 | 015 | 1 |
| 0263095 | 110x57cm z. kraangat rechts m. WG | (R)wit/(L)platina | 23091035701 | stuk | 1014,00 | 015 | 1 |
| 0263096 | 110x57cm z. kraangat rechts m. WG | (R)wit/(L)geel | 23091080701 | stuk | 924,00 | 015 | 1 |

onderstel voor wastafel 23091/23071

| | | | | | | | |
|---------|--|---------|----------|------|--------|-----|---|
| 0263049 | | chroom | 30481000 | stuk | 360,00 | 016 | 1 |
| 0263050 | | platina | 30483500 | stuk | 868,00 | 304 | 1 |

wastafelonderbouw voor wastafel 23091/23071

| | | | | | | | |
|---------|------------|---------|--------|------|---------|-----|---|
| 0290187 | 55.5x109cm | wit | 629822 | stuk | 1920,00 | 304 | 1 |
| 0290188 | 55.5x109cm | geel | 629880 | stuk | 1920,00 | 304 | 1 |
| 0290189 | 55.5x109cm | platina | 629835 | stuk | 2310,00 | 304 | 1 |
| 0290190 | 55.5x109cm | zwart | 629840 | stuk | 2120,00 | 304 | 1 |

designsifon m. muurbuis

| | | | | | | | |
|---------|--|---------|------------|------|--------|-----|---|
| 0290507 | | chroom | 0050361000 | stuk | 132,00 | 016 | 0 |
| 0263052 | | platina | 50363500 | stuk | 235,00 | 015 | 1 |

wandbidet voor zitting

| | | | | | | | |
|---------|-------|-----|-------------|------|--------|-----|---|
| 0290171 | | wit | 2260150032 | stuk | 580,00 | 015 | 1 |
| 0290172 | m. WG | wit | 22601500321 | stuk | 629,00 | 015 | 1 |

deksel voor wandbidet m. softclose

| | | | | | | | |
|---------|--|-----|------------|------|--------|-----|---|
| 0263030 | | wit | 0068210000 | stuk | 330,00 | 015 | 1 |
|---------|--|-----|------------|------|--------|-----|---|

wandbidet

| | | | | | | | |
|---------|-------|-----|-------------|------|--------|-----|---|
| 0290173 | | wit | 2260150000 | stuk | 580,00 | 015 | 1 |
| 0290174 | m. WG | wit | 22601500001 | stuk | 629,00 | 015 | 1 |

staand bidet voor zitting

| | | | | | | | |
|---------|-------|-----|-------------|------|--------|-----|---|
| 0290175 | | wit | 2270100032 | stuk | 580,00 | 015 | 1 |
| 0290176 | m. WG | wit | 22701000321 | stuk | 629,00 | 015 | 1 |



Sanitair producten

Baden /
douchebakken /
stoomcabines

Kranen

Douchegarnituur

Accessoires en
spiegels

Douchewanden

Toebehoren &
afvoerenSpoel- &
installatiesystemenBadkamermeubelen
en toiletkastenGootstenen en
wastroggen

Utiliteit

| Art.nr | Specificaties | Kleur | Lev.nr | Ehd | Prijs | Grp | CC |
|--------|---------------|-------|--------|-----|-------|-----|----|
|--------|---------------|-------|--------|-----|-------|-----|----|

Duravit Starck X

deksel voor staand bidet m. softclose

| | | | | | | | |
|---------|--|-----|----------|------|--------|-----|---|
| 0263032 | | wit | 68310000 | stuk | 360,00 | 016 | 1 |
|---------|--|-----|----------|------|--------|-----|---|

staand bidet

| | | | | | | | |
|---------|--|-----|------------|------|--------|-----|---|
| 0290177 | | wit | 2270100000 | stuk | 580,00 | 015 | 1 |
|---------|--|-----|------------|------|--------|-----|---|

| | | | | | | | |
|---------|-------|-----|-------------|------|--------|-----|---|
| 0290178 | m. WG | wit | 22701000001 | stuk | 629,00 | 015 | 1 |
|---------|-------|-----|-------------|------|--------|-----|---|



wandcloset diepspoel

| | | | | | | | |
|---------|--|-----|------------|------|--------|-----|---|
| 0263026 | | wit | 2204090000 | stuk | 765,00 | 015 | 1 |
|---------|--|-----|------------|------|--------|-----|---|

| | | | | | | | |
|---------|-------|-----|-------------|------|--------|-----|---|
| 0263085 | m. WG | wit | 22040900001 | stuk | 814,00 | 015 | 1 |
|---------|-------|-----|-------------|------|--------|-----|---|



closetzitting v. wandcloset m. softclose

| | | | | | | | |
|---------|--|-----|----------|------|--------|-----|---|
| 0263028 | | wit | 68110000 | stuk | 334,00 | 015 | 1 |
|---------|--|-----|----------|------|--------|-----|---|

duoblokpot diepspoel universeel z. reservoir

| | | | | | | | |
|---------|--|-----|------------|------|--------|-----|---|
| 0263029 | | wit | 2100090000 | stuk | 830,00 | 015 | 1 |
|---------|--|-----|------------|------|--------|-----|---|

| | | | | | | | |
|---------|-------|-----|-------------|------|--------|-----|---|
| 0263086 | m. WG | wit | 21000900001 | stuk | 879,00 | 015 | 1 |
|---------|-------|-----|-------------|------|--------|-----|---|

| | | | | | | | |
|---------|---|--|------------|------|-------|-----|---|
| 0290058 | vario aansluitset verstelbaar 20,5-24,5cm | | 8990250006 | stuk | 44,00 | 016 | 0 |
|---------|---|--|------------|------|-------|-----|---|

| | | | | | | | |
|---------|--------------------------------------|--|------------|------|-------|-----|---|
| 0293709 | vario aansluitset verstelbaar 7-18cm | | 0014220000 | stuk | 46,00 | 016 | 0 |
|---------|--------------------------------------|--|------------|------|-------|-----|---|



duoblokreservoir m. binnenwerk

| | | | | | | | |
|---------|--|-------|-----------|------|--------|-----|---|
| 0290200 | | chrom | 872600005 | stuk | 625,00 | 015 | 1 |
|---------|--|-------|-----------|------|--------|-----|---|

| | | | | | | | |
|---------|--|---------|-----------|------|--------|-----|---|
| 0290201 | | platina | 872600035 | stuk | 692,00 | 015 | 1 |
|---------|--|---------|-----------|------|--------|-----|---|

closetzitting voor duoblok m. softclose

| | | | | | | | |
|---------|--|-----|----------|------|--------|-----|---|
| 0263031 | | wit | 68010000 | stuk | 336,00 | 015 | 1 |
|---------|--|-----|----------|------|--------|-----|---|

staand closet diepspoel

| | | | | | | | |
|---------|-------------|-----|------------|------|--------|-----|---|
| 0263027 | 43.5x57.5cm | wit | 2101090000 | stuk | 725,00 | 015 | 1 |
|---------|-------------|-----|------------|------|--------|-----|---|



spiegel

| | | | | | | | |
|---------|--------------|--|------|------|---------|-----|---|
| 0290199 | 110.6x76.6cm | | 9640 | stuk | 1597,00 | 304 | 1 |
|---------|--------------|--|------|------|---------|-----|---|



kolomkast

| | | | | | | | |
|---------|---------------------|-----|---------|------|---------|-----|---|
| 0290191 | 176x50x33.5cm links | wit | 924822L | stuk | 2575,00 | 304 | 1 |
|---------|---------------------|-----|---------|------|---------|-----|---|

| | | | | | | | |
|---------|----------------------|-----|---------|------|---------|-----|---|
| 0290192 | 176x50x33.5cm rechts | wit | 924822R | stuk | 2575,00 | 304 | 1 |
|---------|----------------------|-----|---------|------|---------|-----|---|

| | | | | | | | |
|---------|---------------------|------|---------|------|---------|-----|---|
| 0290193 | 176x50x33.5cm links | geel | 924880L | stuk | 2575,00 | 304 | 1 |
|---------|---------------------|------|---------|------|---------|-----|---|

| | | | | | | | |
|---------|----------------------|------|---------|------|---------|-----|---|
| 0290194 | 176x50x33.5cm rechts | geel | 924880R | stuk | 2575,00 | 304 | 1 |
|---------|----------------------|------|---------|------|---------|-----|---|

| | | | | | | | |
|---------|---------------------|---------|---------|------|---------|-----|---|
| 0290195 | 176x50x33.5cm links | platina | 924835L | stuk | 2936,00 | 304 | 1 |
|---------|---------------------|---------|---------|------|---------|-----|---|

| | | | | | | | |
|---------|----------------------|---------|---------|------|---------|-----|---|
| 0290196 | 176x50x33.5cm rechts | platina | 924835R | stuk | 2936,00 | 304 | 1 |
|---------|----------------------|---------|---------|------|---------|-----|---|

| | | | | | | | |
|---------|---------------------|-------|---------|------|---------|-----|---|
| 0290197 | 176x50x33.5cm links | zwart | 924840L | stuk | 2730,00 | 304 | 1 |
|---------|---------------------|-------|---------|------|---------|-----|---|

| | | | | | | | |
|---------|----------------------|-------|---------|------|---------|-----|---|
| 0290198 | 176x50x33.5cm rechts | zwart | 924840R | stuk | 2730,00 | 304 | 1 |
|---------|----------------------|-------|---------|------|---------|-----|---|



Duravit Architec

wastafel z. overloop

| | | | | | | | |
|---------|-----------|-----|------------|------|--------|-----|---|
| 0297828 | 57.5x52cm | wit | 0449580000 | stuk | 266,00 | 016 | 0 |
|---------|-----------|-----|------------|------|--------|-----|---|









| | | | | | | | |
|---------|-----------------|-----|-------------|------|--------|-----|---|
| 0290244 | 57.5x52cm m. WG | wit | 04495800001 | stuk | 315,00 | 016 | 1 |
|---------|-----------------|-----|-------------|------|--------|-----|---|

| | | | | | | | |
|---------|---------------------------------|--|------------|------|-------|-----|---|
| 0299472 | Architec afvoerplug Ø75mm chrom | | 0050241000 | stuk | 50,00 | 016 | 0 |
|---------|---------------------------------|--|------------|------|-------|-----|---|

| | | | | | | | |
|---------|---------------------------------|--|------------|------|-------|-----|---|
| 0305294 | Architec afvoerplug Ø75mm satin | | 0050246500 | stuk | 69,00 | 016 | 1 |
|---------|---------------------------------|--|------------|------|-------|-----|---|

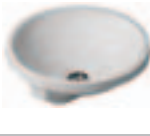
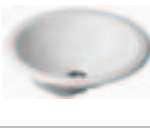
| | | | | | | | |
|---------|---------------------------|--|---------|------|------|-----|---|
| 0830097 | bevestigingsset M10x110mm | | 0830097 | paar | 1,09 | 362 | 0 |
|---------|---------------------------|--|---------|------|------|-----|---|



| Art.nr | Specificaties | Kleur | Lev.nr | Ehd | Prijs | Grp | CC | |
|---|--|--------|-------------|------|--------|-----|----|---|
| Duravit Architec | | | | | | | | |
| wastafel H70 m. kraangat links m. sifon | | | | | | | |  |
| 0315818 | 57.5x52cm | wit | 0443580000 | stuk | 283,00 | 016 | 1 | |
| 0315842 | 57.5x52cm m. WG | wit | 04435800001 | stuk | 332,00 | 016 | 1 | |
| 0315826 | afvoer voor H70 m. aansluitset | | 0050441000 | stuk | 59,00 | 016 | 1 | |
| 0315834 | afdekkap voor wastafelafvoer chroom | | 0050431000 | stuk | 36,00 | 016 | 1 | |
| 0830097 | bevestigingsset M10x110mm | | 0830097 | paar | 1,09 | 362 | 0 | |
| afdekkap voor wastafelafvoer | | | | | | | | |
| 0315834 | | chroom | 0050431000 | stuk | 36,00 | 016 | 1 | |
| afvoer voor H70 m. aansluitset | | | | | | | | |
| 0315826 | | | 0050441000 | stuk | 59,00 | 016 | 1 | |
| wastafel hoekmodel | | | | | | | |  |
| 0297836 | 45x45cm | wit | 0448450000 | stuk | 219,00 | 016 | 1 | |
| 0306908 | 45x45cm m. WG | wit | 04484500001 | stuk | 268,00 | 016 | 1 | |
| 0299472 | Architec afvoerplug Ø75mm chroom | | 0050241000 | stuk | 50,00 | 016 | 0 | |
| 0305294 | Architec afvoerplug Ø75mm satinox | | 0050246500 | stuk | 69,00 | 016 | 1 | |
| 0830097 | bevestigingsset M10x110mm | | 0830097 | paar | 1,09 | 362 | 0 | |
| ronde inbouw wastafel m. kraangat | | | | | | | |  |
| 0297844 | 43cm | wit | 0462400000 | stuk | 250,00 | 016 | 1 | |
| 0306916 | 43cm m. WG | wit | 04624000001 | stuk | 299,00 | 016 | 1 | |
| 0299472 | Architec afvoerplug Ø75mm chroom | | 0050241000 | stuk | 50,00 | 016 | 0 | |
| 0305294 | Architec afvoerplug Ø75mm satinox | | 0050246500 | stuk | 69,00 | 016 | 1 | |
| ronde inbouw wastafel z. kraangat | | | | | | | |  |
| 0297852 | 43cm | wit | 0463400000 | stuk | 231,00 | 016 | 1 | |
| 0306924 | 43cm m. WG | wit | 04634000001 | stuk | 280,00 | 016 | 1 | |
| 0299472 | Architec afvoerplug Ø75mm chroom | | 0050241000 | stuk | 50,00 | 016 | 0 | |
| 0305294 | Architec afvoerplug Ø75mm satinox | | 0050246500 | stuk | 69,00 | 016 | 1 | |
| onderbouw wastafel m. overloop z. kraangat | | | | | | | |  |
| 0298760 | 43cm | wit | 0468400000 | stuk | 262,00 | 016 | 0 | |
| 0290165 | 43cm m. WG | wit | 04684000001 | stuk | 311,00 | 016 | 1 | |
| opbouw wastafel m. overloop z. kraangat | | | | | | | |  |
| 0298180 | 47cm | wit | 0468470000 | stuk | 262,00 | 016 | 1 | |
| 0290166 | 47cm m. WG | wit | 04684700001 | stuk | 311,00 | 016 | 1 | |
| Vanity opbouw wastafel z. overloop | | | | | | | |  |
| 0263014 | 40cm | wit | 318400000 | stuk | 159,00 | 016 | 1 | |
| 0263074 | 40cm m. WG | wit | 3184000001 | stuk | 208,00 | 016 | 1 | |
| 0263013 | 45cm | wit | 318450000 | stuk | 179,00 | 016 | 1 | |
| 0263073 | 45cm m. WG | wit | 3184500001 | stuk | 228,00 | 016 | 1 | |
| 0263012 | 50cm | wit | 318500000 | stuk | 199,00 | 016 | 1 | |
| 0263072 | 50cm m. WG | wit | 3185000001 | stuk | 248,00 | 016 | 1 | |
| 0316393 | Vital Med afvoerventiel 80mm voor wastafel | | 0050381000 | stuk | 50,00 | 017 | 1 | |
| Vanity onderbouw wastafel m. overloop | | | | | | | |  |
| 0263019 | 27.5cm m. bevestiging | wit | 319270000 | stuk | 159,00 | 016 | 1 | |
| 0263078 | 27.5cm m. bevestiging m. WG | wit | 3192700001 | stuk | 208,00 | 016 | 1 | |
| 0263018 | 32.5cm m. bevestiging | wit | 319320000 | stuk | 179,00 | 016 | 1 | |
| 0263077 | 32.5cm m. bevestiging m. WG | wit | 3193200001 | stuk | 228,00 | 016 | 1 | |
| 0315366 | push-open ventiel | | 0050521000 | stuk | 49,00 | 016 | 1 | |
| Vanity onderbouw wastafel z. overloop | | | | | | | |  |
| 0263017 | 37.5cm m. bevestiging | wit | 319370000 | stuk | 199,00 | 016 | 1 | |
| 0263076 | 37.5cm m. bevestiging m. WG | wit | 3193700001 | stuk | 248,00 | 016 | 1 | |
| 0263016 | 42cm m. bevestiging | wit | 319420000 | stuk | 209,00 | 016 | 1 | |
| 0263075 | 42cm m. bevestiging m. WG | wit | 3194200001 | stuk | 258,00 | 016 | 1 | |
| 0316393 | Vital Med afvoerventiel 80mm voor wastafel | | 0050381000 | stuk | 50,00 | 017 | 1 | |

Sanitair producten

Baden /
douchebakken /
stoomcabines

Kranen

Douchegarnituur

Accessoires en
spiegels

Douchewanden

Toebehoren &
afvoerenSpoel- &
installatiesystemenBadkamermeubelen
en toiletkastenGootstenen en
wastroggen

Utiliteit

| Art.nr | Specificaties | Kleur | Lev.nr | Ehd | Prijs | Grp | CC |
|--------|---------------|-------|--------|-----|-------|-----|----|
|--------|---------------|-------|--------|-----|-------|-----|----|

Duravit Architec

opbouwastafel m. plug m. overloop

| | | | | | | | |
|---|--------------------------------------|-----|------------|------|--------|-----|---|
|  | 0263023 40x40cm m. bevestiging | wit | 320400000 | stuk | 205,00 | 016 | 1 |
| | 0263082 40x40cm m. bevestiging m. WG | wit | 320400001 | stuk | 254,00 | 016 | 1 |
| | 0263022 42x42cm m. bevestiging | wit | 320420000 | stuk | 215,00 | 016 | 1 |
| | 0263081 42x42cm m. bevestiging m. WG | wit | 320420001 | stuk | 264,00 | 016 | 1 |
| | 0315366 push-open ventiel | | 0050521000 | stuk | 49,00 | 016 | 1 |

opbouwastafel m. plug z. overloop

| | | | | | | | |
|---|--|-----|------------|------|--------|-----|---|
|  | 0263021 45x45cm m. bevestiging | wit | 320450000 | stuk | 225,00 | 016 | 1 |
| | 0263080 45x45cm m. bevestiging m. WG | wit | 320450001 | stuk | 274,00 | 016 | 1 |
| | 0263020 50x50cm m. bevestiging | wit | 320500000 | stuk | 235,00 | 016 | 1 |
| | 0263079 50x50cm m. bevestiging m. WG | wit | 320500001 | stuk | 284,00 | 016 | 1 |
| | 0316393 Vital Med afvoerventiel 80mm voor wastafel | | 0050381000 | stuk | 50,00 | 017 | 1 |

planchet

| | | | | | | | |
|---|--|-----|------------|------|-------|-----|---|
|  | 0297895 45x23cm | wit | 0903450000 | stuk | 74,00 | 016 | 1 |
| | 0830453 set potschroeven 5.5x60mm chroom | | 0830453 | stuk | 2,28 | 362 | 0 |

fontein z. overloop

| | | | | | | | |
|--|--|-----|-------------|------|--------|-----|---|
|  | 0297860 36x38cm | wit | 0766350000 | stuk | 140,00 | 016 | 0 |
| | 0306932 36x38cm m. WG | wit | 07663500001 | stuk | 189,00 | 016 | 1 |
| | 0299472 Architec afvoerplug Ø75mm chroom | | 0050241000 | stuk | 50,00 | 016 | 0 |
| | 0305294 Architec afvoerplug Ø75mm satinox | | 0050246500 | stuk | 69,00 | 016 | 1 |
| | 0830240 bevestigingsset voor fontein M8x90mm | | 0830240 | stuk | 0,85 | 362 | 0 |

fontein diagonaal rechts

| | | | | | | | |
|---|---|-----|-------------|------|--------|-----|---|
|  | 0297887 64.5x41cm | wit | 0765650000 | stuk | 227,00 | 016 | 1 |
| | 0306940 64.5x41cm m. WG | wit | 07656500001 | stuk | 276,00 | 016 | 1 |
| | 0299472 Architec afvoerplug Ø75mm chroom | | 0050241000 | stuk | 50,00 | 016 | 0 |
| | 0299480 Architec muurbuis chroom 5/4" m. bocht 32mm | | 0050251000 | stuk | 9,00 | 016 | 1 |
| | 0305294 Architec afvoerplug Ø75mm satinox | | 0050246500 | stuk | 69,00 | 016 | 1 |
| | 0830097 bevestigingsset M10x110mm | | 0830097 | paar | 1,09 | 362 | 0 |

fontein diagonaal links

| | | | | | | | |
|---|---|-----|-------------|------|--------|-----|---|
|  | 0297879 64.5x41cm | wit | 0764650000 | stuk | 227,00 | 016 | 1 |
| | 0306959 64.5x41cm m. WG | wit | 07646500001 | stuk | 276,00 | 016 | 1 |
| | 0299472 Architec afvoerplug Ø75mm chroom | | 0050241000 | stuk | 50,00 | 016 | 0 |
| | 0299480 Architec muurbuis chroom 5/4" m. bocht 32mm | | 0050251000 | stuk | 9,00 | 016 | 1 |
| | 0305294 Architec afvoerplug Ø75mm satinox | | 0050246500 | stuk | 69,00 | 016 | 1 |
| | 0830097 bevestigingsset M10x110mm | | 0830097 | paar | 1,09 | 362 | 0 |

wandclosetpot diepspoel 70cm

| | | | | | | | |
|---|---------------|-----|-------------|------|--------|-----|---|
|  | 0297909 | wit | 0190090000 | stuk | 446,00 | 016 | 0 |
| | 0306967 m. WG | wit | 01900900001 | stuk | 495,00 | 016 | 1 |

closetzitting dubbel

| | | | | | | | |
|---|-----------------------------------|-----|--------------|------|-------|-----|---|
|  | 0297380 Darling/Duraplus/Architec | wit | B4C101E0102Y | stuk | 38,75 | 016 | 0 |
|---|-----------------------------------|-----|--------------|------|-------|-----|---|

closetzitting m. deksel m. verhoogde steunen

| | | | | | | | |
|--|---------|-----|----------|------|-------|-----|---|
| | 0290257 | wit | 62810000 | stuk | 99,00 | 016 | 1 |
|--|---------|-----|----------|------|-------|-----|---|

Duravit Bacino

waskom rond

| | | | | | | | |
|---|---------------------------------|-----|-------------|------|--------|-----|---|
|  | 0299925 42cm | wit | 0325420000 | stuk | 333,00 | 016 | 0 |
| | 0299929 42cm m. WG | wit | 03254200001 | stuk | 382,00 | 016 | 1 |
| | 0290509 kniehevelventiel chroom | | 0050311000 | stuk | 55,00 | 016 | 0 |

| Art.nr | Specificaties | Kleur | Lev.nr | Ehd | Prijs | Grp | CC |
|--------|---------------|-------|--------|-----|-------|-----|----|
|--------|---------------|-------|--------|-----|-------|-----|----|

Duravit Bacino

waskom vierkant

| | | | | | | | |
|---------|-------------------------|-----|------------|------|--------|-----|---|
| 0291325 | 42x42cm | wit | 333420000 | stuk | 262,00 | 016 | 1 |
| 0291326 | 42x42cm m. WG | wit | 3334200001 | stuk | 311,00 | 016 | 1 |
| 0290509 | kniehevelventiel chroom | | 0050311000 | stuk | 55,00 | 016 | 0 |

waskom rechthoekig

| | | | | | | | |
|---------|-------------------------|-----|------------|------|--------|-----|---|
| 0291327 | 55x42cm | wit | 334520000 | stuk | 335,00 | 016 | 1 |
| 0291328 | 55x42cm m. WG | wit | 3345200001 | stuk | 384,00 | 016 | 1 |
| 0290509 | kniehevelventiel chroom | | 0050311000 | stuk | 55,00 | 016 | 0 |

Duravit Bali

opbouw wastafel

| | | | | | | | |
|---------|--------|-----|------------|------|--------|-----|---|
| 0294130 | 33.5cm | wit | 0473340000 | stuk | 119,00 | 016 | 1 |
|---------|--------|-----|------------|------|--------|-----|---|



Duravit Bambi

kinderclosetpot vlakspoel PK

| | | | | | | | |
|---------|----------------------------------|-----|------------|------|--------|-----|---|
| 0316121 | | wit | 0106090000 | stuk | 183,00 | 017 | 1 |
| 0830453 | set potschroeven 5.5x60mm chroom | | 0830453 | stuk | 2,28 | 362 | 0 |

**closetzitting**

| | | | | | | | |
|---------|--|-----|------------|------|-------|-----|---|
| 0316148 | | wit | 0065700000 | stuk | 87,00 | 017 | 1 |
|---------|--|-----|------------|------|-------|-----|---|

kinderwandclosetpot diepspoel

| | | | | | | | |
|---------|-------|-----|-------------|------|--------|-----|---|
| 0292078 | | wit | 0185090000 | stuk | 251,00 | 017 | 1 |
| 0290161 | m. WG | wit | 01850900001 | stuk | 300,00 | 016 | 1 |



Duravit Bora

fontein

| | | | | | | | |
|---------|--------------------------------------|----------|-------------|------|--------|-----|---|
| 0299845 | 50x22cm | wit | 3161500000 | stuk | 60,00 | 016 | 1 |
| 0299846 | 50x22cm | pergamon | 3161504700 | stuk | 82,00 | 016 | 1 |
| 0307769 | 50x22cm m. WG | wit | 31615000001 | stuk | 109,00 | 016 | 1 |
| 0307777 | 50x22cm m. WG | pergamon | 31615047001 | stuk | 131,00 | 016 | 1 |
| 0830240 | bevestigingsset voor fontein M8x90mm | | 0830240 | stuk | 0,85 | 362 | 0 |



Duravit Ciottolo

waskom z. overloop m. plug

| | | | | | | | |
|---------|-------------------------------|---------|------------|------|--------|-----|---|
| 0263033 | 50cm | wit | 322500000 | stuk | 520,00 | 016 | 1 |
| 0263034 | 50cm | platina | 322503500 | stuk | 700,00 | 016 | 1 |
| 0263087 | 50cm m. WG | wit | 3225000001 | stuk | 569,00 | 016 | 1 |
| 0263088 | 50cm m. WG | platina | 3225035001 | stuk | 749,00 | 016 | 1 |
| 0263036 | sifon voor waskom 5/4" chroom | | 50540000 | stuk | 26,00 | 016 | 1 |

**waskom hoog z. overloop m. plug**

| | | | | | | | |
|---------|-------------------------------|-----|------------|------|--------|-----|---|
| 0263035 | 46x34cm | wit | 323470000 | stuk | 535,00 | 016 | 1 |
| 0263089 | 46x34cm m. WG | wit | 3234700001 | stuk | 584,00 | 016 | 1 |
| 0263036 | sifon voor waskom 5/4" chroom | | 50540000 | stuk | 26,00 | 016 | 1 |

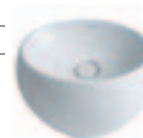
**wastafel kei z. overloop m. plug**

| | | | | | | | |
|---------|-------------------------------|-----|------------|------|--------|-----|---|
| 0263071 | 87x53cm | wit | 324880000 | stuk | 655,00 | 016 | 1 |
| 0263090 | 87x53cm m. WG | wit | 3248800001 | stuk | 704,00 | 016 | 1 |
| 0263036 | sifon voor waskom 5/4" chroom | | 50540000 | stuk | 26,00 | 016 | 1 |

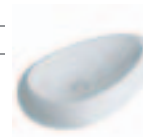
**sifon voor waskom 5/4"**

| | | | | | | | |
|---------|--|--------|----------|------|-------|-----|---|
| 0263036 | | chroom | 50540000 | stuk | 26,00 | 016 | 1 |
|---------|--|--------|----------|------|-------|-----|---|

Sanitair producten

Baden /
douchebakken /
stoomcabines

Kranen

Douchegarnituur

Accessoires en
spiegels

Douchewanden

Toebehoren &
afvoerenSpoel- &
installatiesystemenBadkamermeubelen
en toiletkastenGootstenen en
wastroggen

Utiliteit

| Art.nr | Specificaties | Kleur | Lev.nr | Ehd | Prijs | Grp | CC |
|--------|---------------|-------|--------|-----|-------|-----|----|
|--------|---------------|-------|--------|-----|-------|-----|----|

Duravit Ciottolo

spiegel m. licht

| | | | | | | | |
|---------|----------|-------------|--------|------|--------|-----|---|
| 0263130 | 50x80cm | palissander | 962246 | stuk | 436,00 | 016 | 1 |
| 0263128 | 50x80cm | berken | 962294 | stuk | 436,00 | 016 | 1 |
| 0263131 | 100x80cm | palissander | 962346 | stuk | 500,00 | 016 | 1 |
| 0263129 | 100x80cm | berken | 962394 | stuk | 500,00 | 016 | 1 |



Sanitair producten

Baden /
douchebakken /
stoomcabines

Kranen

Douchegarnituur

Accessoires en
spiegels

Douchewanden

Toebehoren &
afvoeren

Spoel- &
installatiesystemen

Badkamermeubelen
en toiletkasten

Gootstenen en
wastroggen

Utiliteit

Duravit Duravital

duoblokpot diepspoel PK +8cm z. reservoir

| | | | | | | | |
|---------|-------------------------------|-------|-------------|------|--------|-----|---|
| 0304117 | | wit | 0230090000 | stuk | 243,00 | 017 | 1 |
| 0290164 | m. WG | wit | 02300900001 | stuk | 292,00 | 016 | 1 |
| 0303585 | duoblokreservoir + binnenwerk | wit | 0879200001 | stuk | 120,00 | 017 | 0 |
| 0830453 | set potschroeven 5.5x60mm | chrom | 0830453 | stuk | 2,28 | 362 | 0 |



Duravit Fizz

urinoir achterinlaat m. bevestiging

| | | | | | | | |
|---------|--------------------------|----------|------------|------|--------|-----|---|
| 0290136 | | wit | 823360000 | stuk | 240,00 | 016 | 1 |
| 0290138 | | pergamon | 823364700 | stuk | 275,00 | 016 | 1 |
| 0290137 | m. WG | wit | 8236600001 | stuk | 289,00 | 016 | 1 |
| 0290139 | m. WG | pergamon | 8233647001 | stuk | 324,00 | 016 | 1 |
| 0293253 | urinoirsifon horizontaal | | 0050120000 | stuk | 25,50 | 017 | 0 |



urinoir voor deksel m. bevestigingsset

| | | | | | | | |
|---------|-------|----------|------------|------|--------|-----|---|
| 0290140 | | wit | 823350000 | stuk | 261,00 | 016 | 1 |
| 0290142 | | pergamon | 823354700 | stuk | 313,00 | 016 | 1 |
| 0290141 | m. WG | wit | 8233500001 | stuk | 310,00 | 016 | 1 |
| 0290143 | m. WG | pergamon | 8233547001 | stuk | 362,00 | 016 | 1 |



deksel voor urinoir

| | | | | | | | |
|---------|--|----------|----------|------|--------|-----|---|
| 0290144 | | wit | 61310000 | stuk | 101,00 | 016 | 1 |
| 0290145 | | pergamon | 61314700 | stuk | 122,00 | 016 | 1 |

Duravit Gamba

fontein

| | | | | | | | |
|---------|--------------------------------------|-----------|------------|------|-------|-----|---|
| 0299836 | 36x24cm | wit | 3160360000 | stuk | 37,25 | 017 | 0 |
| 0299837 | 36x24cm | pergamon | 3160361400 | stuk | 48,75 | 017 | 0 |
| 0291633 | 36x24cm | beige | 3160364100 | stuk | 79,00 | 017 | 1 |
| 0299838 | 36x24cm | manhattan | 3160361100 | stuk | 47,33 | 017 | 0 |
| 0299839 | 36x24cm | edelweiss | 3160367800 | stuk | 58,95 | 017 | 0 |
| 0830240 | bevestigingsset voor fontein M8x90mm | | 0830240 | stuk | 0,85 | 362 | 0 |



Duravit Hornberg

wandclosetpot diepspoel

| | | | | | | | |
|---------|-------|-----------|-------------|------|--------|-----|---|
| 0295450 | | wit | 0192090000 | stuk | 145,00 | 017 | 0 |
| 0299421 | | pergamon | 0192094700 | stuk | 189,00 | 017 | 0 |
| 0299405 | | manhattan | 0192091100 | stuk | 189,00 | 017 | 1 |
| 0295452 | m. WG | wit | 01920900001 | stuk | 193,00 | 017 | 0 |
| 0295454 | m. WG | pergamon | 01920947001 | stuk | 236,00 | 017 | 1 |



Duravit McDry

urinoir watervrij

| | | | | | | | |
|---------|---------------------------|----------|------------|------|--------|-----|---|
| 0315680 | 36.5x71cm | wit | 0844360000 | stuk | 520,00 | 016 | 1 |
| 0315699 | 36.5x71cm | m. vlieg | 0844360007 | stuk | 542,00 | 016 | 1 |
| 0830097 | bevestigingsset M10x110mm | | 0830097 | paar | 1,09 | 362 | 0 |



| Art.nr | Specificaties | Kleur | Lev.nr | Ehd | Prijs | Grp | CC |
|--------|---------------|-------|--------|-----|-------|-----|----|
|--------|---------------|-------|--------|-----|-------|-----|----|

Duravit Med

wastafel

| | | | | | | | |
|---------|-----------------------------------|-----|------------|------|-------|-----|---|
| 0303690 | 50x38,5cm z. overloop m. kraangat | wit | 0346500000 | stuk | 85,00 | 017 | 1 |
| 0303704 | 50x38,5cm z. overloop z. kraangat | wit | 0346500000 | stuk | 85,00 | 017 | 1 |
| 0830097 | bevestigingsset M10x110mm | | 0830097 | paar | 1,09 | 362 | 0 |



Sanitair producten

Duravit Med-Compact

wastafel

| | | | | | | | |
|---------|-----------------------------------|-----|------------|------|--------|-----|---|
| 0303747 | 55x39,5cm z. overloop z. kraangat | wit | 0356550000 | stuk | 86,00 | 017 | 1 |
| 0303798 | 60x43,5cm z. overloop z. kraangat | wit | 0356600000 | stuk | 96,00 | 017 | 1 |
| 0303771 | 60x43,5cm z. overloop m. kraangat | wit | 0356600000 | stuk | 96,00 | 017 | 1 |
| 0303844 | 65x47cm z. overloop z. kraangat | wit | 0356650000 | stuk | 125,00 | 017 | 1 |
| 0830097 | bevestigingsset M10x110mm | | 0830097 | paar | 1,09 | 362 | 0 |

Baden /
douchebakken /
stoomcabines

Kranen

fontein

| | | | | | | | |
|---------|--------------------------------------|-----|------------|------|-------|-----|---|
| 0303909 | 45x31cm z. overloop z. kraangat | wit | 0799450000 | stuk | 71,00 | 017 | 1 |
| 0830240 | bevestigingsset voor fontein M8x90mm | | 0830240 | stuk | 0,85 | 362 | 0 |



Douchegarnituur

Duravit Minera

meubelwastafel m. clou

| | | | | | | | |
|---------|---------------------------|-----|------------|------|---------|-----|---|
| 0315540 | 80x52cm | wit | 0350800000 | stuk | 911,00 | 016 | 1 |
| 0315559 | 100x52cm | wit | 0350100000 | stuk | 782,00 | 016 | 1 |
| 0315567 | 140x52cm | wit | 0350140000 | stuk | 1220,00 | 016 | 1 |
| 0315575 | 160x52cm | wit | 0350160000 | stuk | 1347,00 | 016 | 1 |
| 0830097 | bevestigingsset M10x110mm | | 0830097 | paar | 1,09 | 362 | 0 |

Accessoires en
spiegels

Douchewanden

Toebehoren &
afvoerenSpoel- &
installatiesystemen

Duravit Ondina

wandclosetpot diepspoel PK

| | | | | | | | |
|---------|--|-----|--------------|------|--------|-----|---|
| 0316261 | | wit | 0184090091 | stuk | 139,00 | 017 | 1 |
| 0297380 | closetzitting dubbel Darling/Duraplus/Architec wit | | B4C101E0102Y | stuk | 38,75 | 016 | 0 |

Badkamermeubelen
en toiletkasten

Duravit Santosa

onderbouwwastafel m. clou

| | | | | | | | |
|---------|------------|----------|-------------|------|--------|-----|---|
| 0315613 | 51cm | wit | 0466510000 | stuk | 203,00 | 016 | 1 |
| 0315648 | 51cm | pergamon | 0466514700 | stuk | 275,00 | 016 | 1 |
| 0315621 | 51cm m. WG | wit | 04665100001 | stuk | 252,00 | 016 | 1 |
| 0315656 | 51cm m. WG | pergamon | 04665147001 | stuk | 324,00 | 016 | 1 |

Gootstenen en
wastroggen

Duravit Sudan

closetpot vlakspoel AO +10

| | | | | | | | |
|---------|----------------------------------|-----|------------|------|--------|-----|---|
| 0292082 | | wit | 0212010000 | stuk | 298,00 | 017 | 1 |
| 0830453 | set potschroeven 5.5x60mm chroom | | 0830453 | stuk | 2,28 | 362 | 0 |











Utiliteit







Duravit Triberg

hoekfontein m. kraangat

| | | | | | | | |
|---------|--------------------------------------|-----------|-------------|------|--------|-----|---|
| 0299840 | 44x38cm | wit | 0794440011 | stuk | 59,00 | 017 | 0 |
| 0299841 | 44x38cm | pergamon | 0794444711 | stuk | 76,50 | 017 | 0 |
| 0290823 | 44x38cm | beige | 0794444111 | stuk | 100,00 | 017 | 1 |
| 0299842 | 44x38cm | manhattan | 0794441111 | stuk | 100,00 | 017 | 1 |
| 0307823 | 44x38cm m. WG | wit | 07944400111 | stuk | 123,00 | 017 | 1 |
| 0307831 | 44x38cm m. WG | pergamon | 07944447111 | stuk | 149,00 | 017 | 1 |
| 0830291 | paar ophanghaken 1/2" gegalvaniseerd | | 0830291 | paar | 3,29 | 362 | 0 |



| | Art.nr | Specificaties | Kleur | Lev.nr | Ehd | Prijs | Grp | CC | | |
|---|---|---|---|-----------------------|------------|-------------|--------|--------|-----|---|
| Sanitair producten | Duravit Ben | | | | | | | | | |
| |  | urinoir achterinlaat | | | | | | | | |
| | | 0292226 | | wit | 0847370000 | stuk | 245,00 | 016 | 1 | |
| | | 0309591 | m. vlieg | wit | 0847370007 | stuk | 270,00 | 016 | 1 | |
| | | 0293253 | urinoirsifon horizontaal | | 0050120000 | stuk | 25,50 | 017 | 0 | |
| | | 0293261 | urinoirsifon verticaal | | 0050110000 | stuk | 25,50 | 017 | 0 | |
| 0830097 | | bevestigingsset M10x110mm | | 0830097 | paar | 1,09 | 362 | 0 | | |
| Baden / douchebakken / stoomcabines | urinoir boveninlaat | | | | | | | | | |
| | 0303910 | | wit | 0848370000 | stuk | 245,00 | 016 | 1 | | |
| | 0293253 | urinoirsifon horizontaal | | 0050120000 | stuk | 25,50 | 017 | 0 | | |
| | 0293261 | urinoirsifon verticaal | | 0050110000 | stuk | 25,50 | 017 | 0 | | |
| | 0830097 | bevestigingsset M10x110mm | | 0830097 | paar | 1,09 | 362 | 0 | | |
| | Kranen | Duravit Bill | | | | | | | | |
|  | | urinoir achterinlaat z. sifon | | | | | | | | |
| | | 0303968 | | wit | 0851350000 | stuk | 203,00 | 016 | 1 | |
| | | 0293253 | urinoirsifon horizontaal | | 0050120000 | stuk | 25,50 | 017 | 0 | |
| | | 0293261 | urinoirsifon verticaal | | 0050110000 | stuk | 25,50 | 017 | 0 | |
| | | 0830097 | bevestigingsset M10x110mm | | 0830097 | paar | 1,09 | 362 | 0 | |
| | Douchegarnituur | Duravit Jim | | | | | | | | |
|  | | urinoir boveninlaat z. sifon | | | | | | | | |
| | | 0303941 | | wit | 0850350000 | stuk | 203,00 | 016 | 1 | |
| | | 0293253 | urinoirsifon horizontaal | | 0050120000 | stuk | 25,50 | 017 | 0 | |
| | | 0293261 | urinoirsifon verticaal | | 0050110000 | stuk | 25,50 | 017 | 0 | |
| | | 0830097 | bevestigingsset M10x110mm | | 0830097 | paar | 1,09 | 362 | 0 | |
| | Accessoires en spiegels | Duravit Katja | | | | | | | | |
|  | | urinoir achterinlaat z. sifon | | | | | | | | |
| | | 0292401 | | wit | 0832320000 | stuk | 127,00 | 016 | 1 | |
| | | 0293253 | urinoirsifon horizontaal | | 0050120000 | stuk | 25,50 | 017 | 0 | |
| | | 0293261 | urinoirsifon verticaal | | 0050110000 | stuk | 25,50 | 017 | 0 | |
| | | 0830097 | bevestigingsset M10x110mm | | 0830097 | paar | 1,09 | 362 | 0 | |
| | Douchewanden | Duravit Katja | | | | | | | | |
|  | | urinoir boveninlaat z. sifon | | | | | | | | |
| | | 0291780 | | wit | 0831320000 | stuk | 127,00 | 016 | 0 | |
| | | 0293253 | urinoirsifon horizontaal | | 0050120000 | stuk | 25,50 | 017 | 0 | |
| | | 0293261 | urinoirsifon verticaal | | 0050110000 | stuk | 25,50 | 017 | 0 | |
| | | 0830097 | bevestigingsset M10x110mm | | 0830097 | paar | 1,09 | 362 | 0 | |
| | Toebehoren & afvoeren | Duravit Katja | | | | | | | | |
|  | | urinoir boveninlaat z. sifon | | | | | | | | |
| | | 0291780 | | wit | 0831320000 | stuk | 127,00 | 016 | 0 | |
| | | 0293253 | urinoirsifon horizontaal | | 0050120000 | stuk | 25,50 | 017 | 0 | |
| | | 0293261 | urinoirsifon verticaal | | 0050110000 | stuk | 25,50 | 017 | 0 | |
| | | 0830097 | bevestigingsset M10x110mm | | 0830097 | paar | 1,09 | 362 | 0 | |
| | Spoel- & installatiesystemen | Duravit Varional | | | | | | | | |
|  | | bevestigingshaak | | | | | | | | |
| | | 0290071 | set à 2stuks | | 0050000000 | stuk | 7,00 | 017 | 0 | |
| | | Duravit Utronic | | | | | | | | |
| | |  | urinoir electronisch m. horizontale afvoer | | | | | | | |
| | | | 0305367 | m. WG voor batterijen | wit | 08303500001 | stuk | 757,00 | 016 | 1 |
| | 0293253 | | urinoirsifon horizontaal | | 0050120000 | stuk | 25,50 | 017 | 0 | |
| Badkamermeubelen en toiletkasten | Duravit Utronic | | | | | | | | | |
| |  | urinoir voor stroomaansluiting 230V | | | | | | | | |
| | | 0290146 | | wit | 830350093 | stuk | 661,00 | 016 | 1 | |
| | | 0290147 | netaansluitset voor urinoir 230V | | 50040000 | stuk | 13,00 | 016 | 1 | |
| | | 0293253 | urinoirsifon horizontaal | | 0050120000 | stuk | 25,50 | 017 | 0 | |
| | | 0314986 | rooster voor urinoir | | 0050421000 | stuk | 34,00 | 017 | 1 | |
| Gootstenen en wastroggen | | netaansluitset voor urinoir 230V | | | | | | | | |
| | 0290147 | | | 50040000 | stuk | 13,00 | 016 | 1 | | |
| Utiliteit | Duravit Utronic | | | | | | | | | |
| | netaansluitset voor urinoir 230V | | | | | | | | | |
| | 0290147 | | | 50040000 | stuk | 13,00 | 016 | 1 | | |

| Art.nr | Specificaties | Kleur | Lev.nr | Ehd | Prijs | Grp | CC | | |
|---------------------------------------|--------------------------------|--------------|----------|---------|--------|--------|-----|---|---|
| Ideal Standard Celia | | | | | | | | | |
| wastafel | | | | | | | |  | |
| 0180104 | 60x50cm | wit | K068201 | stuk | 279,00 | 023 | 1 | | |
| 0180105 | 60x50cm | pergamon | K068227 | stuk | 279,00 | 023 | 1 | | |
| 0180106 | 65x54cm | wit | K068301 | stuk | 340,00 | 023 | 1 | | |
| 0182136 | 65x54cm | pergamon | K068327 | stuk | 340,00 | 023 | 1 | | |
| 0180107 | 65x54cm | m. IdealPlus | wit | K0683MA | stuk | 392,00 | 023 | | 1 |
| 0182137 | 65x54cm | m. IdealPlus | pergamon | K0683MC | stuk | 392,00 | 023 | | 1 |
| 0180108 | 70x58cm | wit | K068401 | stuk | 366,00 | 023 | 1 | | |
| 0182138 | 70x58cm | pergamon | K068427 | stuk | 366,00 | 023 | 1 | | |
| 0180109 | 70x58cm | m. IdealPlus | wit | K0684MA | stuk | 418,00 | 023 | | 1 |
| 0182139 | 70x58cm | m. IdealPlus | pergamon | K0684MC | stuk | 418,00 | 023 | 1 | |
| 0830097 | bevestigingsset M10x110mm | | 0830097 | paar | 1,09 | 362 | 0 | | |
| sifonkap voor wastafel | | | | | | | | | |
| 0180110 | | wit | K006801 | stuk | 168,00 | 023 | 1 | | |
| 0180111 | | pergamon | K006827 | stuk | 168,00 | 023 | 1 | | |
| wastafelonderbouw 60cm m. deur | | | | | | | |  | |
| 0180113 | | eiken/beuken | K2178FN | stuk | 522,00 | 023 | 1 | | |
| 0180115 | afdekplaat voor onderbouw 62cm | wit | K603901 | stuk | 214,00 | 023 | 1 | | |
| 0182134 | afdekplaat voor onderbouw 62cm | pergamon | K603927 | stuk | 214,00 | 023 | 1 | | |
| wastafelonderbouw 60cm z. deur | | | | | | | |  | |
| 0180118 | | eiken/beuken | K2180FN | stuk | 450,00 | 023 | 1 | | |
| 0180115 | afdekplaat voor onderbouw 62cm | wit | K603901 | stuk | 214,00 | 023 | 1 | | |
| 0182134 | afdekplaat voor onderbouw 62cm | pergamon | K603927 | stuk | 214,00 | 023 | 1 | | |
| wastafelonderbouw 82cm m. deur | | | | | | | |  | |
| 0180116 | | eiken/beuken | K2179FN | stuk | 627,00 | 023 | 1 | | |
| 0180117 | afdekplaat voor onderbouw 84cm | wit | K603801 | stuk | 295,00 | 023 | 1 | | |
| 0182135 | afdekplaat voor onderbouw 84cm | pergamon | K603827 | stuk | 295,00 | 023 | 1 | | |
| wastafelonderbouw 82cm z. deur | | | | | | | |  | |
| 0180120 | | eiken/beuken | K2181FN | stuk | 543,00 | 023 | 1 | | |
| 0180117 | afdekplaat voor onderbouw 84cm | wit | K603801 | stuk | 295,00 | 023 | 1 | | |
| afdekplaat voor onderbouw 62cm | | | | | | | | | |
| 0180115 | | wit | K603901 | stuk | 214,00 | 023 | 1 | | |
| 0182134 | | pergamon | K603927 | stuk | 214,00 | 023 | 1 | | |
| afdekplaat voor onderbouw 84cm | | | | | | | | | |
| 0180117 | | wit | K603801 | stuk | 295,00 | 023 | 1 | | |
| 0182135 | | pergamon | K603827 | stuk | 295,00 | 023 | 1 | | |
| wandclosetpot diepspoel | | | | | | | |  | |
| 0180137 | | wit | K309801 | stuk | 487,00 | 023 | 1 | | |
| 0180138 | | pergamon | K309827 | stuk | 487,00 | 023 | 1 | | |
| wandbidet | | | | | | | |  | |
| 0180139 | | wit | K504801 | stuk | 477,00 | 023 | 1 | | |
| 0180140 | | pergamon | K504827 | stuk | 477,00 | 023 | 1 | | |

Sanitair producten

Baden /
douchebakken /
stoomcabines

Kranen









Douchegarnituur

Accessoires en
spiegels

Douchewanden

Toebehoren &
afvoerenSpoel- &
installatiesystemenBadkamermeubelen
en toiletkastenGootstenen en
wastroggen

Utiliteit

| | Art.nr | Specificaties | Kleur | Lev.nr | Ehd | Prijs | Grp | CC | |
|---|---|---------------|--------------------------------------|----------------|---------|--------|--------|-----|---|
| Sanitair producten | Ideal Standard Celia | | | | | | | | |
| | closetzitting dubbel | | | | | | | | |
| | 0180141 | | wit | K704601 | stuk | 110,00 | 023 | 1 | |
| | 0180142 | | pergamon | K704627 | stuk | 110,00 | 023 | 1 | |
| Baden / douchebakken / stoomcabines | Ideal Standard Esprit | | | | | | | | |
| | wastafel | | | | | | | | |
| |  | 0182923 | 61x49cm | wit | K048501 | stuk | 163,00 | 023 | 1 |
| | | 0182931 | 61x49cm | pergamon | K048527 | stuk | 163,00 | 023 | 1 |
| | | 0182958 | 65x51,5cm | wit | K048601 | stuk | 188,00 | 023 | 1 |
| Kranen | | 0182966 | 65x51,5cm | pergamon | K048627 | stuk | 188,00 | 023 | 1 |
| | | 0830097 | bevestigingsset M10x110mm | | 0830097 | paar | 1,09 | 362 | 0 |
| | wastafel dubbel | | | | | | | | |
| Douchegarnituur |  | 0182974 | 93,5x56cm | wit | K049001 | stuk | 612,00 | 023 | 1 |
| | | 0182982 | 93,5x56cm | pergamon | K049027 | stuk | 612,00 | 023 | 1 |
| | | 0830097 | bevestigingsset M10x110mm | | 0830097 | paar | 1,09 | 362 | 0 |
| Accessoires en spiegels | sifonkap voor wastafel | | | | | | | | |
| | | 0182990 | | wit | K003801 | stuk | 106,00 | 023 | 1 |
| | | 0182619 | | pergamon | K003827 | stuk | 106,00 | 023 | 1 |
| Douchewanden | fontein | | | | | | | | |
| |  | 0183008 | 50x38cm | wit | K048301 | stuk | 127,00 | 023 | 1 |
| | | 0183016 | 50x38cm | pergamon | K048327 | stuk | 127,00 | 023 | 1 |
| | | 0830240 | bevestigingsset voor fontein M8x90mm | | 0830240 | stuk | 0,85 | 362 | 0 |
| Toebehoren & afvoeren | sifonkap voor fontein | | | | | | | | |
| | | 0183024 | | wit | K003901 | stuk | 106,00 | 023 | 1 |
| | | 0183032 | | pergamon | K003927 | stuk | 106,00 | 023 | 1 |
| Spoel- & installatiesystemen | wandclosetpot diepspoel | | | | | | | | |
| |  | 0183040 | | wit | K304501 | stuk | 269,00 | 023 | 1 |
| | | 0183059 | | pergamon | K304527 | stuk | 269,00 | 023 | 1 |
| Badkamermeubelen en toiletkasten | wandbidet | | | | | | | | |
| |  | 0183067 | | wit | K502501 | stuk | 284,00 | 023 | 1 |
| | | 0183075 | | pergamon | K502527 | stuk | 284,00 | 023 | 1 |
| Gootstenen en wastroggen | closetzitting dubbel | | | | | | | | |
| | | 0183083 | | wit | K702401 | stuk | 147,00 | 023 | 1 |
| Utiliteit | | 0183091 | | pergamon | K702427 | stuk | 147,00 | 023 | 1 |
| | Ideal Standard I.Q. | | | | | | | | |
| | meubelwastafel | | | | | | | | |
| |  | 0180168 | 70x52cm | wit | K067501 | stuk | 420,00 | 023 | 1 |
| | | 0180169 | 80x52cm | wit | K067601 | stuk | 490,00 | 023 | 1 |
| | | 0180170 | 100x52cm | wit | K067701 | stuk | 544,00 | 023 | 1 |
| | | 0830097 | bevestigingsset M10x110mm | | 0830097 | paar | 1,09 | 362 | 0 |
| | meubelwastafel dubbel | | | | | | | | |
| |  | 0180171 | 130x46cm | wit | K067901 | stuk | 803,00 | 023 | 1 |
| | | 0830097 | bevestigingsset M10x110mm | | 0830097 | paar | 1,09 | 362 | 0 |
| | handdoekhouder | | | | | | | | |
| |  | 0180172 | | beuk/edelstaal | K2177BJ | stuk | 111,00 | 023 | 1 |

| Art.nr | Specificaties | Kleur | Lev.nr | Ehd | Prijs | Grp | CC | |
|---|---------------|----------------|---------|------|---------|-----|----|---|
| Ideal Standard I.O. | | | | | | | | |
| wastafelonderbouw 80cm 0180173 | | beuk/edelstaal | K2174BJ | stuk | 837,00 | 023 | 1 |  |
| wastafelonderbouw 100cm 0180174 | | beuk/edelstaal | K2175BJ | stuk | 909,00 | 023 | 1 |  |
| wastafelonderbouw 130cm voor enkele wastafel 0180175 | | beuk/edelstaal | K2176BJ | stuk | 1031,00 | 023 | 1 |  |
| wastafelonderbouw 130cm voor dubbele wastafel 0180176 | | beuk/edelstaal | K2188BJ | stuk | 1098,00 | 023 | 1 |  |
| Ideal Standard Marc Newson | | | | | | | | |
| wastafel 0180094 65x54cm | | wit | T085601 | stuk | 481,00 | 023 | 1 |  |
| 0180095 72x57cm | | wit | T085701 | stuk | 500,00 | 023 | 1 | |
| 0830097 bevestigingsset M10x110mm | | | 0830097 | paar | 1,09 | 362 | 0 | |
| sifonkap voor wastafel 0180097 | | wit | T402201 | stuk | 205,00 | 023 | 1 | |
| wandclosetpot diepspoel 0180096 | | wit | T313501 | stuk | 648,00 | 023 | 1 |  |
| wandbidet 0180098 | | wit | T505801 | stuk | 513,00 | 023 | 1 |  |
| closetzitting dubbel m. scharnieren 0180099 | | wit | T628101 | stuk | 141,00 | 023 | 1 | |
| Ideal Standard Oval | | | | | | | | |
| onderbouwwastafel 0183017 57x41cm | | wit | R410201 | stuk | 221,00 | 023 | 1 | |
| 0183018 57x41cm | | pergamon | R410227 | stuk | 221,00 | 023 | 1 | |
| bevestigingsset voor onderbouwwastafel 0183019 | | | T645567 | stuk | 6,50 | 023 | 1 | |

Sanitair producten

Baden /
douchebakken /
stoomcabines

Kranen

Douchegarnituur







Accessoires en
spiegels

Douchewanden

Toebehoren &
afvoerenSpoel- &
installatiesystemenBadkamermeubelen
en toiletkastenGootstenen en
wastroggen

Utiliteit

| | Art.nr | Specificaties | Kleur | Lev.nr | Ehd | Prijs | Grp | CC |
|---|---|--------------------------------------|----------|---------|------|--------|-----|----|
| Sanitair producten | Ideal Standard Privo | | | | | | | |
| | urinoir voor verdekte toe- en afvoer z. deksel | | | | | | | |
| | 0180177 | | wit | K553501 | stuk | 264,00 | 023 | 1 |
| | 0180178 | | pergamon | K553527 | stuk | 264,00 | 023 | 1 |
| Baden / douchebakken / stoomcabines | deksel voor urinoir | | | | | | | |
| | 0180179 | | wit | K704501 | stuk | 99,50 | 023 | 1 |
| | 0180180 | | pergamon | K704527 | stuk | 99,50 | 023 | 1 |
| Kranen | Ideal Standard San Remo | | | | | | | |
| | wastafel | | | | | | | |
| | 0182710 | 55x45cm | wit | E745001 | stuk | 78,00 | 023 | 1 |
| Douchegarnituur | 0182729 | 55x45cm | pergamon | E745027 | stuk | 78,00 | 023 | 1 |
| | 0182583 | 60x49cm | wit | E746001 | stuk | 82,50 | 023 | 0 |
| | 0182591 | 60x49cm | pergamon | E746027 | stuk | 82,50 | 023 | 0 |
| | 0182737 | 65x52cm | wit | E747001 | stuk | 111,00 | 023 | 1 |
| | 0182745 | 65x52cm | pergamon | E747027 | stuk | 111,00 | 023 | 1 |
| | 0830097 | bevestigingsset M10x110mm | | 0830097 | paar | 1,09 | 362 | 0 |
| | Accessoires en spiegels | sifonkap voor wastafel | | | | | | |
| 0182605 | | | wit | E749201 | stuk | 76,00 | 023 | 0 |
| 0182613 | | | pergamon | E749227 | stuk | 76,00 | 023 | 0 |
| Douchewanden | zuil voor wastafel | | | | | | | |
| | 0182680 | | wit | E740001 | stuk | 66,50 | 023 | 1 |
| | 0182699 | | pergamon | E740027 | stuk | 66,50 | 023 | 1 |
| Toebehoren & afvoeren | fontein | | | | | | | |
| | 0183226 | 45x36cm | wit | E742001 | stuk | 84,50 | 023 | 1 |
| | 0182702 | 45x36cm | pergamon | E742027 | stuk | 84,50 | 023 | 1 |
| Spoel- & installatiesystemen | 0830240 | bevestigingsset voor fontein M8x90mm | | 0830240 | stuk | 0,85 | 362 | 0 |
| | sifonkap voor fontein | | | | | | | |
| | 0183228 | | wit | E750201 | stuk | 63,00 | 023 | 1 |
| Badkamermeubelen en toiletkasten | 0182753 | | pergamon | E750227 | stuk | 63,00 | 023 | 1 |
| | staand bidet | | | | | | | |
| | 0182869 | | wit | R370101 | stuk | 134,00 | 023 | 1 |
| Gootstenen en wastroggen | 0182877 | | pergamon | R370127 | stuk | 134,00 | 023 | 1 |
| | 0467006 | IdealPlus | wit | R3701MA | stuk | 184,00 | 023 | 1 |
| | 0467014 | IdealPlus | pergamon | R3701MC | stuk | 184,00 | 023 | 1 |
| | 0830453 | set potschroeven 5.5x60mm chroom | | 0830453 | stuk | 2,28 | 362 | 0 |
| | wandclosetpot diepspoel | | | | | | | |
| Utiliteit | 0182621 | | wit | R340101 | stuk | 143,00 | 023 | 0 |
| | 0182648 | | pergamon | R340127 | stuk | 143,00 | 023 | 0 |
| | 0466980 | IdealPlus | wit | R3401MA | stuk | 193,00 | 023 | 1 |
| | 0466999 | IdealPlus | pergamon | R3401MC | stuk | 193,00 | 023 | 1 |
| wandclosetpot diepspoel 48cm | | | | | | | | |
| Utiliteit | 0182885 | | wit | R349301 | stuk | 158,00 | 023 | 0 |
| | 0182893 | | pergamon | R349327 | stuk | 158,00 | 023 | 0 |
| | 0467022 | IdealPlus | wit | R3493MA | stuk | 208,00 | 023 | 1 |
| | 0467030 | IdealPlus | pergamon | R3493MC | stuk | 208,00 | 023 | 1 |
| wandclosetpot diepspoel | | | | | | | | |
| Utiliteit | 0467032 | Powerflush | wit | K312201 | stuk | 257,00 | 023 | 1 |
| | 0467035 | Powerflush IdealPlus | wit | K3122MA | stuk | 309,00 | 023 | 1 |
| closetzitting m. deksel | | | | | | | | |
| Utiliteit | 0180015 | | wit | R391601 | stuk | 43,00 | 023 | 1 |
| | 0180017 | | pergamon | R391627 | stuk | 43,00 | 023 | 0 |

| Art.nr | Specificaties | Kleur | Lev.nr | Ehd | Prijs | Grp | CC | |
|---------------------------------------|---------------------------|----------|---------|------|--------|-----|----|---|
| Ideal Standard San Remo | | | | | | | | |
| closetzitting-48 m. deksel | | | | | | | | |
| 0182907 | | wit | K705401 | stuk | 43,00 | 023 | 0 | |
| 0182915 | | pergamon | K705427 | stuk | 43,00 | 023 | 0 | |
| closetcombinatie AO m. zitting | | | | | | | | |
| 0182826 | | wit | R340801 | stuk | 356,00 | 023 | 1 |  |
| 0182834 | | pergamon | R340827 | stuk | 356,00 | 023 | 1 | |
| 0830453 | set potschroeven 5.5x60mm | chroom | 0830453 | stuk | 2,28 | 362 | 0 | |
| closetcombinatie PK m. zitting | | | | | | | | |
| 0182796 | | wit | R340701 | stuk | 336,00 | 023 | 1 | |
| 0182818 | | pergamon | R340727 | stuk | 336,00 | 023 | 1 | |
| 0830453 | set potschroeven 5.5x60mm | chroom | 0830453 | stuk | 2,28 | 362 | 0 | |
| duoblokpot AO z. reservoir | | | | | | | | |
| 0182842 | | wit | R344101 | stuk | 184,00 | 023 | 1 |  |
| 0183227 | | pergamon | R344127 | stuk | 184,00 | 023 | 1 | |
| duoblokpot PK z. reservoir | | | | | | | | |
| 0182761 | | wit | R342301 | stuk | 161,00 | 023 | 1 | |
| 0182788 | | pergamon | R342327 | stuk | 161,00 | 023 | 1 | |
| duoblokreservoir + binnenwerk | | | | | | | | |
| 0182850 | | wit | R360101 | stuk | 140,00 | 023 | 1 | |
| 0183225 | | pergamon | R360127 | stuk | 140,00 | 023 | 1 | |
| Ideal Standard Sapho | | | | | | | | |
| wastafel m. handdoekhouder | | | | | | | | |
| 0182672 | 65x52cm | wit | P923901 | stuk | 275,00 | 023 | 0 |  |
| 0830097 | bevestigingsset M10x110mm | | 0830097 | paar | 1,09 | 362 | 0 | |
| sifonkap voor wastafel | | | | | | | | |
| 0182279 | | wit | P176301 | stuk | 90,00 | 023 | 1 | |
| Ideal Standard Small+ | | | | | | | | |
| wastafel | | | | | | | | |
| 0183092 | 68x42.5cm | wit | T078001 | stuk | 192,00 | 023 | 1 |  |
| hoekwastafel links | | | | | | | | |
| 0183093 | 68x42.5cm | wit | T077001 | stuk | 192,00 | 023 | 1 |  |
| hoekwastafel rechts | | | | | | | | |
| 0183094 | 68x42.5cm | wit | T076001 | stuk | 192,00 | 023 | 1 |  |
| sifonkap voor wastafel | | | | | | | | |
| 0183095 | | wit | T402001 | stuk | 105,00 | 023 | 1 | |
| handdoekhouder voor sifonkap | | | | | | | | |
| 0183096 | | RVS | T3083AA | stuk | 53,00 | 023 | 1 | |

Sanitair producten

Baden /
douchebakken /
stoomcabines

Kranen

Douchegarnituur









Accessoires en
spiegels

Douchewanden

Toebehoren &
afvoerenSpoel- &
installatiesystemenBadkamermeubelen
en toiletkastenGootstenen en
wastroggen

Utiliteit

| | Art.nr | Specificaties | Kleur | Lev.nr | Ehd | Prijs | Grp | CC | |
|--|---|---------------|---------------------------|--------------|----------|---------|--------|--------|-------|
| Sanitair producten | Ideal Standard Tonic | | | | | | | | |
| | wastafel | | | | | | | | |
| |  | 0180143 | 60x52cm | wit | K068801 | stuk | 190,00 | 023 1 | |
| | | 0180144 | 60x52cm | pergamon | K068827 | stuk | 190,00 | 023 1 | |
| | | 0180145 | 65x52cm | wit | K068901 | stuk | 204,00 | 023 1 | |
| | | 0180146 | 65x52cm | pergamon | K068927 | stuk | 204,00 | 023 1 | |
| | Baden / douchebakken / stoomcabines | | 0180147 | 70x52cm | wit | K069001 | stuk | 251,00 | 023 1 |
| | | | 0180148 | 70x52cm | pergamon | K069027 | stuk | 251,00 | 023 1 |
| | | | 0180151 | 75x55cm | wit | K069101 | stuk | 270,00 | 023 1 |
| | | | 0180152 | 75x55cm | pergamon | K069127 | stuk | 270,00 | 023 1 |
| Kranen | 0830097 bevestigingsset M10x110mm | | | 0830097 | paar | 1,09 | 362 0 | | |
| | sifonkap voor wastafel | | | | | | | | |
| | | 0180149 | | wit | K007101 | stuk | 125,00 | 023 1 | |
| | 0180150 | | pergamon | K007127 | stuk | 125,00 | 023 1 | | |
| Douchegarnituur | wastafelonderbouw 100cm m. lade | | | | | | | | |
| |  | 0180153 | | eiken/beuken | K2166FN | stuk | 686,00 | 023 1 | |
| Accessoires en spiegels | wastafelonderbouw 75cm m. lade | | | | | | | | |
| |  | 0180154 | | eiken/beuken | K2167FN | stuk | 589,00 | 023 1 | |
| Douchewanden | wastafelonderbouw 50cm m. deur | | | | | | | | |
|  | 0180155 | | eiken/beuken | K2168FN | stuk | 492,00 | 023 1 | | |
| Toebehoren & afvoeren | wandclosetpot diepspoel | | | | | | | | |
| |  | 0180156 | | wit | K310101 | stuk | 284,00 | 023 1 | |
| Badkamermeubelen en toiletkasten | | 0180157 | | pergamon | K310127 | stuk | 284,00 | 023 1 | |
| | wandbidet | | | | | | | | |
| Gootstenen en wastroggen |  | 0180158 | | wit | K505001 | stuk | 303,00 | 023 1 | |
| | | 0180159 | | pergamon | K505027 | stuk | 303,00 | 023 1 | |
| Utiliteit | closetzitting dubbel | | | | | | | | |
| | | 0180166 | | wit | K704701 | stuk | 88,00 | 023 1 | |
| | | 0180167 | | pergamon | K704727 | stuk | 88,00 | 023 1 | |
| Utiliteit | Ideal Standard Venice21 | | | | | | | | |
| | wastafel | | | | | | | | |
| |  | 0467111 | 48x54.5cm | wit | K085301 | stuk | 319,00 | 023 1 | |
| | | 0830097 | bevestigingsset M10x110mm | | 0830097 | paar | 1,09 | 362 0 | |
| | sifonkap voor wastafel | | | | | | | | |
| | 0467138 | | wit | K008401 | stuk | 124,00 | 023 1 | | |

| Art.nr | Specificaties | Kleur | Lev.nr | Ehd | Prijs | Grp | CC | |
|-------------------------------------|--------------------------------------|-------|---------|------|--------|-----|----|---|
| Ideal Standard Venice21 | | | | | | | | |
| wastafel opbouwkom 40cm | | | | | | | | |
| 0467197 | | wit | K086501 | stuk | 249,00 | 023 | 1 |  |
| meubelwastafel 80x56cm | | | | | | | | |
| 0467146 | | wit | K084301 | stuk | 417,00 | 023 | 1 |  |
| 0830097 | bevestigingsset M10x110mm | | 0830097 | paar | 1,09 | 362 | 0 | |
| meubelwastafel 100x58cm | | | | | | | | |
| 0467200 | | wit | K084401 | stuk | 482,00 | 023 | 1 |  |
| 0830097 | bevestigingsset M10x110mm | | 0830097 | paar | 1,09 | 362 | 0 | |
| fontein | | | | | | | | |
| 0180100 | 50x36cm | wit | K084001 | stuk | 200,00 | 023 | 1 |  |
| 0830240 | bevestigingsset voor fontein M8x90mm | | 0830240 | stuk | 0,85 | 362 | 0 | |
| wastafel | | | | | | | | |
| 0180101 | 60x53cm | wit | K084101 | stuk | 297,00 | 023 | 1 |  |
| 0180102 | 70x59cm | wit | K084201 | stuk | 372,00 | 023 | 1 | |
| 0830097 | bevestigingsset M10x110mm | | 0830097 | paar | 1,09 | 362 | 0 | |
| wandclosetpot diepspoel 58cm | | | | | | | | |
| 0467227 | | wit | K308401 | stuk | 443,00 | 023 | 1 |  |
| closetzitting dubbel | | | | | | | | |
| 0467235 | | wit | K703301 | stuk | 126,00 | 023 | 1 | |
| wandbidet m. kraangat | | | | | | | | |
| 0467219 | | wit | K508401 | stuk | 372,00 | 023 | 1 |  |
| urinoir z. deksel | | | | | | | | |
| 0467154 | | wit | K558401 | stuk | 382,00 | 023 | 1 |  |
| deksel voor urinoir | | | | | | | | |
| 0467189 | | wit | K703501 | stuk | 87,50 | 023 | 1 | |
| urinoirsifon horizontaal | | | | | | | | |
| 0467170 | | wit | K751501 | stuk | 37,75 | 023 | 1 | |

Sanitair producten

Baden /
douchebakken /
stoomcabines

Kranen

Douchegarnituur

Accessoires en
spiegels

Douchewanden

Toebehoren &
afvoerenSpoel- &
installatiesystemenBadkamermeubelen
en toiletkastenGootstenen en
wastroggen

Utiliteit

| | Art.nr | Specificaties | Kleur | Lev.nr | Ehd | Prijs | Grp | CC |
|---|--|--------------------------------------|----------|-----------|------|--------|-----|----|
| Sanitair producten | Ideal Standard Venice21 | | | | | | | |
| | urinoirsifon verticaal | | | | | | | |
| | 0467162 | | wit | K822367 | stuk | 43,00 | 023 | 1 |
| Baden / douchebakken / stoomcabines | Ideal Standard Washpoint | | | | | | | |
| | wandclosetpot diepspoel | | | | | | | |
| | 0467113 | | wit | R342601 | stuk | 234,00 | 023 | 1 |
| | 0467114 | | pergamon | R342627 | stuk | 234,00 | 023 | 1 |
| Kranen | closetzitting dubbel m. softclose | | | | | | | |
| | 0467115 | | wit | R392101 | stuk | 124,00 | 023 | 1 |
| | 0467116 | | pergamon | R392127 | stuk | 124,00 | 023 | 1 |
| Douchegarnituur | Ideal Standard XL | | | | | | | |
| | duoblokreservoir + binnenwerk | | | | | | | |
| | 0183369 | | wit | K402901 | stuk | 413,00 | 023 | 1 |
| Accessoires en spiegels | closetzitting m. scharnieren | | | | | | | |
| | 0180024 | | wit | T628801 | stuk | 147,00 | 023 | 1 |
| Douchewanden | Ideal Standard Universeel | | | | | | | |
| | sifonkap universeel | | | | | | | |
| | 0183363 | | chrom | K8544AA | stuk | 76,50 | 023 | 1 |
| Toebehoren & afvoeren | Ideal Standard onderdelen | | | | | | | |
| | 0466365 | universeel binnenwerk voor reservoir | | K725767 | stuk | 36,00 | 353 | 1 |
| | 0466366 | klepdichting set à 5 stuks | | A961145NU | stuk | 15,75 | 353 | 1 |
| | 0466367 | trekknop voor duoblok chrom | | A961146AA | stuk | 15,75 | 353 | 1 |
| Spoel- & installatiesystemen | | | | | | | | |
| Badkamermeubelen en toiletkasten | | | | | | | | |
| Gootstenen en wastroggen | | | | | | | | |
| Utiliteit | | | | | | | | |









Cassini.

PURE PASSIE VOOR NATUURLIJKHEID.

Met een buitengewoon design en een breed productprogramma maakt Cassini dromen van een mediterrane natuurlijkheid in individuele sfeer tot werkelijkheid: authentiek, huiselijk of onbekommerd licht. www.keramag.com

Wij creëren blijvende waarde
KERAMAG
Part of the Sanitec Group

KERAMAG Nederland BV
Stationsplein 12 B
6221 BT Maastricht
Tel. 0 43/351 12 00
Fax 0 43/351 12 90
E-Mail: info@keramag.nl

| | Art.nr | Specificaties | Kleur | Lev.nr | Ehd | Prijs | Grp | CC |
|---|---|--------------------------------------|---------------------|-----------|-----------|--------|--------|-------|
| Sanitair producten | Keramag Cassini | | | | | | | |
| | wastafel | | | | | | | |
| |  | 0082211 | 60x48cm | wit | 220260000 | stuk | 145,00 | 034 1 |
| | | 0082212 | 60x48cm m. KeraTect | wit | 220260600 | stuk | 210,00 | 034 1 |
| | | 0082213 | 68x52.5cm | wit | 220268000 | stuk | 185,00 | 034 1 |
| | 0082214 | 68x52.5cm m. KeraTect | wit | 220268600 | stuk | 250,00 | 034 1 | |
| Baden / douchebakken / stoomcabines | opbouwastafel z. kraangat z. overloop | | | | | | | |
| | 0082219 | 46cm | wit | 240246000 | stuk | 199,00 | 034 1 | |
| | 0082220 | 46cm m. KeraTect | wit | 240246600 | stuk | 264,00 | 034 1 | |
| Kranen |  | | | | | | | |
| Douchegarnituur | opbouwastafel m. relief z. kraangat z. overloop | | | | | | | |
| | 0082221 | 46cm | wit | 241246000 | stuk | 295,00 | 034 1 | |
| | 0082222 | 46cm m. KeraTect | wit | 241246600 | stuk | 360,00 | 034 1 | |
| Accessoires en spiegels | meubelwastafel | | | | | | | |
| | 0082215 | 85x52cm | wit | 122285000 | stuk | 380,00 | 034 1 | |
| | 0082216 | 85x52cm m. KeraTect | wit | 122285600 | stuk | 445,00 | 034 1 | |
| Douchewanden | | | | | | | | |
| Toebehoren & afvoeren |  | zuil voor wastafel 0082217 | wit | 292200000 | stuk | 129,00 | 034 1 | |
| Spoel- & installatiesystemen | sifonkap voor wastafel 0082218 | | | | | | | |
| |  | | wit | 292210000 | stuk | 99,00 | 034 1 | |
| Badkamermeubelen en toiletkasten | | | | | | | | |
| Gootstenen en wastroggen | fontein | | | | | | | |
| | 0082223 | 40x29cm | wit | 270240000 | stuk | 89,00 | 034 1 | |
| | 0082224 | 40x29cm m. KeraTect | wit | 270240600 | stuk | 154,00 | 034 1 | |
| Utiliteit |  | | | | | | | |
| | fontein voor 3-gats wandkraan | | | | | | | |
| | 0082225 | 46x37cm | wit | 280345000 | stuk | 260,00 | 034 1 | |
| | 0082226 | 46x37cm m. KeraTect | wit | 280345600 | stuk | 325,00 | 034 1 | |
| |  | | | | | | | |
| | staand bidet | | | | | | | |
| | 0082235 | | wit | 230210000 | stuk | 259,00 | 034 1 | |
| | 0082237 | m. KeraTect | wit | 230210600 | stuk | 324,00 | 034 1 | |
| |  | | | | | | | |

| Art.nr | Specificaties | Kleur | Lev.nr | Ehd | Prijs | Grp | CC |
|--------|---------------|-------|--------|-----|-------|-----|----|
|--------|---------------|-------|--------|-----|-------|-----|----|

Keramag Cassini

wandbidet

| | | | | | | | |
|---------|-------------|-----|-----------|------|--------|-----|---|
| 0082238 | | wit | 233210000 | stuk | 275,00 | 034 | 1 |
| 0082239 | m. KeraTect | wit | 233210600 | stuk | 340,00 | 034 | 1 |



Sanitair producten

Baden /
douchebakken /
stoomcabines

duoblokpot diepspoel universeel

| | | | | | | | |
|---------|-------------|-----|-----------|------|--------|-----|---|
| 0082227 | | wit | 200210000 | stuk | 289,00 | 034 | 1 |
| 0082229 | m. KeraTect | wit | 200210600 | stuk | 354,00 | 034 | 1 |



Kranen

Douchegarnituur

duoblokreservoir m. binnenwerk 6-liter

| | | | | | | | |
|---------|--|-----|-----------|------|--------|-----|---|
| 0082230 | | wit | 227250000 | stuk | 195,00 | 034 | 1 |
|---------|--|-----|-----------|------|--------|-----|---|

wandclosetpot diepspoel 6-liter

| | | | | | | | |
|---------|-------------|-----|-----------|------|--------|-----|---|
| 0082231 | | wit | 203210000 | stuk | 250,00 | 034 | 1 |
| 0082232 | m. KeraTect | wit | 203210600 | stuk | 315,00 | 034 | 1 |

Accessoires en
spiegels

Douchewanden

closetzitting dubbel

| | | | | | | | |
|---------|--------------|---------|-----------|------|--------|-----|---|
| 0082233 | | RVS/wit | 575200000 | stuk | 110,00 | 034 | 1 |
| 0082234 | m. softclose | RVS/wit | 575210000 | stuk | 140,00 | 034 | 1 |

Toebehoren &
afvoerenSpoel- &
installatiesystemen

Keramag Citterio

wastafel m. kraangat

| | | | | | | | |
|---------|---------------------------|-------------|-----------|------|--------|-----|---|
| 0080495 | 47x44cm | wit | 223147000 | stuk | 169,00 | 034 | 1 |
| 0080496 | 47x44cm | m. KeraTect | 223147600 | stuk | 234,00 | 034 | 1 |
| 0088633 | 52x50cm | wit | 223152000 | stuk | 176,00 | 034 | 1 |
| 0081009 | 52x50cm | m. KeraTect | 223152600 | stuk | 241,00 | 034 | 1 |
| 0830097 | bevestigingsset M10x110mm | | 0830097 | paar | 1,09 | 362 | 0 |

Badkamermeubelen
en toiletkastenGootstenen en
wastroggen

zuil voor wastafel 223152

| | | | | | | | |
|---------|--|-----|-----------|------|--------|-----|---|
| 0080507 | | wit | 293100000 | stuk | 135,00 | 034 | 1 |
|---------|--|-----|-----------|------|--------|-----|---|

wastafel z. kraangat

| | | | | | | | |
|---------|---------------------------|-------------|-----------|------|--------|-----|---|
| 0080497 | 52x39.5cm | wit | 223150000 | stuk | 185,00 | 034 | 1 |
| 0080498 | 52x39.5cm | m. KeraTect | 223150600 | stuk | 250,00 | 034 | 1 |
| 0830097 | bevestigingsset M10x110mm | | 0830097 | paar | 1,09 | 362 | 0 |

wastafel

| | | | | | | | |
|---------|---------------------------|-------------|-----------|------|--------|-----|---|
| 0088692 | 90x44cm | wit | 223190000 | stuk | 295,00 | 034 | 1 |
| 0081011 | 90x44cm | m. KeraTect | 223190600 | stuk | 360,00 | 034 | 1 |
| 0088641 | 70x50cm | wit | 223170000 | stuk | 289,00 | 034 | 0 |
| 0081010 | 70x50cm | m. KeraTect | 223170600 | stuk | 354,00 | 034 | 1 |
| 0830097 | bevestigingsset M10x110mm | | 0830097 | paar | 1,09 | 362 | 0 |



handdoekhouder voor nr. 223170

| | | | | | | | |
|---------|--|-------|-----------|------|--------|-----|---|
| 0088781 | | chrom | 500110000 | stuk | 260,00 | 034 | 0 |
|---------|--|-------|-----------|------|--------|-----|---|



Utiliteit

Keramag Citterio

onderstel voor nr. 223170

| | | | | | | | |
|---------|--|-------|-----------|------|--------|-----|---|
| 0088811 | | chrom | 500310000 | stuk | 349,00 | 034 | 1 |
|---------|--|-------|-----------|------|--------|-----|---|



Sanitair producten

Baden /
douchebakken /
stoomcabines

wastafel

| | | | | | | | | |
|---------|---------------------------|--------------------------|-----|-----------|------|--------|-----|---|
| 0088676 | 100x50cm | afleg rechts | wit | 123100000 | stuk | 435,00 | 034 | 1 |
| 0081005 | 100x50cm | afleg rechts m. KeraTect | wit | 123100600 | stuk | 500,00 | 034 | 1 |
| 0088684 | 100x50cm | afleg links | wit | 123110000 | stuk | 435,00 | 034 | 1 |
| 0081006 | 100x50cm | afleg links m. KeraTect | wit | 123110600 | stuk | 500,00 | 034 | 1 |
| 0830097 | bevestigingsset M10x110mm | | | 0830097 | paar | 1,09 | 362 | 0 |



Kranen

handdoekhouder voor nr. 123100 + 123110

| | | | | | | | |
|---------|--|-------|-----------|------|--------|-----|---|
| 0088773 | | chrom | 500100000 | stuk | 270,00 | 034 | 1 |
|---------|--|-------|-----------|------|--------|-----|---|



Douchegarnituur

Accessoires en
spiegels

onderstel voor nr. 123100 + 123110

| | | | | | | | |
|---------|--|-------|-----------|------|--------|-----|---|
| 0088803 | | chrom | 500300000 | stuk | 359,00 | 034 | 1 |
|---------|--|-------|-----------|------|--------|-----|---|



Douchewanden

Toebehoren &
afvoeren

wastafel m. afleg rechts

| | | | | | | | | |
|---------|---------|-------------|-----|-----------|------|--------|-----|---|
| 0080499 | 70x44cm | | wit | 123170000 | stuk | 239,00 | 034 | 1 |
| 0080500 | 70x44cm | m. KeraTect | wit | 123170600 | stuk | 304,00 | 034 | 1 |

wastafel m. afleg links

| | | | | | | | | |
|---------|---------|-------------|-----|-----------|------|--------|-----|---|
| 0080501 | 70x40cm | | wit | 123175000 | stuk | 239,00 | 034 | 1 |
| 0080502 | 70x40cm | m. KeraTect | wit | 123175600 | stuk | 304,00 | 034 | 1 |

handdoekhouder voor wastafel 123170 - 123175

| | | | | | | | |
|---------|--|-------|-----------|------|--------|-----|---|
| 0080514 | | chrom | 500120000 | stuk | 219,00 | 034 | 1 |
|---------|--|-------|-----------|------|--------|-----|---|

Spoel- &
installatiesystemen

Badkamermeubelen
en toiletkasten

wastafel m. afleg rechts

| | | | | | | | | |
|---------|---------|-------------|-----|-----------|------|--------|-----|---|
| 0080503 | 90x44cm | | wit | 123190000 | stuk | 295,00 | 034 | 1 |
| 0080504 | 90x44cm | m. KeraTect | wit | 123190600 | stuk | 360,00 | 034 | 1 |

wastafel m. afleg links

| | | | | | | | | |
|---------|---------|-------------|-----|-----------|------|--------|-----|---|
| 0080505 | 90x44cm | | wit | 123195000 | stuk | 295,00 | 034 | 1 |
| 0080506 | 90x44cm | m. KeraTect | wit | 123195600 | stuk | 360,00 | 034 | 1 |

handdoekhouder voor wastafel 123190 - 123195

| | | | | | | | |
|---------|--|-------|-----------|------|--------|-----|---|
| 0080515 | | chrom | 500130000 | stuk | 229,00 | 034 | 1 |
|---------|--|-------|-----------|------|--------|-----|---|

Gootstenen en
wastroggen

Utiliteit

opbouwastafel m. kraanplateau

| | | | | | | | | |
|---------|---------------------------|-------------|-----|-----------|------|--------|-----|---|
| 0088714 | 52x50cm | | wit | 243152000 | stuk | 239,00 | 034 | 1 |
| 0081014 | 52x50cm | m. KeraTect | wit | 243152600 | stuk | 304,00 | 034 | 1 |
| 0830097 | bevestigingsset M10x110mm | | | 0830097 | paar | 1,09 | 362 | 0 |



wastafelonderkast voor nr. 243152

| | | | | | | | |
|---------|--|-------|-----------|------|--------|-----|---|
| 0088765 | | eiken | 830010000 | stuk | 655,00 | 034 | 1 |
|---------|--|-------|-----------|------|--------|-----|---|



hoekwastafel

| | | | | | | | | |
|---------|--------------------------------------|-------------|-----|-----------|------|--------|-----|---|
| 0088668 | 49.5cm | | wit | 223149000 | stuk | 239,00 | 034 | 1 |
| 0081008 | 49.5cm | m. KeraTect | wit | 223149600 | stuk | 304,00 | 034 | 1 |
| 0830240 | bevestigingsset voor fontein M8x90mm | | | 0830240 | stuk | 0,85 | 362 | 0 |



| Art.nr | Specificaties | Kleur | Lev.nr | Ehd | Prijs | Grp | CC |
|--------|---------------|-------|--------|-----|-------|-----|----|
|--------|---------------|-------|--------|-----|-------|-----|----|

Keramag Citterio

staand wandcloset diepspoel m. vloerbevestiging

| | | | | | | | |
|---------|---|-----|-----------|------|--------|-----|---|
| 0080508 | | wit | 212100000 | stuk | 299,00 | 034 | 1 |
| 0080509 | m. KeraTect | wit | 212100600 | stuk | 364,00 | 034 | 1 |
| 0082821 | afvoerset voor closetcombinatie multi SV/PK | | 521180000 | stuk | 64,00 | 034 | 1 |

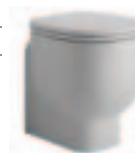

Sanitair producten

Baden /
douchebakken /
stoomcabines

wandclosetpot diepspoel 6 liter

| | | | | | | | |
|---------|-------------|-----|-----------|------|--------|-----|---|
| 0088722 | | wit | 202100000 | stuk | 275,00 | 034 | 0 |
| 0081007 | m. KeraTect | wit | 202100600 | stuk | 340,00 | 034 | 1 |



Kranen

Douchegarnituur

closetzitting dubbel

| | | | | | | | |
|---------|--|-----|-----------|------|-------|-----|---|
| 0088730 | | wit | 572100000 | stuk | 95,00 | 034 | 0 |
|---------|--|-----|-----------|------|-------|-----|---|

wandbidet

| | | | | | | | |
|---------|-------------|-----|-----------|------|--------|-----|---|
| 0088749 | | wit | 232100000 | stuk | 285,00 | 034 | 1 |
| 0081012 | m. KeraTect | wit | 232100600 | stuk | 350,00 | 034 | 1 |

Accessoires en
spiegels

Douchewanden

staand bidet

| | | | | | | | |
|---------|-------------|-----|-----------|------|--------|-----|---|
| 0080510 | | wit | 231200000 | stuk | 269,00 | 034 | 1 |
| 0080511 | m. KeraTect | wit | 231200600 | stuk | 334,00 | 034 | 1 |

Toebehoren &
afvoerenSpoel- &
installatiesystemen

Keramag Cavelle

urinoir voor deksel

| | | | | | | | |
|---------|--------------------------------------|----------|-----------|------|--------|-----|---|
| 0087947 | | wit | 239500000 | stuk | 475,00 | 035 | 1 |
| 0088064 | | pergamon | 239500068 | stuk | 633,00 | 035 | 1 |
| 0088137 | m. keraclean | wit | 239500600 | stuk | 540,00 | 035 | 1 |
| 0088226 | m. keraclean | pergamon | 239500668 | stuk | 698,00 | 035 | 1 |
| 0201197 | urinoirsifon 70/75/80/85 horizontaal | | 492465 | stuk | 25,50 | 350 | 0 |
| 0201200 | urinoirsifon 70/75/80/85 verticaal | | 492458 | stuk | 25,50 | 350 | 0 |

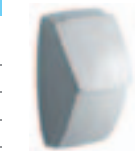
Badkamermeubelen
en toiletkastenGootstenen en
wastroggen

deksel voor urinoir

| | | | | | | | |
|---------|--|----------|-----------|------|--------|-----|---|
| 0087948 | | wit | 573310000 | stuk | 175,00 | 035 | 1 |
| 0087949 | | pergamon | 573310068 | stuk | 193,00 | 035 | 1 |

Keramag Cleo

wastafel

| | | | | | | | |
|---------|---------------------------|----------|-----------|------|--------|-----|---|
| 0084360 | 60x48.5cm | wit | 251360000 | stuk | 390,00 | 034 | 1 |
| 0084336 | 60x48.5cm | pergamon | 251360068 | stuk | 333,00 | 034 | 1 |
| 0081039 | 60x48.5cm m. KeraTect | wit | 251360600 | stuk | 315,00 | 034 | 1 |
| 0081040 | 60x48.5cm m. KeraTect | pergamon | 251360668 | stuk | 398,00 | 034 | 1 |
| 0830097 | bevestigingsset M10x110mm | | 0830097 | paar | 1,09 | 362 | 0 |



Utiliteit

wastafel m. clou

| | | | | | | | |
|---------|---------------------------|----------|------------------|------|--------|-----|---|
| 0082173 | 60x48.5cm | wit | 251260000+521060 | stuk | 335,00 | 034 | 1 |
| 0084328 | 60x48.5cm | pergamon | 251260068+521060 | stuk | 388,00 | 034 | 1 |
| 0081035 | 60x48.5cm m. KeraTect | wit | 251260600+521060 | stuk | 400,00 | 034 | 1 |
| 0081036 | 60x48.5cm m. KeraTect | pergamon | 251260668+521060 | stuk | 505,00 | 034 | 1 |
| 0830097 | bevestigingsset M10x110mm | | 0830097 | paar | 1,09 | 362 | 0 |

wastafel

| | | | | | | | |
|---------|---------------------------|----------|-----------|------|--------|-----|---|
| 0082174 | 65x50cm | wit | 251365000 | stuk | 310,00 | 034 | 1 |
| 0084352 | 65x50cm | pergamon | 251365068 | stuk | 413,00 | 034 | 1 |
| 0081041 | 65x50cm m. KeraTect | wit | 251365600 | stuk | 375,00 | 034 | 1 |
| 0081042 | 65x50cm m. KeraTect | pergamon | 251365668 | stuk | 478,00 | 034 | 1 |
| 0830097 | bevestigingsset M10x110mm | | 0830097 | paar | 1,09 | 362 | 0 |

| Art.nr | Specificaties | Kleur | Lev.nr | Ehd | Prijs | Grp | CC |
|--------|---------------|-------|--------|-----|-------|-----|----|
|--------|---------------|-------|--------|-----|-------|-----|----|

Keramag Cleo

wastafel m. clou

| | | | | | | | |
|---------|---------------------|----------|------------------|------|--------|-----|---|
| 0084379 | 65x50cm | wit | 251265000+521060 | stuk | 384,00 | 034 | 1 |
| 0084344 | 65x50cm | pergamon | 251265068+521060 | stuk | 468,00 | 034 | 1 |
| 0081037 | 65x50cm m. KeraTect | wit | 251265600+521060 | stuk | 447,00 | 034 | 1 |
| 0081038 | 65x50cm m. KeraTect | pergamon | 251265668+521060 | stuk | 524,00 | 034 | 1 |

0830097 bevestigingsset M10x110mm 0830097 paar 1,09 362 0

sifonkap voor wastafel

| | | | | | | | |
|---------|--|----------|-----------|------|--------|-----|---|
| 0082165 | | wit | 291310000 | stuk | 170,00 | 034 | 1 |
| 0084271 | | pergamon | 291310068 | stuk | 227,00 | 034 | 1 |
| 0082546 | kerafix bevestigingsbeugel voor sifonkap | | 551061000 | stuk | 42,00 | 034 | 1 |



opbouw wastafel ovaal m. clou

| | | | | | | | |
|---------|---------------------|----------|------------------|------|--------|-----|---|
| 0082162 | 58x48cm | wit | 241200000+521060 | stuk | 570,00 | 034 | 1 |
| 0087025 | 58x48cm | pergamon | 241200068-521060 | stuk | 650,00 | 034 | 1 |
| 0081033 | 58x48cm m. KeraTect | wit | 241200600+521060 | stuk | 610,00 | 034 | 1 |
| 0081034 | 58x48cm m. KeraTect | pergamon | 241200668+521060 | stuk | 715,00 | 034 | 1 |



meubelwastafel dubbel m. clou

| | | | | | | | |
|---------|----------------------|----------|------------------|------|---------|-----|---|
| 0086940 | 130x55cm | wit | 121230000-521060 | stuk | 1099,00 | 034 | 1 |
| 0086959 | 130x55cm | pergamon | 121230068-521060 | stuk | 1687,00 | 034 | 1 |
| 0081025 | 130x55cm m. KeraTect | wit | 121230600-521060 | stuk | 1164,00 | 034 | 1 |
| 0081026 | 130x55cm m. KeraTect | pergamon | 121230668-521060 | stuk | 1752,00 | 034 | 1 |



0830097 bevestigingsset M10x110mm 0830097 paar 1,09 362 0

duoblokpot diepspoel z. reservoir

| | | | | | | | |
|---------|-------------|----------|-----------|------|--------|-----|---|
| 0080544 | | wit | 203700000 | stuk | 515,00 | 034 | 1 |
| 0080546 | | pergamon | 203700068 | stuk | 650,00 | 034 | 1 |
| 0080545 | m. KeraTect | wit | 203700600 | stuk | 580,00 | 034 | 1 |
| 0080547 | m. KeraTect | pergamon | 203700668 | stuk | 715,00 | 034 | 1 |

0082171 afvoerset voor closetcombinatie multi AO 521170000 stuk 74,00 034 1

0082821 afvoerset voor closetcombinatie multi SV/PK 521180000 stuk 64,00 034 1

duoblokreervoir m. binnenwerk 6-liter

| | | | | | | | |
|---------|--|----------|-----------|------|--------|-----|---|
| 0080548 | | wit | 228750000 | stuk | 345,00 | 034 | 1 |
| 0080549 | | pergamon | 228750068 | stuk | 415,00 | 034 | 1 |

wandclosetpot diepspoel

| | | | | | | | |
|---------|-------------|----------|-----------|------|--------|-----|---|
| 0082181 | | wit | 205900000 | stuk | 575,00 | 034 | 1 |
| 0084301 | | pergamon | 205900068 | stuk | 767,00 | 034 | 1 |
| 0081028 | m. KeraTect | wit | 205900600 | stuk | 640,00 | 034 | 1 |
| 0081029 | m. KeraTect | pergamon | 205900668 | stuk | 832,00 | 034 | 1 |

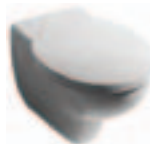

closetzitting dubbel

| | | | | | | | |
|---------|--|-------------|-----------|------|--------|-----|---|
| 0082180 | | chrom/wit | 573600000 | stuk | 180,00 | 034 | 1 |
| 0084298 | | chrom/perg. | 573600068 | stuk | 195,00 | 034 | 1 |

wandbidet

| | | | | | | | |
|---------|-------------|----------|-----------|------|--------|-----|---|
| 0087092 | | wit | 233630000 | stuk | 605,00 | 034 | 1 |
| 0087106 | | pergamon | 233630068 | stuk | 807,00 | 034 | 1 |
| 0081030 | m. KeraTect | wit | 233630600 | stuk | 670,00 | 034 | 1 |
| 0081031 | m. KeraTect | pergamon | 233630668 | stuk | 872,00 | 034 | 1 |



zitrand voor bidet

| | | | | | | | |
|---------|--|----------|-----------|------|-------|-----|---|
| 0087130 | | wit | 573610000 | stuk | 90,00 | 034 | 1 |
| 0087149 | | pergamon | 573610068 | stuk | 94,00 | 034 | 1 |

inlaatverbinder voor urinoir









| | | | | | | | |
|---------|--|--|-----------|------|-------|-----|---|
| 0082475 | | | 521005000 | stuk | 21,00 | 034 | 1 |
|---------|--|--|-----------|------|-------|-----|---|

Keramag Cotta

wastafel

| | | | | | | | |
|---------|---------------------------|-----|-----------|------|--------|-----|---|
| 0084654 | 60x50.5cm | wit | 250560000 | stuk | 185,00 | 034 | 1 |
| 0081046 | 60x50.5cm m. KeraTect | wit | 250560600 | stuk | 250,00 | 034 | 1 |
| 0830097 | bevestigingsset M10x110mm | | 0830097 | paar | 1,09 | 362 | 0 |



| Art.nr | Specificaties | Kleur | Lev.nr | Ehd | Prijs | Grp | CC | |
|---|--|---------|------------------|------|--------|-----|----|---|
| Keramag Cotta | | | | | | | | |
| sifonkap voor wastafel | | | | | | | | |
| 0084581 | 60-65-70cm | wit | 294510000 | stuk | 125,00 | 034 | 1 | |
| 0085928 | kerafix bevestigingsbeugel voor sifonkap Cotta | | 551081000 | stuk | 42,00 | 034 | 1 | |
| zuil voor wastafel | | | | | | | | |
| 0084573 | 60-65-70cm | wit | 294500000 | stuk | 195,00 | 034 | 1 |  |
| meubelwastafel m. clou | | | | | | | | |
| 0086649 | 80x53cm | wit | 120480000+521060 | stuk | 569,00 | 034 | 1 | |
| 0081045 | 80x53cm m. KeraTect | wit | 120480600+521060 | stuk | 634,00 | 034 | 1 |  |
| 0086665 | 100x55cm | wit | 120400000+521060 | stuk | 660,00 | 034 | 1 | |
| 0081044 | 100x55cm m. KeraTect | wit | 120400600+521060 | stuk | 725,00 | 034 | 1 | |
| 0830097 | bevestigingsset M10x110mm | | 0830097 | paar | 1,09 | 362 | 0 |  |
| wandclosetpot diepspoel | | | | | | | | |
| 0084662 | | wit | 207500000 | stuk | 299,00 | 034 | 0 | |
| 0081048 | m. KeraTect | wit | 207500600 | stuk | 364,00 | 034 | 1 |  |
| closetcombinatie diepspoel | | | | | | | | |
| 0085804 | | wit | 200400+227420 | stuk | 670,00 | 034 | 1 | |
| 0082171 | afvoerset voor closetcombinatie multi AO | | 521170000 | stuk | 74,00 | 034 | 1 |  |
| 0082821 | afvoerset voor closetcombinatie multi SV/PK | | 521180000 | stuk | 64,00 | 034 | 1 | |
| 0083208 | vloerbevestiging Kerafix voor bidet/duoblok | | 551060000 | stuk | 33,00 | 034 | 1 | |
| duoblokpot universeel diepspoel z. reservoir | | | | | | | | |
| 0085812 | | wit | 200400000 | stuk | 395,00 | 034 | 1 | |
| 0082171 | afvoerset voor closetcombinatie multi AO | | 521170000 | stuk | 74,00 | 034 | 1 | |
| 0082821 | afvoerset voor closetcombinatie multi SV/PK | | 521180000 | stuk | 64,00 | 034 | 1 | |
| 0083208 | vloerbevestiging Kerafix voor bidet/duoblok | | 551060000 | stuk | 33,00 | 034 | 1 | |
| duoblokpot universeel diepspoel | | | | | | | | |
| 0081047 | m. KeraTect | wit | 200400600 | stuk | 460,00 | 034 | 1 | |
| 0082171 | afvoerset voor closetcombinatie multi AO | | 521170000 | stuk | 74,00 | 034 | 1 | |
| 0082821 | afvoerset voor closetcombinatie multi SV/PK | | 521180000 | stuk | 64,00 | 034 | 1 | |
| 0083208 | vloerbevestiging Kerafix voor bidet/duoblok | | 551060000 | stuk | 33,00 | 034 | 1 | |
| duoblokreservoir + binnenwerk m. duospoeling | | | | | | | | |
| 0084611 | | wit | 227420000 | stuk | 275,00 | 034 | 1 | |
| wandbidet | | | | | | | | |
| 0084670 | | wit | 234300000 | stuk | 355,00 | 034 | 1 |  |
| 0081049 | m. KeraTect | wit | 234300600 | stuk | 420,00 | 034 | 1 | |
| zitrand voor bidet | | | | | | | | |
| 0084603 | | wit | 574810000 | stuk | 60,00 | 034 | 1 |  |
| boxette | | | | | | | | |
| 0086681 | 40x38x46cm rechts | esdoorn | 800100000 | stuk | 415,00 | 034 | 1 |  |
| 0086703 | 40x38x46cm links | esdoorn | 800105000 | stuk | 415,00 | 034 | 1 | |

Sanitair producten

Baden /
douchebakken /
stoomcabines

Kranen

Douchegarnituur

Accessoires en
spiegels

Douchewanden

Toebehoren &
afvoerenSpoel- &
installatiesystemenBadkamermeubelen
en toiletkastenGootstenen en
wastroggen

Utiliteit

| Art.nr | Specificaties | Kleur | Lev.nr | Ehd | Prijs | Grp | CC |
|--------|---------------|-------|--------|-----|-------|-----|----|
|--------|---------------|-------|--------|-----|-------|-----|----|

Keramag Cotta

wastafelonderbouw

| | | | | | | | |
|---------|------------|---------|-----------|------|--------|-----|---|
| 0086711 | 75x34x40.7 | esdoorn | 800110000 | stuk | 599,00 | 034 | 1 |
| 0086738 | 95x34x40.7 | esdoorn | 800120000 | stuk | 660,00 | 034 | 1 |



Sanitair producten

Baden /
douchebakken /
stoomcabines

Kranen

Douchegarnituur

Accessoires en
spiegels

Douchewanden

Toebehoren &
afvoeren

Spoel- &
installatiesystemen

Badkamermeubelen
en toiletkasten

Gootstenen en
wastroggen

Utiliteit

hoge kast

| | | | | | | | |
|---------|-------------------|---------|-----------|------|--------|-----|---|
| 0086746 | 40x38x174cm links | esdoorn | 800130000 | stuk | 695,00 | 034 | 1 |
|---------|-------------------|---------|-----------|------|--------|-----|---|



spiegel m. verlichting

| | | | | | | | |
|---------|--|---------|-----------|------|--------|-----|---|
| 0086762 | | esdoorn | 800140000 | stuk | 410,00 | 034 | 1 |
|---------|--|---------|-----------|------|--------|-----|---|



Keramag Eurotrend

wastafel

| | | | | | | | |
|---------|---------------------------|-----------|-----------|------|--------|-----|---|
| 0081272 | 60x49cm | wit | 226060000 | stuk | 169,00 | 034 | 1 |
| 0081299 | 60x49cm | pergamon | 226060068 | stuk | 205,00 | 034 | 1 |
| 0081280 | 60x49cm | manhattan | 226060010 | stuk | 205,00 | 034 | 1 |
| 0830097 | bevestigingsset M10x110mm | | 0830097 | paar | 1,09 | 362 | 0 |



sifonkap voor wastafel

| | | | | | | | |
|---------|--|-----------|-----------|------|--------|-----|---|
| 0081329 | | wit | 296110000 | stuk | 115,00 | 034 | 1 |
| 0081345 | | pergamon | 296110068 | stuk | 139,00 | 034 | 1 |
| 0081337 | | manhattan | 296110010 | stuk | 139,00 | 034 | 1 |
| 0082945 | kerafix bevestigingsbeugel voor sifonkap | | 551065000 | stuk | 42,00 | 034 | 0 |

wandbidet

| | | | | | | | |
|---------|--|-----------|-----------|------|--------|-----|---|
| 0081612 | | wit | 232800000 | stuk | 329,00 | 034 | 1 |
| 0081639 | | pergamon | 232800068 | stuk | 399,00 | 034 | 1 |
| 0081620 | | manhattan | 232800010 | stuk | 399,00 | 034 | 1 |



wandclosetpot diepspoel

| | | | | | | | |
|---------|--|-----------|-----------|------|--------|-----|---|
| 0081450 | | wit | 206500000 | stuk | 260,00 | 034 | 1 |
| 0081477 | | pergamon | 206500068 | stuk | 353,00 | 034 | 1 |
| 0081469 | | manhattan | 206500010 | stuk | 353,00 | 034 | 1 |



wandclosetpot vlakspoel

| | | | | | | | |
|---------|--|-----------|-----------|------|--------|-----|---|
| 0081507 | | wit | 206400000 | stuk | 305,00 | 034 | 1 |
| 0081523 | | pergamon | 206400068 | stuk | 407,00 | 034 | 1 |
| 0081515 | | manhattan | 206400010 | stuk | 407,00 | 034 | 1 |



closetzitting dubbel voor wandcloset

| | | | | | | | |
|---------|--|----------|-----------|------|--------|-----|---|
| 0087950 | | wit | 573440000 | stuk | 105,00 | 034 | 1 |
| 0087951 | | pergamon | 573440068 | stuk | 119,00 | 034 | 1 |

| Art.nr | Specificaties | Kleur | Lev.nr | Ehd | Prijs | Grp | CC |
|--------|---------------|-------|--------|-----|-------|-----|----|
|--------|---------------|-------|--------|-----|-------|-----|----|

Keramag Eurotrend

closetcombinatie universeel wit multi universeel

| | | | | | | | |
|---------|---|-----|---------------|------|--------|-----|---|
| 0082341 | | wit | 206800+228650 | stuk | 564,00 | 034 | 1 |
| 0082171 | afvoerset voor closetcombinatie multi AO | | 521170000 | stuk | 74,00 | 034 | 1 |
| 0082821 | afvoerset voor closetcombinatie multi SV/PK | | 521180000 | stuk | 64,00 | 034 | 1 |
| 0830453 | set potschroeven 5.5x60mm chrom | | 0830453 | stuk | 2,28 | 362 | 0 |



Sanitair producten

Baden /
douchebakken /
stoomcabines

Kranen

Douchegarnituur

Accessoires en
spiegels

Douchewanden

Toebehoren &
afvoerenSpoel- &
installatiesystemenBadkamermeubelen
en toiletkastenGootstenen en
wastroggen

Utiliteit

closetzitting dubbel m. RVS scharnieren v. closetcombinatie

| | | | | | | | |
|---------|--|-----------|-----------|------|--------|-----|---|
| 0081789 | | wit | 573430000 | stuk | 105,00 | 034 | 1 |
| 0087965 | | pergamon | 573430068 | stuk | 119,00 | 034 | 1 |
| 0087966 | | manhattan | 573430010 | stuk | 119,00 | 034 | 1 |

duoblokpot diepspoel m. multi-uitlaat z. reservoir

| | | | | | | | |
|---------|--|-----|-----------|------|--------|-----|---|
| 0082325 | | wit | 206800000 | stuk | 315,00 | 034 | 1 |
|---------|--|-----|-----------|------|--------|-----|---|

duoblokreervoir dual-flush

| | | | | | | | |
|---------|--|-----|-----------|------|--------|-----|---|
| 0081195 | | wit | 228650000 | stuk | 249,00 | 035 | 1 |
|---------|--|-----|-----------|------|--------|-----|---|

Keramag Felino

wastafel

| | | | | | | | |
|---------|---------------------------|----------|-----------|------|--------|-----|---|
| 0082880 | 60x50cm | wit | 224060000 | stuk | 155,00 | 034 | 1 |
| 0082899 | 60x50cm | pergamon | 224060068 | stuk | 207,00 | 034 | 1 |
| 0081054 | 60x50cm m. KeraTect | | 224060600 | stuk | 220,00 | 034 | 1 |
| 0081055 | 60x50cm m. KeraTect | pergamon | 224060668 | stuk | 272,00 | 034 | 1 |
| 0830097 | bevestigingsset M10x110mm | | 0830097 | paar | 1,09 | 362 | 0 |

**sifonkap voor wastafel**

| | | | | | | | |
|---------|--|----------|-----------|------|--------|-----|---|
| 0082911 | | wit | 294100000 | stuk | 105,00 | 034 | 1 |
| 0082937 | | pergamon | 294100068 | stuk | 140,00 | 034 | 1 |
| 0082945 | kerafix bevestigingsbeugel voor sifonkap | | 551065000 | stuk | 42,00 | 034 | 0 |

zuil voor wastafel

| | | | | | | | |
|---------|--|----------|-----------|------|--------|-----|---|
| 0082902 | | wit | 294000000 | stuk | 159,00 | 034 | 1 |
| 0082910 | | pergamon | 294000068 | stuk | 190,00 | 034 | 1 |

**fontein**

| | | | | | | | |
|---------|--------------------------------------|----------|-----------|------|--------|-----|---|
| 0082953 | 45x37cm | wit | 274045000 | stuk | 83,00 | 034 | 1 |
| 0082961 | 45x37cm | pergamon | 274045068 | stuk | 111,00 | 034 | 1 |
| 0081056 | 45x37cm m. KeraTect | wit | 274045600 | stuk | 148,00 | 034 | 1 |
| 0081057 | 45x37cm m. KeraTect | pergamon | 274045668 | stuk | 176,00 | 034 | 1 |
| 0830240 | bevestigingsset voor fontein M8x90mm | | 0830240 | stuk | 0,85 | 362 | 0 |

**sifonkap voor fontein**

| | | | | | | | |
|---------|--|----------|-----------|------|--------|-----|---|
| 0082988 | | wit | 294150000 | stuk | 90,00 | 034 | 1 |
| 0082996 | | pergamon | 294150068 | stuk | 113,00 | 034 | 1 |
| 0083003 | kerafix bevestigingsbeugel voor sifonkap | | 551066000 | stuk | 42,00 | 034 | 0 |

duoblokpot diepspoel AO z. reservoir

| | | | | | | | |
|---------|---|----------|-----------|------|--------|-----|---|
| 0080562 | | wit | 214100000 | stuk | 270,00 | 034 | 1 |
| 0080564 | | pergamon | 214100068 | stuk | 325,00 | 034 | 1 |
| 0080563 | m. KeraTect | wit | 214100600 | stuk | 335,00 | 034 | 1 |
| 0080565 | m. KeraTect | pergamon | 214100668 | stuk | 390,00 | 034 | 1 |
| 0082821 | afvoerset voor closetcombinatie multi SV/PK | | 521180000 | stuk | 64,00 | 034 | 1 |
| 0083208 | vloerbevestiging Kerafix voor bidet/duoblok | | 551060000 | stuk | 33,00 | 034 | 1 |

duoblokpot diepspoel PK z. reservoir

| | | | | | | | |
|---------|---|----------|-----------|------|--------|-----|---|
| 0080558 | | wit | 214000000 | stuk | 249,00 | 034 | 1 |
| 0080560 | | pergamon | 214000068 | stuk | 299,00 | 034 | 1 |
| 0080559 | m. KeraTect | wit | 214000600 | stuk | 314,00 | 034 | 1 |
| 0080561 | m. KeraTect | pergamon | 214000668 | stuk | 364,00 | 034 | 1 |
| 0082821 | afvoerset voor closetcombinatie multi SV/PK | | 521180000 | stuk | 64,00 | 034 | 1 |
| 0083208 | vloerbevestiging Kerafix voor bidet/duoblok | | 551060000 | stuk | 33,00 | 034 | 1 |

duoblokreervoir m. binnenwerk 6-liter

| | | | | | | | |
|---------|--|----------|-----------|------|--------|-----|---|
| 0080566 | | wit | 229150000 | stuk | 200,00 | 034 | 1 |
| 0080567 | | pergamon | 229150068 | stuk | 245,00 | 034 | 1 |

| | Art.nr | Specificaties | Kleur | Lev.nr | Ehd | Prijs | Grp | CC |
|--|---|--|--------------|-----------|--------|--------|-----|----|
| Sanitair producten | Keramag Felino | | | | | | | |
| | wandclosetpot diepspoel | | | | | | | |
| | 0083127 | | wit | 204900000 | stuk | 245,00 | 034 | 1 |
| | 0083135 | | pergamon | 204900068 | stuk | 327,00 | 034 | 1 |
| | 0081051 | m. KeraTect | wit | 204900600 | stuk | 304,00 | 034 | 1 |
| 0081052 | m. KeraTect | pergamon | 204900668 | stuk | 392,00 | 034 | 1 | |
| Baden / douchebakken / stoomcabines | closetzitting dubbel | | | | | | | |
| | 0082912 | | RVS/wit | 574010000 | stuk | 115,00 | 034 | 1 |
| Kranen | 0081178 | | RVS/pergamon | 574010068 | stuk | 125,00 | 034 | 1 |
| | Keramag Fidelio | | | | | | | |
| Douchegarnituur | fontein z. kraangat | | | | | | | |
| | 0083262 | 37x26cm | wit | 274037000 | stuk | 77,00 | 034 | 0 |
| | 0087831 | 37x26cm | pergamon | 274037068 | stuk | 102,00 | 034 | 1 |
| | 0081062 | 37x26cm | m. KeraTect | 274037600 | stuk | 142,00 | 034 | 1 |
| | 0081063 | 37x26cm | m. KeraTect | 274037668 | stuk | 167,00 | 034 | 1 |
| Accessoires en spiegels | 0830240 | bevestigingsset voor fontein M8x90mm | | 0830240 | stuk | 0,85 | 362 | 0 |
| | fontein m. kraangat | | | | | | | |
| | 0083259 | 37x26cm | wit | 274036000 | stuk | 72,00 | 034 | 0 |
| | 0083267 | 37x26cm | pergamon | 274036068 | stuk | 96,00 | 034 | 0 |
| | 0081060 | 37x26cm | m. KeraTect | 274036600 | stuk | 137,00 | 034 | 1 |
| Douchewanden | 0081061 | 37x26cm | m. KeraTect | 274036668 | stuk | 161,00 | 034 | 1 |
| | 0830240 | bevestigingsset voor fontein M8x90mm | | 0830240 | stuk | 0,85 | 362 | 0 |
| | sifonkap m. bevestiging | | | | | | | |
| Toebehoren & afvoeren | 0083305 | | RVS | 508015000 | stuk | 129,00 | 034 | 0 |
| | hoekfontein | | | | | | | |
| | 0085480 | 38x35.5cm | wit | 274025000 | stuk | 110,00 | 034 | 0 |
| | 0085499 | 38x35.5cm | pergamon | 274025068 | stuk | 146,00 | 034 | 0 |
| | 0081058 | 38x35.5cm | m. KeraTect | 274025600 | stuk | 175,00 | 034 | 1 |
| Spoel- & installatiesystemen | 0081059 | 38x35.5cm | m. KeraTect | 274025668 | stuk | 211,00 | 034 | 1 |
| | ophanghaak voor hoekfontein | | | | | | | |
| Badkamermeubelen en toiletkasten | 0085901 | | | 554005000 | stuk | 6,00 | 034 | 0 |
| | Keramag Flow | | | | | | | |
| Gootstenen en wastroggen | wastafel m. overloop m. kraangat | | | | | | | |
| | 0080625 | 60x44cm | wit | 250960000 | stuk | 149,00 | 034 | 1 |
| | 0080626 | 65x47cm | wit | 250965000 | stuk | 175,00 | 034 | 1 |
| | 0080627 | 70x50cm | wit | 250970000 | stuk | 230,00 | 034 | 1 |
| | 0830097 | bevestigingsset M10x110mm | | 0830097 | paar | 1,09 | 362 | 0 |
| Utiliteit | sifonkap voor wastafel | | | | | | | |
| | 0080653 | | wit | 296910000 | stuk | 115,00 | 034 | 1 |
| | 0080654 | bevestigingsset voor sifonkap wastafel | | 551082000 | stuk | 42,00 | 034 | 1 |
| | bevestigingsset voor sifonkap wastafel | | | | | | | |
| | 0080654 | | | 551082000 | stuk | 42,00 | 034 | 1 |
| Utiliteit | fontein m. overloop m. kraangat | | | | | | | |
| | 0080628 | 40x31cm | wit | 276940000 | stuk | 110,00 | 034 | 1 |
| | 0080629 | 50x36cm | wit | 276950000 | stuk | 120,00 | 034 | 1 |
| | 0830240 | bevestigingsset voor fontein M8x90mm | | 0830240 | stuk | 0,85 | 362 | 0 |
| sifonkap voor fontein | | | | | | | | |
| 0080631 | | wit | 296950000 | stuk | 94,00 | 034 | 1 | |
| bevestigingsset voor sifonkap fontein | | | | | | | | |
| 0080655 | | | 551083000 | stuk | 42,00 | 034 | 1 | |

| Art.nr | Specificaties | Kleur | Lev.nr | Ehd | Prijs | Grp | CC | |
|---|---------------|---------|-----------|------|--------|-----|----|---|
| | | | | | | | | Keramag Flow |
| wandclosetpot diepspoel Gliter 0080632 | | wit | 207900000 | stuk | 249,00 | 034 | 0 |  |
| duoblokpote staand diepspoel z. reservoir 0080788 | | wit | 200900000 | stuk | 379,00 | 034 | 1 |  |
| duoblokreervoir 0080789 | | wit | 229950000 | stuk | 199,00 | 034 | 1 | |
| closetpot staand diepspoel 0080790 | | wit | 216900000 | stuk | 235,00 | 034 | 1 |  |
| closetzitting m. RVS scharnieren 0080633 | | wit | 575900000 | stuk | 115,00 | 034 | 1 |  |
| closetzitting m. RVS scharnieren m. softclose 0080634 | | wit | 575950000 | stuk | 149,00 | 034 | 0 | |
| staand bidet 0080636 | | wit | 230900000 | stuk | 275,00 | 034 | 1 |  |
| wandbidet 0080635 | | wit | 232900000 | stuk | 279,00 | 034 | 1 |  |
| urinoir m. achterinlaat m. achterafvoer 0080668 | | wit | 235900000 | stuk | 265,00 | 034 | 1 |  |
| urinoir voor deksel m. achterinlaat m. achterafvoer 0082240 | | wit | 235920000 | stuk | 350,00 | 034 | 1 | |
| 0082241 | m. KeraTect | wit | 235920600 | stuk | 415,00 | 034 | 1 | |
| deksel voor urinoir 0082242 | | RVS/wit | 575910000 | stuk | 105,00 | 034 | 1 | |
| 0082243 | m. softclose | RVS/wit | 575905000 | stuk | 135,00 | 034 | 1 | |

Sanitair producten

Baden /
douchebakken /
stoomcabines

Kranen









Douchegarnituur

Accessoires en
spiegels

Douchewanden

Toebehoren &
afvoerenSpoel- &
installatiesystemenBadkamermeubelen
en toiletkastenGootstenen en
wastroggen

Utiliteit

| | Art.nr | Specificaties | Kleur | Lev.nr | Ehd | Prijs | Grp | CC | |
|---|---|--|------------|-----------|-----------|--------|--------|-----|---|
| Sanitair producten | Keramag Flow | | | | | | | | |
| | wastafelonderbouw | | | | | | | | |
| | | 0080637 | 70x30x41cm | wit | 877030000 | stuk | 475,00 | 034 | 1 |
| | | 0080638 | 85x30x41cm | wit | 877040000 | stuk | 505,00 | 034 | 1 |
| | | 0080640 | 70x45x41cm | wit | 877010000 | stuk | 565,00 | 034 | 1 |
| | 0080641 | 85x45x41cm | wit | 877020000 | stuk | 650,00 | 034 | 1 | |
| Baden / douchebakken / stoomcabines |  | | | | | | | | |
| Kranen |  | | | | | | | | |
| Douchegarnituur | | wastafelonderbouw m. sifonuitsparing links | | | | | | | |
| | 0080642 | 140x15x41cm | wit | 877050000 | stuk | 535,00 | 034 | 1 | |
| Accessoires en spiegels |  | | | | | | | | |
| Douchewanden | | wastafelonderbouw m. sifonuitsparing links+rechts | | | | | | | |
| | 0080669 | 140x15x41cm | wit | 877060000 | stuk | 535,00 | 034 | 1 | |
| Toebehoren & afvoeren |  | | | | | | | | |
| Spoel- & installatiesystemen | | meubelzijkast | | | | | | | |
| | 0080643 | 70x30x41cm | wit | 877090000 | stuk | 485,00 | 034 | 1 | |
| | 0080645 | 85x30x41cm | wit | 877100000 | stuk | 515,00 | 034 | 1 | |
| | 0080644 | 70x45x41cm | wit | 877070000 | stuk | 580,00 | 034 | 1 | |
| | 0080646 | 85x45x41cm | wit | 877080000 | stuk | 660,00 | 034 | 1 | |
| | 0080647 | 140x15x41cm | wit | 877110000 | stuk | 550,00 | 034 | 1 | |
| Badkamermeubelen en toiletkasten |  | | | | | | | | |
| Gootstenen en wastroggen |  | | | | | | | | |
| Utiliteit |  | | | | | | | | |
| | | hoge kast | | | | | | | |
| | 0080648 | 43x182x30cm | wit | 877000000 | stuk | 665,00 | 034 | 1 | |
| |  | | | | | | | | |
| | | decor greepinzet | | | | | | | |
| | 0080649 | | chroom | 500700000 | stuk | 27,00 | 034 | 1 | |
| | 0080650 | | aluminium | 500701000 | stuk | 27,00 | 034 | 1 | |
| |  | | | | | | | | |

| Art.nr | Specificaties | Kleur | Lev.nr | Ehd | Prijs | Grp | CC |
|--------|---------------|-------|--------|-----|-------|-----|----|
|--------|---------------|-------|--------|-----|-------|-----|----|

Keramag Flow

lichtspiegelement

| | | | | | | | |
|---------|---------|--|-----------|------|--------|-----|---|
| 0080651 | 70x60cm | | 877170000 | stuk | 435,00 | 034 | 1 |
| 0080652 | 85x60cm | | 877180000 | stuk | 509,00 | 034 | 1 |



Sanitair producten

Baden /
douchebakken /
stoomcabines

Keramag Fora

wastafel

| | | | | | | | | |
|---------|---------------------------|-------------|-----|-----------|------|--------|-----|---|
| 0087661 | 52x49cm | | wit | 141552000 | stuk | 315,00 | 034 | 1 |
| 0081064 | 52x49cm | m. KeraTect | wit | 141552600 | stuk | 380,00 | 034 | 1 |
| 0087696 | 70x55cm | | wit | 141570000 | stuk | 410,00 | 034 | 1 |
| 0081065 | 70x55cm | m. KeraTect | wit | 141570600 | stuk | 475,00 | 034 | 1 |
| 0830097 | bevestigingsset M10x110mm | | | 0830097 | paar | 1,09 | 362 | 0 |



Kranen



Douchegarnituur

spiegel m. verlichting m. facet

| | | | | | | | | |
|---------|---------|--|--|-----------|------|--------|-----|---|
| 0087769 | 58x99cm | | | 810360000 | stuk | 629,00 | 034 | 1 |
| 0087777 | 68x99cm | | | 810370000 | stuk | 685,00 | 034 | 1 |

Accessoires en
spiegels

Douchewanden

Keramag Joly

wastafel blad links

| | | | | | | | | |
|---------|-------------------------------|-------------------------|----------|-----------|------|--------|-----|---|
| 0083291 | 60x34cm | | wit | 123060000 | stuk | 205,00 | 034 | 1 |
| 0083294 | 60x34cm | | pergamon | 123060068 | stuk | 273,00 | 034 | 1 |
| 0081066 | 60x34cm | m. KeraTect | wit | 123060600 | stuk | 270,00 | 034 | 1 |
| 0081067 | 60x34cm | m. KeraTect | pergamon | 123060668 | stuk | 338,00 | 034 | 1 |
| 0086517 | 60x34cm | z. kraangat | wit | 123061000 | stuk | 205,00 | 034 | 1 |
| 0086525 | 60x34cm | z. kraangat | pergamon | 123061068 | stuk | 273,00 | 034 | 1 |
| 0081069 | 60x34cm | z. kraangat m. KeraTect | wit | 123061600 | stuk | 270,00 | 034 | 1 |
| 0081198 | 60x34cm | z. kraangat m. KeraTect | pergamon | 123061668 | stuk | 338,00 | 034 | 1 |
| 0083283 | Joly afvoerplug voor wastafel | chrom | | 521070000 | stuk | 55,00 | 034 | 1 |
| 0830097 | bevestigingsset M10x110mm | | | 0830097 | paar | 1,09 | 362 | 0 |

Toebehoren &
afvoerenSpoel- &
installatiesystemenBadkamermeubelen
en toiletkasten

wastafel blad rechts

| | | | | | | | | |
|---------|-------------------------------|-------------------------|----------|-----------|------|--------|-----|---|
| 0083275 | 60x34cm | | wit | 123160000 | stuk | 205,00 | 034 | 0 |
| 0083279 | 60x34cm | | pergamon | 123160068 | stuk | 273,00 | 034 | 1 |
| 0081199 | 60x34cm | m. KeraTect | wit | 123160600 | stuk | 270,00 | 034 | 1 |
| 0081200 | 60x34cm | m. KeraTect | pergamon | 123160668 | stuk | 338,00 | 034 | 1 |
| 0086568 | 60x34cm | z. kraangat | wit | 123161000 | stuk | 205,00 | 034 | 1 |
| 0086576 | 60x34cm | z. kraangat | pergamon | 123161068 | stuk | 273,00 | 034 | 1 |
| 0081201 | 60x34cm | z. kraangat m. KeraTect | wit | 123161600 | stuk | 270,00 | 034 | 1 |
| 0081202 | 60x34cm | z. kraangat m. KeraTect | pergamon | 123161668 | stuk | 338,00 | 034 | 1 |
| 0083283 | Joly afvoerplug voor wastafel | chrom | | 521070000 | stuk | 55,00 | 034 | 1 |
| 0830097 | bevestigingsset M10x110mm | | | 0830097 | paar | 1,09 | 362 | 0 |

Gootstenen en
wastroggen

Utiliteit

sifonkap m. bevestiging

| | | | | | | | | |
|---------|--|-----|--|-----------|------|--------|-----|---|
| 0083305 | | RVS | | 508015000 | stuk | 129,00 | 034 | 0 |
|---------|--|-----|--|-----------|------|--------|-----|---|

planchet voor sifonkap









| | | | | | | | | |
|---------|-------------|--|-------------|-----------|------|--------|-----|---|
| 0083321 | blad links | | glas/chroom | 571030000 | stuk | 219,00 | 034 | 1 |
| 0083313 | blad rechts | | glas/chroom | 571020000 | stuk | 219,00 | 034 | 1 |

boxette m. RVS sifonkap

| | | | | | | | | |
|---------|-----------------------|--|-----|-----------|------|--------|-----|---|
| 0086606 | 123060/61 blad links | | wit | 800060000 | stuk | 385,00 | 034 | 1 |
| 0086614 | 123160/61 blad rechts | | wit | 800050000 | stuk | 385,00 | 034 | 1 |

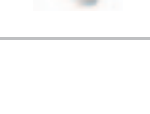

| | Art.nr | Specificaties | Kleur | Lev.nr | Ehd | Prijs | Grp | CC |
|--|---|---|---------------|-----------|------|--------|-----|----|
| Sanitair producten | Keramag Joly | | | | | | | |
| | wandclosetpot-48 diepspoel 6liter | | | | | | | |
| | 0083348 | | wit | 203060000 | stuk | 360,00 | 034 | 0 |
| | 0083328 | | pergamon | 203060068 | stuk | 480,00 | 034 | 1 |
| | 0081075 | m. KeraTect | wit | 203060600 | stuk | 425,00 | 034 | 1 |
| | 0081077 | m. KeraTect | pergamon | 203060668 | stuk | 545,00 | 034 | 1 |
| Baden / douchebakken / stoomcabines | closetzitting dubbel | | | | | | | |
| | 0083356 | | wit | 571000000 | stuk | 129,00 | 034 | 0 |
| | 0083361 | | pergamon | 571000068 | stuk | 129,00 | 034 | 1 |
| Kranen | urinoir semi-inbouw | | | | | | | |
| | 0083364 | | wit | 233060000 | stuk | 340,00 | 034 | 1 |
| | 0080062 | | pergamon | 233060068 | stuk | 453,00 | 034 | 1 |
| | 0084794 | m. keraclean | wit | 233060600 | stuk | 405,00 | 034 | 1 |
| Douchegarnituur | 0083372 | deksel voor urinoir m. scharnier chr./wit | | 572000000 | stuk | 94,00 | 034 | 1 |
| | 0083380 | bevestigingselement voor urinoir wit | | 551075000 | stuk | 22,00 | 034 | 0 |
| | 0083399 | flexibele slang 1/2" m. inlaatverbinder voor urinoir | | 521225000 | stuk | 54,00 | 034 | 0 |
| | 0720348 | urinoirspoeler 1/2" inbouw z. afdekplaat | | 37017000 | stuk | 96,50 | 353 | 0 |
| | 0720356 | Surf afdekplaat voor inbouwspoeler urinoir mat chroom | | 37018P00 | stuk | 50,50 | 353 | 0 |
| Accessoires en spiegels | 0720402 | Surf afdekplaat voor inbouwspoeler urinoir wit | | 37018SH0 | stuk | 50,50 | 353 | 0 |
| | 0720550 | Surf afdekplaat wandbediening RVS | | 37019000 | stuk | 77,50 | 353 | 0 |
| Douchewanden | bevestigingselement voor urinoir | | | | | | | |
| | 0083380 | | wit | 551075000 | stuk | 22,00 | 034 | 0 |
| | deksel voor urinoir m. scharnier | | | | | | | |
| | 0083372 | | chr./wit | 572000000 | stuk | 94,00 | 034 | 1 |
| | 0080061 | | chr./pergamon | 572000068 | stuk | 94,00 | 034 | 1 |
| Toebehoren & afvoeren | flexibele slang 1/2" m. inlaatverbinder voor urinoir | | | | | | | |
| | 0083399 | | | 521225000 | stuk | 54,00 | 034 | 0 |
| Spoel- & installatiesystemen | Keramag Joop | | | | | | | |
| wastafel m. smalle rand m. vlakke kom | | | | | | | | |
| | 0089079 | 60x46cm | wit | 121360000 | stuk | 289,00 | 031 | 1 |
| | 0089087 | 60x46cm m. Keratect | wit | 121360600 | stuk | 354,00 | 031 | 1 |
| Badkamermeubelen en toiletkasten | 0830097 | bevestigingsset M10x110mm | | 0830097 | paar | 1,09 | 362 | 0 |
| wastafel m. brede rand m. diepe kom | | | | | | | | |
| | 0089095 | 60x46cm | wit | 121460000 | stuk | 289,00 | 031 | 1 |
| | 0089109 | 60x46cm m. Keratect | wit | 121460600 | stuk | 354,00 | 031 | 1 |
| Gootstenen en wastroggen | 0830097 | bevestigingsset M10x110mm | | 0830097 | paar | 1,09 | 362 | 0 |
| wastafel m. smalle rand m. vlakke kom | | | | | | | | |
| | 0089184 | 70x47cm | wit | 121370000 | stuk | 395,00 | 031 | 1 |
| | 0089192 | 70x47cm m. Keratect | wit | 121370600 | stuk | 460,00 | 031 | 1 |
| Utiliteit | 0830097 | bevestigingsset M10x110mm | | 0830097 | paar | 1,09 | 362 | 0 |
| wastafel m. brede rand m. diepe kom | | | | | | | | |
| | 0089119 | 70x47cm | wit | 121470000 | stuk | 395,00 | 031 | 1 |
| | 0089120 | 70x47cm m. Keratect | wit | 121470600 | stuk | 460,00 | 031 | 1 |
| | 0830097 | bevestigingsset M10x110mm | | 0830097 | paar | 1,09 | 362 | 0 |
| wastafel m. smalle rand m. vlakke kom | | | | | | | | |
| | 0089122 | 100x47cm | wit | 121300000 | stuk | 715,00 | 031 | 1 |
| | 0089124 | 100x47cm m. Keratect | wit | 121300600 | stuk | 780,00 | 031 | 1 |
| | 0089126 | 100x47cm | wit | 121310000 | stuk | 715,00 | 031 | 1 |
| | 0089128 | 100x47cm m. Keratect | wit | 121310600 | stuk | 780,00 | 031 | 1 |
| | 0830097 | bevestigingsset M10x110mm | | 0830097 | paar | 1,09 | 362 | 0 |

| Art.nr | Specificaties | Kleur | Lev.nr | Ehd | Prijs | Grp | CC | |
|---|---|-------------|-----------|------|--------|-----|----|---|
| Keramag Joop | | | | | | | | |
| wastafel m. brede rand m. diepe kom | | | | | | | | |
| 0089130 | 100x47cm | wit | 121400000 | stuk | 715,00 | 031 | 1 |  |
| 0089132 | 100x47cm m. Keratect | wit | 121400600 | stuk | 780,00 | 031 | 1 | |
| 0830097 | bevestigingsset M10x110mm | | 0830097 | paar | 1,09 | 362 | 0 | |
| opbouwastafel m. smalle rand m. vlakke kom | | | | | | | | |
| 0089117 | 65x39cm | wit | 121365000 | stuk | 335,00 | 031 | 1 |  |
| 0089125 | 65x39cm m. Keratect | wit | 121365600 | stuk | 400,00 | 031 | 1 | |
| opbouwastafel m. brede rand m. diepe kom | | | | | | | | |
| 0089133 | 65x39cm | wit | 121465000 | stuk | 335,00 | 031 | 1 |  |
| 0089141 | 65x39cm m. Keratect | wit | 121465600 | stuk | 400,00 | 031 | 1 | |
| adapter voor opbouwastafel 65cm | | | | | | | | |
| 0089168 | | chrom/wit | 500010000 | stuk | 600,00 | 031 | 1 |  |
| 0089176 | | chrom/noten | 500020000 | stuk | 600,00 | 031 | 1 | |
| decoratierand voor wastafel | | | | | | | | |
| 0089134 | 60-75-70 | chrom | 500050000 | stuk | 80,00 | 031 | 1 |  |
| 0089136 | 60-75-70 | noten | 500055000 | stuk | 69,00 | 031 | 1 | |
| 0089140 | 100cm | chrom | 500060000 | stuk | 90,00 | 031 | 1 | |
| 0089142 | 100cm | noten | 500065000 | stuk | 73,00 | 031 | 1 | |
| staand bidet | | | | | | | | |
| 0089180 | | wit | 231300000 | stuk | 475,00 | 031 | 1 |  |
| 0089182 | m. Keratect | wit | 231300600 | stuk | 540,00 | 031 | 1 | |
| wandbidet | | | | | | | | |
| 0089185 | | wit | 233300000 | stuk | 565,00 | 031 | 1 |  |
| 0089186 | m. Keratect | wit | 233300600 | stuk | 630,00 | 031 | 1 | |
| wandclosetpot diepspoel | | | | | | | | |
| 0089150 | | wit | 201300000 | stuk | 540,00 | 031 | 1 |  |
| 0089152 | m. Keratect | wit | 201300600 | stuk | 605,00 | 031 | 1 | |
| decoratierand voor wandcloset + bidet | | | | | | | | |
| 0089154 | | chrom | 500070000 | stuk | 165,00 | 031 | 1 |  |
| 0089156 | | noten | 500075000 | stuk | 170,00 | 031 | 1 | |
| duoblokpot diepspoel z. reservoir | | | | | | | | |
| 0089144 | | wit | 200300000 | stuk | 575,00 | 031 | 1 |  |
| 0089146 | m. Keratect | wit | 200300600 | stuk | 640,00 | 031 | 1 | |
| 0082171 | afvoerset voor closetcombinatie multi AO | | 521170000 | stuk | 74,00 | 034 | 1 | |
| 0082821 | afvoerset voor closetcombinatie multi SV/PK | | 521180000 | stuk | 64,00 | 034 | 1 | |
| duoblokreservoir | | | | | | | | |
| 0089148 | | wit | 229350000 | stuk | 455,00 | 031 | 1 | |

Sanitair producten

Baden /
douchebakken /
stoomcabines

Kranen

Douchegarnituur

Accessoires en
spiegels

Douchewanden

Toebehoren &
afvoerenSpoel- &
installatiesystemenBadkamermeubelen
en toiletkastenGootstenen en
wastroggen

Utiliteit

| | Art.nr | Specificaties | Kleur | Lev.nr | Ehd | Prijs | Grp | CC |
|---|--|---------------|------------|-----------|------|---------|-----|----|
| Sanitair producten | Keramag Joop | | | | | | | |
| | closetzitting dubbel | | | | | | | |
| | 0089158 | | wit | 575100000 | stuk | 179,00 | 031 | 1 |
| Baden / douchebakken / stoomcabines | wastafelonderkast voor wastafel 60cm | | | | | | | |
| | 0092355 | 40x39x35cm | wit | 820060000 | stuk | 579,00 | 031 | 1 |
| | 0092363 | 40x39x35cm | noten | 820065000 | stuk | 549,00 | 031 | 1 |
| Kranen | wastafelonderkast voor wastafel 65/70cm | | | | | | | |
| | 0092437 | 40x39x35cm | wit | 820061000 | stuk | 589,00 | 031 | 1 |
| | 0092438 | 40x39x35cm | noten | 820066000 | stuk | 555,00 | 031 | 1 |
| Douchegarnituur | wastafelonderkast voor wastafel 60cm | | | | | | | |
| | 0092371 | 40x39x52cm | wit | 820080000 | stuk | 759,00 | 031 | 1 |
| | 0092398 | 40x39x52cm | noten | 820085000 | stuk | 660,00 | 031 | 1 |
| Accessoires en spiegels | wastafelonderkast voor wastafel 65/70cm | | | | | | | |
| | 0092401 | 40x39x52cm | wit | 820081000 | stuk | 759,00 | 031 | 1 |
| | 0092428 | 40x39x52cm | noten | 820086000 | stuk | 665,00 | 031 | 1 |
| Douchewanden | wastafelonderkast voor wastafel 100cm | | | | | | | |
| | 0092439 | 57x39x52cm | wit | 820070000 | stuk | 885,00 | 031 | 1 |
| | 0092440 | 57x39x52cm | noten | 820075000 | stuk | 779,00 | 031 | 1 |
| Toebehoren & afvoeren | meubelpoot 17cm voor wastafelonderkast | | | | | | | |
| | 0092436 | per stuk | verchr.alu | 500500000 | stuk | 180,00 | 031 | 1 |
| Badkamermeubelen en toiletkasten | hoge kast 35x33x110cm | | | | | | | |
| | 0092441 | | wit | 820000000 | stuk | 915,00 | 031 | 1 |
| | 0092442 | | noten | 820005000 | stuk | 819,00 | 031 | 1 |
| Gootstenen en wastroggen | hoge kast 35x33x188cm | | | | | | | |
| | 0092444 | | wit | 820020000 | stuk | 1105,00 | 031 | 1 |
| | 0092445 | | noten | 820025000 | stuk | 1009,00 | 031 | 1 |
| Utiliteit | meubelpoot voor hoge kast per stuk | | | | | | | |
| | 0092443 | | chroom | 500510000 | stuk | 175,00 | 031 | 1 |
| | side table 100x33x36cm | | | | | | | |
| | 0092446 | | wit | 820030000 | stuk | 1285,00 | 031 | 1 |
| | 0092447 | | noten | 820035000 | stuk | 1170,00 | 031 | 1 |
| | inleg voor schuiflade van sidetable | | | | | | | |
| | 0092448 | | wit | 500595000 | stuk | 94,00 | 031 | 1 |
| | 0092449 | | grijs | 500605000 | stuk | 94,00 | 031 | 1 |
| | poot voor sidetable per stuk | | | | | | | |
| | 0092450 | | chroom | 500520000 | stuk | 239,00 | 031 | 1 |

| Art.nr | Specificaties | Kleur | Lev.nr | Ehd | Prijs | Grp | CC |
|--------|---------------|-------|--------|-----|-------|-----|----|
|--------|---------------|-------|--------|-----|-------|-----|----|

Keramag Joop

vitrinekast 30x15x95cm

| | | | | | | | |
|---------|--------|-------|-----------|------|--------|-----|---|
| 0092451 | rechts | wit | 820050000 | stuk | 979,00 | 031 | 1 |
| 0092452 | rechts | noten | 820055000 | stuk | 849,00 | 031 | 1 |
| 0092453 | links | wit | 820051000 | stuk | 979,00 | 031 | 1 |
| 0092454 | links | noten | 820056000 | stuk | 849,00 | 031 | 1 |

hocker 40x39x32.5cm

| | | | | | | | |
|---------|--|-------|-----------|------|--------|-----|---|
| 0092455 | | wit | 820090000 | stuk | 609,00 | 031 | 1 |
| 0092456 | | noten | 820095000 | stuk | 589,00 | 031 | 1 |

bank 75x35.5x21cm

| | | | | | | | |
|---------|--|-------|-----------|------|--------|-----|---|
| 0092457 | | wit | 820100000 | stuk | 615,00 | 031 | 1 |
| 0092458 | | noten | 820105000 | stuk | 615,00 | 031 | 1 |

kussen voor hocker/bank

| | | | | | | | |
|---------|--|-------|-----------|------|--------|-----|---|
| 0092459 | | wit | 500590000 | stuk | 170,00 | 031 | 1 |
| 0092460 | | grijs | 500600000 | stuk | 170,00 | 031 | 1 |

wastafelplaat m. handdoekhouders 120x50x4cm

| | | | | | | | |
|---------|--|-------|-----------|------|--------|-----|---|
| 0092461 | | wit | 820120000 | stuk | 675,00 | 031 | 1 |
| 0092462 | | noten | 820125000 | stuk | 675,00 | 031 | 1 |

poot voor wastafelplaat per stuk

| | | | | | | | |
|---------|--|--------|-----------|------|--------|-----|---|
| 0092463 | | chroom | 500530000 | stuk | 285,00 | 031 | 1 |
|---------|--|--------|-----------|------|--------|-----|---|

spiegelkast 40x15x188cm

| | | | | | | | |
|---------|--------|-------|-----------|------|---------|-----|---|
| 0092223 | rechts | wit | 820130000 | stuk | 1225,00 | 031 | 1 |
| 0092231 | rechts | noten | 820135000 | stuk | 1105,00 | 031 | 1 |
| 0092258 | links | wit | 820131000 | stuk | 1225,00 | 031 | 1 |
| 0092266 | links | noten | 820136000 | stuk | 1105,00 | 031 | 1 |

lichtspiegelement 40x95cm

| | | | | | | | |
|---------|--|-----|-----------|------|---------|-----|---|
| 0092274 | | wit | 820140000 | stuk | 1005,00 | 031 | 1 |
|---------|--|-----|-----------|------|---------|-----|---|

lichtspiegelement 95x40cm horizontaal

| | | | | | | | |
|---------|--|-----|-----------|------|---------|-----|---|
| 0092290 | | wit | 820145000 | stuk | 1005,00 | 031 | 1 |
|---------|--|-----|-----------|------|---------|-----|---|

lichtspiegelement rond 60cm

| | | | | | | | |
|---------|--|-----|-----------|------|---------|-----|---|
| 0092312 | | wit | 820150000 | stuk | 1050,00 | 031 | 1 |
|---------|--|-----|-----------|------|---------|-----|---|

glazen planchet m. uitsparing

| | | | | | | | |
|---------|---------|--------|-----------|------|--------|-----|---|
| 0092282 | 70x15cm | chroom | 500670000 | stuk | 329,00 | 031 | 1 |
| 0092320 | 95x15cm | chroom | 500690000 | stuk | 355,00 | 031 | 1 |

Sanitair producten

Baden /
douchebakken /
stoomcabines

Kranen

Douchegarnituur







Accessoires en
spiegels

Douchewanden

Toebehoren &
afvoerenSpoel- &
installatiesystemenBadkamermeubelen
en toiletkastenGootstenen en
wastroggen

Utiliteit

| Art.nr | Specificaties | Kleur | Lev.nr | Ehd | Prijs | Grp | CC |
|--|---|----------|------------------|------|---------|-----|----|
| Keramag Joop | | | | | | | |
| glazen planchet z. uitsparing | | | | | | | |
| 0092304 | 95x15cm | chroom | 500695000 | stuk | 339,00 | 031 | 1 |
| Keramag Opus | | | | | | | |
| wastafel | | | | | | | |
| 0081073 | 65x51cm | wit | 120365000 | stuk | 535,00 | 034 | 1 |
| 0081079 | 65x51cm m. KeraTect | wit | 120365600 | stuk | 600,00 | 034 | 1 |
| 0081071 | 75x55cm | wit | 120375000 | stuk | 620,00 | 034 | 1 |
| 0081080 | 75x55cm m. KeraTect | wit | 120375600 | stuk | 685,00 | 034 | 1 |
| 0830097 | bevestigingsset M10x110mm | | 0830097 | paar | 1,09 | 362 | 0 |
| zuil voor wastafel | | | | | | | |
| 0081083 | 55/65cm | wit | 290380000 | stuk | 365,00 | 034 | 1 |
| 0081081 | 75cm | wit | 290300000 | stuk | 445,00 | 034 | 1 |
| fontein | | | | | | | |
| 0086886 | 50x40cm | wit | 270350000 | stuk | 345,00 | 034 | 1 |
| 0081085 | 50x40cm m. KeraTect | wit | 270350600 | stuk | 410,00 | 034 | 1 |
| 0830240 | bevestigingsset voor fontein M8x90mm | | 0830240 | stuk | 0,85 | 362 | 0 |
| duoblokpot multi-uni z. reservoir | | | | | | | |
| 0081076 | | wit | 210300000 | stuk | 955,00 | 034 | 1 |
| 0081084 | m. KeraTect | wit | 210300600 | stuk | 1020,00 | 034 | 1 |
| 0082171 | afvoerset voor closetcombinatie multi AO | | 521170000 | stuk | 74,00 | 034 | 1 |
| 0082821 | afvoerset voor closetcombinatie multi SV/PK | | 521180000 | stuk | 64,00 | 034 | 1 |
| 0830453 | set potschroeven 5.5x60mm chroom | | 0830453 | stuk | 2,28 | 362 | 0 |
| duoblokreervoir dual-flush | | | | | | | |
| 0081191 | | wit | 228350000 | stuk | 399,00 | 035 | 1 |
| wandclosetpot diepspoel | | | | | | | |
| 0081074 | | wit | 203300000 | stuk | 1105,00 | 034 | 1 |
| 0081082 | m. KeraTect | wit | 203300600 | stuk | 1170,00 | 034 | 1 |
| closetzitting m. deksel | | | | | | | |
| 0081190 | | RVS/wit | 573120000 | stuk | 195,00 | 034 | 1 |
| Keramag Plus4 | | | | | | | |
| wandclosetpot diepspoel +4cm | | | | | | | |
| 0080516 | | wit | 202000000 | stuk | 319,00 | 035 | 1 |
| 0080518 | | pergamon | 202000668 | stuk | 413,00 | 035 | 1 |
| 0080517 | m. KeraTect | wit | 202000600 | stuk | 384,00 | 035 | 1 |
| 0080519 | m. KeraTect | pergamon | 202000668 | stuk | 478,00 | 035 | 1 |
| closetzitting dubbel | | | | | | | |
| 0080520 | | wit | 571190000 | stuk | 62,00 | 035 | 1 |
| 0080521 | | pergamon | 571190068 | stuk | 62,00 | 035 | 1 |
| Keramag Public Line | | | | | | | |
| wastafel m. clou overloop | | | | | | | |
| 0084247 | 55cm | wit | 120055000+521061 | stuk | 325,00 | 034 | 1 |
| 0087858 | 55cm | pergamon | 120055068+521061 | stuk | 355,00 | 034 | 1 |
| 0081167 | 55cm m. KeraTect | wit | 120055600+521061 | stuk | 390,00 | 034 | 1 |
| 0081147 | 55cm m. KeraTect | pergamon | 120055668+521061 | stuk | 420,00 | 034 | 1 |
| 0830097 | bevestigingsset M10x110mm | | 0830097 | paar | 1,09 | 362 | 0 |
| wastafel z. clou overloop | | | | | | | |
| 0084875 | 55cm | wit | 120055000 | stuk | 245,00 | 034 | 1 |
| 0084883 | 55cm | pergamon | 120055068 | stuk | 275,00 | 034 | 1 |
| 0081090 | 55cm m. KeraTect | wit | 120055600 | stuk | 310,00 | 034 | 1 |
| 0081091 | 55cm m. KeraTect | pergamon | 120055668 | stuk | 340,00 | 034 | 1 |
| 0083283 | Joly afvoerplug voor wastafel chroom | | 521070000 | stuk | 55,00 | 034 | 1 |
| 0830097 | bevestigingsset M10x110mm | | 0830097 | paar | 1,09 | 362 | 0 |

| Art.nr | Specificaties | Kleur | Lev.nr | Ehd | Prijs | Grp | CC | |
|---|---------------|----------|-----------|------|--------|-----|----|---|
| Keramag Public Line | | | | | | | | |
| sierrozet voor afvoerplug 0084166 | | chrom | 510500000 | stuk | 35,00 | 034 | 1 | |
| Keramag Renova | | | | | | | | |
| fontein m. kraangat m. overloop 0080659 50x38cm | | wit | 272150000 | stuk | 85,00 | 034 | 1 |  |
| closetpot vlakspoel AO 0089044 | m. Keratect | wit | 201011600 | stuk | 208,00 | 035 | 1 |  |
| kunststof reservoir compleet 4.5liter 0087432 | | pergamon | 521031068 | stuk | 117,00 | 035 | 1 |  |
| closetzitting dubbel 0080609 | | RVS | 572165000 | stuk | 75,00 | 034 | 1 | |
| Keramag Renova-Comprimo | | | | | | | | |
| wastafel | | | | | | | |  |
| 0081867 55x41cm | | wit | 222055000 | stuk | 122,00 | 035 | 1 | |
| 0084980 55x41cm | | pergamon | 222055068 | stuk | 150,00 | 035 | 1 | |
| 0081156 55x41cm | m. KeraTect | wit | 222055600 | stuk | 187,00 | 035 | 1 | |
| 0081157 55x41cm | m. KeraTect | pergamon | 222055668 | stuk | 215,00 | 035 | 1 | |
| 0081872 60x38cm | | wit | 221560000 | stuk | 105,00 | 035 | 1 | |
| 0081875 60x38cm | | pergamon | 221560068 | stuk | 160,00 | 035 | 1 | |
| 0081154 60x38cm | m. KeraTect | wit | 221560600 | stuk | 170,00 | 035 | 1 | |
| 0081155 60x38cm | m. KeraTect | pergamon | 221560668 | stuk | 225,00 | 035 | 1 | |
| 0081868 60x44cm | | wit | 222060000 | stuk | 110,00 | 035 | 1 | |
| 0081869 60x44cm | | pergamon | 222060068 | stuk | 155,00 | 035 | 1 | |
| 0081158 60x44cm | m. KeraTect | wit | 222060600 | stuk | 192,00 | 035 | 1 | |
| 0081160 60x44cm | m. KeraTect | pergamon | 222060668 | stuk | 220,00 | 035 | 1 | |
| 0830097 bevestigingsset M10x110mm | | | 0830097 | paar | 1,09 | 362 | 0 | |
| sifonkap voor wastafel 60cm | | | | | | | | |
| 0081866 | | wit | 290821000 | stuk | 115,00 | 035 | 1 | |
| 0081865 | | pergamon | 290821068 | stuk | 140,00 | 035 | 1 | |
| 0083003 kerafix bevestigingsbeugel voor sifonkap | | | 551066000 | stuk | 42,00 | 034 | 0 | |
| wastafel m. planchet=links | | | | | | | |  |
| 0089202 70x40cm | | wit | 122070000 | stuk | 223,00 | 035 | 1 | |
| 0089204 70x40cm | | pergamon | 122070068 | stuk | 266,00 | 035 | 1 | |
| 0081180 70x40cm | m. KeraTect | wit | 122070600 | stuk | 288,00 | 035 | 1 | |
| 0081181 70x40cm | m. KeraTect | pergamon | 122070668 | stuk | 331,00 | 035 | 1 | |
| 0830097 bevestigingsset M10x110mm | | | 0830097 | paar | 1,09 | 362 | 0 | |
| wastafel m. planchet=rechts | | | | | | | |  |
| 0089206 70x40cm | | wit | 122170000 | stuk | 223,00 | 035 | 1 | |
| 0089208 70x40cm | | pergamon | 122170068 | stuk | 266,00 | 035 | 1 | |
| 0081182 70x40cm | m. KeraTect | wit | 122170600 | stuk | 288,00 | 035 | 1 | |
| 0081183 70x40cm | m. KeraTect | pergamon | 122170668 | stuk | 331,00 | 035 | 1 | |
| 0830097 bevestigingsset M10x110mm | | | 0830097 | paar | 1,09 | 362 | 0 | |

Sanitair producten

Baden /
douchebakken /
stoomcabines

Kranen

Douchegarnituur

Accessoires en
spiegels

Douchewanden

Toebehoren &
afvoerenSpoel- &
installatiesystemenBadkamermeubelen
en toiletkastenGootstenen en
wastroggen

Utiliteit

| Art.nr | Specificaties | Kleur | Lev.nr | Ehd | Prijs | Grp | CC |
|--|---------------------------|----------|-----------|------|--------|-----|----|
| Keramag Renova-Comprimo | | | | | | | |
| wastafel hoekmodel | | | | | | | |
| 0089214 | 40cm | wit | 224640000 | stuk | 176,00 | 035 | 1 |
| 0089210 | 40cm | pergamon | 224640068 | stuk | 233,00 | 035 | 1 |
| 0081184 | 40cm m. KeraTect | wit | 224640600 | stuk | 241,00 | 035 | 1 |
| 0081185 | 40cm m. KeraTect | pergamon | 224640668 | stuk | 288,00 | 035 | 1 |
| 0089216 | 55cm | wit | 224655000 | stuk | 210,00 | 035 | 1 |
| 0089218 | 55cm | pergamon | 224655068 | stuk | 280,00 | 035 | 1 |
| 0081187 | 55cm m. KeraTect | wit | 224655600 | stuk | 275,00 | 035 | 1 |
| 0081186 | 55cm m. KeraTect | pergamon | 224655668 | stuk | 345,00 | 035 | 1 |
| 0830097 | bevestigingsset M10x110mm | | 0830097 | paar | 1,09 | 362 | 0 |
| wandclosetpot diepspoel 4.5/6liter | | | | | | | |
| 0089220 | | wit | 204545000 | stuk | 210,00 | 035 | 0 |
| 0089222 | | pergamon | 204545068 | stuk | 260,00 | 035 | 0 |
| 0081188 | m. KeraTect | wit | 204545600 | stuk | 275,00 | 035 | 1 |
| 0081189 | m. KeraTect | pergamon | 204545668 | stuk | 325,00 | 035 | 1 |
| closetzitting dubbel voor wandcloset-48 | | | | | | | |
| 0082573 | | wit | 571044000 | stuk | 79,00 | 035 | 0 |
| 0082579 | | pergamon | 571044068 | stuk | 85,00 | 035 | 0 |
| Keramag Renova-Plan | | | | | | | |
| wastafel m. kraangat m. overloop | | | | | | | |
| 0080522 | 55x44cm | wit | 222255000 | stuk | 93,00 | 035 | 1 |
| 0080524 | 55x44cm | pergamon | 222255068 | stuk | 127,00 | 035 | 1 |
| 0080523 | 55x44cm m. KeraTect | wit | 222255600 | stuk | 158,00 | 035 | 1 |
| 0080525 | 55x44cm m. KeraTect | pergamon | 222255668 | stuk | 192,00 | 035 | 1 |
| 0080526 | 60x48cm | wit | 222260000 | stuk | 97,00 | 035 | 1 |
| 0080528 | 60x48cm | pergamon | 222260068 | stuk | 127,00 | 035 | 1 |
| 0080527 | 60x48cm m. KeraTect | wit | 222260600 | stuk | 162,00 | 035 | 1 |
| 0080529 | 60x48cm m. KeraTect | pergamon | 222260668 | stuk | 192,00 | 035 | 1 |
| 0080530 | 65x48cm | wit | 222265000 | stuk | 113,00 | 035 | 1 |
| 0080532 | 65x48cm | pergamon | 222265068 | stuk | 147,00 | 035 | 1 |
| 0080531 | 65x48cm m. KeraTect | wit | 222265600 | stuk | 178,00 | 035 | 1 |
| 0080533 | 65x48cm m. KeraTect | pergamon | 222265668 | stuk | 212,00 | 035 | 1 |
| 0080534 | 85x48cm | wit | 122185000 | stuk | 290,00 | 035 | 1 |
| 0080536 | 85x48cm | pergamon | 122185068 | stuk | 393,00 | 035 | 1 |
| 0080535 | 85x48cm m. KeraTect | wit | 122185600 | stuk | 355,00 | 035 | 1 |
| 0080537 | 85x48cm m. KeraTect | pergamon | 122185668 | stuk | 458,00 | 035 | 1 |
| 0080538 | 100x48cm | wit | 122100000 | stuk | 400,00 | 035 | 1 |
| 0080540 | 100x48cm | pergamon | 122100068 | stuk | 527,00 | 035 | 1 |
| 0080539 | 100x48cm m. KeraTect | wit | 122100600 | stuk | 465,00 | 035 | 1 |
| 0080541 | 100x48cm m. KeraTect | pergamon | 122100668 | stuk | 592,00 | 035 | 1 |
| 0830097 | bevestigingsset M10x110mm | | 0830097 | paar | 1,09 | 362 | 0 |
| sifonkap voor wastafel | | | | | | | |
| 0080542 | m. Kerafix bevestiging | wit | 292110000 | stuk | 139,00 | 035 | 1 |
| 0080543 | m. Kerafix bevestiging | pergamon | 292110068 | stuk | 159,00 | 035 | 1 |
| Keramag Sinfo | | | | | | | |
| wastafel m. clou overloop | | | | | | | |
| 0087785 | 100x48.5cm | wit | 121000000 | stuk | 729,00 | 034 | 1 |
| 0087807 | 100x48.5cm | pergamon | 121000068 | stuk | 875,00 | 034 | 1 |
| 0081100 | 100x48.5cm m. KeraTect | wit | 121000600 | stuk | 794,00 | 034 | 1 |
| 0081101 | 100x48.5cm m. KeraTect | pergamon | 121000668 | stuk | 940,00 | 034 | 1 |
| 0830097 | bevestigingsset M10x110mm | | 0830097 | paar | 1,09 | 362 | 0 |
| sifonkap voor wastafel | | | | | | | |
| 0087823 | | chrom | 508050000 | stuk | 299,00 | 034 | 1 |
| Keramag Virto | | | | | | | |
| wastafel | | | | | | | |
| 0082589 | 60x48cm | wit | 252560000 | stuk | 189,00 | 034 | 1 |
| 0082597 | 60x48cm | pergamon | 252560068 | stuk | 229,00 | 034 | 1 |
| 0081106 | 60x48cm m. KeraTect | wit | 252560600 | stuk | 254,00 | 034 | 1 |
| 0081107 | 60x48cm m. KeraTect | pergamon | 252560668 | stuk | 294,00 | 034 | 1 |
| 0830097 | bevestigingsset M10x110mm | | 0830097 | paar | 1,09 | 362 | 0 |

| Art.nr | Specificaties | Kleur | Lev.nr | Ehd | Prijs | Grp | CC |
|--|--|--------------|---------------|------|--------|-----|----|
| Keramag Virto | | | | | | | |
| sifonkap voor wastafel | | | | | | | |
| 0082643 | | wit | 291800000 | stuk | 129,00 | 034 | 1 |
| 0082651 | | pergamon | 291800068 | stuk | 160,00 | 034 | 1 |
| 0082686 | kerafix bevestigingsbeugel voor sifonkap Virto | | 551063000 | stuk | 42,00 | 034 | 0 |
| zuil voor wastafel | | | | | | | |
| 0082619 | | wit | 291700000 | stuk | 189,00 | 034 | 1 |
| 0082629 | | pergamon | 291700068 | stuk | 229,00 | 034 | 1 |
| fontein | | | | | | | |
| 0082694 | 50x37cm | wit | 271850000 | stuk | 116,00 | 034 | 1 |
| 0082715 | 50x37cm | pergamon | 271850068 | stuk | 165,00 | 034 | 1 |
| 0081108 | 50x37cm m. KeraTect | wit | 271850600 | stuk | 187,00 | 034 | 1 |
| 0081109 | 50x37cm m. KeraTect | pergamon | 271850668 | stuk | 230,00 | 034 | 1 |
| 0830240 | bevestigingsset voor fontein M8x90mm | | 0830240 | stuk | 0,85 | 362 | 0 |
| sifonkap voor fontein | | | | | | | |
| 0082724 | | wit | 291850000 | stuk | 88,00 | 034 | 1 |
| 0082732 | | pergamon | 291850068 | stuk | 129,00 | 034 | 1 |
| 0082759 | kerafix Virto bevestigingsbeugel | | 551064000 | stuk | 42,00 | 034 | 1 |
| wandclosetpot diepspoel | | | | | | | |
| 0082856 | | wit | 204300000 | stuk | 299,00 | 034 | 1 |
| 0082864 | | pergamon | 204300068 | stuk | 373,00 | 034 | 1 |
| 0081104 | m. KeraTect | wit | 204300600 | stuk | 364,00 | 034 | 1 |
| 0081105 | m. KeraTect | pergamon | 204300668 | stuk | 438,00 | 034 | 1 |
| duoblokpot multi-uni z. reservoir | | | | | | | |
| 0082777 | | wit | 213600000 | stuk | 281,00 | 034 | 1 |
| 0081179 | | pergamon | 213600068 | stuk | 374,00 | 034 | 1 |
| 0087960 | m. KeraTect | wit | 213600600 | stuk | 346,00 | 034 | 1 |
| 0087961 | m. KeraTect | pergamon | 213600668 | stuk | 439,00 | 034 | 1 |
| duoblokreservoir dual-flush | | | | | | | |
| 0081175 | | wit | 229750000 | stuk | 265,00 | 034 | 1 |
| 0081176 | | pergamon | 229750068 | stuk | 295,00 | 034 | 1 |
| closetzitting m. deksel | | | | | | | |
| 0081170 | | RVS/wit | 573060000 | stuk | 129,00 | 034 | 1 |
| 0081171 | | RVS/pergamon | 573060068 | stuk | 138,00 | 034 | 1 |
| boxette compleet met rvs deuren en romp licht peren | | | | | | | |
| 0082688 | | | 876410+876421 | stuk | 438,00 | 035 | 1 |
| zijwand voor Boxette 2stuks | | | | | | | |
| 0082690 | | zilverberk | 876411000 | stuk | 195,00 | 035 | 1 |
| boxette compleet met wit gelakte deuren en romp licht peren | | | | | | | |
| 0082689 | | | 876420+876421 | stuk | 476,00 | 035 | 1 |

Keramag Visit

| | | | | | | | |
|----------------|--------------------------------------|-----|-----------|------|--------|-----|---|
| fontein | | | | | | | |
| 0086347 | 36.5x41.5cm | wit | 276340000 | stuk | 270,00 | 034 | 1 |
| 0081112 | 36.5x41.5cm m. KeraTect | wit | 276340600 | stuk | 335,00 | 034 | 1 |
| 0086355 | 36.5x41.5cm z. kraangat | wit | 276342000 | stuk | 270,00 | 034 | 1 |
| 0081113 | 36.5x41.5cm z. kraangat m. KeraTect | wit | 276342600 | stuk | 335,00 | 034 | 1 |
| 0086363 | 36.5x41.5cm | wit | 276440000 | stuk | 399,00 | 034 | 1 |
| 0081114 | 36.5x41.5cm m. KeraTect | wit | 276440600 | stuk | 464,00 | 034 | 1 |
| 0086371 | 36.5x41.5cm z. kraangat | wit | 276442000 | stuk | 399,00 | 034 | 1 |
| 0081115 | 36.5x41.5cm z. kraangat m. KeraTect | wit | 276442600 | stuk | 464,00 | 034 | 1 |
| 0830240 | bevestigingsset voor fontein M8x90mm | | 0830240 | stuk | 0,85 | 362 | 0 |



Sanitair producten

Baden /
douchebakken /
stoomcabines

Kranen

Douchegarnituur

Accessoires en
spiegels









Douchewanden

Toebehoren &
afvoerenSpoel- &
installatiesystemenBadkamermeubelen
en toiletkastenGootstenen en
wastroggen

Utiliteit



| | Art.nr | Specificaties | Kleur | Lev.nr | Ehd | Prijs | Grp | CC |
|---|--|--|-------------|-------------|------|---------|-----|----|
| Sanitair producten | Keramag Visit | | | | | | | |
| | wandclosetpot diepspoel | | | | | | | |
| | 0086398 | | wit | 206300000 | stuk | 425,00 | 034 | 0 |
| | 0081110 | m. KeraTect | wit | 206300600 | stuk | 490,00 | 034 | 1 |
| Baden / douchebakken / stoomcabines | closetzitting voor 206300 | | | | | | | |
| | 0086630 | | | 571150000 | stuk | 139,00 | 034 | 0 |
| Kranen | halfinbouw urinoir | | | | | | | |
| | 0086401 | | | 236300000 | stuk | 325,00 | 034 | 1 |
| | 0081111 | m. KeraTect | wit | 236300600 | stuk | 390,00 | 034 | 1 |
| Douchegarnituur | 0083380 bevestigingselement voor urinoir wit | | | | | | | |
| | 0083399 | flexibele slang 1/2" m. inlaatverbinder voor urinoir | | 551075000 | stuk | 22,00 | 034 | 0 |
| | 0083399 flexibele slang 1/2" m. inlaatverbinder voor urinoir | | | | | | | |
| | 0083399 | flexibele slang 1/2" m. inlaatverbinder voor urinoir | | 521225000 | stuk | 54,00 | 034 | 0 |
| Accessoires en spiegels | urinoirdeksel voor 236300 | | | | | | | |
| | 0086622 | | | 571155000 | stuk | 105,00 | 034 | 1 |
| Douchewanden | planchet keramisch 32x14cm | | | | | | | |
| | 0086428 | | wit | 298200000 | stuk | 63,00 | 034 | 1 |
| Toebehoren & afvoeren | handdoekrek voor planchet keramisch | | | | | | | |
| | 0086436 | | aluminium | 508060000 | stuk | 155,00 | 034 | 1 |
| Spoel- & installatiesystemen | granietplaat voor fontein 276340/276342 | | | | | | | |
| | 0086444 | | | 800300000 | stuk | 505,00 | 034 | 1 |
| Badkamermeubelen en toiletkasten | Keuco Visit | | | | | | | |
| | wastafelonderbouw | | | | | | | |
| | 0685534 | 24x55x32cm links | zilver/glas | 18101173001 | stuk | 718,00 | 229 | 1 |
| | 0685542 | 24x55x32cm links | wit/wit | 18101510201 | stuk | 744,00 | 229 | 1 |
| | 0685453 | 24x55x32cm rechts | zilver/glas | 18101173002 | stuk | 718,00 | 229 | 1 |
| | 0685488 | 24x55x32cm rechts | wit/wit | 18101510202 | stuk | 744,00 | 229 | 1 |
| Gootstenen en wastroggen | hogekast | | | | | | | |
| | 0685577 | 24x185x24,4 links | zilver/glas | 18103173001 | stuk | 1101,00 | 229 | 1 |
| | 0685585 | 24x185x24,4 links | wit/wit | 18103510201 | stuk | 1141,00 | 229 | 1 |
| | 0685860 | 24x185x24,4 rechts | zilver/glas | 18103173002 | stuk | 1101,00 | 229 | 1 |
| | 0685879 | 24x185x24,4 rechts | wit/wit | 18103510202 | stuk | 1141,00 | 229 | 1 |

| Art.nr | Specificaties | Kleur | Lev.nr | Ehd | Prijs | Grp | CC | | |
|--|--|----------|------------------|------|---------|-----|----|---|---|
| | | | | | | | | Keramag Vitelle | |
| wastafel | | | | | | | | | |
| 0083755 | 60x44cm | wit | 253660000 | stuk | 195,00 | 034 | 1 |  | Sanitair producten |
| 0083763 | 60x44cm | pergamon | 253660068 | stuk | 253,00 | 034 | 1 | | |
| 0081135 | 60x44cm m. KeraTect | wit | 253660600 | stuk | 260,00 | 034 | 1 | | Baden / douchebakken / stoomcabines |
| 0081136 | 60x44cm m. KeraTect | pergamon | 253660668 | stuk | 318,00 | 034 | 1 |  | |
| 0083771 | 65x46cm | wit | 253665000 | stuk | 229,00 | 034 | 1 | | Kranen |
| 0083798 | 65x46cm | pergamon | 253665068 | stuk | 293,00 | 034 | 1 | | |
| 0081137 | 65x46cm m. KeraTect | wit | 253665600 | stuk | 294,00 | 034 | 1 | | Douchegarnituur |
| 0081138 | 65x46cm m. KeraTect | pergamon | 253665668 | stuk | 358,00 | 034 | 1 | | |
| 0083801 | 71x50cm | wit | 253670000 | stuk | 275,00 | 034 | 1 | | Accessoires en spiegels |
| 0083828 | 71x50cm | pergamon | 253670068 | stuk | 353,00 | 034 | 1 | | |
| 0081139 | 71x50cm m. KeraTect | wit | 253670600 | stuk | 340,00 | 034 | 1 | | Douchewanden |
| 0081140 | 71x50cm m. KeraTect | pergamon | 253670668 | stuk | 418,00 | 034 | 1 | | |
| 0083607 | 80x51cm | wit | 123680000 | stuk | 415,00 | 034 | 1 | | Toebehoren & afvoeren |
| 0083615 | 80x51cm | pergamon | 123680068 | stuk | 527,00 | 034 | 1 | | |
| 0081122 | 80x51cm m. KeraTect | wit | 123680600 | stuk | 480,00 | 034 | 1 | | Spoel- & installatiesystemen |
| 0081123 | 80x51cm m. KeraTect | pergamon | 123680668 | stuk | 592,00 | 034 | 1 | | |
| 0089028 | 80x51cm m. clou m. KeraTect | wit | 123780600 | stuk | 564,00 | 034 | 1 | | Badkamermeubelen en toiletkasten |
| 0830097 | bevestigingsset M10x110mm | | 0830097 | paar | 1,09 | 362 | 0 | | |
| wastafel blad rechts m. clou overloop | | | | | | | | | |
| 0080031 | 100x51cm | wit | 120610000 | stuk | 755,00 | 034 | 1 |  | Gootstenen en wastroggen |
| 0083569 | 100x51cm | pergamon | 120610068 | stuk | 900,00 | 034 | 1 | | |
| 0081116 | 100x51cm m. KeraTect | wit | 120610600 | stuk | 820,00 | 034 | 1 | | Utiliteit |
| 0081117 | 100x51cm m. KeraTect | pergamon | 120610668 | stuk | 965,00 | 034 | 1 | | |
| 0830097 | bevestigingsset M10x110mm | | 0830097 | paar | 1,09 | 362 | 0 | | |
| wastafel blad links m. clou overloop | | | | | | | | | |
| 0083577 | 100x51cm | wit | 120615000 | stuk | 755,00 | 034 | 1 |  | Toebehoren & afvoeren |
| 0083585 | 100x51cm | pergamon | 120615068 | stuk | 900,00 | 034 | 1 | | |
| 0081118 | 100x51cm m. KeraTect | wit | 120615600 | stuk | 820,00 | 034 | 1 | | Spoel- & installatiesystemen |
| 0081119 | 100x51cm m. KeraTect | pergamon | 120615668 | stuk | 965,00 | 034 | 1 | | |
| 0830097 | bevestigingsset M10x110mm | | 0830097 | paar | 1,09 | 362 | 0 | | |
| sifonkap voor wastafel | | | | | | | | | |
| 0083852 | 60/65cm | wit | 293620000 | stuk | 125,00 | 034 | 1 | | Badkamermeubelen en toiletkasten |
| 0083860 | 60/65cm | pergamon | 293620068 | stuk | 153,00 | 034 | 1 | | |
| 0083836 | 71/80/100cm | wit | 293610000 | stuk | 139,00 | 034 | 1 | | Gootstenen en wastroggen |
| 0083844 | 71/80/100cm | pergamon | 293610068 | stuk | 173,00 | 034 | 1 | | |
| 0080454 | kerafix bevestigingsbeugel voor sifonkap | | 551067000 | stuk | 42,00 | 034 | 0 | | |
| hoekmeubelwastafel blad rechts m. clou overloop | | | | | | | | | |
| 0083623 | 81x50cm | wit | 124680000+521060 | stuk | 745,00 | 034 | 1 |  | Gootstenen en wastroggen |
| 0083631 | 81x50cm | pergamon | 124680068+521060 | stuk | 953,00 | 034 | 1 | | |
| 0081125 | 81x50cm m. KeraTect | wit | 124680600 | stuk | 810,00 | 034 | 1 | | Utiliteit |
| 0081124 | 81x50cm m. KeraTect | pergamon | 124680668 | stuk | 1018,00 | 034 | 1 | | |
| 0830097 | bevestigingsset M10x110mm | | 0830097 | paar | 1,09 | 362 | 0 | | |
| hoekmeubelwastafel blad links m. clou overloop | | | | | | | | | |
| 0080102 | 81x50cm | wit | 124780000+521060 | stuk | 745,00 | 034 | 1 |  | Utiliteit |
| 0083658 | 81x50cm | pergamon | 124780068+521060 | stuk | 953,00 | 034 | 1 | | |
| 0081126 | 81x50cm m. KeraTect | wit | 124780600 | stuk | 810,00 | 034 | 1 | | Spoel- & installatiesystemen |
| 0081127 | 81x50cm m. KeraTect | pergamon | 124780668 | stuk | 1018,00 | 034 | 1 | | |
| 0830097 | bevestigingsset M10x110mm | | 0830097 | paar | 1,09 | 362 | 0 | | |
| meubelwastafel m. clou overloop | | | | | | | | | |
| 0083542 | 100x53cm | wit | 120600000+521060 | stuk | 730,00 | 034 | 1 |  | Gootstenen en wastroggen |
| 0083550 | 100x53cm | pergamon | 120600068+521060 | stuk | 940,00 | 034 | 1 | | |
| 0081004 | 100x53cm m. KeraTect | wit | 120600600+521060 | stuk | 795,00 | 034 | 1 | | Utiliteit |
| 0081146 | 100x53cm m. KeraTect | pergamon | 120600668+521060 | stuk | 1005,00 | 034 | 1 | | |
| 0080076 | 80x53cm | wit | 120680000 | stuk | 695,00 | 034 | 1 |  | Spoel- & installatiesystemen |
| 0083593 | 80x53cm | pergamon | 120680068 | stuk | 927,00 | 034 | 1 | | |
| 0081120 | 80x53cm m. KeraTect | wit | 120680600 | stuk | 760,00 | 034 | 1 | | Badkamermeubelen en toiletkasten |
| 0081121 | 80x53cm m. KeraTect | pergamon | 120680668 | stuk | 992,00 | 034 | 1 | | |
| 0830097 | bevestigingsset M10x110mm | | 0830097 | paar | 1,09 | 362 | 0 | | |
| wandclosetpot diepspoel 6 liter | | | | | | | | | |
| 0080090 | | wit | 202600000 | stuk | 345,00 | 034 | 1 |  | Utiliteit |
| 0083666 | | pergamon | 202600068 | stuk | 440,00 | 034 | 1 | | |
| 0089036 | m. Keratect | wit | 202600600 | stuk | 410,00 | 034 | 1 | | Spoel- & installatiesystemen |
| 0081128 | m. KeraTect | pergamon | 202600668 | stuk | 505,00 | 034 | 1 | | |

| | Art.nr | Specificaties | Kleur | Lev.nr | Ehd | Prijs | Grp | CC |
|---|---|---|--------------|-----------|------|--------|-----|----|
| | Keramag Vitelle | | | | | | | |
| | wandclosetpot vlakspoel 6 liter | | | | | | | |
| Sanitair producten | 0083674 | | wit | 202700000 | stuk | 415,00 | 034 | 1 |
| | 0083682 | | pergamon | 202700068 | stuk | 527,00 | 034 | 1 |
| | 0081129 | m. KeraTect | wit | 202700600 | stuk | 480,00 | 034 | 1 |
| | 0081130 | m. KeraTect | pergamon | 202700668 | stuk | 592,00 | 034 | 1 |
| | closetzitting dubbel | | | | | | | |
| Baden / douchebakken / stoomcabines | 0080080 | | chrom/wit | 573620000 | stuk | 129,00 | 034 | 1 |
| | 0083879 | | chrom/perg. | 573620068 | stuk | 139,00 | 034 | 1 |
| | wandbidet m. clou overloop | | | | | | | |
| Kranen | 0083739 | | wit | 233600000 | stuk | 499,00 | 034 | 1 |
| | 0083747 | | pergamon | 233600068 | stuk | 633,00 | 034 | 1 |
| | 0081133 | m. KeraTect | wit | 233600600 | stuk | 564,00 | 034 | 1 |
| | 0081134 | m. KeraTect | pergamon | 233600668 | stuk | 698,00 | 034 | 1 |
| | zitrand voor bidet | | | | | | | |
| Accessoires en spiegels | 0083887 | | wit | 573630000 | stuk | 65,00 | 034 | 1 |
| | 0083895 | | pergamon | 573630068 | stuk | 73,00 | 034 | 1 |
| | duoblokpot universeel z. reservoir | | | | | | | |
| Douchewanden | 0083690 | | wit | 212600000 | stuk | 440,00 | 034 | 1 |
| | 0083704 | | pergamon | 212600068 | stuk | 553,00 | 034 | 1 |
| | 0081131 | m. KeraTect | wit | 212600600 | stuk | 505,00 | 034 | 1 |
| | 0081132 | m. KeraTect | pergamon | 212600668 | stuk | 618,00 | 034 | 1 |
| | 0082171 afvoerset voor closetcombinatie multi AO | | | | | | | |
| Toebehoren & afvoeren | 0082821 | afvoerset voor closetcombinatie multi SV/PK | | 521180000 | stuk | 64,00 | 034 | 1 |
| | 0083208 | vloerbevestiging Kerafix voor bidet/duoblok | | 551060000 | stuk | 33,00 | 034 | 1 |
| | duoblokreservoir dual-flush | | | | | | | |
| Spoel- & installatiesystemen | 0081168 | | wit | 227650000 | stuk | 275,00 | 034 | 1 |
| | 0081203 | | pergamon | 227650068 | stuk | 353,00 | 034 | 1 |
| | wastafelonderbouw | | | | | | | |
| Badkamermeubelen en toiletkasten | 0083917 | 70x34x67cm | peren | 810030000 | stuk | 675,00 | 034 | 1 |
| | 0080082 | 70x34x67cm | kersen | 810031000 | stuk | 675,00 | 034 | 1 |
| | 0083925 | 90x34x67cm | peren | 810035000 | stuk | 745,00 | 034 | 1 |
| | 0083933 | 90x34x67cm | kersen | 810036000 | stuk | 745,00 | 034 | 1 |
| | 0080084 | greep voor wastafelonderbouw | chrom | 590550000 | stuk | 26,00 | 034 | 1 |
| | greep voor wastafelonderbouw | | | | | | | |
| Gootstenen en wastroggen | 0080084 | | chrom | 590550000 | stuk | 26,00 | 034 | 1 |
| | hoekwastafel onderkast planchet rechts | | | | | | | |
| Utiliteit | 0084026 | | peren/wit | 810140000 | stuk | 655,00 | 034 | 1 |
| | 0084034 | | peren/perg. | 810145000 | stuk | 655,00 | 034 | 1 |
| | 0084042 | | kersen/wit | 810150000 | stuk | 655,00 | 034 | 1 |
| | 0084050 | | kersen/perg. | 810155000 | stuk | 655,00 | 034 | 1 |
| | hoekwastafel onderkast planchet links | | | | | | | |
| | 0080005 | | peren/wit | 810160000 | stuk | 655,00 | 034 | 1 |
| | 0084069 | | peren/perg. | 810165000 | stuk | 655,00 | 034 | 1 |
| | 0080104 | | kersen/wit | 810170000 | stuk | 655,00 | 034 | 1 |
| | 0084077 | | kersen/perg. | 810175000 | stuk | 655,00 | 034 | 1 |
| | boxette | | | | | | | |
| | 0088277 | 30x28.5x55cm | wit | 811100000 | stuk | 455,00 | 034 | 1 |
| | 0080016 | 30x28.5x55 | peren/wit | 810100000 | stuk | 495,00 | 034 | 1 |
| | 0083941 | 30x28.5x55 | peren/perg. | 810105000 | stuk | 495,00 | 034 | 1 |
| | 0083968 | 30x28.5x55 | kersen/wit | 810110000 | stuk | 495,00 | 034 | 1 |
| | 0083976 | 30x28.5x55 | kersen/perg. | 810115000 | stuk | 495,00 | 034 | 1 |
| | 0088285 | 38.5x34x55 | wit | 811120000 | stuk | 475,00 | 034 | 1 |
| | 0080017 | 38.5x34x55 | peren/wit | 810120000 | stuk | 520,00 | 034 | 1 |
| | 0083984 | 38.5x34x55 | peren/perg. | 810125000 | stuk | 520,00 | 034 | 1 |
| | 0083992 | 38.5x34x55 | kersen/wit | 810130000 | stuk | 520,00 | 034 | 1 |
| | 0084018 | 38.5x34x55 | kersen/perg. | 810135000 | stuk | 520,00 | 034 | 1 |

| Art.nr | Specificaties | Kleur | Lev.nr | Ehd | Prijs | Grp | CC |
|--------|---------------|-------|--------|-----|-------|-----|----|
|--------|---------------|-------|--------|-----|-------|-----|----|

Keramag Vitelle

verrijdbaar zitmeubel

| | | | | | | | |
|---------|--|--------------|-----------|------|--------|-----|---|
| 0084085 | | peren/beige | 890050000 | stuk | 539,00 | 034 | 1 |
| 0084093 | | peren/bruin | 890051000 | stuk | 539,00 | 034 | 1 |
| 0084107 | | kersen/beige | 890060000 | stuk | 539,00 | 034 | 1 |
| 0084115 | | kersen/bruin | 890061000 | stuk | 539,00 | 034 | 1 |



Sanitair producten

Baden /
douchebakken /
stoomcabines

greep voor verrijdbaar zitmeubel

| | | | | | | | |
|---------|--|-------|-----------|------|-------|-----|---|
| 0083909 | | chrom | 590560000 | stuk | 22,00 | 034 | 1 |
|---------|--|-------|-----------|------|-------|-----|---|

hoge kast m. schuiflade

| | | | | | | | |
|---------|------------|--------------|-----------|------|--------|-----|---|
| 0088293 | 39x184.5cm | peren/wit | 811000000 | stuk | 985,00 | 034 | 1 |
| 0088307 | 39x184.5cm | peren/perg. | 811005000 | stuk | 985,00 | 034 | 1 |
| 0088315 | 39x184.5cm | kersen/wit | 811010000 | stuk | 985,00 | 034 | 1 |
| 0088323 | 39x184.5cm | kersen/perg. | 811015000 | stuk | 985,00 | 034 | 1 |



Kranen

Douchegarnituur

hangkast

| | | | | | | | |
|---------|------------|--------------|-----------|------|--------|-----|---|
| 0088331 | 30x22.7x80 | peren/wit | 811060000 | stuk | 425,00 | 034 | 1 |
| 0088358 | 30x22.7x80 | peren/perg. | 811065000 | stuk | 425,00 | 034 | 1 |
| 0088366 | 30x22.7x80 | kersen/wit | 811070000 | stuk | 425,00 | 034 | 1 |
| 0088374 | 30x22.7x80 | kersen/perg. | 811075000 | stuk | 425,00 | 034 | 1 |

Accessoires en
spiegels

Douchewanden

meubelzijkast m. schuiflade

| | | | | | | | |
|---------|-----------|--------------|-----------|------|--------|-----|---|
| 0088382 | 30x84.5cm | peren/wit | 811030000 | stuk | 475,00 | 034 | 1 |
| 0088390 | 30x84.5cm | peren/perg. | 811035000 | stuk | 475,00 | 034 | 1 |
| 0088404 | 30x84.5cm | kersen/wit | 811040000 | stuk | 475,00 | 034 | 1 |
| 0088412 | 30x84.5cm | kersen/perg. | 811045000 | stuk | 475,00 | 034 | 1 |

Toebehoren &
afvoerenSpoel- &
installatiesystemen

afdekplaat voor meubelzijkast keramisch

| | | | | | | | |
|---------|-----------|----------|-----------|------|-------|-----|---|
| 0088420 | 30x33.5cm | wit | 293670000 | stuk | 52,00 | 034 | 1 |
| 0088439 | 30x33.5cm | pergamon | 293670068 | stuk | 67,00 | 034 | 1 |

meubelzijkast m. schuiflade

| | | | | | | | | |
|---------|-------------|--------|--------|-----------|------|--------|-----|---|
| 0088447 | 27.5x84.5cm | rechts | peren | 811050000 | stuk | 369,00 | 034 | 1 |
| 0088455 | 27.5x84.5cm | rechts | kersen | 811055000 | stuk | 369,00 | 034 | 1 |
| 0088463 | 27.5x84.5cm | links | peren | 811052000 | stuk | 369,00 | 034 | 1 |
| 0088471 | 27.5x84.5cm | links | kersen | 811057000 | stuk | 369,00 | 034 | 1 |

Badkamermeubelen
en toiletkastenGootstenen en
wastroggen

afdekplaat voor meubelzijkast keramisch

| | | | | | | | |
|---------|-----------|-----|-----------|------|-------|-----|---|
| 0088498 | 28x27.5cm | wit | 293660000 | stuk | 48,00 | 034 | 1 |
|---------|-----------|-----|-----------|------|-------|-----|---|

hoge kast m. schuiflade

| | | | | | | | | |
|---------|--------------|--------|--------|-----------|------|--------|-----|---|
| 0088501 | 36.5x184.5cm | rechts | peren | 811020000 | stuk | 829,00 | 034 | 1 |
| 0088528 | 36.5x184.5cm | rechts | kersen | 811025000 | stuk | 829,00 | 034 | 1 |
| 0088536 | 36.5x184.5cm | links | peren | 811022000 | stuk | 829,00 | 034 | 1 |
| 0088544 | 36.5x184.5cm | links | kersen | 811027000 | stuk | 829,00 | 034 | 1 |



Utiliteit

hangkast

| | | | | | | | |
|---------|------------|--------|-----------|------|--------|-----|---|
| 0088552 | 27.5x17x80 | peren | 811080000 | stuk | 280,00 | 034 | 1 |
| 0088560 | 27.5x17x80 | kersen | 811085000 | stuk | 280,00 | 034 | 1 |



| Art.nr | Specificaties | Kleur | Lev.nr | Ehd | Prijs | Grp | CC |
|--------|---------------|-------|--------|-----|-------|-----|----|
|--------|---------------|-------|--------|-----|-------|-----|----|

Keramag Vitelle

rek

| | | | | | | | |
|---------|------------|--------|-----------|------|--------|-----|---|
| 0088579 | 27.5x15x80 | peren | 811090000 | stuk | 205,00 | 034 | 1 |
| 0088587 | 27.5x15x80 | kersen | 811095000 | stuk | 205,00 | 034 | 1 |



Sanitair producten

Baden /
douchebakken /
stoomcabines

Kranen

Douchegarnituur

Accessoires en
spiegels



spiegelkast

| | | | | | | | |
|---------|------------|--------|-----------|------|--------|-----|---|
| 0088595 | 58x10x80cm | peren | 811130000 | stuk | 859,00 | 034 | 1 |
| 0088609 | 58x10x80cm | kersen | 811135000 | stuk | 859,00 | 034 | 1 |
| 0088617 | 70x10x80cm | peren | 811140000 | stuk | 969,00 | 034 | 1 |
| 0088625 | 70x10x80cm | kersen | 811145000 | stuk | 969,00 | 034 | 1 |



Douchewanden

Toebehoren &
afvoeren

Spoel- &
installatiesystemen

Badkamermeubelen
en toiletkasten

Gootstenen en
wastroggen

Utiliteit

Keramag Vivano

wastafel

| | | | | | | | |
|---------|---------------------------|-------------|-----------|------|--------|-----|---|
| 0085383 | 60x43cm | wit | 250760000 | stuk | 199,00 | 034 | 1 |
| 0081144 | 60x43cm | m. KeraTect | 250762600 | stuk | 264,00 | 034 | 1 |
| 0830097 | bevestigingsset M10x110mm | | 0830097 | paar | 1,09 | 362 | 0 |



wastafel z. kraangat m. overloop

| | | | | | | | |
|---------|---------------------------|-------------|-----------|------|--------|-----|---|
| 0086770 | 60x43cm | wit | 250762000 | stuk | 199,00 | 034 | 1 |
| 0081143 | 60x43cm | m. KeraTect | 250760600 | stuk | 264,00 | 034 | 1 |
| 0086789 | 65x47cm | wit | 250767000 | stuk | 229,00 | 034 | 1 |
| 0081145 | 65x47cm | m. KeraTect | 250767600 | stuk | 294,00 | 034 | 1 |
| 0830097 | bevestigingsset M10x110mm | | 0830097 | paar | 1,09 | 362 | 0 |



hoekwastafel rechts

| | | | | | | | |
|---------|---------------------------|---------------------|------------------|------|--------|-----|---|
| 0085391 | 80x52,5cm | m. clou | 120780000+521060 | stuk | 645,00 | 034 | 1 |
| 0081141 | 80x52,5cm | m. clou m. KeraTect | 120780600 | stuk | 710,00 | 034 | 1 |
| 0085405 | 80x52,5cm | z. clou | 120780000 | stuk | 645,00 | 034 | 1 |
| 0830097 | bevestigingsset M10x110mm | | 0830097 | paar | 1,09 | 362 | 0 |



hoekwastafel links

| | | | | | | | |
|---------|---------------------------|---------------------|------------------|------|--------|-----|---|
| 0085413 | 80x52,5cm | m. clou | 120880000+521060 | stuk | 645,00 | 034 | 1 |
| 0081142 | 80x52,5cm | m. clou m. KeraTect | 120880600 | stuk | 710,00 | 034 | 1 |
| 0085421 | 80x52,5cm | z. clou | 120880000 | stuk | 645,00 | 034 | 1 |
| 0830097 | bevestigingsset M10x110mm | | 0830097 | paar | 1,09 | 362 | 0 |

sifonkap voor wastafel

| | | | | | | | |
|---------|--|---------------|-----------|------|--------|-----|---|
| 0084409 | | wit | 294710000 | stuk | 129,00 | 034 | 1 |
| 0084468 | | hoogglans RVS | 508030000 | stuk | 149,00 | 034 | 1 |

wandclosetpot diepspoel

| | | | | | | | |
|---------|--|-------------|-----------|------|--------|-----|---|
| 0084662 | | wit | 207500000 | stuk | 299,00 | 034 | 0 |
| 0081048 | | m. KeraTect | 207500600 | stuk | 364,00 | 034 | 1 |



closetcombinatie diepspoel

| | | | | | | | |
|---------|---|-----|---------------|------|--------|-----|---|
| 0085898 | | wit | 200400+227320 | stuk | 670,00 | 034 | 1 |
| 0082171 | afvoerset voor closetcombinatie multi AO | | 521170000 | stuk | 74,00 | 034 | 1 |
| 0082821 | afvoerset voor closetcombinatie multi SV/PK | | 521180000 | stuk | 64,00 | 034 | 1 |
| 0083208 | vloerbevestiging Kerafix voor bidet/duoblok | | 551060000 | stuk | 33,00 | 034 | 1 |



| Art.nr | Specificaties | Kleur | Lev.nr | Ehd | Prijs | Grp | CC |
|--------|---------------|-------|--------|-----|-------|-----|----|
|--------|---------------|-------|--------|-----|-------|-----|----|

Keramag Vivano

duoblokpot universeel diepspoel z. reservoir

| | | | | | | | |
|---------|---|-----|-----------|------|--------|-----|---|
| 0085812 | | wit | 200400000 | stuk | 395,00 | 034 | 1 |
| 0082171 | afvoerset voor closetcombinatie multi AO | | 521170000 | stuk | 74,00 | 034 | 1 |
| 0082821 | afvoerset voor closetcombinatie multi SV/PK | | 521180000 | stuk | 64,00 | 034 | 1 |
| 0083208 | vloerbevestiging Kerafix voor bidet/duoblok | | 551060000 | stuk | 33,00 | 034 | 1 |



Sanitair producten

Baden /
douchebakken /
stoomcabines**duoblokreservoir + binnenwerk m. duospoeling**

| | | | | | | | |
|---------|--|-----|-----------|------|--------|-----|---|
| 0084492 | | wit | 227320000 | stuk | 275,00 | 034 | 1 |
|---------|--|-----|-----------|------|--------|-----|---|



Kranen

Douchegarnituur

closetzitting dubbel

| | | | | | | | |
|---------|--|-----|-----------|------|--------|-----|---|
| 0084522 | | wit | 574900000 | stuk | 119,00 | 034 | 0 |
|---------|--|-----|-----------|------|--------|-----|---|

wandbidet

| | | | | | | | |
|---------|-------------|-----|-----------|------|--------|-----|---|
| 0084670 | | wit | 234300000 | stuk | 355,00 | 034 | 1 |
| 0081049 | m. KeraTect | wit | 234300600 | stuk | 420,00 | 034 | 1 |

Accessoires en
spiegels

Douchewanden

zitrand voor bidet

| | | | | | | | |
|---------|--|-----|-----------|------|-------|-----|---|
| 0084530 | | wit | 574910000 | stuk | 60,00 | 034 | 1 |
|---------|--|-----|-----------|------|-------|-----|---|

spiegel m. verlichting horizontaal

| | | | | | | | |
|---------|----------|--|-----------|------|--------|-----|---|
| 0084549 | 120x40mm | | 800280000 | stuk | 465,00 | 034 | 1 |
|---------|----------|--|-----------|------|--------|-----|---|

Toebehoren &
afvoerenSpoel- &
installatiesystemen**spiegel m. verlichting verticaal**

| | | | | | | | |
|---------|----------|--|-----------|------|--------|-----|---|
| 0084557 | 35x100mm | | 800270000 | stuk | 355,00 | 034 | 1 |
|---------|----------|--|-----------|------|--------|-----|---|

Badkamermeubelen
en toiletkastenGootstenen en
wastroggen**wastafelonderkast**

| | | | | | | | | |
|---------|------------|--------|------------|---------------|------|--------|-----|---|
| 0086797 | 35x31x52.5 | rechts | lichtgrijs | 800210+508035 | stuk | 530,00 | 034 | 1 |
| 0086800 | 35x31x52.5 | links | lichtgrijs | 800215+508035 | stuk | 530,00 | 034 | 1 |



Utiliteit



wastafel onderkast











| | | | | | | | | |
|---------|------------|--|------------|---------------|------|--------|-----|---|
| 0086819 | 52.5x31x35 | | lichtgrijs | 800200+508035 | stuk | 580,00 | 034 | 1 |
|---------|------------|--|------------|---------------|------|--------|-----|---|











**wastafelonderkast 2xdeur**

| | | | | | | | | |
|---------|------------|--|------------|----------------|------|--------|-----|---|
| 0086827 | 70x31x52.5 | | lichtgrijs | 8002200+508035 | stuk | 710,00 | 034 | 1 |
|---------|------------|--|------------|----------------|------|--------|-----|---|



| | Art.nr | Specificaties | Kleur | Lev.nr | Ehd | Prijs | Grp | CC |
|---|---|--|----------------|-----------|---------|---------|-----|----|
| Sanitair producten | Keramag Vivano | | | | | | | |
| | hoge kast | | | | | | | |
| | 0086843 | 35x31x104cm rechts | lichtgrijs/mat | 800250000 | stuk | 675,00 | 034 | 1 |
| | 0086851 | 35x31x104cm links | lichtgrijs/mat | 800255000 | stuk | 675,00 | 034 | 1 |
| Baden / douchebakken / stoomcabines |  | | | | | | | |
| Kranen | Keramag Aller | | | | | | | |
| | wandurinoir z. sifon achterinlaat | | | | | | | |
| | 0082015 | | wit | 236500000 | stuk | 208,00 | 035 | 1 |
| | 0082031 | | pergamon | 236500068 | stuk | 267,00 | 035 | 1 |
| | 0082023 | | manhattan | 236500010 | stuk | 267,00 | 035 | 1 |
| Douchegarnituur | 0300748 | bevestigingsset compleet m. sierkappen M10 | chrom | 0300748 | stuk | 3,56 | 362 | 0 |
| | wandurinoir z. sifon boveninlaat | | | | | | | |
| | 0081973 | | wit | 236600000 | stuk | 220,00 | 035 | 1 |
| | 0082007 | | pergamon | 236600068 | stuk | 273,00 | 035 | 1 |
| Accessoires en spiegels | 0081981 | | manhattan | 236600010 | stuk | 273,00 | 035 | 1 |
| | 0300748 | bevestigingsset compleet m. sierkappen M10 | chrom | 0300748 | stuk | 3,56 | 362 | 0 |
| | hoekurinoir z. sifon achterinlaat | | | | | | | |
| | 0082473 | | wit | 236800000 | stuk | 525,00 | 035 | 1 |
| Douchewanden |  | | | | | | | |
| Toebehoren & afvoeren | hoekurinoir z. sifon boveninlaat | | | | | | | |
| | 0082465 | | wit | 236700000 | stuk | 410,00 | 035 | 1 |
| | hoekurinoir m. flushcontrol | | | | | | | |
| 0082247 | | wit | 236858000 | stuk | 1012,00 | 034 | 1 | |
| 0082248 | m. KeraTect | wit | 236858600 | stuk | 1077,00 | 034 | 1 | |
| Spoel- & installatiesystemen | hoekurinoir m. flushcontrol m. kaars | | | | | | | |
| | 0082251 | | wit | 236868000 | stuk | 1047,00 | 034 | 1 |
| | 0082253 | m. KeraTect | wit | 236868600 | stuk | 1068,00 | 034 | 1 |
| Badkamermeubelen en toiletkasten | Keramag Centauris | | | | | | | |
| | urinoir 90 m. bevestigingsset m. vlieg | | | | | | | |
| 0236609 | m. Ceratect | wit | 236450600 | stuk | 580,00 | 034 | 1 | |
| Gootstenen en wastroggen | urinoir 90 watervrij m. bevestigingsset m. vlieg | | | | | | | |
| | 0236610 | m. Ceratect | wit | 236400600 | stuk | 540,00 | 034 | 1 |
| Utiliteit |  | | | | | | | |
| Utiliteit | Keramag Coppelia | | | | | | | |
| | planchet | | | | | | | |
| | 0080411 | 60x14cm | wit | 299260000 | stuk | 60,00 | 035 | 1 |
| | 0080412 | 60x14cm | pergamon | 299260068 | stuk | 81,00 | 035 | 1 |
| | 0830453 | set potschroeven 5.5x60mm | chrom | 0830453 | stuk | 2,28 | 362 | 0 |
| Utiliteit | Keramag Espital | | | | | | | |
| | uitstortgootsteen m. emmerrooster | | | | | | | |
| | 0081092 | | | 215000000 | stuk | 720,00 | 035 | 1 |
| emmerrooster voor Keramag Hospiz | | | | | | | | |
| 0970506 | | | 533040001 | stuk | 63,07 | 362 | 1 | |
| Utiliteit | Keramag Emani | | | | | | | |
| | wastafel | | | | | | | |
| | 0080775 | 70x53cm | wit | 125870000 | stuk | 390,00 | 034 | 1 |
| | 0080776 | 84x53cm | wit | 125884000 | stuk | 435,00 | 034 | 1 |
| | wastafel voor onderbouw | | | | | | | |
| 0080777 | 120x53cm | wit | 125820000 | stuk | 700,00 | 034 | 1 | |

| Art.nr | Specificaties | Kleur | Lev.nr | Ehd | Prijs | Grp | CC | | |
|---|---|-------|-----------|------|---------|-----|----|---|---|
| | | | | | | | | Keramag Emani | |
| opbouwastafel ovaal 0080663 | 70x43.4cm | wit | 124870000 | stuk | 378,00 | 034 | 1 |  | Sanitair producten |
| opbouwastafel rechthoekig 0080664 | 70x43.4cm | wit | 124970000 | stuk | 379,00 | 034 | 1 |  | Baden / douchebakken / stoomcabines |
| opbouwastafel ovaal m. kraanplateau 0080665 | 70x53cm | wit | 224870000 | stuk | 379,00 | 034 | 1 |  | Kranen |
| staand bidet 0080781 | | wit | 230800000 | stuk | 455,00 | 034 | 1 |  | Douchegarnituur |
| wandbidet 0080782 | | wit | 233800000 | stuk | 475,00 | 034 | 1 |  | Accessoires en spiegels |
| wandclosetpot diepspoel 0080779 | | wit | 207800000 | stuk | 559,00 | 034 | 1 |  | Douchewanden |
| closetpot staand diepspoel 0080778 | | wit | 212800000 | stuk | 640,00 | 034 | 1 |  | Toebehoren & afvoeren |
| 0082821 | afvoerset voor closetcombinatie multi SV/PK | | 521180000 | stuk | 64,00 | 034 | 1 |  | Spoel- & installatiesystemen |
| closetzitting dubbel 0080780 | | wit | 575800000 | stuk | 190,00 | 034 | 1 |  | Badkamermeubelen en toiletkasten |
| | | | | | | | | Keramag Flurinal | |
| wandurinoir z. sifon achterafvoer 0082104 | | wit | 577230000 | stuk | 1210,00 | 369 | 1 |  | Gootstenen en wastroggen |
| | | | | | | | | Utiliteit | |

| | Art.nr | Specificaties | Kleur | Lev.nr | Ehd | Prijs | Grp | CC |
|---|---|--|-------------|-----------|------|--------|-----|----|
| Sanitair producten | Keramag Kind | | | | | | | |
| |  | kinderclosetpot diepspoel 0082094 | wit | 201700000 | stuk | 255,00 | 035 | 1 |
| Baden / douchebakken / stoomcabines | kinderclosetzitting dubbel | | | | | | | |
| | | 0082092 | chroom/wit | 573334000 | stuk | 90,00 | 035 | 1 |
| | | 0080156 | chroom/rood | 573337000 | stuk | 95,00 | 035 | 1 |
| Kranen | Keramag Paracelsus | | | | | | | |
| |  | wastafel | | | | | | |
| | | 0080039 64x49cm | wit | 251060000 | stuk | 270,00 | 035 | 0 |
| | | 0080033 64x49cm | pergamon | 251060068 | stuk | 365,00 | 035 | 1 |
| Douchegarnituur | | 0830097 bevestigingsset M10x110mm | | 0830097 | paar | 1,09 | 362 | 0 |
| Accessoires en spiegels | Keramag Preciosa | | | | | | | |
| |  | fontein | | | | | | |
| | | 0088935 33x41cm | wit | 272033000 | stuk | 182,00 | 034 | 1 |
| | | 0088943 33x41cm | pergamon | 272033068 | stuk | 220,00 | 034 | 1 |
| | | 0081102 33x41cm m. KeraTect | wit | 272033600 | stuk | 247,00 | 034 | 1 |
| | | 0830240 bevestigingsset voor fontein M8x90mm | | 0830240 | stuk | 0,85 | 362 | 0 |
| Douchewanden | hoekfontein | | | | | | | |
| |  | 0082067 33x45cm | wit | 272034000 | stuk | 235,00 | 034 | 1 |
| | | 0082069 33x45cm m. KeraTect | wit | 272034600 | stuk | 300,00 | 034 | 1 |
| Toebehoren & afvoeren | | | | | | | | |
| Spoel- & installatiesystemen | wastafel | | | | | | | |
| |  | 0082058 60x55cm | wit | 253200000 | stuk | 215,00 | 035 | 1 |
| | | 0081089 60x55cm m. KeraTect | wit | 253200600 | stuk | 280,00 | 034 | 1 |
| | | 0082503 80x55cm | wit | 124280000 | stuk | 435,00 | 035 | 1 |
| | | 0081087 80x55cm m. KeraTect | wit | 124280600 | stuk | 500,00 | 034 | 1 |
| Badkamermeubelen en toiletkasten | | 0082066 100x55cm | wit | 124200000 | stuk | 575,00 | 035 | 1 |
| | | 0081086 100x55cm m. KeraTect | wit | 124200600 | stuk | 640,00 | 034 | 1 |
| | | 0830097 bevestigingsset M10x110mm | | 0830097 | paar | 1,09 | 362 | 0 |
| Gootstenen en wastroggen |  | | | | | | | |
| | | | | | | | | |
| Utiliteit | dubbele wastafel | | | | | | | |
| |  | 0082430 130x55cm | wit | 133200000 | stuk | 787,00 | 035 | 1 |
| | | 0081088 130x55cm m. KeraTect | wit | 133200600 | stuk | 852,00 | 034 | 1 |
| | | 0830097 bevestigingsset M10x110mm | | 0830097 | paar | 1,09 | 362 | 0 |
| | opbouwastafel z. kraangat z. overloop | | | | | | | |
| |  | 0089302 38cm | wit | 248010000 | stuk | 235,00 | 034 | 1 |
| | opbouwastafel z. kraangat m. overloop | | | | | | | |
| |  | 0089304 46cm | wit | 248000000 | stuk | 255,00 | 034 | 1 |
| | | 0087967 46cm m. KeraTect | wit | 248000600 | stuk | 320,00 | 034 | 1 |
| | inbouwastafel m. kraangat | | | | | | | |
| |  | 0089306 42cm | wit | 248110000 | stuk | 255,00 | 034 | 1 |
| | | 0087968 42cm m. KeraTect | wit | 248110600 | stuk | 320,00 | 034 | 1 |
| | | 0089308 50cm | wit | 248100000 | stuk | 285,00 | 034 | 1 |
| | | 0087969 50cm m. KeraTect | wit | 248100600 | stuk | 350,00 | 034 | 1 |

| Art.nr | Specificaties | Kleur | Lev.nr | Ehd | Prijs | Grp | CC |
|--------|---------------|-------|--------|-----|-------|-----|----|
|--------|---------------|-------|--------|-----|-------|-----|----|

Keramag Preciosa

inbouw wastafel z. kraangat

| | | | | | | | |
|---------|------|-------------|-----|-----------|------|--------|-------|
| 0089310 | 46cm | | wit | 248120000 | stuk | 255,00 | 034 1 |
| 0087952 | 46cm | m. KeraTect | wit | 248120600 | stuk | 320,00 | 034 1 |



Sanitair producten

Baden /
douchebakken /
stoomcabines

onderbouw wastafel m. kraangat

| | | | | | | | |
|---------|------|-------------|-----|-----------|------|--------|-------|
| 0089312 | 35cm | | wit | 248210000 | stuk | 255,00 | 034 1 |
| 0087953 | 35cm | m. KeraTect | wit | 248210600 | stuk | 320,00 | 034 1 |
| 0089314 | 42cm | | wit | 248200000 | stuk | 285,00 | 034 1 |
| 0087954 | 42cm | m. KeraTect | wit | 248200600 | stuk | 350,00 | 034 1 |



Kranen

Douchegarnituur

onderbouw wastafel z. kraangat

| | | | | | | | |
|---------|------|-------------|-----|-----------|------|--------|-------|
| 0089316 | 38cm | | wit | 248220000 | stuk | 255,00 | 034 1 |
| 0087956 | 38cm | m. KeraTect | wit | 248220600 | stuk | 320,00 | 034 1 |

Accessoires en
spiegels

wandclosetpot diepspoel

| | | | | | | | |
|---------|--|-------------|-----|-----------|------|--------|-------|
| 0089318 | | | wit | 208000000 | stuk | 425,00 | 034 1 |
| 0087957 | | m. Keratect | wit | 208000600 | stuk | 490,00 | 034 1 |



Douchewanden

closetzitting dubbel

| | | | | | | | |
|---------|--|--|-----|-----------|------|--------|-------|
| 0089319 | | | wit | 571180000 | stuk | 155,00 | 034 1 |
|---------|--|--|-----|-----------|------|--------|-------|

Toebehoren &
afvoeren

Keramag Sensonal

urinoir m. flushcontrol

| | | | | | | | |
|---------|----------------------|--|-----|-----------|------|--------|-------|
| 0082254 | batterij | | wit | 237506000 | stuk | 850,00 | 034 1 |
| 0082255 | batterij m. KeraTect | | wit | 237506600 | stuk | 915,00 | 034 1 |
| 0082256 | 230V | | wit | 237518000 | stuk | 875,00 | 034 1 |
| 0082257 | 230V m. KeraTect | | wit | 237518600 | stuk | 940,00 | 034 1 |

Spoel- &
installatiesystemenBadkamermeubelen
en toiletkasten

Keramag Separo

urinoirschot

| | | | | | | | |
|---------|-----------|-----------|-----|-----------|------|--------|-------|
| 0082246 | 85x44.5cm | satinglas | wit | 520000000 | stuk | 280,00 | 034 1 |
|---------|-----------|-----------|-----|-----------|------|--------|-------|

Gootstenen en
wastroggen

Keramag Vitalis

wastafel z. overloop

| | | | | | | | |
|---------|---------------------------|-------------|-----|-----------|------|--------|-------|
| 0085650 | 55x55cm | | wit | 221555000 | stuk | 220,00 | 035 1 |
| 0085626 | 55x55cm | m. KeraTect | wit | 221555600 | stuk | 285,00 | 035 1 |
| 0085669 | 65x60cm | | wit | 121565000 | stuk | 279,00 | 035 1 |
| 0085634 | 65x60cm | m. KeraTect | wit | 121565600 | stuk | 344,00 | 035 1 |
| 0830097 | bevestigingsset M10x110mm | | | 0830097 | paar | 1,09 | 362 0 |



Utiliteit

wastafel m. overloop

| | | | | | | | |
|---------|---------------------------|--|-----|-----------|------|--------|-------|
| 0085677 | 65x60cm | | wit | 121765000 | stuk | 289,00 | 035 1 |
| 0830097 | bevestigingsset M10x110mm | | | 0830097 | paar | 1,09 | 362 0 |

wandclosetpot-70 diepspoel

| | | | | | | | |
|---------|--|-------------|----------|-----------|------|--------|-------|
| 0082823 | | | wit | 201500000 | stuk | 440,00 | 035 1 |
| 0082824 | | | pergamon | 201500068 | stuk | 587,00 | 035 1 |
| 0085685 | | m. KeraTect | wit | 201500600 | stuk | 505,00 | 035 1 |



wandclosetpot vlakspoel

| | | | | | | | |
|---------|--|-------------|-----|-----------|------|--------|-------|
| 0089060 | | m. KeraTect | wit | 201600600 | stuk | 515,00 | 035 1 |
|---------|--|-------------|-----|-----------|------|--------|-------|

closetpot-46 vlakspoel PK

| | | | | | | | |
|---------|---------------------------|-------|-----|-----------|------|--------|-------|
| 0085715 | | | wit | 211105000 | stuk | 182,00 | 035 1 |
| 0830453 | set potschroeven 5.5x60mm | chrom | | 0830453 | stuk | 2,28 | 362 0 |





Laufen pro



Reductie verheven tot uitgangspunt van design. De Laufen pro wastafels zijn in verschillende maten en uitvoeringen verkrijgbaar. Voor zowel het oog als budget attractief modern industrieel design.

LAUFEN
bathrooms



| Art.nr | Specificaties | Kleur | Lev.nr | Ehd | Prijs | Grp | CC |
|--------|---------------|-------|--------|-----|-------|-----|----|
|--------|---------------|-------|--------|-----|-------|-----|----|

Laufen Alessi

wastafel m. sifonkap m. WG

| | | | | | | | |
|---------|-----------|---------------------------|-----|---------------|------|---------|-------|
| 0080135 | 52x52.5cm | m. kraangat m. clou | wit | 8109712001041 | stuk | 1108,00 | 035 1 |
| 0080136 | 52x52.5cm | z. kraangat m. afvoerplug | wit | 8109712001091 | stuk | 1108,00 | 035 1 |
| 0080133 | 60x52.5cm | m. kraangat m. clou | wit | 8109722001041 | stuk | 1173,00 | 035 1 |
| 0080134 | 60x52.5cm | z. kraangat m. afvoerplug | wit | 8109722001091 | stuk | 1173,00 | 035 1 |



Sanitair producten

Baden /
douchebakken /
stoomcabines

Kranen

Douchegarnituur

Accessoires en
spiegels

Douchewanden

Toebehoren &
afvoerenSpoel- &
installatiesystemenBadkamermeubelen
en toiletkastenGootstenen en
wastroggen

Utiliteit

wastafel m. zuil m. WG

| | | | | | | | |
|---------|---------|---------------------------|-----|---------------|------|---------|-------|
| 0080140 | 52x53cm | m. kraangat m. clou | wit | 8119712001041 | stuk | 1360,00 | 035 0 |
| 0080141 | 52x53cm | z. kraangat m. afvoerplug | wit | 8119712001091 | stuk | 1360,00 | 035 1 |

**opbouwastafel m. WG**

| | | | | | | | |
|---------|---------|-------------|-----|---------------|------|--------|-------|
| 0080142 | 50x50cm | m. kraangat | wit | 8139712001041 | stuk | 764,00 | 035 1 |
|---------|---------|-------------|-----|---------------|------|--------|-------|

**waskom m. WG**

| | | | | | | | |
|---------|---------|---------------------------|-----|---------------|------|--------|-------|
| 0080147 | 52x52cm | m. kraangat m. clou | wit | 8189712001041 | stuk | 796,00 | 035 1 |
| 0080148 | 52x52cm | z. kraangat m. afvoerplug | wit | 8189712001091 | stuk | 796,00 | 035 1 |

**fontein m. sifonkap m. WG**

| | | | | | | | |
|---------|-----------|-------------|-----|---------------|------|--------|-------|
| 0080368 | 42x46.5cm | m. kraangat | wit | 8159702001041 | stuk | 677,00 | 035 1 |
| 0080369 | 42x46.5cm | z. kraangat | wit | 8159702001091 | stuk | 677,00 | 035 1 |

**duoblokpot diepspoel universeel m. WG z. reservoir**

| | | | | | | | |
|---------|-----------------------------------|--|-----|---------------|------|--------|-------|
| 0080149 | | | wit | 8229762000001 | stuk | 900,00 | 035 1 |
| 0080054 | afvoerbocht verstelbaar 70-220mm | | | 8900920000001 | stuk | 77,00 | 035 1 |
| 0080120 | afvoerbocht verstelbaar 220-300mm | | | 8990250000001 | stuk | 77,00 | 035 0 |

**duoblokreervoir + binnenwerk m. WG**

| | | | | | | | |
|---------|--|--|-----|---------------|------|--------|-------|
| 0080150 | | | wit | 8269712002751 | stuk | 916,00 | 035 1 |
|---------|--|--|-----|---------------|------|--------|-------|

staand closet PK m. WG







| | | | | | | | |
|---------|----------------------------------|--|-----|---------------|------|--------|-------|
| 0080152 | | | wit | 8219712000001 | stuk | 916,00 | 035 1 |
| 0080054 | afvoerbocht verstelbaar 70-220mm | | | 8900920000001 | stuk | 77,00 | 035 1 |

**wandclosetpot diepspoel m. WG**

| | | | | | | | |
|---------|--|--|-----|---------------|------|--------|-------|
| 0080153 | | | wit | 8209762000001 | stuk | 996,00 | 035 0 |
|---------|--|--|-----|---------------|------|--------|-------|

**closetzitting dubbel**

| | | | | | | | |
|---------|--|--|-----|---------------|------|--------|-------|
| 0080154 | | | wit | 8929710000001 | stuk | 241,00 | 035 0 |
|---------|--|--|-----|---------------|------|--------|-------|

| | Art.nr | Specificaties | Kleur | Lev.nr | Ehd | Prijs | Grp | CC |
|---|---|---------------------|----------|---------------|------|--------|-----|----|
| Sanitair producten | Laufen Alessi | | | | | | | |
| | staand bidet m. WG | | | | | | | |
| | 0080158 | m. kraangat m. clou | wit | 8329712003041 | stuk | 788,00 | 035 | 1 |
| Baden / douchebakken / stoomcabines |  | | | | | | | |
| Kranen | wandbidet m. WG | | | | | | | |
| | 0080160 | m. kraangat m. clou | wit | 8309712003041 | stuk | 778,00 | 035 | 1 |
| Douchegarnituur |  | | | | | | | |
| Accessoires en spiegels | bidetsifon | | | | | | | |
| | 0080159 | | wit | 8939490000001 | stuk | 77,00 | 035 | 1 |
| Douchewanden | urinoir z. vlieg m. WG | | | | | | | |
| | 0080163 | | wit | 8409752000001 | stuk | 691,00 | 035 | 1 |
| Toebehoren & afvoeren |  | | | | | | | |
| | urinoir voor deksel m. WG | | | | | | | |
| | 0080165 | | wit | 8409712000001 | stuk | 691,00 | 035 | 1 |
| Spoel- & installatiesystemen | deksel voor urinoir | | | | | | | |
| | 0080162 | | wit | 8949710000001 | stuk | 152,00 | 035 | 1 |
| Badkamermeubelen en toiletkasten | sifon D40 | | | | | | | |
| | 0080143 | | chroom | 8939790000001 | stuk | 77,00 | 035 | 1 |
| | flexibele sifon | | | | | | | |
| | 0080673 | | | 8949750000001 | stuk | 13,50 | 035 | 0 |
| Gootstenen en wastroggen | Laufen Fiora | | | | | | | |
| | meubelwastafel | | | | | | | |
| | 0080831 92x50cm | | wit | 8131380000001 | stuk | 460,00 | 035 | 1 |
| | 0080832 92x50cm | | pergamon | 8131380490001 | stuk | 460,00 | 035 | 1 |
| | 0830097 bevestigingsset M10x110mm | | | 0830097 | paar | 1,09 | 362 | 0 |
| Utiliteit | meubelwastafel dubbel | | | | | | | |
| | 0080106 122x50cm | | wit | 8131390000001 | stuk | 798,00 | 035 | 1 |
| | 0080830 122x50cm | | pergamon | 8131390490001 | stuk | 798,00 | 035 | 1 |
| | 0830097 bevestigingsset M10x110mm | | | 0830097 | paar | 1,09 | 362 | 0 |
| | opbouwastafel | | | | | | | |
| | 0080829 49cm | | wit | 8117720000001 | stuk | 146,00 | 035 | 1 |
| | 0080006 49cm | | pergamon | 8117720490001 | stuk | 146,00 | 035 | 1 |
| |  | | | | | | | |
| | Laufen Gallery | | | | | | | |
| | wastafel | | | | | | | |
| | 0089516 55x46cm | | wit | 8101710000001 | stuk | 190,00 | 035 | 1 |
| | 0092053 55x46cm | | pergamon | 8101710490001 | stuk | 190,00 | 035 | 1 |
| | 0089508 60x50cm | | wit | 8101720000001 | stuk | 203,00 | 035 | 1 |
| | 0092045 60x50cm | | pergamon | 8101720490001 | stuk | 203,00 | 035 | 1 |
| | 0830097 bevestigingsset M10x110mm | | | 0830097 | paar | 1,09 | 362 | 0 |
| |  | | | | | | | |
| |  | | | | | | | |

| Art.nr | Specificaties | Kleur | Lev.nr | Ehd | Prijs | Grp | CC |
|--------|---------------|-------|--------|-----|-------|-----|----|
|--------|---------------|-------|--------|-----|-------|-----|----|

Laufen Gallery

zuil voor wastafel

| | | | | | | | |
|---------|--|----------|---------------|------|--------|-----|---|
| 0089524 | | wit | 8191700000001 | stuk | 157,00 | 035 | 1 |
| 0092061 | | pergamon | 8191700490001 | stuk | 157,00 | 035 | 1 |



Sanitair producten

Baden /
douchebakken /
stoomcabines**wastafel rechts - aflegruimte links**

| | | | | | | | |
|---------|---------------------------|----------|---------------|------|--------|-----|---|
| 0089559 | 81x52cm | wit | 8140780001041 | stuk | 553,00 | 035 | 1 |
| 0092096 | 81x52cm | pergamon | 8140780491041 | stuk | 553,00 | 035 | 1 |
| 0830097 | bevestigingsset M10x110mm | | 0830097 | paar | 1,09 | 362 | 0 |



Kranen

wastafel links - aflegruimte rechts

| | | | | | | | |
|---------|---------------------------|----------|---------------|------|--------|-----|---|
| 0089575 | 81x52cm | wit | 8140790001041 | stuk | 553,00 | 035 | 1 |
| 0092118 | 81x52cm | pergamon | 8140790491041 | stuk | 553,00 | 035 | 1 |
| 0830097 | bevestigingsset M10x110mm | | 0830097 | paar | 1,09 | 362 | 0 |



Douchegarnituur

Accessoires en
spiegels**handdoekhouder m. planchet**

| | | | | | | | |
|---------|--|-------|---------------|------|--------|-----|---|
| 0089591 | | chrom | 8910710000001 | stuk | 313,00 | 035 | 1 |
|---------|--|-------|---------------|------|--------|-----|---|

meubelwastafel

| | | | | | | | |
|---------|---------------------------|----------|---------------|------|--------|-----|---|
| 0084008 | 102x52cm | wit | 8141760000001 | stuk | 522,00 | 035 | 1 |
| 0080086 | 102x52cm | pergamon | 8141760490001 | stuk | 522,00 | 035 | 1 |
| 0830097 | bevestigingsset M10x110mm | | 0830097 | paar | 1,09 | 362 | 0 |



Douchewanden

Toebehoren &
afvoeren**meubelwastafel dubbel**

| | | | | | | | |
|---------|---------------------------|----------|---------------|------|--------|-----|---|
| 0089605 | 135x52cm | wit | 8141780000001 | stuk | 798,00 | 035 | 1 |
| 0092126 | 135x52cm | pergamon | 8141780490001 | stuk | 798,00 | 035 | 1 |
| 0830097 | bevestigingsset M10x110mm | | 0830097 | paar | 1,09 | 362 | 0 |

Spoel- &
installatiesystemen**sifonkap voor wastafel**

| | | | | | | | |
|---------|--|----------|---------------|------|--------|-----|---|
| 0080087 | | pergamon | 8191720490001 | stuk | 157,00 | 035 | 1 |
| 0084012 | | wit | 8191720000001 | stuk | 157,00 | 035 | 1 |

Badkamermeubelen
en toiletkasten**hoekwastafel**

| | | | | | | | |
|---------|---------------------------|----------|---------------|------|--------|-----|---|
| 0089532 | 73x65cm | wit | 8141650000001 | stuk | 250,00 | 035 | 1 |
| 0092088 | 75x65cm | pergamon | 8141650490001 | stuk | 250,00 | 035 | 1 |
| 0830097 | bevestigingsset M10x110mm | | 0830097 | paar | 1,09 | 362 | 0 |

Gootstenen en
wastroggen

Utiliteit

sifonkap universeel

| | | | | | | | |
|---------|--|-------|---------------|------|--------|-----|---|
| 0089540 | | chrom | 8918700000001 | stuk | 120,00 | 035 | 1 |
|---------|--|-------|---------------|------|--------|-----|---|









**fontein**











| | | | | | | | |
|---------|--------------------------------------|----------|---------------|------|--------|-----|---|
| 0089621 | 47x38cm | wit | 8151720000001 | stuk | 116,00 | 035 | 1 |
| 0092134 | 47x38cm | pergamon | 8151720490001 | stuk | 116,00 | 035 | 1 |
| 0830240 | bevestigingsset voor fontein M8x90mm | | 0830240 | stuk | 0,85 | 362 | 0 |

**sifonkap voor fontein m. snelbevestiging**

| | | | | | | | |
|---------|--|----------|---------------|------|--------|-----|---|
| 0089648 | | wit | 8191750000001 | stuk | 136,00 | 035 | 1 |
| 0092142 | | pergamon | 8191750490001 | stuk | 136,00 | 035 | 1 |



| | Art.nr | Specificaties | Kleur | Lev.nr | Ehd | Prijs | Grp | CC | |
|---|---|--|---------------------------|---------------|---------------|--------|--------|-----|---|
| Sanitair producten | Laufen Gallery | | | | | | | | |
| |  | hoekfontein | | | | | | | |
| | | 0089656 | 49x47cm | wit | 8161650000001 | stuk | 231,00 | 035 | 1 |
| | | 0092150 | 49x47cm | pergamon | 8161650490001 | stuk | 231,00 | 035 | 1 |
| | 0830240 | bevestigingsset voor fontein M8x90mm | | 0830240 | stuk | 0,85 | 362 | 0 | |
| Baden / douchebakken / stoomcabines |  | wandbidet | | | | | | | |
| | | 0089729 | | wit | 8301710000001 | stuk | 372,00 | 035 | 1 |
| Kranen | | 0092215 | | pergamon | 8301710490001 | stuk | 372,00 | 035 | 1 |
| Douchegarnituur |  | staand bidet | | | | | | | |
| | | 0089710 | | wit | 8311710000001 | stuk | 436,00 | 035 | 1 |
| | | 0092207 | | pergamon | 8311710490001 | stuk | 436,00 | 035 | 1 |
| Accessoires en spiegels | | 0830453 | set potschroeven 5.5x60mm | chrom | 0830453 | stuk | 2,28 | 362 | 0 |
| Douchewanden |  | wandclosetpot vlakspoel | | | | | | | |
| | | 0089699 | | wit | 8201600000001 | stuk | 354,00 | 035 | 1 |
| Toebehoren & afvoeren | | 0092193 | | pergamon | 8201600490001 | stuk | 354,00 | 035 | 1 |
| Spoel- & installatiesystemen |  | wandclosetpot diepspoel | | | | | | | |
| | | 0084022 | | wit | 8201700000001 | stuk | 337,00 | 035 | 1 |
| Badkamermeubelen en toiletkasten | | 0080374 | | pergamon | 8201700490001 | stuk | 337,00 | 035 | 1 |
| Gootstenen en wastroggen |  | closetzitting m. deksel | | | | | | | |
| | | 0084003 | | wit | 8951710000001 | stuk | 108,00 | 035 | 1 |
| | | 0080375 | | pergamon | 8951710490001 | stuk | 108,00 | 035 | 1 |
| Utiliteit |  | duoblokpot vlakspoel z. reservoir | | | | | | | |
| | | 0089680 | | wit | 8211610000001 | stuk | 422,00 | 035 | 1 |
| | | 0092185 | | pergamon | 8211610490001 | stuk | 422,00 | 035 | 1 |
| | 0830453 | set potschroeven 5.5x60mm | chrom | 0830453 | stuk | 2,28 | 362 | 0 | |
| |  | duoblokpot diepspoel z. reservoir | | | | | | | |
| | | 0089664 | | wit | 8211790000001 | stuk | 392,00 | 035 | 1 |
| | | 0092169 | | pergamon | 8211790490001 | stuk | 392,00 | 035 | 1 |
| | 0830453 | set potschroeven 5.5x60mm | chrom | 0830453 | stuk | 2,28 | 362 | 0 | |
| |  | duoblokresevoir dualflush | | | | | | | |
| | | 0089672 | | wit/chroom | 8271700002781 | stuk | 304,00 | 035 | 1 |
| | 0092177 | | perg./chroom | 8271700492781 | stuk | 304,00 | 035 | 1 | |

| Art.nr | Specificaties | Kleur | Lev.nr | Ehd | Prijs | Grp | CC | | |
|--|--------------------------------------|------------------------|-----------|---------------|-------|---------|-----|----------------------|---|
| | | | | | | | | Laufen Living | |
| wastafel | | | | | | | | | |
| 0080720 | 55x48cm | m. WG | wit | 8104312001041 | stuk | 264,00 | 035 | 1 |  |
| 0080014 | 60x51cm | m. WG | wit | 8104322001041 | stuk | 282,00 | 035 | 1 | |
| 0080007 | 65x52cm | m. WG | wit | 8104342001041 | stuk | 310,00 | 035 | 1 | |
| 0080003 | 70x54cm | m. WG | wit | 8104352001041 | stuk | 368,00 | 035 | 1 | |
| 0830097 | bevestigingsset M10x110mm | | | 0830097 | paar | 1,09 | 362 | 0 | |
| handdoekhouder voor wastafel | | | | | | | | | |
| 0080044 | 55 / 60cm | | chroom | 8954320040001 | stuk | 185,00 | 035 | 1 |  |
| 0080048 | 65 / 70cm | | chroom | 8954350040001 | stuk | 189,00 | 035 | 1 | |
| meubelwastafel | | | | | | | | | |
| 0080056 | 93.5x47cm | m. WG | wit | 8144362001041 | stuk | 711,00 | 035 | 1 |  |
| 0830097 | bevestigingsset M10x110mm | | | 0830097 | paar | 1,09 | 362 | 0 | |
| zuil voor wastafel | | | | | | | | | |
| 0080708 | | | wit | 8194300000001 | stuk | 195,00 | 035 | 1 | |
| sifonkap voor wastafel m. bevestiging | | | | | | | | | |
| 0080706 | | | wit | 8194310000001 | stuk | 186,00 | 035 | 1 | |
| wastafelonderstel | | | | | | | | | |
| 0080057 | | | chroom | 8954310040001 | stuk | 316,00 | 035 | 1 | |
| meubelwastafel z. overloop | | | | | | | | | |
| 0084119 | 68x45cm | m. WG | wit | 8144352001041 | stuk | 615,00 | 035 | 0 |  |
| 0084120 | 68x45cm | m. 3 kraangaten m. WG | wit | 8144352001081 | stuk | 615,00 | 035 | 1 | |
| 0830097 | bevestigingsset M10x110mm | | | 0830097 | paar | 1,09 | 362 | 0 | |
| handdoekhouder voor wastafel 68cm | | | | | | | | | |
| 0084131 | | | chroom | 8954360040001 | stuk | 149,00 | 035 | 0 |  |
| 0084134 | | | matchroom | 8954360070001 | stuk | 165,00 | 035 | 1 | |
| meubelwastafel z. overloop | | | | | | | | | |
| 0084123 | 98x48cm | m. WG | wit | 8144372001041 | stuk | 800,00 | 035 | 0 |  |
| 0084124 | 98x48cm | m. 3 kraangaten m. WG | wit | 8144372001081 | stuk | 800,00 | 035 | 1 | |
| 0830097 | bevestigingsset M10x110mm | | | 0830097 | paar | 1,09 | 362 | 0 | |
| handdoekhouder voor wastafel 98cm | | | | | | | | | |
| 0084132 | | | chroom | 8954370040001 | stuk | 169,00 | 035 | 1 |  |
| 0084135 | | | matchroom | 8954370070001 | stuk | 189,00 | 035 | 1 | |
| dubbele meubelwastafel z. overloop | | | | | | | | | |
| 0084127 | 168x48cm | m. WG | wit | 8144392001041 | stuk | 1169,00 | 035 | 0 |  |
| 0084128 | 168x48cm | 2 x 3 kraangaten m. WG | wit | 8144392001081 | stuk | 1169,00 | 035 | 1 | |
| 0830097 | bevestigingsset M10x110mm | | | 0830097 | paar | 1,09 | 362 | 0 | |
| handdoekhouder voor wastafel 168cm | | | | | | | | | |
| 0084133 | | | chroom | 8954380040001 | stuk | 234,00 | 035 | 0 |  |
| 0084136 | | | matchroom | 8954380070001 | stuk | 269,00 | 035 | 1 | |
| sifonkap universeel | | | | | | | | | |
| 0089540 | | | chroom | 8918700000001 | stuk | 120,00 | 035 | 1 |  |
| fontein | | | | | | | | | |
| 0080059 | 45x40cm | m. WG | wit | 8154312001041 | stuk | 243,00 | 035 | 1 |  |
| 0830240 | bevestigingsset voor fontein M8x90mm | | | 0830240 | stuk | 0,85 | 362 | 0 | |
| sifonkap voor fontein m. bevestiging | | | | | | | | | |
| 0080707 | | | wit | 8194350000001 | stuk | 195,00 | 035 | 1 | |

Sanitair producten

Baden /
douchebakken /
stoomcabines

Kranen

Douchegarnituur

Accessoires en
spiegels

Douchewanden

Toebehoren &
afvoerenSpoel- &
installatiesystemenBadkamermeubelen
en toiletkastenGootstenen en
wastroggen

Utiliteit

| | Art.nr | Specificaties | Kleur | Lev.nr | Ehd | Prijs | Grp | CC | |
|----------------------------------|---|---|-----------------------------------|---------------|---------------|--------|--------|-------|--|
| Sanitair producten | Laufen Living | | | | | | | | |
| |  | wandcloset diepspoel 0080079 | m. WG | wit | 8204302000001 | stuk | 423,00 | 035 0 | |
| Kranen |  | duoblokpot diepspoel z. reservoir 0080067 | m. WG | wit | 8244362000001 | stuk | 464,00 | 035 1 | |
| | | 0080054 | afvoerbocht verstelbaar 70-220mm | | 8900920000001 | stuk | 77,00 | 035 1 | |
| | | 0080120 | afvoerbocht verstelbaar 220-300mm | | 8990250000001 | stuk | 77,00 | 035 0 | |
| Douchegarnituur | reservoir voor closetpot | | | | | | | | |
| | 0080069 | m. WG | wit | 8264302002781 | stuk | 364,00 | 035 1 | | |
| Accessoires en spiegels | closetzitting dubbel antibacterieel | | | | | | | | |
| | 0080088 | | wit | 8924300000001 | stuk | 116,00 | 035 0 | | |
| Douchewanden | closetzitting dubbel antibacterieel m. dempingsmechanisme | | | | | | | | |
| | 0080093 | | wit | 8924310000001 | stuk | 211,00 | 035 1 | | |
| Toebehoren & afvoeren |  | wandbidet 0080096 | m. WG | wit | 8304312003041 | stuk | 441,00 | 035 1 | |
| | | onderbouwkast | | | | | | | |
| Spoel- & installatiesystemen |  | 0080792 | 58x38x38cm | zwart | 4709130705531 | stuk | 627,50 | 035 1 | |
| | | 0080793 | 98x40x38cm | zwart | 4729130705531 | stuk | 707,36 | 035 1 | |
| Badkamermeubelen en toiletkasten |  | onderbouwkast voor 2 wastafels | | | | | | | |
| | | 0080794 | 160x40x38cm | zwart | 4759110705531 | stuk | 999,44 | 035 1 | |
| Gootstenen en wastroggen |  | onderbouwkast | | | | | | | |
| | | 0080795 | 160x40x38cm links | zwart | 4758110705531 | stuk | 969,77 | 035 1 | |
| Utiliteit |  | 0080796 | 160x40x38cm rechts | zwart | 4758120705531 | stuk | 969,77 | 035 1 | |

| Art.nr | Specificaties | Kleur | Lev.nr | Ehd | Prijs | Grp | CC |
|--------|---------------|-------|--------|-----|-------|-----|----|
|--------|---------------|-------|--------|-----|-------|-----|----|

Laufen Living

halfhoge kast m. 2 deuren

| | | | | | | | |
|---------|---------|--------|-------|---------------|------|--------|-------|
| 0080797 | 76x38cm | | zwart | 4789110705531 | stuk | 693,67 | 035 1 |
| 0080798 | 76x38cm | rechts | zwart | 4789120705531 | stuk | 693,67 | 035 1 |



Sanitair producten

Baden /
douchebakken /
stoomcabines

Kranen

Douchegarnituur

Accessoires en
spiegels

Douchewanden

Toebehoren &
afvoeren

hoge kast m. 2 deuren

| | | | | | | | |
|---------|----------|--------|-------|---------------|------|--------|-------|
| 0080800 | 140x38cm | rechts | zwart | 4799120705531 | stuk | 992,59 | 035 1 |
| 0080799 | 140x38cm | links | zwart | 4799110705531 | stuk | 992,59 | 035 1 |



spiegel ovaal

| | | | | | | | |
|---------|----------|--|--|---------------|------|--------|-------|
| 0084116 | 65x28cm | | | 4614910430001 | stuk | 206,00 | 035 1 |
| 0084117 | 95x28cm | | | 4614930430001 | stuk | 234,00 | 035 1 |
| 0084118 | 165x28cm | | | 4614950430001 | stuk | 312,00 | 035 0 |

Spoel- &
installatiesystemenBadkamermeubelen
en toiletkastenGootstenen en
wastroggen

spiegel ovaal m. verlichting

| | | | | | | | |
|---------|----------|--|--|---------------|------|--------|-------|
| 0080801 | 65x28cm | | | 4615110430001 | stuk | 444,95 | 035 1 |
| 0080802 | 95x38cm | | | 4615130430001 | stuk | 467,77 | 035 1 |
| 0080803 | 165x28cm | | | 4615150430001 | stuk | 798,64 | 035 1 |

afvoerplug

| | | | | | | | |
|---------|--|--|--------|---------------|------|-------|-------|
| 0080607 | | | chroom | 8954390000001 | stuk | 47,25 | 035 1 |
|---------|--|--|--------|---------------|------|-------|-------|

Laufen Moderna

wastafelmeubel

| | | | | | | | |
|---------|---------------------------|--|-----|---------------|------|--------|-------|
| 0080105 | 123x52.5cm | | wit | 8144680000001 | stuk | 480,00 | 035 1 |
| 0830097 | bevestigingsset M10x110mm | | | 0830097 | paar | 1,09 | 362 0 |









Laufen MyLife

wastafel m. clou

| | | | | | | | |
|---------|---------|-----------------------|-----|---------------|------|--------|-------|
| 0089215 | 75x53cm | m. WG | wit | 8109462001041 | stuk | 477,00 | 035 1 |
| 0089315 | 75x53cm | m. 3 kraangaten m. WG | wit | 8109462001081 | stuk | 477,00 | 035 1 |
| 0089207 | 95x60cm | m. WG | wit | 8109472001041 | stuk | 582,00 | 035 1 |
| 0089313 | 95x60cm | m. 3 kraangaten m. WG | wit | 8109472001081 | stuk | 582,00 | 035 1 |



| | Art.nr | Specificaties | Kleur | Lev.nr | Ehd | Prijs | Grp | CC |
|---|---|---|------------|---------------|------|--------|-----|----|
| Sanitair producten | Laufen MyLife | | | | | | | |
| | | zuil voor wastafel | | | | | | |
| | 0080709 | | wit | 8199402000001 | stuk | 317,00 | 035 | 1 |
| Baden / douchebakken / stoomcabines |  | | | | | | | |
| Kranen | | sifonkap voor wastafel m. bevestiging | | | | | | |
| | 0080710 | | wit | 8199412000001 | stuk | 317,00 | 035 | 1 |
| Douchegarnituur |  | | | | | | | |
| Accessoires en spiegels | | wandbidet m. clou | | | | | | |
| | | 0089303 m. WG | wit | 8309412003041 | stuk | 562,00 | 035 | 1 |
| | 0080159 bidetsifon | wit | | 8939490000001 | stuk | 77,00 | 035 | 1 |
| |  | | | | | | | |
| Douchewanden | | staand bidet m. bevestigingsset m. clou | | | | | | |
| | 0089281 m. WG | | wit | 8329412003041 | stuk | 521,00 | 035 | 1 |
| | 0080159 bidetsifon | wit | | 8939490000001 | stuk | 77,00 | 035 | 1 |
| |  | | | | | | | |
| Toebehoren & afvoeren | | bidetzitting afneembaar | | | | | | |
| | 0089311 | | wit | 8939410000001 | stuk | 188,00 | 035 | 1 |
| |  | | | | | | | |
| Badkamermeubelen en toiletkasten | | wandclosetpot diepspoel | | | | | | |
| | 0089265 m. WG | | wit | 8209462000001 | stuk | 485,00 | 035 | 1 |
| |  | | | | | | | |
| Gootstenen en wastroggen | | duoblokpot diepspoel z. reservoir m. bevestigingsset | | | | | | |
| | 0089249 m. WG | | wit | 8229432000001 | stuk | 529,00 | 035 | 1 |
| | 0080054 afvoerbocht verstelbaar 70-220mm | | | 8900920000001 | stuk | 77,00 | 035 | 1 |
| | 0080120 afvoerbocht verstelbaar 220-300mm | | | 8990250000001 | stuk | 77,00 | 035 | 0 |
| |  | | | | | | | |
| Utiliteit | | duoblokreservoir dualflush | | | | | | |
| | 0089257 | | wit/chroom | 8269412002751 | stuk | 575,00 | 035 | 1 |
| |  | | | | | | | |
| | | closetzitting m. deksel | | | | | | |
| | 0089273 | | wit | 8929410000001 | stuk | 213,00 | 035 | 1 |
| |  | | | | | | | |

| Art.nr | Specificaties | Kleur | Lev.nr | Ehd | Prijs | Grp | CC |
|-----------------------|--------------------------------|----------|---------------|------|--------|-----|----|
| Laufen Palace | | | | | | | |
| meubelwastafel | | | | | | | |
| 0080406 | 120x55cm m. 1 kraangat | wit | 8125030000001 | stuk | 578,00 | 035 | 1 |
| 0080407 | 120x55cm m. 1 kraangat | pergamon | 8125030490001 | stuk | 578,00 | 035 | 1 |
| 0080410 | 120x55cm m. 3 kraangaten | wit | 8125030001081 | stuk | 578,00 | 035 | 1 |
| 0080413 | 120x55cm m. 3 kraangaten | pergamon | 8125030491081 | stuk | 578,00 | 035 | 1 |
| 0080408 | 120x55cm m. 1 kraangat m. WG | wit | 8125032000001 | stuk | 632,00 | 035 | 1 |
| 0080409 | 120x55cm m. 1 kraangat m. WG | pergamon | 8125032490001 | stuk | 632,00 | 035 | 1 |
| 0080415 | 120x55cm m. 3 kraangaten m. WG | wit | 8125032001081 | stuk | 632,00 | 035 | 1 |
| 0080416 | 120x55cm m. 3 kraangaten m. WG | pergamon | 8125032491081 | stuk | 632,00 | 035 | 1 |
| 0080417 | 150x55cm m. 1 kraangat | wit | 8125050000001 | stuk | 672,00 | 035 | 1 |
| 0080418 | 150x55cm m. 1 kraangat | pergamon | 8125050490001 | stuk | 672,00 | 035 | 1 |
| 0080421 | 150x55cm m. 3 kraangaten | wit | 8125050001081 | stuk | 672,00 | 035 | 1 |
| 0080422 | 150x55cm m. 3 kraangaten | pergamon | 8125050491081 | stuk | 672,00 | 035 | 1 |
| 0080419 | 150x55cm m. 1 kraangat m. WG | wit | 8125052000001 | stuk | 726,00 | 035 | 1 |
| 0080420 | 150x55cm m. 1 kraangat m. WG | pergamon | 8125052490001 | stuk | 726,00 | 035 | 1 |
| 0080423 | 150x55cm m. 3 kraangaten m. WG | wit | 8125052001081 | stuk | 726,00 | 035 | 1 |
| 0080424 | 150x55cm m. 3 kraangaten m. WG | pergamon | 8125052491081 | stuk | 726,00 | 035 | 1 |
| 0080425 | 180x55cm m. 1 kraangat | wit | 8125060000001 | stuk | 766,00 | 035 | 1 |
| 0080426 | 180x55cm m. 1 kraangat | pergamon | 8125060490001 | stuk | 766,00 | 035 | 1 |
| 0080429 | 180x55cm m. 3 kraangaten | wit | 8125060001081 | stuk | 766,00 | 035 | 1 |
| 0080430 | 180x55cm m. 3 kraangaten | pergamon | 8125060491081 | stuk | 766,00 | 035 | 1 |
| 0080427 | 180x55cm m. 1 kraangat m. WG | wit | 8125062000001 | stuk | 820,00 | 035 | 1 |
| 0080428 | 180x55cm m. 1 kraangat m. WG | pergamon | 8125062490001 | stuk | 820,00 | 035 | 1 |
| 0080431 | 180x55cm m. 3 kraangaten m. WG | wit | 8125062001081 | stuk | 820,00 | 035 | 1 |
| 0080432 | 180x55cm m. 3 kraangaten m. WG | pergamon | 8125062491081 | stuk | 820,00 | 035 | 1 |

meubelwastafel m. handdoekhouder

| | | | | | | | |
|---------|--------------------------------|----------|---------------|------|---------|-----|---|
| 0080433 | 120x55cm m. 1 kraangat | wit | 8125130000001 | stuk | 800,00 | 035 | 1 |
| 0080434 | 120x55cm m. 1 kraangat | pergamon | 8125130490001 | stuk | 800,00 | 035 | 1 |
| 0080437 | 120x55cm m. 3 kraangaten | wit | 8125130001081 | stuk | 800,00 | 035 | 1 |
| 0080439 | 120x55cm m. 3 kraangaten | pergamon | 8125130491081 | stuk | 800,00 | 035 | 1 |
| 0080435 | 120x55cm m. 1 kraangat m. WG | wit | 8125132000001 | stuk | 854,00 | 035 | 1 |
| 0080436 | 120x55cm m. 1 kraangat m. WG | pergamon | 8125132490001 | stuk | 854,00 | 035 | 1 |
| 0080440 | 120x55cm m. 3 kraangaten m. WG | wit | 8125132001081 | stuk | 854,00 | 035 | 1 |
| 0080441 | 120x55cm m. 3 kraangaten m. WG | pergamon | 8125132491081 | stuk | 854,00 | 035 | 1 |
| 0080442 | 150x55cm m. 1 kraangat | wit | 8125150000001 | stuk | 894,00 | 035 | 1 |
| 0080443 | 150x55cm m. 1 kraangat | pergamon | 8125150490001 | stuk | 894,00 | 035 | 1 |
| 0080447 | 150x55cm m. 3 kraangaten | wit | 8125150001081 | stuk | 894,00 | 035 | 1 |
| 0080448 | 150x55cm m. 3 kraangaten | pergamon | 8125150491081 | stuk | 894,00 | 035 | 1 |
| 0080444 | 150x55cm m. 1 kraangat m. WG | wit | 8125152000001 | stuk | 948,00 | 035 | 1 |
| 0080445 | 150x55cm m. 1 kraangat m. WG | pergamon | 8125152490001 | stuk | 948,00 | 035 | 1 |
| 0080449 | 150x55cm m. 3 kraangaten m. WG | wit | 8125152001081 | stuk | 948,00 | 035 | 1 |
| 0080450 | 150x55cm m. 3 kraangaten m. WG | pergamon | 8125152491081 | stuk | 948,00 | 035 | 1 |
| 0080451 | 180x55cm m. 1 kraangat | wit | 8125160000001 | stuk | 988,00 | 035 | 1 |
| 0080452 | 180x55cm m. 1 kraangat | pergamon | 8125160490001 | stuk | 988,00 | 035 | 1 |
| 0080458 | 180x55cm m. 3 kraangaten | wit | 8125160001081 | stuk | 988,00 | 035 | 1 |
| 0080459 | 180x55cm m. 3 kraangaten | pergamon | 8125160491081 | stuk | 988,00 | 035 | 1 |
| 0080453 | 180x55cm m. 1 kraangat m. WG | wit | 8125162000001 | stuk | 1041,00 | 035 | 1 |
| 0080457 | 180x55cm m. 1 kraangat m. WG | pergamon | 8125162490001 | stuk | 1041,00 | 035 | 1 |
| 0080460 | 180x55cm m. 3 kraangaten m. WG | wit | 8125162001081 | stuk | 1041,00 | 035 | 1 |
| 0080461 | 180x55cm m. 3 kraangaten m. WG | pergamon | 8125162491081 | stuk | 1041,00 | 035 | 1 |

Laufen Palace Due**meubelwastafel dubbel**

| | | | | | | | |
|---------|--------------------------------|----------|---------------|------|---------|-----|---|
| 0080462 | 150x57cm m. 1 kraangat | wit | 8126050000001 | stuk | 893,00 | 035 | 1 |
| 0080463 | 150x57cm m. 1 kraangat | pergamon | 8126050490001 | stuk | 893,00 | 035 | 1 |
| 0080466 | 150x57cm m. 3 kraangaten | wit | 8126050001081 | stuk | 893,00 | 035 | 1 |
| 0080467 | 150x57cm m. 3 kraangaten | pergamon | 8126050491081 | stuk | 893,00 | 035 | 1 |
| 0080464 | 150x57cm m. 1 kraangat m. WG | wit | 8126052000001 | stuk | 947,00 | 035 | 1 |
| 0080465 | 150x57cm m. 1 kraangat m. WG | pergamon | 8126052490001 | stuk | 947,00 | 035 | 1 |
| 0080468 | 150x57cm m. 3 kraangaten m. WG | wit | 8126052001081 | stuk | 947,00 | 035 | 1 |
| 0080469 | 150x57cm m. 3 kraangaten m. WG | pergamon | 8126052491081 | stuk | 947,00 | 035 | 1 |
| 0080470 | 180x57cm m. 1 kraangat | wit | 8126060000001 | stuk | 993,00 | 035 | 1 |
| 0080471 | 180x57cm m. 1 kraangat | pergamon | 8126060490001 | stuk | 993,00 | 035 | 1 |
| 0080474 | 180x57cm m. 3 kraangaten | wit | 8126060001081 | stuk | 993,00 | 035 | 1 |
| 0080475 | 180x57cm m. 3 kraangaten | pergamon | 8126060491081 | stuk | 993,00 | 035 | 1 |
| 0080472 | 180x57cm m. 1 kraangat m. WG | wit | 8126062000001 | stuk | 1046,00 | 035 | 1 |
| 0080473 | 180x57cm m. 1 kraangat m. WG | pergamon | 8126062490001 | stuk | 1046,00 | 035 | 1 |
| 0080476 | 180x57cm m. 3 kraangaten m. WG | wit | 8126062001081 | stuk | 1046,00 | 035 | 1 |
| 0080477 | 180x57cm m. 3 kraangaten m. WG | pergamon | 8126062491081 | stuk | 1046,00 | 035 | 1 |

Sanitair producten

Baden /
douchebakken /
stoomcabines

Kranen















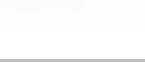

Doucheapparatuur

Accessoires en
spiegels

Douchewanden

Toebehoren &
afvoerenSpoel- &
installatiesystemenBadkamermeubelen
en toiletkastenGootstenen en
wastroggen

Utiliteit

| | Art.nr | Specificaties | Kleur | Lev.nr | Ehd | Prijs | Grp | CC |
|---|---|--|----------|---------------|------|---------|-----|----|
| Laufen Palace Due | | | | | | | | |
| Sanitair producten | meubelwastafel dubbel m. handdoekhouder | | | | | | | |
| |  | 0080478 150x57cm m. 1 kraangat | wit | 812615000001 | stuk | 1121,00 | 035 | 0 |
| Baden / douchebakken / stoomcabines |  | 0080479 150x57cm m. 1 kraangat | pergamon | 8126150490001 | stuk | 1121,00 | 035 | 1 |
| | | 0080482 150x57cm m. 3 kraangaten | wit | 8126150001081 | stuk | 1121,00 | 035 | 1 |
| | | 0080483 150x57cm m. 3 kraangaten | pergamon | 8126150491081 | stuk | 1121,00 | 035 | 1 |
| | | 0080480 150x57cm m. 1 kraangat m. WG | wit | 8126152000001 | stuk | 1175,00 | 035 | 1 |
| | | 0080481 150x57cm m. 1 kraangat m. WG | pergamon | 8126152490001 | stuk | 1175,00 | 035 | 1 |
| | | 0080484 150x57cm m. 3 kraangaten m. WG | wit | 8126152001081 | stuk | 1175,00 | 035 | 1 |
| Kranen | | 0080485 150x57cm m. 3 kraangaten m. WG | pergamon | 8126152491081 | stuk | 1175,00 | 035 | 1 |
| | | 0080486 180x57cm m. 1 kraangat | wit | 8126160000001 | stuk | 1208,00 | 035 | 1 |
| | | 0080487 180x57cm m. 1 kraangat | pergamon | 8126160490001 | stuk | 1208,00 | 035 | 1 |
| | | 0080490 180x57cm m. 3 kraangaten | wit | 8126160001081 | stuk | 1208,00 | 035 | 1 |
| | | 0080491 180x57cm m. 3 kraangaten | pergamon | 8126160491081 | stuk | 1208,00 | 035 | 1 |
| | | 0080488 180x57cm m. 1 kraangat m. WG | wit | 8126162000001 | stuk | 1262,00 | 035 | 1 |
| Douchegarnituur | | 0080489 180x57cm m. 1 kraangat m. WG | pergamon | 8126162490001 | stuk | 1262,00 | 035 | 1 |
| | | 0080492 180x57cm m. 3 kraangatn m. WG | wit | 8126162001081 | stuk | 1262,00 | 035 | 1 |
| | | 0080493 180x57cm m. 3 kraangatn m. WG | pergamon | 8126162491081 | stuk | 1262,00 | 035 | 1 |
| Laufen Palomba | | | | | | | | |
| Accessoires en spiegels | wastafel | | | | | | | |
| |  | 0080723 80x50cm m. kraangat m. WG | wit | 8148042001041 | stuk | 657,00 | 035 | 1 |
| | | 0080724 80x50cm z. kraangat m. WG | wit | 8148042001091 | stuk | 657,00 | 035 | 1 |
| | | 0080768 160x50cm m. kraangat m. WG | wit | 8148082001041 | stuk | 980,00 | 035 | 1 |
| Douchewanden | | 0080722 160x50cm z. kraangat m. WG | wit | 8148082001091 | stuk | 980,00 | 035 | 1 |
| |  | | | | | | | |
| Toebehoren & afvoeren |  | | | | | | | |
| |  | | | | | | | |
| Spoel- & installatiesystemen | waskom | | | | | | | |
| |  | 0080725 45x45cm z. kraangat m. WG | wit | 8118012001121 | stuk | 373,00 | 035 | 1 |
| Badkamermeubelen en toiletkasten |  | | | | | | | |
| |  | | | | | | | |
| Gootstenen en wastroggen | opbouw waskom | | | | | | | |
| |  | 0080726 45x45cm z. kraangat m. WG | wit | 8118022001121 | stuk | 391,00 | 035 | 1 |
| Utiliteit |  | | | | | | | |
| |  | | | | | | | |
| | waskom | | | | | | | |
| |  | 0080727 52x52cm m. kraangat m. WG | wit | 8128012001111 | stuk | 411,00 | 035 | 1 |
| | | 0080728 52x52cm z. kraangat m. WG | wit | 8128012001121 | stuk | 411,00 | 035 | 1 |
| |  | | | | | | | |
| |  | | | | | | | |
| | opbouw waskom | | | | | | | |
| |  | 0080729 52x52cm m. kraangat m. WG | wit | 8128022001111 | stuk | 429,00 | 035 | 1 |
| | | 0080730 52x52cm z. kraangat m. WG | wit | 8128022001121 | stuk | 429,00 | 035 | 1 |
| |  | | | | | | | |

| Art.nr | Specificaties | Kleur | Lev.nr | Ehd | Prijs | Grp | CC |
|--------|---------------|-------|--------|-----|-------|-----|----|
|--------|---------------|-------|--------|-----|-------|-----|----|

Laufen Palomba

wastafel

| | | | | | | | | |
|---------|----------|-----------------------|-----|---------------|------|--------|-----|---|
| 0080731 | 100x50cm | m. kraangat m. WG | wit | 8108062001041 | stuk | 625,00 | 035 | 1 |
| 0080732 | 100x50cm | m. 2 kraangaten m. WG | wit | 8108062001071 | stuk | 625,00 | 035 | 1 |
| 0080733 | 100x50cm | m. 3 kraangaten m. WG | wit | 8108062001081 | stuk | 625,00 | 035 | 1 |



Sanitair producten

Baden /
douchebakken /
stoomcabines**waskom**

| | | | | | | | | |
|---------|---------|--------------------------|-----|---------------|------|--------|-----|---|
| 0080734 | 58x48cm | m. kraangat m. WG | wit | 8138012001111 | stuk | 426,00 | 035 | 1 |
| 0080735 | 58x48cm | m. kraangat links m. WG | wit | 8138012001131 | stuk | 426,00 | 035 | 1 |
| 0080736 | 58x48cm | m. kraangat rechts m. WG | wit | 8138012001141 | stuk | 426,00 | 035 | 1 |



Kranen

Douchegarnituur

opbouwastafel

| | | | | | | | | |
|---------|---------|--------------------------|-----|---------------|------|--------|-----|---|
| 0080737 | 58x48cm | m. kraangat m. WG | wit | 8138022001111 | stuk | 443,00 | 035 | 1 |
| 0080738 | 58x48cm | m. kraangat links m. WG | wit | 8138022001131 | stuk | 443,00 | 035 | 1 |
| 0080739 | 58x48cm | m. kraangat rechts m. WG | wit | 8138022001141 | stuk | 443,00 | 035 | 1 |

Accessoires en
spiegels**wastafelonderbouw m. 1 deur**

| | | | | | | | | |
|---------|---------|--------|----------|---------------|------|--------|-----|---|
| 0080740 | 40x44cm | links | makassar | 4202010805251 | stuk | 745,00 | 035 | 1 |
| 0080741 | 40x44cm | rechts | makassar | 4202020805251 | stuk | 745,00 | 035 | 1 |



Douchewanden

Toebehoren &
afvoeren**wandkast m. 1 lade**

| | | | | | | | | |
|---------|---------|--|----------|---------------|------|--------|-----|---|
| 0080742 | 40x44cm | | makassar | 4202230805251 | stuk | 790,00 | 035 | 1 |
|---------|---------|--|----------|---------------|------|--------|-----|---|

Spoel- &
installatiesystemenBadkamermeubelen
en toiletkasten**wandkast m. 2 laden**

| | | | | | | | | |
|---------|---------|--|----------|---------------|------|---------|-----|---|
| 0080743 | 40x44cm | | makassar | 4202240805251 | stuk | 1055,00 | 035 | 1 |
|---------|---------|--|----------|---------------|------|---------|-----|---|

Gootstenen en
wastroggen**wandkast m. 1 lade**

| | | | | | | | | |
|---------|---------|--|----------|---------------|------|--------|-----|---|
| 0080744 | 80x44cm | | makassar | 4202330805251 | stuk | 907,00 | 035 | 1 |
|---------|---------|--|----------|---------------|------|--------|-----|---|



Utiliteit

wandkast m. 2 laden

| | | | | | | | | |
|---------|---------|--|----------|---------------|------|---------|-----|---|
| 0080745 | 80x44cm | | makassar | 4202340805251 | stuk | 1210,00 | 035 | 1 |
|---------|---------|--|----------|---------------|------|---------|-----|---|

**trolley m. 2 laden**

| | | | | | | | | |
|---------|---------|--|----------|---------------|------|---------|-----|---|
| 0080746 | 40x44cm | | makassar | 4202540805251 | stuk | 1198,00 | 035 | 1 |
|---------|---------|--|----------|---------------|------|---------|-----|---|



| | Art.nr | Specificaties | Kleur | Lev.nr | Ehd | Prijs | Grp | CC |
|----------------------------------|--|----------------------------|---------------|---------------|--------|--------|-----|----|
| | Laufen Palomba | | | | | | | |
| | wastafelblad | | | | | | | |
| Sanitair producten | 0080747 | 80x44cm z. uitsparing | makassar | 4210010805251 | stuk | 378,00 | 035 | 1 |
| | 0080748 | 120x44cm z. uitsparing | makassar | 4210020805251 | stuk | 435,00 | 035 | 1 |
| | 0080749 | 160x44cm z. uitsparing | makassar | 4210030805251 | stuk | 541,00 | 035 | 1 |
| | 0080750 | 200x44cm z. uitsparing | makassar | 4210040805251 | stuk | 609,00 | 035 | 1 |
| | 0080751 | 80x44cm m. uitsparing | makassar | 4210110805251 | stuk | 480,00 | 035 | 1 |
| | 0080752 | 120x44cm m. uitsparing | makassar | 4210120805251 | stuk | 537,00 | 035 | 1 |
| | 0080753 | 160x44cm m. uitsparing | makassar | 4210130805251 | stuk | 643,00 | 035 | 1 |
| | 0080754 | 200x44cm m. uitsparing | makassar | 4210140805251 | stuk | 711,00 | 035 | 1 |
| | 0080756 | 120x44cm m. 2 uitsparingen | makassar | 4210220805251 | stuk | 639,00 | 035 | 1 |
| | 0080757 | 160x44cm m. 2 uitsparingen | makassar | 4210230805251 | stuk | 745,00 | 035 | 1 |
| 0080758 | 200x44cm m. 2 uitsparingen | makassar | 4210240805251 | stuk | 813,00 | 035 | 1 | |
| | wandlamp | | | | | | | |
| Douchegarnituur | 0080761 | 39x18cm | aluminium | 4960210800071 | stuk | 477,00 | 035 | 1 |
| | spiegel rond 60cm | | | | | | | |
| Accessoires en spiegels | 0080762 | | aluminium | 4403010800071 | stuk | 557,00 | 035 | 1 |
| Douchewanden | spiegel | | | | | | | |
| Toebehoren & afvoeren | 0080763 | 120x35cm | aluminium | 4403030800071 | stuk | 460,00 | 035 | 1 |
| | 0080764 | 160x35cm | aluminium | 4403040800071 | stuk | 535,00 | 035 | 1 |
| | 0080765 | 200x35cm | aluminium | 4403050800071 | stuk | 607,00 | 035 | 1 |
| Spoel- & installatiesystemen | sifonafdekking | | | | | | | |
| Badkamermeubelen en toiletkasten | 0080766 | | chrom | 4932020800041 | stuk | 95,50 | 035 | 1 |
| | handdoekhouder | | | | | | | |
| Gootstenen en wastroggen | 0080759 | 38cm | chrom | 4932060800041 | stuk | 59,00 | 035 | 1 |
| | 0080760 | 60cm | chrom | 4932080800041 | stuk | 64,50 | 035 | 1 |
| | Laufen Pro A | | | | | | | |
| | wastafel | | | | | | | |
| Utiliteit | 0080209 | 55x48cm | wit | 8189510001041 | stuk | 107,00 | 035 | 1 |
| | 0080212 | 55x48cm | pergamon | 8189510491041 | stuk | 128,00 | 035 | 1 |
| | 0080215 | 60x48cm | wit | 8189520001041 | stuk | 110,00 | 035 | 0 |
| | 0080218 | 60x48cm | pergamon | 8189520491041 | stuk | 132,00 | 035 | 1 |
| | 0080221 | 65x48cm | wit | 8189530001041 | stuk | 137,00 | 035 | 1 |
| | 0080224 | 65x48cm | pergamon | 8189530491041 | stuk | 164,00 | 035 | 1 |
| | 0830097 | bevestigingsset M10x110mm | | 0830097 | paar | 1,09 | 362 | 0 |
| | sifonkap voor wastafel m. snelbevestiging | | | | | | | |
| | 0080228 | | wit | 8199510000001 | stuk | 97,50 | 035 | 0 |
| | 0080231 | | pergamon | 8199510490001 | stuk | 117,00 | 035 | 1 |
| | zuil voor wastafel | | | | | | | |
| | 0080233 | | wit | 8199500000001 | stuk | 102,00 | 035 | 1 |
| | 0080235 | | pergamon | 8199500490001 | stuk | 122,00 | 035 | 1 |

| Art.nr | Specificaties | Kleur | Lev.nr | Ehd | Prijs | Grp | CC |
|--------|---------------|-------|--------|-----|-------|-----|----|
|--------|---------------|-------|--------|-----|-------|-----|----|

Laufen Pro A

meubelwastafel

| | | | | | | | |
|---------|---------------------------|----------|---------------|------|--------|-----|---|
| 0080237 | 85x48cm | wit | 8139560001041 | stuk | 346,00 | 035 | 1 |
| 0080239 | 85x48cm | pergamon | 8139560491041 | stuk | 415,00 | 035 | 1 |
| 0080242 | 105x48cm m. 1 kraangat | wit | 8139580001041 | stuk | 438,00 | 035 | 1 |
| 0080244 | 105x48cm m. 1 kraangat | pergamon | 8139580491041 | stuk | 526,00 | 035 | 1 |
| 0080246 | 105x48cm m. 3 kraangaten | wit | 8139580001081 | stuk | 438,00 | 035 | 1 |
| 0080248 | 105x48cm m. 3 kraangaten | pergamon | 8139580491081 | stuk | 526,00 | 035 | 1 |
| 0830097 | bevestigingsset M10x110mm | | 0830097 | paar | 1,09 | 362 | 0 |



Sanitair producten

Baden /
douchebakken /
stoomcabines

onderstel voor meubelwastafel

| | | | | | | | |
|---------|-------|-------|---------------|------|--------|-----|---|
| 0080241 | 85cm | chrom | 8909560040001 | stuk | 266,00 | 035 | 1 |
| 0080494 | 105cm | chrom | 8909580040001 | stuk | 304,00 | 035 | 1 |

Kranen

fontein

| | | | | | | | |
|---------|--------------------------------------|----------|---------------|------|--------|-----|---|
| 0080250 | 45x34cm | wit | 8119510001041 | stuk | 86,50 | 035 | 1 |
| 0080252 | 45x34cm | pergamon | 8119510491041 | stuk | 104,00 | 035 | 1 |
| 0830240 | bevestigingsset voor fontein M8x90mm | | 0830240 | stuk | 0,85 | 362 | 0 |



Douchegarnituur

sifonkap voor fontein

| | | | | | | | |
|---------|--|----------|---------------|------|--------|-----|---|
| 0080254 | | wit | 8199520000001 | stuk | 97,50 | 035 | 1 |
| 0080256 | | pergamon | 8199520490001 | stuk | 117,00 | 035 | 1 |

Accessoires en
spiegels

Douchewanden

Laufen Pro B

wastafel

| | | | | | | | |
|---------|---------------------------|----------|---------------|------|--------|-----|---|
| 0080258 | 55x44cm | wit | 8109510001041 | stuk | 91,00 | 035 | 1 |
| 0080260 | 55x44cm | pergamon | 8109510491041 | stuk | 109,00 | 035 | 1 |
| 0080262 | 60x48cm | wit | 8109520001041 | stuk | 83,00 | 035 | 1 |
| 0080264 | 60x48cm | pergamon | 8109520491041 | stuk | 99,50 | 035 | 1 |
| 0080268 | 65x50cm | pergamon | 8109530491041 | stuk | 127,00 | 035 | 1 |
| 0830097 | bevestigingsset M10x110mm | | 0830097 | paar | 1,09 | 362 | 0 |

Toebehoren &
afvoerenSpoel- &
installatiesystemen

sifonkap voor wastafel m. snelbevestiging

| | | | | | | | |
|---------|--|----------|---------------|------|--------|-----|---|
| 0080228 | | wit | 8199510000001 | stuk | 97,50 | 035 | 0 |
| 0080231 | | pergamon | 8199510490001 | stuk | 117,00 | 035 | 1 |

Badkamermeubelen
en toiletkastenGootstenen en
wastroggen

zuil voor wastafel

| | | | | | | | |
|---------|--|----------|---------------|------|--------|-----|---|
| 0080233 | | wit | 8199500000001 | stuk | 102,00 | 035 | 1 |
| 0080235 | | pergamon | 8199500490001 | stuk | 122,00 | 035 | 1 |



Utiliteit

opbouwastafel

| | | | | | | | |
|---------|---------|----------|---------------|------|--------|-----|---|
| 0080270 | 56x44cm | wit | 8139510001041 | stuk | 150,00 | 035 | 1 |
| 0080272 | 56x44cm | pergamon | 8139510491041 | stuk | 180,00 | 035 | 1 |



fontein

| | | | | | | | |
|---------|--------------------------------------|----------|---------------|------|--------|-----|---|
| 0080274 | 35x31cm | wit | 8159500001041 | stuk | 43,50 | 035 | 1 |
| 0080276 | 35x31cm | pergamon | 8159500491041 | stuk | 52,50 | 035 | 1 |
| 0080278 | 40x32cm | wit | 8159510001041 | stuk | 46,50 | 035 | 1 |
| 0080280 | 40x32cm | pergamon | 8159510491041 | stuk | 56,00 | 035 | 1 |
| 0080282 | 45x33cm | wit | 8159520001041 | stuk | 71,50 | 035 | 1 |
| 0080284 | 45x33cm | pergamon | 8159520491041 | stuk | 85,50 | 035 | 1 |
| 0080286 | 50x36cm | wit | 8159530001041 | stuk | 87,50 | 035 | 1 |
| 0080288 | 50x36cm | pergamon | 8159530491041 | stuk | 105,00 | 035 | 1 |
| 0830240 | bevestigingsset voor fontein M8x90mm | | 0830240 | stuk | 0,85 | 362 | 0 |



| Art.nr | Specificaties | Kleur | Lev.nr | Ehd | Prijs | Grp | CC |
|--------|---------------|-------|--------|-----|-------|-----|----|
|--------|---------------|-------|--------|-----|-------|-----|----|

Laufen Pro B

sifonkap voor fontein

| | | | | | | | |
|---------|--|----------|---------------|------|--------|-----|---|
| 0080254 | | wit | 8199520000001 | stuk | 97,50 | 035 | 1 |
| 0080256 | | pergamon | 8199520490001 | stuk | 117,00 | 035 | 1 |



Sanitair producten

Baden /
douchebakken /
stoomcabines

Laufen Pro C

wastafel

| | | | | | | | |
|---------|---------------------------|----------|---------------|------|--------|-----|---|
| 0080290 | 55x40cm | wit | 8149510001041 | stuk | 106,00 | 035 | 1 |
| 0080292 | 55x40cm | pergamon | 8149510491041 | stuk | 127,00 | 035 | 1 |
| 0080294 | 60x42cm | wit | 8149520001041 | stuk | 101,00 | 035 | 1 |
| 0080296 | 60x42cm | pergamon | 8149520491041 | stuk | 121,00 | 035 | 1 |
| 0830097 | bevestigingsset M10x110mm | | 0830097 | paar | 1,09 | 362 | 0 |



Kranen

Douchegarnituur

sifonkap voor wastafel m. snelbevestiging

| | | | | | | | |
|---------|--|----------|---------------|------|--------|-----|---|
| 0080228 | | wit | 8199510000001 | stuk | 97,50 | 035 | 0 |
| 0080231 | | pergamon | 8199510490001 | stuk | 117,00 | 035 | 1 |



Accessoires en
spiegels

Douchewanden

zuil voor wastafel

| | | | | | | | |
|---------|--|----------|---------------|------|--------|-----|---|
| 0080233 | | wit | 8199500000001 | stuk | 102,00 | 035 | 1 |
| 0080235 | | pergamon | 8199500490001 | stuk | 122,00 | 035 | 1 |



Toebehoren &
afvoeren

hoekfontein

| | | | | | | | |
|---------|--------------------------------------|----------|---------------|------|-------|-----|---|
| 0080310 | 49.5x50cm | wit | 8169560001041 | stuk | 81,00 | 035 | 1 |
| 0080312 | 49.5x50cm | pergamon | 8169560491041 | stuk | 97,50 | 035 | 1 |
| 0830240 | bevestigingsset voor fontein M8x90mm | | 0830240 | stuk | 0,85 | 362 | 0 |



Spoel- &
installatiesystemen

Badkamermeubelen
en toiletkasten

fontein

| | | | | | | | | |
|---------|--------------------------------------|-----------------|----------|---------------|------|--------|-----|---|
| 0080302 | 50x25cm | kraangat links | wit | 8169570001051 | stuk | 95,00 | 035 | 1 |
| 0080304 | 50x25cm | kraangat links | pergamon | 8169570491051 | stuk | 114,00 | 035 | 1 |
| 0080306 | 50x25cm | kraangat rechts | wit | 8169570001061 | stuk | 95,00 | 035 | 1 |
| 0080308 | 50x25cm | kraangat rechts | pergamon | 8169570491061 | stuk | 114,00 | 035 | 1 |
| 0830240 | bevestigingsset voor fontein M8x90mm | | 0830240 | stuk | 0,85 | 362 | 0 | |



Gootstenen en
wastroggen

Laufen Pro

wandclosetpot diepspoel

| | | | | | | | |
|---------|--|----------|---------------|------|--------|-----|---|
| 0080331 | | wit | 8209500000001 | stuk | 165,00 | 035 | 0 |
| 0080333 | | pergamon | 8209500490001 | stuk | 198,00 | 035 | 1 |



Utiliteit

wandclosetpot vlakspoel



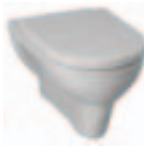





| | | | | | | | |
|---------|--|----------|---------------|------|--------|-----|---|
| 0080339 | | wit | 8209510000001 | stuk | 210,00 | 035 | 1 |
| 0080341 | | pergamon | 8209510490001 | stuk | 252,00 | 035 | 1 |











wandclosetpot diepspoel compact

| | | | | | | | |
|---------|--|----------|---------------|------|--------|-----|---|
| 0080335 | | wit | 8209520000001 | stuk | 184,00 | 035 | 0 |
| 0080337 | | pergamon | 8209520490001 | stuk | 221,00 | 035 | 1 |

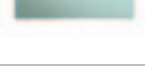

| Art.nr | Specificaties | Kleur | Lev.nr | Ehd | Prijs | Grp | CC | | |
|---|-----------------------------------|----------|---------------|------|--------|-----|----|---|---|
| | | | | | | | | Laufen Pro | |
| duoblokpot diepspoel PK z. reservoir | | | | | | | | | |
| 0080314 | | wit | 8249560002041 | stuk | 129,00 | 035 | 1 |  | Sanitair producten |
| 0080316 | | pergamon | 8249560492041 | stuk | 155,00 | 035 | 1 | | |
| 0080054 | afvoerbocht verstelbaar 70-220mm | | 8900920000001 | stuk | 77,00 | 035 | 1 | | |
| duoblokpot diepspoel AO z. reservoir | | | | | | | | | |
| 0080323 | | wit | 8249570002041 | stuk | 133,00 | 035 | 1 |  | Baden / douchebakken / stoomcabines |
| 0080325 | | pergamon | 8249570492041 | stuk | 159,00 | 035 | 1 | | |
| duoblokpot vlakspoel PK z. reservoir | | | | | | | | | |
| 0080327 | | wit | 8249590002041 | stuk | 146,00 | 035 | 0 |  | Kranen |
| 0080329 | | pergamon | 8249590492041 | stuk | 176,00 | 035 | 1 | | |
| 0080054 | afvoerbocht verstelbaar 70-220mm | | 8900920000001 | stuk | 77,00 | 035 | 1 | | |
| 0080120 | afvoerbocht verstelbaar 220-300mm | | 8990250000001 | stuk | 77,00 | 035 | 0 | | |
| reservoir + binnenwerk | | | | | | | | | |
| 0080318 | | wit | 8269500002781 | stuk | 128,00 | 035 | 0 |  | Douchegarnituur |
| 0080320 | | pergamon | 8269500492781 | stuk | 154,00 | 035 | 1 | | |
| closetzitting dubbel afneembaar antibacterieel | | | | | | | | | |
| 0080347 | | wit | 8919503000001 | stuk | 99,50 | 035 | 0 |  | Accessoires en spiegels |
| 0080348 | | pergamon | 8919503490001 | stuk | 134,00 | 035 | 1 | | |
| closetzitting dubbel afneembaar antibacterieel m. dempingsmechanisme | | | | | | | | | |
| 0080349 | | wit | 8919513000001 | stuk | 200,00 | 035 | 0 | | Douchewanden |
| 0080351 | | pergamon | 8919513490001 | stuk | 240,00 | 035 | 1 | | |
| closetzitting dubbel m. RVS scharnieren | | | | | | | | | |
| 0080344 | | wit | 8929510000001 | stuk | 38,75 | 035 | 0 |  | Toehoren & afvoeren |
| 0080345 | | pergamon | 8929510490001 | stuk | 46,50 | 035 | 1 | | |
| wandbidet | | | | | | | | | |
| 0080352 | | wit | 8309510003041 | stuk | 182,00 | 035 | 1 |  | Spoel- & installatiesystemen |
| 0080355 | | pergamon | 8309510493041 | stuk | 218,00 | 035 | 1 | | |
| keramisch urinoirschot m. montageset | | | | | | | | | |
| 0080357 | | wit | 8476000000001 | stuk | 257,00 | 035 | 1 |  | Badkamermeubelen en toiletkasten |
| 0080358 | | pergamon | 8476000490001 | stuk | 322,00 | 035 | 1 | | |
| universeel planchet | | | | | | | | | |
| 0080366 | 40x13cm | wit | 8702500000001 | stuk | 43,50 | 035 | 1 |  | Gootstenen en wastroggen |
| 0080363 | 50x13.5cm | wit | 8702520000001 | stuk | 36,00 | 035 | 1 | | |
| 0080361 | 60x14cm | wit | 8702540000001 | stuk | 45,25 | 035 | 1 | | |
| 0080362 | 60x14cm | pergamon | 8702540490001 | stuk | 56,50 | 035 | 1 | | |
| 0830453 | set potschroeven 5.5x60mm chroom | | 0830453 | stuk | 2,28 | 362 | 0 | | |

Utiliteit

| | Art.nr | Specificaties | Kleur | Lev.nr | Ehd | Prijs | Grp | CC | |
|---|---|---|---------------------------------|---------------|---------------|--------|--------|-----|---|
| Sanitair producten | Laufen Suprema | | | | | | | | |
| | wandclosetpot diepspoel | | | | | | | | |
|  | 0080145 | | wit | 8216500000001 | stuk | 181,00 | 035 | 1 | |
| | 0084007 | | pergamon | 8216500490001 | stuk | 222,00 | 035 | 1 | |
| Baden / douchebakken / stoomcabines | Laufen Talux | | | | | | | | |
| Kranen | meubelwastafel | | | | | | | | |
| |  | 0080804 | 81x55.5cm | wit | 8146700001041 | stuk | 396,00 | 035 | 1 |
| | | 0080805 | 81x55.5cm m. WG | wit | 8146702001041 | stuk | 450,00 | 035 | 1 |
| | | 0080808 | 91x55.5cm bak links | wit | 8146710001041 | stuk | 586,00 | 035 | 1 |
| | | 0080809 | 91x55.5cm bak links m. WG | wit | 8146712001041 | stuk | 640,00 | 035 | 1 |
| | | 0080811 | 91x55.5cm bak rechts | wit | 8146720001041 | stuk | 586,00 | 035 | 1 |
| Douchegarnituur |  | 0080812 | 91x55.5cm bak rechts m. WG | wit | 8146722001041 | stuk | 640,00 | 035 | 1 |
| | | 0830097 | bevestigingsset M10x110mm | | 0830097 | paar | 1,09 | 362 | 0 |
| Accessoires en spiegels |  | meubelwastafel dubbel | | | | | | | |
| Douchewanden | | 0080814 | 121x55.5cm | wit | 8146770001041 | stuk | 821,00 | 035 | 1 |
| | | 0080815 | 121x55.5cm m. WG | wit | 8146772001041 | stuk | 875,00 | 035 | 1 |
| Toebehoren & afvoeren |  | 0080818 | 151x55.5cm | wit | 8146780001041 | stuk | 850,00 | 035 | 1 |
| | | 0080819 | 151x55.5cm m. WG | wit | 8146782001041 | stuk | 904,00 | 035 | 1 |
| Spoel- & installatiesystemen | | 0830097 | bevestigingsset M10x110mm | | 0830097 | paar | 1,09 | 362 | 0 |
| Badkamermeubelen en toiletkasten |  | onderbouwkast m. 2 deuren | | | | | | | |
| Gootstenen en wastroggen |  | 0080806 | 76x53.5x55.4cm | wit | 4243030775001 | stuk | 684,55 | 035 | 1 |
| | Utiliteit |  | onderbouwkast m. 2 laden | | | | | | |
| | | 0080807 | 76x53.5x55.4cm | wit | 4243040775001 | stuk | 878,50 | 035 | 1 |
| |  | onderbouwkast m. 2 laden m. deur links | | | | | | | |
| |  | 0080810 | 86x53.5x55.4cm | wit | 4243210775001 | stuk | 821,45 | 035 | 1 |

| Art.nr | Specificaties | Kleur | Lev.nr | Ehd | Prijs | Grp | CC |
|--------|---------------|-------|--------|-----|-------|-----|----|
|--------|---------------|-------|--------|-----|-------|-----|----|

Laufen Talux

onderbouwkast m. 2 laden m. deur rechts

| | | | | | | | |
|---------|----------------|-----|---------------|------|--------|-----|---|
| 0080813 | 86x53.5x55.4cm | wit | 4243220775001 | stuk | 821,45 | 035 | 1 |
|---------|----------------|-----|---------------|------|--------|-----|---|



Sanitair producten

Baden /
douchebakken /
stoomcabines**onderbouwkast m. 4 laden**

| | | | | | | | |
|---------|---------------|-----|---------------|------|---------|-----|---|
| 0080816 | 116x53.5x55.4 | wit | 4243640775001 | stuk | 1300,64 | 035 | 1 |
|---------|---------------|-----|---------------|------|---------|-----|---|



Kranen

Douchegarnituur

onderbouwkast m. 2 laden m. 2 deuren

| | | | | | | | |
|---------|---------------|-----|---------------|------|---------|-----|---|
| 0080817 | 116x53.5x55.4 | wit | 4243660775001 | stuk | 1186,55 | 035 | 1 |
|---------|---------------|-----|---------------|------|---------|-----|---|

| | | | | | | | |
|---------|---------------|-----|---------------|------|---------|-----|---|
| 0080820 | 146x53.5x55.4 | wit | 4243860775001 | stuk | 1232,18 | 035 | 1 |
|---------|---------------|-----|---------------|------|---------|-----|---|

Accessoires en
spiegels

Douchewanden

Toebehoren &
afvoeren**hoge kast m. 2 deuren m. 1 lade**

| | | | | | | | | |
|---------|----------|-------|-----|---------------|------|--------|-----|---|
| 0080821 | 175x38cm | links | wit | 4340210775001 | stuk | 867,09 | 035 | 1 |
|---------|----------|-------|-----|---------------|------|--------|-----|---|

| | | | | | | | | |
|---------|----------|--------|-----|---------------|------|--------|-----|---|
| 0080822 | 175x38cm | rechts | wit | 4340220775001 | stuk | 867,09 | 035 | 1 |
|---------|----------|--------|-----|---------------|------|--------|-----|---|

Spoel- &
installatiesystemenBadkamermeubelen
en toiletkasten**spiegel**

| | | | | | | | | |
|---------|---------|--|--|---------------|------|--------|-----|---|
| 0080823 | 38x95cm | | | 4409550705701 | stuk | 234,00 | 035 | 1 |
|---------|---------|--|--|---------------|------|--------|-----|---|

spiegel m. planchet

| | | | | | | | | |
|---------|-----------|--|--|---------------|------|--------|-----|---|
| 0080825 | 53x73.8cm | | | 4419550705701 | stuk | 328,00 | 035 | 1 |
|---------|-----------|--|--|---------------|------|--------|-----|---|

spiegel m. verlichting

| | | | | | | | | |
|---------|---------|--|--|---------------|------|--------|-----|---|
| 0080824 | 38x95cm | | | 4409510705701 | stuk | 343,00 | 035 | 1 |
|---------|---------|--|--|---------------|------|--------|-----|---|



Utiliteit

spiegel m. planchet m. verlichting

| | | | | | | | | |
|---------|-----------|--|--|---------------|------|--------|-----|---|
| 0080826 | 53x73.8cm | | | 4419510705701 | stuk | 536,00 | 035 | 1 |
|---------|-----------|--|--|---------------|------|--------|-----|---|

**spiegel m. planchet**

| | | | | | | | | |
|---------|--------------|--|--|---------------|------|--------|-----|---|
| 0080827 | 117.5x73.8cm | | | 4429550705701 | stuk | 447,00 | 035 | 1 |
|---------|--------------|--|--|---------------|------|--------|-----|---|

| Art.nr | Specificaties | Kleur | Lev.nr | Ehd | Prijs | Grp | CC |
|--------|---------------|-------|--------|-----|-------|-----|----|
|--------|---------------|-------|--------|-----|-------|-----|----|

Laufen Talux

spiegel m. planchet m. verlichting

| | | | | | | | |
|---------|--------------|--|---------------|------|--------|-----|---|
| 0080828 | 117.5x73.8cm | | 4429510705701 | stuk | 755,00 | 035 | 1 |
|---------|--------------|--|---------------|------|--------|-----|---|



Sanitair producten

Baden /
douchebakken /
stoomcabines

Laufen Vienna

wastafel

| | | | | | | | |
|---------|---------------------------|----------|---------------|------|--------|-----|---|
| 0089346 | 60x46cm | wit | 8100340000001 | stuk | 248,00 | 035 | 1 |
| 0089869 | 60x46cm | pergamon | 8100340490001 | stuk | 248,00 | 035 | 1 |
| 0089338 | 65x55cm | wit | 8100350000001 | stuk | 262,00 | 035 | 1 |
| 0089850 | 65x55cm | pergamon | 8100350490001 | stuk | 262,00 | 035 | 1 |
| 0080372 | 70x55.5cm | wit | 8100370000001 | stuk | 295,00 | 035 | 1 |
| 0080125 | 70x55.5cm | pergamon | 8100370490001 | stuk | 295,00 | 035 | 1 |
| 0080037 | 80x56.5cm | wit | 8100380000001 | stuk | 307,00 | 035 | 1 |
| 0084009 | 80x56.5cm | pergamon | 8100380490001 | stuk | 307,00 | 035 | 1 |
| 0830097 | bevestigingsset M10x110mm | | 0830097 | paar | 1,09 | 362 | 0 |



Kranen

Douchegarnituur

Accessoires en
spiegels

Douchewanden

sifonkap voor wastafel

| | | | | | | | |
|---------|--|----------|---------------|------|--------|-----|---|
| 0080038 | | wit | 8190310000001 | stuk | 190,00 | 035 | 1 |
| 0084013 | | pergamon | 8190310490001 | stuk | 190,00 | 035 | 1 |



Toebehoren &
afvoeren

Spoel- &
installatiesystemen

zuil voor wastafel

| | | | | | | | |
|---------|--|----------|---------------|------|--------|-----|---|
| 0089354 | | wit | 8190300000001 | stuk | 190,00 | 035 | 1 |
| 0089877 | | pergamon | 8190300490001 | stuk | 190,00 | 035 | 1 |



fontein

| | | | | | | | |
|---------|--------------------------------------|----------|---------------|------|--------|-----|---|
| 0089362 | 50x35cm | wit | 8153040000001 | stuk | 142,00 | 035 | 1 |
| 0089885 | 50x35cm | pergamon | 8153040490001 | stuk | 142,00 | 035 | 1 |
| 0830240 | bevestigingsset voor fontein M8x90mm | | 0830240 | stuk | 0,85 | 362 | 0 |



Badkamermeubelen
en toiletkasten

Gootstenen en
wastroggen

sifonkap voor fontein m. snelbevestiging

| | | | | | | | |
|---------|--|----------|---------------|------|--------|-----|---|
| 0089370 | | wit | 8190330000001 | stuk | 190,00 | 035 | 1 |
| 0089893 | | pergamon | 8190330490001 | stuk | 190,00 | 035 | 1 |

wandbidet

| | | | | | | | |
|---------|--|----------|---------------|------|--------|-----|---|
| 0084002 | | wit | 8315910000001 | stuk | 370,00 | 035 | 1 |
| 0080098 | | pergamon | 8315910490001 | stuk | 370,00 | 035 | 1 |



Utiliteit

staand bidet

| | | | | | | | |
|---------|--|----------|---------------|------|--------|-----|---|
| 0089443 | | wit | 8305910000001 | stuk | 305,00 | 035 | 1 |
| 0089966 | | pergamon | 8305910490001 | stuk | 305,00 | 035 | 1 |



wandclosetpot diepspoel

| | | | | | | | |
|---------|--|----------|---------------|------|--------|-----|---|
| 0080019 | | wit | 8215800000001 | stuk | 369,00 | 035 | 1 |
| 0080099 | | pergamon | 8215800490001 | stuk | 369,00 | 035 | 1 |



| Art.nr | Specificaties | Kleur | Lev.nr | Ehd | Prijs | Grp | CC |
|--------|---------------|-------|--------|-----|-------|-----|----|
|--------|---------------|-------|--------|-----|-------|-----|----|

Laufen Vienna

wandclosetpot vlakspoel

| | | | | | | | |
|---------|--|----------|---------------|------|--------|-----|---|
| 0089427 | | wit | 8205800000001 | stuk | 396,00 | 035 | 1 |
| 0089958 | | pergamon | 8205800490001 | stuk | 396,00 | 035 | 1 |



Sanitair producten

Baden /
douchebakken /
stoomcabines

Kranen

Douchegarnituur

Accessoires en
spiegels

Douchewanden

Toebehoren &
afvoerenSpoel- &
installatiesystemenBadkamermeubelen
en toiletkastenGootstenen en
wastroggen

Utiliteit

closetzitting m. deksel

| | | | | | | | |
|---------|--|----------|---------------|------|--------|-----|---|
| 0750022 | | wit | 8924700000001 | stuk | 148,00 | 035 | 1 |
| 0080121 | | pergamon | 8924700490001 | stuk | 148,00 | 035 | 1 |

closetpot vlakspoel m. vloerbevestiging

| | | | | | | | |
|---------|-----------------------------------|----------|---------------|------|--------|-----|---|
| 0089400 | | wit | 8202990000001 | stuk | 414,00 | 035 | 1 |
| 0089931 | | pergamon | 8202990490001 | stuk | 414,00 | 035 | 1 |
| 0080054 | afvoerbocht verstelbaar 70-220mm | | 8900920000001 | stuk | 77,00 | 035 | 1 |
| 0080120 | afvoerbocht verstelbaar 220-300mm | | 8990250000001 | stuk | 77,00 | 035 | 0 |

**closetpot diepspoel m. bevestigingsset**

| | | | | | | | |
|---------|-----------------------------------|----------|---------------|------|--------|-----|---|
| 0089389 | | wit | 8215990000001 | stuk | 355,00 | 035 | 1 |
| 0089907 | | pergamon | 8215990490001 | stuk | 355,00 | 035 | 1 |
| 0080054 | afvoerbocht verstelbaar 70-220mm | | 8900920000001 | stuk | 77,00 | 035 | 1 |
| 0080120 | afvoerbocht verstelbaar 220-300mm | | 8990250000001 | stuk | 77,00 | 035 | 0 |

**duoblokeservoir dualflush**

| | | | | | | | |
|---------|--|--------------|---------------|------|--------|-----|---|
| 0089397 | | wit/chroom | 8264700002781 | stuk | 290,00 | 035 | 1 |
| 0080119 | | perg./chroom | 8264700492781 | stuk | 290,00 | 035 | 1 |



Laufen Vienna Comfort

closetpot diepspoel m. bevestigingsset

| | | | | | | | |
|---------|--|----------|---------------|------|--------|-----|---|
| 0089451 | | wit | 8204590000001 | stuk | 541,00 | 035 | 1 |
| 0089974 | | pergamon | 8204590490001 | stuk | 541,00 | 035 | 1 |

**closetpot vlakspoel m. vloerbevestiging**

| | | | | | | | |
|---------|--|----------|---------------|------|--------|-----|---|
| 0089478 | | wit | 8214590000001 | stuk | 556,00 | 035 | 1 |
| 0089982 | | pergamon | 8214590490001 | stuk | 556,00 | 035 | 1 |

**closetpot vlakspoel**

| | | | | | | | |
|---------|--|----------|---------------|------|--------|-----|---|
| 0089494 | | wit | 8204700000001 | stuk | 415,00 | 035 | 1 |
| 0092037 | | pergamon | 8204700490001 | stuk | 415,00 | 035 | 1 |

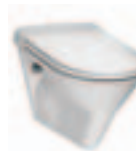
**wandclosetpot diepspoel**

| | | | | | | | |
|---------|--|----------|---------------|------|--------|-----|---|
| 0089486 | | wit | 8234700000001 | stuk | 382,00 | 035 | 1 |
| 0092029 | | pergamon | 8234700490001 | stuk | 382,00 | 035 | 1 |

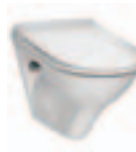
**closetzitting m. deksel**

| | | | | | | | |
|---------|--|----------|---------------|------|--------|-----|---|
| 0750022 | | wit | 8924700000001 | stuk | 148,00 | 035 | 1 |
| 0080121 | | pergamon | 8924700490001 | stuk | 148,00 | 035 | 1 |

| Art.nr | Specificaties | Kleur | Lev.nr | Ehd | Prijs | Grp | CC |
|--------------------------|-----------------------------------|-------|---------------|------|-------|-----|----|
| Laufen Toebehoren | | | | | | | |
| 0080054 | afvoerbocht verstelbaar 70-220mm | | 8900920000001 | stuk | 77,00 | 035 | 1 |
| 0080120 | afvoerbocht verstelbaar 220-300mm | | 8990250000001 | stuk | 77,00 | 035 | 0 |

Sanitair producten

Baden /
douchebakken /
stoomcabines

Kranen

Douchegarnituur

Accessoires en
spiegels

Douchewanden

Toebehoren &
afvoeren

Spoel- &
installatiesystemen

Badkamermeubelen
en toiletkasten

Gootstenen en
wastroggen

Utiliteit

| Art.nr | Specificaties | Kleur | Lev.nr | Ehd | Prijs | Grp | CC |
|--------|---------------|-------|--------|-----|-------|-----|----|
|--------|---------------|-------|--------|-----|-------|-----|----|

Plieger Brussel New

wastafel

| | | | | | | | |
|---------|---------------------------|----------|---------|------|-------|-----|---|
| 0190624 | 55x42cm | wit | 0190624 | stuk | 47,25 | 004 | 0 |
| 0190626 | 55x42cm | pergamon | 0190626 | stuk | 62,50 | 004 | 0 |
| 0190628 | 60x45cm | wit | 0190628 | stuk | 48,50 | 004 | 0 |
| 0190630 | 60x45cm | pergamon | 0190630 | stuk | 63,50 | 004 | 0 |
| 0830097 | bevestigingsset M10x110mm | | 0830097 | paar | 1,09 | 362 | 0 |



Sanitair producten

Baden /
douchebakken /
stoomcabines

Kranen

Douchegarnituur

Accessoires en
spiegels

Douchewanden

Toebehoren &
afvoerenSpoel- &
installatiesystemenBadkamermeubelen
en toiletkastenGootstenen en
wastroggen

Utiliteit

zuil voor wastafel

| | | | | | | | |
|---------|--|----------|---------|------|-------|-----|---|
| 0190632 | | wit | 0190632 | stuk | 46,25 | 004 | 0 |
| 0190634 | | pergamon | 0190634 | stuk | 57,00 | 004 | 0 |

**sifonkap voor wastafel**

| | | | | | | | |
|---------|---|----------|---------|------|-------|-----|---|
| 0190636 | | wit | 0190636 | stuk | 38,25 | 004 | 0 |
| 0190638 | | pergamon | 0190638 | stuk | 51,00 | 004 | 0 |
| 0190690 | Brussel New bevestigingsset voor sifonkap | chrom | 0190690 | stuk | 6,00 | 362 | 0 |

fontein

| | | | | | | | |
|---------|--------------------------------------|----------|---------|------|-------|-----|---|
| 0190640 | 37,5x28cm | wit | 0190640 | stuk | 26,75 | 004 | 0 |
| 0190642 | 37,5x28cm | pergamon | 0190642 | stuk | 39,25 | 004 | 0 |
| 0190644 | 40x32cm | wit | 0190644 | stuk | 38,25 | 004 | 0 |
| 0190646 | 40x32cm | pergamon | 0190646 | stuk | 51,00 | 004 | 0 |
| 0830240 | bevestigingsset voor fontein M8x90mm | | 0830240 | stuk | 0,85 | 362 | 0 |

**hoekfontein**

| | | | | | | | |
|---------|--------------------------------------|----------|---------|------|-------|-----|---|
| 0190648 | 44.5x42.5cm | wit | 0190648 | stuk | 52,00 | 004 | 0 |
| 0190650 | 44.5x42.5cm | pergamon | 0190650 | stuk | 64,50 | 004 | 0 |
| 0830240 | bevestigingsset voor fontein M8x90mm | | 0830240 | stuk | 0,85 | 362 | 0 |

**closetpot vlakspoel AO**

| | | | | | | | |
|---------|---------------------------|----------|---------|------|-------|-----|---|
| 0190652 | | wit | 0190652 | stuk | 52,00 | 004 | 0 |
| 0190656 | | pergamon | 0190656 | stuk | 64,50 | 004 | 0 |
| 0830453 | set potschroeven 5.5x60mm | chrom | 0830453 | stuk | 2,28 | 362 | 0 |

**closetpot vlakspoel PK**

| | | | | | | | |
|---------|---------------------------|----------|---------|------|-------|-----|---|
| 0190654 | | wit | 0190654 | stuk | 52,00 | 004 | 0 |
| 0190658 | | pergamon | 0190658 | stuk | 64,50 | 004 | 0 |
| 0830453 | set potschroeven 5.5x60mm | chrom | 0830453 | stuk | 2,28 | 362 | 0 |

**wandclosetpot diepspoel**

| | | | | | | | |
|---------|--|----------|---------|------|--------|-----|---|
| 0190660 | | wit | 0190660 | stuk | 98,00 | 004 | 0 |
| 0190662 | | pergamon | 0190662 | stuk | 116,00 | 004 | 0 |

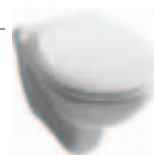
**duoblokpot diepspoel AO z. reservoir**

| | | | | | | | |
|---------|--|----------|---------|------|-------|-----|---|
| 0190664 | | wit | 0190664 | stuk | 68,50 | 004 | 0 |
| 0190670 | | pergamon | 0190670 | stuk | 83,00 | 004 | 0 |



| | Art.nr | Specificaties | Kleur | Lev.nr | Ehd | Prijs | Grp | CC |
|---|---|---|----------|---------|------|--------|-----|----|
| Sanitair producten | Plieger Brussel New | | | | | | | |
| | duoblokpot diepspoel PK z. reservoir | | | | | | | |
| | 0190666 | | wit | 0190666 | stuk | 68,50 | 004 | 0 |
| | 0190672 | | pergamon | 0190672 | stuk | 83,00 | 004 | 0 |
| Baden / douchebakken / stoomcabines | duoblokreservoir + binnenwerk keramisch | | | | | | | |
| | 0190668 | | wit | 0190668 | stuk | 80,00 | 004 | 0 |
| | 0190674 | | pergamon | 0190674 | stuk | 93,50 | 004 | 0 |
| Kranen | closetcombinatie diepspoel AO m. keramisch reservoir | | | | | | | |
| | 0190676 | | wit | 0190676 | stuk | 147,50 | 004 | 0 |
| | 0190680 | | pergamon | 0190680 | stuk | 175,50 | 004 | 0 |
| | 0190688 | bevestigingsset voor duoblokpot (hoekjes) | | 0190688 | stuk | 6,80 | 421 | 0 |
| Douchegarnituur | closetcombinatie diepspoel PK m. keramisch reservoir | | | | | | | |
| | 0190678 | | wit | 0190678 | stuk | 147,50 | 004 | 0 |
| | 0190682 | | pergamon | 0190682 | stuk | 175,50 | 004 | 0 |
| | 0190688 | bevestigingsset voor duoblokpot (hoekjes) | | 0190688 | stuk | 6,80 | 421 | 0 |
| Accessoires en spiegels | closetcombinatie diepspoel m. kunststof reservoir | | | | | | | |
| | 0190684 | AO | wit | 0190684 | stuk | 102,25 | 004 | 0 |
| | 0190686 | PK | wit | 0190686 | stuk | 102,25 | 004 | 0 |
| | 0190688 | bevestigingsset voor duoblokpot (hoekjes) | | 0190688 | stuk | 6,80 | 421 | 0 |
| Douchewanden | bevestigingsset voor duoblokpot (hoekjes) | | | | | | | |
| | 0190688 | | | 0190688 | stuk | 6,80 | 421 | 0 |
| Toebehoren & afvoeren | Plieger Compact | | | | | | | |
| | wandcloset diepspoel verkort | | | | | | | |
| | 0260482 | | wit | 0260482 | stuk | 99,00 | 004 | 0 |
| | 0260484 | | pergamon | 0260484 | stuk | 119,00 | 004 | 0 |
| Spoel- & installatiesystemen | klosetzitting verkort | | | | | | | |
| | 0260486 | | wit | 0260486 | stuk | 69,00 | 004 | 0 |
| | 0260488 | | pergamon | 0260488 | stuk | 79,00 | 004 | 0 |
| Badkamermeubelen en toiletkasten | | | | | | | | |
| Gootstenen en wastroggen | | | | | | | | |
| Utiliteit | | | | | | | | |



Liberty Sanitair_serie



| | Art.nr | Specificaties | Kleur | Lev.nr | Ehd | Prijs | Grp | CC |
|---|--|---------------------------|--------------------------------------|----------|---------|--------|--------|-------|
| Sanitair producten | Plieger Liberty | | | | | | | |
| | wastafel | | | | | | | |
| | | 0190306 | 60x50cm | wit | 0190306 | stuk | 103,00 | 009 0 |
| | | 0190314 | 60x50cm | pergamon | 0190314 | stuk | 124,00 | 009 0 |
| | 0830097 | bevestigingsset M10x110mm | | 0830097 | paar | 1,09 | 362 0 | |
| Baden / douchebakken / stoomcabines | sifonkap voor wastafel m. bevestigingsset | | | | | | | |
| | | 0190322 | | wit | 0190322 | stuk | 121,00 | 009 0 |
| | 0190330 | | pergamon | 0190330 | stuk | 145,00 | 009 0 | |
| Kranen | fontein | | | | | | | |
| | | 0190381 | 47x37.5cm | wit | 0190381 | stuk | 68,50 | 009 0 |
| | | 0190403 | 47x37.5cm | pergamon | 0190403 | stuk | 82,00 | 009 0 |
| Douchegarnituur | | 0830240 | bevestigingsset voor fontein M8x90mm | | 0830240 | stuk | 0,85 | 362 0 |
| | sifonkap voor fontein m. bevestigingsset | | | | | | | |
| Accessoires en spiegels | | 0190411 | | wit | 0190411 | stuk | 106,00 | 009 0 |
| | | 0190438 | | pergamon | 0190438 | stuk | 126,00 | 009 0 |
| Douchewanden | wandclosetpot diepspoel | | | | | | | |
| | | 0190349 | | wit | 0190349 | stuk | 162,00 | 009 0 |
| | | 0190357 | | pergamon | 0190357 | stuk | 194,00 | 009 0 |
| Toebehoren & afvoeren | closetzitting dubbel | | | | | | | |
| | | 0753025 | | wit | 0753025 | stuk | 46,50 | 009 0 |
| | 0753126 | | pergamon | 0753126 | stuk | 53,50 | 009 0 | |
| Spoel- & installatiesystemen | | | | | | | | |
| Badkamermeubelen en toiletkasten | | | | | | | | |
| Gootstenen en wastroggen | | | | | | | | |
| Utiliteit | | | | | | | | |



Complete lijn
accessoires en
kranen

Wandcloset en
duoblok

Fontein
Designsifon

Wastafel met zuil
of sifonkap

| | Art.nr | Specificaties | Kleur | Lev.nr | Ehd | Prijs | Grp | CC |
|---|--------------------------------------|--------------------------------------|------------------------------------|----------|---------|--------|--------|-------|
| Sanitair producten | Plieger Spring | | | | | | | |
| | wastafel | | | | | | | |
| | | 0190004 | 55x45cm | wit | 0190004 | stuk | 66,00 | 009 0 |
| | | 0190012 | 55x45cm | pergamon | 0190012 | stuk | 83,00 | 009 0 |
| | | 0190020 | 60x49cm | wit | 0190020 | stuk | 70,50 | 009 0 |
| Baden / douchebakken / stoomcabines | | 0190039 | 60x49cm | pergamon | 0190039 | stuk | 88,00 | 009 0 |
| | | 0830097 | bevestigingsset M10x110mm | | 0830097 | paar | 1,09 | 362 0 |
| Kranen | sifonkap voor wastafel | | | | | | | |
| | | 0190128 | | wit | 0190128 | stuk | 58,00 | 009 0 |
| | | 0190136 | | pergamon | 0190136 | stuk | 72,50 | 009 0 |
| | | 0830453 | set potschroeven 5.5x60mm chroom | | 0830453 | stuk | 2,28 | 362 0 |
| Douchegarnituur | zuil voor wastafel | | | | | | | |
| | | 0190098 | | wit | 0190098 | stuk | 58,00 | 009 0 |
| | 0190101 | | pergamon | 0190101 | stuk | 72,50 | 009 0 | |
| Accessoires en spiegels | planchet | | | | | | | |
| | | 0260517 | 50cm | wit | 0260517 | stuk | 14,75 | 004 0 |
| | | 0260525 | 50cm | pergamon | 0260525 | stuk | 22,75 | 004 0 |
| | | 0260584 | 60cm | wit | 0260584 | stuk | 14,75 | 004 0 |
| | | 0260347 | 60cm | pergamon | 0260347 | stuk | 22,75 | 004 0 |
| Douchewanden | | 0830143 | set potschroeven 5.5x60mm pergamon | | 0830143 | stuk | 1,10 | 362 0 |
| | | 0830453 | set potschroeven 5.5x60mm chroom | | 0830453 | stuk | 2,28 | 362 0 |
| Toebehoren & afvoeren | fontein | | | | | | | |
| | | 0190047 | 40x23cm | wit | 0190047 | stuk | 37,25 | 009 0 |
| | | 0190055 | 40x23cm | pergamon | 0190055 | stuk | 46,25 | 009 0 |
| | 0830240 | bevestigingsset voor fontein M8x90mm | | 0830240 | stuk | 0,85 | 362 0 | |
| Spoel- & installatiesystemen | wandclosetpot diepspoel | | | | | | | |
| | | 0190187 | | wit | 0190187 | stuk | 114,00 | 009 0 |
| | 0190195 | | pergamon | 0190195 | stuk | 142,00 | 009 0 | |
| Badkamermeubelen en toiletkasten | closetcombinatie diepspoel AO | | | | | | | |
| | | 0190144 | | wit | 0190144 | stuk | 244,00 | 009 0 |
| | | 0190152 | | pergamon | 0190152 | stuk | 305,00 | 009 0 |
| Gootstenen en wastroggen | | 0830453 | set potschroeven 5.5x60mm chroom | | 0830453 | stuk | 2,28 | 362 0 |
| | closetcombinatie diepspoel PK | | | | | | | |
| Utiliteit | | 0190160 | | wit | 0190160 | stuk | 244,00 | 009 0 |
| | | 0190179 | | pergamon | 0190179 | stuk | 289,00 | 009 0 |
| | | 0830453 | set potschroeven 5.5x60mm chroom | | 0830453 | stuk | 2,28 | 362 0 |
| closetzitting dubbel | | | | | | | | |
| | 0752177 | | wit | 0752177 | stuk | 46,25 | 009 0 | |
| | 0752185 | | pergamon | 0752185 | stuk | 46,25 | 009 0 | |
| duoblokpot diepspoel AO z. reservoir | | | | | | | | |
| | 0190225 | | wit | 0190225 | stuk | 133,00 | 009 0 | |
| | 0190233 | | pergamon | 0190233 | stuk | 166,00 | 009 0 | |
| duoblokpot diepspoel PK z. reservoir | | | | | | | | |
| | 0190241 | | wit | 0190241 | stuk | 133,00 | 009 0 | |
| | 0190268 | | pergamon | 0190268 | stuk | 150,00 | 009 0 | |

| Art.nr | Specificaties | Kleur | Lev.nr | Ehd | Prijs | Grp | CC |
|--------|---------------|-------|--------|-----|-------|-----|----|
|--------|---------------|-------|--------|-----|-------|-----|----|

Plieger Spring

duoblokreservoir + binnenwerk

| | | | | | | | |
|---------|--|----------|---------|------|--------|-----|---|
| 0190209 | | wit | 0190209 | stuk | 111,00 | 009 | 0 |
| 0190217 | | pergamon | 0190217 | stuk | 139,00 | 009 | 0 |



Sanitair producten

Baden /
douchebakken /
stoomcabines

deksel voor reservoir

| | | | | | | | |
|---------|--|----------|---------|------|-------|-----|---|
| 0190284 | | wit | 0190284 | stuk | 28,00 | 009 | 0 |
| 0190292 | | pergamon | 0190292 | stuk | 35,00 | 009 | 1 |

Kranen

Plieger Winston

wastafel m. keramische poten m. 3 kraangaten

| | | | | | | | |
|---------|---------------------------|-----|---------|------|--------|-----|---|
| 0190276 | 108,5x60cm | wit | 0190276 | stuk | 595,00 | 004 | 1 |
| 0830097 | bevestigingsset M10x110mm | | 0830097 | paar | 1,09 | 362 | 0 |



Douchegarnituur

vormspiegel m. facetrand Winston-New

| | | | | | | | |
|---------|---------|--|---------|------|--------|-----|---|
| 0803596 | 75x50cm | | 0803596 | stuk | 114,00 | 238 | 0 |
| 0803618 | 95x70cm | | 0803618 | stuk | 170,00 | 238 | 0 |

Accessoires en
spiegels

Douchewanden

Toebehoren &
afvoeren

spotset boog m. melkglas

| | | | | | | | |
|---------|--|--|---------|------|--------|-----|---|
| 0803669 | | | 0803669 | stuk | 105,00 | 238 | 0 |
|---------|--|--|---------|------|--------|-----|---|

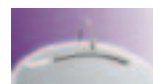
Spoel- &
installatiesystemen

Plieger verhoogde closetpotten

closetpot verhoogd vlakspoel

| | | | | | | | |
|---------|-----------|-----|---------|------|--------|-----|---|
| 0260058 | (+6cm) ao | wit | 0260058 | stuk | 134,00 | 004 | 0 |
| 0260060 | (+6cm) pk | wit | 0260060 | stuk | 121,00 | 004 | 0 |

Badkamermeubelen
en toiletkastenGootstenen en
wastroggen

closetcombinatie verhoogd

| | | | | | | | |
|---------|-----------|-----|---------|------|--------|-----|---|
| 0276010 | (+6cm) AO | wit | 0276010 | stuk | 188,00 | 003 | 0 |
| 0276025 | (+6cm) PK | wit | 0276025 | stuk | 188,00 | 003 | 0 |





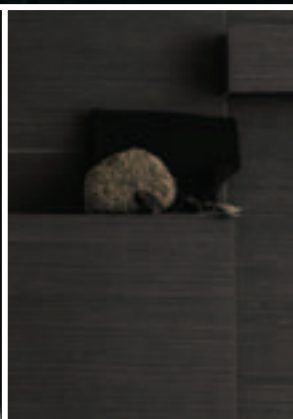
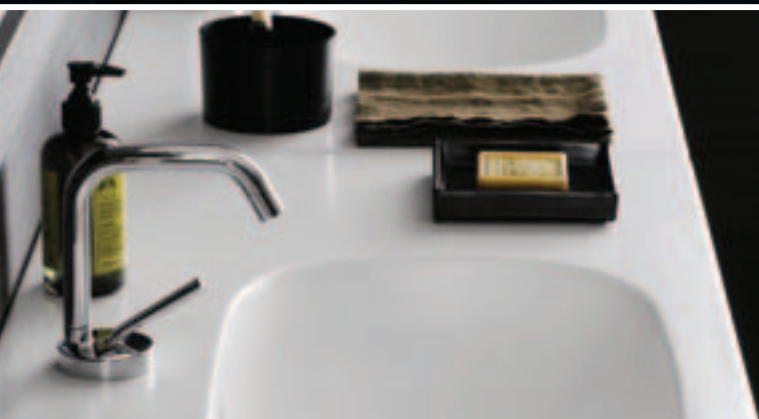



Utiliteit

| | Art.nr | Specificaties | Kleur | Lev.nr | Ehd | Prijs | Grp | CC |
|---|-------------------|---|-------|-------------|------|--------|-----|----|
| Sanitair producten | Sphinx 280 | | | | | | | |
| | | wastafel m. overloop | | | | | | |
| | 0222465 | 60x48cm | wit | S8303500000 | stuk | 72,00 | 044 | 0 |
| | 0830097 | bevestigingsset M10x110mm | | 0830097 | paar | 1,09 | 362 | 0 |
| Baden / douchebakken / stoomcabines | | sifonkap voor wastafel | | | | | | |
| | 0222469 | | wit | S8S01100000 | stuk | 58,50 | 044 | 0 |
| | 0830410 | set potschroeven 5.5x60mm wit | | 0830410 | stuk | 0,84 | 362 | 0 |
| Kranen | | fontein m. overloop | | | | | | |
| | 0222466 | 36x28cm | wit | S8401200000 | stuk | 42,75 | 044 | 0 |
| | 0830240 | bevestigingsset voor fontein M8x90mm | | 0830240 | stuk | 0,85 | 362 | 0 |
| Douchegarnituur | | duoblokpot diepspoel AO z. reservoir | | | | | | |
| | 0222462 | | wit | S8102000000 | stuk | 159,00 | 044 | 0 |
| Accessoires en spiegels | | 0830410 set potschroeven 5.5x60mm wit | | 0830410 | stuk | 0,84 | 362 | 0 |
| Douchewanden | | duoblokpot diepspoel PK z. reservoir | | | | | | |
| | 0222463 | | wit | S8102100000 | stuk | 153,00 | 044 | 0 |
| Toebehoren & afvoeren | | 0830410 set potschroeven 5.5x60mm wit | | 0830410 | stuk | 0,84 | 362 | 0 |
| Spoel- & installatiesystemen | | duoblokreservoir dualflush m. binnenwerk | | | | | | |
| | 0222467 | | wit | S8501199000 | stuk | 99,00 | 044 | 0 |
| Badkamermeubelen en toiletkasten | | wandclosetpot diepspoel | | | | | | |
| | 0222464 | | wit | S8201300000 | stuk | 144,00 | 044 | 0 |
| Gootstenen en wastroggen | | closetzitting dubbel | | | | | | |
| | 0222468 | | wit | S8H50700000 | stuk | 35,00 | 044 | 0 |
| Utiliteit | | | | | | | | |



Oase van comfort | De badkamerlijn Sphinx 330 heeft een uitgesproken karakter met een krachtige visuele impact. Zachte, licht welvende vormen met een exclusief ontwerp geven de badkamer een oase van welzijn en comfort. Ontdek de grenzeloze mogelijkheden met een niet aflatende aandacht voor functionaliteit en welzijn.

 **Sphinx**
Beleef water

| | Art.nr | Specificaties | Kleur | Lev.nr | Ehd | Prijs | Grp | CC | |
|---|---|---------------------------|--------------------------------------|---------|-------------|-------|--------|-------|--|
| Sanitair producten | Sphinx 330 | | | | | | | | |
| | wastafel | | | | | | | | |
| |  | 0082512 | 55x45.8cm | wit | S8303700000 | stuk | 115,00 | 044 1 | |
| | | 0082513 | 60x50cm | wit | S8303800000 | stuk | 127,00 | 044 1 | |
| | | 0082514 | 65x50cm | wit | S8303900000 | stuk | 143,00 | 044 1 | |
| | 0830097 | bevestigingsset M10x110mm | | 0830097 | paar | 1,09 | 362 0 | | |
| Baden / douchebakken / stoomcabines | wastafel bak links | | | | | | | | |
| | | 0082515 | 65x40cm | wit | S8304100000 | stuk | 173,00 | 044 0 | |
| | | 0082517 | 80x50cm | wit | S8304400000 | stuk | 228,00 | 044 1 | |
| Kranen |  | 0830097 | bevestigingsset M10x110mm | | 0830097 | paar | 1,09 | 362 0 | |
| | wastafel bak rechts | | | | | | | | |
| Douchegarnituur | | 0082516 | 65x40cm | wit | S8304200000 | stuk | 173,00 | 044 0 | |
| | | 0082518 | 80x50cm | wit | S8304500000 | stuk | 228,00 | 044 1 | |
| | | 0830097 | bevestigingsset M10x110mm | | 0830097 | paar | 1,09 | 362 0 | |
| Accessoires en spiegels |  | | | | | | | | |
| | zuil | | | | | | | | |
| Douchewanden |  | 0082519 | | wit | S8700500000 | stuk | 113,00 | 044 1 | |
| | fontein | | | | | | | | |
| Toebehoren & afvoeren | | 0082520 | 40x29cm | wit | S8401400000 | stuk | 80,50 | 044 1 | |
| | | 0830240 | bevestigingsset voor fontein M8x90mm | | 0830240 | stuk | 0,85 | 362 0 | |
| Badkamermeubelen en toiletkasten |  | | | | | | | | |
| | wandbidet | | | | | | | | |
| Gootstenen en wastroggen | | 0082524 | | wit | S8901200000 | stuk | 228,00 | 044 1 | |
| |  | | | | | | | | |
| Utiliteit | duoblokpot diepspoel PK universeel | | | | | | | | |
| |  | 0082522 | z. reservoir | wit | S8102400000 | stuk | 202,00 | 044 1 | |
| | duoblokreservoir dualflush m. binnenwerk | | | | | | | | |
| | | 0082521 | | wit | S8501399000 | stuk | 194,00 | 044 1 | |
| wandclosetpot diepspoel | | | | | | | | | |
| |  | 0082523 | | wit | S8201500000 | stuk | 196,00 | 044 0 | |

| Art.nr | Specificaties | Kleur | Lev.nr | Ehd | Prijs | Grp | CC |
|--------|---------------|-------|--------|-----|-------|-----|----|
|--------|---------------|-------|--------|-----|-------|-----|----|

Sphinx 330

closetzitting dubbel

| | | | | | | | |
|---------|---------------------|-----|-------------|------|--------|-----|---|
| 0082525 | v. closetcombinatie | wit | S8H51200000 | stuk | 115,00 | 044 | 1 |
| 0082526 | v. wandcloset | wit | S8H51300000 | stuk | 86,50 | 044 | 0 |



Sanitair producten

Baden /
douchebakken /
stoomcabines

hoge kast

| | | | | | | | | |
|---------|-------------|--------------------|-----|-----------|------|--------|-----|---|
| 0082528 | 30x18x150cm | ondiep m. deur l/r | wit | S8M272000 | stuk | 493,00 | 044 | 1 |
| 0082529 | 30x30x150cm | m. deur l/r | wit | S8M272500 | stuk | 557,00 | 044 | 1 |



Kranen

Douchegarnituur

horizontale kast

| | | | | | | | | |
|---------|------------|--|-----|-----------|------|--------|-----|---|
| 0082527 | 90x18x30cm | | wit | S8M271000 | stuk | 407,00 | 044 | 1 |
|---------|------------|--|-----|-----------|------|--------|-----|---|

Accessoires en
spiegels

Douchewanden

Sphinx 340

wastafel

| | | | | | | | | |
|---------|---------------------------|-------------|----------|-------------|------|--------|-----|---|
| 0222100 | 60x50cm | | wit | S8316000000 | stuk | 139,00 | 042 | 0 |
| 0222119 | 60x50cm | | pergamon | S8316000030 | stuk | 174,00 | 042 | 0 |
| 0200134 | 60x50cm | m. Ceratect | wit | S8316000001 | stuk | 220,00 | 042 | 1 |
| 0200135 | 60x50cm | m. Ceratect | pergamon | S8316000031 | stuk | 255,00 | 042 | 1 |
| 0222151 | 65x53cm | | wit | S8315000000 | stuk | 164,00 | 042 | 0 |
| 0222178 | 65x53cm | | pergamon | S8315000030 | stuk | 205,00 | 042 | 1 |
| 0200132 | 65x53cm | m. CeraTect | wit | S8315000001 | stuk | 245,00 | 042 | 1 |
| 0200133 | 65x53cm | m. CeraTect | pergamon | S8315000031 | stuk | 286,00 | 042 | 1 |
| 0830097 | bevestigingsset M10x110mm | | | 0830097 | paar | 1,09 | 362 | 0 |

Toebehoren &
afvoerenSpoel- &
installatiesystemen

wastafel compact

| | | | | | | | | |
|---------|---------------------------|-------------|----------|-------------|------|--------|-----|---|
| 0222054 | 60x43cm | | wit | S8317000000 | stuk | 139,00 | 042 | 0 |
| 0222062 | 60x43cm | | pergamon | S8317000030 | stuk | 174,00 | 042 | 1 |
| 0200136 | 60x43cm | m. Ceratect | wit | S8317000001 | stuk | 220,00 | 042 | 1 |
| 0200137 | 60x43cm | m. Ceratect | pergamon | S8317000031 | stuk | 255,00 | 042 | 1 |
| 0830097 | bevestigingsset M10x110mm | | | 0830097 | paar | 1,09 | 362 | 0 |

Badkamermeubelen
en toiletkastenGootstenen en
wastroggen

meubelwastafel

| | | | | | | | | |
|---------|---------------------------|-------------|----------|-------------|------|--------|-----|---|
| 0222216 | 80x50cm | | wit | S8W22000000 | stuk | 381,00 | 042 | 0 |
| 0222224 | 80x50cm | | pergamon | S8W22000030 | stuk | 477,00 | 042 | 1 |
| 0200148 | 80x50cm | m. Ceratect | wit | S8W22000001 | stuk | 462,00 | 042 | 1 |
| 0200149 | 80x50cm | m. Ceratect | pergamon | S8W22000031 | stuk | 557,00 | 042 | 1 |
| 0222267 | 90x50cm | | wit | S8W21000000 | stuk | 390,00 | 042 | 1 |
| 0222275 | 90x50cm | | pergamon | S8W21000030 | stuk | 488,00 | 042 | 1 |
| 0830097 | bevestigingsset M10x110mm | | | 0830097 | paar | 1,09 | 362 | 0 |



Utiliteit

sifonkap voor wastafel

| | | | | | | | | |
|---------|--|--|----------|-------------|------|--------|-----|---|
| 0222372 | | | wit | S8S65000000 | stuk | 108,00 | 042 | 0 |
| 0222380 | | | pergamon | S8S65000030 | stuk | 135,00 | 042 | 0 |

zuil voor wastafel







| | | | | | | | | |
|---------|--|--|----------|-------------|------|--------|-----|---|
| 0222313 | | | wit | S8718000000 | stuk | 119,00 | 042 | 1 |
| 0222321 | | | pergamon | S8718000030 | stuk | 149,00 | 042 | 1 |



planchet

| | | | | | | | | |
|---------|---------------------------|-------|----------|-------------|------|-------|-----|---|
| 0222704 | 60x16cm | | wit | S8821000000 | stuk | 52,00 | 042 | 0 |
| 0222712 | 60x16cm | | pergamon | S8821000030 | stuk | 65,00 | 042 | 1 |
| 0830453 | set potschroeven 5.5x60mm | chrom | | 0830453 | stuk | 2,28 | 362 | 0 |



| Art.nr | Specificaties | Kleur | Lev.nr | Ehd | Prijs | Grp | CC |
|---|--|----------|--------------|------|--------|-----|----|
| Sphinx 340 | | | | | | | |
| fontein | | | | | | | |
|  | 0222542 40x32.5cm | wit | S8422000000 | stuk | 70,00 | 042 | 0 |
| | 0222550 40x32.5cm | pergamon | S8422000030 | stuk | 88,00 | 042 | 0 |
| | 0200140 40x32.5cm m. Ceratect | wit | S8422000001 | stuk | 140,00 | 042 | 1 |
| | 0200141 40x32.5cm m. Ceratect | pergamon | S8422000031 | stuk | 158,00 | 042 | 1 |
| | 0222593 45x37cm | wit | S8421000000 | stuk | 75,00 | 042 | 1 |
| | 0222607 45x37cm | pergamon | S8421000030 | stuk | 94,00 | 042 | 1 |
| | 0200138 45x37cm m. Ceratect | wit | S8421000001 | stuk | 145,00 | 042 | 1 |
| | 0200139 45x37cm m. Ceratect | pergamon | S8421000031 | stuk | 164,00 | 042 | 1 |
| | 0830240 bevestigingsset voor fontein M8x90mm | | 0830240 | stuk | 0,85 | 362 | 0 |
| fontein compact | | | | | | | |
|  | 0222429 40x28cm | wit | S8423000000 | stuk | 70,00 | 042 | 0 |
| | 0222437 40x28cm | pergamon | S8423000030 | stuk | 88,00 | 042 | 0 |
| | 0200142 40x28cm m. Ceratect | wit | S8423000001 | stuk | 140,00 | 042 | 1 |
| | 0830240 bevestigingsset voor fontein M8x90mm | | 0830240 | stuk | 0,85 | 362 | 0 |
| hoekfontein | | | | | | | |
|  | 0226734 40x33cm | wit | S8477000000 | stuk | 101,00 | 042 | 0 |
| | 0226742 40x33cm | pergamon | S8477000030 | stuk | 125,00 | 042 | 0 |
| | 0200150 40x33cm m. Ceratect | wit | S8477000001 | stuk | 170,00 | 042 | 1 |
| | 0200151 40x33cm m. Ceratect | pergamon | S8477000031 | stuk | 195,00 | 042 | 1 |
| | 0830240 bevestigingsset voor fontein M8x90mm | | 0830240 | stuk | 0,85 | 362 | 0 |
| sifonkap voor fontein | | | | | | | |
|  | 0222658 | wit | S8S67000000 | stuk | 93,00 | 042 | 1 |
| | 0222666 | pergamon | S8S670000030 | stuk | 116,00 | 042 | 1 |
| sifonkap voor fontein compact | | | | | | | |
| | 0222488 | wit | S8S77000000 | stuk | 88,00 | 042 | 0 |
| | 0222496 | pergamon | S8S770000030 | stuk | 109,00 | 042 | 0 |
| staand bidet | | | | | | | |
|  | 0222755 | wit | S8930000000 | stuk | 198,00 | 042 | 1 |
| | 0222763 | pergamon | S89300000030 | stuk | 247,00 | 042 | 1 |
| | 0200144 m. Ceratect | wit | S89300000001 | stuk | 279,00 | 042 | 1 |
| | 0200145 m. Ceratect | pergamon | S89300000031 | stuk | 328,00 | 042 | 1 |
| wandbidet | | | | | | | |
|  | 0222828 | wit | S8940000000 | stuk | 308,00 | 042 | 1 |
| | 0222836 | pergamon | S89400000030 | stuk | 385,00 | 042 | 1 |
| | 0200146 m. Ceratect | wit | S89400000001 | stuk | 389,00 | 042 | 1 |
| | 0200147 m. Ceratect | pergamon | S89400000031 | stuk | 466,00 | 042 | 1 |
| wandclosetpot-34 diepspoel | | | | | | | |
| | 0200697 | wit | S8204010000 | stuk | 215,00 | 043 | 0 |
| | 0211028 | pergamon | S8204010030 | stuk | 268,00 | 043 | 0 |
| | 0200193 m. Ceratect | wit | S8204010001 | stuk | 296,00 | 043 | 1 |
| | 0200194 m. Ceratect | pergamon | S8204010031 | stuk | 349,00 | 043 | 1 |
| duoblokpot-41 A0 | | | | | | | |
|  | 0222769 | wit | S8184000000 | stuk | 199,00 | 042 | 0 |
| | 0222772 | pergamon | S81840000030 | stuk | 256,00 | 042 | 0 |
| | 0222770 m. Ceratect | wit | S81840000001 | stuk | 279,00 | 042 | 0 |
| | 0222773 m. Ceratect | pergamon | S81840000031 | stuk | 336,00 | 042 | 0 |
| duoblokpot-41 PK | | | | | | | |
| | 0222774 | wit | S8185000000 | stuk | 183,00 | 042 | 0 |
| | 0222776 | pergamon | S81850000030 | stuk | 236,00 | 042 | 0 |
| | 0222775 m. Ceratect | wit | S81850000001 | stuk | 263,00 | 042 | 0 |
| | 0222777 m. Ceratect | pergamon | S81850000031 | stuk | 316,00 | 042 | 0 |

| Art.nr | Specificaties | Kleur | Lev.nr | Ehd | Prijs | Grp | CC |
|---|----------------------------------|-------------|----------------------------|------|--------|-----|----|
| Sphinx 340 | | | | | | | |
| duoblokpot-41 PK Uni | | | | | | | |
| 0222765 | | wit | S8176000000 | stuk | 199,00 | 042 | 0 |
| 0222767 | | pergamon | S8176000030 | stuk | 256,00 | 042 | 0 |
| 0222766 | m. Ceratect | wit | S8176000001 | stuk | 279,00 | 042 | 0 |
| 0222768 | m. Ceratect | pergamon | S8176000031 | stuk | 336,00 | 042 | 0 |
| closetcombinatie-41 AO | | | | | | | |
| 0222807 | | wit | KLOSETKOMB.-41 AO WIT | stuk | 0,00 | 042 | |
| 0 | | | | | | | |
| 0222809 | | pergamon | KLOSETKOMB.-41 AO PERGAMON | stuk | 0,00 | 042 | |
| 0 | | | | | | | |
| 0222808 | m. Ceratect | wit | KLOSETKOMB.-41 AO WIT+ | stuk | 0,00 | 042 | |
| 0 | | | | | | | |
| 0222810 | m. Ceratect | pergamon | KLOSETKOMB.-41 AO PERGAMON | stuk | 0,00 | 042 | |
| 0 | | | | | | | |
| 0830453 | set potschroeven 5.5x60mm chroom | | 0830453 | stuk | 2,28 | 362 | 0 |
| closetcombinatie-41 PK | | | | | | | |
| 0222811 | | wit | KLOSETKOMB.-41 PK WIT | stuk | 0,00 | 042 | |
| 0 | | | | | | | |
| 0222813 | | pergamon | KLOSETKOMB.-41 PK PERGAMON | stuk | 0,00 | 042 | |
| 0 | | | | | | | |
| 0222812 | m. Ceratect | wit | KLOSETKOMB.-41 PK WIT+ | stuk | 0,00 | 042 | |
| 0 | | | | | | | |
| 0222814 | m. Ceratect | pergamon | KLOSETKOMB.-41 PK PERGAMON | stuk | 0,00 | 042 | |
| 0 | | | | | | | |
| 0830453 | set potschroeven 5.5x60mm chroom | | 0830453 | stuk | 2,28 | 362 | 0 |
| closetcombinatie-41 PK Uni | | | | | | | |
| 0222803 | | wit | KLOSETKOMB.-41 PK-UNI. WI | stuk | 0,00 | 042 | |
| 0 | | | | | | | |
| 0222805 | | pergamon | KLOSETKOMB.-41 PK-UNI. PE | stuk | 0,00 | 042 | |
| 0 | | | | | | | |
| 0222804 | m. Ceratect | wit | KLOSETKOMB.-41 PK-UNI. WI | stuk | 0,00 | 042 | |
| 0 | | | | | | | |
| 0222806 | m. Ceratect | pergamon | KLOSETKOMB.-41 PK-UNI. PE | stuk | 0,00 | 042 | |
| 0 | | | | | | | |
| 0830453 | set potschroeven 5.5x60mm chroom | | 0830453 | stuk | 2,28 | 362 | 0 |
| reservoir + binnenwerk | | | | | | | |
| 0226612 | | wit | S8550990000 | stuk | 206,00 | 042 | 1 |
| 0226616 | | pergamon | S8550990030 | stuk | 250,00 | 042 | 1 |
| closetzitting dubbel | | | | | | | |
| 0222502 | | wit | S8H5N011000 | stuk | 120,00 | 042 | 0 |
| 0222503 | | pergamon | S8H5N011030 | stuk | 120,00 | 042 | 0 |
| 0222504 | m. softclose | wit | S8H5N0S1000 | stuk | 162,00 | 042 | 0 |
| 0222505 | m. softclose | pergamon | S8H5N0S1030 | stuk | 162,00 | 042 | 0 |
| Sphinx 360 | | | | | | | |
| wandurinoir achterinlaat voor deksel | | | | | | | |
| 0220087 | | wit | S8637000000 | stuk | 236,00 | 042 | 0 |
| deksel voor urinoir | | | | | | | |
| 0240046 | | wit | S8H5S000000 | stuk | 96,50 | 042 | 1 |
| Sphinx 380 | | | | | | | |
| wastafel m. sifon m. plug | | | | | | | |
| 0282503 | 60x49cm | wit | S8300500000 | stuk | 184,00 | 042 | 1 |
| 0282505 | 60x49cm | pergamon | S8300500030 | stuk | 230,00 | 042 | 1 |
| 0282504 | 60x49cm | m. ceratect | S8300500001 | stuk | 264,00 | 042 | 1 |
| 0282506 | 60x49cm | m. ceratect | S8300500031 | stuk | 310,00 | 042 | 1 |
| 0282507 | 70x50cm | wit | S8302600000 | stuk | 251,00 | 042 | 1 |
| 0282509 | 70x50cm | pergamon | S8302600030 | stuk | 313,00 | 042 | 1 |
| 0282508 | 70x50cm | m. ceratect | S8302600001 | stuk | 331,00 | 042 | 1 |
| 0282570 | 70x50cm | m. ceratect | S8302600031 | stuk | 394,00 | 042 | 1 |



Sanitair producten

Baden /
douchebakken /
stoomcabines

Kranen

Douchegarnituur

Accessoires en
spiegels

Douchewanden

Toebehoren &
afvoerenSpoel- &
installatiesystemenBadkamermeubelen
en toiletkastenGootstenen en
wastroggen

Utiliteit

| Art.nr | Specificaties | Kleur | Lev.nr | Ehd | Prijs | Grp | CC |
|--------|---------------|-------|--------|-----|-------|-----|----|
|--------|---------------|-------|--------|-----|-------|-----|----|

Sphinx 380

meubelwastafel m. sifon m. plug

| | | | | | | | |
|---------|---------------------|----------|-------------|------|--------|-----|---|
| 0282511 | 80x50cm | wit | S8W00100000 | stuk | 440,00 | 042 | 1 |
| 0282513 | 80x50cm | pergamon | S8W00100030 | stuk | 550,00 | 042 | 1 |
| 0282512 | 80x50cm m. ceratect | wit | S8W00100001 | stuk | 520,00 | 042 | 1 |
| 0282514 | 80x50cm m. ceratect | pergamon | S8W00100031 | stuk | 630,00 | 042 | 1 |



Sanitair producten

Baden /
douchebakken /
stoomcabines

sifonkap voor wastafel

| | | | | | | | |
|---------|--|----------|-------------|------|--------|-----|---|
| 0282519 | | wit | S8S00300000 | stuk | 151,00 | 042 | 1 |
| 0282520 | | pergamon | S8S00300030 | stuk | 188,00 | 042 | 1 |



Kranen

Douchegarnituur

hoekwastafel m. sifon m. plug

| | | | | | | | |
|---------|---------------------|----------|-------------|------|--------|-----|---|
| 0282515 | 53x53cm | wit | S8302700000 | stuk | 279,00 | 042 | 1 |
| 0282516 | 53x53cm | pergamon | S8302700030 | stuk | 348,00 | 042 | 1 |
| 0282517 | 53x53cm m. ceratect | wit | S8302700001 | stuk | 359,00 | 042 | 1 |
| 0282518 | 53x53cm m. ceratect | pergamon | S8302700031 | stuk | 428,00 | 042 | 1 |



Accessoires en
spiegels

Douchewanden

fontein

| | | | | | | | |
|---------|---------------------|----------|-------------|------|--------|-----|---|
| 0282523 | 40x30cm | wit | S8400400000 | stuk | 91,50 | 042 | 1 |
| 0282524 | 40x30cm | pergamon | S8400400001 | stuk | 161,00 | 042 | 1 |
| 0282525 | 40x30cm m. ceratect | wit | S8400400030 | stuk | 115,00 | 042 | 1 |
| 0282526 | 40x30cm m. ceratect | pergamon | S8400400031 | stuk | 184,00 | 042 | 1 |



Toebehoren &
afvoeren

sifonkap voor fontein

| | | | | | | | |
|---------|--|----------|-------------|------|--------|-----|---|
| 0282527 | | wit | S8S00200000 | stuk | 117,00 | 042 | 1 |
| 0282528 | | pergamon | S8S00200030 | stuk | 147,00 | 042 | 1 |

wandbidet

| | | | | | | | |
|---------|---------------------|----------|-------------|------|--------|-----|---|
| 0282539 | 35x55cm | wit | S8900500000 | stuk | 362,00 | 042 | 1 |
| 0282540 | 35x55cm | pergamon | S8900500030 | stuk | 453,00 | 042 | 1 |
| 0282541 | 35x55cm m. ceratect | wit | S8900500001 | stuk | 442,00 | 042 | 1 |
| 0282542 | 35x55cm m. ceratect | pergamon | S8900500031 | stuk | 533,00 | 042 | 1 |



Badkamermeubelen
en toiletkasten

Gootstenen en
wastroggen

wandcloset 6-liter

| | | | | | | | |
|---------|-------------|----------|-------------|------|--------|-----|---|
| 0282535 | | wit | S8200700000 | stuk | 256,00 | 042 | 1 |
| 0282536 | | pergamon | S8200700030 | stuk | 320,00 | 042 | 1 |
| 0282568 | m. ceratect | wit | S8200700001 | stuk | 337,00 | 042 | 1 |
| 0282538 | m. ceratect | pergamon | S8200700031 | stuk | 401,00 | 042 | 1 |



Utiliteit

duoblokpot universeel z. reservoir

| | | | | | | | |
|---------|-------------|----------|-------------|------|--------|-----|---|
| 0282569 | | wit | S8101600000 | stuk | 307,00 | 042 | 1 |
| 0282530 | | pergamon | S8101600030 | stuk | 383,00 | 042 | 1 |
| 0282531 | m. ceratect | wit | S8101600001 | stuk | 387,00 | 042 | 1 |
| 0282532 | m. ceratect | pergamon | S8101600031 | stuk | 463,00 | 042 | 1 |









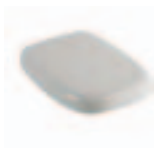

duoblokreervoir compleet

| | | | | | | | |
|---------|--|----------|-------------|------|--------|-----|---|
| 0282533 | | wit | S8500299000 | stuk | 212,00 | 042 | 1 |
| 0282534 | | pergamon | S8500299030 | stuk | 265,00 | 042 | 1 |





closetzitting m. softclose

| | | | | | | | |
|---------|--|----------|-------------|------|--------|-----|---|
| 0282543 | | wit | S8H50508000 | stuk | 173,00 | 042 | 1 |
| 0282544 | | pergamon | S8H50508030 | stuk | 173,00 | 042 | 1 |



| Art.nr | Specificaties | Kleur | Lev.nr | Ehd | Prijs | Grp | CC | | |
|---|-----------------|-------------|-------------|-----------|--------|--------|-----|---|---|
| Sphinx 380 | | | | | | | | | |
| wastafelblad m. lade 0282558 | 90x45x7.5cm | licht eiken | S8M5225KS | stuk | 501,00 | 323 | 1 |  | |
| halfhoge toiletkast 0282557 | 22.5x22.5x90cm | licht eiken | S8M5220KS | stuk | 446,00 | 323 | 1 |  | |
| hoge kast m. deur m. verlichting 0282566 | 37.5x37.5x150cm | | licht eiken | S8M5200KS | stuk | 835,00 | 323 | 1 |  |
| lage kast m. lade 0282554 | 60x37.5x30cm | licht eiken | S8M5205KS | stuk | 501,00 | 323 | 1 |  | |
| wastafelonderbouw voor hoekwastafel 0282555 | 70x55x52.5cm | licht eiken | S8M5210KS | stuk | 613,00 | 323 | 1 |  | |
| wastafelonderbouw voor wastafel 70-80cm 0282556 | 75x45x60cm | licht eiken | S8M5215KS | stuk | 557,00 | 323 | 1 | | |
| opbergrek 0282559 | 90x37.5x7.5cm | licht eiken | S8M5230KS | stuk | 557,00 | 323 | 1 |  | |
| set poten voor meubel 0282563 | | | S8H940000 | stuk | 89,00 | 323 | 1 | | |
| spiegel verticaal m. 2 lampen 0282560 | 37.5x4x75cm | licht eiken | S8M5240KS | stuk | 529,00 | 323 | 1 |  | |
| spiegel verticaal m. 1 lamp boven 0282565 | 37.5x4x75cm | licht eiken | S8M5245KS | stuk | 390,00 | 323 | 1 |  | |

- Sanitair producten
- Baden /
douchebakken /
stoomcabines
- Kranen
- Douchegarnituur
- Accessoires en
spiegels
- Douchewanden
- Toebehoren &
afvoeren
- Spoel- &
installatiesystemen
- Badkamermeubelen
en toiletkasten
- Gootstenen en
wastroggen
- Utiliteit

| | Art.nr | Specificaties | Kleur | Lev.nr | Ehd | Prijs | Grp | CC |
|---|---|---|-------------|-------------|--------|--------|-----|----|
| Sanitair producten | Sphinx 380 | | | | | | | |
| | | spiegel horizontaal m. 2 lampen 0282562 37.5x4x75cm | licht eiken | S8M5250KS | stuk | 529,00 | 323 | 1 |
| Baden / douchebakken / stoomcabines |  | | | | | | | |
| Kranen | bevestigingsset spiegel voor hoekmontage 0282564 | | | | | | | |
| | | | | S8H950000 | stuk | 157,00 | 323 | 1 |
| Douchegarnituur | Sphinx 390 | | | | | | | |
| | | wastafel 0236615 60x50cm | wit | S8301000000 | stuk | 187,00 | 042 | 0 |
| | | 0236617 60x50cm m. Ceratect | wit | S8301000001 | stuk | 267,00 | 042 | 1 |
| | | 0236618 68x51.5cm | wit | S8302000000 | stuk | 264,00 | 042 | 1 |
| | | 0236619 68x51.5cm m. Ceratect | wit | S8302000001 | stuk | 344,00 | 042 | 1 |
| Accessoires en spiegels | | 0830097 bevestigingsset M10x110mm | | 0830097 | paar | 1,09 | 362 | 0 |
| | Douchewanden | wastafel rechts 0236622 80x50cm | wit | S8303000000 | stuk | 473,00 | 042 | 1 |
| 0236623 80x50cm m. Ceratect | | wit | S8303000001 | stuk | 554,00 | 042 | 1 | |
| 0830097 bevestigingsset M10x110mm | | | 0830097 | paar | 1,09 | 362 | 0 | |
| Toebehoren & afvoeren | wastafel links 0236620 80x50cm | wit | S8304000000 | stuk | 473,00 | 042 | 1 | |
| | 0236621 80x50cm m. Ceratect | wit | S8304000001 | stuk | 554,00 | 042 | 1 | |
| | 0830097 bevestigingsset M10x110mm | | 0830097 | paar | 1,09 | 362 | 0 | |
| Spoel- & installatiesystemen | wastafel 0236625 90x53cm | wit | S8305000000 | stuk | 544,00 | 042 | 1 | |
| | 0236626 90x53cm m. Ceratect | wit | S8305000001 | stuk | 625,00 | 042 | 1 | |
| | 0830097 bevestigingsset M10x110mm | | 0830097 | paar | 1,09 | 362 | 0 | |
| Badkamermeubelen en toiletkasten | fontein links 0236611 40x28cm | wit | S8460000000 | stuk | 139,00 | 042 | 0 | |
| | 0236612 40x28cm m. Ceratect | wit | S8460000001 | stuk | 208,00 | 042 | 1 | |
| | 0830240 bevestigingsset voor fontein M8x90mm | | 0830240 | stuk | 0,85 | 362 | 0 | |
| Gootstenen en wastroggen | fontein rechts 0236613 40x28cm | wit | S8461000000 | stuk | 139,00 | 042 | 0 | |
| | 0236614 40x28cm m. Ceratect | wit | S8461000001 | stuk | 208,00 | 042 | 1 | |
| Utiliteit | 0830240 bevestigingsset voor fontein M8x90mm | | 0830240 | stuk | 0,85 | 362 | 0 | |
| |  | wandbidet 0236627 | wit | S8952000000 | stuk | 388,00 | 042 | 1 |
| 0236628 m. Ceratect | | wit | S8952000001 | stuk | 468,00 | 042 | 1 | |
|  | wandclosetpot diepspoel 6 liter 0236629 | wit | S8232000000 | stuk | 325,00 | 042 | 0 | |
| | 0236630 m. Ceratect | wit | S8232000001 | stuk | 405,00 | 042 | 0 | |
|  | closetzitting dubbel 0236631 | wit | S8H54000000 | stuk | 143,00 | 042 | 0 | |

| Art.nr | Specificaties | Kleur | Lev.nr | Ehd | Prijs | Grp | CC |
|--------|---------------|-------|--------|-----|-------|-----|----|
|--------|---------------|-------|--------|-----|-------|-----|----|

Sphinx 390

horizontale kast

| | | | | | | | |
|---------|------------|-------|-----------|------|--------|-----|---|
| 0236635 | 90x18x30cm | eiken | S8M2710KO | stuk | 545,00 | 042 | 1 |
|---------|------------|-------|-----------|------|--------|-----|---|

hoge kast

| | | | | | | | |
|---------|-------------|-------|-----------|------|--------|-----|---|
| 0236634 | 30x18x150cm | eiken | S8M2720KO | stuk | 622,00 | 042 | 1 |
| 0236633 | 30x30x150cm | eiken | S8M2725KO | stuk | 712,00 | 042 | 0 |

spiegel

| | | | | | | | |
|---------|-----------|-----|-----------|------|--------|-----|---|
| 0236639 | 37x5x90cm | wit | S8M2730KO | stuk | 323,00 | 042 | 1 |
| 0236636 | 60x5x40cm | wit | S8M2740KO | stuk | 300,00 | 042 | 0 |
| 0236637 | 70x5x40cm | wit | S8M2750KO | stuk | 311,00 | 042 | 1 |

Sphinx 420

wastafel m. sifon m. plug

| | | | | | | | |
|---------|---------------------------|-----|-------------|------|--------|-----|---|
| 0200038 | 60x48cm | wit | S8348000000 | stuk | 274,00 | 042 | 0 |
| 0200039 | 60x48cm m. ceratect | wit | S8348000001 | stuk | 354,00 | 042 | 0 |
| 0830097 | bevestigingsset M10x110mm | | 0830097 | paar | 1,09 | 362 | 0 |

**wastafel m. sifon m. plug z. kraangat**

| | | | | | | | |
|---------|---------------------------|-----|-------------|------|--------|-----|---|
| 0200031 | 90x42cm | wit | S8337000000 | stuk | 654,00 | 042 | 0 |
| 0200035 | 90x42cm m. ceratect | wit | S8337000001 | stuk | 734,00 | 042 | 1 |
| 0830097 | bevestigingsset M10x110mm | | 0830097 | paar | 1,09 | 362 | 0 |

**wastafel m. sifon m. plug m. 1 kraangat**

| | | | | | | | |
|---------|---------------------------|-----|-------------|------|--------|-----|---|
| 0200032 | 90x42cm | wit | S8337010000 | stuk | 654,00 | 042 | 0 |
| 0200036 | 90x42cm m. ceratect | wit | S8337010001 | stuk | 734,00 | 042 | 1 |
| 0830097 | bevestigingsset M10x110mm | | 0830097 | paar | 1,09 | 362 | 0 |

**wastafel m. sifon m. plug m. 2 kraangaten**

| | | | | | | | |
|---------|---------------------------|-----|-------------|------|--------|-----|---|
| 0200033 | 90x42cm | wit | S8337020000 | stuk | 654,00 | 042 | 0 |
| 0200037 | 90x42cm m. ceratect | wit | S8337020001 | stuk | 734,00 | 042 | 0 |
| 0830097 | bevestigingsset M10x110mm | | 0830097 | paar | 1,09 | 362 | 0 |

**wastafel m. sifon m. plug z. kraangat**

| | | | | | | | |
|---------|---------------------------|-----|-------------|------|---------|-----|---|
| 0200024 | 120x48cm | wit | S8336000000 | stuk | 950,00 | 042 | 0 |
| 0200028 | 120x48cm m. ceratect | wit | S8336000001 | stuk | 1030,00 | 042 | 0 |
| 0830097 | bevestigingsset M10x110mm | | 0830097 | paar | 1,09 | 362 | 0 |

**wastafel m. sifon m. plug m. 1 kraangat**

| | | | | | | | |
|---------|---------------------------|-----|-------------|------|---------|-----|---|
| 0200025 | 120x48cm | wit | S8336010000 | stuk | 950,00 | 042 | 1 |
| 0200029 | 120x48cm m. ceratect | wit | S8336010001 | stuk | 1030,00 | 042 | 1 |
| 0830097 | bevestigingsset M10x110mm | | 0830097 | paar | 1,09 | 362 | 0 |

**wastafel m. sifon m. plug m. 2 kraangaten**

| | | | | | | | |
|---------|---------------------------|-----|-------------|------|---------|-----|---|
| 0200027 | 120x48cm | wit | S8336020000 | stuk | 950,00 | 042 | 0 |
| 0200030 | 120x48cm m. ceratect | wit | S8336020001 | stuk | 1030,00 | 042 | 0 |
| 0830097 | bevestigingsset M10x110mm | | 0830097 | paar | 1,09 | 362 | 0 |

**sifonkap voor wastafel**

| | | | | | | | |
|---------|----------|-----|-------------|------|--------|-----|---|
| 0226335 | | RVS | S8HS13C00 | stuk | 19,00 | 042 | 0 |
| 0226343 | 60/120cm | wit | S8S50000000 | stuk | 177,00 | 042 | 0 |

fontein bak rechts, kraangat links

| | | | | | | | |
|---------|--------------------------------------|-----|-------------|------|--------|-----|---|
| 0200040 | 40x23cm | wit | S8440000000 | stuk | 132,00 | 042 | 0 |
| 0200041 | 40x23cm m. ceratect | wit | S8440000001 | stuk | 201,00 | 042 | 0 |
| 0830240 | bevestigingsset voor fontein M8x90mm | | 0830240 | stuk | 0,85 | 362 | 0 |

**fontein bak links, kraangat rechts**

| | | | | | | | |
|---------|--------------------------------------|-----|-------------|------|--------|-----|---|
| 0200043 | 40x23cm | wit | S8448000000 | stuk | 132,00 | 042 | 0 |
| 0200044 | 40x23cm m. ceratect | wit | S8448000001 | stuk | 201,00 | 042 | 0 |
| 0830240 | bevestigingsset voor fontein M8x90mm | | 0830240 | stuk | 0,85 | 362 | 0 |



Sanitair producten

Baden /
douchebakken /
stoomcabines

Kranen

Douchegarnituur

Accessoires en
spiegels

Douchewanden

Toebehoren &
afvoerenSpoel- &
installatiesystemenBadkamermeubelen
en toiletkastenGootstenen en
wastroggen

Utiliteit

| | Art.nr | Specificaties | Kleur | Lev.nr | Ehd | Prijs | Grp | CC |
|---|---|----------------------------------|-----------|-------------|------|---------|-----|----|
| Sanitair producten | Sphinx 420 | | | | | | | |
| | planchet | | | | | | | |
| | 0226378 | 60x12cm | wit | S8828000000 | stuk | 58,50 | 042 | 1 |
| | 0830453 | set potschroeven 5.5x60mm chroom | | 0830453 | stuk | 2,28 | 362 | 0 |
| Baden / douchebakken / stoomcabines | wandclosetpot diepspoel | | | | | | | |
| | 0200022 | | wit | S8250000000 | stuk | 393,00 | 042 | 0 |
| | 0200023 | m. ceratect | wit | S8250000001 | stuk | 473,00 | 042 | 0 |
| Kranen | | | | | | | | |
| Douchegarnituur | duoblokpot diepspoel universeel z. reservoir | | | | | | | |
| | 0082336 | | wit | S8148000000 | stuk | 440,00 | 043 | 1 |
| | 0082337 | m. ceraTect | wit | S8148000001 | stuk | 520,00 | 043 | 1 |
| Accessoires en spiegels | | | | | | | | |
| Douchewanden | duoblokreervoir m. achteraansluiting | | | | | | | |
| | 0082338 | | wit | S8548990000 | stuk | 251,00 | 043 | 1 |
| | duoblokreervoir m. externe aansluiting | | | | | | | |
| | 0082339 | | wit | S8548029000 | stuk | 251,00 | 043 | 1 |
| Toebehoren & afvoeren | closetzitting dubbel | | | | | | | |
| | 0222500 | | wit | S8H5501R000 | stuk | 155,00 | 042 | 0 |
| | 0222501 | m. softclose | wit | S8H550SR000 | stuk | 210,00 | 042 | 0 |
| Spoel- & installatiesystemen | wastafelblad | | | | | | | |
| | 0226440 | 58x43cm | bronce | S8M2550F0 | stuk | 457,00 | 323 | 1 |
| Badkamermeubelen en toiletkasten | wastafelonderbouw voor wastafel 60cm + Quadro 50cm | | | | | | | |
| | 0226472 | z. poten | wit | S8M254000 | stuk | 722,00 | 323 | 1 |
| | 0226459 | z. poten | bronce | S8M2540F0 | stuk | 687,00 | 323 | 0 |
| Gootstenen en wastroggen | wastafelonderbouw voor wastafel 90cm | | | | | | | |
| | 0226471 | z. poten | wit | S8M256000 | stuk | 842,00 | 323 | 1 |
| | 0226467 | z. poten | bronce | S8M2560F0 | stuk | 802,00 | 323 | 0 |
| Utiliteit | wastafelonderbouw voor wastafel 120cm | | | | | | | |
| | 0226470 | z. poten | wit | S8M257000 | stuk | 1444,00 | 323 | 1 |
| | 0226475 | z. poten | bronce | S8M2570F0 | stuk | 1374,00 | 323 | 0 |
| | hoge kast | | | | | | | |
| | 0226469 | 38x41x160cm links | wit | S8M258000 | stuk | 722,00 | 323 | 1 |
| | hoge kast links/rechts | | | | | | | |
| | 0226483 | 38x41x160cm z. poten | bronce | S8M2580F0 | stuk | 687,00 | 323 | 0 |
| | poten verstelbaar | | | | | | | |
| | 0226505 | | aluminium | S8H934000 | stuk | 56,00 | 323 | 0 |

| Art.nr | Specificaties | Kleur | Lev.nr | Ehd | Prijs | Grp | CC |
|--------|---------------|-------|--------|-----|-------|-----|----|
|--------|---------------|-------|--------|-----|-------|-----|----|

Sphinx 420

fonteinspiegel m. verlichting

| | | | | | | | |
|---------|---------|--|-----------|------|--------|-----|---|
| 0226386 | 38x87cm | | S8M2581FO | stuk | 343,00 | 323 | 1 |
|---------|---------|--|-----------|------|--------|-----|---|

wastafelspiegel m. verlichting

| | | | | | | | |
|---------|---------|--|-----------|------|--------|-----|---|
| 0226394 | 58x80cm | | S8M2582FO | stuk | 400,00 | 323 | 1 |
|---------|---------|--|-----------|------|--------|-----|---|

| | | | | | | | |
|---------|---------|--|-----------|------|--------|-----|---|
| 0226408 | 88x87cm | | S8M2583FO | stuk | 514,00 | 323 | 1 |
|---------|---------|--|-----------|------|--------|-----|---|

| | | | | | | | |
|---------|----------|--|-----------|------|--------|-----|---|
| 0226424 | 118x87cm | | S8M2584FO | stuk | 687,00 | 323 | 1 |
|---------|----------|--|-----------|------|--------|-----|---|

wastafelspiegel

| | | | | | | | |
|---------|---------|--|-----------|------|--------|-----|---|
| 0226416 | 88x30cm | | S8M2586FO | stuk | 228,00 | 323 | 1 |
|---------|---------|--|-----------|------|--------|-----|---|

| | | | | | | | |
|---------|----------|--|-----------|------|--------|-----|---|
| 0226432 | 118x36cm | | S8M2587FO | stuk | 263,00 | 323 | 1 |
|---------|----------|--|-----------|------|--------|-----|---|

Sphinx 450

wastafel m. afvoerplug

| | | | | | | | |
|---------|---------|-----|-------------|------|--------|-----|---|
| 0200057 | 40x40cm | wit | S8343000000 | stuk | 222,00 | 042 | 1 |
|---------|---------|-----|-------------|------|--------|-----|---|

| | | | | | | | |
|---------|---------|-------------|-------------|------|--------|-----|---|
| 0200058 | 40x40cm | m. ceratect | S8343000001 | stuk | 292,00 | 042 | 1 |
|---------|---------|-------------|-------------|------|--------|-----|---|

| | | | | | | | |
|---------|---------------------------|--|---------|------|------|-----|---|
| 0830097 | bevestigingsset M10x110mm | | 0830097 | paar | 1,09 | 362 | 0 |
|---------|---------------------------|--|---------|------|------|-----|---|

wastafel rechts m. afvoerplug

| | | | | | | | |
|---------|-----------|-----|-------------|------|--------|-----|---|
| 0200065 | 60x47.5cm | wit | S8350000000 | stuk | 300,00 | 042 | 1 |
|---------|-----------|-----|-------------|------|--------|-----|---|

| | | | | | | | |
|---------|-----------|-------------|-------------|------|--------|-----|---|
| 0200066 | 60x47.5cm | m. ceratect | S8350000001 | stuk | 380,00 | 042 | 1 |
|---------|-----------|-------------|-------------|------|--------|-----|---|

| | | | | | | | |
|---------|---------------------------|--|---------|------|------|-----|---|
| 0830097 | bevestigingsset M10x110mm | | 0830097 | paar | 1,09 | 362 | 0 |
|---------|---------------------------|--|---------|------|------|-----|---|

wastafel links m. afvoerplug

| | | | | | | | |
|---------|-----------|-----|-------------|------|--------|-----|---|
| 0200070 | 60x47.5cm | wit | S8351000000 | stuk | 300,00 | 042 | 0 |
|---------|-----------|-----|-------------|------|--------|-----|---|

| | | | | | | | |
|---------|-----------|-------------|-------------|------|--------|-----|---|
| 0200071 | 60x47.5cm | m. ceratect | S8351000001 | stuk | 380,00 | 042 | 1 |
|---------|-----------|-------------|-------------|------|--------|-----|---|

| | | | | | | | |
|---------|---------------------------|--|---------|------|------|-----|---|
| 0830097 | bevestigingsset M10x110mm | | 0830097 | paar | 1,09 | 362 | 0 |
|---------|---------------------------|--|---------|------|------|-----|---|

wastafel m. afvoerplug m. sifon

| | | | | | | | |
|---------|---------|-----|-------------|------|--------|-----|---|
| 0200053 | 60x48cm | wit | S8349000000 | stuk | 300,00 | 042 | 0 |
|---------|---------|-----|-------------|------|--------|-----|---|

| | | | | | | | |
|---------|---------|-------------|-------------|------|--------|-----|---|
| 0200054 | 60x48cm | m. ceratect | S8349000001 | stuk | 380,00 | 042 | 1 |
|---------|---------|-------------|-------------|------|--------|-----|---|

| | | | | | | | |
|---------|-----------|-----|-------------|------|--------|-----|---|
| 0200074 | 70x47.5cm | wit | S8352000000 | stuk | 419,00 | 042 | 0 |
|---------|-----------|-----|-------------|------|--------|-----|---|

| | | | | | | | |
|---------|-----------|-------------|-------------|------|--------|-----|---|
| 0200075 | 70x47.5cm | m. ceratect | S8352000001 | stuk | 499,00 | 042 | 0 |
|---------|-----------|-------------|-------------|------|--------|-----|---|

| | | | | | | | |
|---------|---------------------------|--|---------|------|------|-----|---|
| 0830097 | bevestigingsset M10x110mm | | 0830097 | paar | 1,09 | 362 | 0 |
|---------|---------------------------|--|---------|------|------|-----|---|

sifonkap voor wastafel

| | | | | | | | |
|---------|------|-----|-----------|------|--------|-----|---|
| 0223395 | 40cm | RVS | S8HS11C00 | stuk | 170,00 | 042 | 1 |
|---------|------|-----|-----------|------|--------|-----|---|

| | | | | | | | |
|---------|---------|-----|-----------|------|--------|-----|---|
| 0223476 | 60/70cm | RVS | S8HS12C00 | stuk | 188,00 | 042 | 0 |
|---------|---------|-----|-----------|------|--------|-----|---|

Sanitair producten

Baden /
douchebakken /
stoomcabines

Kranen







Douchegarnituur

Accessoires en
spiegels

Douchewanden

Toebehoren &
afvoerenSpoel- &
installatiesystemenBadkamermeubelen
en toiletkastenGootstenen en
wastroggen

Utiliteit

| | Art.nr | Specificaties | Kleur | Lev.nr | Ehd | Prijs | Grp | CC |
|---|---|---------------------------------------|---------------------------------------|-------------|-------------|---------|---------|-------|
| Sanitair producten | Sphinx 450 | | | | | | | |
| | fontein | | | | | | | |
| |  | 0200079 | 28x28cm | wit | S8417000000 | stuk | 147,00 | 042 0 |
| | | 0200080 | 28x28cm m. ceratect | wit | S8417000001 | stuk | 216,00 | 042 1 |
| | 0830240 | bevestigingsset voor fontein M8x90mm | | 0830240 | stuk | 0,85 | 362 0 | |
| Baden / douchebakken / stoomcabines | fontein rechts | | | | | | | |
| |  | 0200087 | 40x28cm | wit | S8419000000 | stuk | 153,00 | 042 0 |
| | | 0200088 | 40x28cm m. ceratect | wit | S8419000001 | stuk | 223,00 | 042 1 |
| Kranen | | 0830240 | bevestigingsset voor fontein M8x90mm | 0830240 | stuk | 0,85 | 362 0 | |
| Douchegarnituur | fontein links | | | | | | | |
| |  | 0200083 | 40x28cm | wit | S8418000000 | stuk | 153,00 | 042 0 |
| | | 0200084 | 40x28cm m. ceratect | wit | S8418000001 | stuk | 223,00 | 042 1 |
| | 0830240 | bevestigingsset voor fontein M8x90mm | | 0830240 | stuk | 0,85 | 362 0 | |
| Accessoires en spiegels | sifonkap voor fontein | | | | | | | |
| | 0223301 | 28/40cm | RVS | S8HS10C00 | stuk | 120,00 | 042 0 | |
| Douchewanden | wandclosetpot diepspoel 6-liter | | | | | | | |
| | | 0200049 | | wit | S8247000000 | stuk | 419,00 | 042 0 |
| | | 0200050 | m. ceratect | wit | S8247000001 | stuk | 499,00 | 042 0 |
| Toebehoren & afvoeren | duoblokpot diepspoel universeel 6liter z. reservoir | | | | | | | |
| |  | 0200045 | | wit | S8167000000 | stuk | 470,00 | 042 0 |
| | | 0200046 | m. ceratect | wit | S8167000001 | stuk | 551,00 | 042 1 |
| | | 0202223 | bocht kunststof universeel AO-uitlaat | | S8H782000 | stuk | 21,50 | 042 0 |
| | | 0202614 | bocht kunststof universeel S-uitlaat | | S8H864000 | stuk | 21,50 | 042 1 |
| | 0202622 | bocht kunststof universeel SV-uitlaat | | S8H865000 | stuk | 21,50 | 042 1 | |
| Spoel- & installatiesystemen | duoblokreervoir + binnenwerk | | | | | | | |
| | 0223549 | | wit | S8567990000 | stuk | 382,00 | 042 0 | |
| Badkamermeubelen en toiletkasten | closetzitting dubbel | | | | | | | |
| | | 0222510 | | wit | S8H5601R000 | stuk | 155,00 | 042 0 |
| | | 0222511 | m. softclose | wit | S8H560SR000 | stuk | 210,00 | 042 0 |
| Gootstenen en wastroggen | wastafelonderbouw voor wastafel 60cm links | | | | | | | |
| |  | 0282332 | | peer | S8M5510BE | stuk | 1806,00 | 323 1 |
| | | 0282421 | | esdoorn | S8M5510WE | stuk | 1806,00 | 323 1 |
| Utiliteit | wastafelonderbouw voor wastafel 60cm rechts | | | | | | | |
| |  | 0282324 | | peer | S8M5520BE | stuk | 1806,00 | 323 1 |
| | | 0282413 | | esdoorn | S8M5520WE | stuk | 1806,00 | 323 1 |
| wastafelonderbouw | | | | | | | | |
|  | 0226831 | voor wastafel 60cm | peren | S8M5540BE | stuk | 1806,00 | 323 1 | |
| | 0226858 | voor wastafel 60cm | esdoorn | S8M5540WE | stuk | 1806,00 | 323 1 | |
| | 0282340 | voor wastafel 70cm | peer | S8M5530BE | stuk | 1955,00 | 323 0 | |
| | 0282448 | voor wastafel 70cm | esdoorn | S8M5530WE | stuk | 1955,00 | 323 1 | |

| Art.nr | Specificaties | Kleur | Lev.nr | Ehd | Prijs | Grp | CC |
|--------|---------------|-------|--------|-----|-------|-----|----|
|--------|---------------|-------|--------|-----|-------|-----|----|

Sphinx 450

wastafelonderbouw voor wastafel 70cm m. glas

| | | | | | | | |
|---------|--|--|-----------|------|--------|-----|---|
| 0282359 | | | S8M85000E | stuk | 511,00 | 323 | 1 |
|---------|--|--|-----------|------|--------|-----|---|



Sanitair producten

Baden /
douchebakken /
stoomcabines

fonteinonderbouw

| | | | | | | | |
|---------|--------|---------|-----------|------|---------|-----|---|
| 0282383 | links | peer | S8M5500BE | stuk | 1278,00 | 323 | 1 |
| 0282472 | links | esdoorn | S8M5500WE | stuk | 1278,00 | 323 | 1 |
| 0282391 | rechts | peer | S8M5501BE | stuk | 1278,00 | 323 | 1 |
| 0282480 | rechts | esdoorn | S8M5501WE | stuk | 1278,00 | 323 | 1 |



Kranen

Douchegarnituur

hoge kast

| | | | | | | | |
|---------|--|---------|-----------|------|---------|-----|---|
| 0282367 | | peer | S8M0500BE | stuk | 2107,00 | 323 | 1 |
| 0282456 | | esdoorn | S8M0500WE | stuk | 2107,00 | 323 | 1 |



Accessoires en
spiegels

fonteinspiegel m. verlichting

| | | | | | | | |
|---------|--|---------|-----------|------|--------|-----|---|
| 0282375 | | peer | S8M1500BE | stuk | 753,00 | 323 | 0 |
| 0282464 | | esdoorn | S8M1500WE | stuk | 753,00 | 323 | 1 |



Douchewanden

Toebehoren &
afvoeren

wastafelspiegel m. verlichting

| | | | | | | | |
|---------|--|---------|-----------|------|--------|-----|---|
| 0282316 | | peer | S8M1510BE | stuk | 904,00 | 323 | 0 |
| 0282405 | | esdoorn | S8M1510WE | stuk | 904,00 | 323 | 1 |



Spoel- &
installatiesystemen

Badkamermeubelen
en toiletkasten

Sphinx Animo II

wastafel

| | | | | | | | |
|---------|------------|-----|-------------|------|-------|-----|---|
| 0226922 | 50cm | wit | SZ300600000 | stuk | 34,25 | 044 | 0 |
| 0226902 | 60x45,5cm. | wit | SZ300700000 | stuk | 34,25 | 044 | 0 |

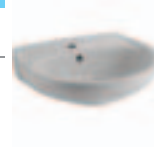

Gootstenen en
wastroggen

fontein

| | | | | | | | |
|---------|----------|-----|-------------|------|-------|-----|---|
| 0226904 | 40x33cm. | wit | SZ400500000 | stuk | 25,75 | 044 | 0 |
|---------|----------|-----|-------------|------|-------|-----|---|



Utiliteit



sifonkap voor wastafel

| | | | | | | | |
|---------|--|-----|-------------|------|-------|-----|---|
| 0226906 | | wit | SZS00400000 | stuk | 32,25 | 044 | 0 |
|---------|--|-----|-------------|------|-------|-----|---|

wandclosetpot diepspoel

| | | | | | | | |
|---------|--|-----|-------------|------|-------|-----|---|
| 0226910 | | wit | SZ200300000 | stuk | 73,00 | 044 | 0 |
|---------|--|-----|-------------|------|-------|-----|---|



| | Art.nr | Specificaties | Kleur | Lev.nr | Ehd | Prijs | Grp | CC |
|---|---|--------------------------------------|----------|-------------|------|--------|-----|----|
| Sanitair producten | Sphinx Animo II | | | | | | | |
| | klosetkombinatie AO | | | | | | | |
| | 0226912 | | wit | ANIMO II | stuk | 119,50 | 044 | 0 |
| Baden / douchebakken / stoomcabines |  | | | | | | | |
| Kranen | klosetkombinatie PK | | | | | | | |
| | 0226914 | | wit | ANIMO II | stuk | 110,00 | 044 | 0 |
| Douchegarnituur |  | | | | | | | |
| Accessoires en spiegels | zuil voor wastafel | | | | | | | |
| | 0226924 | | wit | SZ700400000 | stuk | 32,25 | 044 | 0 |
| Douchewanden | closetzitting dubbel | | | | | | | |
| | 0226926 | | wit | SZH5B050000 | stuk | 34,00 | 044 | 0 |
| Toebehoren & afvoeren | Sphinx Atlantic | | | | | | | |
| | wastafel | | | | | | | |
| | 0221619 | 48x56cm | wit | S8346000000 | stuk | 479,00 | 042 | 1 |
| | 0830097 | bevestigingsset M10x110mm | | 0830097 | paar | 1,09 | 362 | 0 |
| Spool- & installatiesystemen | sifonkap voor wastafel | | | | | | | |
| | 0221627 | | RVS | S8HS00C01 | stuk | 268,00 | 042 | 0 |
| Badkamermeubelen en toiletkasten | fontein | | | | | | | |
| | 0226092 | 34x34cm | wit | S8446000000 | stuk | 219,00 | 042 | 0 |
| | 0226106 | 34x34cm | pergamon | S8446000030 | stuk | 219,00 | 042 | 1 |
| | 0830240 | bevestigingsset voor fontein M8x90mm | | 0830240 | stuk | 0,85 | 362 | 0 |
| Gootstenen en wastroggen | hoekfontein | | | | | | | |
| | 0200098 | 34x34cm | wit | S8476000000 | stuk | 276,00 | 042 | 0 |
| | 0200097 | 34x34cm | pergamon | S8476000030 | stuk | 276,00 | 042 | 1 |
| | 0830240 | bevestigingsset voor fontein M8x90mm | | 0830240 | stuk | 0,85 | 362 | 0 |
| Utiliteit | sifonkap voor hoekfontein | | | | | | | |
| | 0222917 | | RVS | S8HS02C00 | stuk | 284,00 | 042 | 0 |
| | kunststof bocht | | | | | | | |
| | 0223093 | tbv S/SV-uitlaat | | S8H898000 | stuk | 50,50 | 042 | 0 |
| | 0223085 | tbv AO-uitlaat | | S8H897000 | stuk | 50,50 | 042 | 0 |
| | wandurinoir voor deksel m. sifon | | | | | | | |
| | 0226793 | | wit | S8635000000 | stuk | 415,00 | 042 | 1 |
| |  | | | | | | | |
| | deksel voor wandurinoir | | | | | | | |
| | 0226815 | | wit | S8H5AU00000 | stuk | 114,00 | 042 | 1 |

| Art.nr | Specificaties | Kleur | Lev.nr | Ehd | Prijs | Grp | CC |
|--------|---------------|-------|--------|-----|-------|-----|----|
|--------|---------------|-------|--------|-----|-------|-----|----|

Sphinx Atlantic

planchet links/rechts voor wastafel 48cm

| | | | | | | | |
|---------|--|-----------|-----------|------|--------|-----|---|
| 0282251 | | peren | S8M830IBC | stuk | 391,00 | 323 | 1 |
| 0282618 | | black oak | S8M830IUC | stuk | 391,00 | 323 | 1 |

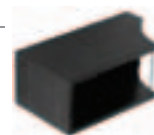

Sanitair producten

Baden /
douchebakken /
stoomcabines

centraal planchet voor wastafel 48cm

| | | | | | | | |
|---------|--|-----------|-----------|------|--------|-----|---|
| 0282278 | | peren | S8M831IBC | stuk | 450,00 | 323 | 1 |
| 0282626 | | black oak | S8M831IUC | stuk | 450,00 | 323 | 1 |



Kranen

planchet voor fontein 34cm

| | | | | | | | |
|---------|--|-----------|-----------|------|--------|-----|---|
| 0282294 | | peren | S8M832IBC | stuk | 223,00 | 323 | 1 |
| 0282642 | | black oak | S8M832IUC | stuk | 223,00 | 323 | 1 |



Douchegarnituur

centraal spiegel 78cm m. verlichting

| | | | | | | | |
|---------|--|-----------|-----------|------|--------|-----|---|
| 0282235 | | peren | S8M131IBC | stuk | 787,00 | 323 | 1 |
| 0282588 | | black oak | S8M131IUC | stuk | 787,00 | 323 | 1 |

Accessoires en
spiegels

Douchewanden

spiegel links/rechts 78cm m. verlichting

| | | | | | | | |
|---------|--|-----------|-----------|------|--------|-----|---|
| 0282243 | | peren | S8M132IBC | stuk | 586,00 | 323 | 1 |
| 0282596 | | black oak | S8M132IUC | stuk | 586,00 | 323 | 1 |

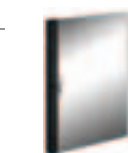
Toebehoren &
afvoerenSpoel- &
installatiesystemen

fontein Spiegel 25x95cm

| | | | | | | | |
|---------|--|-----------|-----------|------|--------|-----|---|
| 0282286 | | peren | S8M133IBC | stuk | 428,00 | 323 | 1 |
| 0282634 | | black oak | S8M133IUC | stuk | 428,00 | 323 | 1 |

Badkamermeubelen
en toiletkastenGootstenen en
wastroggen

Sphinx Dio

wastafel

| | | | | | | | |
|---------|---------------------------|-----|-------------|------|-------|-----|---|
| 0083410 | 60x48.5cm | wit | SZ320000000 | stuk | 57,50 | 044 | 0 |
| 0830097 | bevestigingsset M10x110mm | | 0830097 | paar | 1,09 | 362 | 0 |



Utiliteit

sifonkap voor wastafel

| | | | | | | | |
|---------|--|-----|-------------|------|-------|-----|---|
| 0088250 | | wit | SZS89000000 | stuk | 45,00 | 044 | 0 |
|---------|--|-----|-------------|------|-------|-----|---|

fontein K2Z

| | | | | | | | |
|---------|--------------------------------------|-----|-------------|------|-------|-----|---|
| 0088269 | 36x23.5cm | wit | SZ436000000 | stuk | 36,00 | 044 | 0 |
| 0830240 | bevestigingsset voor fontein M8x90mm | | 0830240 | stuk | 0,85 | 362 | 0 |



closetpot 2x2 vlakspoel A0

| | | | | | | | |
|---------|-------------------------------|-----|-------------|------|-------|-----|---|
| 0083445 | | wit | SZ096010000 | stuk | 72,00 | 044 | 0 |
| 0830410 | set potschroeven 5.5x60mm wit | | 0830410 | stuk | 0,84 | 362 | 0 |



| | Art.nr | Specificaties | Kleur | Lev.nr | Ehd | Prijs | Grp | CC |
|---|---|----------------------------------|-------|-------------------------|------|--------|-----|----|
| Sanitair producten | Sphinx Dio | | | | | | | |
| | closetpot 2x2 vlakspoel PK | | | | | | | |
| | 0083453 | | wit | S8088000000 | stuk | 71,00 | 044 | 0 |
| | 0830410 | set potschroeven 5.5x60mm wit | | 0830410 | stuk | 0,84 | 362 | 0 |
| Baden / douchebakken / stoomcabines | wandclosetpot diepspoel | | | | | | | |
| | 0083518 | | wit | SZ229000000 | stuk | 127,00 | 044 | 0 |
| Kranen | closetcombinatie AO | | | | | | | |
| | 0083412 | | wit | KLOSETKOMBINATIE AO WIT | stuk | 0,00 | 044 | 0 |
| Douchegarnituur | closetcombinatie PK | | | | | | | |
| | 0083413 | | wit | KLOSETKOMBINATIE PK WIT | stuk | 0,00 | 044 | 0 |
| Accessoires en spiegels | closetcombinatie S | | | | | | | |
| | 0083414 | | wit | KLOSETKOMBINATIE S WIT | stuk | 0,00 | 044 | 0 |
| Douchewanden | closetcombinatie SV | | | | | | | |
| | 0083415 | | wit | KLOSETKOMBINATIE SV WIT | stuk | 0,00 | 044 | 0 |
| Toebehoren & afvoeren | duoblokpot AO | | | | | | | |
| | 0083520 | | wit | SZ162010000 | stuk | 105,00 | 044 | 0 |
| Spoel- & installatiesystemen | duoblokpot PK | | | | | | | |
| | 0083522 | | wit | S8163010000 | stuk | 96,50 | 044 | 0 |
| Badkamermeubelen en toiletkasten | duoblokpot S | | | | | | | |
| | 0083528 | | wit | SZ164010000 | stuk | 118,00 | 044 | 1 |
| Gootstenen en wastroggen | duoblokpot SV | | | | | | | |
| | 0083530 | | wit | SZ165010000 | stuk | 118,00 | 044 | 1 |
| Utiliteit | duoblokreervoir m/binnenwerk | | | | | | | |
| | 0083524 | | wit | SZ563990000 | stuk | 86,50 | 035 | 0 |
| | Sphinx Ergonomic | | | | | | | |
| | closetpot-73 verhoogd +6cm vlakspoel AO | | | | | | | |
| | 0202509 | | wit | S8040000000 | stuk | 212,00 | 044 | 0 |
| | 0830453 | set potschroeven 5.5x60mm chroom | | 0830453 | stuk | 2,28 | 362 | 0 |
| | closetpot-73 verhoogd +6cm vlakspoel PK | | | | | | | |
| | 0202525 | | wit | S8042000000 | stuk | 185,00 | 044 | 0 |
| | 0830453 | set potschroeven 5.5x60mm chroom | | 0830453 | stuk | 2,28 | 362 | 0 |
| | closetpot-43 verhoogd +4cm diepspoel USV | | | | | | | |
| | 0200883 | | wit | S8029000000 | stuk | 177,00 | 044 | 0 |
| | 0830453 | set potschroeven 5.5x60mm chroom | | 0830453 | stuk | 2,28 | 362 | 0 |
| | closetpot-68 verhoogd +6cm vlakspoel PK 23,5cm | | | | | | | |
| | 0200077 | | wit | S8038000000 | stuk | 226,00 | 044 | 0 |
| | 0830453 | set potschroeven 5.5x60mm chroom | | 0830453 | stuk | 2,28 | 362 | 0 |

| Art.nr | Specificaties | Kleur | Lev.nr | Ehd | Prijs | Grp | CC |
|----------------------------------|----------------------------------|-------|-------------|------|--------|-----|----|
| Sphinx Ergonomic | | | | | | | |
| kinderclosetpot-18 SV | | | | | | | |
| 0202355 | | wit | S8016000000 | stuk | 169,00 | 044 | 0 |
| 0830453 | set potschroeven 5.5x60mm chroom | | 0830453 | stuk | 2,28 | 362 | 0 |
| kinderclosetzitting enkel | | | | | | | |
| 0209995 | | wit | S8H5K00R000 | stuk | 54,00 | 044 | 0 |



Sanitair producten

Baden /
douchebakken /
stoomcabines

Kranen

Douchegarnituur

Accessoires en
spiegels

Douchewanden

Toebehoren &
afvoerenSpoel- &
installatiesystemenBadkamermeubelen
en toiletkastenGootstenen en
wastroggen

Utiliteit

pagette®



KADETT 300 S

vorm ontmoet functie

UITVOERINGEN

Met RVS bevestiging

Art. Nr.: 7.9188 - 0202 wit
7.9188 - 0272 pergamon

Met afneembare bevestiging

Art. Nr.: 7.9188 - 0302 wit
7.9188 - 0372 pergamon

Met Soft-Close bevestiging

Art. Nr.: 7.9188 - 0402 wit
7.9188 - 0472 pergamon

Met RVS bevestiging, zonder deksel

Art. Nr.: 7.9189 - 0202 wit
7.9189 - 0272 pergamon

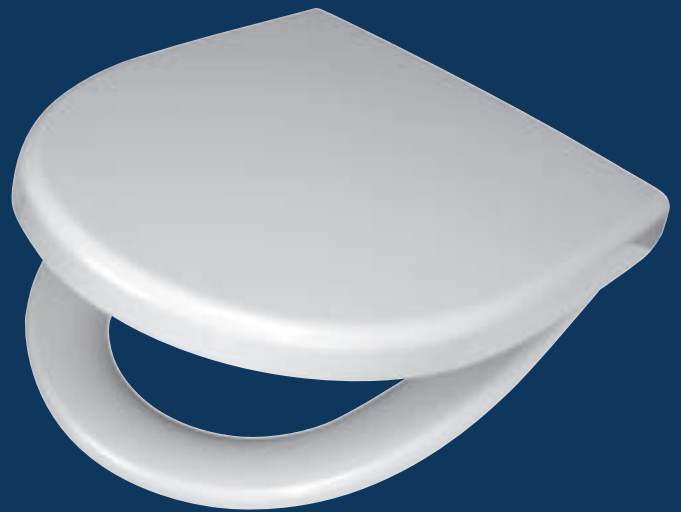

Geschikt voor design keramiek speciaal voor o.a. Sphinx 300 [New Eurobase]

Hamers & Kesber

Agent voor Nederland Tel 035 6566888 info@hamersenkesber.nl www.pagette.com

| Art.nr | Specificaties | Kleur | Lev.nr | Ehd | Prijs | Grp | CC |
|--------|---------------|-------|--------|-----|-------|-----|----|
|--------|---------------|-------|--------|-----|-------|-----|----|

Sphinx 300 [New Eurobase]

wastafel m. kraangat m. overloop

| | | | | | | | | |
|---------|---------------------------|-------------|----------|-------------|------|--------|-----|---|
| 0082424 | 50x38cm | | wit | S8300100000 | stuk | 94,00 | 044 | 0 |
| 0082387 | 50x38cm | | pergamon | S8300100030 | stuk | 117,00 | 044 | 1 |
| 0082388 | 50x38cm | m. ceraTect | wit | S8300100001 | stuk | 175,00 | 044 | 1 |
| 0082389 | 50x38cm | m. ceraTect | pergamon | S8300100031 | stuk | 197,00 | 044 | 1 |
| 0082309 | 55x44.5cm | | wit | S8300200000 | stuk | 96,00 | 044 | 0 |
| 0082311 | 55x44.5cm | | pergamon | S8300200030 | stuk | 136,00 | 044 | 1 |
| 0082310 | 55x44.5cm | m. ceraTect | wit | S8300200001 | stuk | 177,00 | 044 | 1 |
| 0082312 | 55x44.5cm | m. ceraTect | pergamon | S8300200031 | stuk | 216,00 | 044 | 1 |
| 0082313 | 60x47.5cm | | wit | S8300300000 | stuk | 82,00 | 044 | 0 |
| 0082315 | 60x47.5cm | | pergamon | S8300300030 | stuk | 129,00 | 044 | 0 |
| 0082314 | 60x47.5cm | m. ceraTect | wit | S8300300001 | stuk | 163,00 | 044 | 0 |
| 0082316 | 60x47.5cm | m. ceraTect | pergamon | S8300300031 | stuk | 209,00 | 044 | 1 |
| 0082394 | 65x47.5cm | | wit | S8300400000 | stuk | 107,00 | 044 | 0 |
| 0082395 | 65x47.5cm | | pergamon | S8300400030 | stuk | 161,00 | 044 | 1 |
| 0082396 | 65x47.5cm | m. ceraTect | wit | S8300400001 | stuk | 187,00 | 044 | 1 |
| 0082397 | 65x47.5cm | m. ceraTect | pergamon | S8300400031 | stuk | 241,00 | 044 | 1 |
| 0830097 | bevestigingsset M10x110mm | | | 0830097 | paar | 1,09 | 362 | 0 |

Arco wastafel m. kraangat m. overloop

| | | | | | | | | |
|---------|---------------------------|-----------------------------|----------|-------------|------|--------|-----|---|
| 0082318 | 55x45.5cm | m. consolegaten | wit | S8302400000 | stuk | 96,00 | 044 | 1 |
| 0082320 | 55x45.5cm | m. consolegaten | pergamon | S8302400030 | stuk | 136,00 | 044 | 1 |
| 0082319 | 55x45.5cm | m. consolegaten m. ceraTect | wit | S8302400001 | stuk | 177,00 | 043 | 1 |
| 0082321 | 55x45.5cm | m. consolegaten m. ceraTect | pergamon | S8302400031 | stuk | 216,00 | 043 | 1 |
| 0082322 | 60x48.5cm | m. consolegaten | wit | S8302500000 | stuk | 82,00 | 044 | 0 |
| 0082324 | 60x48.5cm | m. consolegaten | pergamon | S8302500030 | stuk | 129,00 | 044 | 1 |
| 0082323 | 60x48.5cm | m. consolegaten m. ceraTect | wit | S8302500001 | stuk | 163,00 | 044 | 1 |
| 0082326 | 60x48.5cm | m. consolegaten m. ceraTect | pergamon | S8302500031 | stuk | 209,00 | 044 | 1 |
| 0830097 | bevestigingsset M10x110mm | | | 0830097 | paar | 1,09 | 362 | 0 |

Compact wastafel m. kraangat m. overloop

| | | | | | | | | |
|---------|---------------------------|-------------|----------|-------------|------|--------|-----|---|
| 0082390 | 60x40cm | | wit | S8301900000 | stuk | 82,00 | 044 | 1 |
| 0082391 | 60x40cm | | pergamon | S8301900030 | stuk | 129,00 | 044 | 1 |
| 0082417 | 60x40cm | m. ceraTect | wit | S8301900001 | stuk | 163,00 | 044 | 1 |
| 0082393 | 60x40cm | m. ceraTect | pergamon | S8301900031 | stuk | 209,00 | 044 | 1 |
| 0830097 | bevestigingsset M10x110mm | | | 0830097 | paar | 1,09 | 362 | 0 |

sifonkap voor wastafel

| | | | | | | | | |
|---------|--|------------------------|----------|-------------|------|--------|-----|---|
| 0082299 | | m. Cerafix bevestiging | wit | S8S00100000 | stuk | 135,00 | 044 | 0 |
| 0082300 | | m. Cerafix bevestiging | pergamon | S8S00100030 | stuk | 166,00 | 044 | 0 |

zuil voor wastafel

| | | | | | | | | |
|---------|--|--|----------|-------------|------|--------|-----|---|
| 0082293 | | | wit | S8700100000 | stuk | 105,00 | 044 | 1 |
| 0082294 | | | pergamon | S8700100030 | stuk | 139,00 | 044 | 1 |

opbouwastafel A

| | | | | | | | | |
|---------|-----------|-------------|----------|-------------|------|--------|-----|---|
| 0082431 | 60x47.5cm | | wit | S8W00300000 | stuk | 232,00 | 044 | 1 |
| 0082433 | 60x47.5cm | | pergamon | S8W00300030 | stuk | 291,00 | 044 | 1 |
| 0082432 | 60x47.5cm | m. ceraTect | wit | S8W00300001 | stuk | 302,00 | 044 | 1 |
| 0082434 | 60x47.5cm | m. ceraTect | pergamon | S8W00300031 | stuk | 360,00 | 044 | 1 |

opbouwastafel B

| | | | | | | | | |
|---------|---------|-------------|----------|-------------|------|--------|-----|---|
| 0082435 | 60x46cm | | wit | S8W00400000 | stuk | 190,00 | 044 | 1 |
| 0082437 | 60x46cm | | pergamon | S8W00400030 | stuk | 239,00 | 044 | 1 |
| 0082436 | 60x46cm | m. ceraTect | wit | S8W00400001 | stuk | 259,00 | 044 | 1 |
| 0082438 | 60x46cm | m. ceraTect | pergamon | S8W00400031 | stuk | 308,00 | 044 | 1 |

Sanitair producten

Baden /
douchebakken /
stoomcabines

Kranen

Douchegarnituur

Accessoires en
spiegels

Douchewanden

Toebehoren &
afvoerenSpoel- &
installatiesystemenBadkamermeubelen
en toiletkastenGootstenen en
wastroggen

Utiliteit

| Art.nr | Specificaties | Kleur | Lev.nr | Ehd | Prijs | Grp | CC |
|--------|---------------|-------|--------|-----|-------|-----|----|
|--------|---------------|-------|--------|-----|-------|-----|----|

Sphinx 300 [New Eurobase]

opbouwastafel C

| | | | | | | | | |
|---------|--------|-------------|----------|-------------|------|--------|-----|---|
| 0082439 | 48.5cm | | wit | S8W00500000 | stuk | 177,00 | 044 | 1 |
| 0082441 | 48.5cm | | pergamon | S8W00500030 | stuk | 222,00 | 044 | 1 |
| 0082440 | 48.5cm | m. ceraTect | wit | S8W00500001 | stuk | 246,00 | 044 | 1 |
| 0082442 | 48.5cm | m. ceraTect | pergamon | S8W00500031 | stuk | 291,00 | 044 | 1 |



onderbouwastafel K

| | | | | | | | | |
|---------|------|-------------|----------|-------------|------|--------|-----|---|
| 0082443 | 46cm | | wit | S8W00600000 | stuk | 239,00 | 044 | 1 |
| 0082445 | 46cm | | pergamon | S8W00600030 | stuk | 297,00 | 044 | 1 |
| 0082444 | 46cm | m. ceraTect | wit | S8W00600001 | stuk | 308,00 | 044 | 1 |
| 0082446 | 46cm | m. ceraTect | pergamon | S8W00600031 | stuk | 367,00 | 044 | 1 |



rolstoelwastafel

| | | | | | | | | |
|---------|---------|-------------------------------------|----------|-------------|------|--------|-----|---|
| 0082447 | 65x56cm | m. kraangat m. overloop | wit | S8302900000 | stuk | 212,00 | 044 | 1 |
| 0082450 | 65x56cm | m. kraangat m. overloop | pergamon | S8302900030 | stuk | 265,00 | 044 | 1 |
| 0082448 | 65x56cm | m. kraangat m. overloop m. ceraT. | wit | S8302900001 | stuk | 292,00 | 044 | 1 |
| 0082451 | 65x56cm | m. kraangat m. overloop m. ceraT. | pergamon | S8302900031 | stuk | 345,00 | 044 | 1 |
| 0082452 | 65x56cm | m. kraangat z. overloop | wit | S8302910000 | stuk | 212,00 | 044 | 1 |
| 0082454 | 65x56cm | m. kraangat z. overloop | pergamon | S8302910030 | stuk | 265,00 | 044 | 1 |
| 0082453 | 65x56cm | m. kraangat z. overloop m. ceraTect | wit | S8302910001 | stuk | 292,00 | 044 | 1 |
| 0082455 | 65x56cm | m. kraangat z. overloop m. ceraTect | pergamon | S8302910031 | stuk | 345,00 | 044 | 1 |
| 0082456 | 65x56cm | z. kraangat z. overloop | wit | S8302915000 | stuk | 212,00 | 044 | 1 |
| 0082459 | 65x56cm | z. kraangat z. overloop | pergamon | S8302915030 | stuk | 265,00 | 044 | 1 |
| 0082458 | 65x56cm | z. kraangat z. overloop m. ceraTect | wit | S8302915001 | stuk | 292,00 | 044 | 1 |
| 0082460 | 65x56cm | z. kraangat z. overloop m. ceraTect | pergamon | S8302915031 | stuk | 345,00 | 044 | 1 |



planchet

| | | | | | | | | |
|---------|---------------------------|-------|----------|-------------|------|-------|-----|---|
| 0238060 | 50x12cm | | wit | S8800200000 | stuk | 50,50 | 044 | 0 |
| 0238062 | 50x12cm | | pergamon | S8800200030 | stuk | 63,00 | 044 | 0 |
| 0238064 | 60x12cm | | wit | S8800300000 | stuk | 52,00 | 044 | 0 |
| 0238067 | 60x12cm | | pergamon | S8800300030 | stuk | 65,00 | 044 | 0 |
| 0830453 | set potschroeven 5.5x60mm | chrom | | 0830453 | stuk | 2,28 | 362 | 0 |

fontein m. kraangat m. overloop

| | | | | | | | | |
|---------|--------------------------------------|-------------|----------|-------------|------|--------|-----|---|
| 0082284 | 36x25cm | | wit | S8400100000 | stuk | 40,25 | 044 | 0 |
| 0082286 | 36x25cm | | pergamon | S8400100030 | stuk | 68,00 | 044 | 0 |
| 0082285 | 36x25cm | m. ceraTect | wit | S8400100001 | stuk | 110,00 | 044 | 1 |
| 0082288 | 36x25cm | m. ceraTect | pergamon | S8400100031 | stuk | 138,00 | 044 | 1 |
| 0082289 | 40x29.5cm | | wit | S8400200000 | stuk | 43,75 | 044 | 0 |
| 0082291 | 40x29.5cm | | pergamon | S8400200030 | stuk | 70,00 | 044 | 0 |
| 0082290 | 40x29.5cm | m. ceraTect | wit | S8400200001 | stuk | 114,00 | 044 | 1 |
| 0082292 | 40x29.5cm | m. ceraTect | pergamon | S8400200031 | stuk | 140,00 | 044 | 1 |
| 0082398 | 45x25cm | | wit | S8400300000 | stuk | 74,00 | 044 | 0 |
| 0082399 | 45x25cm | | pergamon | S8400300030 | stuk | 95,00 | 044 | 1 |
| 0082400 | 45x25cm | m. ceraTect | wit | S8400300001 | stuk | 144,00 | 044 | 1 |
| 0082401 | 45x25cm | m. ceraTect | pergamon | S8400300031 | stuk | 165,00 | 044 | 1 |
| 0830240 | bevestigingsset voor fontein M8x90mm | | | 0830240 | stuk | 0,85 | 362 | 0 |



hoekfontein m. kraangat m. overloop

| | | | | | | | | |
|---------|--------------------------------------|-------------|----------|-------------|------|--------|-----|---|
| 0082402 | 46.7x40.5cm | | wit | S8401000000 | stuk | 80,50 | 044 | 0 |
| 0082403 | 46.7x40.5cm | | pergamon | S8401000030 | stuk | 111,00 | 044 | 0 |
| 0082404 | 46.7x40.5cm | m. ceraTect | wit | S8401000001 | stuk | 150,00 | 044 | 1 |
| 0082425 | 46.7x40.5cm | m. ceraTect | pergamon | S8401000031 | stuk | 181,00 | 044 | 1 |
| 0830240 | bevestigingsset voor fontein M8x90mm | | | 0830240 | stuk | 0,85 | 362 | 0 |



| Art.nr | Specificaties | Kleur | Lev.nr | Ehd | Prijs | Grp | CC |
|--------|---------------|-------|--------|-----|-------|-----|----|
|--------|---------------|-------|--------|-----|-------|-----|----|

Sphinx 300 [New Eurobase]

closetpot vlakspoel 96

| | | | | | | | |
|---------|----------------------------------|----------|-------------|------|--------|-----|---|
| 0082327 | AO | wit | S8000100000 | stuk | 107,00 | 044 | 0 |
| 0082329 | AO | pergamon | S8000100030 | stuk | 160,00 | 044 | 0 |
| 0082328 | AO m. ceratect | wit | S8000100001 | stuk | 187,00 | 044 | 1 |
| 0082330 | AO m. ceratect | pergamon | S8000100031 | stuk | 241,00 | 044 | 1 |
| 0082331 | PK | wit | S8000200000 | stuk | 105,00 | 044 | 0 |
| 0082334 | PK | pergamon | S8000200030 | stuk | 160,00 | 044 | 0 |
| 0082332 | PK m. ceraTect | wit | S8000200001 | stuk | 185,00 | 044 | 1 |
| 0082335 | PK m. ceraTect | pergamon | S8000200031 | stuk | 241,00 | 044 | 1 |
| 0082358 | S | wit | S8000400000 | stuk | 122,00 | 044 | 0 |
| 0082419 | S | pergamon | S8000400030 | stuk | 180,00 | 044 | 1 |
| 0082360 | S m. ceraTect | wit | S8000400001 | stuk | 202,00 | 044 | 1 |
| 0082361 | S m. ceraTect | pergamon | S8000400031 | stuk | 260,00 | 044 | 1 |
| 0830453 | set potschroeven 5.5x60mm chroom | | 0830453 | stuk | 2,28 | 362 | 0 |

closetpot diepspoel 94

| | | | | | | | |
|---------|----------------------------------|----------|-------------|------|--------|-----|---|
| 0082362 | PK | wit | S8000300000 | stuk | 119,00 | 044 | 0 |
| 0082420 | PK | pergamon | S8000300030 | stuk | 156,00 | 044 | 1 |
| 0082364 | PK m. ceraTect | wit | S8000300001 | stuk | 200,00 | 044 | 1 |
| 0082365 | PK m. ceraTect | pergamon | S8000300031 | stuk | 237,00 | 044 | 1 |
| 0082366 | SV | wit | S8000500000 | stuk | 138,00 | 044 | 0 |
| 0082367 | SV | pergamon | S8000500030 | stuk | 182,00 | 044 | 1 |
| 0082368 | SV m. ceraTect | wit | S8000500001 | stuk | 219,00 | 044 | 1 |
| 0082421 | SV m. ceraTect | pergamon | S8000500031 | stuk | 263,00 | 044 | 1 |
| 0830453 | set potschroeven 5.5x60mm chroom | | 0830453 | stuk | 2,28 | 362 | 0 |

closetpot vlakspoel 64 +3cm

| | | | | | | | |
|---------|----------------|----------|-------------|------|--------|-----|---|
| 0082487 | AO | wit | S8001200000 | stuk | 144,00 | 044 | 1 |
| 0082489 | AO m. ceraTect | pergamon | S8001200030 | stuk | 193,00 | 044 | 1 |
| 0082491 | PK | wit | S8001300000 | stuk | 144,00 | 044 | 1 |
| 0082493 | PK | pergamon | S8001300030 | stuk | 193,00 | 044 | 1 |

closetpot vlakspoel 93

| | | | | | | | |
|--------------|----------------------------------|----------|-------------|------|--------|-----|---|
| 0082370 +6cm | AO | wit | S8000700000 | stuk | 196,00 | 044 | 0 |
| 0082371 +6cm | AO | pergamon | S8000700030 | stuk | 272,00 | 044 | 0 |
| 0082372 +6cm | AO m. ceraTect | wit | S8000700001 | stuk | 277,00 | 044 | 1 |
| 0082373 +6cm | AO m. ceraTect | pergamon | S8000700031 | stuk | 352,00 | 044 | 1 |
| 0082374 +6cm | PK | wit | S8000600000 | stuk | 171,00 | 044 | 0 |
| 0082375 +6cm | PK | pergamon | S8000600030 | stuk | 238,00 | 044 | 1 |
| 0082423 +6cm | PK m. ceraTect | wit | S8000600001 | stuk | 252,00 | 044 | 1 |
| 0082377 +6cm | PK m. ceraTect | pergamon | S8000600031 | stuk | 318,00 | 044 | 1 |
| 0830453 | set potschroeven 5.5x60mm chroom | | 0830453 | stuk | 2,28 | 362 | 0 |

closetpot vlakspoel 84

| | | | | | | | |
|---------------|----------------------------------|----------|-------------|------|--------|-----|---|
| 0082415 +10cm | AO | wit | S8000900000 | stuk | 208,00 | 044 | 0 |
| 0082379 +10cm | AO | pergamon | S8000900030 | stuk | 286,00 | 044 | 1 |
| 0082380 +10cm | AO m. ceraTect | wit | S8000900001 | stuk | 288,00 | 044 | 1 |
| 0082381 +10cm | AO m. ceraTect | pergamon | S8000900031 | stuk | 367,00 | 044 | 1 |
| 0082382 +10cm | PK | wit | S8000800000 | stuk | 185,00 | 044 | 0 |
| 0082383 +10cm | PK | pergamon | S8000800030 | stuk | 257,00 | 044 | 1 |
| 0082416 +10cm | PK m. ceraTect | wit | S8000800001 | stuk | 266,00 | 044 | 1 |
| 0082385 +10cm | PK m. ceraTect | pergamon | S8000800031 | stuk | 337,00 | 044 | 1 |
| 0830453 | set potschroeven 5.5x60mm chroom | | 0830453 | stuk | 2,28 | 362 | 0 |

duoblopot diepspoel 54 z. reservoir

| | | | | | | | |
|---------|----------------|----------|-------------|------|--------|-----|---|
| 0082407 | AO | wit | S8100200000 | stuk | 257,00 | 044 | 0 |
| 0082408 | AO | pergamon | S8100200030 | stuk | 337,00 | 044 | 0 |
| 0082409 | AO m. ceraTect | wit | S8100200001 | stuk | 337,00 | 044 | 1 |
| 0082411 | AO m. ceraTect | pergamon | S8100200031 | stuk | 418,00 | 044 | 1 |
| 0082340 | PK | wit | S8100100000 | stuk | 253,00 | 044 | 0 |
| 0082412 | PK | pergamon | S8100100030 | stuk | 330,00 | 044 | 0 |
| 0082342 | PK m. ceraTect | wit | S8100100001 | stuk | 334,00 | 044 | 1 |
| 0082343 | PK m. ceraTect | pergamon | S8100100031 | stuk | 410,00 | 044 | 1 |

Sanitair producten

Baden /
douchebakken /
stoomcabines

Kranen

Douchegarnituur

Accessoires en
spiegels

Douchewanden

Toebehoren &
afvoerenSpoel- &
installatiesystemenBadkamermeubelen
en toiletkastenGootstenen en
wastroggen

Utiliteit

| | Art.nr | Specificaties | Kleur | Lev.nr | Ehd | Prijs | Grp | CC |
|----------------------------------|---|---------------------|----------|-------------------------|------|--------|-----|----|
| | Sphinx 300 [New Eurobase] | | | | | | | |
| Sanitair producten | duoblokpot diepspoel 49 z. reservoir | | | | | | | |
| | 0082344 | +6cm PK | wit | S8101500000 | stuk | 373,00 | 044 | 0 |
| | 0082345 | +6cm PK | pergamon | S8101500030 | stuk | 469,00 | 044 | 0 |
| | 0082346 | +6cm PK m. ceraTect | wit | S8101500001 | stuk | 453,00 | 044 | 1 |
| | 0082347 | +6cm PK m. ceraTect | pergamon | S8101500031 | stuk | 549,00 | 044 | 1 |
| | 0082348 | +6cm AO | wit | S8101400000 | stuk | 401,00 | 044 | 0 |
| | 0082349 | +6cm AO | pergamon | S8101400030 | stuk | 502,00 | 044 | 0 |
| | 0082350 | +6cm AO m. ceraTect | wit | S8101400001 | stuk | 481,00 | 044 | 1 |
| Kranen | duoblokreervoir m. binnenwerk | | | | | | | |
| | 0082352 | onder aansluiting | wit | S8500199000 | stuk | 132,00 | 044 | 0 |
| | 0082353 | onder aansluiting | pergamon | S8500199030 | stuk | 163,00 | 044 | 0 |
| | 0082495 | zij aansluiting | wit | S8500197000 | stuk | 132,00 | 044 | 0 |
| Douchegarnituur | 0082496 | zij aansluiting | pergamon | S8500197030 | stuk | 163,00 | 044 | 0 |
| | closetcombinatie 54 diepspoel AO | | | | | | | |
| Accessoires en spiegels | 0082532 | | wit | KLOSETKOMB.54 DIEPSPAOW | stuk | 389,00 | 044 | 0 |
| | 0082533 | | pergamon | KLOSETKOMB.54 DIEPSPAOP | stuk | 500,00 | 044 | 0 |
| Douchewanden | closetcombinatie 54 diepspoel PK | | | | | | | |
| | 0082534 | | wit | KLOSETKOMB.54 DIEPSPPKW | stuk | 385,00 | 044 | 0 |
| | 0082535 | | pergamon | KLOSETKOMB.54 DIEPSPPKP | stuk | 493,00 | 044 | 0 |
| Toebehoren & afvoeren | wandclosetpot 22 diepspoel | | | | | | | |
| | 0082280 | | wit | S8200100000 | stuk | 176,00 | 044 | 0 |
| | 0082282 | | pergamon | S8200100030 | stuk | 232,00 | 044 | 0 |
| | 0082281 | m. ceraTect | wit | S8200100001 | stuk | 257,00 | 044 | 0 |
| Spoel- & installatiesystemen | 0082283 | m. ceraTect | pergamon | S8200100031 | stuk | 313,00 | 044 | 1 |
| | wandclosetpot 12 vlakspoel | | | | | | | |
| Badkamermeubelen en toiletkasten | 0082354 | | wit | S8200200000 | stuk | 225,00 | 044 | 0 |
| | 0082355 | | pergamon | S8200200030 | stuk | 282,00 | 044 | 0 |
| | 0082418 | m. ceraTect | wit | S8200200001 | stuk | 305,00 | 044 | 1 |
| | 0082357 | m. ceraTect | pergamon | S8200200031 | stuk | 362,00 | 044 | 1 |
| Gootstenen en wastroggen | wandclosetpot 48 vlakspoel | | | | | | | |
| | 0082461 | | wit | S8200900000 | stuk | 225,00 | 044 | 1 |
| Utiliteit | 0082463 | | pergamon | S8200900030 | stuk | 282,00 | 044 | 1 |
| | 0082462 | m. ceraTect | wit | S8200900001 | stuk | 305,00 | 044 | 1 |
| | 0082464 | m. ceraTect | pergamon | S8200900031 | stuk | 362,00 | 044 | 1 |
| | wandclosetpot diepspoel +5cm | | | | | | | |
| | 0082483 | | wit | S8201200000 | stuk | 375,00 | 044 | 1 |
| | 0082485 | | pergamon | S8201200030 | stuk | 468,00 | 044 | 1 |
| | 0082484 | m. ceraTect | wit | S8201200001 | stuk | 455,00 | 044 | 1 |
| | 0082486 | m. ceraTect | pergamon | S8201200031 | stuk | 548,00 | 044 | 1 |
| | closetzitting dubbel | | | | | | | |
| | 0082295 | | wit | S8H50400000 | stuk | 30,00 | 044 | 0 |
| | 0082296 | | pergamon | S8H50400030 | stuk | 38,00 | 044 | 0 |

| Art.nr | Specificaties | Kleur | Lev.nr | Ehd | Prijs | Grp | CC |
|--------|---------------|-------|--------|-----|-------|-----|----|
|--------|---------------|-------|--------|-----|-------|-----|----|

Sphinx 300 [New Eurobase]

closetzitting enkel

| | | | | | | | |
|---------|--|----------|-------------|------|-------|-----|---|
| 0082297 | | wit | S8H50405000 | stuk | 24,50 | 044 | 0 |
| 0082298 | | pergamon | S8H50405030 | stuk | 30,00 | 044 | 1 |



Sanitair producten

Baden /
douchebakken /
stoomcabines

urinoir-80 achterinlaat m. bevestigingsset

| | | | | | | | |
|---------|----------|----------|-------------|------|--------|-----|---|
| 0201140 | | wit | S8600400000 | stuk | 218,00 | 044 | 0 |
| 0201141 | | pergamon | S8600400030 | stuk | 313,00 | 044 | 1 |
| 0201142 | m. vlieg | wit | S8600401000 | stuk | 266,00 | 044 | 1 |
| 0201143 | m. vlieg | pergamon | S8600401030 | stuk | 325,00 | 044 | 1 |

Kranen

urinoir-85 boveninlaat m. bevestigingsset

| | | | | | | | |
|---------|----------|----------|-------------|------|--------|-----|---|
| 0201144 | | wit | S8600300000 | stuk | 218,00 | 044 | 0 |
| 0201145 | | pergamon | S8600300030 | stuk | 313,00 | 044 | 1 |
| 0201148 | m. vlieg | wit | S8600301000 | stuk | 266,00 | 044 | 1 |
| 0201149 | m. vlieg | pergamon | S8600301030 | stuk | 325,00 | 044 | 1 |

Douchegarnituur

Sphinx Eurobase

closetpot-95 vlakspoel A0

| | | | | | | | |
|---------|---------------------------|----------|-------------|------|--------|-----|---|
| 0201871 | | wit | S8081000000 | stuk | 115,00 | 044 | 1 |
| 0216496 | | pergamon | S8081000030 | stuk | 160,00 | 044 | 1 |
| 0830453 | set potschroeven 5.5x60mm | chrom | 0830453 | stuk | 2,28 | 362 | 0 |

Accessoires en
spiegels

Douchewanden

closetpot-95 vlakspoel PK

| | | | | | | | |
|---------|---------------------------|----------|-------------|------|--------|-----|---|
| 0201898 | | wit | S8082000000 | stuk | 113,00 | 044 | 1 |
| 0216368 | | pergamon | S8082000030 | stuk | 158,00 | 044 | 1 |
| 0830453 | set potschroeven 5.5x60mm | chrom | 0830453 | stuk | 2,28 | 362 | 0 |

Toebehoren &
afvoeren

closetzitting enkel

| | | | | | | | |
|---------|--|----------|-------------|------|-------|-----|---|
| 0202096 | | wit | S8H5E001000 | stuk | 19,00 | 044 | 1 |
| 0217409 | | pergamon | S8H5E001030 | stuk | 23,00 | 044 | 1 |

Spoel- &
installatiesystemen

closetzitting dubbel

| | | | | | | | |
|---------|--|----------|-------------|------|-------|-----|---|
| 0202053 | | wit | S8H5C001000 | stuk | 30,00 | 044 | 1 |
| 0217352 | | pergamon | S8H5C001030 | stuk | 35,00 | 044 | 1 |

Badkamermeubelen
en toiletkastenGootstenen en
wastroggen

closetzitting dubbel voor wandpot en duoblok

| | | | | | | | |
|---------|--|----------|-------------|------|-------|-----|---|
| 0202150 | | wit | S8H5D001000 | stuk | 34,00 | 044 | 1 |
| 0217468 | | pergamon | S8H5D001030 | stuk | 39,00 | 044 | 0 |



Utiliteit

ophanghaak voor wandurinoir-55

| | | | | | | | |
|---------|--|--|-----------|------|------|-----|---|
| 0200867 | | | S8H787000 | stuk | 6,80 | 043 | 1 |
|---------|--|--|-----------|------|------|-----|---|

wandurinoir-70 achterinlaat m. bevestigingsset

| | | | | | | | |
|---------|-------------|----------|-------------|------|--------|-----|---|
| 0201936 | | wit | S8600100000 | stuk | 196,00 | 044 | 0 |
| 0216666 | | pergamon | S8600100030 | stuk | 291,00 | 044 | 1 |
| 0200231 | m. ceraTect | wit | S8600100001 | stuk | 276,00 | 044 | 1 |

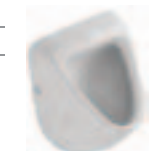

wandurinoir-70 achterinlaat m. bevestigingsset en vlieg







| | | | | | | | |
|---------|-------------|-----|-------------|------|--------|-----|---|
| 0201960 | | wit | S8600101000 | stuk | 245,00 | 044 | 0 |
| 0200232 | m. ceraTect | wit | S8600101001 | stuk | 326,00 | 044 | 1 |

wandurinoir-75 boveninlaat m. bevestigingsset

| | | | | | | | |
|---------|-------------|----------|-------------|------|--------|-----|---|
| 0201952 | | wit | S8600200000 | stuk | 196,00 | 044 | 0 |
| 0216704 | | pergamon | S8600200030 | stuk | 291,00 | 044 | 0 |
| 0200233 | m. ceraTect | wit | S8600200001 | stuk | 276,00 | 044 | 1 |

wandurinoir-75 boveninlaat m. bevestigingsset en vlieg

| | | | | | | | |
|---------|-------------|-----|-------------|------|--------|-----|---|
| 0201979 | | wit | S8600201000 | stuk | 245,00 | 044 | 0 |
| 0200234 | m. ceraTect | wit | S8600201001 | stuk | 326,00 | 044 | 1 |

| | Art.nr | Specificaties | Kleur | Lev.nr | Ehd | Prijs | Grp | CC | |
|---|---|---------------------------------------|-------------|-----------------|-------------|-------------|---------|--------|-----|
| Sanitair producten | Sphinx Milano | | | | | | | | |
| | wandclosetpot-34 diepspoel | | | | | | | | |
| | 0200697 | | wit | S8204010000 | stuk | 215,00 | 043 | 0 | |
| | 0211028 | | pergamon | S8204010030 | stuk | 268,00 | 043 | 0 | |
| | 0200193 | m. Ceratect | wit | S8204010001 | stuk | 296,00 | 043 | 1 | |
| | 0200194 | m. Ceratect | pergamon | S8204010031 | stuk | 349,00 | 043 | 1 | |
| Baden / douchebakken / stoomcabines | Sphinx Mycene | | | | | | | | |
| Kranen | wastafel | | | | | | | | |
| |  | 0237515 | 70x55cm | wit | S8363000000 | stuk | 550,00 | 042 | 1 |
| | | 0235314 | 70x55cm | m. 3 kraangaten | wit | S8363110000 | stuk | 550,00 | 043 |
| | 0830097 | bevestigingsset M10x110mm | | | 0830097 | paar | 1,09 | 362 | 0 |
| Douchegarnituur | zuil voor wastafel | | | | | | | | |
| | 0237884 | | wit | S8703000000 | stuk | 317,00 | 042 | 1 | |
| Accessoires en spiegels | verhogingselement voor zuil | | | | | | | | |
| | | 0237892 | | wit | S8834000000 | stuk | 112,00 | 042 | 1 |
| Douchewanden | planchet | | | | | | | | |
| |  | 0237841 | 60x16cm | wit | S8814000000 | stuk | 143,00 | 042 | 1 |
| | 0830453 | set potschroeven 5.5x60mm chroom | | | 0830453 | stuk | 2,28 | 362 | 0 |
| Toebehoren & afvoeren | fontein | | | | | | | | |
| |  | 0237701 | 45.5x37.5cm | wit | S8408000000 | stuk | 308,00 | 042 | 1 |
| | 0830097 | bevestigingsset M10x110mm | | | 0830097 | paar | 1,09 | 362 | 0 |
| Spoel- & installatiesystemen | staand bidet | | | | | | | | |
| |  | 0217948 | | wit | S8914000000 | stuk | 579,00 | 042 | 1 |
| | 0830453 | set potschroeven 5.5x60mm chroom | | | 0830453 | stuk | 2,28 | 362 | 0 |
| Badkamermeubelen en toiletkasten | wandclosetpot diepspoel | | | | | | | | |
| | 0238049 | | wit | S8209000000 | stuk | 674,00 | 042 | 1 | |
| Gootstenen en wastroggen | closetcombinatie diepspoel PKV | | | | | | | | |
| |  | 0218022 | | wit | S8107990000 | stuk | 1280,00 | 042 | 1 |
| | 0202223 | bocht kunststof universeel AO-uitlaat | | | S8H782000 | stuk | 21,50 | 042 | 0 |
| | 0830453 | set potschroeven 5.5x60mm chroom | | | 0830453 | stuk | 2,28 | 362 | 0 |
| Utiliteit | closetzitting dubbel | | | | | | | | |
| |  | 0218073 | | wit | S8H5800R000 | stuk | 172,00 | 042 | 1 |
| | Sphinx Universeel | | | | | | | | |
| Gootstenen en wastroggen | wandclosetpot-48 diepspoel | | | | | | | | |
| |  | 0218229 | | wit | S8218000000 | stuk | 204,00 | 044 | 0 |
| | | 0218232 | | pergamon | S8218000030 | stuk | 255,00 | 044 | 0 |
| | | 0200188 | m. Ceratect | wit | S8218000001 | stuk | 284,00 | 043 | 1 |
| | | 0200189 | m. Ceratect | pergamon | S8218000031 | stuk | 335,00 | 043 | 1 |

| Art.nr | Specificaties | Kleur | Lev.nr | Ehd | Prijs | Grp | CC |
|--------|---------------|-------|--------|-----|-------|-----|----|
|--------|---------------|-------|--------|-----|-------|-----|----|

Sphinx Universeel

closetzitting dubbel-48

| | | | | | | | |
|---------|--|----------|-------------|------|-------|-----|---|
| 0218226 | | wit | S8H5T001000 | stuk | 82,00 | 044 | 0 |
| 0218231 | | pergamon | S8H5T001030 | stuk | 82,00 | 044 | 0 |



Sanitair producten

verhoogde duoblokpot diepspoel PK +6cm z. reservoir

| | | | | | | | |
|---------|-------------|----------|-------------|------|--------|-----|---|
| 0226614 | | wit | S8160000000 | stuk | 423,00 | 042 | 1 |
| 0226618 | | pergamon | S8160000030 | stuk | 529,00 | 042 | 1 |
| 0200118 | m. CeraTect | wit | S8160000001 | stuk | 503,00 | 042 | 1 |
| 0200119 | m. CeraTect | pergamon | S8160000031 | stuk | 609,00 | 042 | 1 |

Baden /
douchebakken /
stoomcabines

wandcloset verlengd 70cm

| | | | | | | | |
|---------|--|----------|-------------|------|--------|-----|---|
| 0225533 | | wit | S8252000000 | stuk | 414,00 | 042 | 0 |
| 0225541 | | pergamon | S8252000030 | stuk | 517,00 | 042 | 1 |



Kranen

Douchegarnituur

closetzitting dubbel m. rvs garnituur

| | | | | | | | |
|---------|--|----------|-------------|------|-------|-----|---|
| 0225568 | | wit | S8H5T000000 | stuk | 80,00 | 042 | 1 |
| 0225576 | | pergamon | S8H5T000030 | stuk | 80,00 | 042 | 1 |

Accessoires en
spiegels

afvoerelement voor watervrij urinoir

| | | | | | | | |
|---------|--|-----|-----------|------|--------|-----|---|
| 0226122 | | RVS | S8H887000 | stuk | 673,00 | 043 | 1 |
|---------|--|-----|-----------|------|--------|-----|---|

Douchewanden

vuilvangrooster voor watervrij urinoir

| | | | | | | | |
|---------|--|--|-----------|------|-------|-----|---|
| 0226130 | | | S8H699000 | stuk | 28,25 | 043 | 1 |
|---------|--|--|-----------|------|-------|-----|---|

Toebehoren &
afvoeren

rubberklep voor watervrij urinoir

| | | | | | | | |
|---------|--|--|-----------|------|-------|-----|---|
| 0226114 | | | S8H890000 | stuk | 39,50 | 043 | 1 |
|---------|--|--|-----------|------|-------|-----|---|

Spoel- &
installatiesystemen

Sphinx Punto

wastafel opbouw

| | | | | | | | |
|---------|------|-----|-------------|------|--------|-----|---|
| 0200104 | 45cm | wit | S8W71000000 | stuk | 304,00 | 042 | 1 |
|---------|------|-----|-------------|------|--------|-----|---|

Badkamermeubelen
en toiletkasten

Sphinx Quadro

wastafel opbouw









| | | | | | | | |
|---------|---------|-------------|-------------|------|--------|-----|---|
| 0200106 | 50x32cm | wit | S8W70000000 | stuk | 315,00 | 042 | 1 |
| 0200114 | 50x32cm | m. CeraTect | S8W70000001 | stuk | 396,00 | 042 | 1 |

Gootstenen en
wastroggen

Sphinx onderdelen closetzittingen

| | | | | | | | |
|---------|-------------------------------------|-----------------|-----------|------|-------|-----|---|
| 0220062 | set scharnieren voor closetzitting | Atlantic chroom | S8H913000 | stuk | 25,00 | 044 | 1 |
| 0220066 | set scharnieren voor closetzitting | Mycene RVS | S8H95100R | stuk | 25,00 | 044 | 1 |
| 0220072 | set scharnieren voor closetzitting | 340 RVS | S8H95600R | stuk | 25,00 | 044 | 1 |
| 0220078 | set scharnieren voor closetzitting | 420 RVS | S8H95900R | stuk | 25,00 | 044 | 1 |
| 0220076 | set scharnieren voor closetzitting | 450 RVS | S8H95800R | stuk | 25,00 | 044 | 1 |
| 0221019 | set buffers rond voor closetzitting | | S8H908000 | stuk | 5,70 | 043 | 0 |
| 0220054 | bufferset rond closetzitting | Atlantic | S8H906000 | stuk | 5,70 | 044 | 1 |
| 0220060 | bufferset rond closetzitting | Mycene | S8H918000 | stuk | 5,70 | 044 | 1 |
| 0220052 | bufferset ovaal closetzitting | Atlantic | S8H905000 | stuk | 5,70 | 044 | 1 |
| 0220058 | bufferset ovaal closetzitting | Mycene | S8H917000 | stuk | 5,70 | 044 | 1 |

Utiliteit

| | Art.nr | Specificaties | Kleur | Lev.nr | Ehd | Prijs | Grp | CC |
|---|---|----------------------------------|----------------------------------|----------|----------|--------|--------|-------|
| Sanitair producten | Venlo Nimbus | | | | | | | |
| | wastafel | | | | | | | |
| |  | 0425402 | 55cm | wit | H3063B04 | stuk | 64,50 | 044 1 |
| | | 0425510 | 55cm | pergamon | H3063P04 | stuk | 74,00 | 044 1 |
| | | 0425435 | 60x46cm | wit | H3063B02 | stuk | 61,50 | 044 1 |
| Baden / douchebakken / stoomcabines | | 0425509 | 60x46cm | pergamon | H3063P02 | stuk | 70,50 | 044 1 |
| | | 0830097 | bevestigingsset M10x110mm | | 0830097 | paar | 1,09 | 362 0 |
| Kranen | sifonkap voor wastafel | | | | | | | |
| |  | 0425516 | | wit | H3069B02 | stuk | 81,00 | 044 1 |
| | | 0425511 | | pergamon | H3069P02 | stuk | 93,00 | 044 1 |
| Douchegarnituur | | 0830453 | set potschroeven 5.5x60mm chroom | | 0830453 | stuk | 2,28 | 362 0 |
| | fontein | | | | | | | |
| Accessoires en spiegels |  | 0425443 | 35cm | wit | H3063B01 | stuk | 33,25 | 044 0 |
| | | 0425514 | 35cm | pergamon | H3063P01 | stuk | 38,25 | 044 1 |
| Douchewanden | hoekfontein | | | | | | | |
| | | 0425404 | 47x35cm | wit | H3063B03 | stuk | 62,00 | 044 1 |
| | | 0425515 | 47x35cm | pergamon | H3063P03 | stuk | 71,50 | 044 1 |
| Toebehoren & afvoeren | planchet | | | | | | | |
| |  | 0425403 | 50cm | wit | H3062B02 | stuk | 34,75 | 044 1 |
| | | 0425513 | 50cm | pergamon | H3062P02 | stuk | 40,00 | 044 1 |
| | | 0425524 | 60x14cm | wit | H3062B01 | stuk | 43,50 | 044 0 |
| Spoel- & installatiesystemen | | 0425512 | 60x14cm | pergamon | H3062P01 | stuk | 50,50 | 044 1 |
| | | 0830453 | set potschroeven 5.5x60mm chroom | | 0830453 | stuk | 2,28 | 362 0 |
| | closetpot vlakspoel PK | | | | | | | |
| Badkamermeubelen en toiletkasten |  | 0425451 | | wit | H3064B01 | stuk | 79,00 | 044 1 |
| | | 0425517 | | pergamon | H3064P01 | stuk | 91,00 | 044 1 |
| | | 0830453 | set potschroeven 5.5x60mm chroom | | 0830453 | stuk | 2,28 | 362 0 |
| Gootstenen en wastroggen | closetpot vlakspoel AO | | | | | | | |
| |  | 0425478 | | wit | H3064B02 | stuk | 80,50 | 044 1 |
| | | 0425518 | | pergamon | H3064P02 | stuk | 92,50 | 044 1 |
| Utiliteit | | 0830453 | set potschroeven 5.5x60mm chroom | | 0830453 | stuk | 2,28 | 362 0 |
| | closetcombinatie diepspoel PK | | | | | | | |
| |  | 0425486 | | wit | H3064B03 | stuk | 279,00 | 044 1 |
| | 0425519 | | pergamon | H3064P03 | stuk | 321,00 | 044 1 | |
| | 0830453 | set potschroeven 5.5x60mm chroom | | 0830453 | stuk | 2,28 | 362 0 | |
| closetcombinatie diepspoel AO | | | | | | | | |
|  | 0425494 | | wit | H3064B05 | stuk | 284,00 | 044 0 | |
| | 0425520 | | pergamon | H3064P05 | stuk | 326,00 | 044 1 | |
| | 0830453 | set potschroeven 5.5x60mm chroom | | 0830453 | stuk | 2,28 | 362 0 | |
| verhoogde closetpot +6 PK | | | | | | | | |
| | 0425405 | | wit | H3064B08 | stuk | 115,00 | 044 1 | |
| | 0425522 | | pergamon | H3064P08 | stuk | 132,00 | 044 1 | |
| verhoogde closetpot +6 AO | | | | | | | | |
| | 0425406 | | wit | H3064B09 | stuk | 130,00 | 044 1 | |
| | 0425523 | | pergamon | H3064P09 | stuk | 149,00 | 044 1 | |

| Art.nr | Specificaties | Kleur | Lev.nr | Ehd | Prijs | Grp | CC |
|--|---------------|----------|----------|------|--------|-----|----|
| Venlo Nimbus | | | | | | | |
| wandclosetpot diepspoel | | | | | | | |
| 0425508 | | wit | H3064B07 | stuk | 120,00 | 044 | 0 |
| 0425521 | | pergamon | H3064P07 | stuk | 138,00 | 044 | 1 |
| closetzitting dubbel antibacterieel | | | | | | | |
| 0425533 | | wit | H3069B05 | stuk | 31,25 | 044 | 1 |
| 0425525 | | pergamon | H3069P03 | stuk | 36,00 | 044 | 1 |



- Sanitair producten
- Baden /
douchebakken /
stoomcabines
- Kranen
- Douchegarnituur
- Accessoires en
spiegels
- Douchewanden
- Toebehoren &
afvoeren
- Spoel- &
installatiesystemen
- Badkamermeubelen
en toiletkasten
- Gootstenen en
wastroggen
- Utiliteit

| | Art.nr | Specificaties | Kleur | Lev.nr | Ehd | Prijs | Grp | CC |
|---|--|----------------------------------|--------------------------------------|----------|----------|--------|--------|-------|
| Sanitair producten | Villeroy & Boch Amadea | | | | | | | |
| | wastafel v. vrijstaande montage | | | | | | | |
| | | 0120457 | 76x57cm m. 1 kraangat ceramic+ | wit | 718575R1 | stuk | 741,00 | 052 1 |
| | | 0140783 | 76x57cm m.3-kraangaten ceramic+ | wit | 7185A1R1 | stuk | 741,00 | 052 1 |
| | 0140791 | 76x57cm m. 3-kraangaten ceramic+ | pergamon | 7185A1R3 | stuk | 741,00 | 052 1 | |
| Baden / douchebakken / stoomcabines | wastafel | | | | | | | |
| | | 0100109 | 76x57cm 1-kraangat ceramic+ | wit | 7A8575R1 | stuk | 777,00 | 052 1 |
| | | 0100111 | 76x57cm 1-kraangat ceramic+ | pergamon | 7A8575R3 | stuk | 777,00 | 052 1 |
| | | 0100112 | 76x57cm 3-kraangaten ceramic+ | wit | 7A85A1R1 | stuk | 777,00 | 052 1 |
| | | 0100113 | 76x57cm 3-kraangaten ceramic+ | pergamon | 7A85A1R3 | stuk | 777,00 | 052 1 |
| | | 0830097 | bevestigingsset M10x110mm | | 0830097 | paar | 1,09 | 362 0 |
| Kranen | sifonkap voor wastafel m. bevestiging | | | | | | | |
| | | 0131258 | ceramic+ | wit | 728400R1 | stuk | 327,00 | 052 1 |
| | | 0131329 | ceramic+ | pergamon | 728400R3 | stuk | 327,00 | 052 1 |
| Douchegarnituur | zuil voor wastafel | | | | | | | |
| | | 0131351 | ceramic+ | wit | 728500R1 | stuk | 466,00 | 052 1 |
| | | 0131328 | ceramic+ | pergamon | 728500R3 | stuk | 466,00 | 052 1 |
| | | 0102281 | montageset voor toe/afvoer zuil | | 87270000 | stuk | 190,00 | 052 1 |
| Accessoires en spiegels | spiegel ovaal | | | | | | | |
| | | 1023874 | 57.5x90cm | | 86430000 | stuk | 272,00 | 323 1 |
| Douchewanden | fontein | | | | | | | |
| | | 0105759 | 50x41cm ceramic+ | wit | 738550R1 | stuk | 475,00 | 052 1 |
| Toebehoren & afvoeren | | 0105767 | 50x41cm ceramic+ | pergamon | 738550R3 | stuk | 475,00 | 052 1 |
| | | 0140821 | 50x41cm voor 3-gats kraan ceramic+ | wit | 7385A1R1 | stuk | 475,00 | 052 1 |
| | | 0140848 | 50x41cm voor 3-gats kraan ceramic+ | pergamon | 7385A1R3 | stuk | 475,00 | 052 1 |
| | | 0830240 | bevestigingsset voor fontein M8x90mm | | 0830240 | stuk | 0,85 | 362 0 |
| | Badkamermeubelen en toiletkasten | sifonkap voor fontein | | | | | | |
| | | 0129876 | ceramic+ | wit | 721500R1 | stuk | 312,00 | 052 1 |
| | | 0129873 | ceramic+ | pergamon | 721500R3 | stuk | 312,00 | 052 1 |
| Gootstenen en wastroggen | planchet | | | | | | | |
| | | 0121193 | 50x17cm ceramic+ | wit | 788561R1 | stuk | 228,00 | 052 1 |
| | | 0121207 | 50x17cm ceramic+ | pergamon | 788561R3 | stuk | 228,00 | 052 1 |
| | | 0101215 | 70x18cm ceramic+ | wit | 788761R1 | stuk | 272,00 | 052 1 |
| | | 0103706 | 70x18cm ceramic+ | pergamon | 788761R3 | stuk | 272,00 | 052 1 |
| Utiliteit | staand bidet | | | | | | | |
| | | 0105775 | ceramic+ | wit | 748500R1 | stuk | 861,00 | 052 1 |
| | | 0105783 | ceramic+ | pergamon | 748500R3 | stuk | 861,00 | 052 1 |
| | | 0140910 | voor 3-gats kraan ceramic+ | wit | 7485A1R1 | stuk | 861,00 | 052 1 |
| | | 0140929 | voor 3-gats kraan ceramic+ | pergamon | 7485A1R3 | stuk | 861,00 | 052 1 |
| Utiliteit | wandbidet m. overloop voor 1-gats kraan | | | | | | | |
| | | 0100114 | ceramic+ | wit | 7E86B0R1 | stuk | 905,00 | 052 1 |
| | | 0100115 | ceramic+ | pergamon | 7E86B0R3 | stuk | 905,00 | 052 1 |
| Utiliteit | wandbidet m. overloop voor 3-gats kraan | | | | | | | |
| | | 0100116 | ceramic+ | wit | 7E86B1R1 | stuk | 905,00 | 052 1 |
| | | 0100117 | ceramic+ | pergamon | 7E86B1R3 | stuk | 905,00 | 052 1 |
| Utiliteit | sifon voor bidet m. verlengde muurbuis | | | | | | | |
| | | 0100119 | | | 92087200 | stuk | 44,00 | 052 1 |

| Art.nr | Specificaties | Kleur | Lev.nr | Ehd | Prijs | Grp | CC |
|--------|---------------|-------|--------|-----|-------|-----|----|
|--------|---------------|-------|--------|-----|-------|-----|----|

Villeroy & Boch Amadea

wandclosetpot diepspoel

| | | | | | | | |
|---------|----------|----------|----------|------|---------|-----|---|
| 0100120 | ceramic+ | wit | 7C96B0R1 | stuk | 1034,00 | 052 | 1 |
| 0100121 | ceramic+ | pergamon | 7C96B0R3 | stuk | 1034,00 | 052 | 1 |



Sanitair producten

closetcombinatie diepspoel

| | | | | | | | |
|---------|-----------------------------|-----------|----------|------|---------|-----|---|
| 0108871 | ceramic+ | wit | AMADEA | stuk | 1440,00 | 052 | 1 |
| 0108855 | ceramic+ | pergamon | AMADEA | stuk | 1440,00 | 052 | 1 |
| 0102221 | vario afvoerbocht verticaal | 160-250mm | 87010000 | stuk | 68,00 | 052 | 0 |
| 0102225 | vario afvoerbocht verticaal | 70-160mm | 87110000 | stuk | 68,00 | 052 | 1 |

Baden /
douchebakken /
stoomcabines

Kranen

duoblokpot diepspoel z. reservoir

| | | | | | | | |
|---------|----------|----------|----------|------|--------|-----|---|
| 0114427 | ceramic+ | wit | 769510R1 | stuk | 962,00 | 052 | 1 |
| 0108863 | ceramic+ | pergamon | 769510R3 | stuk | 962,00 | 052 | 1 |

Douchegarnituur

closetzitting dubbel

| | | | | | | | |
|---------|--|----------|----------|------|--------|-----|---|
| 0102818 | | wit | 88106101 | stuk | 173,00 | 052 | 1 |
| 0102807 | | pergamon | 88106109 | stuk | 192,00 | 052 | 1 |

Accessoires en
spiegels**montageset voor toe/afvoer zuil**

| | | | | | | | |
|---------|--|--|----------|------|--------|-----|---|
| 0102281 | | | 87270000 | stuk | 190,00 | 052 | 1 |
|---------|--|--|----------|------|--------|-----|---|

Douchewanden

Villeroy & Boch Arriba

wastafel

| | | | | | | | | |
|---------|---------------------------|----------|----------|----------|--------|--------|-----|---|
| 0120596 | 55x45cm | wit | 71665501 | stuk | 200,00 | 052 | 1 | |
| 0120634 | 55x45cm | pergamon | 71665509 | stuk | 239,00 | 052 | 1 | |
| 0105864 | 55x45cm | ceramic+ | wit | 716655R1 | stuk | 263,00 | 052 | 1 |
| 0120636 | 55x45cm | ceramic+ | pergamon | 716655R3 | stuk | 302,00 | 052 | 1 |
| 0120561 | 60x49cm | wit | 71666001 | stuk | 179,00 | 052 | 1 | |
| 0120588 | 60x49cm | pergamon | 71666009 | stuk | 215,00 | 052 | 1 | |
| 0120563 | 60x48cm | ceramic+ | wit | 716660R1 | stuk | 242,00 | 052 | 1 |
| 0100016 | 60x48cm | ceramic+ | pergamon | 716660R3 | stuk | 278,00 | 052 | 1 |
| 0120545 | 65x52cm | wit | 71666501 | stuk | 209,00 | 052 | 1 | |
| 0120553 | 65x52cm | pergamon | 71666509 | stuk | 251,00 | 052 | 1 | |
| 0105910 | 65x52cm | ceramic+ | wit | 716665R1 | stuk | 272,00 | 052 | 1 |
| 0120555 | 65x52cm | ceramic+ | pergamon | 716665R3 | stuk | 314,00 | 052 | 1 |
| 0120576 | 70x55cm | wit | 71667001 | stuk | 272,00 | 052 | 1 | |
| 0120574 | 70x55cm | pergamon | 71667009 | stuk | 327,00 | 052 | 1 | |
| 0120578 | 70x55cm | ceramic+ | wit | 716670R1 | stuk | 335,00 | 052 | 1 |
| 0105953 | 70x55cm | ceramic+ | pergamon | 716670R3 | stuk | 390,00 | 052 | 1 |
| 0830097 | bevestigingsset M10x110mm | | 0830097 | paar | 1,09 | 362 | 0 | |

Toebehoren &
afvoerenSpoel- &
installatiesystemenBadkamermeubelen
en toiletkastenGootstenen en
wastroggen**sifonkap voor wastafel**

| | | | | | | | |
|---------|--|----------|----------|------|--------|-----|---|
| 0120677 | | wit | 72070001 | stuk | 141,00 | 052 | 1 |
| 0120685 | | pergamon | 72070009 | stuk | 169,00 | 052 | 1 |



Utiliteit

zuil voor wastafel

| | | | | | | | |
|---------|--|----------|----------|------|--------|-----|---|
| 0120693 | | wit | 72060001 | stuk | 192,00 | 052 | 1 |
| 0120707 | | pergamon | 72060009 | stuk | 232,00 | 052 | 1 |

**planchet**

| | | | | | | | |
|---------|---------------------------|----------|----------|------|--------|-----|---|
| 0120812 | 55x18cm | wit | 78665501 | stuk | 97,00 | 052 | 1 |
| 0120820 | 55x18cm | pergamon | 78665509 | stuk | 118,00 | 052 | 1 |
| 0120782 | 60x19cm | wit | 78666001 | stuk | 106,00 | 052 | 1 |
| 0120790 | 60x19cm | pergamon | 78666009 | stuk | 129,00 | 052 | 1 |
| 0830453 | set potschroeven 5.5x60mm | chroom | 0830453 | stuk | 2,28 | 362 | 0 |



| Art.nr | Specificaties | Kleur | Lev.nr | Ehd | Prijs | Grp | CC |
|--------|---------------|-------|--------|-----|-------|-----|----|
|--------|---------------|-------|--------|-----|-------|-----|----|

Villeroy & Boch Arriba

fontein



| | | | | | | | |
|---------|--------------------------------------|----------|----------|------|--------|-----|---|
| 0120723 | 45x35cm | wit | 73664501 | stuk | 122,00 | 052 | 1 |
| 0120731 | 45x35cm | pergamon | 73664509 | stuk | 146,00 | 052 | 1 |
| 0105961 | 45x35cm ceramic+ | wit | 736645R1 | stuk | 185,00 | 052 | 1 |
| 0120456 | 45x35cm ceramic+ | pergamon | 736645R3 | stuk | 209,00 | 052 | 1 |
| 0830240 | bevestigingsset voor fontein M8x90mm | | 0830240 | stuk | 0,85 | 362 | 0 |

sifonkap voor fontein

| | | | | | | | |
|---------|--|----------|----------|------|--------|-----|---|
| 0120758 | | wit | 72080001 | stuk | 141,00 | 052 | 1 |
| 0120774 | | pergamon | 72080009 | stuk | 169,00 | 052 | 1 |

staand bidet



| | | | | | | | |
|---------|----------|----------|----------|------|--------|-----|---|
| 0121002 | | wit | 74670001 | stuk | 262,00 | 052 | 1 |
| 0121010 | | pergamon | 74670009 | stuk | 315,00 | 052 | 1 |
| 0105996 | ceramic+ | wit | 746700R1 | stuk | 325,00 | 052 | 1 |
| 0108685 | ceramic+ | pergamon | 746700R3 | stuk | 378,00 | 052 | 1 |

wandbidet



| | | | | | | | |
|---------|----------|----------|----------|------|--------|-----|---|
| 0120979 | | wit | 74660001 | stuk | 361,00 | 052 | 1 |
| 0120995 | | pergamon | 74660009 | stuk | 433,00 | 052 | 1 |
| 0106038 | ceramic+ | wit | 746600R1 | stuk | 424,00 | 052 | 1 |
| 0128686 | ceramic+ | pergamon | 746600R3 | stuk | 496,00 | 052 | 1 |

wandclosetpot diepspoel



| | | | | | | | |
|---------|----------|----------|----------|------|--------|-----|---|
| 0120839 | | wit | 76031001 | stuk | 257,00 | 052 | 0 |
| 0120847 | | pergamon | 76031009 | stuk | 308,00 | 052 | 0 |
| 0120849 | ceramic+ | wit | 760310R1 | stuk | 320,00 | 052 | 1 |
| 0100019 | ceramic+ | pergamon | 760310R3 | stuk | 371,00 | 052 | 1 |

closetcombinatie diepspoel



| | | | | | | | |
|---------|---------------------------------------|----------|----------|------|--------|-----|---|
| 0120936 | | wit | ARRIBA | stuk | 473,00 | 052 | 0 |
| 0120944 | | pergamon | ARRIBA | stuk | 546,00 | 052 | 1 |
| 0108928 | ceramic+ | wit | ARRIBA | stuk | 536,00 | 052 | 1 |
| 0108936 | ceramic+ | pergamon | ARRIBA | stuk | 609,00 | 052 | 1 |
| 0102221 | vario afvoerbocht verticaal 160-250mm | | 87010000 | stuk | 68,00 | 052 | 0 |
| 0102225 | vario afvoerbocht verticaal 70-160mm | | 87110000 | stuk | 68,00 | 052 | 1 |

closetzitting dubbel

| | | | | | | | |
|---------|--|----------|----------|------|--------|-----|---|
| 0120952 | | wit | 88266101 | stuk | 118,00 | 052 | 0 |
| 0120960 | | pergamon | 88266109 | stuk | 131,00 | 052 | 0 |

duoblokpot diepspoel z. reservoir

| | | | | | | | |
|---------|----------|----------|----------|------|--------|-----|---|
| 0120855 | | wit | 76111001 | stuk | 243,00 | 052 | 1 |
| 0120863 | | pergamon | 76111009 | stuk | 293,00 | 052 | 1 |
| 0108898 | ceramic+ | wit | 761110R1 | stuk | 306,00 | 052 | 1 |
| 0108901 | ceramic+ | pergamon | 761110R3 | stuk | 356,00 | 052 | 1 |

duoblokreervoir + binnenwerk

| | | | | | | | |
|---------|--|----------|----------|------|--------|-----|---|
| 0120901 | | wit | 77111101 | stuk | 230,00 | 052 | 1 |
| 0120928 | | pergamon | 77111109 | stuk | 253,00 | 052 | 1 |

urinoir voor deksel

| | | | | | | | |
|---------|--|----------|----------|------|--------|-----|---|
| 0120625 | | wit | 75660101 | stuk | 367,00 | 052 | 1 |
| 0120805 | | pergamon | 75660109 | stuk | 441,00 | 052 | 1 |

deksel voor urinoir







| | | | | | | | |
|---------|--|----------|----------|------|--------|-----|---|
| 0120626 | | wit | 88286101 | stuk | 118,00 | 052 | 1 |
| 0120627 | | pergamon | 88286109 | stuk | 131,00 | 052 | 1 |

Villeroy & Boch Aveo



wastafel

| | | | | | | | |
|---------|---------------------------------|------------|----------|------|--------|-----|---|
| 0123236 | 60x51cm ceramic+ | wit | 713260R1 | stuk | 620,00 | 272 | 1 |
| 0123237 | 60x51cm ceramic+ m. active care | star white | 713260R2 | stuk | 619,00 | 272 | 1 |
| 0123224 | 70x51cm ceramic+ | wit | 713270R1 | stuk | 804,00 | 272 | 1 |
| 0123225 | 70x51cm ceramic+ m. active care | star white | 713270R2 | stuk | 804,00 | 272 | 1 |
| 0830097 | bevestigingsset M10x110mm | | 0830097 | paar | 1,09 | 362 | 0 |

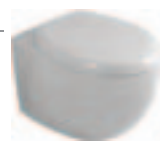
| Art.nr | Specificaties | Kleur | Lev.nr | Ehd | Prijs | Grp | CC | |
|---|--------------------------------------|------------|----------|------|--------|-----|----|---|
| | | | | | | | | Villeroy & Boch Aveo |
| wastafel m.overloop m.afvoerplug | | | | | | | | |
| 0123239 | 60x51cm ceramic+ | wit | 7132V6R1 | stuk | 692,00 | 272 | 1 | |
| 0123240 | 60x51cm ceramic+ m. active care | star white | 7132V6R2 | stuk | 692,00 | 272 | 1 | |
| 0123227 | 70x51cm ceramic+ | wit | 7132V7R1 | stuk | 876,00 | 272 | 1 | |
| 0123228 | 70x51cm ceramic+ m. active care | star white | 7132V7R2 | stuk | 876,00 | 272 | 1 | |
| 0830097 | bevestigingsset M10x110mm | | 0830097 | paar | 1,09 | 362 | 0 | |
| sifonkap m.bevestiging m.sifon voor wastafel | | | | | | | | |
| 0123230 | m. ceramic+ | wit | 728300R1 | stuk | 375,00 | 272 | 1 | |
| 0123231 | ceramic+ m. active care | star white | 728300R2 | stuk | 374,00 | 272 | 1 | |
| zuil voor wastafel | | | | | | | | |
| 0123233 | ceramic+ | wit | 728100R1 | stuk | 468,00 | 272 | 1 |  |
| 0123234 | ceramic+ | star white | 728100R2 | stuk | 467,00 | 272 | 1 | |
| opbouwastafel z.kraangat | | | | | | | | |
| 0123242 | 63x40cm ceramic+ | wit | 714800R1 | stuk | 764,00 | 272 | 1 |  |
| 0123243 | 63x40cm ceramic+ m. active care | star white | 714800R2 | stuk | 764,00 | 272 | 1 | |
| opzetwastafel z.kraangat | | | | | | | | |
| 0123278 | 65x47cm ceramic+ | wit | 718400R1 | stuk | 770,00 | 272 | 1 |  |
| 0123279 | 65x47cm ceramic+ m. active care | star white | 718400R2 | stuk | 770,00 | 272 | 1 | |
| planchet m. bevestiging | | | | | | | | |
| 0123251 | 66x50cm ceramic+ | wit | 787866R1 | stuk | 342,00 | 272 | 1 |  |
| 0123252 | 66x50cm ceramic+ m. active care | star white | 787866R2 | stuk | 342,00 | 272 | 1 | |
| fontein | | | | | | | | |
| 0123245 | 50x42,5cm ceramic+ | wit | 730850R1 | stuk | 392,00 | 272 | 1 |  |
| 0123246 | 50x42,5cm ceramic+ m. active care | star white | 730850R2 | stuk | 391,00 | 272 | 1 | |
| 0830240 | bevestigingsset voor fontein M8x90mm | | 0830240 | stuk | 0,85 | 362 | 0 | |
| sifonkap m.bevestiging m.sifon voor fontein | | | | | | | | |
| 0123248 | ceramic+ | wit | 721300R1 | stuk | 375,00 | 272 | 1 | |
| 0123249 | ceramic+ m. active care | star white | 721300R2 | stuk | 374,00 | 272 | 1 | |
| wandbidet | | | | | | | | |
| 0123254 | ceramic+ | wit | 741100R1 | stuk | 876,00 | 272 | 1 |  |
| 0123255 | ceramic+ m. active care | star white | 741100R2 | stuk | 876,00 | 272 | 1 | |
| wandbidet m.verdekte overloop | | | | | | | | |
| 0123257 | ceramic+ | wit | 7411V0R1 | stuk | 948,00 | 272 | 1 | |
| 0123258 | ceramic+ m. active care | star white | 7411V0R2 | stuk | 948,00 | 272 | 1 | |
| wandclosetpot m.bevestigingsset | | | | | | | | |
| 0123260 | ceramic+ | wit | 661210R1 | stuk | 836,00 | 272 | 1 |  |
| 0123261 | ceramic+ m. active care | star white | 661210R2 | stuk | 836,00 | 272 | 1 | |

Sanitair producten

Baden /
douchebakken /
stoomcabines

Kranen

Douchegarnituur

Accessoires en
spiegels

Douchewanden

Toebehoren &
afvoerenSpoel- &
installatiesystemenBadkamermeubelen
en toiletkastenGootstenen en
wastroggen

Utiliteit

| Art.nr | Specificaties | Kleur | Lev.nr | Ehd | Prijs | Grp | CC |
|--------|---------------|-------|--------|-----|-------|-----|----|
|--------|---------------|-------|--------|-----|-------|-----|----|

Villeroy & Boch Aveo

duoblokpot vario z. reservoir m.bevestigungsset

| | | | | | | | |
|---------|---------------------------------------|------------|----------|------|--------|-----|---|
| 0123267 | ceramic+ | wit | 661410R1 | stuk | 969,00 | 272 | 1 |
| 0123268 | ceramic+ m. active care | star white | 661410R2 | stuk | 969,00 | 272 | 1 |
| 0102221 | vario afvoerbocht verticaal 160-250mm | | 87010000 | stuk | 68,00 | 052 | 0 |
| 0102225 | vario afvoerbocht verticaal 70-160mm | | 87110000 | stuk | 68,00 | 052 | 1 |



Sanitair producten

Baden /
douchebakken /
stoomcabines

duoblokreservoir m.binnenwerk

| | | | | | | | |
|---------|-------------------------|------------|----------|------|--------|-----|---|
| 0123270 | ceramic+ | wit | 772411R1 | stuk | 684,00 | 272 | 1 |
| 0123271 | ceramic+ m. active care | star white | 772411R2 | stuk | 684,00 | 272 | 1 |

Kranen

closetzitting dubbel

| | | | | | | | |
|---------|------------|------------|----------|------|--------|-----|---|
| 0123263 | soft-close | wit | 9957S101 | stuk | 319,00 | 272 | 1 |
| 0123264 | soft-close | star white | 9957S1R2 | stuk | 352,00 | 272 | 1 |



Douchegarnituur

Villeroy & Boch Bellevue

wastafel

| | | | | | | | | |
|---------|-----------|-------------------------------|-----------|----------|------|--------|-----|---|
| 0100373 | 65x50.5cm | m. overloop ceramic+ | wit | 516465R1 | stuk | 580,00 | 052 | 1 |
| 0100374 | 65x50.5cm | m. overloop ceramic+ | starwhite | 516465R2 | stuk | 580,00 | 052 | 1 |
| 0100375 | 65x50.5cm | m. overloop ceramic+ | edelweiss | 516465S3 | stuk | 758,00 | 052 | 1 |
| 0100378 | 65x50.5cm | m. verdekte overloop ceramic+ | wit | 5164V6R1 | stuk | 652,00 | 052 | 1 |
| 0100379 | 65x50.5cm | m. verdekte overloop ceramic+ | starwhite | 5164V6R2 | stuk | 652,00 | 052 | 1 |
| 0100380 | 65x50.5cm | m. verdekte overloop ceramic+ | edelweiss | 5164V6S3 | stuk | 830,00 | 052 | 1 |



Accessoires en
spiegels

Douchewanden

decorpaneel voor wastafel 65cm

| | | | | | | | | |
|---------|-----------|--|--------------|----------|------|--------|-----|---|
| 0100224 | 44x4x38cm | | linea fineer | A2211000 | stuk | 184,00 | 323 | 1 |
|---------|-----------|--|--------------|----------|------|--------|-----|---|

Toebehoren &
afvoeren

wastafel

| | | | | | | | | |
|---------|---------|-------------------------------|-----------|----------|------|--------|-----|---|
| 0100591 | 75x55cm | m. overloop ceramic+ | wit | 516475R1 | stuk | 606,00 | 052 | 1 |
| 0100592 | 75x55cm | m. overloop ceramic+ | starwhite | 516475R2 | stuk | 606,00 | 052 | 1 |
| 0100593 | 75x55cm | m. overloop ceramic+ | edelweiss | 516475S3 | stuk | 794,00 | 052 | 1 |
| 0100296 | 75x55cm | m. verdekte overloop ceramic+ | wit | 5164V7R1 | stuk | 679,00 | 052 | 1 |
| 0100297 | 75x55cm | m. verdekte overloop ceramic+ | starwhite | 5164V7R2 | stuk | 678,00 | 052 | 1 |
| 0100298 | 75x55cm | m. verdekte overloop ceramic+ | edelweiss | 5164V7S3 | stuk | 866,00 | 052 | 1 |



Spoel- &
installatiesystemen

Badkamermeubelen
en toiletkasten

decorpaneel voor wastafel 75cm

| | | | | | | | | |
|---------|-------------|--|--------------|----------|------|--------|-----|---|
| 0100443 | 50.5x4x40cm | | linea fineer | A2212000 | stuk | 196,00 | 323 | 1 |
|---------|-------------|--|--------------|----------|------|--------|-----|---|

sifonkap voor wastafel

| | | | | | | | |
|---------|----------|-----------|----------|------|--------|-----|---|
| 0100646 | ceramic+ | wit | 526100R1 | stuk | 302,00 | 052 | 1 |
| 0100647 | | starwhite | 526100R2 | stuk | 302,00 | 052 | 1 |
| 0100648 | ceramic+ | edelweiss | 526100S3 | stuk | 386,00 | 052 | 1 |



Gootstenen en
wastroggen

Utiliteit

zuil voor wastafel

| | | | | | | | |
|---------|----------|-----------|----------|------|--------|-----|---|
| 0100557 | ceramic+ | wit | 526000R1 | stuk | 422,00 | 052 | 1 |
| 0100558 | ceramic+ | starwhite | 526000R2 | stuk | 422,00 | 052 | 1 |
| 0100559 | ceramic+ | edelweiss | 526000S3 | stuk | 547,00 | 052 | 1 |



meubelwastafel

| | | | | | | | | |
|---------|----------|-------------------------------|-----------|----------|------|---------|-----|---|
| 0100426 | 100x55cm | m. overloop ceramic+ | wit | 516810R1 | stuk | 945,00 | 052 | 1 |
| 0100427 | 100x55cm | m. overloop ceramic+ | starwhite | 516810R2 | stuk | 944,00 | 052 | 1 |
| 0100428 | 100x55cm | m. overloop ceramic+ | edelweiss | 516810S3 | stuk | 1250,00 | 052 | 1 |
| 0100429 | 100x55cm | m. overloop ceramic+ | Art Deco | 516810U8 | stuk | 1056,00 | 052 | 1 |
| 0100547 | 100x55cm | m. verdekte overloop ceramic+ | wit | 5168V1R1 | stuk | 1017,00 | 052 | 1 |
| 0100548 | 100x55cm | m. verdekte overloop ceramic+ | starwhite | 5168V1R2 | stuk | 1017,00 | 052 | 1 |
| 0100549 | 100x55cm | m. verdekte overloop ceramic+ | edelweiss | 5168V1S3 | stuk | 1322,00 | 052 | 1 |



decorpaneel voor wastafel 100cm

| | | | | | | | | |
|---------|-------------|--|--------------|----------|------|--------|-----|---|
| 0100341 | 67.5x4x40cm | | linea fineer | A2310000 | stuk | 217,00 | 323 | 1 |
|---------|-------------|--|--------------|----------|------|--------|-----|---|

| Art.nr | Specificaties | Kleur | Lev.nr | Ehd | Prijs | Grp | CC |
|--------|---------------|-------|--------|-----|-------|-----|----|
|--------|---------------|-------|--------|-----|-------|-----|----|

Villeroy & Boch Bellevue

opbouwastafel

| | | | | | | | |
|---------|---------|-------------------------------|-----------|----------|------|--------|-------|
| 0100365 | 65x50cm | m. overloop ceramic+ | wit | 516565R1 | stuk | 643,00 | 052 1 |
| 0100366 | 65x50cm | m. overloop ceramic+ | starwhite | 516565R2 | stuk | 642,00 | 052 1 |
| 0100367 | 65x50cm | m. overloop ceramic+ | edelweiss | 516565S3 | stuk | 844,00 | 052 1 |
| 0100311 | 65x50cm | m. verdekte overloop ceramic+ | wit | 5165V6R1 | stuk | 715,00 | 052 1 |
| 0100312 | 65x50cm | m. verdekte overloop ceramic+ | starwhite | 5165V6R2 | stuk | 714,00 | 052 1 |
| 0100313 | 65x50cm | m. verdekte overloop ceramic+ | edelweiss | 5165V6S3 | stuk | 916,00 | 053 1 |



Sanitair producten

Baden /
douchebakken /
stoomcabines

Kranen

Douchegarnituur

Accessoires en
spiegels

Douchewanden

Toebehoren &
afvoerenSpoel- &
installatiesystemenBadkamermeubelen
en toiletkastenGootstenen en
wastroggen

Utiliteit

fontein

| | | | | | | | |
|---------|---------|----------------------|-----------|----------|------|--------|-------|
| 0100601 | 50x40cm | m. overloop ceramic+ | wit | 536450R1 | stuk | 405,00 | 052 1 |
| 0100602 | 50x40cm | m. overloop ceramic+ | starwhite | 536450R2 | stuk | 405,00 | 052 1 |
| 0100603 | 50x40cm | m. overloop ceramic+ | edelweiss | 536450S3 | stuk | 524,00 | 052 1 |

**decorpaneel voor fontein**

| | | | | | | | |
|---------|-------------|--|--|----------|------|--------|-------|
| 0100260 | 34.5x4x30cm | | | A2210000 | stuk | 181,00 | 052 1 |
|---------|-------------|--|--|----------|------|--------|-------|

sifonkap voor fontein

| | | | | | | | |
|---------|--|----------|-----------|----------|------|--------|-------|
| 0100448 | | ceramic+ | wit | 526200R1 | stuk | 302,00 | 052 1 |
| 0100449 | | ceramic+ | starwhite | 526200R2 | stuk | 302,00 | 052 1 |
| 0100450 | | ceramic+ | edelweiss | 526200S3 | stuk | 386,00 | 052 1 |

wandbidet

| | | | | | | | |
|---------|-----------|-------------------------------|-----------|----------|------|---------|-------|
| 0100417 | 37.5x59cm | m. overloop ceramic+ | wit | 546400R1 | stuk | 781,00 | 052 1 |
| 0100418 | 37.5x59cm | m. overloop ceramic+ | starwhite | 546400R2 | stuk | 781,00 | 052 1 |
| 0100420 | 37.5x59cm | m. overloop ceramic+ | edelweiss | 546400S3 | stuk | 1030,00 | 052 1 |
| 0100668 | 37.5x59cm | m. verdekte overloop ceramic+ | wit | 5464V1R1 | stuk | 853,00 | 052 1 |
| 0100669 | 37.5x59cm | m. verdekte overloop ceramic+ | starwhite | 5464V1R2 | stuk | 853,00 | 052 1 |
| 0100670 | 37.5x59cm | m. verdekte overloop ceramic+ | edelweiss | 5464V1S3 | stuk | 1102,00 | 052 1 |

**staand bidet**

| | | | | | | | |
|---------|-----------|----------------------|-----------|----------|------|--------|-------|
| 0100665 | 37.5x56cm | m. overloop ceramic+ | wit | 546500R1 | stuk | 730,00 | 052 1 |
| 0100666 | 37.5x56cm | m. overloop ceramic+ | starwhite | 546500R2 | stuk | 730,00 | 052 1 |
| 0100667 | 37.5x56cm | m. overloop ceramic+ | edelweiss | 546500S3 | stuk | 961,00 | 052 1 |

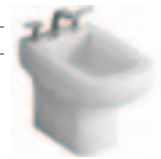
**zitting voor bidet**

| | | | | | | | |
|---------|--|----------|-----------|----------|------|--------|-------|
| 0100614 | | | wit | 98M40001 | stuk | 165,00 | 052 1 |
| 0100615 | | ceramic+ | starwhite | 98M400R2 | stuk | 182,00 | 052 1 |
| 0100616 | | | edelweiss | 98M400S3 | stuk | 217,00 | 052 1 |

wandclosetpot diepspoel

| | | | | | | | |
|---------|-----------|----------|-----------|----------|------|--------|-------|
| 0100594 | 37.5x59cm | ceramic+ | wit | 566410R1 | stuk | 747,00 | 052 1 |
| 0100596 | 37.5x59cm | ceramic+ | starwhite | 566410R2 | stuk | 747,00 | 052 1 |
| 0100597 | 37.5x59cm | ceramic+ | edelweiss | 566410S3 | stuk | 984,00 | 052 1 |

**wandclosetpot diepspoel voor Geberit Powerflush**

| | | | | | | | |
|---------|-----------|----------|-----------|----------|------|---------|-------|
| 0100346 | 37.5x59cm | ceramic+ | wit | 566710R1 | stuk | 865,00 | 052 1 |
| 0100347 | 37.5x59cm | ceramic+ | starwhite | 566710R2 | stuk | 865,00 | 052 1 |
| 0100348 | 37.5x59cm | ceramic+ | edelweiss | 566710S3 | stuk | 1142,00 | 052 1 |







closetzitting m. softclosing

| | | | | | | | |
|---------|--|--|-----------|----------|------|--------|-------|
| 0100607 | | | wit | 98M2S101 | stuk | 260,00 | 052 1 |
| 0100608 | | | starwhite | 98M2S1R2 | stuk | 287,00 | 052 1 |
| 0100609 | | | edelweiss | 98M2S1S3 | stuk | 340,00 | 052 1 |

afzuigurinoir voor deksel

| | | | | | | | |
|---------|--------------|----------|-----------|----------|------|--------|-------|
| 0100598 | 31x53.5x38cm | ceramic+ | wit | 556401R1 | stuk | 578,00 | 052 1 |
| 0100599 | 31x53.5x38cm | ceramic+ | starwhite | 556401R2 | stuk | 578,00 | 052 1 |
| 0100600 | 31x53.5x38cm | ceramic+ | edelweiss | 556401S3 | stuk | 756,00 | 052 1 |



| | Art.nr | Specificaties | Kleur | Lev.nr | Ehd | Prijs | Grp | CC |
|---|---|----------------|--------------|----------|---------|---------|-----|----|
| Sanitair producten | Villeroy & Boch Bellevue | | | | | | | |
| | deksel voor urinoir m. softclosing | | | | | | | |
| | 0100611 | | wit | 98M3S101 | stuk | 260,00 | 052 | 1 |
| | 0100612 | | starwhite | 98M3S1R2 | stuk | 287,00 | 052 | 1 |
| | 0100613 | | edelweiss | 98M3S1S3 | stuk | 340,00 | 052 | 1 |
| Baden / douchebakken / stoomcabines | spiegel | | | | | | | |
| | 0100516 | 50x75x3.5cm | linea fineer | A2340000 | stuk | 388,00 | 323 | 1 |
| | 0100610 | 75x75x8.5cm | linea fineer | A2240000 | stuk | 986,00 | 323 | 1 |
| | 0100644 | 150x55x5cm | linea fineer | A2241000 | stuk | 1180,00 | 323 | 1 |
| Kranen |  | | | | | | | |
| Douchegarnituur |  | | | | | | | |
| Accessoires en spiegels |  | | | | | | | |
| Douchewanden | | | | | | | | |
| Toebehoren & afvoeren | spiegelkast | | | | | | | |
| | 0100363 | 75x75x14.5cm | linea fineer | A2320100 | stuk | 1376,00 | 323 | 1 |
| Spoel- & installatiesystemen | | | | | | | | |
| Badkamermeubelen en toiletkasten | staande spiegel | | | | | | | |
| | 0100405 | 63x189x63cm | linea fineer | A2290000 | stuk | 1792,00 | 323 | 1 |
| Gootstenen en wastroggen | onderkast voor wastafel 5164 | | | | | | | |
| | 0100349 | 54x65.5x40cm | linea fineer | A2200000 | stuk | 1265,00 | 323 | 1 |
| | 0100645 | 48x66.5x38cm | linea fineer | A2201000 | stuk | 1176,00 | 323 | 1 |
| Utiliteit |  | | | | | | | |
| | onderkast voor wastafel 5168 | | | | | | | |
| | 0100588 | 71.5x65.5x40cm | linea fineer | A2202000 | stuk | 1423,00 | 323 | 1 |
|  | | | | | | | | |
| onderkast voor wastafel 5165 | | | | | | | | |
| 0100309 | 109x81x56.5cm | linea fineer | A2220000 | stuk | 2362,00 | 323 | 1 | |
|  | | | | | | | | |

| Art.nr | Specificaties | Kleur | Lev.nr | Ehd | Prijs | Grp | CC |
|--------|---------------|-------|--------|-----|-------|-----|----|
|--------|---------------|-------|--------|-----|-------|-----|----|

Villeroy & Boch Bellevue

onderconstructie

| | | | | | | | |
|---------|---------------|--------------|----------|------|---------|-----|---|
| 0100406 | 150x17.5x42cm | linea fineer | A2230000 | stuk | 1307,00 | 323 | 1 |
|---------|---------------|--------------|----------|------|---------|-----|---|



Sanitair producten

Baden /
douchebakken /
stoomcabines**hoge kast**

| | | | | | | | | |
|---------|---------------|-----------------|--------------|----------|------|---------|-----|---|
| 0100221 | 54x199.5x40cm | scharnier links | linea fineer | A2251L00 | stuk | 1995,00 | 323 | 1 |
|---------|---------------|-----------------|--------------|----------|------|---------|-----|---|

| | | | | | | | | |
|---------|---------------|------------------|--------------|----------|------|---------|-----|---|
| 0100222 | 54x199.5x40cm | scharnier rechts | linea fineer | A2251R00 | stuk | 1995,00 | 323 | 1 |
|---------|---------------|------------------|--------------|----------|------|---------|-----|---|



Kranen

Douchegarnituur

commode

| | | | | | | | |
|---------|-------------|--------------|----------|------|---------|-----|---|
| 0100356 | 109x95x40cm | linea fineer | A2260000 | stuk | 2079,00 | 323 | 1 |
|---------|-------------|--------------|----------|------|---------|-----|---|

Accessoires en
spiegels**make-up tafel**

| | | | | | | | |
|---------|------------|--------------|----------|------|---------|-----|---|
| 0100214 | 58x79x40cm | linea fineer | A2270000 | stuk | 1353,00 | 323 | 1 |
|---------|------------|--------------|----------|------|---------|-----|---|



Douchewanden

Toebehoren &
afvoeren**kruk**

| | | | | | | | |
|---------|------------|-------------|----------|------|--------|-----|---|
| 0100358 | 42x44x40cm | linea/zwart | A2280000 | stuk | 798,00 | 323 | 1 |
|---------|------------|-------------|----------|------|--------|-----|---|

Spoel- &
installatiesystemenBadkamermeubelen
en toiletkasten**dressboy**

| | | | | | | | |
|---------|-------------|--------------|----------|------|--------|-----|---|
| 0100204 | 48x102x45cm | linea fineer | A2300000 | stuk | 790,00 | 323 | 1 |
|---------|-------------|--------------|----------|------|--------|-----|---|

Gootstenen en
wastroggen

Utiliteit

Villeroy & Boch Century

wastafel

| | | | | | | | | |
|---------|---------|------------------------|-----|----------|------|--------|-----|---|
| 0120538 | 60x49cm | m. 1 kraangat ceramic+ | wit | 715660R1 | stuk | 329,00 | 052 | 1 |
|---------|---------|------------------------|-----|----------|------|--------|-----|---|

| | | | | | | | | |
|---------|---------|------------------------|----------|----------|------|--------|-----|---|
| 0120539 | 60x49cm | m. 1 kraangat ceramic+ | pergamon | 715660R3 | stuk | 382,00 | 052 | 1 |
|---------|---------|------------------------|----------|----------|------|--------|-----|---|

| | | | | | | | | |
|---------|---------|--------------------------|-----|----------|------|--------|-----|---|
| 0120541 | 60x49cm | m. 3 kraangaten ceramic+ | wit | 7156A2R1 | stuk | 329,00 | 052 | 1 |
|---------|---------|--------------------------|-----|----------|------|--------|-----|---|

| | | | | | | | | |
|---------|---------|--------------------------|----------|----------|------|--------|-----|---|
| 0120542 | 60x49cm | m. 3 kraangaten ceramic+ | pergamon | 7156A2R3 | stuk | 382,00 | 052 | 1 |
|---------|---------|--------------------------|----------|----------|------|--------|-----|---|

| | | | | | | | | |
|---------|---------|------------------------|-----|----------|------|--------|-----|---|
| 0120509 | 70x52cm | m. 1 kraangat ceramic+ | wit | 715670R1 | stuk | 388,00 | 052 | 1 |
|---------|---------|------------------------|-----|----------|------|--------|-----|---|

| | | | | | | | | |
|---------|---------|------------------------|----------|----------|------|--------|-----|---|
| 0122224 | 70x52cm | m. 1 kraangat ceramic+ | pergamon | 715670R3 | stuk | 454,00 | 052 | 1 |
|---------|---------|------------------------|----------|----------|------|--------|-----|---|

| | | | | | | | | |
|---------|---------|--------------------------|-----|----------|------|--------|-----|---|
| 0141267 | 70x52cm | m. 3 kraangaten ceramic+ | wit | 7156A1R1 | stuk | 388,00 | 052 | 1 |
|---------|---------|--------------------------|-----|----------|------|--------|-----|---|

| | | | | | | | | |
|---------|---------|--------------------------|----------|----------|------|--------|-----|---|
| 0141275 | 70x52cm | m. 3 kraangaten ceramic+ | pergamon | 7156A1R3 | stuk | 454,00 | 052 | 1 |
|---------|---------|--------------------------|----------|----------|------|--------|-----|---|

| | | | | | | | | |
|---------|----------|------------------------|-----|----------|------|--------|-----|---|
| 0172115 | 100x54cm | m. 1 kraangat ceramic+ | wit | 715310R1 | stuk | 796,00 | 052 | 1 |
|---------|----------|------------------------|-----|----------|------|--------|-----|---|

| | | | | | | | | |
|---------|----------|------------------------|----------|----------|------|--------|-----|---|
| 0130028 | 100x54cm | m. 1 kraangat ceramic+ | pergamon | 715310R3 | stuk | 945,00 | 052 | 1 |
|---------|----------|------------------------|----------|----------|------|--------|-----|---|

| | | | | | | | | |
|---------|----------|--------------------------|-----|----------|------|--------|-----|---|
| 0141224 | 100x54cm | m. 3 kraangaten ceramic+ | wit | 7153A1R1 | stuk | 796,00 | 052 | 1 |
|---------|----------|--------------------------|-----|----------|------|--------|-----|---|

| | | | | | | | | |
|---------|----------|--------------------------|----------|----------|------|--------|-----|---|
| 0141232 | 100x54cm | m. 3 kraangaten ceramic+ | pergamon | 7153A1R3 | stuk | 945,00 | 052 | 1 |
|---------|----------|--------------------------|----------|----------|------|--------|-----|---|

| | | | | | | | | |
|---------|---------------------------|--|--|---------|------|------|-----|---|
| 0830097 | bevestigingsset M10x110mm | | | 0830097 | paar | 1,09 | 362 | 0 |
|---------|---------------------------|--|--|---------|------|------|-----|---|

| | | | | | | | |
|---------|----------|-----|----------|------|--------|-----|---|
| 0120513 | ceramic+ | wit | 720300R1 | stuk | 245,00 | 052 | 1 |
|---------|----------|-----|----------|------|--------|-----|---|

| | | | | | | | |
|---------|----------|----------|----------|------|--------|-----|---|
| 0121576 | ceramic+ | pergamon | 720300R3 | stuk | 283,00 | 052 | 1 |
|---------|----------|----------|----------|------|--------|-----|---|



| Art.nr | Specificaties | Kleur | Lev.nr | Ehd | Prijs | Grp | CC |
|--------|---------------|-------|--------|-----|-------|-----|----|
|--------|---------------|-------|--------|-----|-------|-----|----|

Villeroy & Boch Century

zuil voor wastafel

| | | | | | | | |
|---------|----------|----------|----------|------|--------|-----|---|
| 0120511 | ceramic+ | wit | 720200R1 | stuk | 257,00 | 052 | 1 |
| 0122223 | ceramic+ | pergamon | 720200R3 | stuk | 297,00 | 052 | 1 |



Sanitair producten

Baden /
douchebakken /
stoomcabines

keramische poot per stuk

| | | | | | | | |
|---------|----------|----------|----------|------|--------|-----|---|
| 0172113 | ceramic+ | wit | 720100R1 | stuk | 234,00 | 052 | 1 |
| 0130029 | ceramic+ | pergamon | 720100R3 | stuk | 268,00 | 052 | 1 |



Kranen

Douchegarnituur

voorbouwwastafel

| | | | | | | | | |
|---------|---------|--------------------------|----------|----------|------|--------|-----|---|
| 0106798 | 57x46cm | m. 1 kraangat ceramic+ | wit | 714355R1 | stuk | 553,00 | 052 | 1 |
| 0106801 | 57x46cm | m. 1 kraangat ceramic+ | pergamon | 714355R3 | stuk | 652,00 | 052 | 1 |
| 0141313 | 57x45cm | m. 3 kraangaten ceramic+ | wit | 7143A1R1 | stuk | 553,00 | 052 | 1 |
| 0141321 | 57x45cm | m. 3 kraangaten ceramic+ | pergamon | 7143A1R3 | stuk | 652,00 | 052 | 1 |



Accessoires en
spiegels

Douchewanden

fontein

| | | | | | | | | |
|---------|--------------------------------------|----------|----------|----------|------|--------|-----|---|
| 0106615 | 50x40cm | ceramic+ | wit | 735050R1 | stuk | 278,00 | 052 | 1 |
| 0106623 | 50x40cm | ceramic+ | pergamon | 735050R3 | stuk | 321,00 | 052 | 1 |
| 0830240 | bevestigingsset voor fontein M8x90mm | | | 0830240 | stuk | 0,85 | 362 | 0 |



Toebehoren &
afvoeren

planchet

| | | | | | | | | |
|---------|----------------------------------|----------|----------|----------|------|--------|-----|---|
| 0121606 | 50x18cm | ceramic+ | wit | 785350R1 | stuk | 173,00 | 052 | 1 |
| 0121614 | 50x18cm | ceramic+ | pergamon | 785350R3 | stuk | 196,00 | 052 | 1 |
| 0120503 | 70x19cm | ceramic+ | wit | 785370R1 | stuk | 226,00 | 052 | 1 |
| 0122222 | 70x19cm | ceramic+ | pergamon | 785370R3 | stuk | 261,00 | 052 | 1 |
| 0830453 | set potschroeven 5.5x60mm chroom | | | 0830453 | stuk | 2,28 | 362 | 0 |



Spoel- &
installatiesystemen

staand bidet

| | | | | | | | |
|---------|----------|----------|----------|------|--------|-----|---|
| 0106658 | ceramic+ | wit | 745700R1 | stuk | 418,00 | 052 | 1 |
| 0106666 | ceramic+ | pergamon | 745700R3 | stuk | 491,00 | 052 | 1 |



Badkamermeubelen
en toiletkasten

Gootstenen en
wastroggen

staand bidet voor 3-gats kraan

| | | | | | | | |
|---------|----------|----------|----------|------|--------|-----|---|
| 0141364 | ceramic+ | wit | 7457A1R1 | stuk | 418,00 | 052 | 1 |
| 0141372 | ceramic+ | pergamon | 7457A1R3 | stuk | 491,00 | 052 | 1 |

wandbidet

| | | | | | | | |
|---------|----------|----------|----------|------|--------|-----|---|
| 0106674 | ceramic+ | wit | 745300R1 | stuk | 487,00 | 052 | 1 |
| 0110311 | ceramic+ | pergamon | 745300R3 | stuk | 572,00 | 052 | 1 |



Utiliteit

wandclosetpot diepspoel

| | | | | | | | |
|---------|----------|----------|----------|------|--------|-----|---|
| 0120515 | ceramic+ | wit | 665310R1 | stuk | 432,00 | 052 | 1 |
| 0115000 | ceramic+ | pergamon | 665310R3 | stuk | 506,00 | 052 | 1 |



closetzitting dubbel

| | | | | | | | |
|---------|--|---------------|----------|------|--------|-----|---|
| 0120525 | | wit | 88436101 | stuk | 162,00 | 052 | 1 |
| 0125000 | | pergamon | 88436109 | stuk | 179,00 | 052 | 1 |
| 0120540 | | chroom/kersen | 88456100 | stuk | 253,00 | 052 | 1 |

| Art.nr | Specificaties | Kleur | Lev.nr | Ehd | Prijs | Grp | CC |
|--------|---------------|-------|--------|-----|-------|-----|----|
|--------|---------------|-------|--------|-----|-------|-----|----|

Villeroy & Boch Century

duoblokpot diepspoel z. reservoir

| | | | | | | | |
|---------|----------|----------|----------|------|--------|-----|---|
| 0106720 | ceramic+ | wit | 665410R1 | stuk | 451,00 | 052 | 1 |
| 0106739 | ceramic+ | pergamon | 665410R3 | stuk | 529,00 | 052 | 1 |



Sanitair producten

Baden /
douchebakken /
stoomcabines

Kranen

Douchegarnituur

Accessoires en
spiegels

Douchewanden

Toebehoren &
afvoerenSpoel- &
installatiesystemenBadkamermeubelen
en toiletkastenGootstenen en
wastroggen

Utiliteit

duoblokreervoir + binnenwerk

| | | | | | | | |
|---------|--|----------|----------|------|--------|-----|---|
| 0106002 | | wit | 775311R1 | stuk | 356,00 | 052 | 1 |
| 0106005 | | pergamon | 775311R3 | stuk | 392,00 | 052 | 1 |

closetcombinatie diepspoel

| | | | | | | | |
|---------|-----------------------------|-----------|----------|------|--------|-----|---|
| 0113344 | ceramic+ | wit | CENTURY | stuk | 807,00 | 052 | 1 |
| 0113352 | ceramic+ | pergamon | CENTURY | stuk | 921,00 | 052 | 1 |
| 0102221 | vario afvoerbocht verticaal | 160-250mm | 87010000 | stuk | 68,00 | 052 | 0 |
| 0102225 | vario afvoerbocht verticaal | 70-160mm | 87110000 | stuk | 68,00 | 052 | 1 |

**urinoir voor deksel**

| | | | | | | | |
|---------|---|----------|----------|------|--------|-----|---|
| 0106747 | ceramic+ | wit | 755301R1 | stuk | 504,00 | 052 | 1 |
| 0106755 | ceramic+ | pergamon | 755301R3 | stuk | 593,00 | 052 | 1 |
| 0100951 | inlaatfitting urinoir Esta/Magnum/Stratos | | 99330000 | stuk | 27,00 | 053 | 1 |
| 0104590 | urinoirsifon horizontaal | | 93090000 | stuk | 25,50 | 053 | 0 |
| 0104604 | urinoirsifon verticaal | | 93080000 | stuk | 25,50 | 053 | 1 |
| 0104612 | aansluitgarnituur urinoir Magnum-Neu | | 93190000 | stuk | 70,00 | 053 | 1 |

**deksel voor urinoir m. scharnier chrom**

| | | | | | | | |
|---------|--|----------|----------|------|--------|-----|---|
| 0121681 | | wit | 88446101 | stuk | 162,00 | 052 | 1 |
| 0121703 | | pergamon | 88446109 | stuk | 179,00 | 052 | 1 |

spiegel

| | | | | | | | |
|---------|---------|--------|----------|------|--------|-----|---|
| 0122226 | 70x55cm | kersen | 96570000 | stuk | 490,00 | 323 | 1 |
|---------|---------|--------|----------|------|--------|-----|---|



Villeroy & Boch Editionals

wandbidet

| | | | | | | | |
|---------|----------|----------|----------|------|--------|-----|---|
| 0104329 | ceramic+ | wit | 7443B0R1 | stuk | 593,00 | 052 | 1 |
| 0104337 | ceramic+ | pergamon | 7443B0R3 | stuk | 593,00 | 052 | 1 |

**wandclosetpot diepspoel**

| | | | | | | | |
|---------|----------|----------|----------|------|--------|-----|---|
| 0104264 | ceramic+ | wit | 6665B0R1 | stuk | 707,00 | 052 | 1 |
| 0104272 | ceramic+ | pergamon | 6665B0R3 | stuk | 707,00 | 052 | 1 |

**duoblokpot diepspoel z. reservoir**

| | | | | | | | |
|---------|-----------------------------|-----------|----------|------|--------|-----|---|
| 0104434 | ceramic+ | wit | 666610R1 | stuk | 732,00 | 052 | 1 |
| 0104442 | ceramic+ | pergamon | 666610R3 | stuk | 732,00 | 052 | 1 |
| 0102221 | vario afvoerbocht verticaal | 160-250mm | 87010000 | stuk | 68,00 | 052 | 0 |
| 0102225 | vario afvoerbocht verticaal | 70-160mm | 87110000 | stuk | 68,00 | 052 | 1 |

**duoblokreervoir**

| | | | | | | | |
|---------|----------|----------|----------|------|--------|-----|---|
| 0104418 | ceramic+ | wit | 772211R1 | stuk | 504,00 | 052 | 1 |
| 0104426 | ceramic+ | pergamon | 772211R3 | stuk | 504,00 | 052 | 1 |

closetcombinatie diepspoel

| | | | | | | | |
|---------|-----------------------------|-----------|------------|------|---------|-----|---|
| 0113395 | ceramic+ | wit | EDITIONALS | stuk | 1236,00 | 052 | 1 |
| 0113409 | ceramic+ | pergamon | EDITIONALS | stuk | 1236,00 | 052 | 1 |
| 0102221 | vario afvoerbocht verticaal | 160-250mm | 87010000 | stuk | 68,00 | 052 | 0 |
| 0102225 | vario afvoerbocht verticaal | 70-160mm | 87110000 | stuk | 68,00 | 052 | 1 |



| Art.nr | Specificaties | Kleur | Lev.nr | Ehd | Prijs | Grp | CC |
|--------|---------------|-------|--------|-----|-------|-----|----|
|--------|---------------|-------|--------|-----|-------|-----|----|

Villeroy & Boch Editorials

closetzitting dubbel

| | | | | | | | |
|---------|-----------------------------------|-------------------|----------|------|--------|-----|---|
| 0104280 | | wit | 88796101 | stuk | 165,00 | 052 | 1 |
| 0104310 | | pergamon | 88796109 | stuk | 182,00 | 052 | 1 |
| 0104442 | duoblokpot diepspoel z. reservoir | ceramic+ pergamon | 666610R3 | stuk | 732,00 | 052 | 1 |

Villeroy & Boch Epura

wastafel ovaal

| | | | | | | | | |
|---------|---------------------------|----------|-----------|----------|------|--------|-----|---|
| 0140433 | 70x56cm | ceramic+ | wit | 719670R1 | stuk | 473,00 | 052 | 1 |
| 0106879 | 70x56cm | ceramic+ | pergamon | 719670R3 | stuk | 473,00 | 052 | 1 |
| 0132028 | 70x56cm | ceramic+ | starwhite | 719670R2 | stuk | 473,00 | 052 | 1 |
| 0830097 | bevestigingsset M10x110mm | | | 0830097 | paar | 1,09 | 362 | 0 |



wastafel rond

| | | | | | | | | |
|---------|---------------------------|----------|----------|----------|------|--------|-----|---|
| 0120004 | 53x54cm | ceramic+ | wit | 719950R1 | stuk | 388,00 | 052 | 1 |
| 0106909 | 53x54cm | ceramic+ | pergamon | 719950R3 | stuk | 388,00 | 052 | 1 |
| 0830097 | bevestigingsset M10x110mm | | | 0830097 | paar | 1,09 | 362 | 0 |

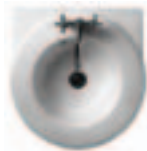

sifonkap voor wastafel

| | | | | | | | | |
|---------|--|----------|----------|----------|------|--------|-----|---|
| 0132136 | | ceramic+ | wit | 729900R1 | stuk | 261,00 | 052 | 1 |
| 0132144 | | ceramic+ | pergamon | 729900R3 | stuk | 261,00 | 052 | 1 |

hoekfontein links m. kraangat

| | | | | | | | | |
|---------|---------------------------|----------|----------|----------|------|--------|-----|---|
| 0100146 | 43x43cm | ceramic+ | wit | 73125LR1 | stuk | 369,00 | 052 | 1 |
| 0100042 | 43x43cm | ceramic+ | pergamon | 73125LR3 | stuk | 369,00 | 052 | 1 |
| 0830097 | bevestigingsset M10x110mm | | | 0830097 | paar | 1,09 | 362 | 0 |

hoekfontein rechts m. kraangat

| | | | | | | | | |
|---------|---------------------------|----------|----------|----------|------|--------|-----|---|
| 0100043 | 43x43cm | ceramic+ | wit | 73125RR1 | stuk | 369,00 | 052 | 1 |
| 0100044 | 43x43cm | ceramic+ | pergamon | 73125RR3 | stuk | 369,00 | 052 | 1 |
| 0830097 | bevestigingsset M10x110mm | | | 0830097 | paar | 1,09 | 362 | 0 |



wandbidet

| | | | | | | | | |
|---------|--|----------|----------|----------|------|--------|-----|---|
| 0106941 | | ceramic+ | wit | 749600R1 | stuk | 529,00 | 052 | 1 |
| 0106968 | | ceramic+ | pergamon | 749600R3 | stuk | 529,00 | 052 | 1 |



wandclosetpot diepspoel

| | | | | | | | | |
|---------|--|----------|----------|----------|------|--------|-----|---|
| 0112889 | | ceramic+ | wit | 669610R1 | stuk | 508,00 | 052 | 0 |
| 0106992 | | ceramic+ | pergamon | 669610R3 | stuk | 508,00 | 052 | 1 |



closetcombinatie diepspoel

| | | | | | | | | |
|---------|---------------------------------------|----------|----------|----------|------|---------|-----|---|
| 0113417 | | ceramic+ | wit | EPURA | stuk | 1007,00 | 052 | 1 |
| 0113441 | | ceramic+ | pergamon | EPURA | stuk | 1007,00 | 052 | 1 |
| 0102221 | vario afvoerbocht verticaal 160-250mm | | | 87010000 | stuk | 68,00 | 052 | 0 |
| 0102225 | vario afvoerbocht verticaal 70-160mm | | | 87110000 | stuk | 68,00 | 052 | 1 |



closetzitting dubbel

| | | | | | | | |
|---------|--|----------|----------|------|--------|-----|---|
| 0104248 | | wit | 88376101 | stuk | 165,00 | 052 | 1 |
| 0104256 | | pergamon | 88376109 | stuk | 182,00 | 052 | 1 |

duoblokpot diepspoel z. reservoir

| | | | | | | | | |
|---------|--|----------|----------|----------|------|--------|-----|---|
| 0109002 | | ceramic+ | wit | 669810R1 | stuk | 589,00 | 052 | 1 |
| 0109010 | | ceramic+ | pergamon | 669810R3 | stuk | 589,00 | 052 | 1 |

duoblokreervoir + binnenwerk

| | | | | | | | | |
|---------|--|----------|----------|----------|------|--------|-----|---|
| 0112852 | | ceramic+ | wit | 777811R1 | stuk | 418,00 | 052 | 1 |
| 0112860 | | ceramic+ | pergamon | 777811R3 | stuk | 418,00 | 052 | 1 |

| Art.nr | Specificaties | Kleur | Lev.nr | Ehd | Prijs | Grp | CC |
|--------|---------------|-------|--------|-----|-------|-----|----|
|--------|---------------|-------|--------|-----|-------|-----|----|

Villeroy & Boch Epura

urinoir voor deksel

| | | | | | | | |
|---------|----------|----------|----------|------|--------|-----|---|
| 0120621 | ceramic+ | wit | 756051R1 | stuk | 625,00 | 052 | 1 |
| 0120623 | ceramic+ | pergamon | 756051R3 | stuk | 625,00 | 052 | 1 |



Sanitair producten

Baden /
douchebakken /
stoomcabines**deksel voor wandurinoir**

| | | | | | | | |
|---------|--|----------|----------|------|--------|-----|---|
| 0112917 | | wit | 88386101 | stuk | 165,00 | 052 | 1 |
| 0112925 | | pergamon | 88386109 | stuk | 182,00 | 052 | 1 |



Kranen

Douchegarnituur

Loft onderstel voor wastafel

| | | | | | | | |
|---------|--|----------|----------|------|--------|-----|---|
| 0100265 | | alu/glas | 96720000 | stuk | 692,00 | 052 | 1 |
|---------|--|----------|----------|------|--------|-----|---|

Accessoires en
spiegels**Cottage wastafelonderbouw**

| | | | | | | | |
|---------|-------------|--------|----------|------|---------|-----|---|
| 0140479 | 120x63x42cm | beuken | 960810H2 | stuk | 1524,00 | 052 | 1 |
| 0140481 | 40x63x32cm | beuken | 960900H2 | stuk | 920,00 | 052 | 1 |



Douchewanden

Toebehoren &
afvoerenSpoel- &
installatiesystemenBadkamermeubelen
en toiletkasten**Cottage hoge kast links**

| | | | | | | | |
|---------|----------|--------|----------|------|---------|-----|---|
| 0140473 | 200x50cm | beuken | 961200H2 | stuk | 1978,00 | 052 | 1 |
|---------|----------|--------|----------|------|---------|-----|---|

Gootstenen en
wastroggen**Cottage spiegel**

| | | | | | | | |
|---------|---------|--------|----------|------|--------|-----|---|
| 0140466 | 60x86cm | beuken | 961300H2 | stuk | 545,00 | 052 | 1 |
|---------|---------|--------|----------|------|--------|-----|---|



Utiliteit

Modern Home wastafelonderbouw

| | | | | | | | |
|---------|--------------|--|----------|------|--------|-----|---|
| 0140437 | 38x48x34.5cm | | 967000H3 | stuk | 583,00 | 052 | 1 |
|---------|--------------|--|----------|------|--------|-----|---|

**Modern Home hoge kast links**

| | | | | | | | |
|---------|-------------|--------------|----------|------|---------|-----|---|
| 0140462 | 35x170x35cm | aqua/wit/alu | 967500H3 | stuk | 1169,00 | 052 | 1 |
|---------|-------------|--------------|----------|------|---------|-----|---|



| Art.nr | Specificaties | Kleur | Lev.nr | Ehd | Prijs | Grp | CC |
|--------|---------------|-------|--------|-----|-------|-----|----|
|--------|---------------|-------|--------|-----|-------|-----|----|

Villeroy & Boch Epura

Modern Home spiegel

| | | | | | | | |
|---------|---------|----------|----------|------|--------|-----|---|
| 0100261 | 69x49cm | alu/aqua | 967600H3 | stuk | 466,00 | 052 | 1 |
|---------|---------|----------|----------|------|--------|-----|---|



Sanitair producten

Baden /
douchebakken /
stoomcabines

Villeroy & Boch Grangracia

wastafel

| | | | | | | | | |
|---------|---------------------------|----------|----------|----------|--------|--------|-----|---|
| 0120154 | 60x51cm | wit | 71426001 | stuk | 253,00 | 053 | 1 | |
| 0130370 | 60x51cm | pergamon | 71426009 | stuk | 304,00 | 053 | 1 | |
| 0113824 | 60x51cm | ceramic+ | wit | 714260R1 | stuk | 316,00 | 053 | 1 |
| 0113832 | 60x51cm | ceramic+ | pergamon | 714260R3 | stuk | 367,00 | 053 | 1 |
| 0120200 | 70x57cm | wit | 71427001 | stuk | 359,00 | 053 | 1 | |
| 0130400 | 70x57cm | pergamon | 71427009 | stuk | 431,00 | 053 | 1 | |
| 0113875 | 70x57cm | ceramic+ | wit | 714270R1 | stuk | 422,00 | 053 | 1 |
| 0113883 | 70x57cm | ceramic+ | pergamon | 714270R3 | stuk | 494,00 | 053 | 1 |
| 0120987 | 80x57cm | wit | 71388001 | stuk | 600,00 | 053 | 1 | |
| 0113948 | 80x57cm | ceramic+ | wit | 713880R1 | stuk | 663,00 | 053 | 1 |
| 0830097 | bevestigingsset M10x110mm | | 0830097 | paar | 1,09 | 362 | 0 | |



Kranen

Douchegarnituur

Accessoires en
spiegels

sifonkap voor wastafel

| | | | | | | | |
|---------|---------------------------|----------|----------|------|--------|-----|---|
| 0120375 | | wit | 72800001 | stuk | 152,00 | 053 | 1 |
| 0130427 | | pergamon | 72800009 | stuk | 182,00 | 053 | 1 |
| 0830453 | set potschroeven 5.5x60mm | chroom | 0830453 | stuk | 2,28 | 362 | 0 |

Douchewanden

zuil voor wastafel

| | | | | | | | |
|---------|------------|----------|----------|------|--------|-----|---|
| 0120308 | 60/70/80cm | wit | 72920001 | stuk | 200,00 | 053 | 1 |
| 0130435 | 60/70/80cm | pergamon | 72920009 | stuk | 239,00 | 053 | 1 |

Toebehoren &
afvoeren

planchet

| | | | | | | | |
|---------|---------------------------|----------|----------|------|--------|-----|---|
| 0120804 | 60x15cm | wit | 78056001 | stuk | 97,00 | 053 | 1 |
| 0130419 | 60x15cm | pergamon | 78056009 | stuk | 118,00 | 053 | 1 |
| 0830453 | set potschroeven 5.5x60mm | chroom | 0830453 | stuk | 2,28 | 362 | 0 |



Spoel- &
installatiesystemen

staand bidet

| | | | | | | | | |
|---------|---------------------------|----------|----------|----------|--------|--------|-----|---|
| 0101222 | | wit | 74270001 | stuk | 295,00 | 053 | 1 | |
| 0110809 | | pergamon | 74270009 | stuk | 353,00 | 053 | 1 | |
| 0113964 | | ceramic+ | wit | 742700R1 | stuk | 358,00 | 053 | 1 |
| 0113972 | | ceramic+ | pergamon | 742700R3 | stuk | 416,00 | 053 | 1 |
| 0830453 | set potschroeven 5.5x60mm | chroom | 0830453 | stuk | 2,28 | 362 | 0 | |



Badkamermeubelen
en toiletkasten

wandbidet

| | | | | | | | | |
|---------|--|----------|----------|----------|--------|--------|-----|---|
| 0101249 | | wit | 74170001 | stuk | 393,00 | 053 | 1 | |
| 0111341 | | pergamon | 74170009 | stuk | 473,00 | 053 | 1 | |
| 0114006 | | ceramic+ | wit | 741700R1 | stuk | 456,00 | 053 | 1 |
| 0114014 | | ceramic+ | pergamon | 741700R3 | stuk | 536,00 | 053 | 1 |



Gootstenen en
wastroggen

Utiliteit

duoblokpot diepspoel AO z. reservoir

| | | | | | | | | |
|---------|--|----------|----------|----------|--------|--------|-----|---|
| 0100412 | | wit | 76680101 | stuk | 321,00 | 053 | 1 | |
| 0111163 | | pergamon | 76680109 | stuk | 386,00 | 053 | 1 | |
| 0114065 | | ceramic+ | wit | 766801R1 | stuk | 384,00 | 053 | 1 |
| 0114073 | | ceramic+ | pergamon | 766801R3 | stuk | 449,00 | 053 | 1 |



duoblokpot diepspoel PK z. reservoir

| | | | | | | | | |
|---------|--|----------|----------|----------|--------|--------|-----|---|
| 0100439 | | wit | 76681001 | stuk | 315,00 | 053 | 1 | |
| 0111171 | | pergamon | 76681009 | stuk | 380,00 | 053 | 1 | |
| 0114103 | | ceramic+ | wit | 766810R1 | stuk | 378,00 | 053 | 1 |
| 0114111 | | ceramic+ | pergamon | 766810R3 | stuk | 443,00 | 053 | 1 |

duoblokreservoir + binnenwerk

| | | | | | | | |
|---------|--|----------|----------|------|--------|-----|---|
| 0100242 | | wit | 77281101 | stuk | 270,00 | 053 | 1 |
| 0111198 | | pergamon | 77281109 | stuk | 300,00 | 053 | 1 |

| Art.nr | Specificaties | Kleur | Lev.nr | Ehd | Prijs | Grp | CC |
|--------|---------------|-------|--------|-----|-------|-----|----|
|--------|---------------|-------|--------|-----|-------|-----|----|

Villeroy & Boch Grangracia

wandclosetcombinatie diepspoel

| | | | | | | | |
|---------|----------|-----------|------------|------|---------|-----|---|
| 0101257 | | wit | GRANGRACIA | stuk | 842,00 | 053 | 1 |
| 0121789 | | pergamon | GRANGRACIA | stuk | 988,00 | 053 | 1 |
| 0110523 | | edelweiss | GRANGRACIA | stuk | 950,95 | 053 | 1 |
| 0114235 | ceramic+ | wit | GRANGRACIA | stuk | 862,00 | 053 | 1 |
| 0121797 | ceramic+ | pergamon | GRANGRACIA | stuk | 1051,00 | 053 | 1 |
| 0114243 | ceramic+ | edelweiss | GRANGRACIA | stuk | 1252,90 | 053 | 1 |



Sanitair producten

Baden /
douchebakken /
stoomcabines**wandduoblokpot diepspoel PK**

| | | | | | | | |
|---------|----------|----------|----------|------|--------|-----|---|
| 0101265 | | wit | 76561001 | stuk | 572,00 | 053 | 1 |
| 0121762 | | pergamon | 76561009 | stuk | 688,00 | 053 | 1 |
| 0121770 | ceramic+ | pergamon | 765610R3 | stuk | 751,00 | 053 | 1 |

Kranen

closetcombinatie diepspoel AO

| | | | | | | | |
|---------|----------------------------------|-----------|---------|------|--------|-----|---|
| 0101974 | | wit | 0101974 | stuk | 591,00 | 053 | 1 |
| 0111139 | | pergamon | 0111139 | stuk | 686,00 | 053 | 1 |
| 0110701 | | edelweiss | 0110701 | stuk | 738,15 | 053 | 1 |
| 0830453 | set potschroeven 5.5x60mm chroom | | 0830453 | stuk | 2,28 | 362 | 0 |



Douchegarnituur

Accessoires en
spiegels**closetcombinatie diepspoel PK**

| | | | | | | | |
|---------|----------------------------------|-----------|------------|------|--------|-----|---|
| 0101982 | | wit | 0101982 | stuk | 585,00 | 053 | 1 |
| 0111155 | | pergamon | 0111155 | stuk | 680,00 | 053 | 1 |
| 0111007 | | edelweiss | 0111007 | stuk | 730,55 | 053 | 1 |
| 0114200 | ceramic+ | wit | GRANGRACIA | stuk | 648,00 | 053 | 1 |
| 0114219 | ceramic+ | pergamon | GRANGRACIA | stuk | 743,00 | 053 | 1 |
| 0114227 | ceramic+ | edelweiss | GRANGRACIA | stuk | 872,90 | 053 | 1 |
| 0830453 | set potschroeven 5.5x60mm chroom | | 0830453 | stuk | 2,28 | 362 | 0 |

Douchewanden

Toebehoren &
afvoeren

Villeroy & Boch Hommage

wastafel

| | | | | | | | | | |
|---------|---------------------------|-------------------|----------|----------|----------|--------|--------|-----|---|
| 0104485 | 65x53cm | ceramic+ | wit | 710165R1 | stuk | 411,00 | 052 | 1 | |
| 0104493 | 65x53cm | ceramic+ | pergamon | 710165R3 | stuk | 411,00 | 052 | 1 | |
| 0141054 | 65x53cm | voor 3-gats kraan | ceramic+ | wit | 7101A2R1 | stuk | 411,00 | 052 | 1 |
| 0141062 | 65x53cm | voor 3-gats kraan | ceramic+ | pergamon | 7101A2R3 | stuk | 411,00 | 052 | 1 |
| 0104469 | 75x57cm | ceramic+ | wit | 710175R1 | stuk | 473,00 | 052 | 1 | |
| 0104477 | 75x57cm | ceramic+ | pergamon | 710175R3 | stuk | 473,00 | 052 | 1 | |
| 0141003 | 75x57cm | voor 3-gats kraan | ceramic+ | wit | 7101A1R1 | stuk | 473,00 | 052 | 1 |
| 0141011 | 75x57cm | voor 3-gats kraan | ceramic+ | pergamon | 7101A1R3 | stuk | 473,00 | 052 | 1 |
| 0830097 | bevestigingsset M10x110mm | | | 0830097 | paar | 1,09 | 362 | 0 | |

Spoel- &
installatiesystemenBadkamermeubelen
en toiletkasten**sifonkap voor wastafel**

| | | | | | | | |
|---------|----------|----------|----------|------|--------|-----|---|
| 0104566 | ceramic+ | wit | 723100R1 | stuk | 247,00 | 052 | 1 |
| 0104574 | ceramic+ | pergamon | 723100R3 | stuk | 247,00 | 052 | 1 |

Gootstenen en
wastroggen**zuil voor wastafel 65/75cm**

| | | | | | | | |
|---------|----------|----------|----------|------|--------|-----|---|
| 0104531 | ceramic+ | wit | 723200R1 | stuk | 302,00 | 052 | 1 |
| 0104558 | ceramic+ | pergamon | 723200R3 | stuk | 302,00 | 052 | 1 |

voorbouwwastafel

| | | | | | | | | | |
|---------|-----------|-------------------|----------|----------|----------|------|--------|-----|---|
| 0141097 | 55,5x45cm | voor 3-gats kraan | ceramic+ | wit | 7103A1R1 | stuk | 578,00 | 052 | 1 |
| 0141100 | 55,5x45cm | voor 3-gats kraan | ceramic+ | pergamon | 7103A1R3 | stuk | 578,00 | 052 | 1 |



Utiliteit

inbouwastafel







| | | | | | | | | | |
|---------|---------|-------------------|----------|----------|----------|--------|--------|-----|---|
| 0108707 | 63x52cm | ceramic+ | wit | 710263R1 | stuk | 500,00 | 052 | 1 | |
| 0108758 | 63x52cm | ceramic+ | pergamon | 710263R3 | stuk | 500,00 | 052 | 1 | |
| 0141135 | 63x52cm | voor 3-gats kraan | ceramic+ | wit | 7102A1R1 | stuk | 500,00 | 052 | 1 |
| 0141143 | 63x52cm | voor 3-gats kraan | ceramic+ | pergamon | 7102A1R3 | stuk | 500,00 | 052 | 1 |

**fontein**

| | | | | | | | | | |
|---------|--------------------------------------|-------------------|----------|----------|----------|--------|--------|-----|---|
| 0104507 | 50x41cm | ceramic+ | wit | 730150R1 | stuk | 306,00 | 052 | 1 | |
| 0104515 | 50x41cm | ceramic+ | pergamon | 730150R3 | stuk | 306,00 | 052 | 1 | |
| 0141186 | 50x41cm | voor 3-gats kraan | ceramic+ | wit | 7301A1R1 | stuk | 306,00 | 052 | 1 |
| 0141194 | 50x41cm | voor 3-gats kraan | ceramic+ | pergamon | 7301A1R3 | stuk | 306,00 | 052 | 1 |
| 0830240 | bevestigingsset voor fontein M8x90mm | | | 0830240 | stuk | 0,85 | 362 | 0 | |

**sifonkap voor fontein**

| | | | | | | | |
|---------|----------|----------|----------|------|--------|-----|---|
| 0104582 | ceramic+ | wit | 723300R1 | stuk | 247,00 | 052 | 1 |
| 0104639 | ceramic+ | pergamon | 723300R3 | stuk | 247,00 | 052 | 1 |

| | Art.nr | Specificaties | Kleur | Lev.nr | Ehd | Prijs | Grp | CC |
|---|---------------------|----------------------------|-------------|----------|------|---------|-----|----|
| Villeroy & Boch Hommage | | | | | | | | |
| Sanitair producten | wandbidet | | | | | | | |
| | 0104655 | ceramic+ | wit | 744100R1 | stuk | 496,00 | 052 | 1 |
| | 0103663 | ceramic+ | pergamon | 744100R3 | stuk | 496,00 | 052 | 1 |
|  | | | | | | | | |
| staand bidet | | | | | | | | |
| Baden / douchebakken / stoomcabines | 0108621 | ceramic+ | wit | 744200R1 | stuk | 449,00 | 052 | 1 |
| | 0108622 | ceramic+ | pergamon | 744200R3 | stuk | 449,00 | 052 | 1 |
| Kranen | 0108625 | voor 3-gats kraan ceramic+ | wit | 7442A1R1 | stuk | 449,00 | 052 | 1 |
| | 0108627 | voor 3-gats kraan ceramic+ | pergamon | 7442A1R3 | stuk | 449,00 | 052 | 1 |
| wandclosetpot diepspoel | | | | | | | | |
| Douchegarnituur | 0104671 | ceramic+ | wit | 666110R1 | stuk | 462,00 | 052 | 1 |
| | 0104698 | ceramic+ | pergamon | 666110R3 | stuk | 462,00 | 052 | 1 |
|  | | | | | | | | |
| closetzitting dubbel | | | | | | | | |
| Accessoires en spiegels | 0104701 | | wit | 88096101 | stuk | 154,00 | 052 | 1 |
| | 0104728 | | pergamon | 88096109 | stuk | 171,00 | 052 | 1 |
| closetcombinatie Purair PK m. zitting | | | | | | | | |
| Douchewanden | 1023660 | m. ceramic+ | wit | 6662N0R1 | stuk | 1406,00 | 052 | 1 |
| | 1023662 | m. ceramic+ | pergamon | 6662N0R3 | stuk | 1423,00 | 052 | 1 |
| | 1023663 | | starwhite | 6662N0R2 | stuk | 1423,00 | 052 | 1 |
| onderkast berk | | | | | | | | |
| Toebehoren & afvoeren | 0106690 | 68,5x75cm | greep=wit | 89950001 | stuk | 1343,00 | 323 | 1 |
| | 0107298 | 68,5x75cm | greep=perg. | 89950009 | stuk | 1343,00 | 323 | 1 |
| | 0106704 | 98,5x62x85 | greep=wit | 89791001 | stuk | 2122,00 | 323 | 1 |
| | 0107328 | 98,5x62x85 | greep=perg. | 89791009 | stuk | 2122,00 | 323 | 1 |
|  | | | | | | | | |
| Spoel- & installatiesystemen | | | | | | | | |
|  | | | | | | | | |
| Badkamermeubelen en toiletkasten | | | | | | | | |
|  | | | | | | | | |
| Gootstenen en wastroggen | | | | | | | | |
| Utiliteit | commode berk | | | | | | | |
| | 0106712 | 98,5x62x85 | greep=wit | 89781001 | stuk | 1942,00 | 323 | 1 |
| | 0107344 | 98,5x62x85 | greep=perg. | 89781009 | stuk | 1942,00 | 323 | 1 |
|  | | | | | | | | |
| vertico berk/marmer | | | | | | | | |
| Utiliteit | 0106860 | 56,5x190cm aanslag links | greep=wit | 89651001 | stuk | 2244,00 | 323 | 1 |
| | 0107352 | 56,5x190cm aanslag links | greep=perg. | 89651009 | stuk | 2244,00 | 323 | 1 |
| | 0106895 | 56,5x190cm aanslag rechts | greep=wit | 89651101 | stuk | 2244,00 | 323 | 1 |
| | 0107360 | 56,5x190cm aanslag rechts | greep=perg. | 89651109 | stuk | 2244,00 | 323 | 1 |
|  | | | | | | | | |

| Art.nr | Specificaties | Kleur | Lev.nr | Ehd | Prijs | Grp | CC |
|--------|---------------|-------|--------|-----|-------|-----|----|
|--------|---------------|-------|--------|-----|-------|-----|----|

Villeroy & Boch Hommage

lage kast berk/marmer

| | | | | | | | |
|---------|------------|----------------|-------------|----------|------|---------|-------|
| 0106984 | 56,5x110cm | aanslag links | greep=wit | 89652001 | stuk | 1683,00 | 323 1 |
| 0107379 | 56,5x110cm | aanslag links | greep=perg. | 89652009 | stuk | 1683,00 | 323 1 |
| 0107018 | 56,5x110cm | aanslag rechts | greep=wit | 89652101 | stuk | 1683,00 | 323 1 |
| 0107387 | 56,5x110cm | aanslag rechts | greep=perg. | 89652109 | stuk | 1683,00 | 323 1 |
| 0107204 | 44x85cm | aanslag links | greep=wit | 89641001 | stuk | 1360,00 | 323 1 |
| 0107417 | 44x85cm | aanslag links | greep=perg. | 89641009 | stuk | 1360,00 | 323 1 |
| 0107212 | 44x85cm | aanslag rechts | greep=wit | 89641101 | stuk | 1360,00 | 323 1 |
| 0107476 | 44x85cm | aanslag rechts | greep=perg. | 89641109 | stuk | 1360,00 | 323 1 |



Sanitair producten

Baden /
douchebakken /
stoomcabines

Kranen

Douchegarnituur

Accessoires en
spiegels

spiegel

| | | | | | | |
|---------|-----------|------|----------|------|--------|-------|
| 0107247 | 56x4x75cm | berk | 85650000 | stuk | 498,00 | 323 1 |
|---------|-----------|------|----------|------|--------|-------|



Villeroy & Boch Loop & Friends

opbouw wastafel m. overloop z. kraangat

| | | | | | | | |
|---------|---------|----------|----------|----------|------|--------|-------|
| 0100049 | 51x34cm | | wit | 61451001 | stuk | 239,00 | 052 1 |
| 0100051 | 51x34cm | | pergamon | 61451009 | stuk | 289,00 | 052 1 |
| 0100050 | 51x34cm | ceramic+ | wit | 614510R1 | stuk | 302,00 | 052 1 |
| 0100052 | 51x34cm | ceramic+ | pergamon | 614510R3 | stuk | 352,00 | 052 1 |



Douchewanden

Toebehoren &
afvoeren

opbouw wastafel z. overloop z. kraangat

| | | | | | | | |
|---------|---------|----------|----------|----------|------|--------|-------|
| 0100057 | 51x34cm | | wit | 61451101 | stuk | 272,00 | 052 1 |
| 0100059 | 51x34cm | | pergamon | 61451109 | stuk | 321,00 | 052 1 |
| 0100058 | 51x34cm | ceramic+ | wit | 614511R1 | stuk | 335,00 | 052 1 |
| 0100060 | 51x34cm | ceramic+ | pergamon | 614511R3 | stuk | 384,00 | 052 1 |

Spoel- &
installatiesystemen

opbouw wastafel m. overloop z. kraangat

| | | | | | | | |
|---------|---------|----------|----------|----------|------|--------|-------|
| 0100045 | 67x45cm | | wit | 61452001 | stuk | 277,00 | 052 1 |
| 0100047 | 67x45cm | | pergamon | 61452009 | stuk | 334,00 | 052 1 |
| 0100046 | 67x45cm | ceramic+ | wit | 614520R1 | stuk | 340,00 | 052 1 |
| 0100048 | 67x45cm | ceramic+ | pergamon | 614520R3 | stuk | 397,00 | 052 1 |

Badkamermeubelen
en toiletkasten

opbouw wastafel z. overloop z. kraangat

| | | | | | | | |
|---------|---------|----------|----------|----------|------|--------|-------|
| 0100053 | 67x45cm | | wit | 61452101 | stuk | 310,00 | 052 1 |
| 0100055 | 67x45cm | | pergamon | 61452109 | stuk | 367,00 | 052 1 |
| 0100054 | 67x45cm | ceramic+ | wit | 614521R1 | stuk | 373,00 | 052 1 |
| 0100056 | 67x45cm | ceramic+ | pergamon | 614521R3 | stuk | 430,00 | 052 1 |

Gootstenen en
wastroggen

onderbouw wastafel m. overloop z. kraangat

| | | | | | | | |
|---------|---------|----------|----------|----------|------|--------|-------|
| 0100065 | 51x34cm | | wit | 61631001 | stuk | 276,00 | 052 1 |
| 0100068 | 51x34cm | | pergamon | 61631009 | stuk | 331,00 | 052 1 |
| 0100067 | 51x34cm | ceramic+ | wit | 616310R1 | stuk | 339,00 | 052 1 |
| 0100069 | 51x34cm | ceramic+ | pergamon | 616310R3 | stuk | 394,00 | 052 1 |



Utiliteit

onderbouw wastafel z. overloop z. kraangat







| | | | | | | | |
|---------|---------|----------|----------|----------|------|--------|-------|
| 0100074 | 51x34cm | | wit | 61631101 | stuk | 308,00 | 052 1 |
| 0100086 | 51x34cm | | pergamon | 61631109 | stuk | 363,00 | 052 1 |
| 0100076 | 51x34cm | ceramic+ | wit | 616311R1 | stuk | 371,00 | 052 1 |
| 0100087 | 51x34cm | ceramic+ | pergamon | 616311R3 | stuk | 426,00 | 052 1 |







onderbouw wastafel m. overloop z. kraangat

| | | | | | | | |
|---------|---------|----------|----------|----------|------|--------|-------|
| 0100061 | 60x38cm | | wit | 61632001 | stuk | 319,00 | 052 1 |
| 0100063 | 60x38cm | | pergamon | 61632009 | stuk | 384,00 | 052 1 |
| 0100062 | 60x38cm | ceramic+ | wit | 616320R1 | stuk | 382,00 | 052 1 |
| 0100064 | 60x38cm | ceramic+ | pergamon | 616320R3 | stuk | 447,00 | 052 1 |

onderbouw wastafel z. overloop z. kraangat

| | | | | | | | |
|---------|---------|----------|----------|----------|------|--------|-------|
| 0100070 | 60x38cm | | wit | 61632101 | stuk | 352,00 | 052 1 |
| 0100072 | 60x38cm | | pergamon | 61632109 | stuk | 416,00 | 052 1 |
| 0100071 | 60x38cm | ceramic+ | wit | 616321R1 | stuk | 415,00 | 052 1 |
| 0100073 | 60x38cm | ceramic+ | pergamon | 616321R3 | stuk | 479,00 | 052 1 |

| | Art.nr | Specificaties | Kleur | Lev.nr | Ehd | Prijs | Grp | CC | |
|---|---|---|---|-----------|----------|--------|--------|-----|---|
| Sanitair producten | Villeroy & Boch Loop & Friends | | | | | | | | |
| |  | opzet wastafel m. overloop z. kraangat | | | | | | | |
| | | 0100088 | 66x43cm | wit | 61671001 | stuk | 344,00 | 052 | 1 |
| | | 0100090 | 66x43cm | pergamon | 61671009 | stuk | 414,00 | 052 | 1 |
| | | 0100089 | 66x43cm ceramic+ | wit | 616710R1 | stuk | 407,00 | 052 | 1 |
| 0100091 | | 66x43cm ceramic+ | pergamon | 616710R3 | stuk | 477,00 | 052 | 1 | |
| Baden / douchebakken / stoomcabines | opzet wastafel z. overloop z. kraangat | | | | | | | | |
| | 0100092 | 66x43cm | wit | 61671101 | stuk | 376,00 | 052 | 1 | |
| | 0100094 | 66x43cm | pergamon | 61671109 | stuk | 447,00 | 052 | 1 | |
| | 0100093 | 66x43cm ceramic+ | wit | 616711R1 | stuk | 439,00 | 052 | 1 | |
| | 0100095 | 66x43cm ceramic+ | pergamon | 616711R3 | stuk | 510,00 | 052 | 1 | |
| Kranen | New Wave onderbouw wastafel | | | | | | | | |
| | 0100407 | 51x32cm m. overloop z. kraangat | wit | 51925001 | stuk | 357,00 | 053 | 1 | |
| | 0100408 | 51x32cm m. overloop z. kraangat | pergamon | 51925009 | stuk | 429,00 | 052 | 1 | |
| | 0100409 | 51x32cm m. overl. z. kraang. ceramic+ | wit | 519250R1 | stuk | 420,00 | 052 | 1 | |
| | 0100410 | 51x32cm m. overl. z. kraang. ceramic+ | starwhite | 519250R2 | stuk | 492,00 | 053 | 1 | |
| Douchegarnituur | 0100411 | 51x32cm m. overl. z. kraang. ceramic+ | pergamon | 519250R3 | stuk | 492,00 | 052 | 1 | |
| | 0100274 | 51x32cm z. overloop z. kraangat | wit | 51925101 | stuk | 390,00 | 052 | 1 | |
| | 0100275 | 51x32cm z. overloop z. kraangat | pergamon | 51925109 | stuk | 462,00 | 052 | 1 | |
| | 0100276 | 51x32cm z. overl. z. kraang. ceramic+ | wit | 519251R1 | stuk | 453,00 | 052 | 1 | |
| | 0100278 | 51x32cm z. overl. z. kraang. ceramic+ | starwhite | 519251R2 | stuk | 524,00 | 052 | 1 | |
| Accessoires en spiegels | 0100279 | 51x32cm z. overl. z. kraang. ceramic+ | pergamon | 519251R3 | stuk | 525,00 | 052 | 1 | |
| | New Wave opzetwastafel | | | | | | | | |
| |  | 0100654 | 60x45.5cm m. overloop z. kraangat | wit | 51906001 | stuk | 367,00 | 052 | 1 |
| | | 0100655 | 60x45.5cm m. overloop z. kraangat | pergamon | 51906009 | stuk | 441,00 | 052 | 1 |
| | | 0100656 | 60x45.5cm m. overl. z. kraang. ceramic+ | wit | 519060R1 | stuk | 430,00 | 052 | 1 |
| 0100657 | | 60x45.5cm m. overl. z. kraang. ceramic+ | starwhite | 519060R2 | stuk | 504,00 | 052 | 1 | |
| 0100658 | | 60x45.5cm m. overl. z. kraang. ceramic+ | pergamon | 519060R3 | stuk | 504,00 | 052 | 1 | |
| Douchewanden | 0100571 | 60x45.5cm z. overloop z. kraangat | wit | 51906101 | stuk | 399,00 | 053 | 1 | |
| | 0100572 | 60x45.5cm z. overloop z. kraangat | pergamon | 51906109 | stuk | 473,00 | 053 | 1 | |
| | 0100573 | 60x45.5cm z. overl. z. kraang. ceramic+ | wit | 519061R1 | stuk | 462,00 | 052 | 1 | |
| | 0100578 | 60x45.5cm z. overl. z. kraang. ceramic+ | starwhite | 519061R2 | stuk | 536,00 | 052 | 1 | |
| | 0100579 | 60x45.5cm z. overl. z. kraang. ceramic+ | pergamon | 519061R3 | stuk | 536,00 | 052 | 1 | |
| Toebehoren & afvoeren | New Wave opbouw wastafel | | | | | | | | |
| |  | 0100581 | 60x45.5cm m. overloop z. kraangat | wit | 51916001 | stuk | 308,00 | 052 | 1 |
| | | 0100582 | 60x45.5cm m. overloop z. kraangat | pergamon | 51916009 | stuk | 371,00 | 052 | 1 |
| | | 0100583 | 60x45.5cm m. overl. z. kraang. ceramic+ | wit | 519160R1 | stuk | 371,00 | 052 | 1 |
| | | 0100584 | 60x45.5cm m. overl. z. kraang. ceramic+ | starwhite | 519160R2 | stuk | 433,00 | 053 | 1 |
| 0100585 | | 60x45.5cm m. overl. z. kraang. ceramic+ | pergamon | 519160R3 | stuk | 434,00 | 052 | 1 | |
| Spoel- & installatiesystemen | Villeroy & Boch Magnum | | | | | | | | |
| | wastafel | | | | | | | | |
| |  | 0103462 | 60x53cm | wit | 71336001 | stuk | 226,00 | 052 | 0 |
| | | 0103470 | 60x53cm | pergamon | 71336009 | stuk | 272,00 | 052 | 1 |
| | | 0103464 | 60x53cm ceramic+ | wit | 713360R1 | stuk | 289,00 | 052 | 1 |
| 0100785 | | 60x53cm ceramic+ | pergamon | 713360R3 | stuk | 335,00 | 052 | 1 | |
| 0103497 | | 65x54cm | wit | 71336501 | stuk | 239,00 | 052 | 1 | |
| Badkamermeubelen en toiletkasten | 0103500 | 65x54cm | pergamon | 71336509 | stuk | 289,00 | 052 | 1 | |
| | 0107220 | 65x54cm ceramic+ | wit | 713365R1 | stuk | 302,00 | 052 | 1 | |
| | 0107239 | 65x54cm ceramic+ | pergamon | 713365R3 | stuk | 352,00 | 052 | 1 | |
| | 0830097 | bevestigingsset M10x110mm | | 0830097 | paar | 1,09 | 362 | 0 | |
| | sifonkap voor wastafel | | | | | | | | |
|  | 0103756 | | wit | 72090001 | stuk | 154,00 | 052 | 0 | |
| | 0103764 | | pergamon | 72090009 | stuk | 186,00 | 052 | 1 | |
| | 0830453 | set potschroeven 5.5x60mm chroom | | 0830453 | stuk | 2,28 | 362 | 0 | |
| zuil voor wastafel | | | | | | | | | |
|  | 0103713 | | wit | 72065001 | stuk | 192,00 | 052 | 0 | |
| | 0103721 | | pergamon | 72065009 | stuk | 232,00 | 052 | 1 | |
| planchet | | | | | | | | | |
|  | 0103683 | 60x16cm | wit | 78336001 | stuk | 124,00 | 052 | 0 | |
| | 0103691 | 60x16cm | pergamon | 78336009 | stuk | 148,00 | 052 | 1 | |
| | 0830453 | set potschroeven 5.5x60mm chroom | | 0830453 | stuk | 2,28 | 362 | 0 | |

| Art.nr | Specificaties | Kleur | Lev.nr | Ehd | Prijs | Grp | CC | |
|--|---------------------------------------|-----------|----------|------|--------|-----|----|---|
| Villeroy & Boch Magnum | | | | | | | | |
| fontein | | | | | | | | |
| 0103535 | 45x34cm | wit | 73334501 | stuk | 146,00 | 052 | 0 |  |
| 0103543 | 45x34cm | pergamon | 73334509 | stuk | 177,00 | 052 | 1 | |
| 0101042 | 45x34cm ceramic+ | wit | 733345R1 | stuk | 209,00 | 052 | 1 | |
| 0107255 | 45x34cm ceramic+ | pergamon | 733345R3 | stuk | 240,00 | 052 | 1 | |
| 0103578 | 50x36cm | wit | 73335001 | stuk | 165,00 | 052 | 1 | |
| 0103594 | 50x36cm | pergamon | 73335009 | stuk | 200,00 | 052 | 1 | |
| 0107263 | 50x36cm ceramic+ | wit | 733350R1 | stuk | 228,00 | 052 | 1 | |
| 0107271 | 50x36cm ceramic+ | pergamon | 733350R3 | stuk | 263,00 | 052 | 1 | |
| 0830240 | bevestigingsset voor fontein M8x90mm | | 0830240 | stuk | 0,85 | 362 | 0 | |
| sifonkap voor fontein | | | | | | | | |
| 0103780 | | wit | 72100001 | stuk | 154,00 | 052 | 1 |  |
| 0103799 | | pergamon | 72100009 | stuk | 186,00 | 052 | 1 | |
| 0830453 | set potschroeven 5.5x60mm chroom | | 0830453 | stuk | 2,28 | 362 | 0 | |
| staand bidet | | | | | | | | |
| 0103616 | | wit | 74320001 | stuk | 331,00 | 052 | 1 |  |
| 0103624 | | pergamon | 74320009 | stuk | 397,00 | 052 | 1 | |
| 0103633 | ceramic+ | wit | 743200R1 | stuk | 394,00 | 052 | 1 | |
| 0107301 | ceramic+ | pergamon | 743200R3 | stuk | 460,00 | 052 | 1 | |
| wandbidet | | | | | | | | |
| 0103640 | | wit | 74310001 | stuk | 416,00 | 052 | 1 |  |
| 0103667 | | pergamon | 74310009 | stuk | 500,00 | 052 | 1 | |
| 0103642 | ceramic+ | wit | 743100R1 | stuk | 479,00 | 052 | 1 | |
| 0107336 | ceramic+ | pergamon | 743100R3 | stuk | 563,00 | 052 | 1 | |
| wandclosetpot diepspoel | | | | | | | | |
| 0103845 | | wit | 76311001 | stuk | 300,00 | 052 | 0 |  |
| 0103861 | | pergamon | 76311009 | stuk | 361,00 | 052 | 1 | |
| 0120552 | ceramic+ | wit | 763110R1 | stuk | 363,00 | 052 | 1 | |
| 0103863 | ceramic+ | pergamon | 763110R3 | stuk | 424,00 | 052 | 1 | |
| wandclosetpot vlakspoel | | | | | | | | |
| 0103810 | | wit | 76271001 | stuk | 365,00 | 052 | 0 |  |
| 0103825 | | pergamon | 76271009 | stuk | 439,00 | 052 | 1 | |
| 0103812 | ceramic+ | wit | 762710R1 | stuk | 428,00 | 052 | 1 | |
| 0120614 | ceramic+ | pergamon | 762710R3 | stuk | 502,00 | 052 | 1 | |
| closetcombinatie diepspoel | | | | | | | | |
| 0104043 | | wit | MAGNUM | stuk | 571,00 | 052 | 0 |  |
| 0104051 | | pergamon | MAGNUM | stuk | 661,00 | 052 | 1 | |
| 0104078 | | edelweiss | MAGNUM | stuk | 853,10 | 052 | 1 | |
| 0109053 | ceramic+ | wit | MAGNUM | stuk | 634,00 | 052 | 1 | |
| 0109061 | ceramic+ | pergamon | MAGNUM | stuk | 724,00 | 052 | 1 | |
| 0102221 | vario afvoerbocht verticaal 160-250mm | | 87010000 | stuk | 68,00 | 052 | 0 | |
| 0102225 | vario afvoerbocht verticaal 70-160mm | | 87110000 | stuk | 68,00 | 052 | 1 | |
| duoblokpot diepspoel z. reservoir | | | | | | | | |
| 0103918 | | wit | 76441001 | stuk | 314,00 | 052 | 0 | |
| 0103926 | | pergamon | 76441009 | stuk | 376,00 | 052 | 1 | |
| 0103921 | ceramic+ | wit | 764410R1 | stuk | 377,00 | 052 | 1 | |
| 0109045 | ceramic+ | pergamon | 764410R3 | stuk | 439,00 | 052 | 1 | |
| duoblokreservoir + binnenwerk | | | | | | | | |
| 0103985 | | wit | 77331101 | stuk | 257,00 | 052 | 0 | |
| 0103993 | | pergamon | 77331109 | stuk | 285,00 | 052 | 1 | |
| closetzitting dubbel | | | | | | | | |
| 0111905 | | wit | 99506101 | stuk | 120,00 | 052 | 0 | |
| 0111903 | | pergamon | 99506109 | stuk | 133,00 | 052 | 1 | |

Sanitair producten

Baden /
douchebakken /
stoomcabines

Kranen

Doucheapparatuur









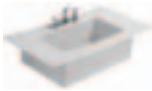

Accessoires en
spiegels







Douchewanden









Toebehoren &
afvoerenSpoel- &
installatiesystemenBadkamermeubelen
en toiletkastenGootstenen en
wastroggen

Utiliteit

| | Art.nr | Specificaties | Kleur | Lev.nr | Ehd | Prijs | Grp | CC |
|------------------------------------|---|---|-----------|----------|------|--------|-----|----|
| Villeroy & Boch Magnum | | | | | | | | |
| Sanitair producten | wandurinoir voor deksel achterinlaat | | | | | | | |
| | 0104019 | | wit | 75330101 | stuk | 365,00 | 052 | 1 |
| | 0104027 | | pergamon | 75330109 | stuk | 439,00 | 052 | 1 |
| | 0107425 | ceramic+ | wit | 753301R1 | stuk | 428,00 | 052 | 1 |
| | 0107433 | ceramic+ | pergamon | 753301R3 | stuk | 502,00 | 052 | 1 |
| | 0100951 | inlaatfitting urinoir Esta/Magnum/Stratos | | 99330000 | stuk | 27,00 | 053 | 1 |
| | 0104590 | urinoirsifon horizontaal | | 93090000 | stuk | 25,50 | 053 | 0 |
| | 0104604 | urinoirsifon verticaal | | 93080000 | stuk | 25,50 | 053 | 1 |
| | 0104612 | aansluitgarnituur urinoir Magnum-Neu | | 93190000 | stuk | 70,00 | 053 | 1 |
| | deksel voor wandurinoir | | | | | | | |
| Kranen | 0102474 | | wit | 99510001 | stuk | 125,00 | 052 | 1 |
| | 0102482 | | pergamon | 99510009 | stuk | 139,00 | 052 | 1 |
| Villeroy & Boch Memento | | | | | | | | |
| Douchegarnituur | wastafel | | | | | | | |
| | 1023705 | 80x47cm z. overloop z. kraangat m. ceramic+ | wit | 513383R1 | stuk | 633,00 | 052 | 1 |
| | 1023706 | 80x47cm z. overloop z. kraangat m. ceramic+ | starwhite | 513383R2 | stuk | 633,00 | 052 | 1 |
| | 1023703 | 80x47cm z. overloop m. 2 krngat. m. ceramic+ | wit | 513381R1 | stuk | 599,00 | 052 | 1 |
| | 1023704 | 80x47cm z. overloop m. 3 krngat. m. ceramic+ | starwhite | 513381R2 | stuk | 599,00 | 052 | 1 |
| Accessoires en spiegels | 0830097 | bevestigingsset M10x110mm | | 0830097 | paar | 1,09 | 362 | 0 |
| | wastafel dubbel | | | | | | | |
| Douchewanden | 1023694 | 120x47cm z. overloop z. kraangat m. ceramic+ | wit | 5133C3R1 | stuk | 943,00 | 052 | 1 |
| | 1023695 | 120x47cm z. overloop z. kraangat m. ceramic+ | starwhite | 5133C3R2 | stuk | 942,00 | 052 | 1 |
| | 1023692 | 120x47cm z. overloop m. 2 krngat. m. ceramic+ | wit | 5133C1R1 | stuk | 909,00 | 052 | 1 |
| | 1023693 | 120x47cm z. overloop m. 2 krngat. m. ceramic+ | starwhite | 5133C1R2 | stuk | 908,00 | 052 | 1 |
| | 0830097 | bevestigingsset M10x110mm | | 0830097 | paar | 1,09 | 362 | 0 |
| Toebehoren & afvoeren | meubelwastafel | | | | | | | |
| | 1023710 | 80x47cm z. overloop z. kraangat m. ceramic+ | wit | 51338FR1 | stuk | 684,00 | 052 | 1 |
| | 1023711 | 80x47cm z. overloop z. kraangat m. ceramic+ | starwhite | 51338FR2 | stuk | 684,00 | 052 | 1 |
| | 1023708 | 80x47cm z. overloop m. 3 krngat. m. ceramic+ | wit | 51338GR1 | stuk | 650,00 | 052 | 1 |
| | 1023709 | 80x47cm z. overloop m. 3 krngat. m. ceramic+ | starwhite | 51338GR2 | stuk | 650,00 | 052 | 1 |
| Spoel- & installatiesystemen | 0830097 | bevestigingsset M10x110mm | | 0830097 | paar | 1,09 | 362 | 0 |
| | meubelwastafel dubbel | | | | | | | |
| Badkamermeubelen en toiletkasten | 1023701 | 120x47cm z. overloop z. kraangat m. ceramic+ | wit | 5133CFR1 | stuk | 994,00 | 052 | 1 |
| | 1023702 | 120x47cm z. overloop z. kraangat m. ceramic+ | starwhite | 5133CFR2 | stuk | 994,00 | 052 | 1 |
| | 1023699 | 120x47cm z. overloop m. 2 krngat. m. ceramic+ | wit | 5133CGR1 | stuk | 960,00 | 052 | 1 |
| | 1023700 | 120x47cm z. overloop m. 2 krngat. m. ceramic+ | starwhite | 5133CGR2 | stuk | 960,00 | 052 | 1 |
| | 0830097 | bevestigingsset M10x110mm | | 0830097 | paar | 1,09 | 362 | 0 |
| Gootstenen en wastroggen | opzetwastafel | | | | | | | |
| | 1023716 | 50x42cm m. overloop m. kraangat m. ceramic+ | wit | 513550R1 | stuk | 310,00 | 052 | 1 |
| | 1023717 | 50x42cm m. overloop m. kraangat m. ceramic+ | starwhite | 513550R2 | stuk | 310,00 | 052 | 1 |
| | 1023718 | 50x42cm z. overloop m. kraangat m. ceramic+ | wit | 513551R1 | stuk | 310,00 | 052 | 1 |
| | 1023719 | 50x42cm z. overloop m. kraangat m. ceramic+ | starwhite | 513551R2 | stuk | 310,00 | 052 | 1 |
| | 1023712 | 60x42cm m. overloop m. kraangat m. ceramic+ | wit | 513560R1 | stuk | 339,00 | 052 | 1 |
| | 1023713 | 60x42cm m. overloop m. kraangat m. ceramic+ | starwhite | 513560R2 | stuk | 338,00 | 052 | 1 |
| | 1023714 | 60x42cm z. overloop m. kraangat m. ceramic+ | wit | 513561R1 | stuk | 339,00 | 052 | 1 |
| | 1023715 | 60x42cm z. overloop m. kraangat m. ceramic+ | starwhite | 513561R2 | stuk | 338,00 | 052 | 1 |
| Utiliteit | handdoekhouder | | | | | | | |
| | 1023697 | 42x14cm | glans RVS | 874942D7 | stuk | 135,00 | 052 | 1 |
| | 1023707 | 72x14cm | glans RVS | 874980D7 | stuk | 179,00 | 052 | 1 |
| | 1023696 | 112x14cm | glans RVS | 874912D7 | stuk | 249,00 | 052 | 1 |
| afvoerplug niet afsluitbaar | | | | | | | | |
| | 1023698 | | chrom | 87987061 | stuk | 49,00 | 052 | 1 |

| Art.nr | Specificaties | Kleur | Lev.nr | Ehd | Prijs | Grp | CC | | |
|--------------------------------------|-------------------------------------|-------|----------|------|---------|-----|----|---|---|
| Villeroy & Boch Nagano | | | | | | | | | |
| wastafel | | | | | | | | | |
| 0108774 | 100x53cm ceramic+ | wit | 717110R1 | stuk | 772,00 | 052 | 1 |  | Sanitair producten |
| 0140546 | 100x53cm voor 3-gats kraan ceramic+ | wit | 7171A1R1 | stuk | 772,00 | 052 | 1 | | |
| 0830097 | bevestigingsset M10x110mm | | 0830097 | paar | 1,09 | 362 | 0 | | |
| onderkast | | | | | | | | | |
| 0108782 | 93,5cm | eiken | 980300D9 | stuk | 2027,00 | 323 | 1 |  | Baden / douchebakken / stoomcabines |
| lage kast | | | | | | | | | |
| 0108790 | | eiken | 980700D9 | stuk | 1562,00 | 323 | 1 |  | Kranen |
| lage kast m. klapdeur | | | | | | | | | |
| 0108804 | | eiken | 980800D9 | stuk | 1702,00 | 323 | 1 |  | Douchegarnituur |
| wasmand | | | | | | | | | |
| 0108812 | 51,5x63,5cm | eiken | 980900D9 | stuk | 1454,00 | 323 | 1 |  | Accessoires en spiegels |
| rek | | | | | | | | | |
| 0108820 | 29x180x38cm | eiken | 982000D9 | stuk | 688,00 | 323 | 1 |  | Douchewanden |
| bank | | | | | | | | | |
| 0108839 | 87x33x35cm | eiken | 981000D9 | stuk | 680,00 | 323 | 1 |  | Toebehoren & afvoeren |
| spiegel | | | | | | | | | |
| 0108847 | 75/90,5cm | eiken | 980400D9 | stuk | 612,00 | 323 | 1 |  | Spoel- & installatiesystemen |
| Villeroy & Boch New Haven | | | | | | | | | |
| wastafel | | | | | | | | | |
| 0107441 | 60x49cm ceramic+ | wit | 714461R1 | stuk | 692,00 | 052 | 1 |  | Badkamermeubelen en toiletkasten |
| 0107468 | 80x57cm ceramic+ | wit | 714481R1 | stuk | 755,00 | 052 | 1 | | |
| | | | | | | | |  | Gootstenen en wastroggen |
| | | | | | | | | | Utiliteit |

| | Art.nr | Specificaties | Kleur | Lev.nr | Ehd | Prijs | Grp | CC |
|---|---|--|---|------------|----------|--------|---------|-------|
| Sanitair producten | Villeroy & Boch New Haven | | | | | | | |
| | installatie-element voor bevestiging z. wastafelonderbouw | | | | | | | |
| | 0104175 | | | 87410000 | stuk | 184,00 | 052 | 1 |
| Baden / douchebakken / stoomcabines |  | wandbidet 0104189 | ceramic+ | wit | 7413B1R1 | stuk | 796,00 | 052 1 |
| | Kranen | zitrand voor bidet 0104191 | | wit | 88310001 | stuk | 184,00 | 052 1 |
| Douchegarnituur | wandclosetpot diepspoel 0120622 | ceramic+ | wit | 7694B0R1 | stuk | 717,00 | 052 1 | |
| Accessoires en spiegels | closetzitting dubbel 0104221 | | wit | 88306101 | stuk | 243,00 | 052 1 | |
| Douchewanden |  | wastafelonderbouw voor wastafel 60cm 0172014 | | larix | 898800F2 | stuk | 1582,00 | 323 1 |
| | Toebehoren & afvoeren |  | wastafelonderbouw voor wastafel 60cm riet 0172022 | riet/larix | 898810F2 | stuk | 1873,00 | 323 1 |
| Spoel- & installatiesystemen |  | wastafelonderbouw voor wastafel 80cm 0171980 | | larix | 898600F2 | stuk | 1650,00 | 323 1 |
| Badkamermeubelen en toiletkasten |  | wastafelonderbouw voor wastafel 80cm riet 0172006 | | riet/larix | 898620F2 | stuk | 2190,00 | 323 1 |
| Gootstenen en wastroggen |  | spiegel m. glasplanchet 0172049 86x60cm | | larix | 899300F2 | stuk | 940,00 | 323 1 |
| Utiliteit |  | spiegel m. verlichting 0172057 86x60cm | | larix | 899400F2 | stuk | 2391,00 | 323 1 |

| Art.nr | Specificaties | Kleur | Lev.nr | Ehd | Prijs | Grp | CC | |
|---------------------------------------|--------------------------------------|----------------|----------|------|--------|-----|----|---|
| Villeroy & Boch New Haven | | | | | | | | |
| rieten mand | | | | | | | | |
| 0172030 | | | 89870000 | stuk | 180,00 | 323 | 1 | |
| Villeroy & Boch Oblic | | | | | | | | |
| wastafel rechts | | | | | | | | |
| 0104760 | 60x17.5/35cm | wit | 71046R01 | stuk | 222,00 | 052 | 1 |  |
| 0104779 | 60x17.5/35cm | pergamon | 71046R09 | stuk | 268,00 | 052 | 1 | |
| 0104744 | 60x17.5/35cm ceramic+ | wit | 71046RR1 | stuk | 285,00 | 052 | 1 | |
| 0104752 | 60x17.5/35cm ceramic+ | pergamon | 71046RR3 | stuk | 331,00 | 052 | 1 | |
| 0830097 | bevestigingsset M10x110mm | | 0830097 | paar | 1,09 | 362 | 0 | |
| wastafel links | | | | | | | | |
| 0104817 | 60x17.5/35cm | wit | 71046L01 | stuk | 222,00 | 052 | 1 |  |
| 0105554 | 60x17.5/35cm | pergamon | 71046L09 | stuk | 268,00 | 052 | 1 | |
| 0104787 | 60x17.5/35cm ceramic+ | wit | 71046LR1 | stuk | 285,00 | 052 | 1 | |
| 0104809 | 60x17.5/35cm ceramic+ | pergamon | 71046LR3 | stuk | 331,00 | 052 | 1 | |
| 0830097 | bevestigingsset M10x110mm | | 0830097 | paar | 1,09 | 362 | 0 | |
| fontein rechts | | | | | | | | |
| 0104841 | 40x26cm | wit | 73024R01 | stuk | 118,00 | 052 | 0 |  |
| 0104868 | 40x26cm | pergamon | 73024R09 | stuk | 143,00 | 052 | 1 | |
| 0104825 | 40x26cm ceramic+ | wit | 73024RR1 | stuk | 181,00 | 052 | 1 | |
| 0104833 | 40x26cm ceramic+ | pergamon | 73024RR3 | stuk | 206,00 | 052 | 1 | |
| 0830240 | bevestigingsset voor fontein M8x90mm | | 0830240 | stuk | 0,85 | 362 | 0 | |
| fontein links | | | | | | | | |
| 0104906 | 40x26cm | wit | 73024L01 | stuk | 118,00 | 052 | 0 |  |
| 0104914 | 40x26cm | pergamon | 73024L09 | stuk | 143,00 | 052 | 0 | |
| 0104884 | 40x26cm ceramic+ | wit | 73024LR1 | stuk | 181,00 | 052 | 1 | |
| 0104892 | 40x26cm ceramic+ | pergamon | 73024LR3 | stuk | 206,00 | 052 | 1 | |
| 0830240 | bevestigingsset voor fontein M8x90mm | | 0830240 | stuk | 0,85 | 362 | 0 | |
| wandclosetpot diepspoel | | | | | | | | |
| 0104957 | | wit | 66641001 | stuk | 357,00 | 052 | 1 |  |
| 0104965 | | pergamon | 66641009 | stuk | 429,00 | 052 | 1 | |
| 0104922 | ceramic+ | wit | 666410R1 | stuk | 420,00 | 052 | 1 | |
| 0104949 | ceramic+ | pergamon | 666410R3 | stuk | 492,00 | 052 | 1 | |
| wandclosetpot diepspoel rechts | | | | | | | | |
| 0105031 | | wit | 66641R01 | stuk | 384,00 | 052 | 1 |  |
| 0105058 | | pergamon | 66641R09 | stuk | 462,00 | 052 | 1 | |
| 0105007 | ceramic+ | wit | 66641RR1 | stuk | 447,00 | 052 | 1 | |
| 0105023 | ceramic+ | pergamon | 66641RR3 | stuk | 525,00 | 052 | 1 | |
| wandclosetpot diepspoel links | | | | | | | | |
| 0105090 | | wit | 66641L01 | stuk | 384,00 | 052 | 1 |  |
| 0105104 | | pergamon | 66641L09 | stuk | 462,00 | 052 | 1 | |
| 0105066 | ceramic+ | wit | 66641LR1 | stuk | 447,00 | 052 | 1 | |
| 0105074 | ceramic+ | pergamon | 66641LR3 | stuk | 525,00 | 052 | 1 | |
| closetzitting dubbel | | | | | | | | |
| 0104973 | | wit | 88466101 | stuk | 143,00 | 052 | 0 | |
| 0104981 | | pergamon | 88466109 | stuk | 158,00 | 052 | 1 | |
| sifonkap | | | | | | | | |
| 0105112 | | zwart/metaal | 879700N2 | stuk | 207,00 | 323 | 1 |  |
| 0105113 | | RVS geborsteld | 879700L9 | stuk | 270,00 | 323 | 1 | |
| hoekkast | | | | | | | | |
| 0105120 | | zwart/metaal | 854300N2 | stuk | 236,00 | 323 | 1 |  |
| 0105114 | | RVS geborsteld | 854300L9 | stuk | 304,00 | 323 | 1 | |

Sanitair producten

Baden /
douchebakken /
stoomcabines

Kranen





Douchegarnituur

Accessoires en
spiegels

Douchewanden

Toebehoren &
afvoerenSpoel- &
installatiesystemenBadkamermeubelen
en toiletkastenGootstenen en
wastroggen

Utiliteit

| | Art.nr | Specificaties | Kleur | Lev.nr | Ehd | Prijs | Grp | CC | |
|---|--|---------------------------------|----------------|----------|---------|--------|------|-----|---|
| Sanitair producten | Villeroy & Boch Oblic | | | | | | | | |
| | wandrek | | | | | | | | |
|  | 0105139 | | zwart/metaal | 854100N2 | stuk | 342,00 | 323 | 1 | |
| | 0105115 | | RVS geborsteld | 854100L9 | stuk | 450,00 | 323 | 1 | |
| Baden / douchebakken / stoomcabines | | | | | | | | | |
| Kranen | spiegel | | | | | | | | |
| | 0105147 | | zwart/metaal | 853600N2 | stuk | 230,00 | 323 | 1 | |
|  | 0105116 | | RVS geborsteld | 853600L9 | stuk | 298,00 | 323 | 1 | |
| | | | | | | | | | |
| Douchegarnituur | | | | | | | | | |
| Accessoires en spiegels | Villeroy & Boch Omnia Architect | | | | | | | | |
| | wastafel | | | | | | | | |
|  | 1023887 | 55x46cm m. overloop | wit | 51755501 | stuk | 120,00 | 053 | 1 | |
| | 1023889 | 55x46cm m. overloop | pergamon | 51755509 | stuk | 144,00 | 053 | 1 | |
| Douchewanden | 1023888 | 55x46cm m. overloop m. ceramic+ | wit | 517555R1 | stuk | 183,00 | 053 | 1 | |
| | 1023890 | 55x46cm m. overloop m. ceramic+ | pergamon | 517555R3 | stuk | 207,00 | 053 | 1 | |
| Toebehoren & afvoeren | 1023883 | 60x48cm m. overloop | wit | 51756001 | stuk | 120,00 | 053 | 1 | |
| | 1023885 | 60x48cm m. overloop | pergamon | 51756009 | stuk | 144,00 | 053 | 1 | |
| Spoel- & installatiesystemen | 1023884 | 60x48cm m. overloop m. ceramic+ | wit | 517560R1 | stuk | 183,00 | 053 | 1 | |
| | 1023886 | 60x48cm m. overloop m. ceramic+ | pergamon | 517560R3 | stuk | 207,00 | 053 | 1 | |
| Badkamermeubelen en toiletkasten | 1023879 | 65x50cm m. overloop | wit | 51756501 | stuk | 143,00 | 053 | 1 | |
| | 1023881 | 65x50cm m. overloop | pergamon | 51756509 | stuk | 171,00 | 053 | 1 | |
| Gootstenen en wastroggen | 1023880 | 65x50cm m. overloop m. ceramic+ | wit | 517565R1 | stuk | 206,00 | 053 | 1 | |
| | 1023882 | 65x50cm m. overloop m. ceramic+ | pergamon | 517565R3 | stuk | 234,00 | 053 | 1 | |
| Utiliteit | 1023875 | 70x52cm m. overloop | wit | 51757001 | stuk | 228,00 | 053 | 1 | |
| | 1023877 | 70x52cm m. overloop | pergamon | 51757009 | stuk | 274,00 | 053 | 1 | |
|  | 1023876 | 70x52cm m. overloop m. ceramic+ | wit | 517570R1 | stuk | 291,00 | 053 | 1 | |
| | 1023878 | 70x52cm m. overloop m. ceramic+ | pergamon | 517570R3 | stuk | 337,00 | 053 | 1 | |
| 0830097 bevestigingsset M10x110mm | | | | | 0830097 | paar | 1,09 | 362 | 0 |
| sifonkap voor wastafel | | | | | | | | | |
| 1023891 | | wit | 72646001 | stuk | 122,00 | 053 | 1 | | |
| 1023892 | | pergamon | 72646009 | stuk | 146,00 | 053 | 1 | | |
| zuil voor wastafel | | | | | | | | | |
| 1023893 | | wit | 72506001 | stuk | 158,00 | 053 | 1 | | |
| 1023894 | | pergamon | 72506009 | stuk | 190,00 | 053 | 1 | | |
| fontein | | | | | | | | | |
| 1023899 | 45x34.5cm m. overloop | wit | 53734501 | stuk | 93,00 | 053 | 1 | | |
| 1023901 | 45x34.5cm m. overloop | pergamon | 53734509 | stuk | 112,00 | 053 | 1 | | |
| 1023900 | 45x34.5cm m. overloop m. ceramic+ | wit | 537345R1 | stuk | 156,00 | 053 | 1 | | |
| 1023902 | 45x34.5cm m. overloop m. ceramic+ | pergamon | 537345R3 | stuk | 175,00 | 053 | 1 | | |
| 1023895 | 50x39cm m. overloop | wit | 53735001 | stuk | 99,00 | 053 | 1 | | |
| 1023897 | 50x39cm m. overloop | pergamon | 53735009 | stuk | 120,00 | 053 | 1 | | |
| 1023896 | 50x39cm m. overloop m. ceramic+ | wit | 537350R1 | stuk | 162,00 | 053 | 1 | | |
| 1023898 | 50x39cm m. overloop m. ceramic+ | pergamon | 537350R3 | stuk | 183,00 | 053 | 1 | | |
| 0830097 bevestigingsset M10x110mm | | | | | 0830097 | paar | 1,09 | 362 | 0 |
| sifonkap voor fontein | | | | | | | | | |
| 1023903 | | wit | 72446001 | stuk | 122,00 | 053 | 1 | | |
| 1023904 | | pergamon | 72446009 | stuk | 146,00 | 053 | 1 | | |
| wandbidet | | | | | | | | | |
| 1023905 | | wit | 54730001 | stuk | 230,00 | 053 | 1 | | |
| 1023907 | | pergamon | 54730009 | stuk | 277,00 | 053 | 1 | | |
| 1023906 | m. ceramic+ | wit | 547300R1 | stuk | 293,00 | 053 | 1 | | |
| 1023908 | m. ceramic+ | pergamon | 547300R3 | stuk | 340,00 | 053 | 1 | | |
| wandclosetpot diepspoel PK | | | | | | | | | |
| 1023909 | | wit | 56741001 | stuk | 209,00 | 053 | 1 | | |
| 1023911 | | pergamon | 56741009 | stuk | 251,00 | 053 | 1 | | |
| 1023910 | m. ceramic+ | wit | 567410R1 | stuk | 272,00 | 053 | 1 | | |
| 1023912 | m. ceramic+ | pergamon | 567410R3 | stuk | 314,00 | 053 | 1 | | |

| Art.nr | Specificaties | Kleur | Lev.nr | Ehd | Prijs | Grp | CC |
|--------|---------------|-------|--------|-----|-------|-----|----|
|--------|---------------|-------|--------|-----|-------|-----|----|

Villeroy & Boch Omnia Architect

closetzitting dubbel voor wandcloset

| | | | | | | | |
|---------|--|----------|----------|------|-------|-----|---|
| 1023913 | | wit | 98M96101 | stuk | 82,00 | 053 | 1 |
| 1023914 | | pergamon | 98M96109 | stuk | 87,00 | 053 | 1 |

Villeroy & Boch Omnia Classic

wastafel

| | | | | | | | | |
|---------|---------------------------|----------|----------|----------|------|--------|-----|---|
| 0120510 | 50x45cm | | wit | 71225001 | stuk | 97,00 | 053 | 1 |
| 0131954 | 50x45cm | | pergamon | 71225009 | stuk | 118,00 | 053 | 1 |
| 0109177 | 50x45cm | ceramic+ | wit | 712250R1 | stuk | 160,00 | 053 | 1 |
| 0109185 | 50x45cm | ceramic+ | pergamon | 712250R3 | stuk | 181,00 | 053 | 1 |
| 0120502 | 55x47cm | | wit | 71225501 | stuk | 99,00 | 053 | 1 |
| 0131946 | 55x47cm | | pergamon | 71225509 | stuk | 120,00 | 053 | 1 |
| 0120501 | 55x47cm | ceramic+ | wit | 712255R1 | stuk | 162,00 | 053 | 1 |
| 0109193 | 55x47cm | ceramic+ | pergamon | 712255R3 | stuk | 183,00 | 053 | 1 |
| 0120480 | 60x49cm | | wit | 71226001 | stuk | 99,00 | 053 | 0 |
| 0131938 | 60x49cm | | pergamon | 71226009 | stuk | 120,00 | 053 | 0 |
| 0120482 | 60x49cm | ceramic+ | wit | 712260R1 | stuk | 162,00 | 053 | 1 |
| 0131936 | 60x49cm | ceramic+ | pergamon | 712260R3 | stuk | 183,00 | 053 | 1 |
| 0120448 | 65x51cm | | wit | 71226501 | stuk | 118,00 | 053 | 1 |
| 0131911 | 65x51cm | | pergamon | 71226509 | stuk | 143,00 | 053 | 1 |
| 0109207 | 65x51cm | ceramic+ | wit | 712265R1 | stuk | 181,00 | 053 | 1 |
| 0109215 | 65x51cm | ceramic+ | pergamon | 712265R3 | stuk | 206,00 | 053 | 1 |
| 0830097 | bevestigingsset M10x110mm | | | 0830097 | paar | 1,09 | 362 | 0 |



Sanitair producten

Baden /
douchebakken /
stoomcabines

Kranen

Douchegarnituur

Accessoires en
spiegels

Douchewanden

Toebehoren &
afvoeren

Spoel- &
installatiesystemen

Badkamermeubelen
en toiletkasten

Gootstenen en
wastroggen

Utiliteit

sifonkap voor wastafel

| | | | | | | | |
|---------|---------------------------|----------|----------|------|--------|-----|---|
| 0120537 | | wit | 72890001 | stuk | 101,00 | 053 | 0 |
| 0131970 | | pergamon | 72890009 | stuk | 122,00 | 053 | 0 |
| 0830453 | set potschroeven 5.5x60mm | chrom | 0830453 | stuk | 2,28 | 362 | 0 |

zuil voor wastafel

| | | | | | | | |
|---------|--|----------|----------|------|--------|-----|---|
| 0120529 | | wit | 72870001 | stuk | 143,00 | 053 | 1 |
| 0131962 | | pergamon | 72870009 | stuk | 171,00 | 053 | 1 |

planchet

| | | | | | | | | |
|---------|---------------------------|-------|----------|----------|------|-------|-----|---|
| 0120445 | 60x17cm | | wit | 78186001 | stuk | 63,00 | 053 | 0 |
| 0120444 | 60x17cm | | pergamon | 78186009 | stuk | 76,00 | 053 | 1 |
| 0830453 | set potschroeven 5.5x60mm | chrom | | 0830453 | stuk | 2,28 | 362 | 0 |



fontein m. overloop

| | | | | | | | | |
|---------|--------------------------------------|----------|----------|----------|------|--------|-----|---|
| 0130563 | 36x30cm | | wit | 73263601 | stuk | 59,00 | 053 | 0 |
| 0130561 | 36x30cm | | pergamon | 73263609 | stuk | 72,00 | 053 | 0 |
| 0109223 | 36x30cm | ceramic+ | wit | 732636R1 | stuk | 122,00 | 053 | 1 |
| 0105006 | 36x30cm | ceramic+ | pergamon | 732636R3 | stuk | 135,00 | 053 | 1 |
| 0830240 | bevestigingsset voor fontein M8x90mm | | | 0830240 | stuk | 0,85 | 362 | 0 |



fontein z. overloop

| | | | | | | | | |
|---------|--------------------------------------|----------|----------|----------|------|--------|-----|---|
| 0141429 | 36x30cm | | wit | 73263701 | stuk | 59,00 | 053 | 1 |
| 0141437 | 36x30cm | | pergamon | 73263709 | stuk | 72,00 | 053 | 1 |
| 0141445 | 36x30cm | ceramic+ | wit | 732637R1 | stuk | 122,00 | 053 | 1 |
| 0141453 | 36x30cm | ceramic+ | pergamon | 732637R3 | stuk | 135,00 | 053 | 1 |
| 0830240 | bevestigingsset voor fontein M8x90mm | | | 0830240 | stuk | 0,85 | 362 | 0 |



fontein m. overloop

| | | | | | | | | |
|---------|--------------------------------------|----------|----------|----------|------|--------|-----|---|
| 0130569 | 45x32cm | | wit | 73264501 | stuk | 72,00 | 053 | 1 |
| 0130560 | 45x32cm | | pergamon | 73264509 | stuk | 87,00 | 053 | 1 |
| 0130565 | 45x32cm | ceramic+ | wit | 732645R1 | stuk | 135,00 | 053 | 1 |
| 0130545 | 45x32cm | ceramic+ | pergamon | 732645R3 | stuk | 150,00 | 053 | 1 |
| 0830240 | bevestigingsset voor fontein M8x90mm | | | 0830240 | stuk | 0,85 | 362 | 0 |





fontein z. overloop

| | | | | | | | | |
|---------|--------------------------------------|----------|----------|----------|------|--------|-----|---|
| 0141380 | 44x32cm | | wit | 73264601 | stuk | 72,00 | 053 | 1 |
| 0141399 | 44x32cm | | pergamon | 73264609 | stuk | 87,00 | 053 | 1 |
| 0141402 | 44x32cm | ceramic+ | wit | 732646R1 | stuk | 135,00 | 053 | 1 |
| 0141410 | 44x32cm | ceramic+ | pergamon | 732646R3 | stuk | 150,00 | 053 | 1 |
| 0830240 | bevestigingsset voor fontein M8x90mm | | | 0830240 | stuk | 0,85 | 362 | 0 |



sifonkap voor fontein

| | | | | | | | |
|---------|---------------------------|----------|----------|------|--------|-----|---|
| 0130570 | | wit | 72260001 | stuk | 101,00 | 053 | 1 |
| 0130562 | | pergamon | 72260009 | stuk | 122,00 | 053 | 1 |
| 0830453 | set potschroeven 5.5x60mm | chrom | 0830453 | stuk | 2,28 | 362 | 0 |

| | Art.nr | Specificaties | Kleur | Lev.nr | Ehd | Prijs | Grp | CC |
|---|---|---------------------------|---------------------------|----------|----------|--------|--------|-------|
| Villeroy & Boch Omnia Classic | | | | | | | | |
| Sanitair producten | staand bidet | | | | | | | |
| | | 0103403 | | wit | 74190001 | stuk | 205,00 | 053 1 |
| | | 0112712 | | pergamon | 74190009 | stuk | 247,00 | 053 1 |
| | | 0109266 | ceramic+ | wit | 741900R1 | stuk | 268,00 | 053 1 |
| | | 0109274 | ceramic+ | pergamon | 741900R3 | stuk | 310,00 | 053 1 |
| Baden / douchebakken / stoomcabines |  | | | | | | | |
| Kranen | wandbidet | | | | | | | |
| | | 0103381 | | wit | 74180001 | stuk | 222,00 | 053 1 |
| | | 0112704 | | pergamon | 74180009 | stuk | 268,00 | 053 1 |
| | | 0109282 | ceramic+ | wit | 741800R1 | stuk | 285,00 | 053 1 |
| | | 0109290 | ceramic+ | pergamon | 741800R3 | stuk | 331,00 | 053 1 |
| Douchegarnituur |  | | | | | | | |
| Accessoires en spiegels | closetcombinatie diepspoel AO | | | | | | | |
| | | 0103357 | | wit | P0103357 | stuk | 352,00 | 053 1 |
| | | 0112674 | | pergamon | P0112674 | stuk | 399,00 | 053 1 |
| | | 0109339 | ceramic+ | wit | P0109339 | stuk | 415,00 | 053 1 |
| | | 0109347 | ceramic+ | pergamon | P0109347 | stuk | 462,00 | 053 1 |
| | 0830453 | set potschroeven 5.5x60mm | chroom | 0830453 | stuk | 2,28 | 362 0 | |
| Douchewanden | closetcombinatie diepspoel PK | | | | | | | |
| | | 0103373 | | wit | P0103373 | stuk | 348,00 | 053 1 |
| | | 0112690 | | pergamon | P0112690 | stuk | 395,00 | 053 0 |
| | | 0109355 | ceramic+ | wit | P0109355 | stuk | 411,00 | 053 1 |
| | | 0109363 | ceramic+ | pergamon | P0109363 | stuk | 458,00 | 053 1 |
| Toebehoren & afvoeren | | 0830453 | set potschroeven 5.5x60mm | chroom | 0830453 | stuk | 2,28 | 362 0 |
| Spoel- & installatiesystemen | closetzitting dubbel | | | | | | | |
| | | 0102816 | | wit | 88236101 | stuk | 72,00 | 052 0 |
| | | 0102817 | | pergamon | 88236109 | stuk | 76,00 | 052 0 |
| | duoblokpot diepspoel AO z. reservoir | | | | | | | |
| | | 0103322 | | wit | 76170101 | stuk | 158,00 | 053 1 |
| Badkamermeubelen en toiletkasten | | 0112615 | | pergamon | 76170109 | stuk | 190,00 | 053 1 |
| | | 0112626 | ceramic+ | wit | 761701R1 | stuk | 221,00 | 053 1 |
| | | 0109304 | ceramic+ | pergamon | 761701R3 | stuk | 253,00 | 053 1 |
| | duoblokpot diepspoel PK z. reservoir | | | | | | | |
| | | 0103330 | | wit | 76171001 | stuk | 154,00 | 053 1 |
| Gootstenen en wastroggen | | 0112631 | | pergamon | 76171009 | stuk | 186,00 | 053 1 |
| | | 0109312 | ceramic+ | wit | 761710R1 | stuk | 217,00 | 053 1 |
| | | 0109320 | ceramic+ | pergamon | 761710R3 | stuk | 249,00 | 053 1 |
| | duoblokreservoir + binnenwerk | | | | | | | |
| | | 0103349 | | wit | 77961101 | stuk | 194,00 | 053 1 |
| Utiliteit | | 0112658 | | pergamon | 77961109 | stuk | 209,00 | 053 1 |
| | closetpot vlakspoel PK | | | | | | | |
| | | 0100078 | | wit | 76191001 | stuk | 124,00 | 053 1 |
| | | 0100079 | | pergamon | 76191009 | stuk | 148,00 | 053 1 |
| | | 0100080 | ceramic+ | wit | 761910R1 | stuk | 187,00 | 053 1 |
| | 0100081 | ceramic+ | pergamon | 761910R3 | stuk | 211,00 | 053 1 | |
| | wandclosetpot diepspoel | | | | | | | |
| | | 0100196 | | wit | 76821001 | stuk | 175,00 | 053 0 |
| | | 0111066 | | pergamon | 76821009 | stuk | 211,00 | 053 0 |
| | | 0103439 | ceramic+ | pergamon | 768210R3 | stuk | 274,00 | 053 0 |
| | closetcombinatie Purair PK m. zitting | | | | | | | |
| | 1023677 | | wit | 7617N001 | stuk | 695,00 | 053 1 | |
| | 1023679 | | pergamon | 7617N009 | stuk | 747,00 | 053 1 | |
| | 1023678 | m. ceramic+ | wit | 7617N0R1 | stuk | 821,00 | 053 1 | |
| | 1023680 | m. ceramic+ | pergamon | 7617N0R3 | stuk | 872,00 | 053 1 | |
| | 1023681 | m. ceramic+ | starwhite | 7617N0R2 | stuk | 872,00 | 053 1 | |
| | 0830453 | set potschroeven 5.5x60mm | chroom | 0830453 | stuk | 2,28 | 362 0 | |

| Art.nr | Specificaties | Kleur | Lev.nr | Ehd | Prijs | Grp | CC |
|--------|---------------|-------|--------|-----|-------|-----|----|
|--------|---------------|-------|--------|-----|-------|-----|----|

Villeroy & Boch Omnia Compact

wastafel

| | | | | | | | |
|---------|---------------------------|----------|----------|------|--------|-----|---|
| 0121053 | 55x41cm | wit | 71185501 | stuk | 114,00 | 053 | 1 |
| 0132004 | 55x41cm | pergamon | 71185509 | stuk | 137,00 | 053 | 1 |
| 0109371 | 55x41cm | ceramic+ | 711855R1 | stuk | 177,00 | 053 | 1 |
| 0109398 | 55x41cm | ceramic+ | 711855R3 | stuk | 200,00 | 053 | 1 |
| 0121037 | 60x44cm | wit | 71186001 | stuk | 114,00 | 053 | 1 |
| 0131997 | 60x44cm | pergamon | 71186009 | stuk | 137,00 | 053 | 1 |
| 0109401 | 60x44cm | ceramic+ | 711860R1 | stuk | 177,00 | 053 | 1 |
| 0109428 | 60x44cm | ceramic+ | 711860R3 | stuk | 200,00 | 053 | 1 |
| 0830097 | bevestigingsset M10x110mm | | 0830097 | paar | 1,09 | 362 | 0 |



Sanitair producten

Baden /
douchebakken /
stoomcabines

Kranen

Douchegarnituur

fontein

| | | | | | | | |
|---------|--------------------------------------|----------|----------|------|--------|-----|---|
| 0121045 | 53x23cm | wit | 73285001 | stuk | 63,00 | 053 | 1 |
| 0139517 | 53x23cm | pergamon | 73285009 | stuk | 76,00 | 053 | 1 |
| 0109231 | 53x23cm | ceramic+ | 732850R1 | stuk | 126,00 | 053 | 1 |
| 0109258 | 53x23cm | ceramic+ | 732850R3 | stuk | 139,00 | 053 | 1 |
| 0830240 | bevestigingsset voor fontein M8x90mm | | 0830240 | stuk | 0,85 | 362 | 0 |

Accessoires en
spiegels

Douchewanden

hoekfontein

| | | | | | | | |
|---------|--------------------------------------|----------|----------|------|--------|-----|---|
| 0120241 | 55x45cm | wit | 73274001 | stuk | 114,00 | 053 | 1 |
| 0120768 | 55x45cm | pergamon | 73274009 | stuk | 137,00 | 053 | 1 |
| 0132179 | 55x45cm | ceramic+ | 732740R1 | stuk | 177,00 | 053 | 1 |
| 0130567 | 55x45cm | ceramic+ | 732740R3 | stuk | 200,00 | 053 | 1 |
| 0830240 | bevestigingsset voor fontein M8x90mm | | 0830240 | stuk | 0,85 | 362 | 0 |

Toebehoren &
afvoeren**hoekwastafel**

| | | | | | | | |
|---------|--------------------------------------|----------|----------|------|--------|-----|---|
| 0130571 | 70,5x52cm | wit | 71725001 | stuk | 220,00 | 053 | 1 |
| 0141496 | 70,5x52cm | pergamon | 71725009 | stuk | 266,00 | 053 | 1 |
| 0141461 | 70,5x52cm | ceramic+ | 717250R1 | stuk | 283,00 | 053 | 1 |
| 0141518 | 70,5x52cm | ceramic+ | 717250R3 | stuk | 329,00 | 053 | 1 |
| 0830240 | bevestigingsset voor fontein M8x90mm | | 0830240 | stuk | 0,85 | 362 | 0 |

wandclosetpot diepspoel

| | | | | | | | |
|---------|--|----------|----------|------|--------|-----|---|
| 0103454 | | wit | 76671001 | stuk | 182,00 | 053 | 0 |
| 0112720 | | pergamon | 76671009 | stuk | 220,00 | 053 | 0 |
| 0103455 | | ceramic+ | 766710R1 | stuk | 245,00 | 053 | 0 |
| 0112723 | | ceramic+ | 766710R3 | stuk | 283,00 | 053 | 0 |

Spoel- &
installatiesystemenBadkamermeubelen
en toiletkasten**duoblospot diepspoel PK z. reservoir**

| | | | | | | | |
|---------|---------------------------|----------|----------|------|--------|-----|---|
| 0100096 | | wit | 66691001 | stuk | 196,00 | 053 | 1 |
| 0100098 | | pergamon | 66691009 | stuk | 236,00 | 053 | 1 |
| 0100097 | | ceramic+ | 666910R1 | stuk | 259,00 | 053 | 1 |
| 0100099 | | ceramic+ | 666910R3 | stuk | 299,00 | 053 | 1 |
| 0830453 | set potschroeven 5.5x60mm | chrom | 0830453 | stuk | 2,28 | 362 | 0 |

duoblokreservoir + binnenwerk

| | | | | | | | |
|---------|--|----------|----------|------|--------|-----|---|
| 0100100 | | wit | 77291101 | stuk | 192,00 | 053 | 1 |
| 0100101 | | pergamon | 77291109 | stuk | 207,00 | 053 | 1 |

Gootstenen en
wastroggen

Utiliteit

Villeroy & Boch Omnia Vita

wastafel m. kraangat m. overloop

| | | | | | | | |
|---------|---------------------------|----------|----------|------|--------|-----|---|
| 0121029 | 70x56cm | wit | 71190101 | stuk | 274,00 | 053 | 1 |
| 0131989 | 70x56cm | pergamon | 71190109 | stuk | 329,00 | 053 | 1 |
| 0109436 | 70x56cm | ceramic+ | 711901R1 | stuk | 337,00 | 053 | 1 |
| 0109444 | 70x56cm | ceramic+ | 711901R3 | stuk | 392,00 | 053 | 1 |
| 0830097 | bevestigingsset M10x110mm | | 0830097 | paar | 1,09 | 362 | 0 |

**wandclosetpot diepspoel**

| | | | | | | | |
|---------|--|----------|----------|------|--------|-----|---|
| 0103411 | | wit | 76011001 | stuk | 386,00 | 053 | 1 |
| 0103438 | | pergamon | 76011009 | stuk | 464,00 | 053 | 1 |
| 0109452 | | ceramic+ | 760110R1 | stuk | 449,00 | 053 | 1 |
| 0109460 | | ceramic+ | 760110R3 | stuk | 527,00 | 053 | 1 |

**kinderclosetpot m. S-uitlaat**

| | | | | | | | |
|---------|---------------------------|-----|----------|------|--------|-----|---|
| 0101605 | diepspoel | wit | 76460301 | stuk | 217,00 | 053 | 1 |
| 0830410 | set potschroeven 5.5x60mm | wit | 0830410 | stuk | 0,84 | 362 | 0 |



| | Art.nr | Specificaties | Kleur | Lev.nr | Ehd | Prijs | Grp | CC | | |
|--|---|----------------------------------|--------------------------------------|------------------|----------|----------|---------|--------|-----|---|
| Sanitair producten | Villeroy & Boch Omnia Pro | | | | | | | | | |
| | wastafel m. overloop | | | | | | | | | |
| | | 0132217 | 55x45cm | wit | 61595501 | stuk | 101,00 | 053 | 1 | |
| | | 0132268 | 55x45cm | pergamon | 61595509 | stuk | 122,00 | 053 | 1 | |
| | | 0132292 | 55x45cm ceramic+ | wit | 615955R1 | stuk | 164,00 | 053 | 1 | |
| | | 0132322 | 55x45cm ceramic+ | pergamon | 615955R3 | stuk | 185,00 | 053 | 1 | |
| | Baden / douchebakken / stoomcabines | | 0132209 | 60x50cm | wit | 61596001 | stuk | 84,00 | 053 | 0 |
| | | | 0132233 | 60x50cm | pergamon | 61596009 | stuk | 101,00 | 053 | 1 |
| | | | 0132284 | 60x50cm ceramic+ | wit | 615960R1 | stuk | 147,00 | 053 | 1 |
| | | | 0132314 | 60x50cm ceramic+ | pergamon | 615960R3 | stuk | 164,00 | 053 | 1 |
| Kranen | | 0132195 | 65x52cm | wit | 61596501 | stuk | 120,00 | 053 | 1 | |
| | | 0132225 | 65x52cm | pergamon | 61596509 | stuk | 144,00 | 053 | 1 | |
| | | 0132276 | 65x52cm ceramic+ | wit | 615965R1 | stuk | 183,00 | 053 | 1 | |
| | | 0132306 | 65x52cm ceramic+ | pergamon | 615965R3 | stuk | 207,00 | 053 | 1 | |
| Douchegarnituur | | 0830097 | bevestigingsset M10x110mm | | 0830097 | paar | 1,09 | 362 | 0 | |
| | sifonkap voor wastafel | | | | | | | | | |
| | | 0132691 | | wit | 72490001 | stuk | 106,00 | 053 | 0 | |
| Accessoires en spiegels | | 0132705 | | pergamon | 72490009 | stuk | 129,00 | 053 | 1 | |
| | | 0830453 | set potschroeven 5.5x60mm chroom | | 0830453 | stuk | 2,28 | 362 | 0 | |
| | gootsteen z. overloop | | | | | | | | | |
| Douchewanden | | 0132594 | 50x40cm | wit | 63211001 | stuk | 186,00 | 053 | 1 | |
| | | 0132608 | 50x40cm ceramic+ | wit | 632110R1 | stuk | 249,00 | 053 | 1 | |
| | | 0132616 | 60x50cm | wit | 63221001 | stuk | 239,00 | 053 | 1 | |
| | | 0132632 | 60x50cm ceramic+ | wit | 632210R1 | stuk | 302,00 | 053 | 1 | |
| | | 0140163 | overloopgarnituur voor gootsteen | | 94281061 | stuk | 29,00 | 053 | 0 | |
| Toebehoren & afvoeren | wastobbe | | | | | | | | | |
| | | 0100102 | 83x34x51cm | wit | 69221001 | stuk | 1051,00 | 053 | 1 | |
| | | 0100104 | 83x34x51cm | pergamon | 69221009 | stuk | 1262,00 | 053 | 1 | |
| | | 0100103 | 83x34x51cm ceramic+ | wit | 692210R1 | stuk | 1114,00 | 053 | 1 | |
| Spoel- & installatiesystemen | | 0100105 | 83x34x51cm ceramic+ | pergamon | 692210R3 | stuk | 1325,00 | 053 | 1 | |
| | fontein | | | | | | | | | |
| | | 0132519 | 45x35cm | wit | 73594501 | stuk | 74,00 | 053 | 1 | |
| | | 0132527 | 45x35cm | pergamon | 73594509 | stuk | 89,00 | 053 | 1 | |
| | | 0132535 | 45x35cm ceramic+ | wit | 735945R1 | stuk | 137,00 | 053 | 1 | |
| Badkamermeubelen en toiletkasten | | 0132578 | 45x35cm ceramic+ | pergamon | 735945R3 | stuk | 152,00 | 053 | 1 | |
| | | 0830240 | bevestigingsset voor fontein M8x90mm | | 0830240 | stuk | 0,85 | 362 | 0 | |
| | fontein rechts | | | | | | | | | |
| | 0132236 | 40x25cm | wit | 73361B01 | stuk | 44,00 | 053 | 0 | | |
| Gootstenen en wastroggen | duoblokpot diepspoel AO z. reservoir | | | | | | | | | |
| | | 0100688 | | wit | 6C590101 | stuk | 163,00 | 053 | 0 | |
| | | 0100689 | | pergamon | 6C590109 | stuk | 198,00 | 053 | 1 | |
| | | 0100690 | m. ceramic+ | wit | 6C5901R1 | stuk | 226,00 | 053 | 1 | |
| Utiliteit | | 0100691 | m. ceramic+ | pergamon | 6C5901R3 | stuk | 261,00 | 053 | 1 | |
| | duoblokpot diepspoel PK z. reservoir | | | | | | | | | |
| | | 0100692 | | wit | 6C591001 | stuk | 152,00 | 053 | 0 | |
| | | 0100693 | | pergamon | 6C591009 | stuk | 182,00 | 053 | 1 | |
| | | 0100694 | m. ceramic+ | wit | 6C5910R1 | stuk | 215,00 | 053 | 1 | |
| | | 0100695 | m. ceramic+ | pergamon | 6C5910R3 | stuk | 245,00 | 053 | 1 | |
| | duoblokreervoir | | | | | | | | | |
| | | 0100696 | | wit | 7D192101 | stuk | 149,00 | 053 | 0 | |
| | 0100697 | | pergamon | 7D192109 | stuk | 157,00 | 053 | 1 | | |
| closetpot staand vlakspoel AO | | | | | | | | | | |
| | 0132234 | | wit | 66360B01 | stuk | 91,50 | 053 | 0 | | |
| closetpot staand vlakspoel PK | | | | | | | | | | |
| | 0132235 | | wit | 66361B01 | stuk | 91,50 | 053 | 0 | | |
| closetcombinatie Purair AO m. zitting | | | | | | | | | | |
| | 1023682 | | wit | 6C59N101 | stuk | 661,00 | 053 | 1 | | |
| | 1023684 | | pergamon | 6C59N109 | stuk | 707,00 | 053 | 1 | | |
| | 1023683 | m. ceramic+ | wit | 6C59N1R1 | stuk | 787,00 | 053 | 1 | | |
| | 1023685 | m. ceramic+ | pergamon | 6C59N1R3 | stuk | 832,00 | 053 | 1 | | |
| | 1023686 | | starwhite | 6C59N1R2 | stuk | 832,00 | 053 | 1 | | |
| | 0830453 | set potschroeven 5.5x60mm chroom | | 0830453 | stuk | 2,28 | 362 | 0 | | |

| Art.nr | Specificaties | Kleur | Lev.nr | Ehd | Prijs | Grp | CC |
|--------|---------------|-------|--------|-----|-------|-----|----|
|--------|---------------|-------|--------|-----|-------|-----|----|

Villeroy & Boch Omnia Pro

closetcombinatie Purair PK m. zitting

| | | | | | | | |
|---------|---------------------------|-----------|----------|------|--------|-----|---|
| 1023687 | m. ceramic+ | wit | 6C59N001 | stuk | 650,00 | 053 | 1 |
| 1023689 | | pergamon | 6C59N009 | stuk | 692,00 | 053 | 1 |
| 1023688 | m. ceramic+ | wit | 6C59NOR1 | stuk | 775,00 | 053 | 1 |
| 1023690 | m. ceramic+ | pergamon | 6C59NOR3 | stuk | 817,00 | 053 | 1 |
| 1023691 | m. ceramic+ | starwhite | 6C59NOR2 | stuk | 817,00 | 053 | 1 |
| 0830453 | set potschroeven 5.5x60mm | chroom | 0830453 | stuk | 2,28 | 362 | 0 |

wandurinoir boveninlaat onderafvoer

| | | | | | | | |
|---------|--|----------|----------|------|--------|-----|---|
| 0100501 | | wit | 75040001 | stuk | 270,00 | 053 | 1 |
| 0111104 | | pergamon | 75040009 | stuk | 325,00 | 053 | 1 |
| 0100595 | inlaatfitting urinoir Ebra/Esta/Magnum-Neu | | 99320000 | stuk | 19,00 | 053 | 1 |
| 0100897 | bevestigingsset universeel | | 99610000 | stuk | 21,00 | 053 | 1 |



Sanitair producten

Baden /
douchebakken /
stoomcabines

Kranen

Douchegarnituur

Accessoires en
spiegels

Douchewanden

Toebehoren &
afvoerenSpoel- &
installatiesystemenBadkamermeubelen
en toiletkastenGootstenen en
wastroggen

Utiliteit

wandurinoir boveninlaat achterafvoer

| | | | | | | | |
|---------|--|----------|----------|------|--------|-----|---|
| 0100471 | | wit | 75020001 | stuk | 253,00 | 053 | 1 |
| 0121746 | | pergamon | 75020009 | stuk | 304,00 | 053 | 1 |
| 0100595 | inlaatfitting urinoir Ebra/Esta/Magnum-Neu | | 99320000 | stuk | 19,00 | 053 | 1 |
| 0100897 | bevestigingsset universeel | | 99610000 | stuk | 21,00 | 053 | 1 |

wandurinoir achterinlaat achterafvoer

| | | | | | | | |
|---------|---|----------|----------|------|--------|-----|---|
| 0100498 | | wit | 75030001 | stuk | 295,00 | 053 | 1 |
| 0113181 | | pergamon | 75030009 | stuk | 353,00 | 053 | 1 |
| 0100897 | bevestigingsset universeel | | 99610000 | stuk | 21,00 | 053 | 1 |
| 0100951 | inlaatfitting urinoir Esta/Magnum/Stratos | | 99330000 | stuk | 27,00 | 053 | 1 |

wandurinoir boveninlaat z. sifon

| | | | | | | | |
|---------|--|----------|----------|------|--------|-----|---|
| 0102040 | | wit | 75080001 | stuk | 217,00 | 053 | 1 |
| 0121754 | | pergamon | 75080009 | stuk | 260,00 | 053 | 1 |
| 0100595 | inlaatfitting urinoir Ebra/Esta/Magnum-Neu | | 99320000 | stuk | 19,00 | 053 | 1 |
| 0101796 | bevestigingsset urinoir Esta/Magnum-Neu | | 99700000 | stuk | 21,00 | 053 | 1 |
| 0104590 | urinoirsifon horizontaal | | 93090000 | stuk | 25,50 | 053 | 0 |
| 0104604 | urinoirsifon verticaal | | 93080000 | stuk | 25,50 | 053 | 1 |

**wandurinoir achterinlaat z. sifon**

| | | | | | | | |
|---------|---|----------|----------|------|--------|-----|---|
| 0102032 | | wit | 75070001 | stuk | 203,00 | 053 | 1 |
| 0111120 | | pergamon | 75070009 | stuk | 245,00 | 053 | 1 |
| 0100951 | inlaatfitting urinoir Esta/Magnum/Stratos | | 99330000 | stuk | 27,00 | 053 | 1 |
| 0101796 | bevestigingsset urinoir Esta/Magnum-Neu | | 99700000 | stuk | 21,00 | 053 | 1 |
| 0104590 | urinoirsifon horizontaal | | 93090000 | stuk | 25,50 | 053 | 0 |
| 0104604 | urinoirsifon verticaal | | 93080000 | stuk | 25,50 | 053 | 1 |
| 0104612 | aansluitgarnituur urinoir Magnum-Neu | | 93190000 | stuk | 70,00 | 053 | 1 |

Villeroy & Boch Private Lounge

wastafel

| | | | | | | | | |
|---------|---------------------------|----------------------|-----------|----------|------|--------|-----|---|
| 0100480 | 65x50cm | z. overloop ceramic+ | starwhite | 510766R2 | stuk | 471,00 | 052 | 1 |
| 0100698 | 65x50cm | z. overloop ceramic+ | wit | 510766R1 | stuk | 472,00 | 053 | 1 |
| 0830097 | bevestigingsset M10x110mm | | | 0830097 | paar | 1,09 | 362 | 0 |

**dubbele wastafel**











| | | | | | | | | |
|---------|---------------------------|----------------------|-----------|----------|------|--------|-----|---|
| 0100699 | 80x65cm | z. overloop ceramic+ | wit | 510681R1 | stuk | 941,00 | 053 | 1 |
| 0100555 | 80x65cm | z. overloop ceramic+ | starwhite | 510681R2 | stuk | 941,00 | 052 | 1 |
| 0830097 | bevestigingsset M10x110mm | | | 0830097 | paar | 1,09 | 362 | 0 |

**fontein**

| | | | | | | | | |
|---------|---------------------------|----------------------|-----------|----------|------|--------|-----|---|
| 0100700 | 50x32.5cm | z. overloop ceramic+ | wit | 736051R1 | stuk | 411,00 | 053 | 1 |
| 0100396 | 50x32.5cm | z. overloop ceramic+ | starwhite | 736051R2 | stuk | 410,00 | 052 | 1 |
| 0830097 | bevestigingsset M10x110mm | | | 0830097 | paar | 1,09 | 362 | 0 |



| | Art.nr | Specificaties | Kleur | Lev.nr | Ehd | Prijs | Grp | CC | |
|---|---|---|----------------|-----------------|----------|---------|---------|-----|---|
| Sanitair producten | Villeroy & Boch Private Lounge | | | | | | | | |
| | onderconstructie voor fontein | | | | | | | | |
| | | 0100308 | 44x30x29.5cm | blauw | 9737DE00 | stuk | 380,00 | 323 | 1 |
| | | 0100556 | 44x30x29.5cm | groen | 9737DF00 | stuk | 380,00 | 323 | 1 |
| | | 0100398 | 44x30x29.5cm | wit | 9737DD00 | stuk | 380,00 | 323 | 1 |
| | 0100652 | 44x30x29.5cm | rood | 9737DG00 | stuk | 380,00 | 323 | 1 | |
| Baden / douchebakken / stoomcabines |  | | | | | | | | |
| Kranen | onderkast voor wastafel 5107 | | | | | | | | |
| | | 0100225 | 59x47x47cm | zebrano | 973800CP | stuk | 1117,00 | 323 | 1 |
| | 0100226 | 59x47x47cm | starwhite | 973800CR | stuk | 1117,00 | 323 | 1 | |
| Douchegarnituur |  | | | | | | | | |
| Accessoires en spiegels | onderkast voor wastafel 5106 | | | | | | | | |
| | | 0100622 | 74x47x62cm | zebrano | 973900CP | stuk | 1357,00 | 323 | 1 |
| | 0100623 | 74x47x62cm | starwhite | 973900CR | stuk | 1357,00 | 323 | 1 | |
| Douchewanden |  | | | | | | | | |
| Toebehoren & afvoeren | spiegel | | | | | | | | |
| | | 0100660 | 35x49x4cm | | 97411000 | stuk | 302,00 | 323 | 1 |
| | | 0100333 | 49x67x9.5cm | | 97412000 | stuk | 597,00 | 323 | 1 |
| | 0100451 | 130x67cm | | 97413000 | stuk | 1169,00 | 052 | 1 | |
| Spool- & installatiesystemen |  | | | | | | | | |
| Badkamermeubelen en toiletkasten | make-up spiegel | | | | | | | | |
| | | 0100589 | 15cm | | 97420000 | stuk | 116,00 | 323 | 1 |
| Gootstenen en wastroggen |  | | | | | | | | |
| Utiliteit | rolcontainer | | | | | | | | |
| | | 0100456 | 44x43x28cm | enamel wit | 9743DD00 | stuk | 479,00 | 323 | 1 |
| | | 0100299 | 44x43x28cm | enamel blauw | 9743DE00 | stuk | 479,00 | 323 | 1 |
| | | 0100220 | 44x43x28cm | enamel groen | 9743DF00 | stuk | 479,00 | 323 | 1 |
| | | 0100455 | 44x43x28cm | enamel rood | 9743DG00 | stuk | 479,00 | 323 | 1 |
| | | 0100525 | 44x76x28cm | wit/zebrano | 9793DDCP | stuk | 1258,00 | 323 | 1 |
| | | 0100526 | 44x76x28cm | wit/starwhite | 9793DDCR | stuk | 1258,00 | 053 | 1 |
| | | 0100237 | 44x76x28cm | blauw/zebrano | 9793DECP | stuk | 1258,00 | 323 | 1 |
| | | 0100238 | 44x76x28cm | blauw/starwhite | 9793DECR | stuk | 1258,00 | 323 | 1 |
| | | 0100475 | 44x76x28cm | groen/zebrano | 9793DFCP | stuk | 1258,00 | 323 | 1 |
| | | 0100476 | 44x76x28cm | groen/starwhite | 9793DFCR | stuk | 1258,00 | 323 | 1 |
| | | 0100604 | 44x76x28cm | rood/zebrano | 9793DGCP | stuk | 1258,00 | 323 | 1 |
| | | 0100605 | 44x76x28cm | rood/starwhite | 9793DGCR | stuk | 1258,00 | 323 | 1 |
| | |  | | | | | | | |
| | wandkast open | wandkast open | | | | | | | |
| | | 0100432 | 44x70x28cm | wit/zebrano | 9792DDCP | stuk | 1068,00 | 323 | 1 |
| | | 0100433 | 44x70x28cm | wit/starwhite | 9792DDCR | stuk | 1068,00 | 323 | 1 |
| | | 0100649 | 44x70x28cm | blauw/zebrano | 9792DECP | stuk | 1068,00 | 323 | 1 |
| | | 0100650 | 44x70x28cm | blauw/starwhite | 9792DECR | stuk | 1068,00 | 323 | 1 |
| | | 0100505 | 44x70x28cm | groen/zebrano | 9792DFCP | stuk | 1068,00 | 323 | 1 |
| | | 0100506 | 44x70x28cm | groen/starwhite | 9792DFCR | stuk | 1068,00 | 323 | 1 |
| | | 0100430 | 44x70x28cm | rood/zebrano | 9792DGCP | stuk | 1068,00 | 323 | 1 |
| | 0100431 | 44x70x28cm | rood/starwhite | 9792DGCR | stuk | 1068,00 | 323 | 1 | |
| |  | | | | | | | | |

| Art.nr | Specificaties | Kleur | Lev.nr | Ehd | Prijs | Grp | CC | | |
|--|--------------------------------------|----------|----------|------|--------|-----|----|---|---|
| | | | | | | | | Villeroy & Boch Pure Basic | |
| wastafel | | | | | | | | | |
| 0105724 | 65x50cm ceramic+ | wit | 710665R1 | stuk | 460,00 | 052 | 1 |  | Sanitair producten |
| 0140562 | 65x50cm voor 3-gats kraan ceramic+ | wit | 7106A1R1 | stuk | 460,00 | 052 | 1 | | |
| 0105899 | 50x50cm ceramic+ | wit | 711250R1 | stuk | 396,00 | 052 | 0 | | |
| 0140589 | 50x50cm voor 3-gats kraan ceramic+ | wit | 7112A1R1 | stuk | 396,00 | 052 | 1 | | |
| 0830097 | bevestigingsset M10x110mm | | 0830097 | paar | 1,09 | 362 | 0 |  | Baden / douchebakken / stoomcabines |
| handdoekhouder voor wastafel 50/65cm p/stuk | | | | | | | | | |
| 0105929 | | chrom | 874900D7 | stuk | 141,00 | 323 | 0 | | Kranen |
| wastafel voor montage element | | | | | | | | | |
| 0105945 | 65x50cm ceramic+ | wit | 71066GR1 | stuk | 511,00 | 052 | 1 |  | Douchegarnituur |
| 0140600 | 65x50cm voor 3-gats kraan ceramic+ | wit | 7106A2R1 | stuk | 511,00 | 052 | 1 | | |
| 0106046 | 50x50cm ceramic + | wit | 71125GR1 | stuk | 447,00 | 052 | 1 | | |
| 0140627 | 50x50cm voor 3-gats kraan ceramic+ | wit | 7112A2R1 | stuk | 447,00 | 052 | 1 | | |
| 0830097 | bevestigingsset M10x110mm | | 0830097 | paar | 1,09 | 362 | 0 |  | Accessoires en spiegels |
| fontein z. overloop | | | | | | | | | |
| 0100135 | 52.5x25cm ceramic+ | wit | 731353R1 | stuk | 237,00 | 052 | 1 |  | Douchewanden |
| 0100136 | 52.5x25cm ceramic+ | pergamon | 731353R3 | stuk | 237,00 | 052 | 1 | | |
| 0100137 | 35x35cm ceramic+ | wit | 731435R1 | stuk | 358,00 | 052 | 1 | | |
| 0100138 | 35x35cm ceramic+ | pergamon | 731435R3 | stuk | 358,00 | 052 | 1 | | |
| 0830240 | bevestigingsset voor fontein M8x90mm | | 0830240 | stuk | 0,85 | 362 | 0 |  | Toebehoren & afvoeren |
| handdoekhouder voor fontein 35cm p/stuk | | | | | | | | | |
| 0100139 | | chrom | 974900D7 | stuk | 135,00 | 323 | 1 |  | Spoel- & installatiesystemen |
| meubelfontein voor 1-gats kraan z. overloop | | | | | | | | | |
| 0100140 | 35x35cm ceramic+ | wit | 73143GR1 | stuk | 409,00 | 052 | 1 |  | Badkamermeubelen en toiletkasten |
| 0100141 | 35x35cm ceramic+ | pergamon | 73143GR3 | stuk | 409,00 | 052 | 1 | | |
| 0830240 | bevestigingsset voor fontein M8x90mm | | 0830240 | stuk | 0,85 | 362 | 0 | | |
| opbergelement | | | | | | | | | |
| 0106062 | 15cm | eiken | 852101C9 | stuk | 274,00 | 323 | 1 |  | Gootstenen en wastroggen |
| 0106097 | 30cm | eiken | 852102C9 | stuk | 323,00 | 323 | 1 | | |
| 0106143 | 41.5cm | eiken | 852104C9 | stuk | 363,00 | 323 | 1 | | |
| 0106135 | 55cm | eiken | 852103C9 | stuk | 380,00 | 323 | 1 | | |
| verbindingselement | | | | | | | | | |
| 0106208 | 35cm | eiken | 852105C9 | stuk | 188,00 | 323 | 1 | | Utiliteit |
| vloerelement | | | | | | | | | |
| 0106216 | 135cm | eiken | 852200C9 | stuk | 718,00 | 323 | 1 |  | |
| 0106399 | 125cm | eiken | 852210C9 | stuk | 656,00 | 323 | 1 | | |
| wandregaal | | | | | | | | | |
| 0106488 | 50x20cm | eiken | 852300C9 | stuk | 171,00 | 323 | 1 |  | |

| | Art.nr | Specificaties | Kleur | Lev.nr | Ehd | Prijs | Grp | CC | |
|---|---|--|-------------------------------|------------|----------|---------|---------|-----|---|
| Sanitair producten | Villeroy & Boch Pure Basic | | | | | | | | |
| | mini-meubelstuk 2xladen | | | | | | | | |
| | 0106496 | | eiken | 852400C9 | stuk | 859,00 | 323 | 1 | |
| Baden / douchebakken / stoomcabines |  | | | | | | | | |
| Kranen |  | hoge kast links 0100144 35x165cm | eiken | 974000C9 | stuk | 1077,00 | 323 | 1 | |
| Douchegarnituur | | hoge kast rechts 0100145 35x165cm | eiken | 974001C9 | stuk | 1077,00 | 323 | 1 | |
| Accessoires en spiegels |  | onderbouwkast links 0100142 65x41.5cm | eiken | 974700C9 | stuk | 948,00 | 323 | 1 | |
| Douchewanden | | spiegel m. verlichting 0100143 40x78cm | eiken | 974800C9 | stuk | 475,00 | 323 | 1 | |
| Toebehoren & afvoeren |  | | | | | | | | |
| Spoel- & installatiesystemen | | spiegel 0106607 70x50cm | eiken | 850800C9 | stuk | 447,00 | 323 | 1 | |
| Badkamermeubelen en toiletkasten |  | | | | | | | | |
| Gootstenen en wastroggen | | Villeroy & Boch Pure Stone | | | | | | | |
| Utiliteit |  | wastafel | | | | | | | |
| | | 0100536 60.5x54cm | z. overloop ceramic+ | wit | 517061R1 | stuk | 578,00 | 052 | 1 |
| | | 0100537 60.5x54cm | z. overloop ceramic+ | starwhite | 517061R2 | stuk | 578,00 | 052 | 1 |
| | | 0100538 60.5x54cm | z. overloop ceramic+ | edelweiss | 517061S3 | stuk | 756,00 | 052 | 1 |
| |  | opzetwastafel | | | | | | | |
| | | 0100360 53.5x54cm | z. overloop ceramic+ | wit | 517251R1 | stuk | 762,00 | 052 | 1 |
| | | 0100361 53.5x54cm | z. overloop ceramic+ | starwhite | 517251R2 | stuk | 762,00 | 052 | 1 |
| | | 0100362 53.5x54cm | z. overloop ceramic+ | edelweiss | 517251S3 | stuk | 1003,00 | 052 | 1 |
| | | 0100210 53.5x54cm | z. overl. z. kraang. ceramic+ | wit | 517253R1 | stuk | 796,00 | 052 | 1 |
| | | 0100211 53.5x54cm | z. overl. z. kraang. ceramic+ | starwhite | 517253R2 | stuk | 796,00 | 052 | 1 |
| | | 0100212 53.5x54cm | z. overl. z. kraang. ceramic+ | edelweiss | 517253S3 | stuk | 1037,00 | 052 | 1 |
| | | 0100213 53.5x54cm | z. overl. z. kraang. ceramic+ | steengrijs | 517253U9 | stuk | 1037,00 | 052 | 1 |
| | | 0100282 60x62.5cm | z. overloop ceramic+ | wit | 517261R1 | stuk | 802,00 | 052 | 1 |
| | | 0100283 60x62.5cm | z. overloop ceramic+ | starwhite | 517261R2 | stuk | 802,00 | 052 | 1 |
| | | 0100284 60x62.5cm | z. overloop ceramic+ | edelweiss | 517261S3 | stuk | 1058,00 | 052 | 1 |
| | | 0100285 60x62.5cm | z. overloop ceramic+ | steengrijs | 517261U9 | stuk | 1058,00 | 052 | 1 |
| | | 0100481 60x62.5cm | z. overl. z. kraang. ceramic+ | wit | 517263R1 | stuk | 836,00 | 052 | 1 |
| | | 0100482 60x62.5cm | z. overl. z. kraang. ceramic+ | starwhite | 517263R2 | stuk | 836,00 | 052 | 1 |
| | | 0100483 60x62.5cm | z. overl. z. kraang. ceramic+ | edelweiss | 517263S3 | stuk | 1093,00 | 052 | 1 |
| | | 0100484 60x62.5cm | z. overl. z. kraang. ceramic+ | steengrijs | 517263U9 | stuk | 1093,00 | 052 | 1 |

| Art.nr | Specificaties | Kleur | Lev.nr | Ehd | Prijs | Grp | CC |
|--------|---------------|-------|--------|-----|-------|-----|----|
|--------|---------------|-------|--------|-----|-------|-----|----|

Villeroy & Boch Pure Stone

fontein

| | | | | | | | |
|---------|---------|----------------------|-----------|----------|------|--------|-------|
| 0100452 | 45x38cm | z. overloop ceramic+ | wit | 537041R1 | stuk | 390,00 | 052 1 |
| 0100453 | 45x38cm | z. overloop ceramic+ | starwhite | 537041R2 | stuk | 390,00 | 052 1 |
| 0100454 | 45x38cm | z. overloop ceramic+ | edelweiss | 537041S3 | stuk | 504,00 | 052 1 |



Sanitair producten

Baden /
douchebakken /
stoomcabines**wandbidet**

| | | | | | | | |
|---------|-----------|----------------------|------------|----------|------|--------|-------|
| 0100464 | 52.5x59cm | z. overloop ceramic+ | wit | 547001R1 | stuk | 677,00 | 052 1 |
| 0100465 | 52.5x59cm | z. overloop ceramic+ | starwhite | 547001R2 | stuk | 676,00 | 052 1 |
| 0100466 | 52.5x59cm | z. overloop ceramic+ | edelweiss | 547001S3 | stuk | 889,00 | 052 1 |
| 0100467 | 52.5x59cm | z. overloop ceramic+ | steengrijs | 547001U9 | stuk | 889,00 | 052 1 |

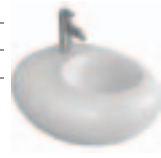

Kranen

Douchegarnituur

wandclosetpot diepspoel

| | | | | | | | |
|---------|---------|----------|-----------|----------|------|--------|-------|
| 0100568 | 53x59cm | ceramic+ | wit | 567010R1 | stuk | 648,00 | 052 1 |
| 0100569 | 53x59cm | ceramic+ | starwhite | 567010R2 | stuk | 648,00 | 052 1 |
| 0100570 | 53x59cm | ceramic+ | edelweiss | 567010S3 | stuk | 851,00 | 052 1 |

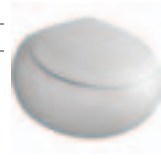
Accessoires en
spiegels**closetzitting dubbel m. softclosing**

| | | | | | | | |
|---------|--|----------|-----------|----------|------|--------|-------|
| 0100343 | | | wit | 98M1S101 | stuk | 295,00 | 052 1 |
| 0100344 | | ceramic+ | starwhite | 98M1S1R2 | stuk | 325,00 | 052 1 |
| 0100345 | | ceramic+ | edelweiss | 98M1S1S3 | stuk | 384,00 | 052 1 |

Douchewanden

zeepschaal

| | | | | | | | |
|---------|-----------------|----------|------------|----------|------|-------|-------|
| 0100207 | 20.5x5.2x19.5cm | ceramic+ | starwhite | 597000R2 | stuk | 32,00 | 052 1 |
| 0100208 | 20.5x5.2x19.5cm | ceramic+ | edelweiss | 597000S3 | stuk | 44,00 | 052 1 |
| 0100209 | 20.5x5.2x19.5cm | ceramic+ | steengrijs | 597000U9 | stuk | 44,00 | 052 1 |

Toebehoren &
afvoerenSpoel- &
installatiesystemen**decosteen**

| | | | | | | | |
|---------|---------------|----------|------------|----------|------|-------|-------|
| 0100662 | 14.2x6x13.5cm | ceramic+ | starwhite | 597100R2 | stuk | 27,00 | 052 1 |
| 0100663 | 14.2x6x13.5cm | ceramic+ | edelweiss | 597100S3 | stuk | 36,00 | 052 1 |
| 0100664 | 14.2x6x13.5cm | ceramic+ | steengrijs | 597100U9 | stuk | 36,00 | 052 1 |

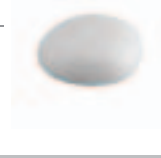
Badkamermeubelen
en toiletkastenGootstenen en
wastroggen**deco doosje**

| | | | | | | | |
|---------|---------------|----------|-----------|----------|------|-------|-------|
| 0100258 | 15.5x6x13.5cm | ceramic+ | starwhite | 597200R2 | stuk | 34,00 | 052 1 |
| 0100259 | 15.5x6x13.5cm | ceramic+ | edelweiss | 597200S3 | stuk | 48,00 | 052 1 |



Utiliteit









wastafelblad voor wastafel 5172









| | | | | | | | |
|---------|------------|--------|-------|----------|------|--------|-------|
| 0100539 | 100x8x45cm | links | eiken | 95681L00 | stuk | 572,00 | 052 1 |
| 0100535 | 100x8x45cm | rechts | eiken | 95681R00 | stuk | 572,00 | 052 1 |

**onderkast voor wastafel 5172**

| | | | | | | | |
|---------|-------------|--------|-------------|----------|------|---------|-------|
| 0100377 | 100x40x45cm | links | noten/eiken | 95710L00 | stuk | 1322,00 | 052 1 |
| 0100524 | 100x40x45cm | rechts | noten/eiken | 95710R00 | stuk | 1322,00 | 052 1 |



| | Art.nr | Specificaties | Kleur | Lev.nr | Ehd | Prijs | Grp | CC |
|---|---|---------------|-------------|----------|------|---------|-----|----|
| Sanitair producten | Villeroy & Boch Pure Stone | | | | | | | |
| | onderkast voor 2 wastafels 5172 | | | | | | | |
| Baden / douchebakken / stoomcabines | 0100478 | 159x40x45cm | noten/eiken | 95712000 | stuk | 2179,00 | 052 | 1 |
| |  | | | | | | | |
| Kranen | onderkast voor wastafel 5172 | | | | | | | |
| | 0100326 | 80x70x65cm | noten/eiken | 95720000 | stuk | 1769,00 | 052 | 1 |
| Douchegarnituur | 0100335 | 120x70x65cm | noten/eiken | 95721000 | stuk | 2252,00 | 052 | 1 |
| |  | | | | | | | |
| Accessoires en spiegels | spiegelkast | | | | | | | |
| | 0100332 | 60x80x13.5cm | noten | 95730000 | stuk | 1389,00 | 052 | 1 |
| Douchewanden |  | | | | | | | |
| Toebehoren & afvoeren | spiegel | | | | | | | |
| | 0100350 | 40x60x14cm | noten | 95771000 | stuk | 460,00 | 052 | 1 |
| Spoel- & installatiesystemen | 0100364 | 60x80x14cm | noten | 95772000 | stuk | 1058,00 | 052 | 1 |
| | 0100444 | 120x60x14cm | noten | 95774000 | stuk | 1307,00 | 052 | 1 |
| Badkamermeubelen en toiletkasten |  | | | | | | | |
| |  | | | | | | | |
| Gootstenen en wastroggen |  | | | | | | | |
| Utiliteit | schapmodule | | | | | | | |
| | 0100334 | 80x128x35cm | noten/eiken | 95780000 | stuk | 1626,00 | 052 | 1 |
| |  | | | | | | | |
| | zijkastmodule | | | | | | | |
| | 0100435 | 80x54x34.5cm | noten/eiken | 95790000 | stuk | 1034,00 | 052 | 1 |
| |  | | | | | | | |

| Art.nr | Specificaties | Kleur | Lev.nr | Ehd | Prijs | Grp | CC | | | |
|---------------------------------------|---------------------------|----------------|----------|----------|--------|--------|-----|---|---|----------------------------|
| Villeroy & Boch Pure Stone | | | | | | | | | | |
| kastmodule | | | | | | | | | | |
| 0100342 | 79x32x31.5cm | noten/eiken | 95840000 | stuk | 771,00 | 052 | 1 |  | Sanitair producten | |
| zijkast | | | | | | | | | | |
| 0100606 | 80x40cm | noten/eiken | 95810000 | stuk | 773,00 | 052 | 1 |  | Baden / douchebakken / stoomcabines | |
| open kast | | | | | | | | | | |
| 0100310 | 80x48x35cm | noten/eiken | 95850000 | stuk | 939,00 | 052 | 1 |  | Kranen | |
| planchet uittrekbaar | | | | | | | | | | |
| 0100395 | 40x8x35cm | eiken | 95830000 | stuk | 576,00 | 052 | 1 |  | Douchegarnituur | |
| planchet | | | | | | | | | | |
| 0100205 | 80x8x35cm | z. verlichting | eiken | 95800000 | stuk | 452,00 | 052 | 1 |  | Accessoires en spiegels |
| 0100566 | 80x8x35cm | m. verlichting | eiken | 9580B000 | stuk | 572,00 | 052 | 1 | | Douchewanden |
| planchet voor 9579 / 9584 | | | | | | | | | | |
| 0100281 | 80x8x35cm | eiken | 95802000 | stuk | 405,00 | 052 | 1 |  | Toebehoren & afvoeren | |
| lamp | | | | | | | | | | |
| 0100203 | 13.5x5cm | | 95820000 | stuk | 118,00 | 052 | 1 |  | Spoel- & installatiesystemen | |
| Villeroy & Boch Saval | | | | | | | | | | |
| wastafel | | | | | | | | | | |
| 0102200 | 55x45cm | wit | 7G205501 | stuk | 39,00 | 054 | 1 | | Badkamermeubelen en toiletkasten | |
| 0102300 | 55x45cm | pergamon | 7G205509 | stuk | 48,75 | 054 | 1 | | | |
| 0102701 | 60x49cm | wit | 7G206001 | stuk | 41,50 | 053 | 0 | | | |
| 0120003 | 60x49cm | pergamon | 7G206009 | stuk | 52,00 | 053 | 0 | | | |
| 0830097 | bevestigingsset M10x110mm | | 0830097 | paar | 1,09 | 362 | 0 | | | |
| sifonkap voor wastafel | | | | | | | | | | |
| 0102719 | | wit | 7G010001 | stuk | 46,00 | 054 | 0 | | Gootstenen en wastroggen | |
| 0120001 | | pergamon | 7G010009 | stuk | 57,50 | 054 | 1 | | | |
| 0830453 | set potschroeven 5.5x60mm | chrom | 0830453 | stuk | 2,28 | 362 | 0 | | | |
| zuil voor wastafel | | | | | | | | | | |
| 0101900 | | wit | 7G020001 | stuk | 53,00 | 054 | 1 |  | Utiliteit | |

| | Art.nr | Specificaties | Kleur | Lev.nr | Ehd | Prijs | Grp | CC |
|---|---|--|----------|----------|--------|--------|-----|----|
| | Villeroy & Boch Saval | | | | | | | |
| | planchet | | | | | | | |
| Sanitair producten | 0102100 | 50x15cm | wit | 7G825001 | stuk | 26,00 | 054 | 1 |
| | 0120010 | 50x15cm | pergamon | 7G825009 | stuk | 32,50 | 054 | 1 |
| | 0102720 | 60x16cm | wit | 7G826001 | stuk | 28,50 | 053 | 0 |
| | 0120002 | 60x16cm | pergamon | 7G826009 | stuk | 35,75 | 054 | 1 |
| Baden / douchebakken / stoomcabines | 0830453 | set potschroeven 5.5x60mm | chrom | 0830453 | stuk | 2,28 | 362 | 0 |
| | fontein | | | | | | | |
| | 0191000 | 40x25cm | wit | 7G368701 | stuk | 41,50 | 053 | 0 |
| Kranen | 0191112 | 40x25cm | pergamon | 7G368709 | stuk | 52,00 | 054 | 1 |
| | 0830240 | bevestigingsset voor fontein M8x90mm | | 0830240 | stuk | 0,85 | 362 | 0 |
| | closetpot vlakspool AO | | | | | | | |
| Douchegarnituur | 0100006 | | wit | 7G630401 | stuk | 78,00 | 053 | 0 |
| | 0100108 | | pergamon | 7G630409 | stuk | 97,50 | 054 | 1 |
| | 0830453 | set potschroeven 5.5x60mm | chrom | 0830453 | stuk | 2,28 | 362 | 0 |
| | closetpot vlakspool PK | | | | | | | |
| Accessoires en spiegels | 0100075 | | wit | 7G611001 | stuk | 73,50 | 054 | 1 |
| | 0100077 | | pergamon | 7G611009 | stuk | 92,00 | 054 | 1 |
| | 0830453 | set potschroeven 5.5x60mm | chrom | 0830453 | stuk | 2,28 | 362 | 0 |
| | closetpot diepspoel AO | | | | | | | |
| Douchewanden | 0262037 | | wit | 7G640101 | stuk | 68,00 | 054 | 1 |
| | 0262035 | | pergamon | 7G640109 | stuk | 85,00 | 054 | 1 |
| | 0830453 | set potschroeven 5.5x60mm | chrom | 0830453 | stuk | 2,28 | 362 | 0 |
| | closetpot diepspoel PK | | | | | | | |
| Toebehoren & afvoeren | 0262039 | | wit | 7G641001 | stuk | 68,00 | 054 | 1 |
| | 0262041 | | pergamon | 7G641009 | stuk | 85,00 | 054 | 1 |
| | 0830453 | set potschroeven 5.5x60mm | chrom | 0830453 | stuk | 2,28 | 362 | 0 |
| | wandclosetpot diepspoel | | | | | | | |
| Spoel- & installatiesystemen | 0102727 | | wit | 7G651001 | stuk | 75,50 | 053 | 0 |
| | 0102740 | | pergamon | 7G651009 | stuk | 94,00 | 053 | 0 |
| | wandclosetpot vlakspool | | | | | | | |
| | 0102500 | | wit | 7G681001 | stuk | 102,00 | 053 | 0 |
| Badkamermeubelen en toiletkasten | 0102600 | | pergamon | 7G681009 | stuk | 127,00 | 054 | 1 |
| | closetcombinatie AO | | | | | | | |
| | 0104580 | | wit | SAVAL | stuk | 189,50 | 053 | 1 |
| | 0104585 | | pergamon | SAVAL | stuk | 237,00 | 053 | 1 |
| Gootstenen en wastroggen | 0830453 | set potschroeven 5.5x60mm | chrom | 0830453 | stuk | 2,28 | 362 | 0 |
| | closetcombinatie PK | | | | | | | |
| | 0104595 | | wit | SAVAL | stuk | 189,50 | 053 | 1 |
| | 0104600 | | pergamon | SAVAL | stuk | 237,00 | 053 | 1 |
| Utiliteit | 0830453 | set potschroeven 5.5x60mm | chrom | 0830453 | stuk | 2,28 | 362 | 0 |
| | duoblokpot diepspoel AO z. reservoir | | | | | | | |
| | 0191111 | | wit | 7G660401 | stuk | 85,50 | 053 | 0 |
| | 0191120 | | pergamon | 7G660409 | stuk | 107,00 | 054 | 1 |
| duoblokpot diepspoel PK z. reservoir | | | | | | | | |
| Utiliteit | 0112200 | | wit | 7G661401 | stuk | 85,50 | 053 | 0 |
| | 0112222 | | pergamon | 7G661409 | stuk | 107,00 | 054 | 1 |
| | duoblokreservoir + binnenwerk | | | | | | | |
| | 0119876 | | wit | 7G762101 | stuk | 104,00 | 053 | 0 |
| 0119880 | | pergamon | 7G762109 | stuk | 130,00 | 054 | 1 | |
| wandurinoir achterinlaat | | | | | | | | |
| Utiliteit | 0101700 | | wit | 7G510001 | stuk | 127,00 | 054 | 1 |
| | 0190900 | | pergamon | 7G510009 | stuk | 159,00 | 054 | 1 |
| | 0100595 | inlaatfitting urinoir Ebra/Esta/Magnum-Neu | | 99320000 | stuk | 19,00 | 053 | 1 |
| | 0104590 | urinoirsifon horizontaal | | 93090000 | stuk | 25,50 | 053 | 0 |
| | 0104604 | urinoirsifon verticaal | | 93080000 | stuk | 25,50 | 053 | 1 |
| | 0104612 | aansluitgarnituur urinoir Magnum-Neu | | 93190000 | stuk | 70,00 | 053 | 1 |
| | wandurinoir boveninlaat | | | | | | | |
| 0102744 | | wit | 7G500001 | stuk | 122,00 | 054 | 1 | |
| 0190018 | | pergamon | 7G500009 | stuk | 153,00 | 054 | 1 | |
| 0104590 | urinoirsifon horizontaal | | 93090000 | stuk | 25,50 | 053 | 0 | |
| 0104604 | urinoirsifon verticaal | | 93080000 | stuk | 25,50 | 053 | 1 | |



Uw gevoel voor de goede vorm: SentiQue

Moderne stijl, tijdloos design - met SENTIQUE maakt u een badkamer zoals u altijd gewild heeft: smaakvol, tijdloos en met veel persoonlijkheid. Een badkamer waar u zich zult thuisvoelen.

| | Art.nr | Specificaties | Kleur | Lev.nr | Ehd | Prijs | Grp | CC |
|---|-------------------------------------|---|-----------|-----------|----------|----------|--------|------------|
| | Villeroy & Boch Sentique | | | | | | | |
| | wastafel | | | | | | | |
| Sanitair producten | 1023777 | 60x49cm m. overloop m. 3 krngat. | wit | 51436001 | stuk | 186,00 | 052 | 1 |
| | 1023779 | 60x49cm m. overloop m. 3 krngat. | pergamon | 51436009 | stuk | 224,00 | 052 | 1 |
| | 1023778 | 60x49cm m. overloop m. 3 krngat. m. ceramic+ | wit | | 514360R1 | stuk | 249,00 | 052 |
| Baden / douchebakken / stoomcabines | 1023780 | 60x49cm m. overloop m. 3 krngat. m. ceramic+ | | pergamon | | 514360R3 | stuk | 287,00 052 |
| | 1023781 | 60x49cm m. overloop m. 3 krngat. m. ceramic+ | | starwhite | | 514360R2 | stuk | 287,00 052 |
| Kranen | 1023782 | 60x49cm z. overloop m. 3 krngat. | wit | 51436101 | stuk | 228,00 | 052 | 1 |
| | 1023784 | 60x49cm z. overloop m. 3 krngat. | pergamon | 51436109 | stuk | 266,00 | 052 | 1 |
| | 1023783 | 60x49cm z. overloop m. 3 krngat. m. ceramic+wit | | 514361R1 | stuk | 291,00 | 052 | 1 |
| | 1023785 | 60x49cm z. overloop m. 3 krngat. m. ceramic+pergamon | | 514361R3 | stuk | 329,00 | 052 | 1 |
| | 1023786 | 60x49cm z. overloop m. 3 krngat. m. ceramic+starwhite | | 514361R2 | stuk | 329,00 | 052 | 1 |
| Douchegarnituur | 1023767 | 65x50cm m. overloop m. 3 krngat. | wit | 51436501 | stuk | 219,00 | 052 | 1 |
| | 1023769 | 65x50cm m. overloop m. 3 krngat. | pergamon | 51436509 | stuk | 262,00 | 052 | 1 |
| | 1023768 | 65x50cm m. overloop m. 3 krngat. m. ceramic+ | wit | | 514365R1 | stuk | 282,00 | 052 |
| Accessoires en spiegels | 1023770 | 65x50cm m. overloop m. 3 krngat. m. ceramic+ | | pergamon | | 514365R3 | stuk | 325,00 052 |
| | 1023771 | 65x50cm m. overloop m. 3 krngat. m. ceramic+ | | starwhite | | 514365R2 | stuk | 325,00 052 |
| Douchewanden | 1023772 | 65x50cm z. overloop m. 3 krngat. | wit | 51436601 | stuk | 260,00 | 052 | 1 |
| | 1023774 | 65x50cm z. overloop m. 3 krngat. | pergamon | 51436609 | stuk | 304,00 | 052 | 1 |
| | 1023773 | 65x50cm z. overloop m. 3 krngat. m. ceramic+wit | | 514366R1 | stuk | 323,00 | 052 | 1 |
| | 1023775 | 65x50cm z. overloop m. 3 krngat. m. ceramic+pergamon | | 514366R3 | stuk | 367,00 | 052 | 1 |
| | 1023776 | 65x50cm z. overloop m. 3 krngat. m. ceramic+starwhite | | 514366R2 | stuk | 367,00 | 052 | 1 |
| Toebehoren & afvoeren | 0830097 | bevestigingsset M10x110mm | | 0830097 | paar | 1,09 | 362 | 0 |
| | sifonkap voor wastafel | | | | | | | |
| | 1023730 | | wit | 52440001 | stuk | 143,00 | 052 | 1 |
| | 1023731 | | pergamon | 52440009 | stuk | 171,00 | 052 | 1 |
| | 1023732 | m. ceramic+ | starwhite | 524400R2 | stuk | 234,00 | 052 | 1 |
| Spoel- & installatiesystemen | zuil voor wastafel | | | | | | | |
| | 1023733 | | wit | 52430001 | stuk | 186,00 | 052 | 1 |
| | 1023734 | | pergamon | 52430009 | stuk | 224,00 | 052 | 1 |
| | 1023735 | m. ceramic+ | starwhite | 524300R2 | stuk | 287,00 | 052 | 1 |
| Badkamermeubelen en toiletkasten | handdoekhouder | | | | | | | |
| | 1023736 | 47x16x8.5cm | RVS | 979000D7 | stuk | 230,00 | 052 | 1 |
| Gootstenen en wastroggen | voorbouwwastafel | | | | | | | |
| | 1023787 | 56x45cm m. 3 kraangaten | wit | 51465501 | stuk | 325,00 | 052 | 1 |
| | 1023789 | 56x45cm m. 3 kraangaten | pergamon | 51465509 | stuk | 391,00 | 052 | 1 |
| | 1023788 | 56x43cm m. 3 kraangaten m. ceramic+ | wit | 514655R1 | stuk | 388,00 | 052 | 1 |
| | 1023790 | 56x45cm m. 3 kraangaten m. ceramic+ | pergamon | 514655R3 | stuk | 454,00 | 052 | 1 |
| | 1023791 | 56x45cm m. 3 kraangaten m. ceramic+ | starwhite | 514655R2 | stuk | 454,00 | 052 | 1 |
| Utiliteit | | | | | | | | |

| Art.nr | Specificaties | Kleur | Lev.nr | Ehd | Prijs | Grp | CC |
|-------------------------------------|---------------------------|-------------------------|-----------|----------|-------|---------|-------|
| Villeroy & Boch Sentique | | | | | | | |
| meubelwastafel | | | | | | | |
| 1023757 | 80x52cm | m. overloop | wit | 51428001 | stuk | 452,00 | 052 1 |
| 1023759 | 80x52cm | m. overloop | pergamon | 51428009 | stuk | 543,00 | 052 1 |
| 1023758 | 80x52cm | m. overloop m. ceramic+ | wit | 514280R1 | stuk | 515,00 | 052 1 |
| 1023760 | 80x52cm | m. overloop m. ceramic+ | pergamon | 514280R3 | stuk | 606,00 | 052 1 |
| 1023761 | 80x52cm | m. overloop m. ceramic+ | starwhite | 514280R2 | stuk | 606,00 | 052 1 |
| 1023762 | 80x52cm | z. overloop | wit | 51428101 | stuk | 494,00 | 052 1 |
| 1023764 | 80x52cm | z. overloop | pergamon | 51428109 | stuk | 585,00 | 052 1 |
| 1023763 | 80x52cm | z. overloop m. ceramic+ | wit | 514281R1 | stuk | 557,00 | 052 1 |
| 1023765 | 80x52cm | z. overloop m. ceramic+ | pergamon | 514281R3 | stuk | 648,00 | 052 1 |
| 1023766 | 80x52cm | z. overloop m. ceramic+ | starwhite | 514281R2 | stuk | 648,00 | 052 1 |
| 1023747 | 100x52cm | m. overloop | wit | 5142A001 | stuk | 591,00 | 052 1 |
| 1023749 | 100x52cm | m. overloop | pergamon | 5142A009 | stuk | 711,00 | 052 1 |
| 1023748 | 100x52cm | m. overloop m. ceramic+ | wit | 5142A0R1 | stuk | 654,00 | 052 1 |
| 1023750 | 100x52cm | m. overloop m. ceramic+ | pergamon | 5142A0R3 | stuk | 774,00 | 052 1 |
| 1023751 | 100x52cm | m. overloop m. ceramic+ | starwhite | 5142A0R2 | stuk | 773,00 | 052 1 |
| 1023752 | 100x52cm | z. overloop | wit | 5142A101 | stuk | 633,00 | 052 1 |
| 1023754 | 100x52cm | z. overloop | pergamon | 5142A109 | stuk | 752,00 | 052 1 |
| 1023753 | 100x52cm | z. overloop m. ceramic+ | wit | 5142A1R1 | stuk | 696,00 | 052 1 |
| 1023755 | 100x52cm | z. overloop m. ceramic+ | pergamon | 5142A1R3 | stuk | 815,00 | 052 1 |
| 1023756 | 100x52cm | z. overloop m. ceramic+ | starwhite | 5142A1R2 | stuk | 815,00 | 052 1 |
| 1023737 | 145x52cm | m. overloop | wit | 5142E001 | stuk | 756,00 | 052 1 |
| 1023739 | 145x52cm | m. overloop | pergamon | 5142E009 | stuk | 908,00 | 052 1 |
| 1023738 | 145x52cm | m. overloop m. ceramic+ | wit | 5142E0R1 | stuk | 819,00 | 052 1 |
| 1023740 | 145x52cm | m. overloop m. ceramic+ | pergamon | 5142E0R3 | stuk | 971,00 | 052 1 |
| 1023741 | 145x52cm | m. overloop m. ceramic+ | starwhite | 5142E0R2 | stuk | 971,00 | 052 1 |
| 1023742 | 145x52cm | z. overloop | wit | 5142E101 | stuk | 798,00 | 052 1 |
| 1023744 | 145x52cm | z. overloop | pergamon | 5142E109 | stuk | 950,00 | 052 1 |
| 1023743 | 145x52cm | z. overloop m. ceramic+ | wit | 5142E1R1 | stuk | 861,00 | 052 1 |
| 1023745 | 145x52cm | z. overloop m. ceramic+ | pergamon | 5142E1R3 | stuk | 1013,00 | 052 1 |
| 1023746 | 145x52cm | z. overloop m. ceramic+ | starwhite | 5142E1R2 | stuk | 1013,00 | 052 1 |
| 0830097 | bevestigingsset M10x110mm | | | 0830097 | paar | 1,09 | 362 0 |
| meubelwastafel dubbel | | | | | | | |
| 1023720 | 130x52cm | m. overloop | wit | 5126D001 | stuk | 777,00 | 052 1 |
| 1023722 | 130x52cm | m. overloop | pergamon | 5126D009 | stuk | 933,00 | 052 1 |
| 1023721 | 130x52cm | m. overloop m. ceramic+ | wit | 5126D0R1 | stuk | 840,00 | 052 1 |
| 1023723 | 130x52cm | m. overloop m. ceramic+ | pergamon | 5126D0R3 | stuk | 996,00 | 052 1 |
| 1023724 | 130x52cm | m. overloop m. ceramic+ | starwhite | 5126D0R2 | stuk | 996,00 | 052 1 |
| 1023725 | 130x52cm | z. overloop | wit | 5126D101 | stuk | 819,00 | 052 1 |
| 1023727 | 130x52cm | z. overloop | pergamon | 5126D109 | stuk | 975,00 | 052 1 |
| 1023726 | 130x52cm | z. overloop m. ceramic+ | wit | 5126D1R1 | stuk | 882,00 | 052 1 |
| 1023728 | 130x52cm | z. overloop m. ceramic+ | pergamon | 5126D1R3 | stuk | 1038,00 | 052 1 |
| 1023729 | 130x52cm | z. overloop m. ceramic+ | starwhite | 5126D1R2 | stuk | 1037,00 | 052 1 |
| 0830097 | bevestigingsset M10x110mm | | | 0830097 | paar | 1,09 | 362 0 |
| fontein | | | | | | | |
| 1023792 | 45x36cm | m. overloop | wit | 53224501 | stuk | 129,00 | 052 1 |
| 1023794 | 45x36cm | m. overloop | pergamon | 53224509 | stuk | 156,00 | 052 1 |
| 1023793 | 45x36cm | m. overloop m. ceramic+ | wit | 532245R1 | stuk | 192,00 | 052 1 |
| 1023795 | 45x36cm | m. overloop m. ceramic+ | pergamon | 532245R3 | stuk | 219,00 | 052 1 |
| 1023796 | 45x36cm | m. overloop m. ceramic+ | starwhite | 532245R2 | stuk | 219,00 | 052 1 |
| 1023797 | 45x36cm | z. overloop | wit | 53224601 | stuk | 171,00 | 052 1 |
| 1023799 | 45x36cm | z. overloop | pergamon | 53224609 | stuk | 198,00 | 052 1 |
| 1023798 | 45x36cm | z. overloop m. ceramic+ | wit | 532246R1 | stuk | 234,00 | 052 1 |
| 1023800 | 45x36cm | z. overloop m. ceramic+ | pergamon | 532246R3 | stuk | 261,00 | 052 1 |
| 1023801 | 45x36cm | z. overloop m. ceramic+ | starwhite | 532246R2 | stuk | 260,00 | 052 1 |
| 0830097 | bevestigingsset M10x110mm | | | 0830097 | paar | 1,09 | 362 0 |
| sifonkap voor fontein | | | | | | | |
| 1023802 | | | wit | 52220001 | stuk | 143,00 | 052 1 |
| 1023803 | | | pergamon | 52220009 | stuk | 171,00 | 052 1 |
| 1023804 | | m. ceramic+ | starwhite | 522200R2 | stuk | 234,00 | 052 1 |



Sanitair producten

Baden /
douchebakken /
stoomcabines

Kranen

Douchegarnituur

Accessoires en
spiegels

Douchewanden

Toebehoren &
afvoerenSpoel- &
installatiesystemenBadkamermeubelen
en toiletkastenGootstenen en
wastroggen

Utiliteit



| Art.nr | Specificaties | Kleur | Lev.nr | Ehd | Prijs | Grp | CC |
|---------------------------------------|---------------------------------|-----------|----------|------|--------|-----|----|
| Villeroy & Boch Sentique | | | | | | | |
| fontein compact | | | | | | | |
| 1023805 | 36x26cm m. overloop | wit | 53233601 | stuk | 106,00 | 052 | 1 |
| 1023807 | 36x26cm m. overloop | pergamon | 53233609 | stuk | 129,00 | 052 | 1 |
| 1023806 | 36x26cm m. overloop m. ceramic+ | wit | 532336R1 | stuk | 169,00 | 052 | 1 |
| 1023808 | 36x26cm m. overloop m. ceramic+ | pergamon | 532336R3 | stuk | 192,00 | 052 | 1 |
| 1023809 | 36x26cm m. overloop m. ceramic+ | starwhite | 532336R2 | stuk | 192,00 | 052 | 1 |
| 1023810 | 36x26cm z. overloop | wit | 53233701 | stuk | 148,00 | 052 | 1 |
| 1023812 | 36x26cm z. overloop | pergamon | 53233709 | stuk | 171,00 | 052 | 1 |
| 1023811 | 36x26cm z. overloop m. ceramic+ | wit | 532337R1 | stuk | 211,00 | 052 | 1 |
| 1023813 | 36x26cm z. overloop m. ceramic+ | pergamon | 532337R3 | stuk | 234,00 | 052 | 1 |
| 1023814 | 36x26cm z. overloop m. ceramic+ | starwhite | 532337R2 | stuk | 234,00 | 052 | 1 |
| wandbidet | | | | | | | |
| 1023815 | | wit | 54220001 | stuk | 350,00 | 052 | 1 |
| 1023817 | | pergamon | 54220009 | stuk | 420,00 | 052 | 1 |
| 1023816 | m. ceramic+ | wit | 542200R1 | stuk | 413,00 | 052 | 1 |
| 1023818 | m. ceramic+ | pergamon | 542200R3 | stuk | 483,00 | 052 | 1 |
| 1023819 | m. ceramic+ | starwhite | 542200R2 | stuk | 483,00 | 052 | 1 |
| staand bidet | | | | | | | |
| 1023820 | | wit | 54230001 | stuk | 317,00 | 052 | 1 |
| 1023822 | | pergamon | 54230009 | stuk | 382,00 | 052 | 1 |
| 1023821 | m. ceramic+ | wit | 542300R1 | stuk | 380,00 | 052 | 1 |
| 1023823 | m. ceramic+ | pergamon | 542300R3 | stuk | 445,00 | 052 | 1 |
| 1023824 | m. ceramic+ | starwhite | 542300R2 | stuk | 445,00 | 052 | 1 |
| wandclosetpot diepspoel | | | | | | | |
| 1023825 | | wit | 56221001 | stuk | 317,00 | 052 | 1 |
| 1023827 | | pergamon | 56221009 | stuk | 382,00 | 052 | 1 |
| 1023826 | m. ceramic+ | wit | 562210R1 | stuk | 380,00 | 052 | 1 |
| 1023828 | m. ceramic+ | pergamon | 562210R3 | stuk | 445,00 | 052 | 1 |
| 1023829 | m. ceramic+ | starwhite | 562210R2 | stuk | 445,00 | 052 | 1 |
| closetzitting dubbel | | | | | | | |
| 1023830 | m. softclose | wit | 98M8S101 | stuk | 207,00 | 052 | 1 |
| 1023831 | m. softclose | pergamon | 98M8S109 | stuk | 228,00 | 052 | 1 |
| 1023832 | m. softclose m. ceramic+ | starwhite | 98M8S1R2 | stuk | 228,00 | 052 | 1 |
| 1023833 | | wit | 98M8Q101 | stuk | 165,00 | 052 | 1 |
| 1023834 | | pergamon | 98M8Q109 | stuk | 182,00 | 052 | 1 |
| 1023835 | | starwhite | 98M8Q1R2 | stuk | 182,00 | 052 | 1 |
| closetpot diepspoel PK | | | | | | | |
| 1023836 | | wit | 56241001 | stuk | 372,00 | 052 | 1 |
| 1023838 | | pergamon | 56241009 | stuk | 448,00 | 052 | 1 |
| 1023837 | m. ceramic+ | wit | 562410R1 | stuk | 435,00 | 052 | 1 |
| 1023839 | m. ceramic+ | pergamon | 562410R3 | stuk | 511,00 | 052 | 1 |
| 1023840 | m. ceramic+ | starwhite | 562410R2 | stuk | 511,00 | 052 | 1 |
| duoblokpot diepspoel PK | | | | | | | |
| 1023841 | | wit | 56251001 | stuk | 331,00 | 052 | 1 |
| 1023843 | | pergamon | 56251009 | stuk | 397,00 | 052 | 1 |
| 1023842 | m. ceramic+ | wit | 562510R1 | stuk | 394,00 | 052 | 1 |
| 1023844 | m. ceramic+ | pergamon | 562510R3 | stuk | 460,00 | 052 | 1 |
| 1023845 | m. ceramic+ | starwhite | 562510R2 | stuk | 460,00 | 052 | 1 |
| duoblokreservoir m. binnenwerk | | | | | | | |
| 1023846 | | wit | 57221101 | stuk | 190,00 | 052 | 1 |
| 1023847 | | pergamon | 57221109 | stuk | 205,00 | 052 | 1 |
| 1023848 | | starwhite | 572211R2 | stuk | 268,00 | 052 | 1 |

| Art.nr | Specificaties | Kleur | Lev.nr | Ehd | Prijs | Grp | CC |
|-------------------------------------|----------------|----------|----------|------|---------|-----|----|
| Villeroy & Boch Sentique | | | | | | | |
| onderkast | | | | | | | |
| 1023853 | 125x45x42.5cm | glanswit | A25150DH | stuk | 984,00 | 323 | 1 |
| 1023854 | 140x45x42.5cm | glanswit | A25140DH | stuk | 1011,00 | 323 | 1 |
| 1023855 | 95x45x42.5cm | glanswit | A25130DH | stuk | 726,00 | 323 | 1 |
| 1023856 | 75x45x42.5cm | glanswit | A25120DH | stuk | 612,00 | 323 | 1 |
| 1023857 | 44x40x35.5cm | glanswit | A25110DH | stuk | 494,00 | 323 | 1 |
| 1023858 | 32.5x39.5x25cm | glanswit | A25100DH | stuk | 367,00 | 323 | 1 |



Sanitair producten

Baden /
douchebakken /
stoomcabines

Kranen

Douchegarnituur

Accessoires en
spiegels

Douchewanden

Toebehoren &
afvoerenSpoel- &
installatiesystemenBadkamermeubelen
en toiletkastenGootstenen en
wastroggen

Utiliteit









spiegelkast m. verlichting









| | | | | | | | |
|---------|---------|----------|----------|------|---------|-----|---|
| 1023859 | 80x75cm | glanswit | A30080DH | stuk | 1182,00 | 323 | 1 |
|---------|---------|----------|----------|------|---------|-----|---|

**spiegel m. verlichting**

| | | | | | | | |
|---------|----------|------------|----------|------|--------|-----|---|
| 1023860 | 120x75cm | (2 lampen) | A3012200 | stuk | 925,00 | 323 | 1 |
| 1023861 | 120x75cm | (1 lamp) | A3011200 | stuk | 872,00 | 323 | 1 |
| 1023862 | 90x75cm | (1 lamp) | A3019000 | stuk | 627,00 | 323 | 1 |
| 1023863 | 80x75cm | (1 lamp) | A3018000 | stuk | 591,00 | 323 | 1 |
| 1023864 | 55x75cm | | A3015500 | stuk | 504,00 | 323 | 1 |
| 1023865 | 40x60cm | | A3014000 | stuk | 156,00 | 323 | 1 |



| | Art.nr | Specificaties | Kleur | Lev.nr | Ehd | Prijs | Grp | CC | |
|---|---|-----------------------|---|----------|----------|--------|---------|-----|---|
| Sanitair producten | Villeroy & Boch Sentique | | | | | | | | |
| | glasplanchet | | | | | | | | |
| |  | 1023866 | 120x12x0.8cm | | A3021200 | stuk | 207,00 | 323 | 1 |
| | | 1023867 | 90x12x0.8cm | | A3029000 | stuk | 150,00 | 323 | 1 |
| | | 1023868 | 80x12x0.8cm | | A3028000 | stuk | 141,00 | 323 | 1 |
| | 1023869 | 55x12x0.8cm | | A3025500 | stuk | 120,00 | 323 | 1 | |
| Baden / douchebakken / stoomcabines | | | | | | | | | |
| Kranen | zijkast | | | | | | | | |
| |  | 1023870 | 35.5x97x37.5cm links | glanswit | A25800DH | stuk | 751,00 | 323 | 1 |
| | | 1023871 | 35.5x97x37.5cm rechts | glanswit | A25801DH | stuk | 751,00 | 323 | 1 |
| | | 1023872 | 35.5x81x37.5cm links | glanswit | A25700DH | stuk | 561,00 | 323 | 1 |
| | 1023873 | 35.5x81x37.5cm rechts | glanswit | A25701DH | stuk | 561,00 | 323 | 1 | |
| Douchegarnituur | | | | | | | | | |
| Accessoires en spiegels |  | | | | | | | | |
| Douchewanden | Villeroy & Boch Soho | | | | | | | | |
| | wastafel | | | | | | | | |
| |  | 0140694 | 60x45cm z. overloop 3-gats kr. ceramic+ | wit | 7147B2R1 | stuk | 624,00 | 052 | 1 |
| | | 0140716 | 60x45cm m. overloop 3-krq ceramic+ | wit | 7147A2R1 | stuk | 624,00 | 052 | 1 |
| | | 0140678 | 95x48cm m. overloop 3-krq kr. ceramic+ | wit | 7147A1R1 | stuk | 782,00 | 052 | 1 |
| Toebehoren & afvoeren | | 0830097 | bevestigingsset M10x110mm | 0830097 | paar | 1,09 | 362 | 0 | |
| Spoel- & installatiesystemen |  | | | | | | | | |
| Badkamermeubelen en toiletkasten | wastafelonderbouw m. rooster 95cm | | | | | | | | |
| |  | 0173102 | | | 960010C0 | stuk | 907,00 | 323 | 1 |
| Gootstenen en wastroggen | | | | | | | | | |
| Utiliteit | open rek m. 3 glasplaten | | | | | | | | |
| |  | 0122200 | | | 959900C0 | stuk | 1105,00 | 323 | 1 |
| | spiegel | | | | | | | | |
|  | 0173104 | 93x43cm | | 95920000 | stuk | 173,00 | 323 | 1 | |
| | hocker 50cm hoog | | | | | | | | |
|  | 0122227 | | | 959800C0 | stuk | 374,00 | 323 | 1 | |

| Art.nr | Specificaties | Kleur | Lev.nr | Ehd | Prijs | Grp | CC | |
|---|---------------------------|-----------|----------|----------|--------|--------|-------|---|
| | | | | | | | | Villeroy & Boch Soho |
| wastafelonderbouw m. glas planchet | | | | | | | |  |
| 0172116 | 58x68.5x37 | hout | 960200C0 | stuk | 747,00 | 323 | 1 | |
| wastafelonderbouw m. aluminium rooster | | | | | | | | |
| 0172138 | 58x68.5x37 | hout | 960210C0 | stuk | 747,00 | 323 | 1 | |
| | | | | | | | | Villeroy & Boch Stratos |
| wastafel | | | | | | | |  |
| 0107492 | 65x54cm | ceramic+ | wit | 715565R1 | stuk | 409,00 | 052 1 | |
| 0107506 | 65x54cm | ceramic+ | pergamon | 715565R3 | stuk | 409,00 | 052 1 | |
| 0131125 | 75x60cm | ceramic + | wit | 617275R1 | stuk | 551,00 | 052 1 | |
| 0120186 | 75x60cm | ceramic + | pergamon | 617275R3 | stuk | 551,00 | 052 1 | |
| 0107530 | 90x60cm | ceramic+ | wit | 617290R1 | stuk | 806,00 | 052 1 | |
| 0107549 | 90x60cm | ceramic+ | pergamon | 617290R3 | stuk | 806,00 | 052 1 | |
| 0830097 | bevestigingsset M10x110mm | | 0830097 | paar | 1,09 | 362 | 0 | |
| sifonkap voor wastafel | | | | | | | |  |
| 0131289 | ceramic+ | wit | 725600R1 | stuk | 276,00 | 052 | 1 | |
| 0131253 | ceramic+ | pergamon | 725600R3 | stuk | 276,00 | 052 | 1 | |
| zuil voor wastafel | | | | | | | |  |
| 0120219 | ceramic+ | wit | 725500R1 | stuk | 397,00 | 052 | 1 | |
| 0131210 | ceramic+ | pergamon | 725500R3 | stuk | 397,00 | 052 | 1 | |
| staand bidet | | | | | | | |  |
| 0107573 | ceramic+ | wit | 745500R1 | stuk | 665,00 | 052 | 1 | |
| 0107581 | ceramic+ | pergamon | 745500R3 | stuk | 665,00 | 052 | 1 | |
| wandbidet | | | | | | | |  |
| 0107603 | ceramic+ | wit | 745600R1 | stuk | 698,00 | 052 | 1 | |
| 0107611 | ceramic+ | pergamon | 745600R3 | stuk | 698,00 | 052 | 1 | |
| zitrand voor bidet | | | | | | | |  |
| 0102296 | | wit | 99470001 | stuk | 137,00 | 052 | 1 | |
| 0111880 | | pergamon | 99470009 | stuk | 152,00 | 052 | 1 | |
| wandclosetpot diepspoel | | | | | | | |  |
| 0107638 | ceramic+ | wit | 767210R1 | stuk | 665,00 | 052 | 1 | |
| 0107646 | ceramic+ | pergamon | 767210R3 | stuk | 665,00 | 052 | 1 | |
| closetzitting dubbel | | | | | | | | |
| 0102326 | | wit | 99456101 | stuk | 194,00 | 052 | 1 | |
| 0102342 | | pergamon | 99456109 | stuk | 215,00 | 052 | 1 | |
| duoblokpot diepspoel z. reservoir | | | | | | | | |
| 0108693 | ceramic+ | wit | 767110R1 | stuk | 741,00 | 052 | 1 | |
| 0107662 | ceramic+ | pergamon | 767110R3 | stuk | 741,00 | 052 | 1 | |
| duoblokreservoir + binnenwerk | | | | | | | | |
| 0102407 | ceramic+ | wit | 775511R1 | stuk | 529,00 | 052 | 1 | |
| 0112097 | ceramic+ | pergamon | 775511R3 | stuk | 529,00 | 052 | 1 | |

Sanitair producten

Baden /
douchebakken /
stoomcabines

Kranen

Douchegarnituur

Accessoires en
spiegels

Douchewanden

Toebehoren &
afvoerenSpoel- &
installatiesystemenBadkamermeubelen
en toiletkastenGootstenen en
wastroggen

Utiliteit

| | Art.nr | Specificaties | Kleur | Lev.nr | Ehd | Prijs | Grp | CC |
|---|---|---------------------------------------|----------|----------|--------|---------|-----|----|
| | Villeroy & Boch Stratos | | | | | | | |
| | closetcombinatie diepspoel | | | | | | | |
| Sanitair producten | 0113662 | ceramic+ | wit | STRATOS | stuk | 1270,00 | 052 | 1 |
| | 0113670 | ceramic+ | pergamon | STRATOS | stuk | 1270,00 | 052 | 1 |
| | 0102221 | vario afvoerbocht verticaal 160-250mm | | 87010000 | stuk | 68,00 | 052 | 0 |
| | 0102225 | vario afvoerbocht verticaal 70-160mm | | 87110000 | stuk | 68,00 | 052 | 1 |
| Baden / douchebakken / stoomcabines |  | | | | | | | |
| | Villeroy & Boch Subway | | | | | | | |
| | wastafel m. overloop m. kraangat | | | | | | | |
| Kranen | 0123146 | 55x43cm | wit | 61365501 | stuk | 124,00 | 053 | 0 |
| | 0123147 | 55x43cm | pergamon | 61365509 | stuk | 148,00 | 053 | 1 |
| | 0123148 | 55x43cm ceramic+ | wit | 613655R1 | stuk | 187,00 | 053 | 1 |
| | 0123149 | 55x43cm ceramic+ | pergamon | 613655R3 | stuk | 211,00 | 053 | 1 |
| Douchegarnituur | 0830097 | bevestigingsset M10x110mm | | 0830097 | paar | 1,09 | 362 | 0 |
| | wastafel z. overloop m. kraangat | | | | | | | |
| Accessoires en spiegels | 0123150 | 55x43cm | wit | 61365601 | stuk | 124,00 | 053 | 1 |
| | 0123151 | 55x43cm | pergamon | 61365609 | stuk | 148,00 | 053 | 1 |
| | 0123152 | 55x43cm ceramic+ | wit | 613656R1 | stuk | 187,00 | 053 | 1 |
| | 0123153 | 55x43cm ceramic+ | pergamon | 613656R3 | stuk | 211,00 | 053 | 1 |
| Douchewanden | 0830097 | bevestigingsset M10x110mm | | 0830097 | paar | 1,09 | 362 | 0 |
| | wastafel m. overloop z. kraangat | | | | | | | |
| Toebehoren & afvoeren | 0123154 | 55x43cm | wit | 61365701 | stuk | 158,00 | 053 | 1 |
| | 0123155 | 55x43cm | pergamon | 61365709 | stuk | 182,00 | 053 | 1 |
| | 0123156 | 55x43cm ceramic+ | wit | 613657R1 | stuk | 221,00 | 053 | 1 |
| | 0123157 | 55x43cm ceramic+ | pergamon | 613657R3 | stuk | 245,00 | 053 | 1 |
| Spoel- & installatiesystemen | 0830097 | bevestigingsset M10x110mm | | 0830097 | paar | 1,09 | 362 | 0 |
| | wastafel z. overloop z. kraangat | | | | | | | |
| Badkamermeubelen en toiletkasten | 0123158 | 55x43cm | wit | 61365801 | stuk | 158,00 | 053 | 1 |
| | 0123159 | 55x43cm | pergamon | 61365809 | stuk | 182,00 | 053 | 1 |
| | 0123160 | 55x43cm ceramic+ | wit | 613658R1 | stuk | 221,00 | 053 | 1 |
| | 0123161 | 55x43cm ceramic+ | pergamon | 613658R3 | stuk | 245,00 | 053 | 1 |
| Gootstenen en wastroggen | 0830097 | bevestigingsset M10x110mm | | 0830097 | paar | 1,09 | 362 | 0 |
| | wastafel compact z. overloop z. kraangat | | | | | | | |
| Utiliteit | 0123283 | 60x38cm | wit | 61386301 | stuk | 175,00 | 053 | 1 |
| | 0123284 | 60x38cm | pergamon | 61386309 | stuk | 203,00 | 053 | 1 |
| | 0123285 | 60x38cm ceramic+ | wit | 613863R1 | stuk | 238,00 | 053 | 1 |
| | 0123286 | 60x38cm ceramic+ | pergamon | 613863R3 | stuk | 266,00 | 053 | 1 |
| Utiliteit | wastafel compact m. overloop z. kraangat | | | | | | | |
| | 0123275 | 60x38cm | wit | 61386201 | stuk | 175,00 | 053 | 1 |
| | 0123280 | 60x38cm | pergamon | 61386209 | stuk | 203,00 | 053 | 1 |
| | 0123281 | 60x38cm ceramic+ | wit | 613862R1 | stuk | 238,00 | 053 | 1 |
| Utiliteit | 0123282 | 60x38cm ceramic+ | pergamon | 613862R3 | stuk | 266,00 | 053 | 1 |
| | wastafel compact z. overloop m. kraangat | | | | | | | |
| | 0123259 | 60x38cm | wit | 61386101 | stuk | 141,00 | 053 | 1 |
| | 0123262 | 60x38cm | pergamon | 61386109 | stuk | 169,00 | 053 | 1 |
| Utiliteit | 0123269 | 60x38cm ceramic+ | wit | 613861R1 | stuk | 204,00 | 053 | 1 |
| | 0123272 | 60x38cm ceramic+ | pergamon | 613861R3 | stuk | 232,00 | 053 | 1 |
| | wastafel compact m. overloop m. kraangat | | | | | | | |
| | 0123247 | 60x38cm | wit | 61386001 | stuk | 141,00 | 053 | 1 |
| 0123250 | 60x38cm | pergamon | 61386009 | stuk | 169,00 | 053 | 1 | |
| 0123253 | 60x38cm ceramic+ | wit | 613860R1 | stuk | 204,00 | 053 | 1 | |
| 0123256 | 60x38cm ceramic+ | pergamon | 613860R3 | stuk | 232,00 | 053 | 1 | |
| Utiliteit | wastafel m. overloop m. kraangat | | | | | | | |
| | 0123162 | 60x47cm | wit | 61366001 | stuk | 135,00 | 053 | 0 |
| | 0123163 | 60x47cm | pergamon | 61366009 | stuk | 163,00 | 053 | 1 |
| | 0123164 | 60x47cm ceramic+ | wit | 613660R1 | stuk | 198,00 | 053 | 1 |
| Utiliteit | 0123165 | 60x47cm ceramic+ | pergamon | 613660R3 | stuk | 226,00 | 053 | 1 |
| | 0830097 | bevestigingsset M10x110mm | | 0830097 | paar | 1,09 | 362 | 0 |
| | wastafel z. overloop m. kraangat | | | | | | | |
| | 0123166 | 60x47cm | wit | 61366101 | stuk | 135,00 | 053 | 1 |
| 0123167 | 60x47cm | pergamon | 61366109 | stuk | 163,00 | 053 | 1 | |
| 0123168 | 60x47cm ceramic+ | wit | 613661R1 | stuk | 198,00 | 053 | 1 | |
| 0123169 | 60x47cm ceramic+ | pergamon | 613661R3 | stuk | 226,00 | 053 | 1 | |
| 0830097 | bevestigingsset M10x110mm | | 0830097 | paar | 1,09 | 362 | 0 | |

| Art.nr | Specificaties | Kleur | Lev.nr | Ehd | Prijs | Grp | CC |
|---|---------------------------|-----------|----------|------|--------|-----|----|
| Villeroy & Boch Subway | | | | | | | |
| wastafel m. overloop z. kraangat | | | | | | | |
| 0123170 | 60x47cm | wit | 61366201 | stuk | 169,00 | 053 | 1 |
| 0123171 | 60x47cm | pergamon | 61366209 | stuk | 198,00 | 053 | 1 |
| 0123172 | 60x47cm ceramic+ | wit | 613662R1 | stuk | 232,00 | 053 | 1 |
| 0123173 | 60x47cm ceramic+ | pergamon | 613662R3 | stuk | 261,00 | 053 | 1 |
| 0830097 | bevestigingsset M10x110mm | | 0830097 | paar | 1,09 | 362 | 0 |
| wastafel z. overloop z. kraangat | | | | | | | |
| 0123174 | 60x47cm | wit | 61366301 | stuk | 169,00 | 053 | 1 |
| 0123175 | 60x47cm | pergamon | 61366309 | stuk | 198,00 | 053 | 1 |
| 0123176 | 60x47cm ceramic+ | wit | 613663R1 | stuk | 232,00 | 053 | 1 |
| 0123177 | 60x47cm ceramic+ | pergamon | 613663R3 | stuk | 261,00 | 053 | 1 |
| 0830097 | bevestigingsset M10x110mm | | 0830097 | paar | 1,09 | 362 | 0 |
| wastafel m. overloop m. kraangat | | | | | | | |
| 0123178 | 65x51cm | wit | 61366501 | stuk | 148,00 | 053 | 1 |
| 0123179 | 65x51cm | pergamon | 61366509 | stuk | 179,00 | 053 | 1 |
| 0123180 | 65x51cm ceramic+ | wit | 613665R1 | stuk | 211,00 | 053 | 1 |
| 0123181 | 65x51cm ceramic+ | pergamon | 613665R3 | stuk | 242,00 | 053 | 1 |
| 0830097 | bevestigingsset M10x110mm | | 0830097 | paar | 1,09 | 362 | 0 |
| wastafel z. overloop m. kraangat | | | | | | | |
| 0123182 | 65x51cm | wit | 61366601 | stuk | 148,00 | 053 | 1 |
| 0123183 | 65x51cm | pergamon | 61366609 | stuk | 179,00 | 053 | 1 |
| 0123184 | 65x51cm ceramic+ | wit | 613666R1 | stuk | 211,00 | 053 | 1 |
| 0123185 | 65x51cm ceramic+ | pergamon | 613666R3 | stuk | 242,00 | 053 | 1 |
| 0830097 | bevestigingsset M10x110mm | | 0830097 | paar | 1,09 | 362 | 0 |
| wastafel m. overloop z. kraangat | | | | | | | |
| 0123186 | 65x51cm | wit | 61366701 | stuk | 182,00 | 053 | 1 |
| 0123187 | 65x51cm | pergamon | 61366709 | stuk | 213,00 | 053 | 1 |
| 0123188 | 65x51cm ceramic+ | wit | 613667R1 | stuk | 245,00 | 053 | 1 |
| 0123189 | 65x51cm ceramic+ | pergamon | 613667R3 | stuk | 276,00 | 053 | 1 |
| 0830097 | bevestigingsset M10x110mm | | 0830097 | paar | 1,09 | 362 | 0 |
| wastafel z. overloop z. kraangat | | | | | | | |
| 0123190 | 65x51cm | wit | 61366801 | stuk | 182,00 | 053 | 1 |
| 0123191 | 65x51cm | pergamon | 61366809 | stuk | 213,00 | 053 | 1 |
| 0123192 | 65x51cm ceramic+ | wit | 613668R1 | stuk | 245,00 | 053 | 1 |
| 0123193 | 65x51cm ceramic+ | pergamon | 613668R3 | stuk | 276,00 | 053 | 1 |
| 0830097 | bevestigingsset M10x110mm | | 0830097 | paar | 1,09 | 362 | 0 |
| wastafel z. overloop | | | | | | | |
| 0100541 | 70x55cm | wit | 61367101 | stuk | 247,00 | 053 | 1 |
| 0100542 | 70x55cm | pergamon | 61367109 | stuk | 296,00 | 053 | 1 |
| 0100543 | 70x55cm ceramic+ | wit | 613671R1 | stuk | 310,00 | 053 | 1 |
| 0100544 | 70x55cm ceramic+ | starwhite | 613671R2 | stuk | 359,00 | 053 | 1 |
| 0100545 | 70x55cm ceramic+ | pergamon | 613671R3 | stuk | 359,00 | 053 | 1 |
| 0100546 | 70x55cm ceramic+ | edelweiss | 613671S3 | stuk | 458,00 | 053 | 1 |
| wastafel m. overloop z. kraangat | | | | | | | |
| 0100240 | 70x55cm | wit | 61367201 | stuk | 281,00 | 053 | 1 |
| 0100241 | 70x55cm | pergamon | 61367209 | stuk | 331,00 | 053 | 1 |
| 0100243 | 70x55cm ceramic+ | wit | 613672R1 | stuk | 344,00 | 053 | 1 |
| 0100244 | 70x55cm ceramic+ | starwhite | 613672R2 | stuk | 393,00 | 053 | 1 |
| 0100246 | 70x55cm ceramic+ | pergamon | 613672R3 | stuk | 394,00 | 053 | 1 |
| 0100248 | 70x55cm ceramic+ | edelweiss | 613672S3 | stuk | 492,00 | 053 | 1 |
| wastafel z. overloop z. kraangat | | | | | | | |
| 0100508 | 70x55cm | wit | 61367301 | stuk | 281,00 | 053 | 1 |
| 0100509 | 70x55cm | pergamon | 61367309 | stuk | 331,00 | 053 | 1 |
| 0100510 | 70x55cm ceramic+ | wit | 613673R1 | stuk | 344,00 | 053 | 1 |
| 0100512 | 70x55cm ceramic+ | starwhite | 613673R2 | stuk | 393,00 | 053 | 1 |
| 0100513 | 70x55cm ceramic+ | pergamon | 613673R3 | stuk | 394,00 | 053 | 1 |
| 0100514 | 70x55cm ceramic+ | edelweiss | 613673S3 | stuk | 492,00 | 053 | 1 |
| zuil voor wastafel | | | | | | | |
| 0123196 | | wit | 72505001 | stuk | 158,00 | 053 | 1 |
| 0123197 | | pergamon | 72505009 | stuk | 190,00 | 053 | 1 |



Sanitair producten

Baden /
douchebakken /
stoomcabines

Kranen

Douchegarnituur











Accessoires en
spiegels

Douchewanden

Toebehoren &
afvoerenSpoel- &
installatiesystemenBadkamermeubelen
en toiletkastenGootstenen en
wastroggen

Utiliteit

| | Art.nr | Specificaties | Kleur | Lev.nr | Ehd | Prijs | Grp | CC |
|---|---|--------------------------------------|----------|----------|------|--------|-----|----|
| Villeroy & Boch Subway | | | | | | | | |
| Sanitair producten | sifonkap voor wastafel m. bevestigingsset | | | | | | | |
| | 0123194 | | wit | 72640001 | stuk | 122,00 | 053 | 0 |
| | 0123195 | | pergamon | 72640009 | stuk | 146,00 | 053 | 1 |
| <hr/> | | | | | | | | |
| Baden / douchebakken / stoomcabines | fontein | | | | | | | |
| | 0123138 | 45x33cm | wit | 73054501 | stuk | 97,00 | 053 | 1 |
| Kranen | 0123139 | 45x33cm | pergamon | 73054509 | stuk | 118,00 | 053 | 1 |
| | 0123140 | 45x33cm ceramic+ | wit | 730545R1 | stuk | 160,00 | 053 | 1 |
| | 0123141 | 45x33cm ceramic+ | pergamon | 730545R3 | stuk | 181,00 | 053 | 1 |
| | 0123134 | 50x39cm | wit | 73055001 | stuk | 110,00 | 053 | 1 |
| | 0123135 | 50x39cm | pergamon | 73055009 | stuk | 133,00 | 053 | 1 |
| Douchegarnituur | 0123136 | 50x39cm ceramic+ | wit | 730550R1 | stuk | 173,00 | 053 | 1 |
| | 0123137 | 50x39cm ceramic+ | pergamon | 730550R3 | stuk | 196,00 | 053 | 1 |
| | 0123144 | 37x29cm | wit | 73093701 | stuk | 95,00 | 053 | 0 |
| | 0123145 | 37x29cm | pergamon | 73093709 | stuk | 114,00 | 053 | 1 |
| Accessoires en spiegels | 0123222 | 37x29cm ceramic+ | wit | 730937R1 | stuk | 158,00 | 053 | 1 |
| | 0123223 | 37x29cm ceramic+ | pergamon | 730937R3 | stuk | 177,00 | 053 | 1 |
| | 0830240 | bevestigingsset voor fontein M8x90mm | | 0830240 | stuk | 0,85 | 362 | 0 |
| | <hr/> | | | | | | | |
| Douchewanden | sifonkap voor fontein 45-50cm m. bevestiging | | | | | | | |
| | 0123142 | | wit | 72440001 | stuk | 122,00 | 053 | 1 |
| | 0123143 | | pergamon | 72440009 | stuk | 146,00 | 053 | 1 |
| <hr/> | | | | | | | | |
| Toebehoren & afvoeren | compact fontein z. kraangat | | | | | | | |
| | 0100154 | 55x25cm | wit | 73035201 | stuk | 137,00 | 053 | 1 |
| Spoel- & installatiesystemen | 0100155 | 55x25cm | pergamon | 73035209 | stuk | 158,00 | 053 | 1 |
| | 0100160 | 55x25cm ceramic+ | wit | 730352R1 | stuk | 200,00 | 053 | 1 |
| | 0100161 | 55x25cm ceramic+ | pergamon | 730352R3 | stuk | 221,00 | 053 | 1 |
| Badkamermeubelen en toiletkasten | compact fontein m. kraangat links | | | | | | | |
| | 0100150 | 55x25cm | wit | 73035L01 | stuk | 103,00 | 053 | 0 |
| | 0100151 | 55x25cm | pergamon | 73035L09 | stuk | 124,00 | 053 | 1 |
| | 0100156 | 55x25cm ceramic+ | wit | 73035LR1 | stuk | 166,00 | 053 | 1 |
| | 0100157 | 55x25cm ceramic+ | pergamon | 73035LR3 | stuk | 187,00 | 053 | 1 |
| Gootstenen en wastroggen | compact fontein m. kraangat rechts | | | | | | | |
| | 0100152 | 55x25cm | wit | 73035R01 | stuk | 103,00 | 053 | 0 |
| | 0100153 | 55x25cm | pergamon | 73035R09 | stuk | 124,00 | 053 | 1 |
| | 0100158 | 55x25cm ceramic+ | wit | 73035RR1 | stuk | 166,00 | 053 | 1 |
| | 0100159 | 55x25cm ceramic+ | pergamon | 73035RR3 | stuk | 187,00 | 053 | 1 |
| Utiliteit | hoekfontein m. kraangat | | | | | | | |
| | 0100162 | 45x38cm | wit | 73064501 | stuk | 139,00 | 053 | 0 |
| | 0100147 | 45x38cm | pergamon | 73064509 | stuk | 167,00 | 053 | 1 |
| | 0100148 | 45x38cm ceramic+ | wit | 730645R1 | stuk | 202,00 | 053 | 1 |
| | 0100149 | 45x38cm ceramic+ | pergamon | 730645R3 | stuk | 230,00 | 053 | 1 |
| | 0830240 | bevestigingsset voor fontein M8x90mm | | 0830240 | stuk | 0,85 | 362 | 0 |
| <hr/> | | | | | | | | |
| | meubelwastafel 100cm | | | | | | | |
| | 0123206 | | wit | 61161001 | stuk | 460,00 | 053 | 1 |
| | 0123207 | | pergamon | 61161009 | stuk | 553,00 | 053 | 1 |
| | 0123208 | ceramic+ | wit | 611610R1 | stuk | 523,00 | 053 | 1 |
| | 0123209 | ceramic+ | pergamon | 611610R3 | stuk | 616,00 | 053 | 1 |
| | 0830097 | bevestigingsset M10x110mm | | 0830097 | paar | 1,09 | 362 | 0 |
| | meubelwastafel 80cm | | | | | | | |
| | 0123210 | | wit | 61168001 | stuk | 376,00 | 053 | 1 |
| | 0123211 | | pergamon | 61168009 | stuk | 452,00 | 053 | 1 |
| | 0123212 | ceramic+ | wit | 611680R1 | stuk | 439,00 | 053 | 1 |
| | 0123213 | ceramic+ | pergamon | 611680R3 | stuk | 515,00 | 053 | 1 |
| | 0830097 | bevestigingsset M10x110mm | | 0830097 | paar | 1,09 | 362 | 0 |
| | meubelwastafel 130cm | | | | | | | |
| | 0123202 | | wit | 61181301 | stuk | 604,00 | 053 | 1 |
| | 0123203 | | pergamon | 61181309 | stuk | 726,00 | 053 | 1 |
| | 0123204 | ceramic+ | wit | 611813R1 | stuk | 667,00 | 053 | 1 |
| | 0123205 | ceramic+ | pergamon | 611813R3 | stuk | 789,00 | 053 | 1 |
| | 0830097 | bevestigingsset M10x110mm | | 0830097 | paar | 1,09 | 362 | 0 |

| Art.nr | Specificaties | Kleur | Lev.nr | Ehd | Prijs | Grp | CC | |
|---|---------------------------------------|-----------|----------|------|---------|-----|----|---|
| Villeroy & Boch Subway | | | | | | | | |
| meubelwastafel dubbel 130cm | | | | | | | | |
| 0123198 | | wit | 61311301 | stuk | 633,00 | 053 | 0 |  |
| 0123199 | | pergamon | 61311309 | stuk | 760,00 | 053 | 1 | |
| 0123200 | ceramic+ | wit | 613113R1 | stuk | 696,00 | 053 | 1 | |
| 0123201 | ceramic+ | pergamon | 613113R3 | stuk | 823,00 | 053 | 1 | |
| 0830097 | bevestigingsset M10x110mm | | 0830097 | paar | 1,09 | 362 | 0 | |
| wandbidet | | | | | | | | |
| 0123130 | | wit | 74000001 | stuk | 281,00 | 053 | 1 |  |
| 0123131 | | pergamon | 74000009 | stuk | 338,00 | 053 | 1 | |
| 0123132 | ceramic+ | wit | 740000R1 | stuk | 344,00 | 053 | 1 | |
| 0123133 | ceramic+ | pergamon | 740000R3 | stuk | 401,00 | 053 | 1 | |
| wandbidet compact | | | | | | | | |
| 0123287 | | wit | 74060001 | stuk | 323,00 | 053 | 1 |  |
| 0123288 | | pergamon | 74060009 | stuk | 388,00 | 053 | 1 | |
| 0123289 | ceramic+ | wit | 740600R1 | stuk | 386,00 | 053 | 1 | |
| 0123290 | ceramic+ | pergamon | 740600R3 | stuk | 451,00 | 053 | 1 | |
| wandclosetpot diepspoel | | | | | | | | |
| 0123116 | | wit | 66001001 | stuk | 262,00 | 053 | 0 |  |
| 0123117 | | pergamon | 66001009 | stuk | 315,00 | 053 | 0 | |
| 0123118 | ceramic+ | wit | 660010R1 | stuk | 325,00 | 053 | 0 | |
| 0123119 | ceramic+ | pergamon | 660010R3 | stuk | 378,00 | 053 | 1 | |
| wandclosetpot compact diepspoel | | | | | | | | |
| 0123291 | | wit | 66041001 | stuk | 268,00 | 053 | 0 |  |
| 0123292 | | pergamon | 66041009 | stuk | 323,00 | 053 | 1 | |
| 0123293 | ceramic+ | wit | 660410R1 | stuk | 331,00 | 053 | 0 | |
| 0123294 | ceramic+ | pergamon | 660410R3 | stuk | 386,00 | 053 | 1 | |
| duoblokpot diepspoel universeel z. reservoir | | | | | | | | |
| 0123124 | | wit | 66091001 | stuk | 287,00 | 053 | 0 |  |
| 0123125 | | pergamon | 66091009 | stuk | 346,00 | 053 | 1 | |
| 0123126 | ceramic+ | wit | 660910R1 | stuk | 350,00 | 053 | 1 | |
| 0123127 | ceramic+ | pergamon | 660910R3 | stuk | 409,00 | 053 | 1 | |
| 0102221 | vario afvoerbocht verticaal 160-250mm | | 87010000 | stuk | 68,00 | 052 | 0 | |
| 0102225 | vario afvoerbocht verticaal 70-160mm | | 87110000 | stuk | 68,00 | 052 | 1 | |
| duoblokreservoir + binnenwerk | | | | | | | | |
| 0123128 | | wit | 77231101 | stuk | 125,00 | 053 | 0 |  |
| 0123129 | | pergamon | 77231109 | stuk | 127,00 | 053 | 1 | |
| closetzitting dubbel | | | | | | | | |
| 0123120 | | wit | 9955Q101 | stuk | 154,00 | 053 | 0 |  |
| 0123121 | | pergamon | 9955Q109 | stuk | 171,00 | 053 | 1 | |
| 0123122 | m. softscharnier | wit | 9955S101 | stuk | 196,00 | 053 | 0 | |
| 0123123 | m. softscharnier | pergamon | 9955S109 | stuk | 217,00 | 053 | 0 | |
| compact closetzitting m. softscharnieren | | | | | | | | |
| 0123297 | | wit | 9966S101 | stuk | 201,00 | 053 | 0 |  |
| 0123298 | | pergamon | 9966S109 | stuk | 222,00 | 053 | 1 | |
| compact closetzitting dubbel | | | | | | | | |
| 0123295 | | wit | 9966Q101 | stuk | 162,00 | 053 | 0 |  |
| 0123296 | | pergamon | 9966Q109 | stuk | 179,00 | 053 | 1 | |
| closetcombinatie Purair PK m. zitting | | | | | | | | |
| 1023667 | | wit | 6609N001 | stuk | 884,00 | 053 | 1 |  |
| 1023669 | | pergamon | 6609N009 | stuk | 965,00 | 053 | 1 | |
| 1023668 | m. ceramic+ | wit | 6609NOR1 | stuk | 1009,00 | 053 | 1 | |
| 1023670 | m. ceramic+ | pergamon | 6609NOR3 | stuk | 1091,00 | 053 | 1 | |
| 1023671 | | starwhite | 6609NOR2 | stuk | 1091,00 | 053 | 1 | |
| 1023672 | nabij wand | wit | 6610N001 | stuk | 901,00 | 053 | 1 | |
| 1023674 | nabij wand | pergamon | 6610N009 | stuk | 984,00 | 053 | 1 | |
| 1023673 | nabij wand m. ceramic+ | wit | 6610NOR1 | stuk | 1026,00 | 053 | 1 | |
| 1023675 | nabij wand m. ceramic+ | pergamon | 6610NOR3 | stuk | 1110,00 | 053 | 1 | |
| 1023676 | nabij wand m. ceramic+ | starwhite | 6610NOR2 | stuk | 1110,00 | 053 | 1 | |

Sanitair producten

Baden /
douchebakken /
stoomcabines

Kranen

Douchegarnituur

Accessoires en
spiegels

Douchewanden

Toebehoren &
afvoerenSpoel- &
installatiesystemenBadkamermeubelen
en toiletkastenGootstenen en
wastroggen

Utiliteit

| | Art.nr | Specificaties | Kleur | Lev.nr | Ehd | Prijs | Grp | CC |
|---|---|---|-----------|----------|------|--------|-----|----|
| Villeroy & Boch Subway | | | | | | | | |
| Sanitair producten | urinoir voor deksel | | | | | | | |
| | 1023849 | m. ceramic+ | wit | 751301R1 | stuk | 359,00 | 053 | 1 |
| | 1023850 | m. ceramic+ | pergamon | 751301R3 | stuk | 420,00 | 053 | 1 |
| | 1023851 | m. ceramic+ | starwhite | 751301R2 | stuk | 420,00 | 053 | 1 |
| Baden / douchebakken / stoomcabines | deksel voor urinoir | | | | | | | |
| | 1023852 | | starwhite | 9956S1R2 | stuk | 158,00 | 053 | 1 |
| Kranen | urinoir z. deksel | | | | | | | |
| | 0123214 | | wit | 75130001 | stuk | 268,00 | 053 | 1 |
| | 0123215 | | pergamon | 75130009 | stuk | 323,00 | 053 | 1 |
| | 0100951 | inlaatfitting urinoir Esta/Magnum/Stratos | | 99330000 | stuk | 27,00 | 053 | 1 |
| | 0104590 | urinoirsifon horizontaal | | 93090000 | stuk | 25,50 | 053 | 0 |
| | 0104604 | urinoirsifon verticaal | | 93080000 | stuk | 25,50 | 053 | 1 |
| Douchegarnituur | urinoir z. deksel m. bom | | | | | | | |
| | 0123218 | | wit | 75130501 | stuk | 312,00 | 053 | 1 |
| Accessoires en spiegels | 0123219 | | pergamon | 75130509 | stuk | 367,00 | 053 | 1 |
| | 0100951 | inlaatfitting urinoir Esta/Magnum/Stratos | | 99330000 | stuk | 27,00 | 053 | 1 |
| | 0104590 | urinoirsifon horizontaal | | 93090000 | stuk | 25,50 | 053 | 0 |
| | 0104604 | urinoirsifon verticaal | | 93080000 | stuk | 25,50 | 053 | 1 |
| Douchewanden | urinoir voor deksel | | | | | | | |
| | 0123216 | | wit | 75130101 | stuk | 296,00 | 053 | 0 |
| | 0123217 | | pergamon | 75130109 | stuk | 357,00 | 053 | 1 |
| | 0100951 | inlaatfitting urinoir Esta/Magnum/Stratos | | 99330000 | stuk | 27,00 | 053 | 1 |
| | 0104590 | urinoirsifon horizontaal | | 93090000 | stuk | 25,50 | 053 | 0 |
| Toebehoren & afvoeren | 0104604 | urinoirsifon verticaal | | 93080000 | stuk | 25,50 | 053 | 1 |
| | deksel voor urinoir | | | | | | | |
| Spoel- & installatiesystemen | 0123220 | | wit | 9956S101 | stuk | 143,00 | 053 | 0 |
| | 0123221 | | pergamon | 9956S109 | stuk | 158,00 | 053 | 1 |
| Badkamermeubelen en toiletkasten | AquaZero urinoir m. bevestiging en 0-liter sifon | | | | | | | |
| | 0100518 | | wit | 75170001 | stuk | 507,00 | 053 | 1 |
| | 0100519 | | pergamon | 75170009 | stuk | 610,00 | 053 | 1 |
| | 0100520 | ceramic+ | wit | 751700R1 | stuk | 570,00 | 053 | 1 |
| | 0100521 | ceramic+ | starwhite | 751700R2 | stuk | 673,00 | 053 | 1 |
| | 0100522 | ceramic+ | pergamon | 751700R3 | stuk | 673,00 | 053 | 1 |
| Gootstenen en wastroggen | 0100523 | ceramic+ | edelweiss | 751700S3 | stuk | 876,00 | 053 | 1 |
| | AquaOne urinoir m. bevestiging en 1-liter sifon | | | | | | | |
| Utiliteit | 0100497 | | wit | 75190501 | stuk | 551,00 | 053 | 1 |
| | 0100499 | | pergamon | 75190509 | stuk | 654,00 | 053 | 1 |
| | 0100504 | ceramic+ | edelweiss | 751905S3 | stuk | 920,00 | 053 | 1 |
| | 0100500 | ceramic+ | wit | 751905R1 | stuk | 614,00 | 053 | 1 |
| | 0100502 | ceramic+ | starwhite | 751905R2 | stuk | 716,00 | 053 | 1 |
| | 0100503 | ceramic+ | pergamon | 751905R3 | stuk | 717,00 | 053 | 1 |

| Art.nr | Specificaties | Kleur | Lev.nr | Ehd | Prijs | Grp | CC |
|-------------------------------------|------------------------------|-----------|----------|------|--------|-----|----|
| Villeroy & Boch Sunberry | | | | | | | |
| wastafel | | | | | | | |
| 0100232 | 55x46cm m. overloop | wit | 51305501 | stuk | 124,00 | 053 | 1 |
| 0100233 | 55x46cm m. overloop | pergamon | 51305509 | stuk | 148,00 | 053 | 1 |
| 0100234 | 55x46cm m. overloop ceramic+ | wit | 513055R1 | stuk | 187,00 | 053 | 1 |
| 0100236 | 55x46cm m. overloop ceramic+ | starwhite | 513055R2 | stuk | 211,00 | 053 | 1 |
| 0100235 | 55x46cm m. overloop ceramic+ | pergamon | 513055R3 | stuk | 211,00 | 053 | 1 |
| 0100437 | 55x46cm z. overloop | wit | 51305601 | stuk | 124,00 | 053 | 1 |
| 0100438 | 55x46cm z. overloop | pergamon | 51305609 | stuk | 148,00 | 053 | 1 |
| 0100440 | 55x46cm z. overloop ceramic+ | wit | 513056R1 | stuk | 187,00 | 053 | 1 |
| 0100442 | 55x46cm z. overloop ceramic+ | starwhite | 513056R2 | stuk | 211,00 | 053 | 1 |
| 0100441 | 55x46cm z. overloop ceramic+ | pergamon | 513056R3 | stuk | 211,00 | 053 | 1 |
| 0100291 | 60x49cm m. overloop | wit | 51306001 | stuk | 135,00 | 053 | 1 |
| 0100292 | 60x49cm m. overloop | pergamon | 51306009 | stuk | 163,00 | 053 | 1 |
| 0100293 | 60x49cm m. overloop ceramic+ | wit | 513060R1 | stuk | 198,00 | 053 | 1 |
| 0100295 | 60x49cm m. overloop ceramic+ | starwhite | 513060R2 | stuk | 226,00 | 053 | 1 |
| 0100294 | 60x49cm m. overloop ceramic+ | pergamon | 513060R3 | stuk | 226,00 | 053 | 1 |
| 0100351 | 60x49cm z. overloop | wit | 51306101 | stuk | 135,00 | 053 | 1 |
| 0100352 | 60x49cm z. overloop | pergamon | 51306109 | stuk | 163,00 | 053 | 1 |
| 0100353 | 60x49cm z. overloop | wit | 513061R1 | stuk | 198,00 | 053 | 1 |
| 0100355 | 60x49cm z. overloop ceramic+ | starwhite | 513061R2 | stuk | 226,00 | 053 | 1 |
| 0100354 | 60x49cm z. overloop ceramic+ | pergamon | 513061R3 | stuk | 226,00 | 053 | 1 |
| 0100327 | 65x52cm m. overloop | wit | 51306501 | stuk | 148,00 | 053 | 1 |
| 0100328 | 65x52cm m. overloop | pergamon | 51306509 | stuk | 179,00 | 053 | 1 |
| 0100329 | 65x52cm m. overloop ceramic+ | wit | 513065R1 | stuk | 211,00 | 053 | 1 |
| 0100331 | 65x52cm m. overloop ceramic+ | starwhite | 513065R2 | stuk | 241,00 | 053 | 1 |
| 0100330 | 65x52cm m. overloop ceramic+ | pergamon | 513065R3 | stuk | 242,00 | 053 | 1 |
| 0100199 | 65x52cm z. overloop | pergamon | 51306609 | stuk | 179,00 | 053 | 1 |
| 0100200 | 65x52cm z. overloop ceramic+ | wit | 513066R1 | stuk | 211,00 | 053 | 1 |
| 0100202 | 65x52cm z. overloop ceramic+ | starwhite | 513066R2 | stuk | 241,00 | 053 | 1 |
| 0100201 | 65x52cm z. overloop ceramic+ | pergamon | 513066R3 | stuk | 242,00 | 053 | 1 |
| 0100400 | 70x56cm m. overloop | wit | 51307001 | stuk | 247,00 | 053 | 1 |
| 0100401 | 70x56cm m. overloop | pergamon | 51307009 | stuk | 296,00 | 053 | 1 |
| 0100402 | 70x56cm m. overloop ceramic+ | wit | 513070R1 | stuk | 310,00 | 053 | 1 |
| 0100404 | 70x56cm m. overloop ceramic+ | starwhite | 513070R2 | stuk | 359,00 | 053 | 1 |
| 0100403 | 70x56cm m. overloop ceramic+ | pergamon | 513070R3 | stuk | 359,00 | 053 | 1 |
| 0100639 | 70x56cm z. overloop | wit | 51307101 | stuk | 247,00 | 053 | 1 |
| 0100640 | 70x56cm z. overloop | pergamon | 51307109 | stuk | 296,00 | 053 | 1 |
| 0100641 | 70x56cm z. overloop ceramic+ | wit | 513071R1 | stuk | 310,00 | 053 | 1 |
| 0100643 | 70x56cm z. overloop ceramic+ | starwhite | 513071R2 | stuk | 359,00 | 053 | 1 |
| 0100642 | 70x56cm z. overloop ceramic+ | pergamon | 513071R3 | stuk | 359,00 | 053 | 1 |

zuil voor wastafel

| | | | | | | | |
|---------|----------|-----------|----------|------|--------|-----|---|
| 0100492 | | wit | 72505501 | stuk | 158,00 | 053 | 1 |
| 0100493 | | pergamon | 72505509 | stuk | 190,00 | 053 | 1 |
| 0100494 | ceramic+ | wit | 725055R1 | stuk | 221,00 | 053 | 1 |
| 0100496 | ceramic+ | starwhite | 725055R2 | stuk | 253,00 | 053 | 1 |
| 0100495 | ceramic+ | pergamon | 725055R3 | stuk | 253,00 | 053 | 1 |

sifonkap voor wastafel

| | | | | | | | |
|---------|----------|-----------|----------|------|--------|-----|---|
| 0100390 | | wit | 72645501 | stuk | 122,00 | 053 | 1 |
| 0100391 | | pergamon | 72645509 | stuk | 146,00 | 053 | 1 |
| 0100392 | ceramic+ | wit | 726455R1 | stuk | 185,00 | 053 | 1 |
| 0100394 | ceramic+ | starwhite | 726455R2 | stuk | 209,00 | 053 | 1 |
| 0100393 | ceramic+ | pergamon | 726455R3 | stuk | 209,00 | 053 | 1 |



Sanitair producten

Baden /
douchebakken /
stoomcabines

Kranen

Douchegarnituur

Accessoires en
spiegels

Douchewanden











Toebehoren &
afvoerenSpoel- &
installatiesystemenBadkamermeubelen
en toiletkastenGootstenen en
wastroggen

Utiliteit

| Art.nr | Specificaties | Kleur | Lev.nr | Ehd | Prijs | Grp | CC |
|--------|---------------|-------|--------|-----|-------|-----|----|
|--------|---------------|-------|--------|-----|-------|-----|----|

Villeroy & Boch Sunberry

opzetwastafel

| | | | | | | | | | | | |
|-------------------------------------|---|---|---|-----------------|----------------------|-----------|----------|------|--------|-----|---|
| Sanitair producten |  | 0100336 55x46cm | m. overloop | wit | 51305G01 | stuk | 175,00 | 053 | 1 | | |
| | | 0100337 55x46cm | m. overloop | pergamon | 51305G09 | stuk | 211,00 | 053 | 1 | | |
| | | 0100338 55x46cm | m. overloop ceramic+ | wit | 51305GR1 | stuk | 238,00 | 053 | 1 | | |
| | | 0100340 55x46cm | m. overloop ceramic+ | starwhite | 51305GR2 | stuk | 274,00 | 053 | 1 | | |
| | | Baden / douchebakken / stoomcabines |  | 0100339 55x46cm | m. overloop ceramic+ | pergamon | 51305GR3 | stuk | 274,00 | 053 | 1 |
| | | | | 0100671 55x46cm | z. overloop | wit | 51303G01 | stuk | 175,00 | 053 | 1 |
| | | | | 0100672 55x46cm | z. overloop | pergamon | 51303G09 | stuk | 211,00 | 053 | 1 |
| | | | | 0100673 55x46cm | z. overloop ceramic+ | wit | 51303GR1 | stuk | 238,00 | 053 | 1 |
| | | Kranen |  | 0100675 55x46cm | z. overloop ceramic+ | starwhite | 51303GR2 | stuk | 274,00 | 053 | 1 |
| | | | | 0100674 55x46cm | z. overloop ceramic+ | pergamon | 51303GR3 | stuk | 274,00 | 053 | 1 |
| 0100676 60x49cm | m. overloop | | | wit | 51301G01 | stuk | 184,00 | 053 | 1 | | |
| 0100677 60x49cm | m. overloop | | | pergamon | 51301G09 | stuk | 222,00 | 053 | 1 | | |
| Douchegarnituur |  | 0100678 60x49cm | m. overloop ceramic+ | wit | 51301GR1 | stuk | 247,00 | 053 | 1 | | |
| | | 0100679 60x49cm | m. overloop ceramic+ | starwhite | 51301GR2 | stuk | 285,00 | 053 | 1 | | |
| | | 0100680 60x49cm | m. overloop ceramic+ | pergamon | 51301GR3 | stuk | 285,00 | 053 | 1 | | |
| | | 0100617 60x49cm | z. overloop | wit | 51308G01 | stuk | 184,00 | 053 | 1 | | |
| Accessoires en spiegels |  | 0100618 60x49cm | z. overloop | pergamon | 51308G09 | stuk | 222,00 | 053 | 1 | | |
| | | 0100619 60x49cm | z. overloop ceramic+ | wit | 51308GR1 | stuk | 247,00 | 053 | 1 | | |
| | | 0100620 60x49cm | z. overloop ceramic+ | starwhite | 51308GR2 | stuk | 285,00 | 053 | 1 | | |
| | | 0100621 60x49cm | z. overloop ceramic+ | pergamon | 51308GR3 | stuk | 285,00 | 053 | 1 | | |
| Douchewanden |  | 0100561 65x52cm | m. overloop | wit | 51306G01 | stuk | 196,00 | 053 | 1 | | |
| | | 0100562 65x52cm | m. overloop | pergamon | 51306G09 | stuk | 236,00 | 053 | 1 | | |
| | | 0100563 65x52cm | m. overloop ceramic+ | wit | 51306GR1 | stuk | 259,00 | 053 | 1 | | |
| | | 0100564 65x52cm | m. overloop ceramic+ | starwhite | 51306GR2 | stuk | 298,00 | 053 | 1 | | |
| | | 0100565 65x52cm | m. overloop ceramic+ | pergamon | 51306GR3 | stuk | 299,00 | 053 | 1 | | |
| | | 0100269 65x52cm | z. overloop | wit | 51304G01 | stuk | 196,00 | 053 | 1 | | |
| Toebehoren & afvoeren |  | 0100270 65x52cm | z. overloop | pergamon | 51304G09 | stuk | 236,00 | 053 | 1 | | |
| | | 0100271 65x52cm | z. overloop ceramic+ | wit | 51304GR1 | stuk | 259,00 | 053 | 1 | | |
| | | 0100272 65x52cm | z. overloop ceramic+ | starwhite | 51304GR2 | stuk | 298,00 | 053 | 1 | | |
| | | 0100273 65x52cm | z. overloop ceramic+ | pergamon | 51304GR3 | stuk | 299,00 | 053 | 1 | | |
| Spoel- & installatiesystemen |  | 0100385 70x56cm | z. overloop | wit | 51309G01 | stuk | 296,00 | 053 | 1 | | |
| | | 0100386 70x56cm | z. overloop | pergamon | 51309G09 | stuk | 357,00 | 053 | 1 | | |
| | | 0100387 70x56cm | z. overloop ceramic+ | wit | 51309GR1 | stuk | 359,00 | 053 | 1 | | |
| | | 0100389 70x56cm | z. overloop ceramic+ | starwhite | 51309GR2 | stuk | 420,00 | 053 | 1 | | |
| | | 0100388 70x56cm | z. overloop ceramic+ | pergamon | 51309GR3 | stuk | 420,00 | 053 | 1 | | |
| Badkamermeubelen en toiletkasten |  | 0100459 70x56cm | m. overloop | wit | 51307G01 | stuk | 296,00 | 053 | 1 | | |
| | | 0100460 70x56cm | m. overloop | pergamon | 51307G09 | stuk | 357,00 | 053 | 1 | | |
| | | 0100461 70x56cm | m. overloop ceramic+ | wit | 51307GR1 | stuk | 359,00 | 053 | 1 | | |
| | | 0100462 70x56cm | m. overloop ceramic+ | starwhite | 51307GR2 | stuk | 420,00 | 053 | 1 | | |
| Gootstenen en wastroggen |  | 0100463 70x56cm | m. overloop ceramic+ | pergamon | 51307GR3 | stuk | 420,00 | 053 | 1 | | |

voorbouwwastafel

| | | | | | | | | | |
|-----------|---|-----------------|----------------------|-----------|----------|------|--------|-----|---|
| Utiliteit |  | 0100421 56x46cm | m. overloop | wit | 51310001 | stuk | 334,00 | 053 | 1 |
| | | 0100422 56x46cm | m. overloop | pergamon | 51310009 | stuk | 403,00 | 053 | 1 |
| | | 0100423 56x46cm | m. overloop ceramic+ | wit | 513100R1 | stuk | 397,00 | 053 | 1 |
| | | 0100425 56x46cm | m. overloop ceramic+ | starwhite | 513100R2 | stuk | 466,00 | 053 | 1 |
| | | 0100424 56x46cm | m. overloop ceramic+ | pergamon | 513100R3 | stuk | 466,00 | 053 | 1 |

opbouwastafel

| | | | | | | | | |
|---|-----------------|----------------------|-----------|----------|------|--------|-----|---|
|  | 0100314 60x49cm | m. overloop | wit | 51326001 | stuk | 298,00 | 053 | 1 |
| | 0100315 60x49cm | m. overloop | pergamon | 51326009 | stuk | 359,00 | 053 | 1 |
| | 0100316 60x49cm | m. overloop ceramic+ | wit | 513260R1 | stuk | 361,00 | 053 | 1 |
| | 0100318 60x49cm | m. overloop ceramic+ | starwhite | 513260R2 | stuk | 422,00 | 053 | 1 |
| | 0100317 60x49cm | m. overloop ceramic+ | pergamon | 513260R3 | stuk | 422,00 | 053 | 1 |

| Art.nr | Specificaties | Kleur | Lev.nr | Ehd | Prijs | Grp | CC |
|---|-----------------|----------------------|-----------|----------|--------|---------|-------|
| Villeroy & Boch Sunberry | | | | | | | |
| fontein | | | | | | | |
| 0100249 | 36x30cm | m. overloop | wit | 53303601 | stuk | 95,00 | 053 1 |
| 0100251 | 36x30cm | m. overloop | pergamon | 53303609 | stuk | 114,00 | 053 1 |
| 0100252 | 36x30cm | m. overloop ceramic+ | wit | 533036R1 | stuk | 158,00 | 053 1 |
| 0100255 | 36x30cm | m. overloop ceramic+ | starwhite | 533036R2 | stuk | 177,00 | 053 1 |
| 0100254 | 36x30cm | m. overloop ceramic+ | pergamon | 533036R3 | stuk | 177,00 | 053 1 |
| 0100300 | 45x38cm | m. overloop | wit | 53304501 | stuk | 97,00 | 053 1 |
| 0100301 | 45x38cm | m. overloop | pergamon | 53304509 | stuk | 118,00 | 053 1 |
| 0100303 | 45x38cm | m. overloop ceramic+ | wit | 533045R1 | stuk | 160,00 | 053 1 |
| 0100307 | 45x38cm | m. overloop ceramic+ | starwhite | 533045R2 | stuk | 181,00 | 053 1 |
| 0100304 | 45x38cm | m. overloop ceramic+ | pergamon | 533045R3 | stuk | 181,00 | 053 1 |
| sifonkap voor fontein | | | | | | | |
| 0100683 | ceramic+ | wit | 724455R1 | stuk | 185,00 | 053 1 | |
| 0100684 | ceramic+ | starwhite | 724455R2 | stuk | 209,00 | 053 1 | |
| 0100682 | | pergamon | 72445509 | stuk | 146,00 | 053 1 | |
| 0100685 | ceramic+ | pergamon | 724455R3 | stuk | 209,00 | 053 1 | |
| opzetfontein | | | | | | | |
| 0100486 | 45x38cm | m. overloop | wit | 53304G01 | stuk | 148,00 | 053 1 |
| 0100487 | 45x38cm | m. overloop | pergamon | 53304G09 | stuk | 179,00 | 053 1 |
| 0100488 | 45x38cm | m. overloop ceramic+ | wit | 53304GR1 | stuk | 211,00 | 053 1 |
| 0100490 | 45x38cm | m. overloop ceramic+ | starwhite | 53304GR2 | stuk | 241,00 | 053 1 |
| 0100489 | 45x38cm | m. overloop ceramic+ | pergamon | 53304GR3 | stuk | 242,00 | 053 1 |
| 0100469 | 45x38cm | z. overloop | wit | 53305G01 | stuk | 148,00 | 053 1 |
| 0100470 | 45x38cm | z. overloop | pergamon | 53305G09 | stuk | 179,00 | 053 1 |
| 0100472 | 45x38cm | z. overloop ceramic+ | wit | 53305GR1 | stuk | 211,00 | 053 1 |
| 0100474 | 45x38cm | z. overloop ceramic+ | starwhite | 53305GR2 | stuk | 304,00 | 053 1 |
| 0100473 | 45x38cm | z. overloop ceramic+ | pergamon | 53305GR3 | stuk | 242,00 | 053 1 |
| stand bidet | | | | | | | |
| 0100368 | | | wit | 54310001 | stuk | 277,00 | 053 1 |
| 0100369 | | | pergamon | 54310009 | stuk | 334,00 | 053 1 |
| 0100370 | m. ceramic+ | | wit | 543100R1 | stuk | 340,00 | 053 1 |
| 0100372 | ceramic+ | | starwhite | 543100R2 | stuk | 397,00 | 053 1 |
| 0100371 | ceramic+ | | pergamon | 543100R3 | stuk | 397,00 | 053 1 |
| wandbidet | | | | | | | |
| 0100629 | | | wit | 54300001 | stuk | 281,00 | 053 1 |
| 0100630 | | | pergamon | 54300009 | stuk | 338,00 | 053 1 |
| 0100631 | ceramic+ | | wit | 543000R1 | stuk | 344,00 | 053 1 |
| 0100633 | ceramic+ | | starwhite | 543000R2 | stuk | 401,00 | 053 1 |
| 0100632 | ceramic+ | | pergamon | 543000R3 | stuk | 401,00 | 053 1 |
| wandclosetpot diepspoel m. closetzitting | | | | | | | |
| 0100634 | PurAir | | wit | 5630N001 | stuk | 713,00 | 053 0 |
| 0100635 | PurAir | | pergamon | 5630N009 | stuk | 787,00 | 053 0 |
| 0100636 | PurAir ceramic+ | | wit | 5630NOR1 | stuk | 776,00 | 053 0 |
| 0100637 | PurAir ceramic+ | | starwhite | 5630NOR2 | stuk | 849,00 | 053 1 |
| 0100638 | PurAir ceramic+ | | pergamon | 5630NOR3 | stuk | 850,00 | 053 1 |
| wandclosetpot vlakspoel m. closetzitting cascade | | | | | | | |
| 0100215 | PurAir | | wit | 5633N001 | stuk | 910,00 | 053 1 |
| 0100216 | PurAir | | pergamon | 5633N009 | stuk | 1024,00 | 053 1 |
| 0100217 | PurAir ceramic+ | | wit | 5633NOR1 | stuk | 973,00 | 053 1 |
| 0100218 | PurAir ceramic+ | | starwhite | 5633NOR2 | stuk | 1087,00 | 053 1 |
| 0100219 | PurAir ceramic+ | | pergamon | 5633NOR3 | stuk | 1087,00 | 053 1 |
| wandclosetpot vlakspoel cascade | | | | | | | |
| 0100624 | | | wit | 56331001 | stuk | 371,00 | 053 1 |
| 0100625 | | | pergamon | 56331009 | stuk | 445,00 | 053 1 |
| 0100626 | ceramic+ | | wit | 563310R1 | stuk | 434,00 | 053 1 |
| 0100628 | ceramic+ | | starwhite | 563310R2 | stuk | 507,00 | 053 1 |
| 0100627 | ceramic+ | | pergamon | 563310R3 | stuk | 508,00 | 053 1 |

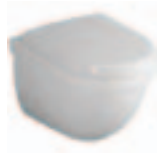

Sanitair producten

Baden /
douchebakken /
stoomcabines

Kranen

Douchegarnituur

Accessoires en
spiegels

Douchewanden

Toebehoren &
afvoerenSpoel- &
installatiesystemenBadkamermeubelen
en toiletkastenGootstenen en
wastroggen

Utiliteit

| | Art.nr | Specificaties | Kleur | Lev.nr | Ehd | Prijs | Grp | CC | |
|---|---|--------------------|-----------|-----------|----------|--------|--------|-----|---|
| Sanitair producten | Villeroy & Boch Sunberry | | | | | | | | |
| | duoblokpot diepspoel z. reservoir | | | | | | | | |
| | | 0100320 | | wit | 56321001 | stuk | 287,00 | 053 | 1 |
| | | 0100321 | | pergamon | 56321009 | stuk | 346,00 | 053 | 1 |
| | | 0100322 | ceramic+ | wit | 563210R1 | stuk | 350,00 | 053 | 1 |
| | | 0100325 | ceramic+ | starwhite | 563210R2 | stuk | 409,00 | 053 | 1 |
| Baden / douchebakken / stoomcabines | | 0100324 | ceramic+ | pergamon | 563210R3 | stuk | 409,00 | 053 | 1 |
| | duoblokreervoir m. binnenwerk | | | | | | | | |
| Kranen | | 0100227 | | wit | 57301101 | stuk | 125,00 | 053 | 1 |
| | | 0100228 | | pergamon | 57301109 | stuk | 127,00 | 053 | 1 |
| | | 0100229 | ceramic+ | wit | 573011R1 | stuk | 188,00 | 053 | 1 |
| | | 0100231 | ceramic+ | starwhite | 573011R2 | stuk | 190,00 | 053 | 1 |
| | | 0100230 | ceramic+ | pergamon | 573011R3 | stuk | 190,00 | 053 | 1 |
| Douchegarnituur | closetzitting | | | | | | | | |
| | | 0100551 | | wit | 9955Q201 | stuk | 154,00 | 053 | 1 |
| | | 0100552 | | pergamon | 9955Q209 | stuk | 171,00 | 053 | 1 |
| Accessoires en spiegels | | 0100553 | | starwhite | 9955Q2R2 | stuk | 171,00 | 053 | 1 |
| | closetzitting m. softclosing | | | | | | | | |
| Douchewanden | | 0100532 | | wit | 9955S201 | stuk | 196,00 | 053 | 1 |
| | | 0100533 | | pergamon | 9955S209 | stuk | 217,00 | 053 | 1 |
| | | 0100534 | | starwhite | 9955S2R2 | stuk | 217,00 | 053 | 1 |
| Toebehoren & afvoeren | onderkast voor opzetwastafel 65cm / 70cm | | | | | | | | |
| | | 0100399 80x40x42cm | | wit/wit | A235AG00 | stuk | 650,00 | 053 | 1 |
| Spoel- & installatiesystemen | | 0100436 80x40x42cm | | eiken/wit | A235CS00 | stuk | 650,00 | 053 | 1 |
| | onderkast voor opzetwastafel 55cm / 60cm | | | | | | | | |
| Badkamermeubelen en toiletkasten | | 0100590 70x40x42cm | | wit/wit | A236AG00 | stuk | 631,00 | 053 | 1 |
| | | 0100554 70x40x42cm | | eiken/wit | A236CS00 | stuk | 631,00 | 053 | 1 |
| Gootstenen en wastroggen | onderkast voor opbouwastafel | | | | | | | | |
| | | 0100477 80x52x55cm | | wit/wit | A237AG00 | stuk | 671,00 | 053 | 1 |
| Utiliteit | | 0100239 80x52x55cm | | eiken/wit | A237CS00 | stuk | 671,00 | 053 | 1 |
| | onderkast voor voorbouwastafel | | | | | | | | |
| | | 0100414 80x52x33cm | | wit/wit | A238AG00 | stuk | 694,00 | 053 | 1 |
| | | 0100359 80x52x33cm | | eiken/wit | A238CS00 | stuk | 694,00 | 053 | 1 |
| | onderkast voor opzetfontein | | | | | | | | |
| | | 0100515 50x40x33cm | | wit/wit | A239AG00 | stuk | 555,00 | 053 | 1 |
| | 0100491 50x40x33cm | | eiken/wit | A239CS00 | stuk | 555,00 | 053 | 1 | |

| Art.nr | Specificaties | Kleur | Lev.nr | Ehd | Prijs | Grp | CC |
|--------|---------------|-------|--------|-----|-------|-----|----|
|--------|---------------|-------|--------|-----|-------|-----|----|

Villeroy & Boch Sunberry

spiegel

| | | | | | | | |
|---------|---------|--|-------|----------|------|--------|-------|
| 0100223 | 54x91cm | | wit | A240AG00 | stuk | 532,00 | 053 1 |
| 0100653 | 54x91cm | | eiken | A240CS00 | stuk | 532,00 | 053 1 |
| 0100479 | 40x91cm | | wit | A241AG00 | stuk | 418,00 | 053 1 |
| 0100517 | 40x91cm | | eiken | A241CS00 | stuk | 418,00 | 053 1 |



Sanitair producten

Baden /
douchebakken /
stoomcabines

Kranen

Douchegarnituur

Accessoires en
spiegels

Douchewanden

Toebehoren &
afvoerenSpoel- &
installatiesystemenBadkamermeubelen
en toiletkastenGootstenen en
wastroggen

Utiliteit

zijkast

| | | | | | | | |
|---------|-------------|--------|-----------|----------|------|--------|-------|
| 0100262 | 35x110x35cm | rechts | wit/wit | A243AG00 | stuk | 595,00 | 053 1 |
| 0100485 | 35x110x35cm | rechts | eiken/wit | A243CS00 | stuk | 595,00 | 053 1 |
| 0100458 | 35x110x35cm | links | wit/wit | A244AG00 | stuk | 595,00 | 053 1 |
| 0100457 | 35x110x35cm | links | eiken/wit | A244CS00 | stuk | 595,00 | 053 1 |



hoge kast

| | | | | | | | |
|---------|-------------|--------|-----------|----------|------|--------|-------|
| 0100415 | 35x166x35cm | rechts | wit/wit | A245AG00 | stuk | 665,00 | 053 1 |
| 0100376 | 35x166x35cm | rechts | eiken/wit | A245CS00 | stuk | 665,00 | 053 1 |
| 0100687 | 35x166x35cm | links | wit/wit | A246AG00 | stuk | 665,00 | 053 1 |
| 0100434 | 35x166x35cm | links | eiken/wit | A246CS00 | stuk | 665,00 | 053 1 |



Villeroy & Boch Sunny

wastafel

| | | | | | | | |
|---------|---------------------------|----------|----------|----------|------|--------|-------|
| 0120517 | 60x50cm | | wit | 71466001 | stuk | 213,00 | 052 1 |
| 0121320 | 60x50cm | | pergamon | 71466009 | stuk | 257,00 | 052 1 |
| 0120534 | 60x50cm | ceramic+ | wit | 714660R1 | stuk | 276,00 | 052 1 |
| 0120531 | 60x50cm | ceramic+ | pergamon | 714660R3 | stuk | 320,00 | 052 1 |
| 0120521 | 65x52cm | | wit | 71466501 | stuk | 260,00 | 052 1 |
| 0120533 | 65x52cm | | pergamon | 71466509 | stuk | 314,00 | 052 1 |
| 0140432 | 65x52cm | ceramic+ | wit | 714665R1 | stuk | 323,00 | 052 1 |
| 0101489 | 65x52cm | ceramic+ | pergamon | 714665R3 | stuk | 377,00 | 052 1 |
| 0121304 | 70x55cm | | wit | 71467001 | stuk | 315,00 | 052 1 |
| 0121312 | 70x55cm | | pergamon | 71467009 | stuk | 380,00 | 052 1 |
| 0107735 | 70x55cm | ceramic+ | wit | 714670R1 | stuk | 378,00 | 052 1 |
| 0107743 | 70x55cm | ceramic+ | pergamon | 714670R3 | stuk | 443,00 | 052 1 |
| 0830097 | bevestigingsset M10x110mm | | | 0830097 | paar | 1,09 | 362 0 |



sifonkap voor wastafel

| | | | | | | | |
|---------|--|--|----------|----------|------|--------|-------|
| 0120508 | | | wit | 72470001 | stuk | 165,00 | 052 0 |
| 0120530 | | | pergamon | 72470009 | stuk | 200,00 | 052 1 |

zuil voor wastafel

| | | | | | | | |
|---------|--|--|----------|----------|------|--------|-------|
| 0121339 | | | wit | 72460001 | stuk | 213,00 | 052 1 |
| 0121347 | | | pergamon | 72460009 | stuk | 257,00 | 052 1 |







fontein











| | | | | | | | |
|---------|--------------------------------------|----------|----------|----------|------|--------|-------|
| 0120514 | 50x39cm | | wit | 73465001 | stuk | 177,00 | 052 1 |
| 0120523 | 50x39cm | | pergamon | 73465009 | stuk | 213,00 | 052 1 |
| 0107751 | 50x39cm | ceramic+ | wit | 734650R1 | stuk | 240,00 | 052 1 |
| 0120605 | 50x39cm | ceramic+ | pergamon | 734650R3 | stuk | 276,00 | 052 1 |
| 0830240 | bevestigingsset voor fontein M8x90mm | | | 0830240 | stuk | 0,85 | 362 0 |

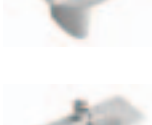

sifonkap voor fontein

| | | | | | | | |
|---------|--|--|----------|----------|------|--------|-------|
| 0120519 | | | wit | 72450001 | stuk | 165,00 | 052 1 |
| 0120532 | | | pergamon | 72450009 | stuk | 200,00 | 052 1 |

| | Art.nr | Specificaties | Kleur | Lev.nr | Ehd | Prijs | Grp | CC | | |
|---|---|---------------|---|---------------------------|----------|----------|--------|--------|-----|---|
| Villeroy & Boch Sunny | | | | | | | | | | |
| Sanitair producten | planchet | | | | | | | | | |
| |  | 0121398 | 50x18cm | wit | 78465001 | stuk | 89,00 | 052 | 1 | |
| | | 0120604 | 50x18cm | pergamon | 78465009 | stuk | 108,00 | 052 | 1 | |
| | | 0120505 | 60x19cm | wit | 78466001 | stuk | 108,00 | 052 | 1 | |
| | | 0121371 | 60x19cm | pergamon | 78466009 | stuk | 131,00 | 052 | 1 | |
| | Baden / douchebakken / stoomcabines | | 0121355 | 70x20cm | wit | 78467001 | stuk | 152,00 | 052 | 1 |
| | | | 0121363 | 70x20cm | pergamon | 78467009 | stuk | 182,00 | 052 | 1 |
| | | | 0830453 | set potschroeven 5.5x60mm | chroom | 0830453 | stuk | 2,28 | 362 | 0 |
| Kranen | staand bidet | | | | | | | | | |
| |  | 0121436 | | wit | 74470001 | stuk | 353,00 | 052 | 1 | |
| | | 0121444 | | pergamon | 74470009 | stuk | 426,00 | 052 | 1 | |
| | | 0107786 | ceramic+ | wit | 744700R1 | stuk | 416,00 | 052 | 1 | |
| | | 0107794 | ceramic+ | pergamon | 744700R3 | stuk | 489,00 | 052 | 1 | |
| Douchegarnituur | | 0112798 | montageset voor staand bidet voor montage tegen de wand | | 92083100 | stuk | 86,00 | 052 | 1 | |
| Accessoires en spiegels | wandbidet | | | | | | | | | |
| |  | 0121401 | | wit | 74460001 | stuk | 376,00 | 052 | 1 | |
| | | 0121428 | | pergamon | 74460009 | stuk | 452,00 | 052 | 1 | |
| | | 0107808 | ceramic+ | wit | 744600R1 | stuk | 439,00 | 052 | 1 | |
| | | 0107816 | ceramic+ | pergamon | 744600R3 | stuk | 515,00 | 052 | 1 | |
| Douchewanden | wandclosetpot diepspoel | | | | | | | | | |
| |  | 0106008 | | wit | 66461001 | stuk | 329,00 | 052 | 1 | |
| | | 0121452 | | pergamon | 66461009 | stuk | 395,00 | 052 | 1 | |
| | Toebehoren & afvoeren | | 0120600 | ceramic+ | wit | 664610R1 | stuk | 392,00 | 052 | 1 |
| | | 0120603 | ceramic+ | pergamon | 664610R3 | stuk | 458,00 | 052 | 1 | |
| Spoel- & installatiesystemen | closetzitting dubbel | | | | | | | | | |
| | | 0120522 | | wit | 88416101 | stuk | 148,00 | 052 | 1 | |
| | | 0120528 | | pergamon | 88416109 | stuk | 163,00 | 052 | 1 | |
| Badkamermeubelen en toiletkasten | duoblokpot universeel z. reservoir | | | | | | | | | |
| | | 0121495 | | wit | 66491001 | stuk | 401,00 | 052 | 1 | |
| | | 0121509 | | pergamon | 66491009 | stuk | 483,00 | 052 | 1 | |
| | | 0107867 | ceramic+ | wit | 664910R1 | stuk | 464,00 | 052 | 1 | |
| | | 0107875 | ceramic+ | pergamon | 664910R3 | stuk | 546,00 | 052 | 1 | |
| Gootstenen en wastroggen | duoblokreservoir + binnenwerk | | | | | | | | | |
| | | 0121517 | | wit | 77481101 | stuk | 266,00 | 052 | 1 | |
| | | 0121525 | | pergamon | 77481109 | stuk | 296,00 | 052 | 1 | |
| Utiliteit | closetcombinatie universeel | | | | | | | | | |
| |  | 0113689 | | wit | SUNNY | stuk | 667,00 | 052 | 1 | |
| | | 0113697 | | pergamon | SUNNY | stuk | 779,00 | 052 | 1 | |
| | | 0113700 | ceramic+ | wit | SUNNY | stuk | 730,00 | 052 | 1 | |
| | | 0113719 | ceramic+ | pergamon | SUNNY | stuk | 842,00 | 052 | 1 | |
| | | 0102221 | vario afvoerbocht verticaal | 160-250mm | 87010000 | stuk | 68,00 | 052 | 0 | |
| | | 0102225 | vario afvoerbocht verticaal | 70-160mm | 87110000 | stuk | 68,00 | 052 | 1 | |
| Villeroy & Boch Transimage | spiegelkast m. verlichting 50x75x13.5cm | | | | | | | | | |
|  | 0100122 | | | 97601L00 | stuk | 1953,00 | 323 | 1 | | |
| Villeroy & Boch Viala | closetcombinatie diepspoel AO | | | | | | | | | |
| |  | 0103268 | | wit | P0103268 | stuk | 551,00 | 052 | 1 | |
| | | 0112496 | | pergamon | P0112496 | stuk | 662,00 | 052 | 1 | |
| | | 0109134 | ceramic+ | wit | P0109134 | stuk | 612,00 | 052 | 1 | |
| | | 0109142 | ceramic+ | pergamon | P0109142 | stuk | 723,00 | 052 | 1 | |
| | | 0103276 | | wit | P0103276 | stuk | 546,00 | 052 | 1 | |
| | 0112534 | | pergamon | P0112534 | stuk | 657,00 | 052 | 1 | | |
| | 0109150 | ceramic+ | wit | P0109150 | stuk | 607,00 | 052 | 1 | | |
| | 0109169 | ceramic+ | pergamon | P0109169 | stuk | 717,00 | 052 | 1 | | |

| Art.nr | Specificaties | Kleur | Lev.nr | Ehd | Prijs | Grp | CC | | | | | | |
|-------------------------------|----------------------------------|----------|----------|------|---------|-----|----|---|-------------------------------------|---|---|---|--------------------------|
| | | | | | | | | Villeroy & Boch Virage | | | | | |
| wastafel | | | | | | | | | | | | | |
| 0120315 | 80x55cm | wit | 61060001 | stuk | 574,00 | 053 | 1 |  | Sanitair producten | | | | |
| 0120319 | 80x55cm | pergamon | 61060009 | stuk | 690,00 | 052 | 1 | | | | | | |
| 0121800 | 80x55cm ceramic+ | wit | 610600R1 | stuk | 637,00 | 053 | 1 | | | | | | |
| 0121819 | 80x55cm ceramic+ | pergamon | 610600R3 | stuk | 753,00 | 053 | 1 | | | | | | |
| 0120469 | 100x55cm | wit | 61050001 | stuk | 661,00 | 053 | 1 | | | | | | |
| 0120465 | 100x55cm | pergamon | 61050009 | stuk | 794,00 | 052 | 1 | | | | | | |
| 0120463 | 100x55cm ceramic+ | wit | 610500R1 | stuk | 724,00 | 053 | 1 | | | | | | |
| 0120471 | 100x55cm ceramic+ | pergamon | 610500R3 | stuk | 857,00 | 053 | 1 | | | | | | |
| 0830097 | bevestigingsset M10x110mm | | 0830097 | paar | 1,09 | 362 | 0 | | |  | Baden / douchebakken / stoomcabines | | |
| meubelwastafel | | | | | | | | | | | | | |
| 0120320 | 155x55cm | wit | 61030001 | stuk | 1058,00 | 053 | 1 |  | Kranen | | | | |
| 0121827 | 155x55cm | pergamon | 61030009 | stuk | 1271,00 | 053 | 1 | | | | | | |
| 0121835 | 155x55cm ceramic+ | wit | 610300R1 | stuk | 1121,00 | 053 | 1 | | | | | | |
| 0121843 | 155x55cm ceramic+ | pergamon | 610300R3 | stuk | 1334,00 | 053 | 1 | | | | | | |
| 0830097 | bevestigingsset M10x110mm | | 0830097 | paar | 1,09 | 362 | 0 | | | | |  | Douchegarnituur |
| wastafel dubbel | | | | | | | | | | | | | |
| 0132640 | 2 zijdig gesneden | wit | 61040301 | stuk | 1328,00 | 053 | 1 |  | Accessoires en spiegels | | | | |
| 0132659 | 2 zijdig gesneden | pergamon | 61040309 | stuk | 1560,00 | 053 | 1 | | | | | | |
| 0120017 | 2 zijdig gesneden ceramic + | wit | 610403R1 | stuk | 1391,00 | 053 | 1 | | | | | | |
| 0120446 | 142.5x55cm links gesneden | wit | 61040101 | stuk | 1265,00 | 052 | 1 | | | | | | |
| 0132683 | 142.5x55cm links gesneden | pergamon | 61040109 | stuk | 1497,00 | 053 | 1 | | | | | | |
| 0120467 | 155x55cm | wit | 61040001 | stuk | 1157,00 | 052 | 1 | | | | | | |
| 0120466 | 155x55cm | pergamon | 61040009 | stuk | 1389,00 | 052 | 1 | | | | | | |
| 0131662 | 155x55cm ceramic+ | wit | 610400R1 | stuk | 1220,00 | 053 | 1 | | | | | | |
| 0121851 | 155x55cm ceramic+ | pergamon | 610400R3 | stuk | 1452,00 | 053 | 1 | | | | | | |
| 0830097 | bevestigingsset M10x110mm | | 0830097 | paar | 1,09 | 362 | 0 | | | | | | |
| 0830453 | set potschroeven 5.5x60mm chroom | | 0830453 | stuk | 2,28 | 362 | 0 | | |  | Douchewanden | | |
| sifonkap voor wastafel | | | | | | | | | | | | | |
| 0130323 | | wit | 72540001 | stuk | 251,00 | 053 | 1 | | | | |  | Toebehoren & afvoeren |
| 0130319 | | pergamon | 72540009 | stuk | 302,00 | 052 | 1 | | | | | | |
| | | | | | | | | | | Villeroy & Boch Velvet | | | |
| meubelwastafel | | | | | | | | | | | | | |
| 0132058 | 65x45cm | wit | 71926501 | stuk | 412,00 | 052 | 1 |  | Badkamermeubelen en toiletkasten | | | | |
| 0105686 | 65x45cm ceramic+ | wit | 719265R1 | stuk | 475,00 | 052 | 1 | | | | | | |
| 0120447 | 80x53cm | wit | 71928001 | stuk | 494,00 | 052 | 1 | | | | | | |
| 0100903 | 80x53cm ceramic+ | wit | 719280R1 | stuk | 557,00 | 052 | 1 | | | | | | |
| 0105619 | 100x55cm | wit | 71921001 | stuk | 616,00 | 052 | 1 | | | | | | |
| 0105627 | 100x55cm ceramic+ | wit | 719210R1 | stuk | 679,00 | 052 | 1 | | | | | | |
| 0830097 | bevestigingsset M10x110mm | | 0830097 | paar | 1,09 | 362 | 0 | | |  | Gootstenen en wastroggen | | |
| meubelwastafel dubbel | | | | | | | | | | | | | |
| 0132057 | 130x55cm | wit | 71911301 | stuk | 895,00 | 052 | 1 | | | | |  | Utiliteit |
| 0132056 | 130x55cm ceramic+ | wit | 719113R1 | stuk | 958,00 | 052 | 1 | | | | | | |
| 0830097 | bevestigingsset M10x110mm | | 0830097 | paar | 1,09 | 362 | 0 | | | | | | |

| | Art.nr | Specificaties | Kleur | Lev.nr | Ehd | Prijs | Grp | CC | | |
|-------------------------------------|---|---------------|--------------------------------------|----------------------------|----------|----------|----------|--------|--------|-----|
| Sanitair producten | Villeroy & Boch Evana | | | | | | | | | |
| | onderbouw wastafel | | | | | | | | | |
| | | 0105309 | 38x26cm | wit | 61473801 | stuk | 165,00 | 053 | 1 | |
| | | 0105317 | 38x26cm | pergamon | 61473809 | stuk | 200,00 | 053 | 1 | |
| | | 0105287 | 38x26cm ceramic+ | wit | 614738R1 | stuk | 228,00 | 053 | 1 | |
| | | 0105295 | 38x26cm ceramic+ | pergamon | 614738R3 | stuk | 263,00 | 053 | 1 | |
| | Baden / douchebakken / stoomcabines | | 0105260 | 46x31cm | wit | 61474601 | stuk | 182,00 | 053 | 1 |
| | | | 0105279 | 46x31cm | pergamon | 61474609 | stuk | 220,00 | 053 | 1 |
| | | | 0105244 | 46x31cm ceramic+ | wit | 614746R1 | stuk | 245,00 | 053 | 1 |
| | | | 0105252 | 46x31cm ceramic+ | pergamon | 614746R3 | stuk | 283,00 | 053 | 1 |
| | | Kranen | | 0120316 | 50x35cm | wit | 61470001 | stuk | 194,00 | 053 |
| | | | 0131563 | 50x35cm | pergamon | 61470009 | stuk | 234,00 | 053 | 0 |
| | | | 0101173 | 50x35cm ceramic+ | wit | 614700R1 | stuk | 257,00 | 053 | 1 |
| | | | 0105414 | 50x35cm ceramic+ | pergamon | 614700R3 | stuk | 297,00 | 053 | 1 |
| | Douchegarnituur | | | 0100181 | 61x41cm | wit | 61440001 | stuk | 319,00 | 053 |
| | | | 0105392 | 61x41cm | pergamon | 61440009 | stuk | 384,00 | 053 | 1 |
| | | | 0105570 | 61x41cm ceramic+ | wit | 614400R1 | stuk | 382,00 | 053 | 1 |
| | | 0105376 | 61x41cm ceramic+ | pergamon | 614400R3 | stuk | 447,00 | 053 | 1 | |
| Accessoires en spiegels | Villeroy & Boch Florine | | | | | | | | | |
| | inbouw wastafel | | | | | | | | | |
| | | 0120251 | 56x44cm | wit | 61490001 | stuk | 262,00 | 053 | 1 | |
| | | 0130443 | 56x44cm | pergamon | 61490009 | stuk | 315,00 | 053 | 1 | |
| | Douchewanden | | 0108235 | 56x44cm ceramic+ | wit | 614900R1 | stuk | 325,00 | 053 | 1 |
| | | | 0108243 | 56x44cm ceramic+ | pergamon | 614900R3 | stuk | 378,00 | 053 | 1 |
| | | | 0120278 | 64x52cm | wit | 61480001 | stuk | 306,00 | 053 | 1 |
| | | | 0130451 | 64x52cm | pergamon | 61480009 | stuk | 369,00 | 053 | 1 |
| | | | 0108251 | 64x52cm ceramic+ | wit | 614800R1 | stuk | 369,00 | 053 | 1 |
| | Toebehoren & afvoeren | | 0108278 | 64x52cm ceramic+ | pergamon | 614800R3 | stuk | 432,00 | 053 | 1 |
| Villeroy & Boch Lonina | | | | | | | | | | |
| fontein | | | | | | | | | | |
| Spoel- & installatiesystemen | | 0121118 | 36x29cm | wit | 73353601 | stuk | 93,00 | 053 | 0 | |
| | | 0130052 | 36x29cm | pergamon | 73353609 | stuk | 112,00 | 053 | 1 | |
| | | 0136971 | 36x29cm ceramic+ | wit | 733536R1 | stuk | 156,00 | 053 | 1 | |
| | | 0120766 | 45x34cm | wit | 73354501 | stuk | 133,00 | 053 | 1 | |
| | | 0130273 | 45x34cm | pergamon | 73354509 | stuk | 160,00 | 053 | 1 | |
| | | 0121096 | 50x35cm | wit | 73355001 | stuk | 165,00 | 053 | 1 | |
| Badkamermeubelen en toiletkasten | | 0137055 | 50x35cm | pergamon | 73355009 | stuk | 200,00 | 053 | 1 | |
| | | 0830240 | bevestigingsset voor fontein M8x90mm | | 0830240 | stuk | 0,85 | 362 | 0 | |
| Gootstenen en wastroggen | Villeroy & Boch Loop | | | | | | | | | |
| | opzetwastafel | | | | | | | | | |
| | | 0108286 | Ø38cm z. overloop | wit | 71813801 | stuk | 306,00 | 052 | 1 | |
| | | 0105345 | 38cm z. overloop | pergamon | 71813809 | stuk | 361,00 | 052 | 1 | |
| | | 0105562 | Ø38cm z. overloop ceramic+ | wit | 718138R1 | stuk | 369,00 | 052 | 1 | |
| | Utiliteit | | 0108294 | Ø38cm m. overloop | wit | 71803801 | stuk | 274,00 | 052 | 1 |
| | | | 0105344 | 38cm m. overloop | pergamon | 71803809 | stuk | 329,00 | 052 | 1 |
| | | | 0105341 | Ø38cm m. overloop ceramic+ | wit | 718038R1 | stuk | 337,00 | 052 | 1 |
| | | | 0108308 | Ø43cm z. overloop | wit | 71814301 | stuk | 314,00 | 052 | 1 |
| | | | 0105333 | Ø43cm z. overloop ceramic+ | wit | 718143R1 | stuk | 377,00 | 052 | 1 |
| | | | 0108316 | Ø43cm m. overloop | wit | 71804301 | stuk | 281,00 | 052 | 0 |
| | | | 0105342 | 43cm m. overloop | pergamon | 71804309 | stuk | 338,00 | 052 | 1 |
| | | | 0105325 | Ø43cm m. overloop ceramic+ | wit | 718043R1 | stuk | 344,00 | 052 | 0 |

| Art.nr | Specificaties | Kleur | Lev.nr | Ehd | Prijs | Grp | CC |
|---------------------------------|----------------------------|----------|----------|------|--------|-----|----|
| Villeroy & Boch Loop | | | | | | | |
| inbouw wastafel | | | | | | | |
| 0108324 | Ø34cm z. overloop | wit | 61413401 | stuk | 200,00 | 052 | 1 |
| 0105546 | Ø34cm z. overloop ceramic+ | wit | 614134R1 | stuk | 263,00 | 052 | 1 |
| 0105353 | 33cm z. overloop | pergamon | 61413409 | stuk | 234,00 | 052 | 1 |
| 0108332 | Ø34cm m. overloop | wit | 61403401 | stuk | 167,00 | 052 | 1 |
| 0105338 | Ø34cm m. overloop ceramic+ | wit | 614034R1 | stuk | 230,00 | 052 | 1 |
| 0105352 | 33cm m. overloop | pergamon | 61403409 | stuk | 201,00 | 052 | 1 |
| 0108340 | Ø39cm z. overloop | wit | 61413901 | stuk | 220,00 | 052 | 1 |
| 0105503 | Ø39cm z. overloop ceramic+ | wit | 614139R1 | stuk | 283,00 | 052 | 1 |
| 0105351 | 39cm z. overloop | pergamon | 61413909 | stuk | 258,00 | 052 | 1 |
| 0108359 | Ø39cm m. overloop | wit | 61403901 | stuk | 188,00 | 052 | 0 |
| 0105481 | Ø39cm m. overloop ceramic+ | wit | 614039R1 | stuk | 251,00 | 052 | 1 |
| 0105350 | 39cm m. overloop | pergamon | 61403909 | stuk | 226,00 | 052 | 1 |
| 0108367 | Ø45cm z. overloop | wit | 61414501 | stuk | 239,00 | 052 | 1 |
| 0105473 | Ø45cm z. overloop ceramic+ | wit | 614145R1 | stuk | 302,00 | 052 | 1 |
| 0105349 | 45cm z. overloop | pergamon | 61414509 | stuk | 281,00 | 052 | 1 |
| 0108375 | Ø45cm m. overloop | wit | 61404501 | stuk | 207,00 | 052 | 1 |
| 0105465 | Ø45cm m. overloop ceramic+ | wit | 614045R1 | stuk | 270,00 | 052 | 1 |
| 0105348 | 45cm m. overloop | pergamon | 61404509 | stuk | 249,00 | 052 | 1 |
| 0108383 | Ø51cm z. overloop | wit | 61415101 | stuk | 260,00 | 052 | 1 |
| 0105347 | 51cm z. overloop | pergamon | 61415109 | stuk | 306,00 | 052 | 1 |
| 0105457 | Ø51cm z. overloop ceramic+ | wit | 614151R1 | stuk | 323,00 | 052 | 1 |
| 0108391 | Ø51cm m. overloop | wit | 61405101 | stuk | 228,00 | 052 | 1 |
| 0105346 | 51cm m. overloop | pergamon | 61405109 | stuk | 274,00 | 052 | 1 |
| 0105449 | Ø51cm m. overloop ceramic+ | wit | 614051R1 | stuk | 291,00 | 052 | 1 |



Sanitair producten

Baden /
douchebakken /
stoomcabines

Kranen

Douchegarnituur

Accessoires en
spiegels

Douchewanden

| | | | | | | | |
|-------------------------------------|-------------|------------|----------|------|---------|-----|---|
| Villeroy & Boch Universo | | | | | | | |
| wastafelonderbouw | | | | | | | |
| 0172073 | 125x70x40cm | beuken/wit | 958700F3 | stuk | 1298,00 | 323 | 1 |

Toebehoren &
afvoeren

| | | | | | | | |
|--|--|-----|----------|------|---------|-----|---|
| onderkast voor dubbele wastafel | | | | | | | |
| 0104614 | | wit | 937600F3 | stuk | 1697,00 | 323 | 1 |

Spoel- &
installatiesystemen

| | | | | | | | |
|--------------------------|------------|------------|----------|------|--------|-----|---|
| wastafelonderbouw | | | | | | | |
| 0100902 | 75x70x40cm | beuken/wit | 958900F3 | stuk | 811,00 | 323 | 1 |

Badkamermeubelen
en toiletkastenGootstenen en
wastroggen







| | | | | | | | |
|--------------------------------------|----------|----------|------------|------|--------|-----|---|
| Villeroy & Boch Targa | | | | | | | |
| Targa wandclosetpot diepspoel | | | | | | | |
| 0121738 | | wit | 76231001 | stuk | 155,00 | 053 | 0 |
| 0121739 | | pergamon | 76231009 | stuk | 186,00 | 053 | 0 |
| 0123080 | ceramic+ | wit | 76231001R1 | stuk | 223,00 | 053 | 0 |
| 0123099 | ceramic+ | pergamon | 76231009R3 | stuk | 254,00 | 053 | 0 |







Utiliteit

| | | | | | | | |
|---------------------------------------|--|--|----------|------|-------|-----|---|
| Villeroy & Boch Toebehoren | | | | | | | |
| 0190617 | bevestigingsset voor reservoir op pot | | 99190000 | stuk | 13,00 | 053 | 1 |
| 1023664 | Purair elektrische voeding 100-240V 4meter | | 92194001 | stuk | 36,00 | 052 | 1 |
| 1023665 | Purair inbouw netvoeding 100-240V 2meter | | 92194501 | stuk | 44,00 | 052 | 1 |
| 1023666 | Purair wisselfilter | | 92193001 | stuk | 29,00 | 052 | 1 |

Packs, complete sets in doos

| | Art.nr | Specificaties | Kleur | Lev.nr | Ehd | Prijs | Grp | CC |
|---|---|---|-------|--------|-----|---------------------------|--------|-----|
| Sanitair producten | Duravit packs | | | | | | | |
| |  | wastafelset compleet 4970050 0 | | wit | | WASTAFELPACK COMPLEET WIT | 169,00 | 004 |
| Baden / douchebakken / stoomcabines | | fonteinset compleet 4970052 0 | | wit | | Fonteinpack compleet wit | 89,50 | 004 |
| Kranen |  | | | | | | | |
| Douchegarnituur | WC-pack m. keramisch reservoir | | | | | | | |
| |  | 4970054 0 | AO | | wit | WC PACK AO COMPLEET WIT | 226,00 | 004 |
| Accessoires en spiegels | | 4970056 0 | PK | | wit | WC PACK PK COMPLEET WIT | 226,00 | 004 |
| | | | | | | | | |
| Douchewanden | Sphinx packs | | | | | | | |
| |  | wastafelset compleet 4970030 0 | | wit | | WASTAFELSET COMPLEET WIT | 160,00 | 004 |
| Toebehoren & afvoeren | | fonteinset compleet 4970032 0 | | wit | | Fonteinset compleet wit | 79,50 | 004 |
| Spoel- & installatiesystemen |  | | | | | | | |
| Badkamermeubelen en toiletkasten | WC-pack m. keramisch reservoir | | | | | | | |
| |  | 4970034 0 | AO | | wit | WC-PACK AO M.KERAM. RESER | 195,00 | 004 |
| Gootstenen en wastroggen | | 4970036 0 | PK | | wit | WC-PACK PK M.KERAM. RESER | 183,00 | 004 |
| Utiliteit | | | | | | | | |

| Art.nr | Specificaties | Kleur | Lev.nr | Ehd | Prijs | Grp | CC | | |
|---|---------------|-----------|-------------|------|--------|-----|----|---|---|
| | | | | | | | | Alape inbouwwaskommen EB | |
| EW3 inbouw wastafel geglazuurd staal | | | | | | | | | |
| 0930814 | 47.5cm | wit | 2005000000 | stuk | 93,50 | 359 | 0 |  | Sanitair producten |
| 0930032 | 47.5cm | pergamon | 2005000130 | stuk | 93,50 | 359 | 1 | | |
| 0930822 | 47.5cm | manhattan | 2005000105 | stuk | 93,50 | 359 | 1 | | |
| EB/S450H inbouw wastafel geglazuurd staal | | | | | | | | | |
| 0930156 | 45cm | wit | 2406000000 | stuk | 182,00 | 359 | 1 |  | Baden / douchebakken / stoomcabines |
| 0930164 | 45cm | pergamon | 2406000130 | stuk | 182,00 | 359 | 1 | | |
| EB/K400H inbouw wastafel geglazuurd staal | | | | | | | | | |
| 0930115 | 40cm | wit | 2003000000 | stuk | 182,00 | 359 | 1 |  | Kranen |
| 0930117 | 40cm | pergamon | 2003000130 | stuk | 182,00 | 359 | 1 | | |
| 0930171 | 40cm | edelweiss | 20030000010 | stuk | 363,00 | 359 | 1 | | |
| EB/K400 inbouw wastafel geglazuurd staal | | | | | | | | | |
| 0930105 | 40cm | wit | 2001000000 | stuk | 169,00 | 359 | 0 |  | Douchegarnituur |
| | | | | | | | | | |
| EB/K325 inbouw wastafel geglazuurd staal z. kraangat | | | | | | | | | |
| 0930113 | 32.5cm | wit | 2000000000 | stuk | 169,00 | 359 | 1 |  | Accessoires en spiegels |
| 0930114 | 32.5cm | pergamon | 2000000130 | stuk | 169,00 | 359 | 1 | | |
| EB/K450 inbouw wastafel geglazuurd staal z. kraangat | | | | | | | | | |
| 0930107 | 45cm | wit | 2002000000 | stuk | 169,00 | 359 | 1 |  | Douchewanden |
| | | | | | | | | | |
| EB/0600H inbouw wastafel geglazuurd staal | | | | | | | | | |
| 0930036 | 60x50cm | wit | 2104000000 | stuk | 225,00 | 359 | 1 |  | Toebehoren & afvoeren |
| | | | | | | | | | |
| EB/0500H inbouw wastafel geglazuurd staal | | | | | | | | | |
| 0930079 | 50x40cm | wit | 2102000000 | stuk | 195,00 | 359 | 1 |  | Spoel- & installatiesystemen |
| 0930166 | 50x40cm | pergamon | 2102000130 | stuk | 195,00 | 359 | 1 | | |
| EB/0425 inbouw wastafel geglazuurd staal z. kraangat | | | | | | | | | |
| 0930091 | 42.5x32.5cm | wit | 2100000000 | stuk | 169,00 | 359 | 1 |  | Badkamermeubelen en toiletkasten |
| | | | | | | | | | |
| EB/0425 inbouw wastafel geglazuurd staal z. kraangat | | | | | | | | | |
| | | | | | | | | Gootstenen en wastroggen | |
| | | | | | | | | | |
| EB/0600H inbouw wastafel geglazuurd staal | | | | | | | | | |
| | | | | | | | | Utiliteit | |
| | | | | | | | | | |



Shaping space is de expressie van onze pretentie producten en een assortiment volgens de eisen van een creatieve ruimtelijke vormgeving te ontwikkelen. Als ontwerpers en producenten van individuele badkamerarchitectuur ondersteunen wij het creatieve werk van de architectonische vormgeving.

Agent voor Alape in Nederland

Burgmans Agenturen bv Hoofdweg 92 NL-2908 LC Capelle aan den IJssel





Tel +31(0)10.4508451 Fax +31(0)10.4588670 E-Mail info@burgmans.nl www.burgmans.nl

www.alape.com

shaping space **Alape**^U

| Art.nr | Specificaties | Kleur | Lev.nr | Ehd | Prijs | Grp | CC |
|--------|---------------|-------|--------|-----|-------|-----|----|
|--------|---------------|-------|--------|-----|-------|-----|----|

Alape inbouwwaskommen ED

| | | | | | | | |
|--|-----|------------|------|--------|-----|---|---|
| ED/K450 inbouwwasstafel binnen-/buitenzijde gepolijst 0930170 45cm | RVS | 2062000921 | stuk | 374,00 | 359 | 1 |  |
| ED/K400 inbouwwasstafel binnen-/buitenzijde gepolijst 0930169 40cm | RVS | 2063000921 | stuk | 374,00 | 359 | 1 |  |
| ED/K325 inbouwwasstafel binnen-/buitenzijde gepolijst 0930175 32,5cm | RVS | 2064000921 | stuk | 374,00 | 359 | 1 |  |
| ED/S450H inbouwwasstafel binnen-/buitenzijde gepolijst 0930173 45cm | RVS | 2060000921 | stuk | 335,00 | 359 | 1 |  |
| 0930181 45cm geborsteld | RVS | 2060000922 | stuk | 261,00 | 359 | 1 | |

Alape opbouwwaskommen SB

| | | | | | | | |
|---|-----------|------------|------|--------|-----|---|---|
| SB/450GS opbouwkom binnen/buiten geglazuurd 0930482 45cm | staal wit | 3502000000 | stuk | 369,00 | 359 | 1 |  |
| SB/K450ED opbouwkom binnen / buiten geborsteld 0930490 45cm | RVS | 3502000922 | stuk | 475,00 | 359 | 1 | |
| SB/450GM opbouwkom veiligheidsglas 0930474 45cm | matglas | 3502000840 | stuk | 631,00 | 359 | 1 | |

Alape Toebehoren

| | | | | | | |
|---|--|------------|------|--------|-----|---|
| 0934684 VT1 afvoerplug m. stuwfunctie chroom | | 8302000978 | stuk | 59,00 | 359 | 0 |
| 0934685 VT2 afvoerplug kap 63mm chroom | | 8304000978 | stuk | 40,00 | 359 | 0 |
| 0934686 VT3 afvoerplug kap 73mm chroom | | 8305000978 | stuk | 43,75 | 359 | 1 |
| 0934687 SV1 sifonkap 36cm wit | | 8105000000 | stuk | 76,50 | 359 | 1 |
| 0934692 SV1 sifonkap 36cm RVS | | 8105000922 | stuk | 100,00 | 359 | 1 |
| 0934689 SV1 sifonkap 36cm chroom | | 8105000978 | stuk | 100,00 | 359 | 1 |
| 0934693 SV2 sifonkap 33cm wit | | 8106000000 | stuk | 150,00 | 359 | 1 |
| 0934694 SV3 sifonkap 33cm wit | | 8107000000 | stuk | 172,00 | 359 | 1 |
| 0930231 design overlooprozet chroom | | 8303000978 | stuk | 11,25 | 359 | 1 |
| 0930230 overloopset type-1 | | 950005 | stuk | 11,75 | 359 | 0 |
| 0930051 onderlegging | | 950300 | stuk | 4,09 | 359 | 1 |
| 0930055 dichtingsprofiel voor inbouwwasstafel | | 950500 | m2 | 1,24 | 359 | 1 |

Alape wastafels WT

| | | | | | | | |
|--|-----|------------|------|---------|-----|---|---|
| WT.RL800H wastafel vlak m. kraangat m. bevestiging 0930022 80x49,5cm | wit | 4251000000 | stuk | 1014,00 | 359 | 1 |  |
| 0930023 80x49,5cm m. Clean | wit | 4251000400 | stuk | 1073,00 | 359 | 1 | |

Sanitair producten

Baden /
douchebakken /
stoomcabines

Kranen

Douchegarnituur

Accessoires en
spiegels

Douchewanden

Toebehoren &
afvoeren

Spoel- &
installatiesystemen

Badkamermeubelen
en toiletkasten

Gootstenen en
wastroggen

Utiliteit

| | Art.nr | Specificaties | Kleur | Lev.nr | Ehd | Prijs | Grp | CC |
|---|---|--------------------------------|-------|------------|------|---------|-----|----|
| Sanitair producten | Alape wastafels WT | | | | | | | |
| | WT.RL800H wastafel vlak z. kraangat m. bevestiging | | | | | | | |
| | 0930024 | 80x49.5cm | wit | 4250000000 | stuk | 1014,00 | 359 | 1 |
| | 0930025 | 80x49.5cm m. Clean | wit | 4250000400 | stuk | 1073,00 | 359 | 1 |
| Baden / douchebakken / stoomcabines |  | | | | | | | |
| Kranen | WT/RS450H wastafel rond m. kraangat m. bevestiging | | | | | | | |
| | 0934695 | 45cm | wit | 5053000000 | stuk | 581,00 | 359 | 1 |
| Douchegarnituur |  | | | | | | | |
| Accessoires en spiegels | WT/RS400H wastafel rond m. kraangat m. bevestiging | | | | | | | |
| | 0934696 | 40cm | wit | 5051000000 | stuk | 507,00 | 359 | 1 |
| | 0934685 | VT2 afvoerplug kap 63mm chroom | | 8304000978 | stuk | 40,00 | 359 | 0 |
| Douchewanden | WT/RS450 wastafel rond z. kraangat m. bevestiging | | | | | | | |
| | 0934697 | 45cm | wit | 5054000000 | stuk | 581,00 | 359 | 1 |
| |  | | | | | | | |
| Toebehoren & afvoeren | WT/RS400 wastafel rond z. kraangat m. bevestiging | | | | | | | |
| | 0934698 | 40cm | wit | 5052000000 | stuk | 507,00 | 359 | 1 |
| Spoel- & installatiesystemen | WT/RS325 wastafel rond z. kraangat m. bevestiging | | | | | | | |
| | 0934699 | 32.5cm | wit | 5041000000 | stuk | 574,00 | 359 | 1 |
| |  | | | | | | | |
| Badkamermeubelen en toiletkasten | WT.RX400KH wastafelset 40cm m. bevestigingset | | | | | | | |
| | 0934779 | | wit | 4500000000 | stuk | 1071,00 | 359 | 1 |
| |  | | | | | | | |
| Gootstenen en wastroggen | WT.RX325K wastafelset 32.5cm m. bevestigingset | | | | | | | |
| | 0934780 | | wit | 4501000000 | stuk | 960,00 | 359 | 1 |
| |  | | | | | | | |
| Utiliteit | WT.RX325Q wastafelset 32.5x32.5cm m. bevestigingset | | | | | | | |
| | 0934781 | | wit | 4800000000 | stuk | 1102,00 | 359 | 1 |
| |  | | | | | | | |
| | WT/IC325H wastafel vierkant m. kraangat m. bevestiging | | | | | | | |
| | 0934700 | 32.5cm | wit | 4236000000 | stuk | 400,00 | 359 | 1 |
| |  | | | | | | | |

| Art.nr | Specificaties | Kleur | Lev.nr | Ehd | Prijs | Grp | CC |
|---|---------------|-------|------------|------|--------|-----|----|
| Alape wastafels WT | | | | | | | |
| WT/IC600H wastafel m. kraangat m. bevestiging 0934702 60x32.5cm | | wit | 4238000000 | stuk | 438,00 | 359 | 1 |
| WT/IC600HL wastafel links m. kraangat m. bevestiging 0934703 60x32.5cm | | wit | 4239000000 | stuk | 456,00 | 359 | 1 |
| WT/IC600HR wastafel rechts m. kraangat m. bevestiging 0934706 60x32.5cm | | wit | 4240000000 | stuk | 456,00 | 359 | 1 |
| WT/IC800HL wastafel links m. kraangat m. bevestiging 0934707 80x32.5cm | | wit | 4241000000 | stuk | 494,00 | 359 | 1 |
| WT/IC800HR wastafel rechts m. kraangat m. bevestiging 0934708 80x32.5cm | | wit | 4242000000 | stuk | 494,00 | 359 | 1 |
| WT/MC450H wastafel vierkant m. kraangat m. bevestiging 0934709 45cm | | wit | 4228000000 | stuk | 438,00 | 359 | 1 |
| WT/MC800H wastafel m. kraangat m. bevestiging 0934710 80x45cm | | wit | 4230000000 | stuk | 500,00 | 359 | 1 |
| WT/MC800HL wastafel links m. kraangat m. bevestiging 0934711 80x45cm | | wit | 4231000000 | stuk | 531,00 | 359 | 1 |
| WT/MC800HR wastafel rechts m. kraangat m. bevestiging 0934714 80x45cm | | wit | 4232000000 | stuk | 531,00 | 359 | 1 |

Sanitair producten

Baden /
douchebakken /
stoomcabines

Kranen











Douchegarnituur

Accessoires en
spiegels

Douchewanden

Toebehoren &
afvoerenSpoel- &
installatiesystemenBadkamermeubelen
en toiletkastenGootstenen en
wastroggen

Utiliteit

| | Art.nr | Specificaties | Kleur | Lev.nr | Ehd | Prijs | Grp | CC |
|---|---|---|-------|------------|------|--------|-----|----|
| Sanitair producten | Alape wastafels WT | | | | | | | |
| |  | WT/SC525H wastafel vierkant m. kraangat m. bevestiging 0934715 52.5cm | wit | 4216000000 | stuk | 463,00 | 359 | 1 |
| Baden / douchebakken / stoomcabines |  | WT/SC1000H wastafel m. kraangat m. bevestiging 0934716 100x52.5cm | wit | 4218000000 | stuk | 592,00 | 359 | 1 |
| Kranen |  | WT/SC1000HL wastafel links m. kraangat m. bevestiging 0934717 100x52.5cm | wit | 4220000000 | stuk | 592,00 | 359 | 1 |
| Douchegarnituur |  | WT/SC1000HR wastafel rechts m. kraangat m. bevestiging 0934718 100x52.5cm | wit | 4222000000 | stuk | 592,00 | 359 | 1 |
| Accessoires en spiegels |  | WT/PR585H wastafel m. kraangat m. bevestiging 0934719 58.5x40.5cm | wit | 4201000000 | stuk | 338,00 | 359 | 0 |
| Toebehoren & afvoeren |  | WT/PR585 wastafel z. kraangat m. bevestiging 0934722 58.5x34.7cm | wit | 4200000000 | stuk | 325,00 | 359 | 0 |
| Badkamermeubelen en toiletkasten |  | WT/PR800H wastafel m. kraangat m. bevestiging 0934723 80x40.5cm | wit | 4203000000 | stuk | 525,00 | 359 | 1 |
| Gootstenen en wastroggen |  | WT/PR800HL wastafel links m. kraangat m. bevestiging 0934724 80x40.5cm | wit | 4205000000 | stuk | 525,00 | 359 | 1 |
| Utiliteit |  | WT/PR800HR wastafel rechts m. kraangat m. bevestiging 0934725 80x40.5cm | wit | 4207000000 | stuk | 525,00 | 359 | 1 |
| |  | WT/PR1000H wastafel m. kraangat m. bevestiging 0934726 100x40.5cm | wit | 4209000000 | stuk | 550,00 | 359 | 1 |

| Art.nr | Specificaties | Kleur | Lev.nr | Ehd | Prijs | Grp | CC | | |
|---|---------------|-----------|------------|------|---------|-----|----|---|---|
| | | | | | | | | Alape wastafels WT | |
| WT/FY800H wastafel m. kraangat m. bevestiging 0934727 80x46.4cm | | wit | 4211000000 | stuk | 652,00 | 359 | 1 |  | Sanitair producten |
| | | | | | | | | Alape wastafelmeubelen WP | |
| WT/FY1000H wastafel m. kraangat m. bevestiging 0934728 100x46.4cm | | wit | 4213000000 | stuk | 719,00 | 359 | 1 |  | Baden / douchebakken / stoomcabines |
| WP/PI1 wastafelmeubel links m. kraangat m. bevestiging 0934735 | | wit | 5031000000 | stuk | 601,00 | 359 | 1 |  | Kranen |
| WP/PI2 wastafelmeubel rechts m. kraangat m. bevestiging 0934736 | | wit | 5032000000 | stuk | 601,00 | 359 | 1 |  | Douchegarnituur |
| WP/PI3 wastafelmeubel links z. kraangat m. bevestiging 0934737 | | wit | 5033000000 | stuk | 601,00 | 359 | 1 |  | Accessoires en spiegels |
| WP/PI4 wastafelmeubel rechts z. kraangat m. bevestiging 0934738 | | wit | 5034000000 | stuk | 601,00 | 359 | 1 |  | Douchewanden |
| WP.MW600 wastafelmeubel 59.5x49cm 0934782 | | wit | 5100000000 | stuk | 596,00 | 359 | 1 | | Toebehoren & afvoeren |
| WP.MW800 wastafelmeubel 81x49cm 0934783 | | wit | 5102000000 | stuk | 689,00 | 359 | 0 | | Spoel- & installatiesystemen |
| WP.MW1000 wastafelmeubel 100x49cm 0934784 | | wit | 5103000000 | stuk | 805,00 | 359 | 1 | | Badkamermeubelen en toiletkasten |
| WP.MW1200 wastafelmeubel 120x49cm 0934785 m. dubbele bak | | wit | 5104000000 | stuk | 1013,00 | 359 | 1 | | Gootstenen en wastroggen |
| | | | | | | | | Alape spiegelkasten/spiegels | |
| SPS.FS500 spiegelkast m. verlichting 50x87.8cm 0934758 | | aluminium | 6410520709 | stuk | 1187,00 | 359 | 1 |  | Utiliteit |

| | Art.nr | Specificaties | Kleur | Lev.nr | Ehd | Prijs | Grp | CC |
|---|---|--|------------------|------------|------|---------|-----|----|
| Sanitair producten | Alape spiegelkasten/spiegels | | | | | | | |
| |  | SPS.FS1000 spiegelkast m. verlichting m. planchet 50x87.8cm | | | | | | |
| 0934759 | | | | 6411520709 | stuk | 1237,00 | 359 | 1 |
| Baden / douchebakken / stoomcabines | | | | | | | | |
| Kranen | SPS.MW600 spiegelkast 60cm m. verlichting | | | | | | | |
| | 0934787 | | aluminium | 6401520509 | stuk | 747,00 | 359 | 1 |
| Douchegarnituur | SPS.MW800 spiegelkast 80cm m. verlichting | | | | | | | |
| | 0934788 | | aluminium | 6402520509 | stuk | 886,00 | 359 | 1 |
| Accessoires en spiegels | SPS.MW1000 spiegelkast 100cm m. verlichting | | | | | | | |
| | 0934789 | | aluminium | 6403520509 | stuk | 990,00 | 359 | 1 |
| Douchewanden | SPS.MW1200 spiegelkast 120cm m. verlichting | | | | | | | |
| | 0934790 | | aluminium | 6404520509 | stuk | 1175,00 | 359 | 1 |
| Toebehoren & afvoeren | SP.FS340.2 spiegel m. verlichting 34x86cm | | | | | | | |
| | 0934757 | | aluminium | 6711000899 | stuk | 413,00 | 359 | 1 |
| Spoel- & installatiesystemen | SP.FS340.1 spiegel m. verlichting 34x86cm | | | | | | | |
| | 0934754 | | aluminium | 6710000899 | stuk | 413,00 | 359 | 1 |
| Badkamermeubelen en toiletkasten | SP.FS580 spiegel m. verlichting 58.5x72.8cm | | | | | | | |
| | 0930571 | | aluminium/zilver | 6712000899 | stuk | 425,00 | 359 | 1 |
| Gootstenen en wastroggen | SP.FS790 spiegel m. verlichting 79x72.8cm | | | | | | | |
| | 0934756 | | aluminium | 6713000899 | stuk | 438,00 | 359 | 1 |
| Utiliteit | SP.FS990 spiegel m. verlichting 99x72.8cm | | | | | | | |
| | 0930512 | | aluminium/zilver | 6714000899 | stuk | 488,00 | 359 | 1 |
| | SP.FS1190 spiegel m. verlichting 119x72.8cm | | | | | | | |
| | 0934786 | | aluminium | 6715000899 | stuk | 525,00 | 359 | 1 |
| | Alape metalen meubelen | | | | | | | |
| | HS.MW1560.L hoge kast links | | | | | | | |
| | 0934794 | | wit/wit | 6320960000 | stuk | 494,00 | 359 | 1 |
| | HS.MW1560.R hoge kast rechts | | | | | | | |
| | 0934793 | | wit/wit | 6320660000 | stuk | 494,00 | 359 | 1 |
| | MS.MW750.L middenkast links 35x75cm | | | | | | | |
| | 0934792 | | wit/wit | 6220960000 | stuk | 315,00 | 359 | 1 |
| | MS.MW750.R middenkast rechts 35x75cm | | | | | | | |
| | 0934791 | | wit/wit | 6220660000 | stuk | 315,00 | 359 | 1 |

| Art.nr | Specificaties | Kleur | Lev.nr | Ehd | Prijs | Grp | CC | | |
|---|---------------|--------|--------|------|---------|-----|----|---|---|
| | | | | | | | | Dimensie Apokalypse | |
| fontein losse kom 0740152 25cm | | RVS | F25 | stuk | 177,00 | 369 | 1 |  | Sanitair producten |
| achterwand m. spiegel 0740160 110cm | | RVS | M28 | stuk | 341,00 | 369 | 1 |  | Baden / douchebakken / stoomcabines |
| achterwand m. spiegel m. kraangat 0744025 110cm | | RVS | M28P | stuk | 359,00 | 369 | 1 |  | Kranen |
| fontein m. console z. kraangat 0740187 28x26.5cm | | RVS | S28P | stuk | 568,00 | 369 | 1 |  | Douchegarnituur |
| fontein m. console m. kraangat 0740179 28x33.5cm | | RVS | S28 | stuk | 568,00 | 369 | 1 |  | Accessoires en spiegels |
| 0740330 plugbuissifon m. muurbuis m. rozet 5/4" chroom | | | 404 | stuk | 32,00 | 369 | 1 | | Toebehoren & afvoeren |
| fontein m. spiegelcombinatie m. bevestiging 0740210 | | RVS | SM28 | stuk | 909,00 | 369 | 1 |  | Spoel- & installatiesystemen |
| fontein m. hoekconsole m. kraangat 0740209 31x31cm | | RVS | C028 | stuk | 658,00 | 369 | 1 |  | Badkamermeubelen en toiletkasten |
| | | | | | | | | Dimensie Thema | |
| wastafel in glasplaat 0740217 | | RVS | R068 | stuk | 1271,00 | 369 | 1 |  | Gootstenen en wastroggen |
| | | | | | | | | Dimensie Frattini | |
| buissifon m. muurbuis m. rozet 0740004 5/4" | | chroom | 401.02 | stuk | 25,00 | 369 | 1 |  | Utiliteit |
| plugbuissifon m. muurbuis m. rozet 0740330 5/4" | | chroom | 404 | stuk | 32,00 | 369 | 1 | | |

| | Art.nr | Specificaties | Kleur | Lev.nr | Ehd | Prijs | Grp | CC |
|---|----------------------------|--|-------|--------|------|-------|-----|----|
| Sanitair producten | Dimensione Frattini | | | | | | | |
| | 0740025 | losse simplexplug m. stop 5/4" | | 400S | stuk | 7,00 | 369 | 1 |
| Baden / douchebakken / stoomcabines | 0740009 | waste-inrichting m. handbediening | chrom | 400W | stuk | 40,00 | 369 | 1 |
| Kranen | | | | | | | | |
| Douchegarnituur | | | | | | | | |
| Accessoires en spiegels | | | | | | | | |
| Douchewanden | | | | | | | | |
| Toebehoren & afvoeren | | | | | | | | |
| Spoel- & installatiesystemen | | | | | | | | |
| Badkamermeubelen en toiletkasten | | | | | | | | |
| Gootstenen en wastroggen | | | | | | | | |
| Utiliteit | | | | | | | | |

| Art.nr | Specificaties | Kleur | Lev.nr | Ehd | Prijs | Grp | CC | | |
|---|---------------|----------|---------|------|--------|-----|----|---|---|
| | | | | | | | | Plieger inbouw wastafels | |
| plaatstaal inbouw wastafel ovaal | | | | | | | | | |
| 0970166 | 51x46cm | wit | 0970166 | stuk | 57,50 | 062 | 0 |  | Sanitair producten |
| 0970468 | 51x46cm | pergamon | 0970468 | stuk | 64,00 | 062 | 0 | | |
| plaatstaal inbouw wastafel rond | | | | | | | | | |
| 0970001 | Ø49cm | wit | 0970001 | stuk | 52,50 | 062 | 0 |  | Baden / douchebakken / stoomcabines |
| 0970003 | Ø49cm | grijs | 0970003 | stuk | 59,00 | 062 | 1 | | |
| plug voor inbouw wastafel m. bevestigingsset | | | | | | | | | |
| 0970239 | | | 0970239 | stuk | 6,60 | 062 | 0 | | Kranen |
| | | | | | | | | Plieger Bergamo | |
| opbouw wastafel | | | | | | | | | |
| 4338254 | 37.5cm | RVS | 4338254 | stuk | 136,00 | 359 | 0 |  | Douchegarnituur |
| | | | | | | | | Plieger Boule | |
| keramische waskom inbouw/opbouw | | | | | | | | | |
| 4338232 | 25x h16cm | wit | 4338232 | stuk | 70,00 | 002 | 0 |  | Accessoires en spiegels |
| 4338234 | 30xh16cm | wit | 4338234 | stuk | 77,50 | 002 | 0 | | |
| 4338236 | 40xh17.5cm | wit | 4338236 | stuk | 105,00 | 002 | 0 | | |
| keramische waskom inbouw/opbouw | | | | | | | | | |
| 4338250 | 41cm | wit | 4338250 | stuk | 84,00 | 359 | 0 |  | Douchewanden |
| | | | | | | | | Plieger Cati | |
| keramische waskom inbouw/opbouw | | | | | | | | | |
| 4338250 | 41cm | wit | 4338250 | stuk | 84,00 | 359 | 0 |  | Toebehoren & afvoeren |
| | | | | | | | | Plieger Cono | |
| keramische waskom opbouw z. overloop | | | | | | | | | |
| 4338246 | 42cm | wit | 4338246 | stuk | 84,00 | 359 | 0 |  | Spoel- & installatiesystemen |
| | | | | | | | | Plieger Cucina | |
| keramische gootsteen | | | | | | | | | |
| 0278000 | 60x45x18cm | wit | 0278000 | stuk | 164,00 | 002 | 0 |  | Badkamermeubelen en toiletkasten |
| | | | | | | | | Plieger Gina | |
| keramische wandfontein m. planchet | | | | | | | | | |
| 4338238 | 41x40cm | wit | 4338238 | stuk | 114,00 | 002 | 0 |  | Gootstenen en wastroggen |
| | | | | | | | | Plieger Imola | |
| dubbele wastafel massief hout m. RVS kom z. sifonkap | | | | | | | | | |
| 4339540 | | | 4339540 | stuk | 251,00 | 298 | 0 |  | Utiliteit |
| | | | | | | | | Plieger Locarno | |
| inbouwfontein m. chromen plug z. overloop | | | | | | | | | |
| 4339502 | 28cm | matglas | 4339502 | stuk | 45,50 | 359 | 0 |  | |

| | Art.nr | Specificaties | Kleur | Lev.nr | Ehd | Prijs | Grp | CC |
|---|---|--|---------|---------|-------|--------|-----|----|
| Sanitair producten | Plieger Locarno | | | | | | | |
| | | inbouw wastafel m. chromen plug z. overloop | | | | | | |
| |  | 4339504 33cm | matglas | 4339504 | stuk | 48,00 | 359 | 0 |
| | 4339506 41cm | matglas | 4339506 | stuk | 57,00 | 359 | 0 | |
| Baden / douchebakken / stoomcabines | Plieger Lugano | | | | | | | |
| Kranen |  | fonteinset m. keramische waskom m. sifon m. muurbuis m. simplexplug | | | | | | |
| | | 4338224 41cm. | | 4338224 | stuk | 179,00 | 298 | 0 |
| Douchegarnituur | Plieger Luna | | | | | | | |
| Accessoires en spiegels |  | keramische waskom opbouw m. overloop | | | | | | |
| | | 4338242 40,5cm | wit | 4338242 | stuk | 84,00 | 359 | 0 |
| Douchewanden | Plieger Rimini | | | | | | | |
| Toebehoren & afvoeren |  | inbouw wastafel RVS gepolijst m. afvoerplug | | | | | | |
| | | 4339508 32cm | | 4339508 | stuk | 73,00 | 359 | 0 |
| | | 4339510 41cm | | 4339510 | stuk | 109,00 | 359 | 0 |
| Spool- & installatiesystemen |  | wastafelmeubel massief hout | | | | | | |
| Badkamermeubelen en toiletkasten | | 4338200 | kersen | 4338200 | stuk | 191,64 | 298 | 0 |
| | | 4338001 | noten | 4338001 | stuk | 191,64 | 298 | 0 |
| Gootstenen en wastroggen | Plieger Savona | | | | | | | |
| Utiliteit |  | sifonkap gepolijst | | | | | | |
| | | 4339512 | RVS | 4339512 | stuk | 36,25 | 359 | 0 |
| | Plieger Square | | | | | | | |
| |  | opbouw wastafel m. gloeing | | | | | | |
| | | 4324138 50x45x15cm | wit | 4324138 | stuk | 213,00 | 009 | 0 |
| | Plieger Teorema | | | | | | | |
| |  | keramische fontein | | | | | | |
| | | 4338270 30x30cm. | wit | 4338270 | stuk | 123,00 | 002 | 0 |
| |  | keramische wastafel | | | | | | |
| | | 4338268 46x46cm. | wit | 4338268 | stuk | 198,00 | 002 | 0 |

| Art.nr | Specificaties | Kleur | Lev.nr | Ehd | Prijs | Grp | CC |
|--|---------------|--------------|---------|------|--------|-----|----|
| Plieger Teorema | | | | | | | |
| keramische wastafel dubbel 4338266 | 105x46cm. | wit | 4338266 | stuk | 368,00 | 002 | 0 |
| Plieger Trento | | | | | | | |
| hoekfonteinset m. RVS kom 4339514 | | noten | 4339514 | stuk | 117,00 | 298 | 1 |
| 4339519 | | white-washed | 4339519 | stuk | 117,00 | 298 | 1 |
| Plieger Tuli | | | | | | | |
| keramische opbouw waskom m. kraangat m. overloop 4338244 | 37cm | wit | 4338244 | stuk | 84,00 | 359 | 0 |
| Plieger Verona | | | | | | | |
| RVS wastafelset m. muurbeugel 42cm en sifon 4339513 | | | 4339513 | stuk | 143,00 | 298 | 0 |
| RVS hoekfonteinset 32cm m. muurbeugel m. sifon 4339511 | | | 4339511 | stuk | 198,00 | 298 | 0 |
| Plieger Vicenza | | | | | | | |
| wastafelmeubel kersen m. opbouwkom keramisch 4338205 | 65cm | wit | 4338205 | stuk | 288,00 | 298 | 0 |



Sanitair producten

Baden /
douchebakken /
stoomcabines

Kranen









Douchegarnituur



Accessoires en
spiegels

Douchewanden

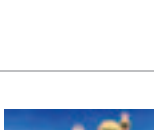
Toebehoren &
afvoerenSpoel- &
installatiesystemenBadkamermeubelen
en toiletkastenGootstenen en
wastroggen

Utiliteit

| | Art.nr | Specificaties | Kleur | Lev.nr | Ehd | Prijs | Grp | CC | |
|---|---|--|---------------------|--------|-------|--------|--------|-----|---|
| Sanitair producten | Imar inbouw wastafels | | | | | | | | |
| |  | opbouw wastafel z. kraangat | | | | | | | |
| 0740012 | | 33cm m. overloop | RVS | 500ST | stuk | 170,00 | 369 | 1 | |
| Baden / douchebakken / stoomcabines | inbouw wastafel z. kraangat | | | | | | | | |
| | 0740074 | 33cm integratie | RVS | 500VF | stuk | 170,00 | 369 | 1 | |
| Kranen | opbouw/onderbouw wastafel z. kraangat | | | | | | | | |
| | 0740190 | 33cm | RVS | 500SP | stuk | 170,00 | 369 | 1 | |
| Douchegarnituur |  | opbouw wastafel z. kraangat | | | | | | | |
| | | 0740063 | 38cm m. overloop | RVS | 510ST | stuk | 180,00 | 369 | 1 |
| Accessoires en spiegels |  | opbouw/onderbouw wastafel z. kraangat | | | | | | | |
| | | 0740047 | 38cm m. overloop | RVS | 510VF | stuk | 180,00 | 369 | 1 |
| | | 0740039 | 38cm m. overloop | RVS | 510SP | stuk | 180,00 | 369 | 1 |
| | | 0740098 | 43.5cm m. overloop | RVS | 520VF | stuk | 195,00 | 369 | 1 |
| Douchewanden | opbouw wastafel z. kraangat | | | | | | | | |
| | 0740136 | 50x38cm m. overloop | RVS | 531ST | stuk | 215,00 | 369 | 1 | |
| Toebehoren & afvoeren |  | opbouw/onderbouw wastafel z. kraangat | | | | | | | |
| | | 0740128 | 50x38cm m. overloop | RVS | 531SP | stuk | 215,00 | 369 | 1 |
| Spoel- & installatiesystemen |  | 0740130 | 50x38cm | RVS | 531VF | stuk | 215,00 | 369 | 1 |
| | | opbouw wastafel m. kraangat | | | | | | | |
| Badkamermeubelen en toiletkasten |  | 0740055 | 48cm m. overloop | RVS | 541ST | stuk | 225,00 | 369 | 1 |
| | | opbouw/onderbouw wastafel m. kraangat | | | | | | | |
| Gootstenen en wastroggen |  | 0740332 | 48cm | RVS | 541SP | stuk | 225,00 | 369 | 1 |
| | | opbouw wastafel m. kraangat | | | | | | | |
| Utiliteit |  | 0740101 | 53x45cm m. overloop | RVS | 530ST | stuk | 225,00 | 369 | 1 |
| | | opbouw/onderbouw wastafel m. kraangat | | | | | | | |
| | | 0740331 | 53x45cm | RVS | 530SP | stuk | 225,00 | 369 | 1 |
| | | inbouw wastafel in- en uitwendig geëmailleerd | | | | | | | |
|  | 0740144 | 43.5cm z. kraangat m. overloop | wit | 420SP | stuk | 125,00 | 369 | 1 | |
| | 0740148 | 53x45.5cm m. kraangat | wit | 430SP | stuk | 150,00 | 369 | 1 | |
| | 0740149 | 50.5x38.5cm z. kraangat in- en uitwendig | wit | 431SP | stuk | 145,00 | 369 | 1 | |

| Art.nr | Specificaties | Kleur | Lev.nr | Ehd | Prijs | Grp | CC | |
|--|---------------|----------------|--------|------|--------|-----|----|---|
| | | | | | | | | Trento fonteinbakjes |
| fonteinkom keramisch 27cm | | | | | | | | |
| 0740184 | | wit | 2703 | stuk | 225,00 | 369 | 1 |  |
| 0740003 | | terra | 2709 | stuk | 225,00 | 369 | 1 | |
| <hr/> | | | | | | | | |
| RVS frame m. kraangat | | | | | | | | |
| 0740146 | | mat geborsteld | T27 | stuk | 266,00 | 369 | 1 | |
| <hr/> | | | | | | | | |
| RVS frame z. kraangat | | | | | | | | |
| 0743250 | | mat geborsteld | T27K | stuk | 257,00 | 369 | 1 |  |
| <hr/> | | | | | | | | |
| RVS frame hoekmodel m. kraangat | | | | | | | | |
| 0740145 | | mat geborsteld | T27H | stuk | 280,00 | 369 | 1 |  |

Sanitair producten

Baden /
douchebakken /
stoomcabines

Kranen

Douchegarnituur

Accessoires en
spiegels

Douchewanden

Toebehoren &
afvoerenSpoel- &
installatiesystemenBadkamermeubelen
en toiletkastenGootstenen en
wastroggen

Utiliteit

Sanitair producten

Baden /
douchebakken /
stoomcabines

Kranen

Douchegarnituur

Accessoires en
spiegels

Douchewanden

Toebehoren &
afvoeren

Spoel- &
installatiesystemen

Badkamermeubelen
en toiletkasten

Gootstenen en
wastroggen

Utiliteit

Baden / douchebakken / stoomcabines

| | |
|--|-----|
| Plaatstaal baden Bette | 250 |
| Plaatstaal douchebakken Bette | 256 |
| Plaatstaal baden Kaldewei | 259 |
| Plaatstaal douchebakken Kaldewei | 268 |
| Plaatstaal baden Plieger | 275 |
| Plaatstaal douchebakken Plieger | 276 |
| Kunststof baden Duravit | 277 |
| Kunststof douchebakken Duravit | 281 |
| Kunststof baden Duscholux | 285 |
| Kunststof douchebakken Duscholux | 289 |
| Kunststof baden Hoesch | 291 |
| Kunststof douchebakken Hoesch | 300 |
| Kunststof douchebakken Huppe | 302 |
| Kunststof baden /douchebakken JOOP! | 304 |
| Kunststof baden Laufen | 305 |
| Kunststof douchebakken Novellini | 306 |
| Kunststof baden Plieger Design | 307 |
| Kunststof baden Plieger Exclusief | 309 |
| Whirlpoolsystemen Plieger Exclusief | 311 |
| Kunststof douchebakken Plieger Design | 312 |
| Kunststof douchebakken Plieger Exclusief | 313 |
| Kunststof baden Riho | 315 |
| Whirlpoolsystemen Riho | 321 |
| Kunststof douchebakken Riho | 322 |
| Kunststof baden Sphinx | 325 |
| Kunststof douchebakken Sphinx | 328 |
| Kunststof baden Ucosan | 330 |
| Whirlpoolsystemen Ucosan | 333 |
| Kunststof douchebakken Ucosan | 334 |
| Kunststof baden Villeroy & Boch | 336 |
| Whirlpoolsystemen Villeroy & Boch | 343 |
| Kunststof douchebakken Villeroy & Boch | 344 |
| Multifunctionele douches Duravit | 348 |
| Stoomcabines Hoesch | 349 |
| Douche-/Stoomcabines Huppe | 351 |
| Douchecabines Intersan | 352 |
| Stoomcabines Riho | 353 |
| Stoomcabines Sphinx | 354 |
| Douche-/Stoomcabines Ucosan | 355 |
| Stoomcabines Villeroy & Boch | 356 |

Baden / douchebakken /
stoomcabines

| | Art.nr | Specificaties | Kleur | Lev.nr | Ehd | Prijs | Grp | CC |
|---|--|---|--------------|-------------------------|--------|---------|-----|----|
| Sanitair producten | BetteForm Nova | | | | | | | |
| | bad plaatstaal dunwandig rechthoekig z. poten | | | | | | | |
| | 0340979 | 170x75cm | wit | 1010000 | stuk | 156,00 | 082 | 0 |
| | 0354228 | 170x75cm | pergamon | 1010001 | stuk | 266,00 | 082 | 1 |
| | 0354317 | 170x75cm | manhattan | 1010002 | stuk | 266,00 | 082 | 1 |
| | 0340995 | badpoten per set voor 1010-1240-1700-301034/35/36-3710-38/3 | | B231500 | stuk | 28,00 | 082 | 0 |
| Baden / douchebakken / stoomcabines | bad plaatstaal dikwandig rechthoekig z. poten | | | | | | | |
| | 0340987 | 170x75cm | wit | 3010000 | stuk | 189,00 | 082 | 0 |
| | 0354236 | 170x75cm | pergamon | 3010001 | stuk | 290,00 | 082 | 0 |
| | 0354376 | 170x75cm | manhattan | 3010002 | stuk | 290,00 | 082 | 1 |
| | 0350001 | 170x75cm | sunrise | 3010295 | stuk | 490,00 | 082 | 1 |
| Kranen | 0340995 | badpoten per set voor 1010-1240-1700-301034/35/36-3710-38/3 | | B231500 | stuk | 28,00 | 082 | 0 |
| Douchegarnituur | Bette Form | | | | | | | |
| | bad plaatstaal dunwandig rechthoekig z. poten | | | | | | | |
| | 0349999 | 150x70cm | wit | 1500000 | stuk | 203,00 | 082 | 1 |
| | 0340595 | 170x70cm | wit | 1970000 | stuk | 156,00 | 082 | 1 |
| | 0341096 | 170x73cm | wit | 1700000 | stuk | 163,00 | 082 | 1 |
| | 0340995 | badpoten per set voor 1010-1240-1700-301034/35/36-3710-38/3 | | B231500 | stuk | 28,00 | 082 | 0 |
| Accessoires en spiegels | bad plaatstaal dunwandig rechthoekig m. poten | | | | | | | |
| | 0340596 | 170x73cm | wit | 1700000+B231500 | stuk | 191,00 | 082 | 1 |
| Douchewanden | bad plaatstaal dikwandig rechthoekig z. poten | | | | | | | |
| | 0348342 | 160x75cm | wit | 3620000 | stuk | 199,00 | 082 | 1 |
| | 0342041 | 160x75cm | pergamon | 3620001 | stuk | 306,00 | 082 | 1 |
| | 0341460 | 170x75cm | wit | 3710000 | stuk | 193,00 | 082 | 0 |
| | 0360185 | 175x75cm | wit | 3450000 | stuk | 315,00 | 082 | 1 |
| Toebehoren & afvoeren | 0341193 | 180x80cm | wit | 3800000 | stuk | 315,00 | 082 | 0 |
| | 0340465 | 180x80cm | klassiek wit | 3800018 | stuk | 315,00 | 082 | 1 |
| | 0340995 | badpoten per set voor 1010-1240-1700-301034/35/36-3710-38/3 | | B231500 | stuk | 28,00 | 082 | 0 |
| Spoel- & installatiesystemen | bad plaatstaal dikwandig rechthoekig m. poten | | | | | | | |
| | 0340375 | 140x71cm | wit | 3400000+B231500 | stuk | 343,00 | 082 | 1 |
| | 0351210 | 140x71cm | pergamon | 3400001+B231500 | stuk | 459,00 | 082 | 1 |
| | 0340413 | 150x71cm | wit | 3500000+B231500 | stuk | 343,00 | 082 | 1 |
| | 0351229 | 150x71cm | pergamon | 3500001+B231500 | stuk | 459,00 | 082 | 1 |
| Badkamermeubelen en toiletkasten | 0340421 | 160x71cm | wit | 3600000+B231500 | stuk | 227,00 | 082 | 1 |
| | 0351245 | 160x71cm | pergamon | 3600001+B231500 | stuk | 334,00 | 082 | 1 |
| | 0340422 | 170x70cm | wit | 3970000+B231500 | stuk | 221,00 | 082 | 1 |
| | 0342068 | 170x70cm | pergamon | 3970001+B231500 | stuk | 327,00 | 082 | 1 |
| | 0340456 | 170x75cm | wit | 3710000+B231500 | stuk | 221,00 | 082 | 0 |
| Gootstenen en wastroggen | 0352829 | 170x75cm | pergamon | 3710001+B231500 | stuk | 327,00 | 082 | 1 |
| | 0340004 | 170x75cm | klassiek wit | 3710018+B231500 | stuk | 221,00 | 082 | 1 |
| | 0341468 | 170x75cm | starwhite | 3710287+B231500 | stuk | 327,00 | 082 | 1 |
| | 0342076 | 170x80cm | wit | 3490000+B231500 | stuk | 343,00 | 082 | 1 |
| | 0350100 | 170x80cm | pergamon | 3490001+B231500 | stuk | 459,00 | 082 | 1 |
| Utiliteit | 0341112 | 180x80cm m. grepen | wit | 3800000+B231500+B080901 | stuk | 472,00 | 082 | 1 |
| | 0340464 | 180x80cm | wit | 3800000+B231500 | stuk | 343,00 | 082 | 0 |
| | 0352950 | 180x80cm | pergamon | 3800001+B231500 | stuk | 459,00 | 082 | 1 |
| | 0340472 | 190x80cm | wit | 3900000+B231500 | stuk | 425,00 | 082 | 1 |
| | 0352977 | 190x80cm | pergamon | 3900001+B231500 | stuk | 599,00 | 082 | 1 |
| Bette Bambino | bad plaatstaal dikwandig links z. poten | | | | | | | |
| | 0348345 | 157x70/55cm | wit | 2570000 | stuk | 514,00 | 082 | 1 |
| | 0340995 | badpoten per set voor 1010-1240-1700-301034/35/36-3710-38/3 | | B231500 | stuk | 28,00 | 082 | 0 |
| Bette Cora | bad plaatstaal dikwandig | | | | | | | |
| | 0342222 | 160x90cm ronding rechts z. poten | klassiek wit | 2810018 | stuk | 1165,00 | 082 | 1 |
| | 0346950 | 170x90cm ronding rechts z. poten | wit | 2130000 | stuk | 1165,00 | 082 | 1 |
| | 0340995 | badpoten per set voor 1010-1240-1700-301034/35/36-3710-38/3 | | B231500 | stuk | 28,00 | 082 | 0 |
| plaatstaal hoekbad dikwandig links | 0341238 | 170x90cm m. ommanteling | wit | 2830000CERH | stuk | 2025,00 | 082 | 1 |
| | 0340995 | badpoten per set voor 1010-1240-1700-301034/35/36-3710-38/3 | | B231500 | stuk | 28,00 | 082 | 0 |
| | plint voor plaatstaal hoekbad | | | | | | | |
| 0341818 | 170cm | wit | 2132000 | stuk | 228,00 | 082 | 1 | |

| Art.nr | Specificaties | Kleur | Lev.nr | Ehd | Prijs | Grp | CC |
|-------------------------------------|---|-------|---------|------|---------|-----|----|
| Bette Cora Ronda | | | | | | | |
| plaatstaal hoekbad dikwandig | | | | | | | |
| 0346951 | 170x90cm rechts z. poten | wit | 8510000 | stuk | 1221,00 | 082 | 1 |
| 0346952 | 170x90cm links z. poten | wit | 8530000 | stuk | 1221,00 | 082 | 1 |
| 0340995 | badpoten per set voor 1010-1240-1700-301034/35/36-3710-38/3 | | B231500 | stuk | 28,00 | 082 | 0 |



Sanitair producten

Baden /
douchebakken /
stoomcabines

Kranen

Doucheapparatuur

Accessoires en
spiegels

Douchewanden

Toebehoren &
afvoeren

Spoel- &
installatiesystemen

Badkamermeubelen
en toiletkasten





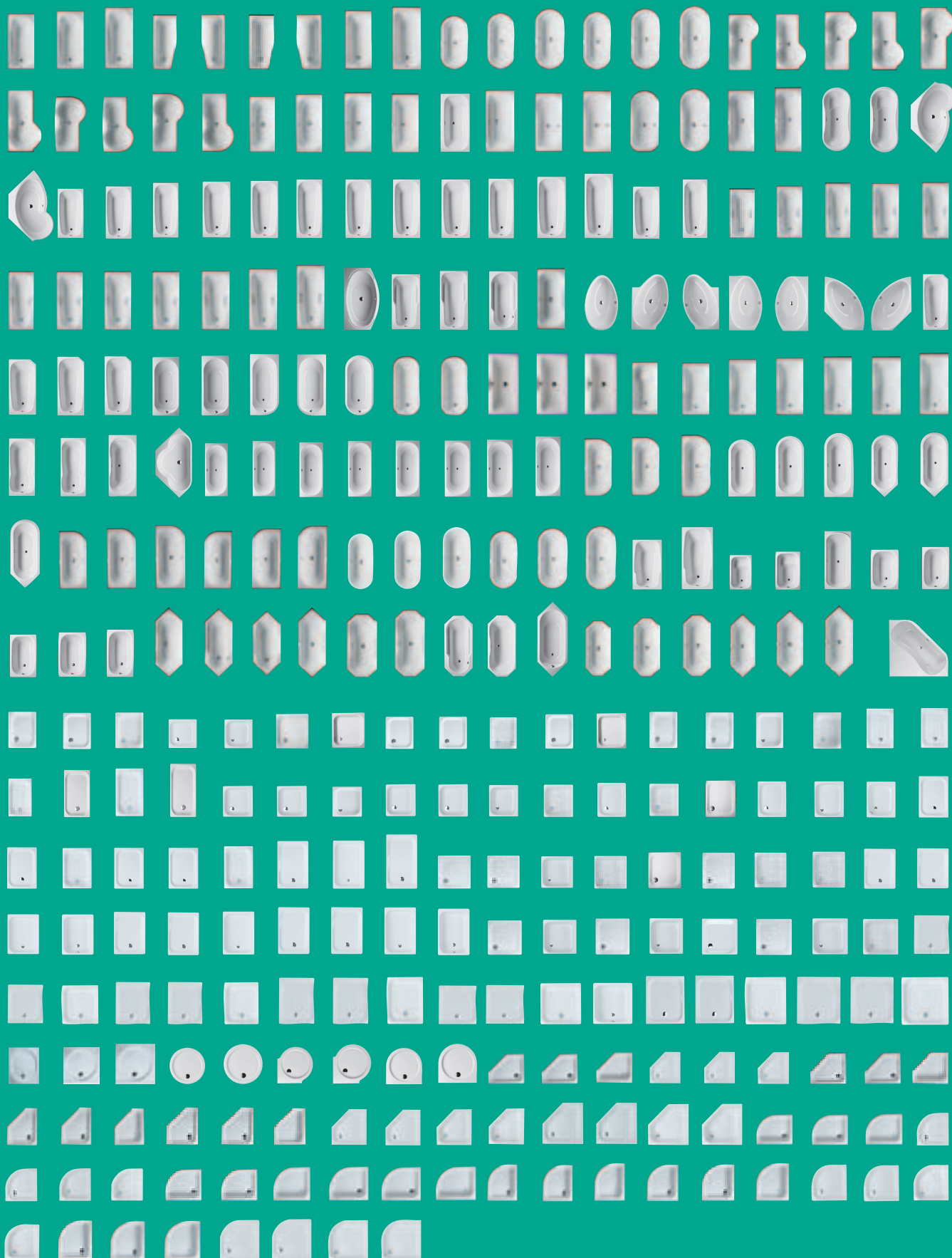

Gootstenen en
wastroggen

Utiliteit



BETTE
Baden und Duschen

Bette GmbH & Co. KG · Heinrich-Bette-Str. 1 · D-33129 Delbrück · Telefon +49 52 50/ 511-0 · Fax +49 52 50/ 511-130 · info@bette.de
www.bette.de

| Art.nr | Specificaties | Kleur | Lev.nr | Ehd | Prijs | Grp | CC | | |
|------------------------------------|---|-----------------------------|----------|-------------------------|-------|---------|-----|---|---|
| Bette Darling | | | | | | | |  | |
| bad plaatstaal dikwandig | | | | | | | | | |
| 0340790 | 160x70cm | rechthoekig m. poten | wit | D600000+B231500 | stuk | 542,00 | 082 | 1 | Sanitair producten |
| 0353620 | 160x70cm | rechthoekig m. poten | pergamon | D600001+B231500 | stuk | 696,00 | 082 | 1 | |
| 0340804 | 160x70cm | rechthoekig m. poten m. grp | wit | D600000+B231500+B090901 | stuk | 630,00 | 082 | 1 | Baden / douchebakken / stoomcabines |
| 0353698 | 160x70cm | rechthoekig m. poten m. grp | pergamon | D600001+B231500+B090901 | stuk | 784,00 | 082 | 1 | |
| 0340820 | 170x75cm | rechthoekig m. poten m. grp | wit | D710000+B231500+B090901 | stuk | 630,00 | 082 | 1 | Kranen |
| 0353884 | 170x75cm | rechthoekig m. poten m. grp | pergamon | D710001+B231500+B090901 | stuk | 784,00 | 082 | 1 | |
| 0340847 | 180x80cm | rechthoekig m. poten m. grp | wit | D800000+B231500+B090901 | stuk | 813,00 | 082 | 1 | Douchegarnituur |
| 0354074 | 180x80cm | rechthoekig m. poten m. grp | pergamon | D800001+B231500+B090901 | stuk | 969,00 | 082 | 1 | |
| 0341487 | 170x75cm | rechthoekig z. poten | wit | D710000 | stuk | 514,00 | 082 | 1 | Accessoires en spiegels |
| 0342025 | 170x75cm | rechthoekig z. poten | pergamon | D710001 | stuk | 668,00 | 082 | 1 | |
| 0341312 | 180x80cm | rechthoekig z. poten | wit | D800000 | stuk | 697,00 | 082 | 1 | Douchewanden |
| 0354910 | 180x80cm | rechthoekig z. poten | pergamon | D800001 | stuk | 853,00 | 082 | 1 | |
| 0340995 | badpoten per set voor 1010-1240-1700-301034/35/36-3710-38/3 | | | B231500 | stuk | 28,00 | 082 | 0 | Toebehoren & afvoeren |
| Bette Duett | | | | | | | |  | |
| bad plaatstaal dikwandig | | | | | | | | | |
| 0340766 | 170x80cm | rechthoekig m. poten | wit | 3100000+B231500 | stuk | 579,00 | 082 | 1 | Douchewanden |
| 0353515 | 170x80cm | rechthoekig m. poten | pergamon | 3100001+B231500 | stuk | 739,00 | 082 | 1 | |
| Bette Duo | | | | | | | |  | |
| bad plaatstaal dikwandig | | | | | | | | | |
| 0340138 | 180x80cm | rechthoekig m. poten | wit | 3820000+B231500 | stuk | 725,00 | 082 | 1 | Toebehoren & afvoeren |
| 0352969 | 180x80cm | rechthoekig m. poten | pergamon | 3820001+B231500 | stuk | 881,00 | 082 | 1 | |
| Bette Linea | | | | | | | |  | |
| bad plaatstaal dikwandig | | | | | | | | | |
| 0340997 | 170x80cm | rechthoekig m. poten | wit | 2480000+B231500 | stuk | 671,00 | 082 | 1 | Spoel- & installatiesystemen |
| Bette Morrison | | | | | | | |  | |
| bad plaatstaal dikwandig | | | | | | | | | |
| 0340990 | 180x80cm | rechthoekig m. poten | wit | 2460000+B231500 | stuk | 840,00 | 082 | 1 | Badkamermeubelen en toiletkasten |
| Bette Pool | | | | | | | |  | |
| bad plaatstaal links | | | | | | | | | |
| 0342312 | 164x96cm | z. poten z. mantel | wit | 6054000 | stuk | 1283,00 | 082 | 1 | Gootstenen en wastroggen |
| 0342313 | 164x96cm | z. poten z. mantel | pergamon | 6054001 | stuk | 1464,00 | 082 | 1 | |
| 0342316 | 164x96cm | m. poten m. mantel | wit | 6054000CERV | stuk | 2005,00 | 082 | 1 | Utiliteit |
| 0342317 | 164x96cm | m. poten m. mantel | pergamon | 6054001CERV | stuk | 2210,00 | 082 | 1 | |
| bad plaatstaal rechts | | | | | | | | | |
| 0342314 | 164x96cm | z. poten z. mantel | wit | 6055000 | stuk | 1283,00 | 082 | 1 | Utiliteit |
| 0342315 | 164x96cm | z. poten z. mantel | pergamon | 6055001 | stuk | 1464,00 | 082 | 1 | |
| 0342318 | 164x96cm | m. poten m. mantel | wit | 6055000CELV | stuk | 2005,00 | 082 | 1 | Utiliteit |
| 0342320 | 164x96cm | m. poten m. mantel | pergamon | 6055001CELV | stuk | 2210,00 | 082 | 1 | |
| bad plaatstaal ovaal | | | | | | | | | |
| 0342310 | 164x96cm | z. poten | wit | 6050000 | stuk | 1085,00 | 082 | 1 | Utiliteit |
| 0342311 | 164x96cm | z. poten | pergamon | 6050001 | stuk | 1247,00 | 082 | 1 | |
| 0342336 | douchebakpoten 4stuks voor 6,5 / 15cm | | | B500015 | stuk | 22,00 | 082 | 1 | |
| sokkel voor Pool II Comfort | | | | | | | | | |
| 0342321 | | | wit | 6058000 | stuk | 228,00 | 082 | 1 | |
| 0342322 | | | pergamon | 6058001 | stuk | 269,00 | 082 | 1 | |
| Bette Pur | | | | | | | |  | |
| bad plaatstaal rechthoekig | | | | | | | | | |
| 0342331 | 170x75 | z.poten | wit | 8260000 | stuk | 545,00 | 082 | 1 | Utiliteit |
| 0342332 | 170x75 | z.poten | pergamon | 8260001 | stuk | 708,00 | 082 | 1 | |
| 0342333 | 180x80 | z.poten | wit | 8760000 | stuk | 734,00 | 082 | 1 | Utiliteit |
| 0342334 | 180x80 | z.poten | pergamon | 8760001 | stuk | 904,00 | 082 | 1 | |
| 0340995 | badpoten per set voor 1010-1240-1700-301034/35/36-3710-38/3 | | | B231500 | stuk | 28,00 | 082 | 0 | |

| | Art.nr | Specificaties | Kleur | Lev.nr | Ehd | Prijs | Grp | CC |
|---|---|---|-----------|---------------------------|------|---------|-----|----|
| Sanitair producten | Bette Roma | | | | | | | |
| | bad plaatstaal dikwandig vrijstaand | | | | | | | |
| | 0340021 | 170x75cm ovaal z. poten | wit | 3130000 | stuk | 1420,00 | 082 | 1 |
| Baden / douchebakken / stoomcabines | badpoten per set | | | | | | | |
| | 0340012 | | chrom | B240901 | stuk | 708,00 | 082 | 1 |
| Kranen | bad- /overloopgarnituur | | | | | | | |
| | 0340016 | | chrom | B260901 | stuk | 815,00 | 082 | 1 |
| Douchegarnituur | Bette Schmiddy | | | | | | | |
| | bad plaatstaal rechthoekig | | | | | | | |
| | 0342323 | 180x80x45cm z.poten | wit | 8766000 | stuk | 938,00 | 082 | 1 |
| | 0342324 | 180x80x45cm z.poten | pergamon | 8766001 | stuk | 1088,00 | 082 | 1 |
| | 0342325 | 180x85x45cm z.poten | wit | 8767000 | stuk | 938,00 | 082 | 1 |
| | 0342326 | 180x85x45cm z.poten | pergamon | 8767001 | stuk | 1088,00 | 082 | 1 |
| | 0342329 | 180x90x45cm z.poten | wit | 8768000 | stuk | 938,00 | 082 | 1 |
| | 0342328 | 180x90x45cm z.poten | pergamon | 8768001 | stuk | 1088,00 | 082 | 1 |
| Accessoires en spiegels | 0340995 | badpoten per set voor 1010-1240-1700-301034/35/36-3710-38/3 | | B231500 | stuk | 28,00 | 082 | 0 |
| Douchewanden | douchebakpoten 4stuks | | | | | | | |
| | 0342336 | voor 6,5 / 15cm | | B500015 | stuk | 22,00 | 082 | 1 |
| Toebehoren & afvoeren | Rotaplextrio badvul, afvoer en overloopgarnituur | | | | | | | |
| | 0342330 | | chrom | B790901 | stuk | 317,00 | 082 | 1 |
| Spool- & installatiesystemen | Rotaplex af- en overloopgarnituur | | | | | | | |
| | 0342309 | | chrom | B780901 | stuk | 187,00 | 082 | 1 |
| Badkamermeubelen en toiletkasten | Bette Set | | | | | | | |
| | bad plaatstaal dikwandig rechthoekig | | | | | | | |
| | 0341425 | 170x75cm z. poten | wit | 3060000 | stuk | 625,00 | 082 | 1 |
| | 0341479 | 170x80cm z. poten m. grepen | wit | 3760000+B110901 | stuk | 748,00 | 082 | 1 |
| | 0348343 | 150x75cm m. poten | wit | 2560000+B231500 | stuk | 653,00 | 082 | 1 |
| | 0348344 | 170x75cm m. poten | pergamon | 3060001+B231500 | stuk | 793,00 | 082 | 1 |
| | 0304835 | 170x75cm m. poten m. antislip | wit | 3060000AR+B231500 | stuk | 765,00 | 082 | 1 |
| | 0350643 | 170x75cm m. poten m. antislip | pergamon | 3060001AR+B231500 | stuk | 905,00 | 082 | 1 |
| | 0340626 | 170x80cm m. poten | wit | 3760000+B231500 | stuk | 653,00 | 082 | 1 |
| | 0352888 | 170x80cm m. poten | pergamon | 3760001+B231500 | stuk | 793,00 | 082 | 1 |
| Gootstenen en wastroggen | 0340502 | 170x80cm m. poten m. grepen | wit | 3760000+B231500+B110901 | stuk | 770,00 | 082 | 1 |
| | 0352853 | 170x80cm m. poten m. grepen | pergamon | 3760001+B231500+B110901 | stuk | 916,00 | 082 | 1 |
| Utiliteit | 0352854 | 170x80cm m. poten m. grepen | manhattan | 3760002+B231500+B110901 | stuk | 916,00 | 082 | 1 |
| | 0340782 | 170x80cm m. poten m. grepen m. antislip | wit | 3760000AR+B231500+B110901 | stuk | 888,00 | 082 | 1 |
| | 0353612 | 170x80cm m. poten m. grepen m. antislip | pergamon | 3760001AR+B231500+B110901 | stuk | 1028,00 | 082 | 1 |
| | 0340076 | 180x80cm m. poten | wit | 3860000+B231500 | stuk | 771,00 | 082 | 1 |
| | 0342084 | 180x80cm m. poten | pergamon | 3860001+B231500 | stuk | 922,00 | 082 | 1 |
| | 0342889 | 180x80cm m. poten m. antislip | wit | 3860000AR+B231500 | stuk | 883,00 | 082 | 1 |
| | 0350102 | 180x80cm m. poten m. antislip | pergamon | 3860001AR+B231500 | stuk | 1034,00 | 082 | 1 |
| | 0350101 | 180x80cm m. poten m. antislip | manhattan | 3860002AR+B231500 | stuk | 1034,00 | 082 | 1 |
| Badkamermeubelen en toiletkasten | Bette Sign | | | | | | | |
| | bad plaatstaal dikwandig rechthoekig | | | | | | | |
| | 0341138 | 180x80cm z. poten | wit | 3830000 | stuk | 774,00 | 082 | 1 |
| | 0340995 | badpoten per set voor 1010-1240-1700-301034/35/36-3710-38/3 | | B231500 | stuk | 28,00 | 082 | 0 |
| Badkamermeubelen en toiletkasten | Bette Starlet | | | | | | | |
| | bad plaatstaal dikwandig | | | | | | | |
| | 0360487 | 165x75cm ovaal m. poten | wit | 2720000+B231500 | stuk | 1082,00 | 082 | 1 |
| | 0360586 | 175x80cm ovaal z. poten | wit | 2680000 | stuk | 1054,00 | 082 | 1 |
| | 0360588 | 185x85cm ovaal z. poten | wit | 2740000 | stuk | 1176,00 | 082 | 1 |
| | 0340995 | badpoten per set voor 1010-1240-1700-301034/35/36-3710-38/3 | | B231500 | stuk | 28,00 | 082 | 0 |
| Badkamermeubelen en toiletkasten | Bette Trend | | | | | | | |
| | bad plaatstaal dikwandig | | | | | | | |
| | 0340996 | 170x75cm rechthoekig m. poten | wit | 3470000+B231500 | stuk | 640,00 | 082 | 1 |

| Art.nr | Specificaties | Kleur | Lev.nr | Ehd | Prijs | Grp | CC |
|--------|---------------|-------|--------|-----|-------|-----|----|
|--------|---------------|-------|--------|-----|-------|-----|----|

Bette Voetzitbad

plaatstaal voetzitbad dikwandig

| | | | | | | | |
|---------|------------------------------------|-----|---------|------|--------|-----|---|
| 0360424 | 105x65cm rechthoekig z. poten | wit | 1050000 | stuk | 451,00 | 082 | 1 |
| 0340969 | badpoten per set Seat + voetzitbad | | B231520 | stuk | 28,00 | 082 | 1 |



Sanitair producten

Bette LaBette

bad plaatstaal dunwandig

| | | | | | | | |
|---------|-------------------------------|----------|-----------------|------|--------|-----|---|
| 0340154 | 108x73cm rechthoekig m. poten | wit | 1080000+B231500 | stuk | 437,00 | 082 | 1 |
| 0352675 | 108x73cm rechthoekig m. poten | pergamon | 1080001+B231500 | stuk | 519,00 | 082 | 1 |
| 0340162 | 118x73cm rechthoekig m. poten | wit | 1180000+B231500 | stuk | 437,00 | 082 | 1 |
| 0352691 | 118x73cm rechthoekig m. poten | pergamon | 1180001+B231500 | stuk | 519,00 | 082 | 1 |
| 0340006 | 124x70cm rechthoekig m. poten | wit | 1240000+B231500 | stuk | 437,00 | 082 | 1 |
| 0351164 | 124x70cm rechthoekig m. poten | pergamon | 1240001+B231500 | stuk | 519,00 | 082 | 1 |



Baden /
douchebakken /
stoomcabines

Kranen

Bette Toebehoren

| | | | | | | | |
|---------|---|--|---------|------|--------|-----|---|
| 0340995 | badpoten per set voor 1010-1240-1700-301034/35/36-3710-38/3 | | B231500 | stuk | 28,00 | 082 | 0 |
| 0360426 | badpoten per set voor Family | | B231510 | stuk | 28,00 | 082 | 1 |
| 0340969 | badpoten per set Seat + voetzitbad | | B231520 | stuk | 28,00 | 082 | 1 |
| 0340685 | set geluiddempende platen | | AD | stuk | 62,00 | 082 | 1 |
| 0340992 | badgreep per paar chroom | | B080901 | stuk | 129,00 | 082 | 1 |
| 0340929 | badgreep per stuk chroom | | B090901 | stuk | 88,00 | 082 | 1 |
| 0340993 | badgreep per paar chroom | | B110901 | stuk | 123,00 | 082 | 1 |
| 0341136 | Fix voorpaneel 170x42cm wit | | 2030000 | stuk | 149,00 | 082 | 1 |
| 0360490 | Fix zijpaneel 66x42cm wit | | 2110000 | stuk | 107,00 | 082 | 1 |
| 0371322 | Fix zijpaneel 71x42cm wit | | 2120000 | stuk | 107,00 | 082 | 1 |
| 0341111 | Fix voorplint 170x12cm wit | | 2230000 | stuk | 62,00 | 082 | 1 |
| 0371321 | Fix voorplint 167x12cm wit | | 2240000 | stuk | 62,00 | 082 | 1 |
| 0360491 | Fix zijplint 63x12cm wit | | 2300000 | stuk | 54,00 | 082 | 1 |
| 0371320 | Fix zijplint 68x12cm wit | | 2310000 | stuk | 54,00 | 082 | 1 |
| 0371324 | Fix set hoeksteunen per 4 stuks | | B150003 | stuk | 98,00 | 082 | 1 |
| 0371326 | Fix diagonaalschoren | | B160003 | stuk | 11,00 | 082 | 1 |

Douchegarnituur

Accessoires en
spiegels

Douchewanden

Toebehoren &
afvoeren







Spoel- &
installatiesystemen

Badkamermeubelen
en toiletkasten

Gootstenen en
wastroggen

Utiliteit

| | Art.nr | Specificaties | Kleur | Lev.nr | Ehd | Prijs | Grp | CC |
|---|---------------------------------------|---|--------------|-----------|--------|--------|-----|----|
| | Bette Model diep 28cm | | | | | | | |
| | douchebak plaatstaal dikwandig | | | | | | | |
| Sanitair producten | 0360252 | 80x80x28cm vierkant | wit | 5810000 | stuk | 156,00 | 082 | 1 |
| | 0371289 | 80x80x28cm vierkant | pergamon | 5810001 | stuk | 220,00 | 082 | 1 |
| | 0341213 | 80x120x28cm rechthoekig | wit | 5860000 | stuk | 518,00 | 082 | 1 |
| | 0360260 | 90x90x28cm vierkant | wit | 5910000 | stuk | 165,00 | 082 | 1 |
| Baden / douchebakken / stoomcabines | 0371319 | 90x90x28cm vierkant | pergamon | 5910001 | stuk | 231,00 | 082 | 1 |
| | 0360389 | 100x100x28 vierkant | pergamon | 5610001 | stuk | 500,00 | 082 | 1 |
| | 0360309 | douchebaksteun m. 3 verstelbare poten 125-195mm | | 3SGS | stuk | 12,25 | 062 | 0 |
| | | | | | | | | |
| | Bette Model vlak 15cm | | | | | | | |
| | douchebak plaatstaal dikwandig | | | | | | | |
| Kranen | 0360484 | 70x100x15cm rechthoekig | wit | 5890000 | stuk | 333,00 | 082 | 1 |
| | 0342092 | 70x100x15cm rechthoekig | pergamon | 5890001 | stuk | 362,00 | 082 | 1 |
| Douchegarnituur | 0360325 | 80x75x15cm rechthoekig | wit | 5650000 | stuk | 105,00 | 082 | 1 |
| | 0371114 | 80x75x15cm rechthoekig | pergamon | 5650001 | stuk | 174,00 | 082 | 1 |
| | 0360007 | 80x80x15cm vierkant | wit | 5800000 | stuk | 90,00 | 082 | 0 |
| | 0371254 | 80x80x15cm vierkant | pergamon | 5800001 | stuk | 159,00 | 082 | 1 |
| Accessoires en spiegels | 0372447 | 80x80x15cm vierkant | manhattan | 5800002 | stuk | 159,00 | 082 | 1 |
| | 0360473 | 80x80x15cm vierkant m. antislip | wit | 5800000AR | stuk | 202,00 | 082 | 1 |
| | 0350000 | 80x90x15cm rechthoekig | wit | 5950000 | stuk | 225,00 | 082 | 1 |
| | 0360483 | 80x90x15cm rechthoekig | pergamon | 5950001 | stuk | 258,00 | 082 | 1 |
| Douchewanden | 0360363 | 80x100x15cm rechthoekig | wit | 5500000 | stuk | 333,00 | 082 | 1 |
| | 0342106 | 80x100x15cm rechthoekig | pergamon | 5500001 | stuk | 362,00 | 082 | 1 |
| | 0360442 | 80x120x15cm rechthoekig | wit | 5850000 | stuk | 429,00 | 082 | 1 |
| | 0342114 | 80x120x15cm rechthoekig | pergamon | 5850001 | stuk | 461,00 | 082 | 1 |
| Toebehoren & afvoeren | 0360244 | 90x75x15cm rechthoekig | wit | 5750000 | stuk | 114,00 | 082 | 0 |
| | 0371173 | 90x75x15cm rechthoekig | pergamon | 5750001 | stuk | 174,00 | 082 | 1 |
| | 0360236 | 90x90x15cm vierkant | wit | 5900000 | stuk | 95,00 | 082 | 0 |
| | 0371300 | 90x90x15cm vierkant | pergamon | 5900001 | stuk | 166,00 | 082 | 0 |
| Spoel- & installatiesystemen | 0371874 | 90x90x15cm vierkant | klassiek wit | 5900018 | stuk | 95,00 | 082 | 1 |
| | 0372633 | 90x90x15cm vierkant | manhattan | 5900002 | stuk | 166,00 | 082 | 1 |
| | 0360475 | 90x90x15cm vierkant | greenwich | 5900026 | stuk | 166,00 | 082 | 1 |
| | 0360009 | 90x90x15cm vierkant | sunrise | 5900295 | stuk | 366,00 | 082 | 1 |
| Badkamermeubelen en toiletkasten | 0360511 | 90x90x15cm vierkant m. antislip | wit | 5900000AR | stuk | 207,00 | 082 | 0 |
| | 0371890 | 90x90x15cm vierkant m. antislip | pergamon | 5900001AR | stuk | 278,00 | 082 | 1 |
| | 0360183 | 90x110x15cm rechthoekig | wit | 8650000 | stuk | 333,00 | 082 | 1 |
| | 0342122 | 90x110x15cm rechthoekig | pergamon | 8650001 | stuk | 362,00 | 082 | 1 |
| | 0361005 | 90x120x15cm rechthoekig | wit | 1290000 | stuk | 429,00 | 082 | 1 |
| | 0360309 | douchebaksteun m. 3 verstelbare poten 125-195mm | | 3SGS | stuk | 12,25 | 062 | 0 |
| | Bette Extra vlak 6,5cm | | | | | | | |
| | douchebak plaatstaal dikwandig | | | | | | | |
| Gootstenen en wastroggen | 0364824 | 90x70x6.5 rechthoekig | wit | 5710000 | stuk | 342,00 | 082 | 1 |
| | 0346953 | 75x85x6.5 rechthoekig | wit | 1570000AR | stuk | 445,00 | 082 | 1 |
| Utiliteit | 0360004 | 90x75x6.5 rechthoekig | wit | 5770000 | stuk | 342,00 | 082 | 1 |
| | 0360010 | 90x75x6.5 rechthoekig m. antislip | wit | 5770000AR | stuk | 454,00 | 082 | 1 |
| | 0304838 | 90x75x6.5 rechthoekig m. antislip | pergamon | 5770001AR | stuk | 482,00 | 082 | 1 |
| | 0360493 | 75x120x6.5 rechthoekig | wit | 5570000 | stuk | 498,00 | 082 | 1 |
| | 0360481 | 80x80x6.5 vierkant | wit | 5820000 | stuk | 324,00 | 082 | 1 |
| | 0371297 | 80x80x6.5 vierkant | pergamon | 5820001 | stuk | 353,00 | 082 | 1 |
| | 0360503 | 80x80x6.5 vierkant m. antislip | wit | 5820000AR | stuk | 436,00 | 082 | 1 |
| | 0360489 | 90x80x6.5 rechthoekig | wit | 5970000 | stuk | 342,00 | 082 | 1 |
| | 0341214 | 90x80x6.5 rechthoekig m. antislip | wit | 5970000AR | stuk | 454,00 | 082 | 1 |
| | 0360480 | 80x100x6.5 rechthoekig | wit | 5520000 | stuk | 417,00 | 082 | 1 |
| | 0360486 | 80x100x6.5 rechthoekig | klassiek wit | 5520018 | stuk | 417,00 | 082 | 1 |
| | 0360485 | 80x100x6.5 rechthoekig m. antislip | wit | 5520000AR | stuk | 529,00 | 082 | 1 |
| | 0360482 | 120x80x6.5 rechthoekig | wit | 5870000 | stuk | 484,00 | 082 | 1 |
| | 0360016 | 120x80x6.5 rechthoekig | pergamon | 5870001 | stuk | 513,00 | 082 | 1 |
| | 0360538 | 90x90x6.5 vierkant | wit | 5920000 | stuk | 330,00 | 082 | 1 |
| | 0371327 | 90x90x6.5 vierkant | pergamon | 5920001 | stuk | 364,00 | 082 | 1 |
| | 0360546 | 90x90x6.5 vierkant m. antislip | wit | 5920000AR | stuk | 442,00 | 082 | 1 |
| | 0360492 | 90x100x6.5 rechthoekig | wit | 5380000 | stuk | 417,00 | 082 | 1 |
| 0530211 | 90x110x6.5 rechthoekig | wit | 8640000 | stuk | 417,00 | 082 | 1 | |
| 0304827 | 90x120x6.5 rechthoekig m. antislip | wit | 1690000AR | stuk | 596,00 | 082 | 1 | |
| 0342130 | 100x100x6.5 vierkant m. antislip | wit | 5620000AR | stuk | 556,00 | 082 | 1 | |
| 0340009 | 100x100x6.5 vierkant m. antislip | pergamon | 5620001AR | stuk | 597,00 | 082 | 1 | |
| 0340040 | 100x100x6.5 vierkant | klassiek wit | 5620018 | stuk | 444,00 | 082 | 1 | |
| 0341156 | 100x120x6.5 rechthoekig | wit | 8670000 | stuk | 444,00 | 082 | 1 | |
| | 0360309 | douchebaksteun m. 3 verstelbare poten 125-195mm | | 3SGS | stuk | 12,25 | 062 | 0 |

| Art.nr | Specificaties | Kleur | Lev.nr | Ehd | Prijs | Grp | CC | | | |
|--|---|----------------------------------|-----------|-----------|-------|---------|-----|-------------------------------|---|----------------------------------|
| | | | | | | | | Bette Super vlak 3,5cm | | |
| douchebak plaatstaal dikwandig | | | | | | | | | | |
| 0342226 | 80x100x3.5 | rechthoekig m. antislip | wit | 5490000AR | stuk | 529,00 | 082 | 1 |  | Sanitair producten |
| 0360563 | 90x90x3.5 | vierkant | wit | 5930000 | stuk | 342,00 | 082 | 1 | | |
| 0342149 | 90x90x3.5 | vierkant | pergamon | 5930001 | stuk | 370,00 | 082 | 1 | | |
| 0360564 | 90x90x3.5 | vierkant | starwhite | 5930287 | stuk | 342,00 | 082 | 1 | | |
| 0364819 | 90x100x3.5 | rechthoekig | wit | 1660000 | stuk | 417,00 | 082 | 1 | | |
| 0360309 | douchebaksteun m. 3 verstelbare poten 125-195mm | | | 3SGS | stuk | 12,25 | 062 | 0 | | |
| | | | | | | | | Bette Darling | | |
| douchebak plaatstaal dikwandig | | | | | | | | | | |
| 0360651 | 90x75x6.5cm | rechthoekig | wit | D770000 | stuk | 351,00 | 082 | 1 |  | Kranen |
| 0371750 | 90x75x6.5cm | rechthoekig | pergamon | D770001 | stuk | 381,00 | 082 | 1 | | |
| 0360643 | 90x90x6.5cm | vierkant | wit | D920000 | stuk | 339,00 | 082 | 1 | | |
| 0371653 | 90x90x6.5cm | vierkant | pergamon | D920001 | stuk | 375,00 | 082 | 1 | | |
| 0360309 | douchebaksteun m. 3 verstelbare poten 125-195mm | | | 3SGS | stuk | 12,25 | 062 | 0 | | |
| | | | | | | | | Bette Point Rond | | |
| douchebak plaatstaal dikwandig | | | | | | | | | | |
| 0354556 | 90x3.5cm | rond m. poten | wit | 4822000 | stuk | 1078,00 | 082 | 1 |  | Douchegarnituur |
| 0354555 | 90x6.5cm | rond m. poten | wit | 4820000 | stuk | 1078,00 | 082 | 1 | | |
| 0354554 | 100x3.5cm | rond m. poten | wit | 4823000 | stuk | 1129,00 | 082 | 1 | | |
| 0354553 | 100x6.5cm | rond m. poten | wit | 4821000 | stuk | 1129,00 | 082 | 1 | | |
| | | | | | | | | Bette Point | | |
| douchebak plaatstaal dikwandig | | | | | | | | | | |
| 0360006 | 90x90x6.5cm | kwarttrond m. paneel | wit | 1020000 | stuk | 1005,00 | 082 | 1 |  | Douchewanden |
| | | | | | | | | | | |
| | | | | | | | | Bette Caro | | |
| douchebak plaatstaal dikwandig | | | | | | | | | | |
| 0340072 | 100x100x6.5 | vijfhoekig m. paneel | wit | 7250000 | stuk | 862,00 | 082 | 1 |  | Spoel- & installatiesystemen |
| 0371027 | 80x80x15 | vijfhoekig z. paneel | pergamon | 5330001 | stuk | 963,00 | 082 | 1 | | |
| 0342157 | 90x90x6.5 | vijfhoekig z. paneel | wit | 7190000 | stuk | 801,00 | 082 | 1 | | |
| 0342210 | 90x90x6.5 | vijfhoekig z. paneel | pergamon | 7190001 | stuk | 963,00 | 082 | 1 | | |
| 0340039 | 90x90x15 | vijfhoekig z. paneel | wit | 7200000 | stuk | 801,00 | 082 | 1 | | |
| 0340007 | 90x90x15 | vijfhoekig z. paneel | pergamon | 7200001 | stuk | 963,00 | 082 | 1 | | |
| 0369876 | 100x100x15 | vijfhoekig z. paneel | wit | 7230000 | stuk | 822,00 | 082 | 1 | | |
| 0350271 | 100x100x15 | vijfhoekig z. paneel m. antislip | wit | 7230000AR | stuk | 934,00 | 082 | 1 | | |
| 0369877 | 100x100x15 | vijfhoekig z. paneel m. antislip | pergamon | 7230001AR | stuk | 1101,00 | 082 | 1 | | |
| 0360309 | douchebaksteun m. 3 verstelbare poten 125-195mm | | | 3SGS | stuk | 12,25 | 062 | 0 | | |
| | | | | | | | | Bette Corner | | |
| douchebak plaatstaal dikwandig kwarttrond | | | | | | | | | | |
| 0360184 | 90x90x6.5cm | m. paneel | wit | 8910000 | stuk | 625,00 | 082 | 1 |  | Badkamermeubelen en toiletkasten |
| 0361100 | 90x90x15cm | m. paneel | wit | 7910000 | stuk | 625,00 | 082 | 1 | | |
| 0304828 | 90x90x15cm | m. paneel m. antislip | wit | 7910000AR | stuk | 737,00 | 082 | 1 | | |
| 0361105 | 100x100x28 | m. paneel | wit | 7820000 | stuk | 654,00 | 082 | 1 | | |
| 0361108 | 90x90x6.5 | z. paneel m. antislip | wit | 5430000AR | stuk | 670,00 | 082 | 1 | | |
| 0364433 | 100x100x6.5 | z. paneel m. antislip | wit | 5460000AR | stuk | 703,00 | 082 | 1 | | |
| afneembare plint | | | | | | | | | | |
| 0340624 | | hoogte=7.5cm | wit | 8960000 | stuk | 96,00 | 082 | 1 | Gootstenen en wastroggen | |
| 0304830 | | hoogte=10cm | | 7950000 | stuk | 96,00 | 082 | 1 | | |
| 0361107 | | hoogte=10cm | wit | 7830000 | stuk | 96,00 | 082 | 1 | | |
| | | | | | | | | Bette Toebehoren | | |
| 0342225 | montageframe voor douchebak 80x100cm | | | B500045 | stuk | 73,00 | 082 | 1 |  | Utiliteit |
| 0370004 | montageframe voor douchebak 90x90cm | | | B500051 | stuk | 67,00 | 082 | 1 | | |
| 0304820 | montageframe voor douchebak 90x100cm | | | B500053 | stuk | 73,00 | 082 | 1 | | |
| 0342227 | montageframe voor douchebak 100x100cm | | | B500064 | stuk | 73,00 | 082 | 1 | | |
| 0370011 | montageframe voor douchebak 80x80cm | | | B500041 | stuk | 67,00 | 082 | 1 | | |
| 0342223 | douchebakpoten 10-12cm per 4 stuks | | | B500010 | stuk | 22,00 | 082 | 1 | | |



Douchebak Megaplan ontwerp Sottsass Associati Milaan.





Puur plezier tot in de lengte van jaren.

In de grootste emailleerovens ter wereld produceert Kaldewei van glasvormende, natuurlijke grondstoffen een speciaal email waarvan het oppervlak gegarandeerd vele jaren lang onveranderlijk blijft. Op het gladde, glas-harde oppervlak ontstaan zelfs geen microscopisch kleine krasjes: bacteriën hebben geen kans om zich te nestelen. Een belofte die Kaldewei nakomt met een garantie van 30 jaar op zijn badkuipen en douchebakken.



Vaioduo

KALDEWEI
Europas Nr. 1 in Badewannen

| Art.nr | Specificaties | Kleur | Lev.nr | Ehd | Prijs | Grp | CC | | |
|---|---|----------|--------------|------|---------|-----|----|---|---|
| Kaldewei Aquamarin | | | | | | | | | |
| bad plaatstaal dikwandig rechthoekig | | | | | | | | | |
| 0341727 | 180x80x42cm z. poten | wit | 240000010001 | stuk | 890,00 | 073 | 1 |  | Sanitair producten |
| 0341728 | 180x80x42cm z. poten | pergamon | 240000010231 | stuk | 890,00 | 073 | 1 | | |
| 0340035 | 180x80x42cm z. poten zelfreinigend | wit | 240000013001 | stuk | 1039,00 | 073 | 1 | | |
| 0340036 | 180x80x42cm z. poten zelfreinigend | pergamon | 240000013231 | stuk | 1039,00 | 073 | 1 | | |
| 0341729 | 190x90x42cm z. poten | wit | 240200010001 | stuk | 1001,00 | 073 | 1 | | Baden / douchebakken / stoomcabines |
| 0341730 | 190x90x42cm z. poten | pergamon | 240200010231 | stuk | 1001,00 | 073 | 1 | | |
| 0340037 | 190x90x42cm z. poten zelfreinigend | wit | 240200013001 | stuk | 1151,00 | 073 | 1 | | |
| 0340078 | 190x90x42cm z. poten zelfreinigend | pergamon | 240200013231 | stuk | 1151,00 | 073 | 1 | | |
| 0341533 | badpoten universeel 5047 per set | | 5047 | stuk | 17,75 | 061 | 0 | | |
| Kaldewei AquamarinStar | | | | | | | | | |
| bad plaatstaal dikwandig rechthoekig m. greepmontage | | | | | | | | | |
| 0340031 | 180x80x42cm z. greep z. poten | wit | 240100010001 | stuk | 890,00 | 073 | 1 | | Kranen |
| 0340032 | 180x80x42cm z. greep z. poten | pergamon | 240100010231 | stuk | 890,00 | 073 | 1 | | |
| 0340251 | 180x80x42cm z. greep z. poten zelfreinigend | wit | 240100013001 | stuk | 1039,00 | 073 | 1 | | Douchegarnituur |
| 0340080 | 180x80x42cm z. greep z. poten zelfreinigend | pergamon | 240100013231 | stuk | 1039,00 | 073 | 1 | | |
| 0340033 | 190x90x42cm z. greep z. poten | wit | 240300010001 | stuk | 1001,00 | 073 | 1 | | |
| 0340034 | 190x90x42cm z. greep z. poten | pergamon | 240300010231 | stuk | 1001,00 | 073 | 1 | | |
| 0340139 | 190x90x42cm z. greep z. poten zelfreinigend | wit | 240300013001 | stuk | 1151,00 | 073 | 1 | | Accessoires en spiegels |
| 0340140 | 190x90x42cm z. greep z. poten zelfreinigend | pergamon | 240300013231 | stuk | 1151,00 | 073 | 1 | | |
| 0340141 | badgrepen voor AquamarinStar chroom | | 588070000999 | stuk | 207,00 | 073 | 1 | | |
| 0341533 | badpoten universeel 5047 per set | | 5047 | stuk | 17,75 | 061 | 0 | | |
| badgrepen voor AquamarinStar | | | | | | | | | |
| 0340141 | | chroom | 588070000999 | stuk | 207,00 | 073 | 1 | | Douchewanden |
| Kaldewei Centro Duo | | | | | | | | | |
| plaatstaal bad dikwandig ovaal | | | | | | | | | |
| 0341974 | 170x75x47cm z. poten zelfreinigend | wit | 292700013001 | stuk | 1417,40 | 073 | 1 |  | Toebehoren & afvoeren |
| 0341975 | 170x75x47cm z. poten zelfreinigend | pergamon | 292700013231 | stuk | 1417,40 | 073 | 1 | | |
| 0341976 | 180x80x47cm z. poten zelfreinigend | wit | 292800013001 | stuk | 1724,40 | 073 | 1 | | |
| 0341977 | 180x80x47cm z. poten zelfreinigend | pergamon | 292800013231 | stuk | 1724,40 | 073 | 1 | | |
| 0341649 | badpoten per set | | 581670000000 | stuk | 49,00 | 073 | 1 | | Spoel- & installatiesystemen |
| plaatstaal bad dikwandig | | | | | | | | | |
| 0341978 | 170x75x47cm z. poten zelfreinigend | wit | 293100013001 | stuk | 1413,40 | 073 | 1 | | |
| 0341979 | 170x75x47cm z. poten zelfreinigend | pergamon | 293100013231 | stuk | 1413,40 | 073 | 1 | | |
| 0341980 | 170x75x47cm links z. poten zelfreinigend | wit | 292900013001 | stuk | 1413,40 | 073 | 1 |  | Badkamermeubelen en toiletkasten |
| 0341981 | 170x75x47cm links z. poten zelfreinigend | pergamon | 292900013231 | stuk | 1413,40 | 073 | 1 | | |
| 0341982 | 170x75x47cm rechts z. poten zelfreinigend | wit | 293000013001 | stuk | 1413,40 | 073 | 1 | | |
| 0341983 | 170x75x47cm rechts z. poten zelfreinigend | pergamon | 293000013231 | stuk | 1413,40 | 073 | 1 | | |
| 0340960 | badpoten per set universeel | | 0340960 | stuk | 38,00 | 073 | 0 | | Gootstenen en wastroggen |
| plaatstaal bad dikwandig rechthoekig | | | | | | | | | |
| 0341984 | 170x75x47cm z. poten zelfreinigend | wit | 293200013001 | stuk | 1012,40 | 073 | 1 |  | Utiliteit |
| 0341985 | 170x75x47cm z. poten zelfreinigend | pergamon | 293200013231 | stuk | 1012,40 | 073 | 1 | | |
| 0341986 | 180x80x47cm z. poten zelfreinigend | wit | 293300013001 | stuk | 1229,40 | 073 | 1 |  | |
| 0341987 | 180x80x47cm z. poten zelfreinigend | pergamon | 293300013231 | stuk | 1229,40 | 073 | 1 | | |
| 0341649 | badpoten per set | | 581670000000 | stuk | 49,00 | 073 | 1 | | |

| Art.nr | Specificaties | Kleur | Lev.nr | Ehd | Prijs | Grp | CC |
|--------|---------------|-------|--------|-----|-------|-----|----|
|--------|---------------|-------|--------|-----|-------|-----|----|

Kaldewei Centro Duo

plaatstaal bad dikwandig zeshoekig

| | | | | | | | |
|---------|------------------------------------|----------|--------------|------|---------|-----|---|
| 0341988 | 200x75x47cm z. poten zelfreinigend | wit | 293400013001 | stuk | 2169,40 | 073 | 1 |
| 0341989 | 200x75x47cm z. poten zelfreinigend | pergamon | 293400013231 | stuk | 2169,40 | 073 | 1 |
| 0340960 | badpoten per set universeel | | 0340960 | stuk | 38,00 | 073 | 0 |



Kaldewei Classic Duo

plaatstaal bad dikwandig rechthoekig

| | | | | | | | |
|---------|----------------------|----------|--------------|------|--------|-----|---|
| 0341990 | 160x70x43cm z. poten | wit | 290300010001 | stuk | 502,40 | 073 | 1 |
| 0341991 | 160x70x43cm z. poten | pergamon | 290300010231 | stuk | 560,40 | 073 | 1 |
| 0341992 | 170x70x43cm z. poten | wit | 290500010001 | stuk | 502,40 | 073 | 1 |
| 0341993 | 170x70x43cm z. poten | pergamon | 290500010231 | stuk | 560,40 | 073 | 1 |
| 0341994 | 170x75x43cm z. poten | wit | 290700010001 | stuk | 502,40 | 073 | 1 |
| 0341995 | 170x75x43cm z. poten | pergamon | 290700010231 | stuk | 560,40 | 073 | 1 |
| 0341996 | 180x75x43cm z. poten | wit | 290900010001 | stuk | 594,40 | 073 | 1 |
| 0341997 | 180x75x43cm z. poten | pergamon | 290900010231 | stuk | 663,00 | 073 | 1 |
| 0341998 | 180x80x43cm z. poten | wit | 291000010001 | stuk | 594,40 | 073 | 1 |
| 0341999 | 180x80x43cm z. poten | pergamon | 291000010231 | stuk | 663,00 | 073 | 1 |
| 0341649 | badpoten per set | | 581670000000 | stuk | 49,00 | 073 | 1 |



Kaldewei Conoduo

plaatstaal bad dikwandig rechthoekig

| | | | | | | | |
|---------|-------------------------------------|----------|--------------|------|---------|-----|---|
| 0342530 | 170x75x43cm z. poten zelfreinigend | wit | 235000013001 | stuk | 858,00 | 073 | 1 |
| 0342531 | 170x75x43cm z. poten zelfreinigend | pergamon | 235000013231 | stuk | 858,00 | 073 | 1 |
| 0341970 | 180x80x43cm z. poten zelfreinigend | wit | 235100013001 | stuk | 1040,40 | 073 | 0 |
| 0341971 | 180x80x43cm z. poten zelfreinigend | pergamon | 235100013231 | stuk | 1040,40 | 073 | 1 |
| 0342532 | 190x90x43cm z. poten zelfreinigend | wit | 235200013001 | stuk | 1382,00 | 073 | 1 |
| 0342533 | 190x90x43cm z. poten zelfreinigend | pergamon | 235200013231 | stuk | 1382,00 | 073 | 1 |
| 0342534 | 200x100x43cm z. poten zelfreinigend | wit | 235300013001 | stuk | 1598,00 | 073 | 1 |
| 0342535 | 200x100x43cm z. poten zelfreinigend | pergamon | 235300013231 | stuk | 1598,00 | 073 | 1 |



afvoer-/ overloopgarnituur

| | | | | | | | |
|---------|--|----------|--------------|------|--------|-----|---|
| 0341972 | | wit | 687770553001 | stuk | 157,00 | 073 | 0 |
| 0341973 | | pergamon | 687770553231 | stuk | 157,00 | 073 | 1 |

badvul- /afvoer-/ overloopcombinatie

| | | | | | | | |
|---------|--|----------|--------------|------|--------|-----|---|
| 0342536 | | wit | 687770570001 | stuk | 334,00 | 073 | 1 |
| 0342537 | | pergamon | 687770570231 | stuk | 334,00 | 073 | 1 |

Kaldewei Corpo Duo

bad plaatstaal dikwandig rechthoekig

| | | | | | | | |
|---------|-------------------------------------|----------|--------------|------|---------|-----|---|
| 0340147 | 190x100x43.5 z. poten zelfreinigend | wit | 225000013001 | stuk | 2934,00 | 073 | 1 |
| 0340148 | 190x100x43.5 z. poten zelfreinigend | pergamon | 225000013231 | stuk | 2934,00 | 073 | 1 |
| 0341820 | badpoten voor Corpoline/ - Star | | 582570000000 | stuk | 117,00 | 073 | 1 |



Kaldewei Corpo Duo Star

bad plaatstaal dikwandig rechthoekig m. greepmontage

| | | | | | | | |
|---------|--|----------|--------------|------|---------|-----|---|
| 0340149 | 190x100x43.5 z. greep z. poten zelfreinigend | wit | 225100013001 | stuk | 2934,00 | 073 | 1 |
| 0340150 | 190x100x43.5 z. greep z. poten zelfreinigend | pergamon | 225100013231 | stuk | 2934,00 | 073 | 1 |
| 0341760 | grepen los voor montage chroom | | 585270000999 | stuk | 215,00 | 073 | 1 |
| 0341820 | badpoten voor Corpoline/ - Star | | 582570000000 | stuk | 117,00 | 073 | 1 |

grepen los voor montage

| | | | | | | | |
|---------|--|--------|--------------|------|--------|-----|---|
| 0341760 | | chroom | 585270000999 | stuk | 215,00 | 073 | 1 |
|---------|--|--------|--------------|------|--------|-----|---|

Kaldewei Duo Pool

bad plaatstaal dikwandig

| | | | | | | | |
|---------|---|----------|--------------|------|---------|-----|---|
| 0341775 | 150x100x50 z. poten zelfreinigend | wit | 222700013001 | stuk | 1745,00 | 073 | 1 |
| 0341776 | 150x100x50 z. poten zelfreinigend | pergamon | 222700013231 | stuk | 1745,00 | 073 | 1 |
| 0341777 | 150x100x50 z. poten zelfreinigend m. pan. | wit | 222748033001 | stuk | 2483,00 | 073 | 1 |
| 0341778 | 150x100x50 z. poten zelfreinigend m. pan. | pergamon | 222748033231 | stuk | 2483,00 | 073 | 1 |
| 0341779 | 150x100x50 z. poten zelfreinigend m. pan. | wit | 222748173001 | stuk | 3028,00 | 073 | 1 |
| 0341780 | 150x100x50 z. poten zelfreinigend m. pan. | pergamon | 222748173231 | stuk | 3365,00 | 073 | 1 |
| 0341822 | badpoten voor Duopool | | 583370000000 | stuk | 117,00 | 073 | 1 |



| Art.nr | Specificaties | Kleur | Lev.nr | Ehd | Prijs | Grp | CC |
|--------|---------------|-------|--------|-----|-------|-----|----|
|--------|---------------|-------|--------|-----|-------|-----|----|

Kaldewei Dyna Duo

| bad plaatstaal dikwandig rechthoekig | | | | | | | |
|---|------------------------------------|----------|--------------|------|--------|-----|---|
| 0341696 | 170x75x43cm z. poten | wit | 226000010001 | stuk | 578,00 | 073 | 1 |
| 0341697 | 170x75x43cm z. poten | pergamon | 226000010231 | stuk | 670,00 | 073 | 1 |
| 0340151 | 170x75x43cm z. poten zelfreinigend | wit | 226000013001 | stuk | 728,00 | 073 | 1 |
| 0340152 | 170x75x43cm z. poten zelfreinigend | pergamon | 226000013231 | stuk | 819,00 | 073 | 1 |
| 0340650 | 180x80x45cm z. poten | wit | 226300010001 | stuk | 769,00 | 073 | 1 |
| 0353140 | 180x80x45cm z. poten | pergamon | 226300010231 | stuk | 769,00 | 073 | 1 |
| 0340153 | 180x80x45cm z. poten zelfreinigend | wit | 226300013001 | stuk | 918,00 | 073 | 1 |
| 0340155 | 180x80x45cm z. poten zelfreinigend | pergamon | 226300013231 | stuk | 918,00 | 073 | 1 |
| 0341533 | badpoten universeel 5047 per set | | 5047 | stuk | 17,75 | 061 | 0 |



Sanitair producten

Baden /
douchebakken /
stoomcabines

Kaldewei Dyna

| bad plaatstaal dikwandig rechthoekig | | | | | | | |
|---|------------------------------------|----------|--------------|------|---------|-----|---|
| 0340022 | 170x75x43cm z. poten | wit | 224000010001 | stuk | 417,00 | 073 | 1 |
| 0341681 | 170x75x43cm z. poten | pergamon | 224000010231 | stuk | 499,00 | 073 | 1 |
| 0340156 | 170x75x43cm z. poten zelfreinigend | wit | 224000013001 | stuk | 567,00 | 073 | 1 |
| 0340157 | 170x75x43cm z. poten zelfreinigend | pergamon | 224000013231 | stuk | 648,00 | 073 | 1 |
| 0341709 | 190x75x43cm z. poten | wit | 224200010001 | stuk | 1025,00 | 073 | 1 |
| 0341710 | 190x75x43cm z. poten | pergamon | 224200010231 | stuk | 1165,00 | 073 | 1 |
| 0340158 | 190x75x43cm z. poten zelfreinigend | wit | 224200013001 | stuk | 1174,00 | 073 | 1 |
| 0340159 | 190x75x43cm z. poten zelfreinigend | pergamon | 224200013231 | stuk | 1315,00 | 073 | 1 |
| 0341533 | badpoten universeel 5047 per set | | 5047 | stuk | 17,75 | 061 | 0 |



Kranen

Douchegarnituur

Accessoires en
spiegels

Kaldewei Dyna Star

| bad plaatstaal dikwandig rechthoekig m. greepmontage | | | | | | | |
|---|---|----------|--------------|------|---------|-----|---|
| 0341707 | 170x75x43cm z. greep z. poten | wit | 224100010001 | stuk | 417,00 | 073 | 1 |
| 0341708 | 170x75x43cm z. greep z. poten | pergamon | 224100010231 | stuk | 499,00 | 073 | 1 |
| 0340161 | 170x75x43cm z. greep z. poten zelfreinigend | wit | 224100013001 | stuk | 567,00 | 073 | 1 |
| 0340164 | 170x75x43cm z. greep z. poten zelfreinigend | pergamon | 224100013231 | stuk | 648,00 | 073 | 1 |
| 0341712 | 190x75x43cm z. greep z. poten | wit | 224300010001 | stuk | 1025,00 | 073 | 1 |
| 0341713 | 190x75x43cm z. greep z. poten | pergamon | 224300010231 | stuk | 1165,00 | 073 | 1 |
| 0340165 | 190x75x43cm z. greep z. poten zelfreinigend | wit | 224300013001 | stuk | 1174,00 | 073 | 1 |
| 0340166 | 190x75x43cm z. greep z. poten zelfreinigend | pergamon | 224300013231 | stuk | 1314,00 | 073 | 1 |
| 0341533 | badpoten universeel 5047 per set | | 5047 | stuk | 17,75 | 061 | 0 |
| 0341714 | grepen voor Dyna Star chroom | | 585170000999 | stuk | 120,00 | 073 | 1 |

Douchewanden

Toebehoren &
afvoeren

Spoel- &
installatiesystemen

Kaldewei Dyna Set

| bad plaatstaal dikwandig rechthoekig | | | | | | | |
|---|------------------------------------|----------|--------------|------|--------|-----|---|
| 0340669 | 170x75x43cm z. poten | wit | 226100010001 | stuk | 670,00 | 073 | 1 |
| 0353159 | 170x75x43cm z. poten | pergamon | 226100010231 | stuk | 747,00 | 073 | 1 |
| 0340167 | 170x75x43cm z. poten zelfreinigend | wit | 226100013001 | stuk | 819,00 | 073 | 1 |
| 0340168 | 170x75x43cm z. poten zelfreinigend | pergamon | 226100013231 | stuk | 897,00 | 073 | 1 |
| 0341702 | 180x80x43cm z. poten | wit | 226400010001 | stuk | 771,00 | 073 | 1 |
| 0341704 | 180x80x43cm z. poten | pergamon | 226400010231 | stuk | 771,00 | 073 | 1 |
| 0340169 | 180x80x43cm z. poten zelfreinigend | wit | 226400013001 | stuk | 920,00 | 073 | 1 |
| 0340170 | 180x80x43cm z. poten zelfreinigend | pergamon | 226400013231 | stuk | 920,00 | 073 | 1 |
| 0341698 | 160x70x43cm z. poten | wit | 226800010001 | stuk | 670,00 | 073 | 1 |
| 0341699 | 160x70x43cm z. poten | pergamon | 226800010231 | stuk | 747,00 | 073 | 1 |
| 0340171 | 160x70x43cm z. poten zelfreinigend | wit | 226800013001 | stuk | 819,00 | 073 | 1 |
| 0340172 | 160x70x43cm z. poten zelfreinigend | pergamon | 226800013231 | stuk | 897,00 | 073 | 1 |
| 0341533 | badpoten universeel 5047 per set | | 5047 | stuk | 17,75 | 061 | 0 |



Badkamermeubelen
en toiletkasten

Gootstenen en
wastroggen

Utiliteit

Kaldewei Dyna Set Star







| bad plaatstaal dikwandig rechthoekig m. greepmontage | | | | | | | |
|---|---|----------|--------------|------|--------|-----|---|
| 0341700 | 170x75x43cm z. greep z. poten | wit | 226200010001 | stuk | 670,00 | 073 | 1 |
| 0341701 | 170x75x43cm z. greep z. poten | pergamon | 226200010231 | stuk | 747,00 | 073 | 1 |
| 0340173 | 170x75x43cm z. greep z. poten zelfreinigend | wit | 226200013001 | stuk | 819,00 | 073 | 1 |
| 0340174 | 170x75x43cm z. greep z. poten zelfreinigend | pergamon | 226200013231 | stuk | 897,00 | 073 | 1 |
| 0341705 | 180x80x43cm z. greep z. poten | wit | 226500010001 | stuk | 771,00 | 073 | 1 |
| 0341706 | 180x80x43cm z. greep z. poten | pergamon | 226500010231 | stuk | 771,00 | 073 | 1 |
| 0340175 | 180x80x43cm z. greep z. poten zelfreinigend | wit | 226500013001 | stuk | 920,00 | 073 | 1 |
| 0340176 | 180x80x43cm z. greep z. poten zelfreinigend | pergamon | 226500013231 | stuk | 920,00 | 073 | 1 |
| 0341533 | badpoten universeel 5047 per set | | 5047 | stuk | 17,75 | 061 | 0 |
| 0341824 | set badgrepen voor Dynasetstar chroom | | 585570000999 | stuk | 120,00 | 073 | 1 |

Kaldewei Ergonova Duo



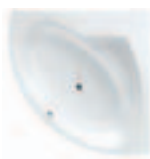

| bad plaatstaal dikwandig rechthoekig | | | | | | | |
|---|------------------------------------|----------|--------------|------|---------|-----|---|
| 0340177 | 190x90x45cm z. poten zelfreinigend | wit | 222100013001 | stuk | 1709,00 | 073 | 1 |
| 0340178 | 190x90x45cm z. poten zelfreinigend | pergamon | 222100013231 | stuk | 1815,00 | 073 | 1 |
| 0341533 | badpoten universeel 5047 per set | | 5047 | stuk | 17,75 | 061 | 0 |



| | Art.nr | Specificaties | Kleur | Lev.nr | Ehd | Prijs | Grp | CC |
|----------------------------------|---|--------------------------------------|---------------------------------|--------------|--------------|---------|---------|-------|
| Sanitair producten | Kaldewei Saniform Plus Star | | | | | | | |
| | bad plaatstaal dikwandig rechthoekig m. greepmontage | | | | | | | |
| | 0341690 | 170x70x41cm | z. greep z. poten | wit | 133500010001 | stuk | 243,00 | 073 1 |
| | 0341691 | 170x70x41cm | z. greep z. poten | pergamon | 133500010231 | stuk | 371,00 | 073 1 |
| | 0340179 | 170x70x41cm | z. greep z. poten zelfreinigend | wit | 133500013001 | stuk | 393,00 | 073 1 |
| | 0340180 | 170x70x41cm | z. greep z. poten zelfreinigend | pergamon | 133500013231 | stuk | 521,00 | 073 1 |
| | 0341688 | 160x75x41cm | z. greep z. poten | wit | 133300010001 | stuk | 243,00 | 073 1 |
| | 0341689 | 160x75x41cm | z. greep z. poten | pergamon | 133300010231 | stuk | 369,00 | 073 1 |
| | 0340181 | 160x75x41cm | z. greep z. poten zelfreinigend | wit | 133300013001 | stuk | 393,00 | 073 1 |
| | 0340182 | 160x75x41cm | z. greep z. poten zelfreinigend | pergamon | 133300013231 | stuk | 519,00 | 073 1 |
| Kranen | 0341533 | badpoten universeel 5047 | per set | 5047 | stuk | 17,75 | 061 0 | |
| | 0341714 | grepen voor Dyna Star | chrom | 585170000999 | stuk | 120,00 | 073 1 | |
| Douchegarnituur | Kaldewei Kusatsu Pool | | | | | | | |
| | bad plaatstaal dikwandig ovaal | | | | | | | |
| | 0341781 | 140x100x81 | zelfreinigend z. poten | wit | 229900013001 | stuk | 4842,00 | 073 1 |
| | 0341782 | 140x100x81 | zelfreinigend z. poten | pergamon | 229900013231 | stuk | 4842,00 | 073 1 |
| | 0341826 | badpoten voor Kusatsupool | | | 581970000000 | stuk | 135,00 | 073 1 |
| | 0341828 | Rotexa2000 afvoer voor Kusatsupool | chrom | | 688374490999 | stuk | 123,00 | 073 1 |
| Accessoires en spiegels | 0341830 | Rotexa Multi afvoer voor Kusatsupool | chrom | | 688474500999 | stuk | 293,00 | 073 1 |
| | Kaldewei Mega Duo | | | | | | | |
| Douchewanden | bad plaatstaal dikwandig rechthoekig | | | | | | | |
| | 0341783 | 180x90x45cm | zelfreinigend z. poten | wit | 223400013001 | stuk | 1424,00 | 073 0 |
| | 0341784 | 180x90x45cm | zelfreinigend z. poten | pergamon | 223400013231 | stuk | 1424,00 | 073 1 |
| Toebehoren & afvoeren | 0341533 | badpoten universeel 5047 | per set | 5047 | stuk | 17,75 | 061 0 | |
| | bad plaatstaal dikwandig ovaal | | | | | | | |
| | 0342337 | 180x90x45cm | z. poten z. mantel | wit | 223800013001 | stuk | 1701,00 | 073 1 |
| | 0342338 | 180x90x45cm | z. poten z. mantel | pergamon | 223800013231 | stuk | 1701,00 | 073 1 |
| | 0342339 | 180x90x45cm | z. poten m. mantel | wit | 223848053001 | stuk | 4013,00 | 073 1 |
| 0342340 | 180x90x45cm | z. poten m. mantel | pergamon | 223848053231 | stuk | 4311,00 | 073 1 | |
| 0341533 | badpoten universeel 5047 | per set | 5047 | stuk | 17,75 | 061 0 | | |
| Spoel- & installatiesystemen | Kaldewei Mega Duo 6 | | | | | | | |
| | bad plaatstaal dikwandig zeshoekig | | | | | | | |
| | 0341614 | 214x90x45cm | z. poten | wit | 223600013001 | stuk | 2339,00 | 073 1 |
| Badkamermeubelen en toiletkasten | 0341657 | 214x90x45cm | z. poten | pergamon | 223600013231 | stuk | 2339,00 | 073 1 |
| | 0341533 | badpoten universeel 5047 | per set | 5047 | stuk | 17,75 | 061 0 | |
| Gootstenen en wastroggen | Kaldewei Novola | | | | | | | |
| | bad plaatstaal dikwandig rechthoekig | | | | | | | |
| | 0341719 | 170x75x43cm | z. poten | wit | 242000010001 | stuk | 504,00 | 073 1 |
| | 0341720 | 170x75x43cm | z. poten | pergamon | 242000010231 | stuk | 564,00 | 073 1 |
| | 0340188 | 170x75x43cm | z. poten zelfreinigend | wit | 242000013001 | stuk | 654,00 | 073 1 |
| | 0340189 | 170x75x43cm | z. poten zelfreinigend | pergamon | 242000013231 | stuk | 713,00 | 073 1 |
| Utiliteit | 0341717 | 180x80x43cm | z. poten | wit | 242200010001 | stuk | 670,00 | 073 1 |
| | 0341718 | 180x80x43cm | z. poten | pergamon | 242200010231 | stuk | 749,00 | 073 1 |
| | 0340190 | 180x80x43cm | z. poten zelfreinigend | wit | 242200013001 | stuk | 819,00 | 073 1 |
| | 0340191 | 180x80x43cm | z. poten zelfreinigend | pergamon | 242200013231 | stuk | 899,00 | 073 1 |
| 0341533 | badpoten universeel 5047 | per set | 5047 | stuk | 17,75 | 061 0 | | |
| Badkamermeubelen en toiletkasten | Kaldewei Novola Star / Duo Star | | | | | | | |
| | bad plaatstaal dikwandig rechthoekig m. greepmontage | | | | | | | |
| | 0340184 | 170x75x44cm | z. greep z. poten | wit | 241600010001 | stuk | 504,00 | 073 1 |
| | 0340185 | 170x75x44cm | z. greep z. poten | pergamon | 241600010231 | stuk | 564,00 | 073 1 |
| | 0340192 | 170x75x44cm | z. greep z. poten zelfreinigend | wit | 241600013001 | stuk | 654,00 | 073 1 |
| | 0340193 | 170x75x44cm | z. greep z. poten zelfreinigend | pergamon | 241600013231 | stuk | 713,00 | 073 1 |
| | 0340186 | 180x80x44cm | z. greep z. poten | wit | 241700010001 | stuk | 670,00 | 073 1 |
| | 0340187 | 180x80x44cm | z. greep z. poten | pergamon | 241700010231 | stuk | 749,00 | 073 1 |
| | 0340194 | 180x80x44cm | z. greep z. poten zelfreinigend | wit | 241700013001 | stuk | 819,00 | 073 1 |
| | 0340195 | 180x80x44cm | z. greep z. poten zelfreinigend | pergamon | 241700013231 | stuk | 899,00 | 073 1 |
| | 0340259 | set grepen 5884 voor Novola Duo Star | | | 588470000999 | stuk | 145,00 | 073 1 |
| | 0341533 | badpoten universeel 5047 | per set | 5047 | stuk | 17,75 | 061 0 | |
| | set grepen 5884 voor Novola Duo Star | | | | | | | |
| | 0340259 | | | | 588470000999 | stuk | 145,00 | 073 1 |

| Art.nr | Specificaties | Kleur | Lev.nr | Ehd | Prijs | Grp | CC | | |
|---|---|----------|--------------|------|---------|-----|----|---|----------------------------------|
| | | | | | | | | Kaldewei Novola Duo 6 | |
| bad plaatstaal dikwandig zeshoekig | | | | | | | | | |
| 0341715 | 210x80x44cm z. poten | wit | 242400010001 | stuk | 1019,00 | 073 | 1 |  | Sanitair producten |
| 0341716 | 210x80x44cm z. poten | pergamon | 242400010231 | stuk | 1138,00 | 073 | 1 | | |
| 0340202 | 210x80x44cm z. poten zelfreinigend | wit | 242400013001 | stuk | 1169,00 | 073 | 1 | | |
| 0340203 | 210x80x44cm z. poten zelfreinigend | pergamon | 242400013231 | stuk | 1287,00 | 073 | 1 | | |
| 0341533 | badpoten universeel 5047 per set | | 5047 | stuk | 17,75 | 061 | 0 | | |
| | | | | | | | | Kaldewei Novola Duo 6 Star | |
| bad plaatstaal dikwandig zeshoekig m. greepmontage | | | | | | | | | |
| 0340200 | 210x80x44cm z. greep z. poten | wit | 241800010001 | stuk | 1019,00 | 073 | 1 | | |
| 0340201 | 210x80x44cm z. greep z. poten | pergamon | 241800010231 | stuk | 1138,00 | 073 | 1 | | |
| 0340204 | 210x80x44cm z. greep z. poten zelfreinigend | wit | 241800013001 | stuk | 1169,00 | 073 | 1 | | Kranen |
| 0340206 | 210x80x44cm z. greep z. poten zelfreinigend | pergamon | 241800013231 | stuk | 1287,00 | 073 | 1 | | |
| 0341533 | badpoten universeel 5047 per set | | 5047 | stuk | 17,75 | 061 | 0 | | |
| | | | | | | | | Kaldewei Novola Duo Oval | |
| bad plaatstaal dikwandig ovaal | | | | | | | | | |
| 0340196 | 180x80x44cm z. poten | wit | 242800010001 | stuk | 890,00 | 073 | 1 |  | Douchegarnituur |
| 0340197 | 180x80x44cm z. poten | pergamon | 242800010231 | stuk | 990,00 | 073 | 1 | | |
| 0340198 | 180x80x44cm z. poten zelfreinigend | wit | 242800013001 | stuk | 1039,00 | 073 | 1 | | |
| 0340199 | 180x80x44cm z. poten zelfreinigend | pergamon | 242800013231 | stuk | 1140,00 | 073 | 1 | | Accessoires en spiegels |
| 0341533 | badpoten universeel 5047 per set | | 5047 | stuk | 17,75 | 061 | 0 | | |
| | | | | | | | | Kaldewei Punta Duo 3 | |
| hoekbad plaatstaal dikwandig | | | | | | | | | |
| 0341771 | 140x140x45 z. poten zelfreinigend | wit | 228300013001 | stuk | 2319,00 | 073 | 1 |  | Douchewanden |
| 0341772 | 140x140x45 z. poten zelfreinigend | pergamon | 228300013231 | stuk | 2319,00 | 073 | 1 | | |
| 0341773 | 140x140x45 z. poten zelfreinigend m. pan. | wit | 228348033001 | stuk | 3294,00 | 073 | 1 | | |
| 0341774 | 140x140x45 z. poten zelfreinigend m. pan. | pergamon | 228348033231 | stuk | 3426,00 | 073 | 1 | | |
| 0342357 | badpoten per set | | 583170000000 | stuk | 49,00 | 073 | 0 | | Toebehoren & afvoeren |
| | | | | | | | | Kaldewei Retro | |
| bad plaatstaal dikwandig rechthoekig | | | | | | | | | |
| 0341748 | 190x90x45cm z. poten | wit | 228400010001 | stuk | 1476,00 | 073 | 1 |  | Spoe- & installatiesystemen |
| 0341749 | 190x90x45cm z. poten | pergamon | 228400010231 | stuk | 1476,00 | 073 | 1 | | |
| 0340207 | 190x90x45cm z. poten zelfreinigend | wit | 228400013001 | stuk | 1626,00 | 073 | 1 | | |
| 0340208 | 190x90x45cm z. poten zelfreinigend | pergamon | 228400013231 | stuk | 1626,00 | 073 | 1 | | |
| 0341649 | badpoten per set | | 581670000000 | stuk | 49,00 | 073 | 1 | | Badkamermeubelen en toiletkasten |
| | | | | | | | | Kaldewei Retro Star | |
| bad plaatstaal dikwandig rechthoekig m. greepmontage | | | | | | | | | |
| 0341750 | 190x90x45cm z. greep z. poten | wit | 228500010001 | stuk | 1476,00 | 073 | 1 | | |
| 0341751 | 190x90x45cm z. greep z. poten | pergamon | 228500010231 | stuk | 1476,00 | 073 | 1 | | |
| 0340209 | 190x90x45cm z. greep z. poten zelfreinigend | wit | 228500013001 | stuk | 1626,00 | 073 | 1 | | Gootstenen en wastroggen |
| 0340210 | 190x90x45cm z. greep z. poten zelfreinigend | pergamon | 228500013231 | stuk | 1626,00 | 073 | 1 | | |
| 0341649 | badpoten per set | | 581670000000 | stuk | 49,00 | 073 | 1 | | |
| 0341752 | grepen los voor montage chroom | | 585970000999 | stuk | 186,00 | 073 | 1 | | Utiliteit |
| | | | | | | | | Kaldewei Retro 6 | |
| bad plaatstaal dikwandig zeshoekig | | | | | | | | | |
| 0341745 | 190x80x45cm z. poten | wit | 228800010001 | stuk | 1878,00 | 073 | 1 |  | |
| 0341747 | 190x80x45cm z. poten | pergamon | 228800010231 | stuk | 1878,00 | 073 | 1 | | |
| 0341649 | badpoten per set | | 581670000000 | stuk | 49,00 | 073 | 1 | | |
| | | | | | | | | Kaldewei Retro 8 | |
| bad plaatstaal dikwandig achthoekig | | | | | | | | | |
| 0341743 | 180x90x45cm z. poten | wit | 228600010001 | stuk | 1982,00 | 073 | 1 |  | |
| 0341744 | 180x90x45cm z. poten | pergamon | 228600010231 | stuk | 1982,00 | 073 | 1 | | |
| 0340216 | 180x90x45cm z. poten zelfreinigend | wit | 228600013001 | stuk | 2132,00 | 073 | 1 | | |
| 0340217 | 180x90x45cm z. poten zelfreinigend | pergamon | 228600013231 | stuk | 2132,00 | 073 | 1 | | |
| 0341649 | badpoten per set | | 581670000000 | stuk | 49,00 | 073 | 1 | | |
| | | | | | | | | Kaldewei Retro 8 Star | |
| bad plaatstaal dikwandig achthoekig m. greepmontage | | | | | | | | | |
| 0340212 | 180x90x45cm z. greep z. poten | wit | 228700010001 | stuk | 1982,00 | 073 | 1 | | |
| 0340213 | 180x90x45cm z. greep z. poten | pergamon | 228700010231 | stuk | 1982,00 | 073 | 1 | | |
| 0340214 | 180x90x45cm z. greep z. poten zelfreinigend | wit | 228700013001 | stuk | 2132,00 | 073 | 1 | | |
| 0340215 | 180x90x45cm z. greep z. poten zelfreinigend | pergamon | 228700013231 | stuk | 2132,00 | 073 | 1 | | |
| 0341649 | badpoten per set | | 581670000000 | stuk | 49,00 | 073 | 1 | | |
| 0341752 | grepen los voor montage chroom | | 585970000999 | stuk | 186,00 | 073 | 1 | | |

| | Art.nr | Specificaties | Kleur | Lev.nr | Ehd | Prijs | Grp | CC | |
|---|---|---|----------------------|--------------|--------------|---------|---------|-----|---|
| Sanitair producten | Kaldewei Rondo | | | | | | | | |
| | bad plaatstaal dikwandig rechthoekig | | | | | | | | |
| | 0341509 | 170x75x44cm z. poten | wit | 221500010001 | stuk | 773,00 | 073 | 0 | |
| | 0354929 | 170x75x44cm z. poten | pergamon | 221500010231 | stuk | 773,00 | 073 | 1 | |
| | 0341517 | 180x80x44cm z. poten | wit | 221700010001 | stuk | 963,00 | 073 | 0 | |
| Baden / douchebakken / stoomcabines | 0354937 | 180x80x44cm z. poten | pergamon | 221700010231 | stuk | 963,00 | 073 | 1 | |
| | 0341606 | 180x80x44cm z. poten Starylan | wit | 700300010001 | stuk | 1325,00 | 073 | 1 | |
| | 0341608 | 180x80x44cm z. poten Starylan | pergamon | 700300010231 | stuk | 1325,00 | 073 | 1 | |
| | 0341533 | badpoten universeel 5047 per set | | 5047 | stuk | 17,75 | 061 | 0 | |
| | Kranen | Kaldewei Rondostar | | | | | | | |
| bad plaatstaal dikwandig rechthoekig m. greepmontage | | | | | | | | | |
| 0341737 | | 170x75x44cm z. greep z. poten | wit | 221600010001 | stuk | 773,00 | 073 | 1 | |
| 0341739 | | 170x75x44cm z. greep z. poten | pergamon | 221600010231 | stuk | 773,00 | 073 | 1 | |
| 0341740 | | 180x80x44cm z. greep z. poten | wit | 221800010001 | stuk | 963,00 | 073 | 1 | |
| Douchegarnituur | 0341741 | 180x80x44cm z. greep z. poten | pergamon | 221800010231 | stuk | 963,00 | 073 | 1 | |
| | 0341533 | badpoten universeel 5047 per set | | 5047 | stuk | 17,75 | 061 | 0 | |
| | 0341742 | grepen voor diverse modellen chroom | | 586770000999 | stuk | 157,00 | 073 | 1 | |
| | Accessoires en spiegels | Kaldewei Rondo 6 | | | | | | | |
| | | bad plaatstaal dikwandig zeshoekig | | | | | | | |
| 0341735 | | 197x75x44cm z. poten | wit | 227100010001 | stuk | 1734,00 | 073 | 1 | |
| 0341736 | | 197x75x44cm z. poten | pergamon | 227100010231 | stuk | 1734,00 | 073 | 1 | |
| 0341835 | | 206x80x44cm z. poten | wit | 227300010001 | stuk | 1831,00 | 073 | 1 | |
| Douchewanden | 0341827 | 206x80x44cm z. poten | pergamon | 227300010231 | stuk | 1831,00 | 073 | 1 | |
| | 0341533 | badpoten universeel 5047 per set | | 5047 | stuk | 17,75 | 061 | 0 | |
| | Toebehoren & afvoeren | Kaldewei Rondo 8 | | | | | | | |
| | | bad plaatstaal dikwandig achthoekig | | | | | | | |
| | | 0341731 | 170x75x44cm z. poten | wit | 227500010001 | stuk | 1734,00 | 073 | 1 |
| 0341732 | | 170x75x44cm z. poten | pergamon | 227500010231 | stuk | 1734,00 | 073 | 1 | |
| 0341733 | | 180x80x44cm z. poten | wit | 227700010001 | stuk | 1831,00 | 073 | 1 | |
| Spoel- & installatiesystemen | 0341734 | 180x80x44cm z. poten | pergamon | 227700010231 | stuk | 1831,00 | 073 | 1 | |
| | 0341533 | badpoten universeel 5047 per set | | 5047 | stuk | 17,75 | 061 | 0 | |
| | Badkamermeubelen en toiletkasten | Kaldewei Saniform Medium | | | | | | | |
| | | bad plaatstaal dikwandig rechthoekig | | | | | | | |
| | | 0341686 | 170x70x31.5 z. poten | wit | 220300010001 | stuk | 490,00 | 073 | 1 |
| 0341687 | | 170x70x31.5 z. poten | pergamon | 220300010231 | stuk | 490,00 | 073 | 1 | |
| 0340218 | | 170x70x31.5 z. poten zelfreinigend | wit | 220300013001 | stuk | 639,00 | 073 | 1 | |
| Gootstenen en wastroggen | 0340219 | 170x70x31.5 z. poten zelfreinigend | pergamon | 220300013231 | stuk | 639,00 | 073 | 1 | |
| | 0341533 | badpoten universeel 5047 per set | | 5047 | stuk | 17,75 | 061 | 0 | |
| | Utiliteit | Kaldewei Saniform Plus | | | | | | | |
| | | bad plaatstaal dikwandig rechthoekig | | | | | | | |
| | | 0340332 | 160x75x41cm z. poten | wit | 112500010001 | stuk | 224,00 | 073 | 1 |
| 0353027 | | 160x75x41cm z. poten | pergamon | 112500010231 | stuk | 350,00 | 073 | 1 | |
| 0345565 | | 170x70x41cm z. poten | wit | 111800010001 | stuk | 193,00 | 073 | 1 | |
| 0342327 | | 170x70x41cm z. poten | pergamon | 111800010231 | stuk | 351,00 | 073 | 1 | |
| 0340952 | | 170x75x41cm z. poten | wit | 112600010001 | stuk | 189,00 | 073 | 0 | |
| 0354198 | | 170x75x41cm z. poten | pergamon | 112600010231 | stuk | 290,00 | 073 | 0 | |
| 0340865 | | 170x75x41cm z. poten m. antislip | wit | 112630000001 | stuk | 312,00 | 073 | 1 | |
| 0342335 | | 170x75x41cm z. poten m. antislip | pergamon | 112630000231 | stuk | 413,00 | 073 | 1 | |
| 0341495 | | 180x80x43cm z. poten | wit | 112800010001 | stuk | 315,00 | 073 | 0 | |
| Utiliteit | 0342343 | 180x80x43cm z. poten | pergamon | 112800010231 | stuk | 431,00 | 073 | 0 | |
| | 0341533 | badpoten universeel 5047 per set | | 5047 | stuk | 17,75 | 061 | 0 | |
| | Utiliteit | Kaldewei Sanilux | | | | | | | |
| | | bad plaatstaal dikwandig rechthoekig | | | | | | | |
| | | 0341682 | 170x75x43cm z. poten | wit | 113200010001 | stuk | 242,00 | 073 | 1 |
| 0341683 | | 170x75x43cm z. poten | pergamon | 113200010231 | stuk | 343,00 | 073 | 1 | |
| 0341533 | | badpoten universeel 5047 per set | | 5047 | stuk | 17,75 | 061 | 0 | |
| Utiliteit | Kaldewei Saniluxstar | | | | | | | | |
| | bad plaatstaal dikwandig rechthoekig m. greepmontage | | | | | | | | |
| | 0341684 | 170x75x43cm z. greep z. poten | wit | 113300010001 | stuk | 242,00 | 073 | 1 | |
| | 0341685 | 170x75x43cm z. greep z. poten | pergamon | 113300010231 | stuk | 343,00 | 073 | 1 | |
| | 0341533 | badpoten universeel 5047 per set | | 5047 | stuk | 17,75 | 061 | 0 | |
| 0341742 | grepen voor diverse modellen chroom | | 586770000999 | stuk | 157,00 | 073 | 1 | | |

| Art.nr | Specificaties | Kleur | Lev.nr | Ehd | Prijs | Grp | CC | | | |
|---|-----------------------------|----------------------------------|----------|--------------|-------|---------|-----|---|---|--------------------------|
| Kaldewei Sento Star | | | | | | | |  | | |
| bad plaatstaal dikwandig rechthoekig m. greepmontage | | | | | | | | | | |
| 0341692 | 170x80x43cm | z. greep z. poten | wit | 221000010001 | stuk | 575,00 | 073 | 1 | Sanitair producten | |
| 0341693 | 170x80x43cm | z. greep z. poten | pergamon | 221000010231 | stuk | 659,00 | 073 | 1 | | |
| 0341694 | 180x80x43cm | z. greep z. poten | wit | 221100010001 | stuk | 647,00 | 073 | 1 | | |
| 0341695 | 180x80x43cm | z. greep z. poten | pergamon | 221100010231 | stuk | 762,00 | 073 | 1 | | |
| 0341533 | badpoten universeel 5047 | per set | | 5047 | stuk | 17,75 | 061 | 0 | Baden / douchebakken / stoomcabines | |
| 0341834 | set badgrepen voor Sanistar | chrom | | 585070000999 | stuk | 120,00 | 073 | 1 | | |
| Kaldewei Studio | | | | | | | |  | | |
| bad plaatstaal dikwandig links | | | | | | | | | | |
| 0341761 | 170x90x43cm | z. poten zelfreinigend | wit | 222800013001 | stuk | 1511,00 | 073 | 1 | Kranen | |
| 0341763 | 170x90x43cm | z. poten zelfreinigend | pergamon | 222800013231 | stuk | 1511,00 | 073 | 1 | | |
| 0341764 | 170x90x43cm | z. poten zelfreinigend m. pan. | wit | 222848033001 | stuk | 2546,00 | 073 | 1 | | |
| 0341765 | 170x90x43cm | z. poten zelfreinigend m. pan. | pergamon | 222848033231 | stuk | 2681,00 | 073 | 1 | | |
| 0342357 | badpoten per set | | | 583170000000 | stuk | 49,00 | 073 | 0 | Douchegarnituur | |
| bad plaatstaal dikwandig rechts | | | | | | | | | | |
| 0341766 | 170x90x43cm | z. poten zelfreinigend | wit | 222200013001 | stuk | 1511,00 | 073 | 1 | Accessoires en spiegels | |
| 0341767 | 170x90x43cm | z. poten zelfreinigend | pergamon | 222200013231 | stuk | 1511,00 | 073 | 1 | | |
| 0341768 | 170x90x43cm | z. poten zelfreinigend m. pan. | wit | 222248033001 | stuk | 2546,00 | 073 | 1 | | |
| 0341769 | 170x90x43cm | z. poten zelfreinigend m. pan. | pergamon | 222248033231 | stuk | 2681,00 | 073 | 1 | | |
| 0342357 | badpoten per set | | | 583170000000 | stuk | 49,00 | 073 | 0 | Kaldewei Twin Pool | |
| bad plaatstaal dikwandig zeshoekig | | | | | | | | | | |
| 0342378 | 170x100x47 | zelfreinigend | wit | 228100013001 | stuk | 1467,00 | 073 | 1 | Douchewanden | |
| 0342386 | 170x100x47 | zelfreinigend | pergamon | 228100013231 | stuk | 1467,00 | 073 | 1 | | |
| 0342357 | badpoten per set | | | 583170000000 | stuk | 49,00 | 073 | 0 | Kaldewei Vaio Duo | |
| bad plaatstaal dikwandig rechthoekig | | | | | | | | | | |
| 0342353 | 180x80x43cm | z.poten | wit | 233000010001 | stuk | 690,00 | 073 | 0 | | Toebehoren & afvoeren |
| 0342356 | 180x80x43cm | z.poten | pergamon | 233000010231 | stuk | 767,00 | 073 | 1 | | |
| 0340220 | 180x80x43cm | z. poten zelfreinigend | wit | 233000013001 | stuk | 839,00 | 073 | 1 | Spoel- & installatiesystemen | |
| 0340221 | 180x80x43cm | z. poten zelfreinigend | pergamon | 233000013231 | stuk | 917,00 | 073 | 1 | | |
| 0341533 | badpoten universeel 5047 | per set | | 5047 | stuk | 17,75 | 061 | 0 | | |
| Kaldewei Vaio Duo Oval | | | | | | | |  | | |
| bad plaatstaal dikwandig ovaal | | | | | | | | | | |
| 0342341 | 180x80x43cm | z. poten z. mantel | wit | 233100010001 | stuk | 909,00 | 073 | 1 | Badkamermeubelen en toiletkasten | |
| 0342342 | 180x80x43cm | z. poten z. mantel | pergamon | 233100010231 | stuk | 1012,00 | 073 | 1 | | |
| 0340222 | 180x80x43cm | z. poten z. mantel m. zelfrein. | wit | 233100013001 | stuk | 1059,00 | 073 | 1 | Gootstenen en wastroggen | |
| 0340223 | 180x80x43cm | z. poten z. mantel zelfreinigend | pergamon | 233100013231 | stuk | 1161,00 | 073 | 1 | | |
| 0342355 | 180x80x43cm | z. poten m. mantel | wit | 233148050001 | stuk | 2571,00 | 073 | 1 | | |
| 0342344 | 180x80x43cm | z. poten m. mantel | pergamon | 233148050231 | stuk | 2889,00 | 073 | 1 | | |
| 0340224 | 180x80x43cm | z. poten m. mantel m. zelfrein. | wit | 233148053001 | stuk | 2720,00 | 073 | 1 | | |
| 0340225 | 180x80x43cm | z. poten m. mantel m. zelfrein. | pergamon | 233148053231 | stuk | 3039,00 | 073 | 1 | | |
| 0341533 | badpoten universeel 5047 | per set | | 5047 | stuk | 17,75 | 061 | 0 | Kaldewei Vaio Duo 3 | |
| hoekbad plaatstaal dikwandig | | | | | | | | | | |
| 0342345 | 140x140x43 | z. poten z. mantel | wit | 234200010001 | stuk | 1620,00 | 073 | 1 | Utiliteit | |
| 0342346 | 140x140x43 | z. poten z. mantel | pergamon | 234200010231 | stuk | 1811,00 | 073 | 1 | | |
| 0340229 | 140x140x43 | z. poten z. mantel zelfreinigend | wit | 234200013001 | stuk | 1770,00 | 073 | 1 | | |
| 0340230 | 140x140x43 | z. poten z. mantel zelfreinigend | pergamon | 234200013231 | stuk | 1961,00 | 073 | 1 | | |
| 0342347 | 140x140x43 | z. poten m. mantel | wit | 234248050001 | stuk | 2634,00 | 073 | 1 | | |
| 0342348 | 140x140x43 | z. poten m. mantel | pergamon | 234248050231 | stuk | 2956,00 | 073 | 1 | | |
| 0340231 | 140x140x43 | z. poten m. mantel zelfreinigend | wit | 234248053001 | stuk | 2783,00 | 073 | 1 | | |
| 0340232 | 140x140x43 | z. poten m. mantel zelfreinigend | pergamon | 234248053231 | stuk | 3105,00 | 073 | 1 | | |
| 0342357 | badpoten per set | | | 583170000000 | stuk | 49,00 | 073 | 0 | | |
| Kaldewei Vaio Duo 6 | | | | | | | |  | | |
| bad plaatstaal dikwandig zeshoekig | | | | | | | | | | |
| 0360561 | 210x80x43cm | z. poten | wit | 233200010001 | stuk | 1037,00 | 073 | 1 | | |
| 0340227 | 210x80x43cm | z. poten | pergamon | 233200010231 | stuk | 1158,00 | 073 | 1 | | |
| 0340226 | 210x80x43cm | z. poten zelfreinigend | wit | 233200013001 | stuk | 1187,00 | 073 | 1 | | |
| 0340228 | 210x80x43cm | z. poten zelfreinigend | pergamon | 233200013231 | stuk | 1307,00 | 073 | 1 | | |
| 0341533 | badpoten universeel 5047 | per set | | 5047 | stuk | 17,75 | 061 | 0 | | |

| | Art.nr | Specificaties | Kleur | Lev.nr | Ehd | Prijs | Grp | CC |
|---|---|---|----------|--------------|------|---------|-----|----|
| Sanitair producten | Kaldewei Vaio Duo 8 | | | | | | | |
| | bad plaatstaal dikwandig achthoekig | | | | | | | |
| | 0341725 | 180x80x43cm z. poten | wit | 233300010001 | stuk | 1102,00 | 073 | 1 |
| | 0341726 | 180x80x43cm z. poten | pergamon | 233300010231 | stuk | 1228,00 | 073 | 1 |
| | 0340233 | 180x80x43cm z. poten zelfreinigend | wit | 233300013001 | stuk | 1251,00 | 073 | 1 |
| Baden / douchebakken / stoomcabines | 0340234 | 180x80x43cm z. poten zelfreinigend | pergamon | 233300013231 | stuk | 1377,00 | 073 | 1 |
| | 0341533 | badpoten universeel 5047 per set | | 5047 | stuk | 17,75 | 061 | 0 |
| Kranen | Kaldewei Vaio | | | | | | | |
| | bad plaatstaal dikwandig rechthoekig | | | | | | | |
| | 0341721 | 170x80x43cm z. poten | wit | 234000010001 | stuk | 524,00 | 073 | 1 |
| | 0341722 | 170x80x43cm z. poten | pergamon | 234000010231 | stuk | 584,00 | 073 | 1 |
| | 0340235 | 170x80x43cm z. poten zelfreinigend | wit | 234000013001 | stuk | 674,00 | 073 | 1 |
| Douchegarnituur | 0340236 | 170x80x43cm z. poten zelfreinigend | pergamon | 234000013231 | stuk | 733,00 | 073 | 1 |
| | 0341533 | badpoten universeel 5047 per set | | 5047 | stuk | 17,75 | 061 | 0 |
| Accessoires en spiegels | Kaldewei Vaio Star | | | | | | | |
| | bad plaatstaal dikwandig rechthoekig m. greepmontage | | | | | | | |
| | 0341723 | 170x80x43cm z. greep z. poten | wit | 234100010001 | stuk | 524,00 | 073 | 1 |
| | 0341724 | 170x80x43cm z. greep z. poten | pergamon | 234100010231 | stuk | 584,00 | 073 | 1 |
| | 0340237 | 170x80x43cm z. greep z. poten zelfreinigend | wit | 234100013001 | stuk | 674,00 | 073 | 1 |
| Douchewanden | 0340238 | 170x80x43cm z. greep z. poten zelfreinigend | pergamon | 234100013231 | stuk | 733,00 | 073 | 1 |
| | 0341533 | badpoten universeel 5047 per set | | 5047 | stuk | 17,75 | 061 | 0 |
| Toebehoren & afvoeren | 0341742 | grepen voor diverse modellen chroom | | 586770000999 | stuk | 157,00 | 073 | 1 |
| | Kaldewei Vaio 6 | | | | | | | |
| Spool- & installatiesystemen | bad plaatstaal dikwandig zeshoekig | | | | | | | |
| | 0342349 | 190x90x43cm z. poten | wit | 233800010001 | stuk | 974,00 | 073 | 1 |
| | 0342350 | 190x90x43cm z. poten | pergamon | 233800010231 | stuk | 1088,00 | 073 | 1 |
| | 0340241 | 190x90x43cm z. poten zelfreinigend | wit | 233800013001 | stuk | 1124,00 | 073 | 1 |
| | 0340242 | 190x90x43cm z. poten zelfreinigend | pergamon | 233800013231 | stuk | 1237,00 | 073 | 1 |
| Badkamermeubelen en toiletkasten | 0342357 | badpoten per set | | 583170000000 | stuk | 49,00 | 073 | 0 |
| | Kaldewei Vaio 6 Star | | | | | | | |
| Gootstenen en wastroggen | bad plaatstaal dikwandig zeshoekig m. greepmontage | | | | | | | |
| | 0340243 | 190x90x43cm z. greep z. poten zelfreinigend | wit | 233900013001 | stuk | 1124,00 | 073 | 1 |
| | 0340244 | 190x90x43cm z. greep z. poten zelfreinigend | pergamon | 233900013231 | stuk | 1237,00 | 073 | 1 |
| | 0340239 | 190x90x43cm z. greep z. poten | wit | 233900010001 | stuk | 974,00 | 073 | 1 |
| | 0340240 | 190x90x43cm z. greep z. poten | pergamon | 233900010231 | stuk | 1088,00 | 073 | 1 |
| Utiliteit | 0341742 | grepen voor diverse modellen chroom | | 586770000999 | stuk | 157,00 | 073 | 1 |
| | 0342357 | badpoten per set | | 583170000000 | stuk | 49,00 | 073 | 0 |
| Utiliteit | Kaldewei Vaio Set | | | | | | | |
| | bad plaatstaal dikwandig rechthoekig | | | | | | | |
| | 0342354 | 170x75x43cm z. poten | wit | 233400010001 | stuk | 499,00 | 073 | 0 |
| | 0342352 | 170x75x43cm z. poten | pergamon | 233400010231 | stuk | 553,00 | 073 | 1 |
| | 0340249 | 170x75x43cm z. poten zelfreinigend | wit | 233400013001 | stuk | 648,00 | 073 | 1 |
| Utiliteit | 0340250 | 170x75x43cm z. poten zelfreinigend | pergamon | 233400013231 | stuk | 702,00 | 073 | 1 |
| | 0341533 | badpoten universeel 5047 per set | | 5047 | stuk | 17,75 | 061 | 0 |
| Utiliteit | Kaldewei Vaio Set Star | | | | | | | |
| | bad plaatstaal dikwandig rechthoekig m. greepmontage | | | | | | | |
| | 0340245 | 170x75x43cm z. greep z. poten | wit | 233500010001 | stuk | 499,00 | 073 | 1 |
| | 0340246 | 170x75x43cm z. greep z. poten | pergamon | 233500010231 | stuk | 553,00 | 073 | 1 |
| | 0340247 | 170x75x43cm z. greep z. poten zelfreinigend | wit | 233500013001 | stuk | 648,00 | 073 | 1 |
| Utiliteit | 0340248 | 170x75x43cm z. greep z. poten zelfreinigend | pergamon | 233500013231 | stuk | 702,00 | 073 | 1 |
| | 0341533 | badpoten universeel 5047 per set | | 5047 | stuk | 17,75 | 061 | 0 |
| Utiliteit | 0341742 | grepen voor diverse modellen chroom | | 586770000999 | stuk | 157,00 | 073 | 1 |
| | Kaldewei Toebehoren | | | | | | | |
| Utiliteit | 0340017 | badkussen 50x30cm | | 687675610000 | stuk | 126,00 | 073 | 1 |
| | 0341649 | badpoten per set | | 581670000000 | stuk | 49,00 | 073 | 1 |
| Utiliteit | 0342357 | badpoten per set | | 583170000000 | stuk | 49,00 | 073 | 0 |
| | 0341820 | badpoten voor Corpoline/ - Star | | 582570000000 | stuk | 117,00 | 073 | 1 |
| Utiliteit | 0341822 | badpoten voor Duopool | | 583370000000 | stuk | 117,00 | 073 | 1 |
| | 0341826 | badpoten voor Kusatsupool | | 581970000000 | stuk | 135,00 | 073 | 1 |
| Utiliteit | 0341714 | grepen voor Dyna Star chroom | | 585170000999 | stuk | 120,00 | 073 | 1 |
| | 0341742 | grepen voor diverse modellen chroom | | 586770000999 | stuk | 157,00 | 073 | 1 |
| Utiliteit | 0341824 | set badgrepen voor Dynasetstar chroom | | 585570000999 | stuk | 120,00 | 073 | 1 |
| | 0341832 | set badgrepen voor Novolastar chroom | | 588570000999 | stuk | 145,00 | 073 | 1 |
| Utiliteit | 0341834 | set badgrepen voor Sanistar chroom | | 585070000999 | stuk | 120,00 | 073 | 1 |
| | 0340866 | Bako voorpaneel z. plint 170x42x4cm wit | | 685500030001 | stuk | 136,00 | 073 | 1 |
| Utiliteit | 0340890 | Bako voorpaneel m. plint 170x51.5cm wit | | 685500050001 | stuk | 165,00 | 073 | 1 |
| | 0340898 | Bako badpoten voor systeem 70cm | | 685500400000 | stuk | 72,00 | 073 | 1 |

| Art.nr | Specificaties | Kleur | Lev.nr | Ehd | Prijs | Grp | CC |
|---------|---|-------|--------------|----------------------------|--------|-----|----|
| | | | | Kaldewei Toebehoren | | | |
| 0340891 | Bako badpoten voor systeem 75cm | | 685500410000 | stuk | 72,00 | 073 | 1 |
| 0340871 | Bako zijpaneel m. plint 75/72x51.2x4 wit | | 685500230001 | stuk | 126,00 | 073 | 1 |
| 0341828 | Rotexa2000 afvoer voor Kusatuspool chroom | | 688374490999 | stuk | 123,00 | 073 | 1 |
| 0341830 | Rotexa Multi afvoer voor Kusatuspool chroom | | 688474500999 | stuk | 293,00 | 073 | 1 |
| 0342481 | badwaste standaard chroom | | 687770500000 | stuk | 114,50 | 073 | 1 |
| 0342482 | badwaste verlengd chroom | | 687770510000 | stuk | 134,50 | 073 | 1 |

Sanitair producten

Baden /
douchebakken /
stoomcabines

Kranen

Douchegarnituur

Accessoires en
spiegels

Douchewanden

Toebehoren &
afvoeren

Spoel- &
installatiesystemen

Badkamermeubelen
en toiletkasten

Gootstenen en
wastroggen

Utiliteit

| | Art.nr | Specificaties | Kleur | Lev.nr | Ehd | Prijs | Grp | CC |
|---|---|---|----------|--------------|------|---------|-----|----|
| Sanitair producten | Kaldewei Belleza | | | | | | | |
| | douchebak plaatstaal dikwandig vijfhoekig | | | | | | | |
| | 0342484 | 90x90x2.5cm zelfreinigend | wit | 442300013001 | stuk | 945,00 | 073 | 1 |
| | 0341800 | 90x90x2.5cm zelfreinigend | pergamon | 442300013231 | stuk | 945,00 | 073 | 1 |
| | 0341770 | 100x100x2.5 zelfreinigend | wit | 442400013001 | stuk | 1032,00 | 073 | 1 |
| Baden / douchebakken / stoomcabines | 0341789 | 100x100x2.5 zelfreinigend | pergamon | 442400013231 | stuk | 1032,00 | 073 | 1 |
| | 0342580 | douchebak onderstel universeel | | 584377000000 | stuk | 24,50 | 073 | 0 |
| Kranen | douchebak plaatstaal dikwandig vijfhoekig m. rand | | | | | | | |
| | 0342459 | 90x90x6.5 zelfreinigend | wit | 441600013001 | stuk | 1109,00 | 073 | 1 |
| | 0342467 | 90x90x6.5 zelfreinigend | pergamon | 441600013231 | stuk | 1109,00 | 073 | 1 |
| | 0342475 | 100x100x6.5 zelfreinigend | wit | 441900013001 | stuk | 1217,00 | 073 | 1 |
| | 0342483 | 100x100x6.5 zelfreinigend | pergamon | 441900013231 | stuk | 1217,00 | 073 | 1 |
| Douchegarnituur | douchebak plaatstaal dikwandig vijfhoekig m. rand m. styropor | | | | | | | |
| | 0342491 | 90x90x6.5 zelfreinigend | wit | 441648043001 | stuk | 1196,00 | 073 | 1 |
| | 0342505 | 90x90x6.5 zelfreinigend | pergamon | 441648043231 | stuk | 1196,00 | 073 | 1 |
| | 0342513 | 100x100x6.5 zelfreinigend | wit | 441948043001 | stuk | 1307,00 | 073 | 1 |
| | 0342521 | 100x100x6.5 zelfreinigend | pergamon | 441948043231 | stuk | 1307,00 | 073 | 1 |
| Accessoires en spiegels | douchebak plaatstaal dikwandig vijfhoekig m. rand m. styropor m. alu plint | | | | | | | |
| | 0342548 | 90x90x6.5 zelfreinigend | wit | 441648003001 | stuk | 1325,00 | 073 | 1 |
| | 0342556 | 90x90x6.5 zelfreinigend | pergamon | 441648003231 | stuk | 1338,00 | 073 | 1 |
| | 0342564 | 100x100x6.5 zelfreinigend | wit | 441948003001 | stuk | 1437,00 | 073 | 1 |
| | 0342572 | 100x100x6.5 zelfreinigend | pergamon | 441948003231 | stuk | 1442,00 | 073 | 1 |
| Douchewanden | Kaldewei Conoplan | | | | | | | |
| | douchebak plaatstaal dikwandig rechthoekig | | | | | | | |
| | 0342240 | 90x120x2.5 zelfreinigend | wit | 458400013001 | stuk | 839,20 | 073 | 1 |
| | 0342241 | 90x120x2.5 zelfreinigend | pergamon | 458400013231 | stuk | 839,20 | 073 | 1 |
| | 0342242 | 90x120x2.5 m. Styropordrager zelfreinigend | wit | 458448043001 | stuk | 1044,20 | 073 | 1 |
| | 0342243 | 90x120x2.5 m. Styropordrager zelfreinigend | pergamon | 458448043231 | stuk | 1044,20 | 073 | 1 |
| | 0342205 | 90x120x6.5 m. paneel zelfreinigend | wit | 458100013001 | stuk | 819,20 | 073 | 1 |
| | 0342247 | 90x120x6.5 m. paneel zelfreinigend | pergamon | 458100013231 | stuk | 819,20 | 073 | 1 |
| | 0342248 | 90x120x6.5 m. pan. m. Styropordr. zelfreinigend | wit | 458148043001 | stuk | 1019,20 | 073 | 1 |
| | 0342249 | 90x120x6.5 m. pan. m. Styropordr. zelfreinigend | pergamon | 458148043231 | stuk | 1019,20 | 073 | 1 |
| Toebehoren & afvoeren | afvoergarnituur speciaal voor douchebak | | | | | | | |
| | 0342244 | | wit | 687770563001 | stuk | 90,00 | 073 | 1 |
| | 0342245 | | pergamon | 687770563231 | stuk | 90,00 | 073 | 1 |
| Spoel- & installatiesystemen | Kaldewei Sanidusch | | | | | | | |
| | douchebak plaatstaal dikwandig | | | | | | | |
| Badkamermeubelen en toiletkasten | 0342541 | 80x80x14cm vierkant | wit | 331000010001 | stuk | 106,20 | 073 | 0 |
| | 0342545 | 80x80x14cm vierkant | pergamon | 331000010231 | stuk | 184,70 | 073 | 1 |
| | 0342552 | 80x80x14cm vierkant m. antislip | pergamon | 331030000231 | stuk | 320,70 | 073 | 1 |
| | 0342578 | 80x80x25cm vierkant | wit | 332000010001 | stuk | 196,20 | 073 | 1 |
| | 0342579 | 80x80x25cm vierkant | pergamon | 332000010231 | stuk | 269,20 | 073 | 1 |
| Gootstenen en wastroggen | 0342542 | 90x90x14cm vierkant | wit | 331100010001 | stuk | 110,70 | 073 | 0 |
| | 0342550 | 90x90x14cm vierkant | pergamon | 331100010231 | stuk | 198,20 | 073 | 1 |
| | 0342544 | 90x90x14cm vierkant m. antislip | wit | 331130000001 | stuk | 233,20 | 073 | 0 |
| | 0342551 | 90x90x14cm vierkant m. antislip | pergamon | 331130000231 | stuk | 307,20 | 073 | 1 |
| | 0342582 | 90x90x25cm vierkant | wit | 332100010001 | stuk | 203,70 | 073 | 1 |
| Utiliteit | 0342583 | 90x90x25cm vierkant | pergamon | 332100010231 | stuk | 269,20 | 073 | 1 |
| | 0342554 | 100x100x14cm vierkant | wit | 440700010001 | stuk | 393,20 | 073 | 1 |
| | 0342566 | 100x100x14cm vierkant | pergamon | 440700010231 | stuk | 393,20 | 073 | 1 |
| | 0342569 | 80x90x14cm rechthoekig | wit | 440800010001 | stuk | 241,20 | 073 | 1 |
| | 0342570 | 80x90x14cm rechthoekig | pergamon | 440800010231 | stuk | 241,20 | 073 | 1 |
| | 0342575 | 80x100x14cm rechthoekig | wit | 440600010001 | stuk | 343,20 | 073 | 1 |
| | 0342576 | 80x100x14cm rechthoekig | pergamon | 440600010231 | stuk | 343,20 | 073 | 1 |
| | 1841620 | 80x100x15cm rechthoekig | pergamon | 440600010231 | stuk | 343,00 | 073 | 1 |
| | 0342577 | 80x120x14cm rechthoekig | wit | 448300010001 | stuk | 411,20 | 073 | 1 |
| | 0342553 | 80x120x14cm rechthoekig | pergamon | 448300010231 | stuk | 411,20 | 073 | 1 |
| | 0342567 | 90x75x14cm rechthoekig | wit | 331600010001 | stuk | 117,20 | 073 | 1 |
| | 0342568 | 90x75x14cm rechthoekig | pergamon | 331600010231 | stuk | 205,20 | 073 | 1 |

| Art.nr | Specificaties | Kleur | Lev.nr | Ehd | Prijs | Grp | CC |
|---------------------------------------|---|----------|--------------|------|--------|-----|----|
| Kaldewei Duschplan | | | | | | | |
| douchebak plaatstaal dikwandig | | | | | | | |
| 0342400 | 70x120x6.5 rechthoekig | wit | 431500010001 | stuk | 531,20 | 073 | 1 |
| 0342401 | 70x120x6.5 rechthoekig | pergamon | 431500010231 | stuk | 531,20 | 073 | 1 |
| 0342294 | 75x100x6.5 rechthoekig | wit | 431600010001 | stuk | 531,20 | 073 | 1 |
| 0342295 | 75x100x6.5 rechthoekig | pergamon | 431600010231 | stuk | 531,20 | 073 | 1 |
| 0342402 | 75x120x6.5 rechthoekig | wit | 431700010001 | stuk | 531,20 | 073 | 1 |
| 0342403 | 75x120x6.5 rechthoekig | pergamon | 431700010231 | stuk | 531,20 | 073 | 1 |
| 0342173 | 80x80x6.5cm vierkant | wit | 440500010001 | stuk | 324,00 | 073 | 1 |
| 0342203 | 80x80x6.5cm vierkant | pergamon | 440500010231 | stuk | 351,00 | 073 | 1 |
| 0342238 | 80x80x6.5cm vierkant m. antislip | wit | 440530000001 | stuk | 447,00 | 073 | 1 |
| 0342254 | 80x80x6.5cm vierkant m. antislip | pergamon | 440530000231 | stuk | 473,00 | 073 | 1 |
| 0342181 | 90x90x6.5cm vierkant | wit | 440300010001 | stuk | 330,00 | 073 | 1 |
| 0342211 | 90x90x6.5cm vierkant | pergamon | 440300010231 | stuk | 351,00 | 073 | 1 |
| 0342246 | 90x90x6.5cm vierkant m. antislip | wit | 440330000001 | stuk | 453,00 | 073 | 1 |
| 0342262 | 90x90x6.5cm vierkant m. antislip | pergamon | 440330000231 | stuk | 473,00 | 073 | 1 |
| 0342296 | 90x100x6.5 rechthoekig | wit | 431800010001 | stuk | 459,20 | 073 | 1 |
| 0342214 | 90x100x6.5 rechthoekig | pergamon | 431800010231 | stuk | 459,20 | 073 | 1 |
| 0342298 | 90x110x6.5 rechthoekig | wit | 431900010001 | stuk | 531,20 | 073 | 1 |
| 0342299 | 90x110x6.5 rechthoekig | pergamon | 431900010231 | stuk | 531,20 | 073 | 1 |
| 0342404 | 90x120x6.5 rechthoekig | wit | 432000010001 | stuk | 531,20 | 073 | 1 |
| 0342405 | 90x120x6.5 rechthoekig | pergamon | 432000010231 | stuk | 531,20 | 073 | 1 |
| 0341626 | 80x100x6.5 rechthoekig | wit | 440100010001 | stuk | 443,00 | 073 | 1 |
| 0341627 | 80x100x6.5 rechthoekig | pergamon | 440100010231 | stuk | 443,00 | 073 | 1 |
| 0341628 | 80x100x6.5 rechthoekig m. antislip | wit | 440130000001 | stuk | 566,00 | 073 | 1 |
| 0341629 | 80x100x6.5 rechthoekig m. antislip | pergamon | 440130000231 | stuk | 566,00 | 073 | 1 |
| 0341631 | 80x120x6.5 rechthoekig | wit | 448200010001 | stuk | 483,00 | 073 | 1 |
| 0341632 | 80x120x6.5 rechthoekig | pergamon | 448200010231 | stuk | 483,00 | 073 | 1 |
| 0341633 | 80x120x6.5 rechthoekig m. antislip | wit | 448230000001 | stuk | 605,00 | 073 | 1 |
| 0341634 | 80x120x6.5 rechthoekig m. antislip | pergamon | 448230000231 | stuk | 605,00 | 073 | 1 |
| 0341635 | 100x100x6.5 vierkant | wit | 440200010001 | stuk | 468,00 | 073 | 1 |
| 0341636 | 100x100x6.5 vierkant | pergamon | 440200010231 | stuk | 468,00 | 073 | 1 |
| 0341637 | 100x100x6.5 vierkant m. antislip | wit | 440230000001 | stuk | 591,00 | 073 | 1 |
| 0341638 | 100x100x6.5 vierkant m. antislip | pergamon | 440230000231 | stuk | 591,00 | 073 | 1 |
| 0342406 | 100x120x6.5 rechthoekig | wit | 432100010001 | stuk | 583,20 | 073 | 1 |
| 0342407 | 100x120x6.5 rechthoekig | pergamon | 432100010231 | stuk | 583,20 | 073 | 1 |
| 0242501 | 120x120x6.5 rechthoekig | wit | 432200010001 | stuk | 603,20 | 073 | 1 |
| 0342409 | 120x120x6.5 rechthoekig | pergamon | 432200010231 | stuk | 603,20 | 073 | 1 |
| 0342410 | 75x100x6.5 rechthoekig m. Styropordrager | wit | 431648040001 | stuk | 578,20 | 073 | 1 |
| 0342411 | 75x100x6.5 rechthoekig m. Styropordrager | pergamon | 431648040231 | stuk | 578,20 | 073 | 1 |
| 0342412 | 90x100x6.5 rechthoekig m. Styropordrager | wit | 431848040001 | stuk | 506,20 | 073 | 1 |
| 0342413 | 90x100x6.5 rechthoekig m. Styropordrager | pergamon | 431848040231 | stuk | 506,20 | 073 | 1 |
| 0342414 | 90x110x6.5 rechthoekig m. Styropordrager | wit | 431948040001 | stuk | 578,20 | 073 | 1 |
| 0342415 | 90x110x6.5 rechthoekig m. Styropordrager | pergamon | 431948040231 | stuk | 578,20 | 073 | 1 |
| 0342500 | 70x120x6.5 rechthoekig m. Styropordrager | wit | 431548040001 | stuk | 578,20 | 073 | 1 |
| 0342417 | 70x120x6.5 rechthoekig m. Styropordrager | pergamon | 431548040231 | stuk | 578,20 | 073 | 1 |
| 0342418 | 75x120x6.5 rechthoekig m. Styropordrager | wit | 431748040001 | stuk | 578,20 | 073 | 1 |
| 0342419 | 75x120x6.5 rechthoekig m. Styropordrager | pergamon | 431748040231 | stuk | 578,20 | 073 | 1 |
| 0342420 | 90x120x6.5 rechthoekig m. Styropordrager | wit | 432048040001 | stuk | 578,20 | 073 | 1 |
| 0342421 | 90x120x6.5 rechthoekig m. Styropordrager | pergamon | 432048040231 | stuk | 578,20 | 073 | 1 |
| 0342422 | 100x120x6.5 rechthoekig m. Styropordrager | wit | 432148040001 | stuk | 630,20 | 073 | 1 |
| 0342423 | 100x120x6.5 rechthoekig m. Styropordrager | pergamon | 432148040231 | stuk | 630,20 | 073 | 1 |
| 0342490 | 120x120x6.5 rechthoekig m. Styropordrager | wit | 432248040001 | stuk | 650,20 | 073 | 1 |
| 0342425 | 120x120x6.5 rechthoekig m. Styropordrager | pergamon | 432248040231 | stuk | 650,20 | 073 | 1 |

XXL douchebak plaatstaal dikwandig rechthoekig

| | | | | | | | |
|---------|-------------------------------|----------|--------------|------|--------|-----|---|
| 0342426 | 70x140x6.5 m. Styropordrager | wit | 432348040001 | stuk | 580,00 | 073 | 1 |
| 0342427 | 70x140x6.5 m. Styropordrager | pergamon | 432348040231 | stuk | 580,00 | 073 | 1 |
| 0342428 | 75x140x6.5 m. Styropordrager | wit | 432548040001 | stuk | 580,00 | 073 | 1 |
| 0342429 | 75x140x6.5 m. Styropordrager | pergamon | 432548040231 | stuk | 580,00 | 073 | 1 |
| 0342430 | 100x140x6.5 m. Styropordrager | wit | 432748040001 | stuk | 625,00 | 073 | 1 |
| 0342431 | 100x140x6.5 m. Styropordrager | pergamon | 432748040231 | stuk | 625,00 | 073 | 1 |
| 0342489 | 150x150x6.5 m. Styropordrager | wit | 432848040001 | stuk | 719,00 | 073 | 1 |
| 0342433 | 150x150x6.5 m. Styropordrager | pergamon | 432848040231 | stuk | 719,00 | 073 | 1 |
| 0342434 | 70x170x6.5 m. Styropordrager | wit | 432448040001 | stuk | 737,00 | 073 | 1 |
| 0342435 | 70x170x6.5 m. Styropordrager | pergamon | 432448040231 | stuk | 737,00 | 073 | 1 |
| 0342436 | 75x170x6.5 m. Styropordrager | wit | 432648040001 | stuk | 737,00 | 073 | 1 |
| 0342437 | 75x170x6.5 m. Styropordrager | pergamon | 432648040231 | stuk | 737,00 | 073 | 1 |



Sanitair producten

Baden /
douchebakken /
stoomcabines

Kranen

Doucheapparatuur

Accessoires en
spiegels

Douchewanden

Toebehoren &
afvoeren

Spoel- &
installatiesystemen

Badkamermeubelen
en toiletkasten

Gootstenen en
wastroggen

Utiliteit



Plaatstaal douchebakken Kaldewei

| | Art.nr | Specificaties | Kleur | Lev.nr | Ehd | Prijs | Grp | CC |
|---|---|--|----------|--------------|------|--------|-----|----|
| Sanitair producten | Kaldewei Dynaplan | | | | | | | |
| | douchebak plaatstaal dikwandig | | | | | | | |
| | 0341610 | 80x80x6.5cm vierkant | wit | 444400010001 | stuk | 364,00 | 073 | 1 |
| | 0341611 | 80x80x6.5cm vierkant | pergamon | 444400010231 | stuk | 364,00 | 073 | 1 |
| | 0341612 | 75x90x6.5cm rechthoekig | wit | 444700010001 | stuk | 364,00 | 073 | 1 |
| | 0341613 | 75x90x6.5cm rechthoekig | pergamon | 444700010231 | stuk | 364,00 | 073 | 1 |
| | 0341615 | 80x90x6.5cm rechthoekig | wit | 444600010001 | stuk | 364,00 | 073 | 1 |
| | 0641616 | 80x90x6.5cm rechthoekig | pergamon | 444600010231 | stuk | 364,00 | 073 | 1 |
| | 0341754 | 90x90x6.5cm vierkant | wit | 444500010001 | stuk | 364,00 | 073 | 1 |
| Baden / douchebakken / stoomcabines | 0341762 | 90x90x6.5cm vierkant | pergamon | 444500010231 | stuk | 364,00 | 073 | 1 |
| | 0342580 | douchebak onderstel universeel | | 584377000000 | stuk | 24,50 | 073 | 0 |
| | Kaldewei Fontana | | | | | | | |
| Kranen | douchebak plaatstaal dikwandig kwartrond | | | | | | | |
| | 0342438 | 80x80x2.5cm | wit | 444800010001 | stuk | 627,20 | 073 | 1 |
| | 0342439 | 80x80x2.5cm | pergamon | 444800010231 | stuk | 627,20 | 073 | 1 |
| | 0342488 | 80x80x2.5cm m. Styropordrager | wit | 444848040001 | stuk | 663,20 | 073 | 1 |
| | 0342441 | 80x80x2.5cm m. Styropordrager | pergamon | 444848040231 | stuk | 663,20 | 073 | 1 |
| | 0342270 | 90x90x13cm m. paneel m. styropor | wit | 445048030001 | stuk | 632,00 | 073 | 1 |
| | 0342289 | 90x90x13cm m. paneel m. styropor | pergamon | 445048030231 | stuk | 674,00 | 073 | 1 |
| | 0342297 | 90x90x13cm m. antislip m. paneel m. styropor | wit | 445035010001 | stuk | 755,00 | 073 | 1 |
| | 0342300 | 90x90x13cm m. antislip m. paneel m. styropor | pergamon | 445035010231 | stuk | 796,00 | 073 | 1 |
| Douchegarnituur | Kaldewei Lacosta | | | | | | | |
| | douchebak plaatstaal dikwandig | | | | | | | |
| | 0341607 | 100x80x28 rechthoekig | wit | 442000010001 | stuk | 406,00 | 073 | 1 |
| Accessoires en spiegels | 0341609 | 100x80x28 rechthoekig | pergamon | 442000010231 | stuk | 443,00 | 073 | 1 |
| | 0342580 | douchebak onderstel universeel | | 584377000000 | stuk | 24,50 | 073 | 0 |
| Douchewanden | Kaldewei Megaplan | | | | | | | |
| | douchebak plaatstaal dikwandig rechthoekig | | | | | | | |
| | 0342394 | 120x90x3.6 zelfreinigend | wit | 447400013001 | stuk | 796,00 | 073 | 1 |
| | 0342408 | 120x90x3.6 zelfreinigend | pergamon | 447400013231 | stuk | 796,00 | 073 | 1 |
| | 0342416 | 120x90x3.6 zelfreinigend en styropor drager | wit | 447448043001 | stuk | 972,00 | 073 | 1 |
| Toebehoren & afvoeren | 0342424 | 120x90x3.6 zelfreinigend en styropor drager | pergamon | 447448043231 | stuk | 972,00 | 073 | 1 |
| | afdekplaat 44x14cm | | | | | | | |
| | 0342432 | | wit | 687673490001 | stuk | 125,00 | 073 | 1 |
| Spoel- & installatiesystemen | 0342440 | | pergamon | 687673490231 | stuk | 144,00 | 073 | 1 |
| | Kaldewei Novolaplan | | | | | | | |
| Badkamermeubelen en toiletkasten | douchebak plaatstaal dikwandig | | | | | | | |
| | 0341661 | 90x75x6.5cm kwartrond | wit | 451000010001 | stuk | 611,00 | 073 | 1 |
| | 0341662 | 90x75x6.5cm kwartrond | pergamon | 451000010231 | stuk | 611,00 | 073 | 1 |
| | 0341663 | 75x90x6.5cm kwartrond | wit | 451100010001 | stuk | 611,00 | 073 | 1 |
| | 0341664 | 75x90x6.5cm kwartrond | pergamon | 451100010231 | stuk | 611,00 | 073 | 1 |
| Gootstenen en wastroggen | 0342580 | douchebak onderstel universeel | | 584377000000 | stuk | 24,50 | 073 | 0 |
| | Kaldewei Quinto | | | | | | | |
| Utiliteit | douchebak plaatstaal dikwandig | | | | | | | |
| | 0341659 | 90x90x6.5cm vijfhoekig | wit | 450000010001 | stuk | 771,00 | 073 | 1 |
| | 0341660 | 90x90x6.5cm vijfhoekig | pergamon | 450000010231 | stuk | 771,00 | 073 | 1 |
| | 0342580 | douchebak onderstel universeel | | 584377000000 | stuk | 24,50 | 073 | 0 |
| Utiliteit | Kaldewei Rondana | | | | | | | |
| | douchebak plaatstaal dikwandig | | | | | | | |
| | 0341666 | 90x90x6.5cm kwartrond m. rand | wit | 443100013001 | stuk | 861,00 | 073 | 1 |
| | 0341667 | 90x90x6.5cm kwartrond m. rand | pergamon | 443100013231 | stuk | 861,00 | 073 | 1 |
| | 0341670 | 90x90x6.5cm kwartrond m. rand m. drager | wit | 443148043001 | stuk | 942,00 | 073 | 1 |
| | 0341671 | 90x90x6.5cm kwartrond m. rand m. drager | pergamon | 443148043231 | stuk | 947,00 | 073 | 1 |
| | 0341668 | 100x100x6.5 kwartrond m. rand | wit | 443200013001 | stuk | 881,00 | 073 | 1 |
| | 0341669 | 100x100x6.5 kwartrond m. rand | pergamon | 443200013231 | stuk | 881,00 | 073 | 1 |
| | 0341672 | 100x100x6.5 kwartrond m. rand m. drager | wit | 443248043001 | stuk | 962,00 | 073 | 1 |
| | 0341674 | 100x100x6.5 kwartrond m. rand m. drager | pergamon | 443248043231 | stuk | 962,00 | 073 | 1 |

Plaatstaal douchebakken Kaldewei

| | Art.nr | Specificaties | Kleur | Lev.nr | Ehd | Prijs | Grp | CC |
|---|---------------------------------------|--|----------|--------------|------|--------|-----|----|
| | Kaldewei Superplan | | | | | | | |
| | douchebak plaatstaal dikwandig | | | | | | | |
| Sanitair producten | 0342278 | 90x120x2.5 rechthoekig m. styropordrager | wit | 430648040001 | stuk | 630,20 | 073 | 1 |
| | 0342279 | 90x120x2.5 rechthoekig m. styropordrager | pergamon | 430648040231 | stuk | 630,20 | 073 | 1 |
| | 0341711 | 100x100x2.5 vierkant | wit | 447000010001 | stuk | 457,00 | 073 | 0 |
| | 0341746 | 100x100x2.5 vierkant | pergamon | 447000010231 | stuk | 457,00 | 073 | 1 |
| Baden / douchebakken / stoomcabines | 0340128 | 100x100x2.5 vierkant m. styropordrager | wit | 447048040001 | stuk | 504,20 | 073 | 1 |
| | 0340129 | 100x100x2.5 vierkant m. styropordrager | pergamon | 447048040231 | stuk | 504,20 | 073 | 1 |
| | 0341656 | 100x100x2.5 vierkant m. antislip | wit | 447030000001 | stuk | 579,00 | 073 | 1 |
| | 0341658 | 100x100x2.5 vierkant m. antislip | pergamon | 447030000231 | stuk | 579,00 | 073 | 1 |
| | 0340253 | 100x100x2.5 vierkant m. st. drager m. antislip | wit | 447035000001 | stuk | 626,70 | 073 | 1 |
| Kranen | 0340254 | 100x100x2.5 vierkant m. st. drager m. antislip | pergamon | 447035000231 | stuk | 626,70 | 073 | 1 |
| | 0341652 | 120x120x2.5 vierkant | wit | 447100010001 | stuk | 603,00 | 073 | 1 |
| | 0342264 | 100x120x2.5 rechthoekig | wit | 430700010001 | stuk | 583,20 | 073 | 1 |
| | 0341653 | 120x120x2.5 vierkant | pergamon | 447100010231 | stuk | 603,00 | 073 | 1 |
| Douchegarnituur | 0342265 | 100x120x2.5 rechthoekig | pergamon | 430700010231 | stuk | 583,20 | 073 | 1 |
| | 0342280 | 100x120x2.5 rechthoekig m. styropordrager | wit | 430748040001 | stuk | 630,20 | 073 | 1 |
| | 0340133 | 120x120x2.5 vierkant m. styropordrager | pergamon | 447148040231 | stuk | 650,20 | 073 | 1 |
| | 0342281 | 100x120x2.5 rechthoekig m. styropordrager | pergamon | 430748040231 | stuk | 630,20 | 073 | 1 |
| | 0341654 | 120x120x2.5 vierkant m. antislip | wit | 447130000001 | stuk | 726,00 | 073 | 1 |
| Accessoires en spiegels | 0341655 | 120x120x2.5 vierkant m. antislip | pergamon | 447130000231 | stuk | 726,00 | 073 | 1 |
| | 0340257 | 120x120x2.5 vierkant m. st. drager m. antislip | wit | 447135000001 | stuk | 772,70 | 073 | 1 |
| | 0340258 | 120x120x2.5 vierkant m. st. drager m. antislip | pergamon | 447135000231 | stuk | 772,70 | 073 | 1 |
| | 0340132 | 120x120x2.5 vierkant m. styropordrager | wit | 447148040001 | stuk | 650,20 | 073 | 1 |
| Douchewanden | | | | | | | | |
| Toebehoren & afvoeren | | | | | | | | |
| Spoel- & installatiesystemen | | | | | | | | |
| Badkamermeubelen en toiletkasten | | | | | | | | |
| Gootstenen en wastroggen | | | | | | | | |
| Utiliteit | | | | | | | | |

| Art.nr | Specificaties | Kleur | Lev.nr | Ehd | Prijs | Grp | CC |
|--------|---------------|-------|--------|-----|-------|-----|----|
|--------|---------------|-------|--------|-----|-------|-----|----|

Kaldewei Superplan

XXL douchebak plaatstaal dikwandig

| | | | | | | | | |
|---------|-------------|-------------------------------|----------|--------------|------|--------|-----|---|
| 0342282 | 70x140x3.9 | rechthoekig m. styropordrager | wit | 430848040001 | stuk | 618,00 | 073 | 1 |
| 0342283 | 70x140x3.9 | rechthoekig m. styropordrager | pergamon | 430848040231 | stuk | 618,00 | 073 | 1 |
| 0342290 | 70x170x4.7 | rechthoekig m. styropordrager | wit | 430948040001 | stuk | 737,00 | 073 | 1 |
| 0342291 | 70x170x4.7 | rechthoekig m. styropordrager | pergamon | 430948040231 | stuk | 737,00 | 073 | 1 |
| 0342284 | 75x140x4cm | rechthoekig m. styropordrager | wit | 431048040001 | stuk | 618,00 | 073 | 1 |
| 0342285 | 75x140x4cm | rechthoekig m. styropordrager | pergamon | 431048040231 | stuk | 618,00 | 073 | 1 |
| 0342292 | 75x170x4.7 | rechthoekig m. styropordrager | wit | 431148040001 | stuk | 737,00 | 073 | 1 |
| 0342293 | 75x170x4.7 | rechthoekig m. styropordrager | pergamon | 431148040231 | stuk | 737,00 | 073 | 1 |
| 0342286 | 100x140x4.3 | rechthoekig m. styropordrager | wit | 431248040001 | stuk | 645,00 | 073 | 1 |
| 0342287 | 100x140x4.3 | rechthoekig m. styropordrager | pergamon | 431248040231 | stuk | 645,00 | 073 | 1 |
| 0342288 | 150x150x5.2 | vierkant m. styropordrager | wit | 431348040001 | stuk | 719,00 | 073 | 1 |
| 0342213 | 150x150x5.2 | vierkant m. styropordrager | pergamon | 431348040231 | stuk | 719,00 | 073 | 1 |



Sanitair producten

Baden /
douchebakken /
stoomcabines

Kranen

Kaldewei Zirkon

douchebak plaatstaal dikwandig kwart rond

| | | | | | | | | |
|---------|--------------------------------|--|----------|--------------|------|--------|-----|---|
| 0342442 | 80x80x3.5cm | | wit | 456500010001 | stuk | 378,20 | 073 | 1 |
| 0342443 | 80x80x3.5cm | | pergamon | 456500010231 | stuk | 378,20 | 073 | 1 |
| 0342448 | 80x90x3.5cm | | wit | 456600010001 | stuk | 583,20 | 073 | 1 |
| 0342449 | 80x90x3.5cm | | pergamon | 456600010231 | stuk | 583,20 | 073 | 1 |
| 0342460 | 80x90x6.5cm | | wit | 456000010001 | stuk | 583,20 | 073 | 1 |
| 0342461 | 80x90x6.5cm | | pergamon | 456000010231 | stuk | 583,20 | 073 | 1 |
| 0342452 | 80x100x3.5 | | wit | 456700010001 | stuk | 583,20 | 073 | 1 |
| 0342453 | 80x100x3.5 | | pergamon | 456700010231 | stuk | 583,20 | 073 | 1 |
| 0342462 | 80x100x6.5 | | wit | 456100010001 | stuk | 583,20 | 073 | 1 |
| 0342463 | 80x100x6.5 | | pergamon | 456100010231 | stuk | 583,20 | 073 | 1 |
| 0342444 | 90x80x3.5cm | | wit | 456800010001 | stuk | 583,20 | 073 | 1 |
| 0342445 | 90x80x3.5cm | | pergamon | 456800010231 | stuk | 583,20 | 073 | 1 |
| 0342456 | 90x80x6.5cm | | wit | 456200010001 | stuk | 583,20 | 073 | 1 |
| 0342457 | 90x80x6.5cm | | pergamon | 456200010231 | stuk | 583,20 | 073 | 1 |
| 0342450 | 90x90x3.5cm | | wit | 456900010001 | stuk | 378,20 | 073 | 1 |
| 0342451 | 90x90x3.5cm | | pergamon | 456900010231 | stuk | 378,20 | 073 | 1 |
| 0368899 | 90x90x6.5cm | | wit | 452200010001 | stuk | 378,00 | 073 | 1 |
| 0342492 | 90x90x6.5cm | | pergamon | 452200010231 | stuk | 378,00 | 073 | 1 |
| 0342446 | 100x80x3.5 | | wit | 457000010001 | stuk | 583,20 | 073 | 1 |
| 0342447 | 100x80x3.5 | | pergamon | 457000010231 | stuk | 583,20 | 073 | 1 |
| 0342458 | 100x80x6.5 | | wit | 456300010001 | stuk | 583,20 | 073 | 1 |
| 0342487 | 100x80x6.5 | | pergamon | 456300010231 | stuk | 583,20 | 073 | 1 |
| 0342454 | 100x100x3.5 | | wit | 457100010001 | stuk | 429,20 | 073 | 1 |
| 0342455 | 100x100x3.5 | | pergamon | 457100010231 | stuk | 429,20 | 073 | 1 |
| 0342464 | 100x100x6.5 | | wit | 456400010001 | stuk | 429,20 | 073 | 1 |
| 0342465 | 100x100x6.5 | | pergamon | 456400010231 | stuk | 429,20 | 073 | 1 |
| 0342580 | douchebak onderstel universeel | | | 584377000000 | stuk | 24,50 | 073 | 0 |



Douchegarnituur

Accessoires en
spiegels

Douchewanden

Toebehoren &
afvoeren

Spoel- &
installatiesystemen

Badkamermeubelen
en toiletkasten

Gootstenen en
wastroggen

Kaldewei systeemraam ESR

systeemraam

| | | | | | | | | |
|---------|-----------|-----------------------------------|--|--------------|------|--------|-----|---|
| 0342522 | 80x80cm | m. sifon m. kruipwateraansluiting | | 584571280000 | stuk | 280,00 | 073 | 1 |
| 0342523 | 90x90cm | m. sifon m. kruipwateraansluiting | | 584571240000 | stuk | 280,00 | 073 | 0 |
| 0342524 | 100x100cm | m. sifon m. kruipwateraansluiting | | 584571220000 | stuk | 280,00 | 073 | 1 |
| 0342525 | 120x120cm | m. sifon m. kruipwateraansluiting | | 584571200000 | stuk | 309,00 | 073 | 1 |



Utiliteit

systeemraam Bellezza

| | | | | | | | | |
|---------|-----------|-----------------------------------|--|--------------|------|--------|-----|---|
| 0342528 | 90x90cm | m. sifon m. kruipwateraansluiting | | 584571310000 | stuk | 485,00 | 073 | 1 |
| 0342529 | 100x100cm | m. sifon m. kruipwateraansluiting | | 584571300000 | stuk | 515,00 | 073 | 1 |

systeemraam Fontana

| | | | | | | | | |
|---------|-----------|-----------------------------------|--|--------------|------|--------|-----|---|
| 0342480 | 80x80cm | m. sifon m. kruipwateraansluiting | | 584572140000 | stuk | 476,00 | 073 | 1 |
| 0342526 | 90x90cm | m. sifon m. kruipwateraansluiting | | 584571330000 | stuk | 503,00 | 073 | 1 |
| 0342527 | 100x100cm | m. sifon m. kruipwateraansluiting | | 584571320000 | stuk | 533,00 | 073 | 1 |

systeemraam Superplan

| | | | | | | | | |
|---------|-----------|-----------------------------------|--|--------------|------|--------|-----|---|
| 0342466 | 70x90cm | m. sifon m. kruipwateraansluiting | | 584572130000 | stuk | 280,00 | 073 | 1 |
| 0342486 | 75x100cm | m. sifon m. kruipwateraansluiting | | 584572120000 | stuk | 280,00 | 073 | 1 |
| 0342468 | 90x100cm | m. sifon m. kruipwateraansluiting | | 584572110000 | stuk | 280,00 | 073 | 1 |
| 0342469 | 90x110cm | m. sifon m. kruipwateraansluiting | | 584572100000 | stuk | 280,00 | 073 | 1 |
| 0342470 | 70x120cm | m. sifon m. kruipwateraansluiting | | 584572090000 | stuk | 309,00 | 073 | 1 |
| 0342471 | 75x120cm | m. sifon m. kruipwateraansluiting | | 584572080000 | stuk | 309,00 | 073 | 1 |
| 0342472 | 90x120cm | m. sifon m. kruipwateraansluiting | | 584572070000 | stuk | 309,00 | 073 | 1 |
| 0342473 | 100x120cm | m. sifon m. kruipwateraansluiting | | 584572060000 | stuk | 309,00 | 073 | 1 |

| | Art.nr | Specificaties | Kleur | Lev.nr | Ehd | Prijs | Grp | CC |
|---|----------------------------------|---|-------|--------------|------|--------|-----|----|
| | Kaldewei systeemraam ESR | | | | | | | |
| | systeemraam Superplan XXL | | | | | | | |
| Sanitair producten | 0342474 | 70x140cm m. sifon m. kruipwateraansluiting | | 584572050000 | stuk | 521,00 | 073 | 1 |
| | 0342485 | 75x140cm m. sifon m. kruipwateraansluiting | | 584572040000 | stuk | 521,00 | 073 | 1 |
| | 0342476 | 100x140cm m. sifon m. kruipwateraansluiting | | 584572030000 | stuk | 521,00 | 073 | 1 |
| | 0342477 | 150x150cm m. sifon m. kruipwateraansluiting | | 584572000000 | stuk | 612,00 | 073 | 1 |
| Baden / douchebakken / stoomcabines | 0342478 | 70x170cm m. sifon m. kruipwateraansluiting | | 584572020000 | stuk | 612,00 | 073 | 1 |
| | 0342479 | 75x170cm m. sifon m. kruipwateraansluiting | | 584572010000 | stuk | 612,00 | 073 | 1 |
| | Kaldewei Toebehoren | | | | | | | |
| | 0342580 | douchebak onderstel universeel | | 584377000000 | stuk | 24,50 | 073 | 0 |
| Kranen | 0342538 | potenset voor douchebak vlak 90x90cm | | 530000010000 | stuk | 90,00 | 073 | 1 |
| | 0342539 | potenset voor douchebak vlak 120x120cm | | 530000020000 | stuk | 99,00 | 073 | 1 |
| | 0342540 | potenset voor douchebak XXL 150x70cm | | 530000030000 | stuk | 153,00 | 073 | 1 |
| Douchegarnituur | | | | | | | | |
| Accessoires en spiegels | | | | | | | | |
| Douchewanden | | | | | | | | |
| Toebehoren & afvoeren | | | | | | | | |
| Spoel- & installatiesystemen | | | | | | | | |
| Badkamermeubelen en toiletkasten | | | | | | | | |
| Gootstenen en wastroggen | | | | | | | | |
| Utiliteit | | | | | | | | |

| Art.nr | Specificaties | Kleur | Lev.nr | Ehd | Prijs | Grp | CC |
|--------|---------------|-------|--------|-----|-------|-----|----|
|--------|---------------|-------|--------|-----|-------|-----|----|

Plieger Standaard

voetzitbad plaatstaal

| | | | | | | | |
|---------|--------------------------------|-----|---------|------|--------|-----|---|
| 0340480 | 105x65cm z. poten | wit | 0340480 | stuk | 114,00 | 062 | 0 |
| 0340079 | poten voor voetzitbad 105x65cm | | 0340079 | stuk | 22,75 | 062 | 0 |



Sanitair producten

bad plaatstaal dunwandig

| | | | | | | | |
|---------|----------------------------------|----------|---------|------|--------|-----|---|
| 0341428 | 140x70cm rechthoekig z. poten | wit | 0341428 | stuk | 114,00 | 062 | 0 |
| 0341436 | 150x70cm rechthoekig z. poten | wit | 0341436 | stuk | 114,00 | 062 | 0 |
| 0341444 | 160x70cm rechthoekig z. poten | wit | 0341444 | stuk | 114,00 | 062 | 0 |
| 0341452 | 170x70cm rechthoekig z. poten | wit | 0341452 | stuk | 117,00 | 062 | 0 |
| 0354899 | 170x70cm rechthoekig z. poten | pergamon | 0354899 | stuk | 128,00 | 062 | 0 |
| 0341533 | badpoten universeel 5047 per set | | 5047 | stuk | 17,75 | 061 | 0 |

Baden /
douchebakken /
stoomcabines

Kranen

Plieger Brussel

bad plaatstaal dikwandig z. poten

| | | | | | | | |
|---------|----------------------------------|----------|---------|------|--------|-----|---|
| 0341525 | 170x75cm | wit | 0341525 | stuk | 135,00 | 061 | 0 |
| 0361586 | 170x75cm | pergamon | 0361586 | stuk | 208,00 | 061 | 1 |
| 0341533 | badpoten universeel 5047 per set | | 5047 | stuk | 17,75 | 061 | 0 |



Douchegarnituur

Accessoires en
spiegels

Douchewanden

Toebehoren &
afvoeren

Spoel- &
installatiesystemen

Badkamermeubelen
en toiletkasten

Gootstenen en
wastroggen

Utiliteit

| | Art.nr | Specificaties | Kleur | Lev.nr | Ehd | Prijs | Grp | CC | | |
|----------------------------------|--|------------------------|---|------------|----------|---------|--------|-------|-----|---|
| Sanitair producten | Plieger Standaard | | | | | | | | | |
| | douchebak plaatstaal dunwandig vierkant | | | | | | | | | |
| | | 0360619 | 80x80x8cm | wit | 0360619 | stuk | 45,50 | 062 | 0 | |
| | | 0370005 | 80x80x8cm | pergamon | 0370005 | stuk | 48,50 | 062 | 0 | |
| | | 0360035 | 80x80x15cm | wit | 0360035 | stuk | 48,25 | 062 | 0 | |
| | | 0370013 | 80x80x15cm | pergamon | 0370013 | stuk | 52,00 | 062 | 0 | |
| | Baden / douchebakken / stoomcabines | | 0360554 | 90x90x15cm | wit | 0360554 | stuk | 78,50 | 062 | 0 |
| | | | 0370878 | 90x90x15cm | pergamon | 0370878 | stuk | 86,50 | 062 | 0 |
| | | 0360309 | douchebaksteun m. 3 verstelbare poten 125-195mm | | 3SGS | stuk | 12,25 | 062 | 0 | |
| Kranen | | Plieger Brussel | | | | | | | | |
| | douchebak plaatstaal dikwandig vierkant | | | | | | | | | |
| | | 0361568 | 80x80x15cm | wit | 0361568 | stuk | 75,00 | 061 | 0 | |
| | | 0361576 | 80x80x15cm | pergamon | 0361576 | stuk | 135,00 | 061 | 1 | |
| | | 0361584 | 90x90x15cm | wit | 0361584 | stuk | 79,50 | 061 | 0 | |
| Douchegarnituur | | 0360309 | douchebaksteun m. 3 verstelbare poten 125-195mm | | 3SGS | stuk | 12,25 | 062 | 0 | |
| Accessoires en spiegels | | | | | | | | | | |
| Douchewanden | | | | | | | | | | |
| Toebehoren & afvoeren | | | | | | | | | | |
| Spoel- & installatiesystemen | | | | | | | | | | |
| Badkamermeubelen en toiletkasten | | | | | | | | | | |
| Gootstenen en wastroggen | | | | | | | | | | |
| Utiliteit | | | | | | | | | | |

| Art.nr | Specificaties | Kleur | Lev.nr | Ehd | Prijs | Grp | CC |
|---|---------------|--------------------------|-------------|-----------------|-------|---------|-------|
| Duravit 2nd Floor | | | | | | | |
| kunststof bad acryl rechthoekig | | | | | | | |
| 0290397 | 170x75cm | voor inbouw incl. afvoer | wit | 700085000000000 | stuk | 865,00 | 092 1 |
| 0290398 | 180x80cm | voor inbouw incl. afvoer | wit | 700086000000000 | stuk | 925,00 | 092 0 |
| 0290399 | 210x90cm | voor inbouw incl. afvoer | wit | 700087000000000 | stuk | 1155,00 | 092 1 |
| 0290400 | 170x75cm | voor paneel incl. afvoer | wit | 700080000000000 | stuk | 1220,00 | 092 1 |
| 0290401 | 180x80cm | voor paneel incl. afvoer | wit | 700081000000000 | stuk | 1285,00 | 092 1 |
| 0290402 | 210x90cm | voor paneel incl. afvoer | wit | 700082000000000 | stuk | 1645,00 | 092 1 |
| voor- en zijpaneel | | | | | | | |
| 0290411 | | links v. 700080 | palissander | 878267 | stuk | 520,00 | 092 1 |
| 0290431 | | links v. 700081 | palissander | 878367 | stuk | 530,00 | 092 1 |
| 0290460 | | links v. 700082 | palissander | 878467 | stuk | 540,00 | 092 1 |
| 0290412 | | links v. 700080 | eiken | 878265 | stuk | 727,00 | 092 1 |
| 0290433 | | links v. 700081 | eiken | 878365 | stuk | 737,00 | 092 1 |
| 0290461 | | links v. 700082 | eiken | 878465 | stuk | 747,00 | 092 1 |
| 0290409 | | rechts v. 700080 | palissander | 878767 | stuk | 520,00 | 092 1 |
| 0290429 | | rechts v. 700081 | palissander | 878867 | stuk | 530,00 | 092 1 |
| 0290458 | | rechts v. 700082 | palissander | 878967 | stuk | 540,00 | 092 1 |
| 0290410 | | rechts v. 700080 | eiken | 878765 | stuk | 727,00 | 092 1 |
| 0290430 | | rechts v. 700081 | eiken | 878865 | stuk | 737,00 | 092 1 |
| 0290459 | | rechts v. 700082 | eiken | 878965 | stuk | 747,00 | 092 1 |
| voor- en 2 zijpanelen | | | | | | | |
| 0290413 | | v. 700080 | palissander | 877767 | stuk | 662,00 | 092 1 |
| 0290434 | | v. 700081 | palissander | 877867 | stuk | 672,00 | 092 1 |
| 0290462 | | v. 700082 | palissander | 877967 | stuk | 682,00 | 092 1 |
| 0290414 | | v. 700080 | eiken | 877765 | stuk | 819,00 | 092 1 |
| 0290435 | | v. 700081 | eiken | 877865 | stuk | 829,00 | 092 1 |
| 0290463 | | v. 700082 | eiken | 877965 | stuk | 839,00 | 092 1 |
| 2 voor- en 2 zijpanelen | | | | | | | |
| 0290415 | | v. 700080 | palissander | 877267 | stuk | 859,00 | 092 1 |
| 0290436 | | v. 700081 | palissander | 877367 | stuk | 869,00 | 092 1 |
| 0290464 | | v. 700082 | palissander | 877467 | stuk | 997,00 | 092 1 |
| 0290416 | | v. 700080 | eiken | 877265 | stuk | 1260,00 | 092 1 |
| 0290437 | | v. 700081 | eiken | 877365 | stuk | 1270,00 | 092 1 |
| 0290465 | | v. 700082 | eiken | 877465 | stuk | 1295,00 | 092 1 |
| badpaneel m. opstappedeelte v. kop opstelling | | | | | | | |
| 0290553 | 209x114cm | links v. 700080 | palissander | 880667 | stuk | 2234,00 | 092 1 |
| 0290557 | 219x119cm | links v. 700081 | palissander | 880767 | stuk | 2234,00 | 092 1 |
| 0290554 | 209x114cm | links v. 700080 | eiken | 880665 | stuk | 2821,00 | 092 1 |
| 0290558 | 219x119cm | links v. 700081 | eiken | 880765 | stuk | 2821,00 | 092 1 |
| 0290555 | 209x114cm | rechts v. 700080 | palissander | 880867 | stuk | 2234,00 | 092 1 |
| 0290559 | 219x119cm | rechts v. 700081 | palissander | 880967 | stuk | 2234,00 | 092 1 |
| 0290556 | 209x114cm | rechts v. 700080 | eiken | 880865 | stuk | 2821,00 | 092 1 |
| 0290561 | 219x119cm | rechts v. 700081 | eiken | 880965 | stuk | 2821,00 | 092 1 |
| badpaneel m. opstappedeelte v. hoek opstelling | | | | | | | |
| 0290419 | 209x114cm | links v. 700080 | palissander | 880267 | stuk | 1930,00 | 092 1 |
| 0290448 | 219x119cm | links v. 700081 | palissander | 880367 | stuk | 1930,00 | 092 1 |
| 0290420 | 209x114cm | links v. 700080 | eiken | 880265 | stuk | 2323,00 | 092 1 |
| 0290449 | 219x119cm | links v. 700081 | eiken | 880365 | stuk | 2323,00 | 092 1 |
| 0290417 | 209x114cm | rechts v. 700080 | palissander | 880467 | stuk | 1930,00 | 092 1 |
| 0290438 | 219x119cm | rechts v. 700081 | palissander | 880567 | stuk | 1930,00 | 092 1 |
| 0290418 | 209x114cm | rechts v. 700080 | eiken | 880465 | stuk | 2323,00 | 092 1 |
| 0290439 | 219x119cm | rechts v. 700081 | eiken | 880565 | stuk | 2323,00 | 092 1 |
| badpaneel m. opstappedeelte v. muur opstelling | | | | | | | |
| 0290421 | 209x114cm | links v. 700080 | palissander | 879867 | stuk | 2035,00 | 092 1 |
| 0290450 | 219x119cm | links v. 700081 | palissander | 879967 | stuk | 2035,00 | 092 1 |
| 0290422 | 209x114cm | links v. 700080 | eiken | 879865 | stuk | 2375,00 | 092 1 |
| 0290451 | 219x119cm | links v. 700081 | eiken | 879965 | stuk | 2375,00 | 092 1 |
| 0290423 | 209x114cm | rechts v. 700080 | palissander | 880067 | stuk | 2035,00 | 092 1 |
| 0290452 | 219x119cm | rechts v. 700081 | palissander | 880167 | stuk | 2035,00 | 092 1 |
| 0290424 | 209x114cm | rechts v. 700080 | eiken | 880065 | stuk | 2375,00 | 092 1 |
| 0290453 | 219x119cm | rechts v. 700081 | eiken | 880165 | stuk | 2375,00 | 092 1 |

Sanitair producten

Baden /
douchebakken /
stoomcabines

Kranen

Douchegarnituur











Accessoires en
spiegels

Douchewanden

Toebehoren &
afvoerenSpoel- &
installatiesystemenBadkamermeubelen
en toiletkastenGootstenen en
wastroggen

Utiliteit

| | Art.nr | Specificaties | Kleur | Lev.nr | Ehd | Prijs | Grp | CC |
|---|--|--|-------------|------------------|------|---------|-----|----|
| | Duravit 2nd Floor | | | | | | | |
| | badpaneel m. opstappedeelte v. vrijstaande opstelling | | | | | | | |
| Sanitair producten | 0290425 | 209x114cm links v. 700080 | palissander | 879067 | stuk | 2234,00 | 092 | 1 |
| | 0290454 | 219x119cm links v. 700081 | palissander | 879167 | stuk | 2234,00 | 092 | 1 |
| Baden / douchebakken / stoomcabines | 0290426 | 209x114cm links v. 700080 | eiken | 879065 | stuk | 2821,00 | 092 | 1 |
| | 0290455 | 219x119cm links v. 700081 | eiken | 879165 | stuk | 2821,00 | 092 | 1 |
| | 0290427 | 209x114cm rechts v. 700080 | palissander | 879267 | stuk | 2234,00 | 092 | 1 |
| | 0290456 | 219x119cm rechts v. 700081 | palissander | 879367 | stuk | 2234,00 | 092 | 1 |
| | 0290428 | 209x114cm rechts v. 700080 | eiken | 879265 | stuk | 2821,00 | 092 | 1 |
| | 0290457 | 219x119cm rechts v. 700081 | eiken | 879365 | stuk | 2821,00 | 092 | 1 |
| | Duravit 2x3 | | | | | | | |
| Kranen | kunststof bad acryl zeshoekig | | | | | | | |
| | 0316504 | 190x90cm m. poten | wit | 7000250000000000 | stuk | 1042,00 | 092 | 1 |
| | 0316512 | 200x100cm m. poten | wit | 7000260000000000 | stuk | 1248,00 | 092 | 1 |
| | Duravit Daro | | | | | | | |
| Douchegarnituur | kunststof bad acryl rechthoekig | | | | | | | |
| | 0316520 | 170x75cm m. poten | wit | 7000290000000000 | stuk | 559,00 | 092 | 1 |
| | 0316539 | 180x80cm afvoer midden m. poten | wit | 7000300000000000 | stuk | 702,00 | 092 | 0 |
| Accessoires en spiegels | Duravit HappyD | | | | | | | |
| | kunststof bad acryl rechthoekig inbouw | | | | | | | |
| | 0316547 | 180x80cm m. poten | wit | 7000210000000000 | stuk | 764,00 | 092 | 1 |
| Douchewanden | kunststof bad acryl rechthoekig opbouw | | | | | | | |
| | 0316555 | 180x80cm m. poten | wit | 7000220000000000 | stuk | 867,00 | 092 | 1 |
| Toebehoren & afvoeren | kunststof bad acryl Back-to-Wall | | | | | | | |
| | 0316563 | 180x80cm m. poten m. paneel | wit | 7000160000000000 | stuk | 1638,00 | 092 | 0 |
| Spool- & installatiesystemen | kunststof bad acryl hoek rechts | | | | | | | |
| | 0316571 | 180x80cm m. poten m. paneel | wit | 7000170000000000 | stuk | 1638,00 | 092 | 1 |
| Badkamermeubelen en toiletkasten | kunststof bad acryl hoek links | | | | | | | |
| | 0316598 | 180x80cm m. poten m. paneel | wit | 7000180000000000 | stuk | 1638,00 | 092 | 1 |
| Gootstenen en wastroggen | kunststof bad acryl vrijstaand | | | | | | | |
| | 0316602 | 180x80cm m. paneel | wit | 7000190000000000 | stuk | 3348,00 | 092 | 1 |
| | 0263059 | 180x80cm m. paneel | noten | 7013190000000000 | stuk | 3657,00 | 016 | 1 |
| | 0263061 | 180x80cm m. paneel | b-horn | 7021190000000000 | stuk | 3451,00 | 016 | 1 |
| | 0263060 | 180x80cm m. paneel | kersen | 7026190000000000 | stuk | 3657,00 | 016 | 1 |
| Utiliteit | 0316822 | spec. af- en overloopgarn. vrijstaand bad m. waste | chroom | 7902060000000000 | stuk | 108,00 | 016 | 1 |
| | 0316830 | spec. af- en overloopgarn. vrijstaand bad m. triowaste | chroom | 7902070000000000 | stuk | 307,00 | 016 | 1 |
| | Duravit Paiova | | | | | | | |
| | kunststof bad acryl links | | | | | | | |
| | 0290227 | 170x130cm voor ombouw m. poten | wit | 7000390000000000 | stuk | 1174,00 | 092 | 1 |
| | 0290226 | 170x130cm m. poten | wit | 7000430000000000 | stuk | 1114,00 | 092 | 1 |
| | 0290233 | 180x140cm voor ombouw m. poten | wit | 7000410000000000 | stuk | 1277,00 | 092 | 1 |
| | 0290232 | 180x140cm m. poten | wit | 7000450000000000 | stuk | 1217,00 | 092 | 0 |
| | kunststof bad acryl rechts | | | | | | | |
| | 0290231 | 170x130cm voor ombouw m. poten | wit | 7000400000000000 | stuk | 1174,00 | 092 | 1 |
| | 0290230 | 170x130cm m. poten | wit | 7000440000000000 | stuk | 1114,00 | 092 | 1 |
| | 0290235 | 180x140cm voor ombouw m. poten | wit | 7000420000000000 | stuk | 1277,00 | 092 | 1 |
| | 0290234 | 180x140cm m. poten | wit | 7000460000000000 | stuk | 1217,00 | 092 | 0 |
| | nekkussen | | | | | | | |
| | 0290228 | | wit | 7900010000000000 | stuk | 77,00 | 092 | 0 |
| | 0290229 | | licht blauw | 7900013100000000 | stuk | 77,00 | 092 | 1 |

| Art.nr | Specificaties | Kleur | Lev.nr | Ehd | Prijs | Grp | CC | | |
|---|-----------------------------|----------|-----------------|------|---------|-----|----|---|---|
| | | | | | | | | Duravit Philippe Starck | |
| kunststof bad acryl ovaal | | | | | | | | | |
| 0315702 | 180x80cm m. poten | wit | 700013000000000 | stuk | 1327,00 | 092 | 1 |  | Sanitair producten |
| 0315710 | 180x80cm m. poten | pergamon | 700013470000000 | stuk | 1327,00 | 092 | 1 | | |
| 0315729 | 180x80cm m. paneel m. poten | wit | 700010000000000 | stuk | 3703,00 | 092 | 1 |  | Baden / douchebakken / stoomcabines |
| 0315737 | 180x80cm m. paneel m. poten | pergamon | 700010470000000 | stuk | 3703,00 | 092 | 1 | | |
| 0315745 | 190x90cm m. poten | wit | 700014000000000 | stuk | 1539,00 | 092 | 1 | | |
| 0315753 | 190x90cm m. poten | pergamon | 700014470000000 | stuk | 1539,00 | 092 | 1 | | |
| 0315761 | 190x90cm m. paneel m. poten | wit | 700012000000000 | stuk | 4233,00 | 092 | 1 | | |
| 0315788 | 190x90cm m. paneel m. poten | pergamon | 700012470000000 | stuk | 4233,00 | 092 | 1 | | |
| | | | | | | | | Duravit Philippe Starck 3 | |
| kunststof bad acryl rechthoekig m. neksteun m. poten | | | | | | | | | |
| 0316610 | 160x70cm | wit | 700005000000000 | stuk | 584,00 | 092 | 0 |  | Kranen |
| 0313289 | 160x70cm | pergamon | 700005470000000 | stuk | 584,00 | 092 | 1 | | |
| 0316611 | 170x70cm | wit | 700006000000000 | stuk | 584,00 | 092 | 0 |  | Douchegarnituur |
| 0313297 | 170x70cm | pergamon | 700006470000000 | stuk | 584,00 | 092 | 1 | | |
| 0316612 | 170x75cm | wit | 700007000000000 | stuk | 599,00 | 092 | 0 | | |
| 0313300 | 170x75cm | pergamon | 700007470000000 | stuk | 599,00 | 092 | 1 | | |
| 0316613 | 180x80cm | wit | 700008000000000 | stuk | 812,00 | 092 | 0 | | |
| 0313319 | 180x80cm | pergamon | 700008470000000 | stuk | 812,00 | 092 | 1 | | |
| 0290148 | 190x90cm | wit | 700033000000000 | stuk | 891,00 | 092 | 1 | Accessoires en spiegels | |
| 0290149 | 190x90cm | pergamon | 700033470000000 | stuk | 891,00 | 092 | 1 | | |
| 0290150 | 200x100cm | wit | 700034000000000 | stuk | 1107,00 | 092 | 1 | | |
| 0290151 | 200x100cm | pergamon | 700034470000000 | stuk | 1107,00 | 092 | 1 | | |
| | | | | | | | | | Duravit Philippe Starck X |
| kunststof bad rechthoekig afvoer midden | | | | | | | | | |
| 0263062 | 232x142cm m. steen | wit | 700057000001000 | stuk | 6355,00 | 092 | 1 |  | Douchewanden |
| 0263063 | 232x142cm m. hout | wit | 700058000001000 | stuk | 6747,00 | 092 | 1 | | |
| kunststof bad rechthoekig afvoer zijkant | | | | | | | | | |
| 0263064 | 232x142cm m. steen | wit | 700059000001000 | stuk | 6355,00 | 092 | 1 |  | Toebehoren & afvoeren |
| 0263065 | 232x142cm m. hout | wit | 700060000001000 | stuk | 6747,00 | 092 | 1 | | |
| | | | | | | | | Duravit Philippe Starck X | |
| kunststof bad rechthoekig afvoer zijkant | | | | | | | | | |
| 0263064 | 232x142cm m. steen | wit | 700059000001000 | stuk | 6355,00 | 092 | 1 |  | Spoel- & installatiesystemen |
| 0263065 | 232x142cm m. hout | wit | 700060000001000 | stuk | 6747,00 | 092 | 1 | | |
| | | | | | | | | Duravit Philippe Starck X | |
| kunststof bad rechthoekig afvoer zijkant | | | | | | | | | |
| 0263064 | 232x142cm m. steen | wit | 700059000001000 | stuk | 6355,00 | 092 | 1 |  | Badkamermeubelen en toiletkasten |
| 0263065 | 232x142cm m. hout | wit | 700060000001000 | stuk | 6747,00 | 092 | 1 | | |
| | | | | | | | | Duravit Philippe Starck X | |
| kunststof bad rechthoekig afvoer zijkant | | | | | | | | | |
| 0263064 | 232x142cm m. steen | wit | 700059000001000 | stuk | 6355,00 | 092 | 1 |  | Gootstenen en wastroggen |
| 0263065 | 232x142cm m. hout | wit | 700060000001000 | stuk | 6747,00 | 092 | 1 | | |
| | | | | | | | | Duravit Philippe Starck X | |
| kunststof bad rechthoekig afvoer zijkant | | | | | | | | | |
| 0263064 | 232x142cm m. steen | wit | 700059000001000 | stuk | 6355,00 | 092 | 1 |  | Utiliteit |
| 0263065 | 232x142cm m. hout | wit | 700060000001000 | stuk | 6747,00 | 092 | 1 | | |

| | Art.nr | Specificaties | Kleur | Lev.nr | Ehd | Prijs | Grp | CC | |
|---|---------|--|-------|-----------------|-----------------|---------|--------|-----|---|
| Duravit Philippe Starck X | | | | | | | | | |
| kunststof bad rechthoekig afvoer midden | | | | | | | | | |
| Sanitair producten | 0263066 | 232x142cm m. steen | wit | 700061000001000 | stuk | 6355,00 | 092 | 1 | |
| | 0263067 | 232x142cm m. hout | wit | 700062000001000 | stuk | 6747,00 | 092 | 1 | |
| | 0263068 | 180x90cm m. overloop | wit | 700048000000000 | stuk | 1090,00 | 092 | 1 | |
| Baden / douchebakken / stoomcabines | 0313475 | badpoten voor bad per 2 stuks | | 7901000000000 | stuk | 64,00 | 092 | 0 | |
| | 0313483 | wandbevestiging voor bad en douchebak per 3 stuks | | 790103000000000 | stuk | 27,00 | 092 | 1 | |
| | 0313556 | wandprofiel voor isolatie per rol 3.30meter | | 790104000000000 | stuk | 44,00 | 092 | 1 | |
| | 0316849 | af- en overloopgarn. bad m. middenafvoer m. waste | chrom | 790204000001000 | stuk | 108,00 | 016 | 0 | |
| | 0316857 | af- en overloopgarn. bad m. middenafvoer m. triowaste | chr. | 790205000001000 | stuk | 267,00 | 016 | 1 | |
| Kranen | | | | | | | | | |
| | | | | | | | | | |
| Douchegarnituur | | | | | | | | | |
| Accessoires en spiegels | | | | | | | | | |
| kunststof bad rechthoekig afvoer zijkant | | | | | | | | | |
| Douchewanden | 0263069 | 180x90cm m. overloop | wit | 700055000000000 | stuk | 1123,00 | 092 | 1 | |
| | 0313475 | badpoten voor bad per 2 stuks | | 7901000000000 | stuk | 64,00 | 092 | 0 | |
| | 0313483 | wandbevestiging voor bad en douchebak per 3 stuks | | 790103000000000 | stuk | 27,00 | 092 | 1 | |
| | 0313491 | af- en overloopgarnituur 50mm | | chrom | 790201000001000 | stuk | 87,00 | 092 | 0 |
| | 0313505 | overloopvulcombinatie 50mm | | chrom | 790202000001000 | stuk | 253,00 | 092 | 1 |
| Toebehoren & afvoeren | 0313556 | wandprofiel voor isolatie per rol 3.30meter | | 790104000000000 | stuk | 44,00 | 092 | 1 | |
| kunststof bad rechthoekig afvoer midden | | | | | | | | | |
| Spoel- & installatiesystemen | 0263070 | 180x90cm m. overloop | wit | 700056000000000 | stuk | 1123,00 | 092 | 1 | |
| | 0313475 | badpoten voor bad per 2 stuks | | 7901000000000 | stuk | 64,00 | 092 | 0 | |
| | 0313483 | wandbevestiging voor bad en douchebak per 3 stuks | | 790103000000000 | stuk | 27,00 | 092 | 1 | |
| | 0313556 | wandprofiel voor isolatie per rol 3.30meter | | 790104000000000 | stuk | 44,00 | 092 | 1 | |
| | 0316849 | af- en overloopgarn. bad m. middenafvoer m. waste | chrom | 790204000001000 | stuk | 108,00 | 016 | 0 | |
| Badkamermeubelen en toiletkasten | 0316857 | af- en overloopgarn. bad m. middenafvoer m. triowaste | chr. | 790205000001000 | stuk | 267,00 | 016 | 1 | |
| Duravit Toebehoren | | | | | | | | | |
| Gootstenen en wastroggen | 0313475 | badpoten voor bad per 2 stuks | | 7901000000000 | stuk | 64,00 | 092 | 0 | |
| | 0313491 | af- en overloopgarnituur 50mm | | chrom | 790201000001000 | stuk | 87,00 | 092 | 0 |
| | 0313505 | overloopvulcombinatie 50mm | | chrom | 790202000001000 | stuk | 253,00 | 092 | 1 |
| | 0316806 | schoonmaakkit voor acrylbaden | | 7903010000000 | stuk | 60,00 | 016 | 1 | |
| | 0316814 | schoonmaak + reparatiekit acrylbaden | | 7903020000000 | stuk | 115,00 | 016 | 1 | |
| Utiliteit | 0316822 | spec. af- en overloopgarn. vrijstaand bad m. waste | chrom | 790206000000000 | stuk | 108,00 | 016 | 1 | |
| | 0316830 | spec. af- en overloopgarn. vrijstaand bad m. triowaste | chrom | 790207000000000 | stuk | 307,00 | 016 | 1 | |
| | 0316849 | af- en overloopgarn. bad m. middenafvoer m. waste | chrom | 790204000001000 | stuk | 108,00 | 016 | 0 | |
| | 0316857 | af- en overloopgarn. bad m. middenafvoer m. triowaste | chr. | 790205000001000 | stuk | 267,00 | 016 | 1 | |

| Art.nr | Specificaties | Kleur | Lev.nr | Ehd | Prijs | Grp | CC |
|--------|---------------|-------|--------|-----|-------|-----|----|
|--------|---------------|-------|--------|-----|-------|-----|----|

Duravit 2nd Floor

kunststof douchebak acryl vierkant

| | | | | | | | |
|---------|----------------|-----|----------------|------|--------|-----|---|
| 0290404 | 90x90x10.5cm | wit | 72004600000000 | stuk | 410,00 | 092 | 0 |
| 0290407 | 100x100x10.5cm | wit | 72005000000000 | stuk | 490,00 | 092 | 0 |

kunststof douchebak acryl rechthoekig

| | | | | | | | |
|---------|----------------|-----|----------------|------|--------|-----|---|
| 0290403 | 80x120x10.5cm | wit | 72004500000000 | stuk | 470,00 | 092 | 1 |
| 0290405 | 90x140x10.5cm | wit | 72004800000000 | stuk | 605,00 | 092 | 1 |
| 0290406 | 90x180x10.5cm | wit | 72004900000000 | stuk | 730,00 | 092 | 1 |
| 0290408 | 100x120x10.5cm | wit | 72005100000000 | stuk | 525,00 | 092 | 1 |

styropor douchebakdrager

| | | | | | | | |
|---------|-------------|--|----------------|------|--------|-----|---|
| 0290274 | voor 720046 | | 79046200000000 | stuk | 92,00 | 092 | 1 |
| 0290275 | voor 720050 | | 79046600000000 | stuk | 131,00 | 092 | 1 |
| 0290278 | voor 720051 | | 79046700000000 | stuk | 114,00 | 092 | 1 |
| 0290279 | voor 720045 | | 79046100000000 | stuk | 106,00 | 092 | 1 |
| 0290280 | voor 720048 | | 79046400000000 | stuk | 153,00 | 092 | 1 |
| 0290281 | voor 720049 | | 79046500000000 | stuk | 153,00 | 092 | 1 |

Duravit HappyD

kunststof douchebak hoekmodel m. paneel

| | | | | | | | |
|---------|------------|-----|----------------|------|--------|-----|---|
| 0316628 | 90x90x8cm | wit | 72002000000000 | stuk | 361,00 | 092 | 1 |
| 0316636 | 100x100x8 | wit | 72002200000000 | stuk | 464,00 | 092 | 1 |
| 0316644 | 90x90x18cm | wit | 72002100000000 | stuk | 464,00 | 092 | 1 |
| 0316652 | 100x100x18 | wit | 72002300000000 | stuk | 567,00 | 092 | 1 |



kunststof douchebak back-to-wall z. paneel

| | | | | | | | |
|---------|------------|-----|----------------|------|--------|-----|---|
| 0316660 | 100x80x8cm | wit | 72002400000000 | stuk | 361,00 | 092 | 1 |
| 0316679 | 120x90x8cm | wit | 72002600000000 | stuk | 505,00 | 092 | 1 |
| 0316687 | 120x100x8 | wit | 72002800000000 | stuk | 546,00 | 092 | 1 |



kunststof douchebak back-to-wall m. paneel

| | | | | | | | |
|---------|-------------|-----|----------------|------|--------|-----|---|
| 0316695 | 100x80x18cm | wit | 72002500000000 | stuk | 464,00 | 092 | 1 |
| 0316709 | 120x90x18cm | wit | 72002700000000 | stuk | 608,00 | 092 | 1 |
| 0316717 | 120x100x18 | wit | 72002900000000 | stuk | 649,00 | 092 | 1 |

Duravit Philippe Starck 3

kunststof douchebak acryl kwarttrond

| | | | | | | | | |
|---------|-----------|-----------|----------|----------------|------|--------|-----|---|
| 0313130 | 90x90cm | z. paneel | wit | 72000100000000 | stuk | 573,00 | 092 | 1 |
| 0313327 | 90x90cm | z. paneel | pergamon | 72000147000000 | stuk | 573,00 | 092 | 1 |
| 0313149 | 100x100cm | z. paneel | wit | 72000300000000 | stuk | 681,00 | 092 | 1 |
| 0313335 | 100x100cm | z. paneel | pergamon | 72000347000000 | stuk | 681,00 | 092 | 1 |
| 0313157 | 90x90cm | m. paneel | wit | 72000200000000 | stuk | 599,00 | 092 | 1 |
| 0313343 | 90x90cm | m. paneel | pergamon | 72000247000000 | stuk | 599,00 | 092 | 1 |
| 0313165 | 100x100cm | m. paneel | wit | 72000400000000 | stuk | 708,00 | 092 | 1 |
| 0313351 | 100x100cm | m. paneel | pergamon | 72000447000000 | stuk | 708,00 | 092 | 1 |
| 0290206 | 90x90cm | z. paneel | wit | 72003000000000 | stuk | 541,00 | 092 | 1 |
| 0290207 | 90x90cm | z. paneel | pergamon | 72003047000000 | stuk | 541,00 | 092 | 1 |
| 0290208 | 100x100cm | z. paneel | wit | 72003200000000 | stuk | 654,00 | 092 | 1 |
| 0290209 | 100x100cm | z. paneel | pergamon | 72003247000000 | stuk | 654,00 | 092 | 1 |



kunststof douchebak acryl vijfhoekig

| | | | | | | | | |
|---------|-----------|-----------|----------|----------------|------|--------|-----|---|
| 0313173 | 90x90cm | z. paneel | wit | 72000500000000 | stuk | 573,00 | 092 | 1 |
| 0313378 | 90x90cm | z. paneel | pergamon | 72000547000000 | stuk | 573,00 | 092 | 1 |
| 0313181 | 100x100cm | z. paneel | wit | 72000700000000 | stuk | 681,00 | 092 | 1 |
| 0313386 | 100x100cm | z. paneel | pergamon | 72000747000000 | stuk | 681,00 | 092 | 1 |
| 0313203 | 90x90cm | m. paneel | wit | 72000600000000 | stuk | 599,00 | 092 | 1 |
| 0313211 | 100x100cm | m. paneel | wit | 72000800000000 | stuk | 708,00 | 092 | 1 |
| 0313408 | 100x100cm | m. paneel | pergamon | 72000847000000 | stuk | 708,00 | 092 | 1 |



kunststof douchebak acryl vierkant

| | | | | | | | | |
|---------|-----------|--|----------|----------------|------|--------|-----|---|
| 0313238 | 80x80cm | | wit | 72000900000000 | stuk | 335,00 | 092 | 1 |
| 0313416 | 80x80cm | | pergamon | 72000947000000 | stuk | 335,00 | 092 | 1 |
| 0313246 | 90x90cm | | wit | 72001000000000 | stuk | 356,00 | 092 | 0 |
| 0313424 | 90x90cm | | pergamon | 72001047000000 | stuk | 356,00 | 092 | 1 |
| 0313254 | 100x100cm | | wit | 72001100000000 | stuk | 465,00 | 092 | 0 |
| 0313432 | 100x100cm | | pergamon | 72001147000000 | stuk | 465,00 | 092 | 1 |



Sanitair producten

Baden /
douchebakken /
stoomcabines

Kranen

Douchegarnituur

Accessoires en
spiegels

Douchewanden

Toebehoren &
afvoeren

Spoel- &
installatiesystemen

Badkamermeubelen
en toiletkasten

Gootstenen en
wastroggen

Utiliteit

| | Art.nr | Specificaties | Kleur | Lev.nr | Ehd | Prijs | Grp | CC |
|---|--|--|----------|-----------------|------|--------|-----|----|
| | Duravit Philippe Starck 3 | | | | | | | |
| | kunststof douchebak acryl rechthoekig | | | | | | | |
| Sanitair producten | 0316725 | 80x100x8.5 | wit | 7200140000000 | stuk | 366,00 | 092 | 1 |
| | 0290236 | 80x100x8.5 | pergamon | 720014470000000 | stuk | 366,00 | 092 | 1 |
| Baden / douchebakken / stoomcabines | 0316741 | 80x120x8.5 | wit | 7200160000000 | stuk | 407,00 | 092 | 0 |
| | 0290253 | 80x120x8.5 | pergamon | 720016470000000 | stuk | 407,00 | 092 | 1 |
| | 0313262 | 90x75cm | wit | 7200120000000 | stuk | 346,00 | 092 | 1 |
| | 0313440 | 90x75cm | pergamon | 7200124700000 | stuk | 346,00 | 092 | 1 |
| | 0313270 | 90x80cm | wit | 7200130000000 | stuk | 356,00 | 092 | 1 |
| | 0313459 | 90x80cm | pergamon | 7200134700000 | stuk | 356,00 | 092 | 1 |
| Kranen | 0316733 | 90x100x8.5 | wit | 7200150000000 | stuk | 376,00 | 092 | 0 |
| | 0290237 | 90x100x8.5 | pergamon | 720015470000000 | stuk | 376,00 | 092 | 1 |
| | 0316768 | 90x120x8.5 | wit | 7200170000000 | stuk | 448,00 | 092 | 0 |
| Douchegarnituur | 0290254 | 90x120x8.5 | pergamon | 720017470000000 | stuk | 448,00 | 092 | 1 |
| | 0316776 | 100x120x8.5 | wit | 7200180000000 | stuk | 505,00 | 092 | 1 |
| | 0290255 | 100x120x8.5 | pergamon | 720018470000000 | stuk | 505,00 | 092 | 1 |
| | 0316792 | 140x75x8.5 | wit | 7200190000000 | stuk | 577,00 | 092 | 1 |
| | 0290256 | 140x75x8.5 | pergamon | 720019470000000 | stuk | 577,00 | 092 | 1 |
| Accessoires en spiegels | 0290210 | 140x70cm | wit | 720034000000000 | stuk | 569,00 | 092 | 1 |
| | 0290211 | 140x70cm | pergamon | 720034470000000 | stuk | 569,00 | 092 | 1 |
| | 0290212 | 140x90cm | wit | 720035000000000 | stuk | 634,00 | 092 | 1 |
| | 0290213 | 140x90cm | pergamon | 720035470000000 | stuk | 634,00 | 092 | 1 |
| Douchewanden | 0290214 | 150x70cm | wit | 720036000000000 | stuk | 588,00 | 092 | 1 |
| | 0290215 | 150x70cm | pergamon | 720036470000000 | stuk | 588,00 | 092 | 1 |
| | 0290216 | 160x70cm | wit | 720038000000000 | stuk | 609,00 | 092 | 1 |
| | 0290217 | 160x70cm | pergamon | 720038470000000 | stuk | 609,00 | 092 | 1 |
| | 0290218 | 160x75cm | wit | 720039000000000 | stuk | 621,00 | 092 | 1 |
| | 0290219 | 160x75cm | pergamon | 720039470000000 | stuk | 621,00 | 092 | 1 |
| Toebehoren & afvoeren | 0290220 | 160x90cm | wit | 720040000000000 | stuk | 672,00 | 092 | 1 |
| | 0290221 | 160x90cm | pergamon | 720040470000000 | stuk | 672,00 | 092 | 1 |
| | 0290222 | 170x90cm | wit | 720041000000000 | stuk | 763,00 | 092 | 1 |
| | 0290223 | 170x90cm | pergamon | 720041470000000 | stuk | 763,00 | 092 | 1 |
| | 0290224 | 180x90cm | wit | 720042000000000 | stuk | 842,00 | 092 | 1 |
| Spoel- & installatiesystemen | 0290225 | 180x90cm | pergamon | 720042470000000 | stuk | 842,00 | 092 | 1 |
| | Duravit Philippe Starck X | | | | | | | |
| | houten vlonder voor douchebak 720011 | | | | | | | |
| Badkamermeubelen en toiletkasten | 0263124 | 88x88cm | hout | 790807000000000 | stuk | 494,00 | 092 | 1 |
| | 0313254 | kunststof douchebak acryl vierkant 100x100cm | wit | 7200110000000 | stuk | 465,00 | 092 | 0 |
| | 0313432 | kunststof douchebak acryl vierkant 100x100cm | pergamon | 7200114700000 | stuk | 465,00 | 092 | 1 |
| | houten vlonder voor douchebak 720035 | | | | | | | |
| Gootstenen en wastroggen | 0263125 | 128x78cm | hout | 790808000000000 | stuk | 567,00 | 092 | 1 |
| | 0290212 | kunststof douchebak acryl rechthoekig 140x90cm | wit | 720035000000000 | stuk | 634,00 | 092 | 1 |
| | 0290213 | kunststof douchebak acryl rechthoekig 140x90cm | pergamon | 720035470000000 | stuk | 634,00 | 092 | 1 |
| | houten vlonder voor douchebak 720040 | | | | | | | |
| Utiliteit | 0263126 | 148x78cm | hout | 790809000000000 | stuk | 649,00 | 092 | 1 |
| | 0290220 | kunststof douchebak acryl rechthoekig 160x90cm | wit | 720040000000000 | stuk | 672,00 | 092 | 1 |
| | 0290221 | kunststof douchebak acryl rechthoekig 160x90cm | pergamon | 720040470000000 | stuk | 672,00 | 092 | 1 |
| | houten vlonder voor douchebak 720032 | | | | | | | |
| Utiliteit | 0263123 | 88x88cm | hout | 790811000000000 | stuk | 530,00 | 092 | 1 |
| | 0290208 | kunststof douchebak acryl kwartrond 100x100cm z. paneel wit | | 720032000000000 | stuk | 654,00 | 092 | 1 |
| | 0290209 | kunststof douchebak acryl kwartrond 100x100cm z. paneel pergamon | | 720032470000000 | stuk | 654,00 | 092 | 1 |

| Art.nr | Specificaties | Kleur | Lev.nr | Ehd | Prijs | Grp | CC |
|--------|---------------|-------|--------|-----|-------|-----|----|
|--------|---------------|-------|--------|-----|-------|-----|----|

Duravit Philippe Starck X

houten vlonder voor douchebak 720042

| | | | | | | | |
|---------|---|--|-----------------|------|--------|-----|---|
| 0263127 | 168x78cm | | 790812000000000 | stuk | 736,00 | 092 | 1 |
| 0290224 | kunststof douchebak acryl rechthoekig 180x90cm wit | | 720042000000000 | stuk | 842,00 | 092 | 1 |
| 0290225 | kunststof douchebak acryl rechthoekig 180x90cm pergamon | | 720042470000000 | stuk | 842,00 | 092 | 1 |



Sanitair producten

Baden /
douchebakken /
stoomcabines

Duravit douchebak Toebehoren

| | | | | | | | |
|---------|---|--|-----------------|------|-------|-----|---|
| 0313513 | douchebakonderstel 85-105mm | | 7901010000000 | stuk | 69,00 | 092 | 0 |
| 0313521 | douchebakonderstel 100-185mm | | 7901020000000 | stuk | 69,00 | 092 | 0 |
| 0313483 | wandbevestiging voor bad en douchebak per 3 stuks | | 790103000000000 | stuk | 27,00 | 092 | 1 |
| 0313556 | wandprofiel voor isolatie per rol 3.30meter | | 790104000000000 | stuk | 44,00 | 092 | 1 |
| 0313548 | afvoer voor douchebak 90mm chroom | | 7902000000010 | stuk | 64,00 | 092 | 1 |

Kranen

Douchegarnituur

Accessoires en
spiegels

Douchewanden

Toebehoren &
afvoerenSpoel- &
installatiesystemenBadkamermeubelen
en toiletkastenGootstenen en
wastroggen

Utiliteit

design



waarin geleefd mag worden











Uw badkamer is de plek voor genieten, ontspannen en bijtanken in een sfeer die bij u past. Daarom let u natuurlijk op design bij de keuze van uw badkamer. Maar in de dagelijkse praktijk moet uw badkamer meer zijn dan een mooi plaatje. Daarom biedt Duscholux kwaliteit en design waarin geleefd mag worden. Voor grote en kleine badkamers; voor luxe en praktische wensen. Duscholux; voor doordachte kwaliteit tot in de kleinste details.









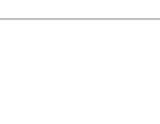

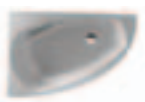



Bezoek ook onze website voor inspirerende badkamerideeën: www.duscholux.nl



Duscholux Nederland B.V. • telefoon: 0347-32 30 00 - Email: info@duscholux.nl

| Art.nr | Specificaties | Kleur | Lev.nr | Ehd | Prijs | Grp | CC | | |
|--|----------------------------------|----------|---------------------------|------|---------|-----|----|---|---|
| Duscholux Ancona | | | | | | | |  | Sanitair producten |
| 225 Trend kunststof bad acryl rechthoekig | | | | | | | | | |
| 0979620 | 180x80cm m. overloop z. poten | wit | 603225000001+699330020078 | stuk | 1354,00 | 276 | 1 | | |
| 0979621 | 180x80cm m. overloop z. poten | pergamon | 603225000061+699330020078 | stuk | 1354,00 | 276 | 1 | | |
| 0987165 | badpotenset | | 699900140 | stuk | 64,00 | 276 | 1 | | Baden / douchebakken / stoomcabines |
| 242 kunststof bad acryl rechthoekig | | | | | | | |  | Kranen |
| 1020676 | 180x80cm m. grepen z. poten | wit | 603242000001 | stuk | 1055,00 | 276 | 1 | | |
| 1020684 | 180x80cm m. grepen z. poten | pergamon | 603242000061 | stuk | 1055,00 | 276 | 1 | | |
| 0987160 | badpotenset | | 699900100 | stuk | 64,00 | 276 | 1 | | Douchegarnituur |
| 112 kunststof bad acryl rechthoekig | | | | | | | |  | Accessoires en spiegels |
| 1021273 | 180x80cm z. poten | wit | 603112000001 | stuk | 1040,00 | 276 | 1 | | |
| 1021281 | 180x80cm z. poten | pergamon | 603112000061 | stuk | 1040,00 | 276 | 1 | | |
| 0987160 | badpotenset | | 699900100 | stuk | 64,00 | 276 | 1 | | Douchegarnituur |
| 117 Free-Line kunststof bad acryl rechthoekig | | | | | | | |  | Accessoires en spiegels |
| 0986769 | 170x75cm z. poten | wit | 603117000001 | stuk | 731,00 | 276 | 1 | | |
| 0987165 | badpotenset | | 699900140 | stuk | 64,00 | 276 | 1 | | Douchewanden |
| 118 Free-Line kunststof bad acryl rechthoekig | | | | | | | |  | Toebehoren & afvoeren |
| 0986770 | 180x80cm z. poten | wit | 603118000001 | stuk | 814,00 | 276 | 1 | | |
| 0987165 | badpotenset | | 699900140 | stuk | 64,00 | 276 | 1 | | Toebehoren & afvoeren |
| 226 Trend kunststof bad acryl rechthoekig | | | | | | | |  | Spoel- & installatiesystemen |
| 0979622 | 190x90cm m. overloop z. poten | wit | 603226000001+699330020078 | stuk | 1457,00 | 276 | 1 | | |
| 0979623 | 190x90cm m. overloop z. poten | pergamon | 603226000061+699330020078 | stuk | 1457,00 | 276 | 1 | | |
| 0987165 | badpotenset | | 699900140 | stuk | 64,00 | 276 | 1 | | Badkamermeubelen en toiletkasten |
| 570 Step-In kunststof bad acryl rechthoekig | | | | | | | |  | Gootstenen en wastroggen |
| 7720865 | 180x80cm z. paneel | wit | 603570000001 | stuk | 6489,00 | 276 | 1 | | |
| 7720866 | 180x80cm z. paneel | pergamon | 603570000061 | stuk | 6489,00 | 276 | 1 | | |
| 7720867 | 180x80cm m. voorpaneel | wit | 603570100001 | stuk | 6901,00 | 276 | 1 | | |
| 7720868 | 180x80cm m. voorpaneel | pergamon | 603570100061 | stuk | 6901,00 | 276 | 1 | | |
| 7720869 | 180x80cm m. voor + zijpaneel | wit | 603570200001 | stuk | 7056,00 | 276 | 1 | | |
| 7720870 | 180x80cm m. voor + zijpaneel | pergamon | 603570200061 | stuk | 7056,00 | 276 | 1 | | Gootstenen en wastroggen |
| Duscholux Cordoba | | | | | | | |  | Utiliteit |
| 534 Free-Line kunststof bad acryl zeshoekig | | | | | | | | | |
| 0986766 | 190x85cm z. poten | wit | 601533000001 | stuk | 1313,00 | 276 | 1 | | |
| 0987165 | badpotenset | | 699900140 | stuk | 64,00 | 276 | 1 | | Utiliteit |
| 533 Free-Line kunststof bad acryl zeshoekig | | | | | | | |  | |
| 0986767 | 200x85cm z. poten | wit | 601534000001 | stuk | 1442,00 | 276 | 1 | | |
| 0987165 | badpotenset | | 699900140 | stuk | 64,00 | 276 | 1 | | |
| Duscholux Malaga | | | | | | | |  | |
| 408 Free-Line kunststof hoekbad acryl | | | | | | | | | |
| 0986754 | 140x140cm m. paneel m. plint | wit | 600408000001 | stuk | 1825,00 | 276 | 1 | | |
| 409 Free-Line kunststof hoekbad acryl | | | | | | | |  | |
| 0986756 | 140x140cm z. paneel m. onderstel | wit | 600409000001 | stuk | 1745,00 | 276 | 1 | | |
| Free-Line paneel voor Malaga 409 | | | | | | | |  | |
| 0986757 | | wit | 699001010001 | stuk | 798,00 | 276 | 1 | | |

| | Art.nr | Specificaties | Kleur | Lev.nr | Ehd | Prijs | Grp | CC |
|---|---|--|--------------|--------------|------|---------|-----|----|
| | Duscholux Malaga | | | | | | | |
| Sanitair producten |  | 412 Free-Line kunststof hoekbad acryl 0986758 155x105cm m. onderstel | wit | 600412000001 | stuk | 1494,00 | 276 | 1 |
| Baden / douchebakken / stoomcabines | | Free-Line paneel voor Malaga 412 0986760 | wit | 699001070001 | stuk | 592,00 | 276 | 1 |
| Kranen |  | 413 Free-Line kunststof hoekbad acryl 0986759 155x105cm m. onderstel | wit | 600413000001 | stuk | 1494,00 | 276 | 1 |
| Douchegarnituur | | Free-Line paneel voor Malaga 413 0986761 | wit | 699001080001 | stuk | 592,00 | 276 | 1 |
| Accessoires en spiegels | | 416 BellaVita Spa kunststof hoekbad acryl 0986762 150x150cm z. paneel m. onderstel | wit | 600416000001 | stuk | 2009,00 | 276 | 1 |
| Douchewanden | | BellaVita Spa paneel voor Malaga 416 0986765 | wit | 699001090001 | stuk | 927,00 | 276 | 1 |
| | Duscholux Portofino | | | | | | | |
| Toebehoren & afvoeren |  | 113 kunststof bad acryl ovaal 0986712 180x80cm z. poten | wit | 602113000001 | stuk | 1025,00 | 276 | 1 |
| | | 0986720 180x80cm z. poten | pergamon | 602113000061 | stuk | 1025,00 | 276 | 1 |
| | | 0986739 180x80cm z. poten | klassiek wit | 602113000117 | stuk | 1025,00 | 276 | 1 |
| | | 0987160 badpotenset | | 699900100 | stuk | 64,00 | 276 | 1 |
| Spoel- & installatiesystemen | | 114 kunststof bad acryl ovaal 1021125 190x80cm z. poten | wit | 602114000001 | stuk | 1185,00 | 276 | 1 |
| | | 1021133 190x80cm z. poten | pergamon | 602114000061 | stuk | 1185,00 | 276 | 1 |
| | | 0987160 badpotenset | | 699900100 | stuk | 64,00 | 276 | 1 |
| Badkamermeubelen en toiletkasten | | 115 kunststof bad acryl ovaal 1021141 190x90cm z. poten | wit | 602115000001 | stuk | 1288,00 | 276 | 1 |
| | | 1021168 190x90cm z. poten | pergamon | 602115000061 | stuk | 1288,00 | 276 | 1 |
| | | 0987160 badpotenset | | 699900100 | stuk | 64,00 | 276 | 1 |
| Gootstenen en wastroggen |  | Free-Line 116 kunststof bad acryl ovaal 0986768 180x80cm z. poten | wit | 602116000001 | stuk | 1025,00 | 276 | 1 |
| | | 0987165 badpotenset | | 699900140 | stuk | 64,00 | 276 | 1 |
| Utiliteit |  | 523 kunststof bad acryl ovaal 1021257 180x85cm z. poten | wit | 602523000001 | stuk | 1082,00 | 276 | 1 |
| | | 1021265 180x85cm z. poten | pergamon | 602523000061 | stuk | 1082,00 | 276 | 1 |
| | | 0987160 badpotenset | | 699900100 | stuk | 64,00 | 276 | 1 |
| |  | 320 kunststof bad acryl ovaal 1021192 190x100cm z. poten | wit | 602320000001 | stuk | 1854,00 | 276 | 1 |
| | | 1021206 190x100cm z. poten | pergamon | 602320000061 | stuk | 1854,00 | 276 | 1 |
| |  | 340 kunststof bad acryl ovaal vrijstaand 1021214 210x105cm z. paneel | wit | 610340000001 | stuk | 4455,00 | 276 | 1 |
| | | 1021222 210x105cm z. paneel | pergamon | 610340000061 | stuk | 4455,00 | 276 | 1 |
| | | 340 voorpaneel voor vrijstaand bad 1021230 | wit | 699101070001 | stuk | 2081,00 | 276 | 1 |
| | | 1021249 | pergamon | 699101070061 | stuk | 2081,00 | 276 | 1 |

| Art.nr | Specificaties | Kleur | Lev.nr | Ehd | Prijs | Grp | CC |
|---|--|-------------|--------------|------|---------|-----|----|
| Duscholux Portofino | | | | | | | |
| 345 kunststof bad acryl ovaal | | | | | | | |
| 0969919 | 190x100cm z. paneel | wit | 610345000001 | stuk | 1777,00 | 276 | 1 |
| 0969921 | 190x100cm z. paneel | pergamon | 610345000061 | stuk | 1777,00 | 276 | 1 |
| 345 frontpaneel voor ovaal bad | | | | | | | |
| 0969925 | | wit | 699101030001 | stuk | 489,00 | 276 | 1 |
| 0969927 | | pergamon | 699101030061 | stuk | 489,00 | 276 | 1 |
| 345 zijpaneel voor ovaal bad | | | | | | | |
| 0969929 | | wit | 699101040001 | stuk | 185,00 | 276 | 1 |
| 0969933 | | pergamon | 699101040061 | stuk | 185,00 | 276 | 1 |
| Duscholux Smart-line | | | | | | | |
| 30 kunststof hoekbad acryl m. punt | | | | | | | |
| 0980274 | 140x140cm | wit | 611030000001 | stuk | 1250,00 | 276 | 1 |
| 0980303 | 140x140cm | pergamon | 611030000061 | stuk | 1250,00 | 276 | 1 |
| 0987162 | badpotenset | | 699900110 | stuk | 74,00 | 276 | 1 |
|  | | | | | | | |
| 31 kunststof hoekbad acryl z. punt | | | | | | | |
| 0980343 | 140x140cm | wit | 611031000001 | stuk | 1250,00 | 276 | 1 |
| 0980370 | 140x140cm | pergamon | 611031000061 | stuk | 1250,00 | 276 | 1 |
| 0987162 | badpotenset | | 699900110 | stuk | 74,00 | 276 | 1 |
|  | | | | | | | |
| 30/31 paneel m. onderstel | | | | | | | |
| 0980371 | | wit | 699111010001 | stuk | 891,00 | 276 | 1 |
| 0980387 | | pergamon | 699111010061 | stuk | 891,00 | 276 | 1 |
| 32 kunststof bad acryl zeshoekig | | | | | | | |
| 0980425 | 190x85cm | wit | 611032000001 | stuk | 925,00 | 276 | 1 |
| 0980426 | 190x85cm | pergamon | 611032000061 | stuk | 925,00 | 276 | 1 |
| 0987162 | badpotenset | | 699900110 | stuk | 74,00 | 276 | 1 |
|  | | | | | | | |
| 33 kunststof bad acryl ovaal | | | | | | | |
| 0980427 | 180x80cm | wit | 611033000001 | stuk | 945,00 | 276 | 1 |
| 0980428 | 180x80cm | pergamon | 611033000061 | stuk | 945,00 | 276 | 1 |
| 0987162 | badpotenset | | 699900110 | stuk | 74,00 | 276 | 1 |
|  | | | | | | | |
| 34/35 kunststof bad acryl rechthoekig | | | | | | | |
| 0980431 | 160x70cm | wit | 611034000001 | stuk | 630,00 | 276 | 1 |
| 0980432 | 160x70cm | pergamon | 611034000061 | stuk | 630,00 | 276 | 1 |
| 0980433 | 160x75cm | wit | 611035000001 | stuk | 630,00 | 276 | 1 |
| 0980434 | 160x75cm | pergamon | 611035000061 | stuk | 630,00 | 276 | 1 |
| 0987162 | badpotenset | | 699900110 | stuk | 74,00 | 276 | 1 |
|  | | | | | | | |
| 36/37 kunststof bad acryl rechthoekig | | | | | | | |
| 0980435 | 170x70cm | wit | 611036000001 | stuk | 630,00 | 276 | 1 |
| 0980436 | 170x70cm | pergamon | 611036000061 | stuk | 630,00 | 276 | 1 |
| 0980437 | 170x75cm | wit | 611037000001 | stuk | 630,00 | 276 | 1 |
| 0980438 | 170x75cm | pergamon | 611037000061 | stuk | 630,00 | 276 | 1 |
| 0987162 | badpotenset | | 699900110 | stuk | 74,00 | 276 | 1 |
| 38 kunststof bad acryl rechthoekig | | | | | | | |
| 0980429 | 180x80cm | wit | 611038000001 | stuk | 840,00 | 276 | 1 |
| 0980430 | 180x80cm | pergamon | 611038000061 | stuk | 840,00 | 276 | 1 |
| 0987162 | badpotenset | | 699900110 | stuk | 74,00 | 276 | 1 |
| 39 kunststof bad acryl m. afschuining | | | | | | | |
| 0980440 | 160x75/60cm | wit | 611039000001 | stuk | 630,00 | 276 | 1 |
| 0980441 | 160x75/60cm | pergamon | 611039000061 | stuk | 630,00 | 276 | 1 |
| 0987162 | badpotenset | | 699900110 | stuk | 74,00 | 276 | 1 |
|  | | | | | | | |
| Duscholux Toebehoren | | | | | | | |
| 0986772 | badgreep voor Free-Line BellaVita | chrom | 699310010078 | stuk | 133,00 | 276 | 1 |
| 0986773 | neksteun voor Free-Line BellaVita | zilvergrijs | 699310020 | stuk | 99,00 | 276 | 1 |
| 0986774 | neksteun voor Free-Line BellaVita | lichtgrijs | 699310030 | stuk | 99,00 | 276 | 1 |
| 0979872 | af- en overloopgarn. ingebouwde watertoevoer | chrom | 699330010078 | stuk | 590,00 | 276 | 1 |
| 0987160 | badpotenset | | 699900100 | stuk | 64,00 | 276 | 1 |
| 0987162 | badpotenset | | 699900110 | stuk | 74,00 | 276 | 1 |
| 0987164 | badpotenset | | 699900130 | stuk | 74,00 | 276 | 1 |
| 0987165 | badpotenset | | 699900140 | stuk | 64,00 | 276 | 1 |
| 7720879 | Duschofill nekkussen m. geïntegreerde watertoevoer | grijs | 195002600 | stuk | 556,00 | 276 | 1 |

Sanitair producten

Baden /
douchebakken /
stoomcabines

Kranen

Douchegarnituur

Accessoires en
spiegels

Douchewanden

Toebehoren &
afvoeren

Spoel- &
installatiesystemen

Badkamermeubelen
en toiletkasten

Gootstenen en
wastroggen

Utiliteit

| Art.nr | Specificaties | Kleur | Lev.nr | Ehd | Prijs | Grp | CC |
|--------|---------------|-------|--------|-----|-------|-----|----|
|--------|---------------|-------|--------|-----|-------|-----|----|

Duscholux Toebehoren

| | | | | | | | |
|---------|-------------------------------------|--------|--------------|------|--------|-----|---|
| 7720880 | Duschodrain badoverloopsysteem 52mm | chroom | 699330120078 | stuk | 219,00 | 276 | 1 |
| 7720881 | Duschodrain badoverloopsysteem 90mm | chroom | 699330130078 | stuk | 329,00 | 276 | 1 |

Sanitair producten

Baden /
douchebakken /
stoomcabines

Kranen

Douchegarnituur

Accessoires en
spiegels

Douchewanden

Toebehoren &
afvoeren

Spoel- &
installatiesystemen

Badkamermeubelen
en toiletkasten

Gootstenen en
wastroggen

Utiliteit

| Art.nr | Specificaties | Kleur | Lev.nr | Ehd | Prijs | Grp | CC |
|--------|---------------|-------|--------|-----|-------|-----|----|
|--------|---------------|-------|--------|-----|-------|-----|----|

Duscholux Ancona

642 Trend kunststof douchebak acryl rechthoekig

| | | | | | | | |
|---------|-----------------------------------|-----|--------------|------|--------|-----|---|
| 0986775 | 90x80x15cm m. onderstel z. paneel | wit | 663642002001 | stuk | 567,00 | 276 | 1 |
|---------|-----------------------------------|-----|--------------|------|--------|-----|---|



Sanitair producten

646 Trend kunststof douchebak acryl rechthoekig

| | | | | | | | |
|---------|-----------------------------------|-----|--------------|------|--------|-----|---|
| 0986776 | 100x80x5cm m. onderstel z. paneel | wit | 663646002001 | stuk | 608,00 | 276 | 1 |
|---------|-----------------------------------|-----|--------------|------|--------|-----|---|

Baden /
douchebakken /
stoomcabines**647 Trend kunststof douchebak acryl rechthoekig**

| | | | | | | | |
|---------|-----------------------------------|-----|--------------|------|--------|-----|---|
| 0986778 | 120x80x5cm m. onderstel z. paneel | wit | 663647002001 | stuk | 709,00 | 276 | 1 |
|---------|-----------------------------------|-----|--------------|------|--------|-----|---|

| | | | | | | | |
|---------|-----------------------------------|----------|--------------|------|--------|-----|---|
| 7720872 | 120x80x5cm m. onderstel z. paneel | pergamon | 663647002061 | stuk | 709,00 | 276 | 1 |
|---------|-----------------------------------|----------|--------------|------|--------|-----|---|

| | | | | | | | |
|---------|-------------------------|-----|--------------|------|--------|-----|---|
| 7720873 | 120x80x5cm z. onderstel | wit | 663647003001 | stuk | 547,00 | 276 | 1 |
|---------|-------------------------|-----|--------------|------|--------|-----|---|

| | | | | | | | |
|---------|-------------------------|----------|--------------|------|--------|-----|---|
| 7720874 | 120x80x5cm z. onderstel | pergamon | 663647003061 | stuk | 547,00 | 276 | 1 |
|---------|-------------------------|----------|--------------|------|--------|-----|---|

Kranen

hoekpaneel voor douchebak

| | | | | | | | |
|---------|---------|-----|--------------|------|--------|-----|---|
| 1020811 | 90x90cm | wit | 699967100001 | stuk | 224,00 | 276 | 1 |
|---------|---------|-----|--------------|------|--------|-----|---|

| | | | | | | | |
|---------|---------|----------|--------------|------|--------|-----|---|
| 1020838 | 90x90cm | pergamon | 699967100061 | stuk | 224,00 | 276 | 1 |
|---------|---------|----------|--------------|------|--------|-----|---|

| | | | | | | | |
|---------|-----------|-----|--------------|------|--------|-----|---|
| 1020846 | 100x100cm | wit | 699967500001 | stuk | 250,00 | 276 | 1 |
|---------|-----------|-----|--------------|------|--------|-----|---|

| | | | | | | | |
|---------|-----------|----------|--------------|------|--------|-----|---|
| 1020854 | 100x100cm | pergamon | 699967500061 | stuk | 250,00 | 276 | 1 |
|---------|-----------|----------|--------------|------|--------|-----|---|

Douchegarnituur

648 Trend kunststof douchebak acryl rechthoekig

| | | | | | | | |
|---------|-----------------------------------|-----|--------------|------|--------|-----|---|
| 7720875 | 120x90x5cm m. onderstel z. paneel | wit | 663648002001 | stuk | 729,00 | 276 | 1 |
|---------|-----------------------------------|-----|--------------|------|--------|-----|---|

| | | | | | | | |
|---------|-------------------------|-----|--------------|------|--------|-----|---|
| 7720877 | 120x90x5cm z. onderstel | wit | 663648003001 | stuk | 567,00 | 276 | 1 |
|---------|-------------------------|-----|--------------|------|--------|-----|---|

Accessoires en
spiegels

Duscholux Malaground

731 kunststof douchebak acryl kwartrond

| | | | | | | | |
|---------|-------------------|-----|--------------|------|--------|-----|---|
| 0986941 | 90x90cm m. paneel | wit | 660731001001 | stuk | 954,00 | 276 | 1 |
|---------|-------------------|-----|--------------|------|--------|-----|---|

| | | | | | | | |
|---------|-------------------|----------|--------------|------|--------|-----|---|
| 0986968 | 90x90cm m. paneel | pergamon | 660731001061 | stuk | 954,00 | 276 | 1 |
|---------|-------------------|----------|--------------|------|--------|-----|---|

| | | | | | | | |
|---------|-------------------|-------------|--------------|------|--------|-----|---|
| 0986976 | 90x90cm m. paneel | klasiek wit | 660731001117 | stuk | 954,00 | 276 | 1 |
|---------|-------------------|-------------|--------------|------|--------|-----|---|



Douchewanden

735 kunststof douchebak acryl kwartrond

| | | | | | | | |
|---------|---------------------|-----|--------------|------|---------|-----|---|
| 0986984 | 100x100cm m. paneel | wit | 660735001001 | stuk | 1106,00 | 276 | 1 |
|---------|---------------------|-----|--------------|------|---------|-----|---|

| | | | | | | | |
|---------|---------------------|----------|--------------|------|---------|-----|---|
| 0986992 | 100x100cm m. paneel | pergamon | 660735001061 | stuk | 1106,00 | 276 | 1 |
|---------|---------------------|----------|--------------|------|---------|-----|---|

| | | | | | | | |
|---------|---------------------|--------------|--------------|------|---------|-----|---|
| 0987018 | 100x100cm m. paneel | klassiek wit | 660735001117 | stuk | 1106,00 | 276 | 1 |
|---------|---------------------|--------------|--------------|------|---------|-----|---|

Toebehoren &
afvoeren**771 kunststof douchebak acryl kwartrond**

| | | | | | | | |
|---------|-------------------|-----|--------------|------|--------|-----|---|
| 0969931 | 90x90cm m. paneel | wit | 660771001001 | stuk | 839,00 | 276 | 1 |
|---------|-------------------|-----|--------------|------|--------|-----|---|

| | | | | | | | |
|---------|-------------------|----------|--------------|------|--------|-----|---|
| 0969982 | 90x90cm m. paneel | pergamon | 660771001061 | stuk | 839,00 | 276 | 1 |
|---------|-------------------|----------|--------------|------|--------|-----|---|

Spoel- &
installatiesystemen**775 kunststof douchebak acryl kwartrond**

| | | | | | | | |
|---------|---------------------|-----|--------------|------|--------|-----|---|
| 0969980 | 100x100cm m. paneel | wit | 660775001001 | stuk | 912,00 | 276 | 1 |
|---------|---------------------|-----|--------------|------|--------|-----|---|

| | | | | | | | |
|---------|---------------------|----------|--------------|------|--------|-----|---|
| 0969990 | 100x100cm m. paneel | pergamon | 660775001061 | stuk | 912,00 | 276 | 1 |
|---------|---------------------|----------|--------------|------|--------|-----|---|

Badkamermeubelen
en toiletkasten**791 kunststof douchebak acryl kwartrond**

| | | | | | | | |
|---------|-------------------|-----|--------------|------|--------|-----|---|
| 0969984 | 90x90cm m. paneel | wit | 660791001001 | stuk | 948,00 | 276 | 1 |
|---------|-------------------|-----|--------------|------|--------|-----|---|

| | | | | | | | |
|---------|-------------------|----------|--------------|------|--------|-----|---|
| 0979961 | 90x90cm m. paneel | pergamon | 660791001061 | stuk | 948,00 | 276 | 1 |
|---------|-------------------|----------|--------------|------|--------|-----|---|

| | | | | | | | |
|---------|-------------------|-----|--------------|------|--------|-----|---|
| 1021338 | 90x90cm z. paneel | wit | 660791002001 | stuk | 818,00 | 276 | 1 |
|---------|-------------------|-----|--------------|------|--------|-----|---|

| | | | | | | | |
|---------|-------------------|----------|--------------|------|--------|-----|---|
| 1021346 | 90x90cm z. paneel | pergamon | 660791002061 | stuk | 818,00 | 276 | 1 |
|---------|-------------------|----------|--------------|------|--------|-----|---|

Gootstenen en
wastroggen**795 kunststof douchebak acryl kwartrond**

| | | | | | | | |
|---------|---------------------|-----|--------------|------|---------|-----|---|
| 0969986 | 100x100cm m. paneel | wit | 660795001001 | stuk | 1124,00 | 276 | 1 |
|---------|---------------------|-----|--------------|------|---------|-----|---|

| | | | | | | | |
|---------|---------------------|----------|--------------|------|---------|-----|---|
| 0979996 | 100x100cm m. paneel | pergamon | 660795001061 | stuk | 1124,00 | 276 | 1 |
|---------|---------------------|----------|--------------|------|---------|-----|---|

| | | | | | | | |
|---------|---------------------|-----|--------------|------|--------|-----|---|
| 1021354 | 100x100cm z. paneel | wit | 660795002001 | stuk | 974,00 | 276 | 1 |
|---------|---------------------|-----|--------------|------|--------|-----|---|

| | | | | | | | |
|---------|---------------------|----------|--------------|------|--------|-----|---|
| 1021362 | 100x100cm z. paneel | pergamon | 660795002061 | stuk | 974,00 | 276 | 1 |
|---------|---------------------|----------|--------------|------|--------|-----|---|

Utiliteit

Duscholux Smart-line

61 kunststof douchebak acryl kwartrond

| | | | | | | | |
|---------|---------------------|-----|--------------|------|--------|-----|---|
| 0980442 | 90x90x5cm m. paneel | wit | 671061001001 | stuk | 798,00 | 276 | 1 |
|---------|---------------------|-----|--------------|------|--------|-----|---|

| | | | | | | | |
|---------|---------------------|----------|--------------|------|--------|-----|---|
| 0980444 | 90x90x5cm m. paneel | pergamon | 671061001061 | stuk | 798,00 | 276 | 1 |
|---------|---------------------|----------|--------------|------|--------|-----|---|

| | | | | | | | |
|---------|---------------------|-----|--------------|------|--------|-----|---|
| 0980445 | 90x90x5cm z. paneel | wit | 671061003001 | stuk | 504,00 | 276 | 1 |
|---------|---------------------|-----|--------------|------|--------|-----|---|

| | | | | | | | |
|---------|---------------------|----------|--------------|------|--------|-----|---|
| 0980446 | 90x90x5cm z. paneel | pergamon | 671061003061 | stuk | 504,00 | 276 | 1 |
|---------|---------------------|----------|--------------|------|--------|-----|---|

**62 kunststof douchebak acryl kwartrond**

| | | | | | | | |
|---------|-----------------------|-----|--------------|------|--------|-----|---|
| 0980448 | 100x100x5cm m. paneel | wit | 671062001001 | stuk | 819,00 | 276 | 1 |
|---------|-----------------------|-----|--------------|------|--------|-----|---|

| | | | | | | | |
|---------|-----------------------|----------|--------------|------|--------|-----|---|
| 0980449 | 100x100x5cm m. paneel | pergamon | 671062001061 | stuk | 819,00 | 276 | 1 |
|---------|-----------------------|----------|--------------|------|--------|-----|---|

| | | | | | | | |
|---------|-----------------------|-----|--------------|------|--------|-----|---|
| 0980451 | 100x100x5cm z. paneel | wit | 671062003001 | stuk | 525,00 | 276 | 1 |
|---------|-----------------------|-----|--------------|------|--------|-----|---|

| | | | | | | | |
|---------|-----------------------|----------|--------------|------|--------|-----|---|
| 0980452 | 100x100x5cm z. paneel | pergamon | 671062003061 | stuk | 525,00 | 276 | 1 |
|---------|-----------------------|----------|--------------|------|--------|-----|---|

| | Art.nr | Specificaties | Kleur | Lev.nr | Ehd | Prijs | Grp | CC |
|----------------------------------|---|---|----------|--------------|------|--------|-----|----|
| | Duscholux Smart-line | | | | | | | |
| | 65 kunststof douchebak acryl rechthoekig | | | | | | | |
| Sanitair producten | 0980461 | 90x75cm | wit | 671065003001 | stuk | 483,00 | 276 | 1 |
| | 0980462 | 90x75cm | pergamon | 671065003061 | stuk | 483,00 | 276 | 1 |
| | 66 kunststof douchebak acryl vierkant | | | | | | | |
| Kranen | 0980463 | 90x90cm | wit | 671066003001 | stuk | 483,00 | 276 | 1 |
| | 0980464 | 90x90cm | pergamon | 671066003061 | stuk | 483,00 | 276 | 1 |
| | 67 kunststof douchebak acryl vijfhoekig | | | | | | | |
| Douchegarnituur | 0980453 | 90x90x5cm m. paneel | wit | 671067001001 | stuk | 798,00 | 276 | 1 |
| | 0980454 | 90x90x5cm m. paneel | pergamon | 671067001061 | stuk | 798,00 | 276 | 1 |
| | 0980455 | 90x90x5cm z. paneel | wit | 671067003001 | stuk | 504,00 | 276 | 1 |
| | 0980456 | 90x90x5cm z. paneel | pergamon | 671067003061 | stuk | 504,00 | 276 | 1 |
| | 68 kunststof douchebak acryl vijfhoekig | | | | | | | |
| Douchewanden | 0980457 | 100x100x5cm m. paneel | wit | 671068001001 | stuk | 840,00 | 276 | 1 |
| | 0980458 | 100x100x5cm m. paneel | pergamon | 671068001061 | stuk | 840,00 | 276 | 1 |
| | 0980459 | 100x100x5cm z. paneel | wit | 671068003001 | stuk | 546,00 | 276 | 1 |
| | 0980460 | 100x100x5cm z. paneel | pergamon | 671068003061 | stuk | 546,00 | 276 | 1 |
| Toebehoren & afvoeren | 0360618 | douchebaksteun m 5 verstelbare poten 87-115mm | | R 5 SGS MINI | stuk | 33,00 | 062 | 0 |
| | 69 kunststof douchebak acryl vierkant | | | | | | | |
| Spoel- & installatiesystemen | 0980465 | 100x100x5cm | wit | 671069003001 | stuk | 525,00 | 276 | 1 |
| | 0980466 | 100x100x5cm | pergamon | 671069003061 | stuk | 525,00 | 276 | 1 |
| Badkamermeubelen en toiletkasten | | | | | | | | |
| Gootstenen en wastroggen | | | | | | | | |
| Utiliteit | | | | | | | | |

| Art.nr | Specificaties | Kleur | Lev.nr | Ehd | Prijs | Grp | CC |
|--------|---------------|-------|--------|-----|-------|-----|----|
|--------|---------------|-------|--------|-----|-------|-----|----|

Hoesch 1930

kunststof bad acryl rechthoekig

| | | | | | | | |
|---------|----------------------------|-----------|---------|------|---------|-----|---|
| 0380164 | 180x90cm z. poten | wit | 6085010 | stuk | 1196,00 | 087 | 1 |
| 0381659 | 180x90cm z. poten | pergamon | 6085030 | stuk | 1196,00 | 087 | 1 |
| 0380172 | 180x90cm z. poten | edelweiss | 6085013 | stuk | 1555,00 | 087 | 1 |
| 0380283 | set poten voor designbaden | | 690705 | stuk | 70,00 | 087 | 0 |

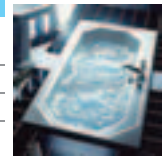

Sanitair producten

Baden /
douchebakken /
stoomcabines

Hoesch Andree Putman

kunststof bad acryl inbouw z. poten

| | | | | | | | |
|---------|----------------------------|-----|---------|------|---------|-----|---|
| 0381807 | 190x100cm | wit | 6655010 | stuk | 2147,00 | 087 | 1 |
| 0380283 | set poten voor designbaden | | 690705 | stuk | 70,00 | 087 | 0 |

kunststof bad acryl vrijstaand

| | | | | | | | |
|---------|--------------------|-----|---------|------|---------|-----|---|
| 0381809 | 190x100cm m. poten | wit | 6656010 | stuk | 4495,00 | 087 | 1 |
|---------|--------------------|-----|---------|------|---------|-----|---|



Kranen

Douchegarnituur

kunststof bad acryl vrijstaand m. aluminium mantel

| | | | | | | | |
|---------|--------------------|-----|---------|------|---------|-----|---|
| 0381811 | 190x100cm m. poten | wit | 6659010 | stuk | 5850,00 | 087 | 1 |
|---------|--------------------|-----|---------|------|---------|-----|---|

Accessoires en
spiegels

Hoesch Armada

kunststof bad acryl zeshoekig

| | | | | | | | |
|---------|----------------------------|----------|---------|------|---------|-----|---|
| 0382280 | 170x80cm z. poten | wit | 6174010 | stuk | 1425,00 | 087 | 1 |
| 0382299 | 170x80cm z. poten | pergamon | 6174030 | stuk | 1425,00 | 087 | 1 |
| 0382302 | 180x80cm z. poten | wit | 6175010 | stuk | 1466,00 | 087 | 1 |
| 0382310 | 180x80cm z. poten | pergamon | 6175030 | stuk | 1466,00 | 087 | 1 |
| 0382329 | 180x90cm z. poten | wit | 6176010 | stuk | 1507,00 | 087 | 1 |
| 0382337 | 180x90cm z. poten | pergamon | 6176030 | stuk | 1507,00 | 087 | 1 |
| 0382345 | 190x90cm z. poten | wit | 6177010 | stuk | 1707,00 | 087 | 1 |
| 0382353 | 190x90cm z. poten | pergamon | 6177030 | stuk | 1707,00 | 087 | 1 |
| 0380283 | set poten voor designbaden | | 690705 | stuk | 70,00 | 087 | 0 |



Douchewanden

Toebehoren &
afvoeren**kunststof bad acryl achthoekig**

| | | | | | | | |
|---------|----------------------------|----------|---------|------|---------|-----|---|
| 0382361 | 180x80cm z. poten | wit | 6169010 | stuk | 1466,00 | 087 | 1 |
| 0382388 | 180x80cm z. poten | pergamon | 6169030 | stuk | 1466,00 | 087 | 1 |
| 0380283 | set poten voor designbaden | | 690705 | stuk | 70,00 | 087 | 0 |

Spoel- &
installatiesystemenBadkamermeubelen
en toiletkasten

Hoesch Aviva

kunststof bad acryl rond m. 4 hoofdsteunen

| | | | | | | | |
|---------|-------|----------|---------|------|---------|-----|---|
| 0380319 | 180cm | wit | 6620010 | stuk | 4334,00 | 086 | 1 |
| 0380320 | 180cm | pergamon | 6620030 | stuk | 4334,00 | 086 | 1 |

Gootstenen en
wastroggen

Hoesch Avventura

kunststof bad acryl m. houten grepen z. poten

| | | | | | | | |
|---------|----------------------------|----------|----------------|------|---------|-----|---|
| 0381801 | 180x90cm | wit | 6648010+690940 | stuk | 1750,00 | 087 | 1 |
| 0381806 | 180x90cm | pergamon | 6648030+690940 | stuk | 1750,00 | 087 | 1 |
| 0380283 | set poten voor designbaden | | 690705 | stuk | 70,00 | 087 | 0 |



Utiliteit

kunststof bad acryl z. grepen z. poten

| | | | | | | | |
|---------|----------------------------|----------|---------|------|---------|-----|---|
| 0381803 | 180x90cm | wit | 6648010 | stuk | 1750,00 | 087 | 1 |
| 0381804 | 180x90cm | pergamon | 6648030 | stuk | 1750,00 | 087 | 1 |
| 0380283 | set poten voor designbaden | | 690705 | stuk | 70,00 | 087 | 0 |

houten opstap voor bad

| | | | | | | | |
|---------|--|--|--------|------|--------|-----|---|
| 0381805 | | | 690941 | stuk | 775,00 | 087 | 1 |
|---------|--|--|--------|------|--------|-----|---|



| Art.nr | Specificaties | Kleur | Lev.nr | Ehd | Prijs | Grp | CC |
|--------|---------------|-------|--------|-----|-------|-----|----|
|--------|---------------|-------|--------|-----|-------|-----|----|

Sanitair producten



| Hoesch Capri | | | | | | | |
|---------------------------------|----------------------------|-----------|---------|------|--------|-----|---|
| kunststof bad acryl rechthoekig | | | | | | | |
| 0380481 | 150x70cm z. poten | wit | 6116010 | stuk | 388,00 | 086 | 1 |
| 0380008 | 170x75cm z. poten | wit | 6103010 | stuk | 349,00 | 086 | 1 |
| 0380016 | 170x75cm z. poten | pergamon | 6103030 | stuk | 349,00 | 086 | 1 |
| 0380032 | 170x75cm z. poten | edelweiss | 6103013 | stuk | 454,00 | 086 | 1 |
| 0380520 | 180x80cm z. poten | wit | 6107010 | stuk | 555,00 | 086 | 1 |
| 0380539 | 180x80cm z. poten | pergamon | 6107030 | stuk | 555,00 | 086 | 1 |
| 0380563 | 180x80cm z. poten | edelweiss | 6107013 | stuk | 722,00 | 086 | 1 |
| 0380029 | 190x80cm z. poten | wit | 6104010 | stuk | 620,00 | 086 | 1 |
| 0380561 | 190x80cm z. poten | pergamon | 6104030 | stuk | 620,00 | 086 | 1 |
| 0380283 | set poten voor designbaden | | 690705 | stuk | 70,00 | 087 | 0 |

Baden /
douchebakken /
stoomcabines



Kranen

Douchegarnituur



| Hoesch Deltanova | | | | | | | |
|-------------------------|--------------------------|----------|---------|------|---------|-----|---|
| kunststof hoekbad acryl | | | | | | | |
| 0384380 | 130cm z. paneel z. poten | wit | 6043010 | stuk | 2571,00 | 087 | 1 |
| 0384399 | 130cm z. paneel z. poten | pergamon | 6043030 | stuk | 2571,00 | 087 | 1 |
| 0384224 | 130cm m. paneel m. poten | wit | 6044010 | stuk | 2848,00 | 087 | 1 |
| 0384232 | 130cm m. paneel m. poten | pergamon | 6044030 | stuk | 2848,00 | 087 | 1 |
| 0384216 | 140cm z. paneel z. poten | wit | 6008010 | stuk | 2943,00 | 087 | 1 |
| 0384208 | 140cm z. paneel z. poten | pergamon | 6008030 | stuk | 2943,00 | 087 | 1 |
| 0380371 | 140cm m. paneel m. poten | wit | 6009010 | stuk | 3523,00 | 086 | 1 |
| 0380027 | 140cm m. paneel m. poten | pergamon | 6009030 | stuk | 3523,00 | 087 | 1 |

Accessoires en
spiegels

Douchewanden



| Hoesch Dreamscape | | | | | | | |
|---------------------|--------------------------------------|-----|------------|------|---------|-----|---|
| kunststof bad acryl | | | | | | | |
| 0382434 | Ø180cm inbouw z. poten | wit | 6114010 | stuk | 4247,00 | 087 | 1 |
| 0382426 | Ø180cm vrijstaand m. mantel m. poten | wit | 6130010100 | stuk | 6605,00 | 087 | 1 |

Toebehoren &
afvoeren

Spoel- &
installatiesystemen



| Hoesch Foster | | | | | | | |
|----------------------------|----------------------------|-----|---------|------|--------|-----|---|
| kunststof bad acryl inbouw | | | | | | | |
| 0381813 | 160x70cm | wit | 6647010 | stuk | 610,00 | 087 | 1 |
| 0381815 | 170x70cm | wit | 6646010 | stuk | 610,00 | 087 | 1 |
| 0381817 | 170x75cm | wit | 6629010 | stuk | 610,00 | 087 | 1 |
| 0381819 | 180x80cm | wit | 6628010 | stuk | 830,00 | 087 | 1 |
| 0380283 | set poten voor designbaden | | 690705 | stuk | 70,00 | 087 | 0 |

Badkamermeubelen
en toiletkasten



| kunststof bad acryl | | | | | | | |
|---------------------|---|-----|---------|------|---------|-----|---|
| 0382965 | 190x98cm inbouw ovaal z. poten | wit | 6476010 | stuk | 2490,00 | 087 | 1 |
| 0382973 | 190x98cm vrijstaand ovaal m. poten | wit | 6477010 | stuk | 4654,00 | 087 | 1 |
| 0382981 | 190x102cm inbouw z. mantel z. poten | wit | 6478010 | stuk | 2059,00 | 087 | 1 |
| 0383007 | 190x102cm vrijstaand m. mantel m. poten | wit | 6479010 | stuk | 4174,00 | 087 | 1 |

Gootstenen en
wastroggen

Utiliteit



Hoesch Giorno



| Hoesch Giorno | | | | | | | |
|----------------------------|----------------------------|-----|---------|------|---------|-----|---|
| kunststof bad acryl inbouw | | | | | | | |
| 0382558 | 190x85cm z. poten | wit | 6470010 | stuk | 1782,00 | 087 | 1 |
| 0380283 | set poten voor designbaden | | 690705 | stuk | 70,00 | 087 | 0 |

kunststof bad acryl vrijstaand



| | | | | | | | |
|---------|-----------------------------|-----|---------|------|---------|-----|---|
| 0382566 | 190x85cm m. mantel z. poten | wit | 6471010 | stuk | 2534,00 | 087 | 1 |
|---------|-----------------------------|-----|---------|------|---------|-----|---|

| Art.nr | Specificaties | Kleur | Lev.nr | Ehd | Prijs | Grp | CC |
|--------|---------------|-------|--------|-----|-------|-----|----|
|--------|---------------|-------|--------|-----|-------|-----|----|

Hoesch Giorno

kunststof hoekbad acryl

| | | | | | | | |
|---------|-------------------------------------|-----|---------|------|---------|-----|---|
| 0382574 | 140cm inbouw z. poten | wit | 6472010 | stuk | 2577,00 | 087 | 1 |
| 0382582 | 140cm vrijstaand m. mantel m. poten | wit | 6473010 | stuk | 3329,00 | 087 | 1 |



Sanitair producten

Baden /
douchebakken /
stoomcabines

Kranen

Douchegarnituur

Accessoires en
spiegels

Douchewanden

Toebehoren &
afvoerenSpoel- &
installatiesystemenBadkamermeubelen
en toiletkastenGootstenen en
wastroggen

Utiliteit

kunststof bad acryl links

| | | | | | | | |
|---------|---------------------------------|-----|---------|------|---------|-----|---|
| 0384526 | 170x90cm z. poten | wit | 6679010 | stuk | 1198,00 | 087 | 1 |
| 0384534 | 170x90cm m. vormmantel m. poten | wit | 6680010 | stuk | 1598,00 | 087 | 1 |
| 0384542 | 170x90cm m. mantel los m. poten | wit | 6681010 | stuk | 1998,00 | 087 | 1 |

kunststof bad acryl rechts

| | | | | | | | |
|---------|---------------------------------|-----|---------|------|---------|-----|---|
| 0384569 | 170x90cm m. poten z. poten | wit | 6693010 | stuk | 1198,00 | 087 | 1 |
| 0384593 | 170x90cm m. vormmantel m. poten | wit | 6694010 | stuk | 1598,00 | 087 | 1 |
| 0384607 | 170x90cm m. mantel los m. poten | wit | 6699010 | stuk | 1998,00 | 087 | 1 |

handreling voor 6679/80/93/94

| | | | | | | | |
|---------|--|-------|--------|------|--------|-----|---|
| 0384631 | | chrom | 692020 | stuk | 440,00 | 087 | 1 |
|---------|--|-------|--------|------|--------|-----|---|

handreling voor 6681/99

| | | | | | | | |
|---------|--|-------|--------|------|--------|-----|---|
| 0384658 | | chrom | 692021 | stuk | 440,00 | 087 | 1 |
|---------|--|-------|--------|------|--------|-----|---|

Hoesch HappyD

kunststof bad acryl

| | | | | | | | |
|---------|--|-----|---------|------|---------|-----|---|
| 0382450 | 180x80cm inbouw z. poten | wit | 6180010 | stuk | 1095,00 | 087 | 1 |
| 0382442 | 180x80cm vrijstaand m. mantel m. poten | wit | 6181010 | stuk | 1561,00 | 086 | 0 |
| 0380283 | set poten voor designbaden | | 690705 | stuk | 70,00 | 087 | 0 |

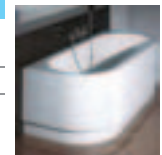

Douchewanden

Toebehoren &
afvoerenSpoel- &
installatiesystemenBadkamermeubelen
en toiletkastenGootstenen en
wastroggen

Utiliteit

kunststof bad acryl links

| | | | | | | | |
|---------|-----------------------------|-----|---------|------|---------|-----|---|
| 0382671 | 180x80cm z. mantel z. poten | wit | 6484010 | stuk | 1095,00 | 087 | 1 |
| 0382698 | 180x80cm m. mantel m. poten | wit | 6485010 | stuk | 1561,00 | 087 | 1 |
| 0380283 | set poten voor designbaden | | 690705 | stuk | 70,00 | 087 | 0 |

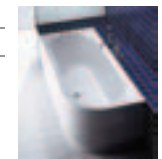

Douchewanden

Toebehoren &
afvoerenSpoel- &
installatiesystemenBadkamermeubelen
en toiletkastenGootstenen en
wastroggen

Utiliteit

kunststof bad acryl rechts

| | | | | | | | |
|---------|-----------------------------|-----|---------|------|---------|-----|---|
| 0382701 | 180x80cm z. mantel z. poten | wit | 6486010 | stuk | 1095,00 | 087 | 1 |
| 0382728 | 180x80cm m. mantel m. poten | wit | 6487010 | stuk | 1561,00 | 087 | 1 |
| 0380283 | set poten voor designbaden | | 690705 | stuk | 70,00 | 087 | 0 |

Hoesch Holland Line

kunststof bad acryl rechthoekig 2002/3/4

| | | | | | | | |
|---------|-----------------------------------|----------|-----------|------|--------|-----|---|
| 0383449 | 170x75cm z. poten | wit | HL2002010 | stuk | 322,00 | 086 | 1 |
| 0383457 | 170x75cm z. poten | pergamon | HL2002030 | stuk | 322,00 | 086 | 1 |
| 0383465 | 180x80cm z. poten | wit | HL2003010 | stuk | 372,00 | 086 | 1 |
| 0383473 | 180x80cm z. poten | pergamon | HL2003030 | stuk | 372,00 | 086 | 1 |
| 0383481 | 190x80cm z. poten | wit | HL2004010 | stuk | 421,00 | 086 | 1 |
| 0383503 | 190x80cm z. poten | pergamon | HL2004030 | stuk | 421,00 | 086 | 1 |
| 0384550 | set poten voor Holland Line baden | | 590705 | stuk | 19,00 | 087 | 0 |



Douchewanden

Toebehoren &
afvoerenSpoel- &
installatiesystemenBadkamermeubelen
en toiletkastenGootstenen en
wastroggen

Utiliteit

kunststof bad acryl rechthoekig 2006/7

| | | | | | | | |
|---------|-----------------------------------|----------|-----------|------|--------|-----|---|
| 0383600 | 170x75cm z. poten | wit | HL2006010 | stuk | 421,00 | 086 | 1 |
| 0383619 | 170x75cm z. poten | pergamon | HL2006030 | stuk | 421,00 | 086 | 1 |
| 0383627 | 180x80cm z. poten | wit | HL2007010 | stuk | 421,00 | 086 | 1 |
| 0383635 | 180x80cm z. poten | pergamon | HL2007030 | stuk | 421,00 | 086 | 1 |
| 0384550 | set poten voor Holland Line baden | | 590705 | stuk | 19,00 | 087 | 0 |



Douchewanden

Toebehoren &
afvoerenSpoel- &
installatiesystemenBadkamermeubelen
en toiletkastenGootstenen en
wastroggen

Utiliteit

kunststof bad acryl rechthoekig 2010

| | | | | | | | |
|---------|-----------------------------------|----------|-----------|------|--------|-----|---|
| 0383333 | 170x75cm z. poten | wit | HL2010010 | stuk | 396,00 | 086 | 1 |
| 0383341 | 170x75cm z. poten | pergamon | HL2010030 | stuk | 396,00 | 086 | 1 |
| 0384550 | set poten voor Holland Line baden | | 590705 | stuk | 19,00 | 087 | 0 |

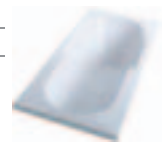

Douchewanden

Toebehoren &
afvoerenSpoel- &
installatiesystemenBadkamermeubelen
en toiletkastenGootstenen en
wastroggen

Utiliteit

| Art.nr | Specificaties | Kleur | Lev.nr | Ehd | Prijs | Grp | CC |
|--------|---------------|-------|--------|-----|-------|-----|----|
|--------|---------------|-------|--------|-----|-------|-----|----|

Hoesch Holland Line

kunststof bad acryl rechthoekig 2011

| | | | | | | | |
|---------|-----------------------------------|----------|-----------|------|--------|-----|---|
| 0383643 | 170x80cm z. poten | wit | HL2011010 | stuk | 421,00 | 086 | 1 |
| 0383651 | 170x80cm z. poten | pergamon | HL2011030 | stuk | 421,00 | 086 | 1 |
| 0384550 | set poten voor Holland Line baden | | 590705 | stuk | 19,00 | 087 | 0 |



Sanitair producten

Baden /
douchebakken /
stoomcabines

kunststof bad acryl rechthoekig 2012/13

| | | | | | | | |
|---------|-----------------------------------|----------|-----------|------|--------|-----|---|
| 0383511 | 180x80cm z. poten | wit | HL2012010 | stuk | 446,00 | 086 | 1 |
| 0383538 | 180x80cm z. poten | pergamon | HL2012030 | stuk | 446,00 | 086 | 1 |
| 0383546 | 190x80cm z. poten | wit | HL2013010 | stuk | 495,00 | 086 | 1 |
| 0383554 | 190x80cm z. poten | pergamon | HL2013030 | stuk | 495,00 | 086 | 1 |
| 0384550 | set poten voor Holland Line baden | | 590705 | stuk | 19,00 | 087 | 0 |



Kranen

Douchegarnituur

kunststof bad acryl rechthoekig 2014/15

| | | | | | | | |
|---------|-----------------------------------|----------|-----------|------|--------|-----|---|
| 0383384 | 170x80cm z. poten | wit | HL2014010 | stuk | 372,00 | 086 | 1 |
| 0383392 | 170x80cm z. poten | pergamon | HL2014030 | stuk | 372,00 | 086 | 1 |
| 0383406 | 175x82cm z. poten | wit | HL2015010 | stuk | 396,00 | 086 | 1 |
| 0383414 | 175x82cm z. poten | pergamon | HL2015030 | stuk | 396,00 | 086 | 1 |
| 0384550 | set poten voor Holland Line baden | | 590705 | stuk | 19,00 | 087 | 0 |



Accessoires en
spiegels

Douchewanden

kunststof bad acryl rechthoekig 2016

| | | | | | | | |
|---------|-----------------------------------|----------|-----------|------|--------|-----|---|
| 0383368 | 170x75cm z. poten | wit | HL2016010 | stuk | 372,00 | 086 | 1 |
| 0383376 | 170x75cm z. poten | pergamon | HL2016030 | stuk | 372,00 | 086 | 1 |
| 0384550 | set poten voor Holland Line baden | | 590705 | stuk | 19,00 | 087 | 0 |



Toebehoren &
afvoeren

kunststof bad acryl rechthoekig 2017

| | | | | | | | |
|---------|-----------------------------------|----------|-----------|------|--------|-----|---|
| 0383589 | 170x75cm z. poten | wit | HL2017010 | stuk | 322,00 | 086 | 1 |
| 0383597 | 170x75cm z. poten | pergamon | HL2017030 | stuk | 322,00 | 086 | 1 |
| 0384550 | set poten voor Holland Line baden | | 590705 | stuk | 19,00 | 087 | 0 |



Spoel- &
installatiesystemen

Badkamermeubelen
en toiletkasten

kunststof bad acryl rechthoekig 2018

| | | | | | | | |
|---------|-----------------------------------|----------|-----------|------|--------|-----|---|
| 0383422 | 170x75cm z. poten | wit | HL2018010 | stuk | 372,00 | 086 | 1 |
| 0383430 | 170x75cm z. poten | pergamon | HL2018030 | stuk | 372,00 | 086 | 1 |
| 0384550 | set poten voor Holland Line baden | | 590705 | stuk | 19,00 | 087 | 0 |



Gootstenen en
wastroggen

Utiliteit

kunststof bad acryl rechthoekig 2019

| | | | | | | | |
|---------|-----------------------------------|----------|-----------|------|--------|-----|---|
| 0383562 | 180x80cm z. poten | wit | HL2019010 | stuk | 396,00 | 086 | 1 |
| 0383570 | 180x80cm z. poten | pergamon | HL2019030 | stuk | 396,00 | 086 | 1 |
| 0384550 | set poten voor Holland Line baden | | 590705 | stuk | 19,00 | 087 | 0 |



kunststof bad acryl rechthoekig 2020/21

| | | | | | | | |
|---------|-----------------------------------|----------|-----------|------|--------|-----|---|
| 0383694 | 170x75cm z. poten overloop links | wit | HL2020010 | stuk | 372,00 | 086 | 1 |
| 0383708 | 170x75cm z. poten overloop links | pergamon | HL2020030 | stuk | 372,00 | 086 | 1 |
| 0383678 | 170x75cm z. poten overloop rechts | wit | HL2021010 | stuk | 372,00 | 086 | 1 |
| 0383686 | 170x75cm z. poten overloop rechts | pergamon | HL2021030 | stuk | 372,00 | 086 | 1 |
| 0384550 | set poten voor Holland Line baden | | 590705 | stuk | 19,00 | 087 | 0 |



kunststof bad acryl zeshoekig 2022

| | | | | | | | |
|---------|---|----------|-----------|------|--------|-----|---|
| 0383716 | 190x90cm z. poten | wit | HL2022010 | stuk | 743,00 | 086 | 1 |
| 0383724 | 190x90cm z. poten | pergamon | HL2022030 | stuk | 743,00 | 086 | 1 |
| 0384550 | set poten voor Holland Line baden | | 590705 | stuk | 19,00 | 087 | 0 |
| 0510426 | badafvoer- en overloopcombi m. waste basisgarn. normaal bad | | 58140180 | stuk | 36,25 | 350 | 0 |



| Art.nr | Specificaties | Kleur | Lev.nr | Ehd | Prijs | Grp | CC |
|--------|---------------|-------|--------|-----|-------|-----|----|
|--------|---------------|-------|--------|-----|-------|-----|----|

Hoesch Holland Line

kunststof hoekbad acryl 2023

| | | | | | | | |
|---------|-----------------------------------|----------|-----------|------|--------|-----|---|
| 0383775 | 140cm z. paneel z. poten | wit | HL2023010 | stuk | 743,00 | 086 | 1 |
| 0383783 | 140cm z. paneel z. poten | pergamon | HL2023030 | stuk | 743,00 | 086 | 1 |
| 0384550 | set poten voor Holland Line baden | | 590705 | stuk | 19,00 | 087 | 0 |



Sanitair producten

paneel voor hoekbad acryl

| | | | | | | | |
|---------|-------|----------|-----------|------|--------|-----|---|
| 0383759 | 140cm | wit | HL2024010 | stuk | 372,00 | 086 | 1 |
| 0383767 | 140cm | pergamon | HL2024030 | stuk | 372,00 | 086 | 1 |

kunststof hoekbad acryl 2025

| | | | | | | | |
|---------|-----------------------------------|----------|-----------|------|--------|-----|---|
| 0383732 | 140cm z. paneel z. poten | wit | HL2025010 | stuk | 694,00 | 086 | 1 |
| 0383740 | 140cm z. paneel z. poten | pergamon | HL2025030 | stuk | 694,00 | 086 | 1 |
| 0384550 | set poten voor Holland Line baden | | 590705 | stuk | 19,00 | 087 | 0 |



Kranen

kunststof hoekbad acryl 2026

| | | | | | | | |
|---------|-----------------------------------|----------|-----------|------|--------|-----|---|
| 0383791 | 145cm rechts z. poten | wit | HL2026010 | stuk | 793,00 | 086 | 1 |
| 0383805 | 145cm rechts z. poten | pergamon | HL2026030 | stuk | 793,00 | 086 | 1 |
| 0384550 | set poten voor Holland Line baden | | 590705 | stuk | 19,00 | 087 | 0 |

Douchegarnituur

kunststof hoekbad acryl 2027

| | | | | | | | |
|---------|-----------------------------------|----------|-----------|------|--------|-----|---|
| 0383813 | 145cm links z. poten | wit | HL2027010 | stuk | 793,00 | 086 | 1 |
| 0383821 | 145cm links z. poten | pergamon | HL2027030 | stuk | 793,00 | 086 | 1 |
| 0384550 | set poten voor Holland Line baden | | 590705 | stuk | 19,00 | 087 | 0 |

Accessoires en spiegels

Hoesch Medici

kunststof bad acryl ovaal

| | | | | | | | |
|---------|----------------------------|-----|---------|------|---------|-----|---|
| 0381675 | 180x90cm z. poten | wit | 6005010 | stuk | 1466,00 | 087 | 1 |
| 0380283 | set poten voor designbaden | | 690705 | stuk | 70,00 | 087 | 0 |



Douchewanden

Hoesch Midi Ovaal

kunststof bad acryl ovaal

| | | | | | | | |
|---------|--------------------------------|-----|---------|------|---------|-----|---|
| 0381821 | 185x90cm z. poten | wit | 3633010 | stuk | 1325,00 | 087 | 1 |
| 0381823 | 185x90cm z. poten m. inbouwset | wit | 3635010 | stuk | 3155,00 | 087 | 1 |



Toebehoren & afvoeren

Spoel- & installatiesystemen

Hoesch Modula

kunststof bad acryl rechthoekig

| | | | | | | | |
|---------|--|----------|---------|------|---------|-----|---|
| 0384402 | 180x80cm m. overloop links z. poten | wit | 6622010 | stuk | 1216,00 | 087 | 1 |
| 0384410 | 180x80cm m. overloop links z. poten | pergamon | 6622030 | stuk | 1216,00 | 087 | 1 |
| 0384429 | 180x80cm m. overloop rechts z. poten | wit | 6621010 | stuk | 1216,00 | 087 | 1 |
| 0384437 | 180x80cm m. overloop rechts z. poten | pergamon | 6621030 | stuk | 1216,00 | 087 | 1 |
| 0384445 | 180x80cm m. instaphulp links z. poten | wit | 6623010 | stuk | 1943,00 | 087 | 1 |
| 0384453 | 180x80cm m. instaphulp links z. poten | pergamon | 6623030 | stuk | 1943,00 | 087 | 1 |
| 0384461 | 180x80cm m. instaphulp rechts z. poten | wit | 6624010 | stuk | 1943,00 | 087 | 1 |
| 0384488 | 180x80cm m. instaphulp rechts z. poten | pergamon | 6624030 | stuk | 1943,00 | 087 | 1 |
| 0380283 | set poten voor designbaden | | 690705 | stuk | 70,00 | 087 | 0 |

Badkamermeubelen en toiletkasten

Gootstenen en wastroggen

hoofd-/rugsteun

| | | | | | | | |
|---------|--|--|-------|------|--------|-----|---|
| 0384496 | | | 69703 | stuk | 152,00 | 087 | 1 |
|---------|--|--|-------|------|--------|-----|---|

douche-/waszitje

| | | | | | | | |
|---------|---------|--|-------|------|--------|-----|---|
| 0384518 | 57x35cm | | 69704 | stuk | 361,00 | 087 | 1 |
|---------|---------|--|-------|------|--------|-----|---|

Hoesch Oriental

kunststof bad acryl rechthoekig

| | | | | | | | |
|---------|----------------------------|-----|---------|------|--------|-----|---|
| 0380266 | 150x80cm z. poten | wit | 6115010 | stuk | 829,00 | 086 | 1 |
| 0380283 | set poten voor designbaden | | 690705 | stuk | 70,00 | 087 | 0 |

Hoesch Patras







kunststof bad acryl rechthoekig



| | | | | | | | |
|---------|----------------------------|-----------|---------|------|---------|-----|---|
| 0381551 | 180x80cm z. poten | wit | 6160000 | stuk | 1158,00 | 087 | 1 |
| 0381578 | 180x80cm z. poten | pergamon | 6160030 | stuk | 1158,00 | 087 | 1 |
| 0381586 | 180x80cm z. poten | edelweiss | 6160013 | stuk | 1506,00 | 087 | 1 |
| 0380019 | 190x80cm z. poten | wit | 6162010 | stuk | 1366,00 | 087 | 1 |
| 0380283 | set poten voor designbaden | | 690705 | stuk | 70,00 | 087 | 0 |



Utiliteit

| | Art.nr | Specificaties | Kleur | Lev.nr | Ehd | Prijs | Grp | CC |
|----------------------------------|---|--|----------|-----------------|------|---------|-----|----|
| | Hoesch Patras | | | | | | | |
| | kunststof bad acryl ovaal | | | | | | | |
| Sanitair producten | 0384135 | 180x80cm z. poten | wit | 6161010 | stuk | 1219,00 | 087 | 1 |
| | 0384143 | 180x80cm z. poten | pergamon | 6161030 | stuk | 1219,00 | 087 | 1 |
| | 0381588 | 190x80cm z. poten | wit | 6163010 | stuk | 1427,00 | 087 | 1 |
| | 0384151 | 190x80cm z. poten | pergamon | 6163030 | stuk | 1427,00 | 087 | 1 |
| | 0380283 | set poten voor designbaden | | 690705 | stuk | 70,00 | 087 | 0 |
| | Hoesch Philippe Starck | | | | | | | |
| | kunststof bad acryl ovaal inbouw | | | | | | | |
| Kranen | 0381594 | 180x90cm z. poten | wit | 6020010 | stuk | 1380,00 | 087 | 1 |
| | 0380283 | set poten voor designbaden | | 690705 | stuk | 70,00 | 087 | 0 |
| | kunststof bad acryl ovaal vrijstaand m. reling 6905 | | | | | | | |
| Douchegarnituur | 0381608 | 180x90cm m. mantel m. waste m. poten | wit | 6021010+6905 | stuk | 4512,00 | 087 | 1 |
| | 0381610 | 180x90cm m. boring rechts z. poten | wit | 6021010030+6905 | stuk | 4512,00 | 087 | 1 |
| | 0381023 | 180x90cm m. boring links z. poten | wit | 6021010020+6905 | stuk | 4512,00 | 087 | 1 |
| Accessoires en spiegels | 0380283 | set poten voor designbaden | | 690705 | stuk | 70,00 | 087 | 0 |
| | Hoesch Philippe Starck II | | | | | | | |
| | kunststof bad acryl ovaal | | | | | | | |
| Douchewanden | 0382396 | 175x80cm inbouw z. poten | wit | 6135010 | stuk | 1180,00 | 087 | 1 |
| | 0382418 | 175x80cm vrijstaand m. poten | wit | 6136010 | stuk | 3380,00 | 087 | 1 |
| | 0380283 | set poten voor designbaden | | 690705 | stuk | 70,00 | 087 | 0 |
| | 0382604 | afvoer- / overloopcombinatie chroom | | 6925305 | stuk | 137,00 | 087 | 1 |
| | Hoesch Regatta | | | | | | | |
| | kunststof bad acryl rechthoekig | | | | | | | |
| Toebehoren & afvoeren | 0382736 | 170x75cm z. poten | wit | 6454010 | stuk | 480,00 | 087 | 1 |
| | 0382744 | 170x75cm z. poten | pergamon | 6454030 | stuk | 480,00 | 087 | 1 |
| | 0380283 | set poten voor designbaden | | 690705 | stuk | 70,00 | 087 | 0 |
| | kunststof bad acryl m. douchezone rechthoekig | | | | | | | |
| Badkamermeubelen en toiletkasten | 0382752 | 180x80cm z. poten | wit | 6460010 | stuk | 655,00 | 087 | 1 |
| | 0382760 | 180x80cm z. poten | pergamon | 6460030 | stuk | 655,00 | 087 | 1 |
| | 0380283 | set poten voor designbaden | | 690705 | stuk | 70,00 | 087 | 0 |
| | kunststof bad acryl rechthoekig | | | | | | | |
| Gootstenen en wastroggen | 0382779 | 180x80cm z. poten | wit | 6456010 | stuk | 655,00 | 087 | 1 |
| | 0382787 | 180x80cm z. poten | pergamon | 6456030 | stuk | 655,00 | 087 | 1 |
| | 0382710 | 190x80cm z. poten | wit | 6462010 | stuk | 743,00 | 087 | 1 |
| | 0382711 | 190x80cm z. poten | pergamon | 6462030 | stuk | 743,00 | 087 | 1 |
| | kunststof bad acryl rechthoekig m. zijte zwart overloop links | | | | | | | |
| Utiliteit | 0382702 | 180x80cm | wit | 6641010 | stuk | 870,00 | 087 | 1 |
| | 0382703 | 180x80cm | pergamon | 6641030 | stuk | 870,00 | 087 | 1 |
| | kunststof bad acryl rechthoekig m. zijte hout overloop links | | | | | | | |
| | 0382704 | 180x80cm | wit | 6643010 | stuk | 931,00 | 087 | 1 |
| | 0382705 | 180x80cm | pergamon | 6643030 | stuk | 931,00 | 087 | 1 |
| | kunststof bad acryl rechthoekig m. zijte zwart overloop rechts | | | | | | | |
| | 0382706 | 180x80cm | wit | 6642010 | stuk | 870,00 | 087 | 1 |
| | 0382707 | 180x80cm | pergamon | 6642030 | stuk | 870,00 | 087 | 1 |
| | kunststof bad acryl rechthoekig m. zijte hout overloop rechts | | | | | | | |
| | 0382708 | 180x80cm | wit | 6644010 | stuk | 931,00 | 087 | 1 |
| | 0382709 | 180x80cm | pergamon | 6644030 | stuk | 931,00 | 087 | 1 |
| | Hoesch Santee | | | | | | | |
| | kunststof bad acryl | | | | | | | |
| Utiliteit | 0381825 | 190x120cm | wit | 6652010 | stuk | 2427,00 | 087 | 1 |
| | 0381832 | afvoer-/overloopcombinatie chroom | | 690952305 | stuk | 137,00 | 087 | 1 |
| | 0381833 | afvoer- / overloop- / vulcombinatie chroom | | 690953305 | stuk | 397,00 | 087 | 1 |

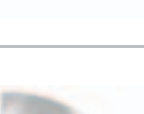
| Art.nr | Specificaties | Kleur | Lev.nr | Ehd | Prijs | Grp | CC | | |
|--|----------------------------|----------|---------|------|---------|-----|----|---|---|
| | | | | | | | | Hoesch Santee | |
| onderstel voor bad | | | | | | | | | |
| 0381827 | | | 690954 | stuk | 201,00 | 087 | 1 | | Sanitair producten |
| | | | | | | | | Hoesch Scelta | |
| kunststof bad acryl rechthoekig | | | | | | | | | |
| 0380097 | 180x90x48cm z. poten | wit | 3671010 | stuk | 745,00 | 086 | 1 |  | Baden / douchebakken / stoomcabines |
| 0380098 | 180x90x48cm z. poten | pergamon | 3671030 | stuk | 745,00 | 086 | 1 | | |
| 0380099 | 190x80x48cm z. poten | wit | 3670010 | stuk | 745,00 | 086 | 1 | | |
| 0380103 | 190x80x48cm z. poten | pergamon | 3670030 | stuk | 745,00 | 086 | 1 | | |
| 0380283 | set poten voor designbaden | | 690705 | stuk | 70,00 | 087 | 0 | | Kranen |
| kunststof bad acryl zeshoekig overloop=links | | | | | | | | | |
| 0380106 | 200x90x48cm z. poten | wit | 3672010 | stuk | 1285,00 | 086 | 1 |  | Accessoires en spiegels |
| 0380107 | 200x90x48cm z. poten | pergamon | 3672030 | stuk | 1285,00 | 086 | 1 | | |
| 0380283 | set poten voor designbaden | | 690705 | stuk | 70,00 | 087 | 0 | | |
| kunststof bad acryl zeshoekig overloop=rechts | | | | | | | | | |
| 0380108 | 200x90x48cm z. poten | wit | 3673010 | stuk | 1285,00 | 086 | 1 |  | Douchegarnituur |
| 0380110 | 200x90x48cm z. poten | pergamon | 3673030 | stuk | 1285,00 | 086 | 1 | | |
| 0380283 | set poten voor designbaden | | 690705 | stuk | 70,00 | 087 | 0 | | |
| kunststof hoekbad acryl | | | | | | | | | |
| 0380111 | 150x150x48cm z. poten | wit | 3676010 | stuk | 1495,00 | 086 | 1 |  | Toebehoren & afvoeren |
| 0380112 | 150x150x48cm z. poten | pergamon | 3676030 | stuk | 1495,00 | 086 | 1 | | |
| 0380283 | set poten voor designbaden | | 690705 | stuk | 70,00 | 087 | 0 | | |
| kunststof hoekbad acryl m. vaste mantel | | | | | | | | | |
| 0380114 | 150x150x48cm m. poten | wit | 3677010 | stuk | 1995,00 | 086 | 1 | | Spoel- & installatiesystemen |
| 0380116 | 150x150x48cm m. poten | pergamon | 3677030 | stuk | 1995,00 | 086 | 1 | | |
| kunststof hoekbad acryl m. losse mantel | | | | | | | | | |
| 0380117 | 150x150x48cm m. poten | wit | 3678010 | stuk | 1995,00 | 086 | 1 | | Badkamermeubelen en toiletkasten |
| 0380118 | 150x150x48cm m. poten | pergamon | 3678030 | stuk | 1995,00 | 086 | 1 | | |
| kunststof bad acryl ovaal overloop=links | | | | | | | | | |
| 0380119 | 200x90x48cm z. poten | wit | 3674010 | stuk | 1585,00 | 086 | 1 |  | Gootstenen en wastroggen |
| 0380120 | 200x90x48cm z. poten | pergamon | 3674030 | stuk | 1585,00 | 086 | 1 | | |
| 0380283 | set poten voor designbaden | | 690705 | stuk | 70,00 | 087 | 0 | | |
| kunststof bad acryl ovaal overloop=rechts | | | | | | | | | |
| 0380121 | 200x90x48cm z. poten | wit | 3675010 | stuk | 1585,00 | 086 | 1 |  | Utiliteit |
| 0380122 | 200x90x48cm z. poten | pergamon | 3675030 | stuk | 1585,00 | 086 | 1 | | |
| 0380283 | set poten voor designbaden | | 690705 | stuk | 70,00 | 087 | 0 | | |

| | Art.nr | Specificaties | Kleur | Lev.nr | Ehd | Prijs | Grp | CC | |
|----------------------------------|--|----------------------------|----------------------------|----------|---------|-------|---------|-----|---|
| Sanitair producten | Hoesch Spectra | | | | | | | | |
| | kunststof bad acryl ovaal | | | | | | | | |
| | | 0382795 | 170x80cm z. poten | wit | 6480010 | stuk | 829,00 | 087 | 1 |
| | | 0382809 | 170x80cm z. poten | pergamon | 6480030 | stuk | 829,00 | 087 | 1 |
| | | 0382817 | 180x80cm z. poten | wit | 6481010 | stuk | 991,00 | 087 | 1 |
| | | 0382825 | 180x80cm z. poten | pergamon | 6481030 | stuk | 991,00 | 087 | 1 |
| | | 0382833 | 190x80cm z. poten | wit | 6483010 | stuk | 1152,00 | 087 | 1 |
| | | 0382841 | 190x80cm z. poten | pergamon | 6483030 | stuk | 1152,00 | 087 | 1 |
| | | 0382868 | 180x90cm z. poten | wit | 6482010 | stuk | 1152,00 | 087 | 1 |
| | | 0382876 | 180x90cm z. poten | pergamon | 6482030 | stuk | 1152,00 | 087 | 1 |
| | 0380283 | set poten voor designbaden | | 690705 | stuk | 70,00 | 087 | 0 | |
| Kranen | kunststof bad acryl rechthoekig | | | | | | | | |
| | | 0380048 | 170x75x48cm z. poten | wit | 3650010 | stuk | 349,00 | 086 | 1 |
| | | 0380049 | 170x75x48cm z. poten | pergamon | 3650030 | stuk | 349,00 | 086 | 1 |
| | | 0380050 | 180x80x48cm z. poten | wit | 3651010 | stuk | 555,00 | 086 | 1 |
| | | 0380051 | 180x80x48cm z. poten | pergamon | 3651030 | stuk | 555,00 | 086 | 1 |
| Douchegarnituur | 0380283 | set poten voor designbaden | | 690705 | stuk | 70,00 | 087 | 0 | |
| Accessoires en spiegels |  | | | | | | | | |
| |  | | | | | | | | |
| Douchewanden |  | | | | | | | | |
| Toebehoren & afvoeren | kunststof hoekbad acryl | | | | | | | | |
| | | 0380052 | 140x140x48cm z. poten | wit | 3653010 | stuk | 1086,00 | 086 | 1 |
| | | 0380053 | 140x140x48cm z. poten | pergamon | 3653030 | stuk | 1086,00 | 086 | 1 |
| | | 0380283 | set poten voor designbaden | | 690705 | stuk | 70,00 | 087 | 0 |
| Spoel- & installatiesystemen | kunststof hoekbad acryl m. vaste mantel | | | | | | | | |
| | | 0380054 | 140x140x48cm m. poten | wit | 3654010 | stuk | 1730,00 | 086 | 1 |
| | | 0380055 | 140x140x48cm m. poten | pergamon | 3654030 | stuk | 1730,00 | 086 | 1 |
| Badkamermeubelen en toiletkasten | kunststof hoekbad acryl m. losse mantel | | | | | | | | |
| | | 0380056 | 140x140x48cm m. poten | wit | 3655010 | stuk | 1730,00 | 086 | 1 |
| | | 0380057 | 140x140x48cm m. poten | pergamon | 3655030 | stuk | 1730,00 | 086 | 1 |
| Gootstenen en wastroggen | kunststof bad acryl zeshoekig | | | | | | | | |
| | | 0380081 | 180x80x48cm z. poten | wit | 3656010 | stuk | 841,00 | 086 | 1 |
| | | 0380082 | 180x80x48cm z. poten | pergamon | 3656030 | stuk | 841,00 | 086 | 1 |
| | | 0380084 | 190x90x48cm z. poten | wit | 3652010 | stuk | 979,00 | 086 | 1 |
| | | 0380085 | 190x90x48cm z. poten | pergamon | 3652030 | stuk | 979,00 | 086 | 1 |
| | | 0380283 | set poten voor designbaden | | 690705 | stuk | 70,00 | 087 | 0 |
| Utiliteit | kunststof hoekbad acryl links | | | | | | | | |
| | | 0380058 | 170x100x48cm z. poten | wit | 3657010 | stuk | 969,00 | 086 | 1 |
| | | 0380069 | 170x100x48cm z. poten | pergamon | 3657030 | stuk | 969,00 | 086 | 1 |
| | | 0380283 | set poten voor designbaden | | 690705 | stuk | 70,00 | 087 | 0 |
| | kunststof hoekbad acryl links m. vaste mantel | | | | | | | | |
| | | 0380070 | 170x100x48cm m. poten | wit | 3658010 | stuk | 1525,00 | 086 | 1 |
| | | 0380071 | 170x100x48cm m. poten | pergamon | 3658030 | stuk | 1525,00 | 086 | 1 |
| | kunststof hoekbad acryl links m. losse mantel | | | | | | | | |
| | | 0380072 | 170x100x48cm m. poten | wit | 3659010 | stuk | 1525,00 | 086 | 1 |
| | | 0380073 | 170x100x48cm m. poten | pergamon | 3659030 | stuk | 1525,00 | 086 | 1 |
| Utiliteit | kunststof hoekbad acryl rechts | | | | | | | | |
| | | 0380074 | 170x100x48cm z. poten | wit | 3660010 | stuk | 969,00 | 086 | 1 |
| | | 0380076 | 170x100x48cm z. poten | pergamon | 3660030 | stuk | 969,00 | 086 | 1 |
| | | 0380283 | set poten voor designbaden | | 690705 | stuk | 70,00 | 087 | 0 |

| Art.nr | Specificaties | Kleur | Lev.nr | Ehd | Prijs | Grp | CC |
|--------|---------------|-------|--------|-----|-------|-----|----|
|--------|---------------|-------|--------|-----|-------|-----|----|

Hoesch Spectra

kunststof hoekbad acryl rechts m. losse mantel

| | | | | | | | |
|---------|-----------------------|----------|---------|------|---------|-----|---|
| 0380077 | 170x100x48cm m. poten | wit | 3661010 | stuk | 1525,00 | 086 | 1 |
| 0380078 | 170x100x48cm m. poten | pergamon | 3661030 | stuk | 1525,00 | 086 | 1 |

kunststof hoekbad acryl rechts m. vaste mantel

| | | | | | | | |
|---------|-----------------------|----------|---------|------|---------|-----|---|
| 0380079 | 170x100x48cm m. poten | wit | 3662010 | stuk | 1525,00 | 086 | 1 |
| 0380080 | 170x100x48cm m. poten | pergamon | 3662030 | stuk | 1525,00 | 086 | 1 |

kunststof bad acryl tweezijdig afgerond

| | | | | | | | |
|---------|----------------------------|----------|---------|------|--------|-----|---|
| 0380086 | 170x80x48cm z. poten | wit | 3663010 | stuk | 945,00 | 086 | 1 |
| 0380087 | 170x80x48cm z. poten | pergamon | 3663030 | stuk | 945,00 | 086 | 1 |
| 0380283 | set poten voor designbaden | | 690705 | stuk | 70,00 | 087 | 0 |



Sanitair producten

Baden /
douchebakken /
stoomcabines

Kranen

Douchegarnituur

kunststof bad acryl tweezijdig afgerond m. vaste mantel

| | | | | | | | |
|---------|----------------------|----------|---------|------|---------|-----|---|
| 0380088 | 170x80x48cm m. poten | wit | 3664010 | stuk | 1545,00 | 086 | 1 |
| 0380096 | 170x80x48cm m. poten | pergamon | 3664030 | stuk | 1545,00 | 086 | 1 |

Hoesch Zero

kunststof bad acryl

| | | | | | | | |
|---------|---------------------------------------|-----|---------|------|---------|-----|---|
| 0381831 | 170x90cm m. rugleuning zwart z. poten | wit | 6627010 | stuk | 1785,00 | 087 | 1 |
| 0380010 | 190x90cm 2 rugleuning zwart z. poten | wit | 6531010 | stuk | 1999,00 | 087 | 1 |
| 0380283 | set poten voor designbaden | | 690705 | stuk | 70,00 | 087 | 0 |
| 0382604 | afvoer- / overloopcombinatie chroom | | 6925305 | stuk | 137,00 | 087 | 1 |

Accessoires en
spiegels

Douchewanden

Hoesch Toebehoren











| | | | | | | | |
|---------|--|--|-----------|------|--------|-----|---|
| 0380283 | set poten voor designbaden | | 690705 | stuk | 70,00 | 087 | 0 |
| 0384550 | set poten voor Holland Line baden | | 590705 | stuk | 19,00 | 087 | 0 |
| 0382422 | afvoer- / overloopcombinatie chroom | | 69261305 | stuk | 144,00 | 087 | 1 |
| 0381707 | afvoer- / overloopcombinatie voor combi 6924 chroom | | 690943305 | stuk | 116,00 | 126 | 1 |
| 0381709 | afvoer- / overloopcombinatie voor combi 6925 chroom | | 690947305 | stuk | 137,00 | 126 | 1 |
| 0381711 | afvoer- / overloopcombinatie voor combi 6926 chroom | | 690948305 | stuk | 164,00 | 126 | 1 |
| 0371713 | afvoer- / overloopcombinatie voor combi 69251 chroom | | 690949305 | stuk | 157,00 | 126 | 1 |
| 0381832 | afvoer-/overloopcombinatie chroom | | 690952305 | stuk | 137,00 | 087 | 1 |
| 0381833 | afvoer- / overloop- / vulcombinatie chroom | | 690953305 | stuk | 397,00 | 087 | 1 |

Toebehoren &
afvoerenSpoel- &
installatiesystemenBadkamermeubelen
en toiletkastenGootstenen en
wastroggen

Utiliteit

Kunststof douchebakken Hoesch

| | Art.nr | Specificaties | Kleur | Lev.nr | Ehd | Prijs | Grp | CC | |
|---|--|---|---|------------|--------|---------|-------|-----|---|
| Sanitair producten | Hoesch Chios | | | | | | | | |
| | kunststof douchebak acryl vierkant | | | | | | | | |
| | 0380237 | 90x90x15cm | wit | 6306010 | stuk | 298,00 | 086 | 0 | |
| | 0380245 | 90x90x15cm | pergamon | 6306030 | stuk | 298,00 | 086 | 1 | |
| | 0380253 | 90x90x15cm | manhattan | 6306020 | stuk | 388,00 | 086 | 1 | |
| Baden / douchebakken / stoomcabines | 0380261 | 90x90x15cm | edelweiss | 6306013 | stuk | 388,00 | 086 | 1 | |
| | 0360635 | douchebaksteun m. 5 verstelbare poten 125-195mm | | 5SGS | stuk | 33,00 | 062 | 0 | |
| Kranen | Hoesch Foster | | | | | | | | |
| | kunststof douchebak acryl z. mantel | | | | | | | | |
| | 0383015 | 120x85cm | wit | 6490010100 | stuk | 1313,00 | 087 | 1 | |
| | 0383023 | 120x85cm m. boring | wit | 6490010600 | stuk | 1313,00 | 087 | 1 | |
| | 0383031 | 120x85cm m. boring m. zijdouches | wit | 6490010700 | stuk | 1459,00 | 087 | 1 | |
| | 0383082 | 160x85cm | wit | 6492010100 | stuk | 1546,00 | 087 | 1 | |
| | 0383090 | 160x85cm m. boring | wit | 6492010600 | stuk | 1546,00 | 087 | 1 | |
| | 0383104 | 160x85cm m. boring m. zijdouches | wit | 6492010700 | stuk | 1692,00 | 087 | 1 | |
| | Douchegarnituur | 0360635 | douchebaksteun m. 5 verstelbare poten 125-195mm | | 5SGS | stuk | 33,00 | 062 | 0 |
| | | kunststof douchebak acryl m. mantel | | | | | | | |
| Accessoires en spiegels | 0383058 | 120x85cm | wit | 6491010100 | stuk | 1575,00 | 087 | 1 | |
| | 0383066 | 120x85cm m. boring | wit | 6491010600 | stuk | 1575,00 | 087 | 1 | |
| | 0383074 | 120x85cm m. boring m. zijdouches | wit | 6491010700 | stuk | 1721,00 | 087 | 1 | |
| | 0383112 | 160x85cm | wit | 6493010100 | stuk | 1808,00 | 087 | 1 | |
| | 0383120 | 160x85cm m. boring | wit | 6493010600 | stuk | 1808,00 | 087 | 1 | |
| Douchewanden | 0383139 | 160x85cm m. boring m. zijdouches | wit | 6493010700 | stuk | 1954,00 | 087 | 1 | |
| | Hoesch Giorno | | | | | | | | |
| Toebehoren & afvoeren | kunststof douchebak acryl kwartrond | | | | | | | | |
| | 0382612 | 100x100cm z. mantel | wit | 6474010 | stuk | 852,00 | 087 | 1 | |
| | 0382620 | 100x100cm m. mantel | wit | 6475010 | stuk | 1145,00 | 087 | 1 | |
| Spoel- & installatiesystemen | Hoesch HappyD | | | | | | | | |
| | kunststof douchebak acryl | | | | | | | | |
| | 0382531 | 90x90cm z. mantel | wit | 6538010 | stuk | 516,00 | 087 | 1 | |
| | 0382515 | 100x80cm z. mantel | wit | 6535010 | stuk | 599,00 | 087 | 1 | |
| Badkamermeubelen en toiletkasten | 0382523 | 90x90cm m. mantel | wit | 6543010 | stuk | 553,00 | 087 | 1 | |
| | 0382507 | 100x80cm m. mantel | wit | 6536010 | stuk | 637,00 | 087 | 1 | |
| Gootstenen en wastroggen | Hoesch Holland Line | | | | | | | | |
| | kunststof douchebak acryl | | | | | | | | |
| | 0383880 | 80x80x6,5cm vierkant | wit | HL2028010 | stuk | 235,00 | 086 | 1 | |
| | 0383899 | 80x80x6,5cm vierkant | pergamon | HL2028030 | stuk | 235,00 | 086 | 1 | |
| | 0383953 | 90x90x6,5cm vierkant | pergamon | HL2031030 | stuk | 260,00 | 086 | 1 | |
| | 0383945 | 90x90x6,5cm vierkant | wit | HL2031010 | stuk | 260,00 | 086 | 1 | |
| | 0383902 | 90x75x6,5cm rechthoekig | wit | HL2029010 | stuk | 248,00 | 086 | 1 | |
| | 0383910 | 90x75x6,5cm rechthoekig | pergamon | HL2029030 | stuk | 248,00 | 086 | 1 | |
| | 0383929 | 90x80x6,5cm rechthoekig | wit | HL2030010 | stuk | 248,00 | 086 | 1 | |
| | 0383937 | 90x80x6,5cm rechthoekig | pergamon | HL2030030 | stuk | 248,00 | 086 | 1 | |
| Utiliteit | 0383848 | 80x80x6,5cm vierkant | wit | HL2032010 | stuk | 273,00 | 086 | 1 | |
| | 0383856 | 80x80x6,5cm vierkant | pergamon | HL2032030 | stuk | 273,00 | 086 | 1 | |
| | 0383864 | 90x90x6,5cm vierkant | wit | HL2033010 | stuk | 273,00 | 086 | 1 | |
| | 0383872 | 90x90x6,5cm vierkant | pergamon | HL2033030 | stuk | 273,00 | 086 | 1 | |
| | 0383961 | 80x80x15cm vierkant | wit | HL2034010 | stuk | 223,00 | 086 | 1 | |
| | 0383988 | 80x80x15cm vierkant | pergamon | HL2034030 | stuk | 223,00 | 086 | 1 | |
| | 0383996 | 90x90x15cm vierkant | wit | HL2035010 | stuk | 223,00 | 086 | 1 | |
| | 0384003 | 90x90x15cm vierkant | pergamon | HL2035030 | stuk | 223,00 | 086 | 1 | |
| | 0384011 | 90x6,5cm vijfhoekig | wit | HL2036010 | stuk | 273,00 | 086 | 1 | |
| | 0384038 | 90x6,5cm vijfhoekig | pergamon | HL2036030 | stuk | 273,00 | 086 | 1 | |
| 0384046 | 100x6,5cm vijfhoekig | wit | HL2037010 | stuk | 285,00 | 086 | 1 | | |
| 0384054 | 100x6,5cm vijfhoekig | pergamon | HL2037030 | stuk | 285,00 | 086 | 1 | | |
| 0384062 | 90x6,5cm kwartrond | wit | HL2038010 | stuk | 273,00 | 086 | 1 | | |
| 0384070 | 90x6,5cm kwartrond | pergamon | HL2038030 | stuk | 273,00 | 086 | 1 | | |
| 0384089 | 100x6,5cm kwartrond | wit | HL2039010 | stuk | 285,00 | 086 | 1 | | |
| 0384097 | 100x6,5cm kwartrond | pergamon | HL2039030 | stuk | 285,00 | 086 | 1 | | |
| | 0360635 | douchebaksteun m. 5 verstelbare poten 125-195mm | | 5SGS | stuk | 33,00 | 062 | 0 | |

| Art.nr | Specificaties | Kleur | Lev.nr | Ehd | Prijs | Grp | CC | | |
|--|---|--------------|---------|------|---------|-----|----|---|---|
| | | | | | | | | Hoesch Lima | |
| kunststof douchebak acryl rechthoekig | | | | | | | | | |
| 0384444 | 120x100x6,5 | wit | 6388010 | stuk | 645,00 | 086 | 1 |  | Sanitair producten |
| 0384267 | 120x100x6,5 | pergamon | 6388030 | stuk | 645,00 | 087 | 1 | | |
| | | | | | | | | Hoesch Nano | |
| kunststof douchebak acryl | | | | | | | | | |
| 0382884 | 90x90x3,2cm vierkant | wit | 6427010 | stuk | 340,00 | 087 | 1 |  | Baden / douchebakken / stoomcabines |
| 0382892 | 90x90x3,2cm vierkant | pergamon | 6427030 | stuk | 340,00 | 087 | 1 | | |
| 0382906 | 100x100x3,2 vierkant | wit | 6428010 | stuk | 445,00 | 087 | 1 |  | Kranen |
| 0382914 | 100x100x3,2 vierkant | pergamon | 6428030 | stuk | 445,00 | 087 | 1 | | |
| 0382922 | 90x90x3,2cm vijfhoekig | wit | 6489010 | stuk | 791,00 | 087 | 1 |  | Douchegarnituur |
| 0382930 | 90x90x3,2cm vijfhoekig | pergamon | 6489030 | stuk | 791,00 | 087 | 1 | | |
| 0382949 | 90x90x3,2cm kwartrond | wit | 6488010 | stuk | 580,00 | 087 | 1 |  | Accessoires en spiegels |
| 0382957 | 90x90x3,2cm kwartrond | pergamon | 6488030 | stuk | 580,00 | 087 | 1 | | |
| 0360635 | douchebaksteen m. 5 verstelbare poten 125-195mm | | 5SGS | stuk | 33,00 | 062 | 0 | | |
| | | | | | | | | Hoesch Philippe Starck | |
| kunststof douchebak acryl | | | | | | | | | |
| 0381624 | 100cm rond | wit | 6351010 | stuk | 1459,00 | 087 | 1 |  | Douchewanden |
| 0381632 | 100cm rond m. mantel | wit | 6350010 | stuk | 1614,00 | 087 | 1 | | |
| 0360635 | douchebaksteen m. 5 verstelbare poten 125-195mm | | 5SGS | stuk | 33,00 | 062 | 0 | | |
| | | | | | | | | Hoesch Regatta | |
| kunststof douchebak acryl vierkant | | | | | | | | | |
| 0381622 | 80x80cm | wit | 6464010 | stuk | 351,00 | 087 | 1 |  | Toebehoren & afvoeren |
| 0381623 | 80x80cm | pergamon | 6464030 | stuk | 351,00 | 087 | 1 | | |
| 0381620 | 90x90cm | wit | 6463010 | stuk | 377,00 | 087 | 1 | | |
| 0381621 | 90x90cm | pergamon | 6463030 | stuk | 377,00 | 087 | 1 | | |
| | | | | | | | | Hoesch Thasos | |
| kunststof douchebak acryl vierkant | | | | | | | | | |
| 0380179 | 80x80x6.5cm | wit | 6323010 | stuk | 328,00 | 086 | 1 |  | Spool- & installatiesystemen |
| kunststof douchebak acryl | | | | | | | | | |
| 0380183 | 80x80x6.5cm | pergamon | 6323030 | stuk | 328,00 | 086 | 1 | | Badkamermeubelen en toiletkasten |
| kunststof douchebak acryl rechthoekig | | | | | | | | | |
| 0380188 | 90x75x6.5cm | wit | 6389010 | stuk | 346,00 | 086 | 1 |  | Gootstenen en wastroggen |
| 0380189 | 90x75x6.5cm | pergamon | 6389030 | stuk | 346,00 | 086 | 1 | | |
| 0380190 | 90x80x6.5cm | wit | 6325010 | stuk | 346,00 | 086 | 1 | | |
| 0380182 | 90x80x6.5cm | pergamon | 6325030 | stuk | 346,00 | 086 | 1 | | |
| kunststof douchebak acryl | | | | | | | | | |
| 0380178 | 90x90x6.5cm vierkant | wit | 6319010 | stuk | 336,00 | 086 | 1 |  | Utiliteit |
| 0380187 | 90x90x6.5cm vierkant | pergamon | 6319030 | stuk | 336,00 | 086 | 1 | | |
| 0380175 | 90x90x6.5cm vierkant | klassiek wit | 6319011 | stuk | 431,00 | 086 | 1 | | |
| 0384585 | 100x100x6.5 vierkant | wit | 6324010 | stuk | 419,00 | 086 | 1 | | |
| 0380184 | 100x100x6.5 vierkant | pergamon | 6324030 | stuk | 419,00 | 086 | 1 | | |
| | | | | | | | | Hoesch Tilos | |
| kunststof douchebak acryl | | | | | | | | | |
| 0382226 | 120x80x6.5 rechthoekig | wit | 6390010 | stuk | 558,00 | 086 | 1 |  | |
| 0380021 | 120x80x6.5 rechthoekig | pergamon | 6390030 | stuk | 558,00 | 086 | 1 | | |

Kunststof douchebakken Huppe

| | Art.nr | Specificaties | Kleur | Lev.nr | Ehd | Prijs | Grp | CC |
|--|---|----------------------------|----------|-----------|------|--------|-----|----|
| Huppe Classique | | | | | | | | |
| Sanitair producten | kunststof douchebak acryl vierkant | | | | | | | |
| | 0360694 | 90x90cm z. ommanteling | wit | 234806055 | stuk | 206,00 | 281 | 1 |
| ommanteling voor douchebak | | | | | | | | |
| | 0360708 | 90cm vierkant | wit | 202061055 | stuk | 112,00 | 281 | 1 |
| kunststof douchebak acryl kwartrond | | | | | | | | |
| Baden / douchebakken / stoomcabines | 0360716 | 90x90x9cm z. ommanteling | wit | 234816055 | stuk | 206,00 | 281 | 1 |
| | kunststof douchebak acryl vijfhoekig | | | | | | | |
| Kranen | 0360724 | 90x90x9cm z. ommanteling | wit | 234825055 | stuk | 206,00 | 281 | 1 |
| Huppe Marano | | | | | | | | |
| kunststof douchebak acryl vierkant | | | | | | | | |
| Douchegarnituur | 0984702 | 80x80x6cm z. ommanteling | wit | 202001055 | stuk | 378,00 | 281 | 1 |
| | 0995185 | 80x80x6cm z. ommanteling | pergamon | 202001014 | stuk | 378,00 | 281 | 1 |
| | 0984709 | 90x90x6cm z. ommanteling | wit | 202003055 | stuk | 378,00 | 281 | 1 |
| | 0984712 | 90x90x6cm z. ommanteling | pergamon | 202003014 | stuk | 378,00 | 281 | 1 |
| kunststof douchebak acryl kwartrond | | | | | | | | |
| Accessoires en spiegels | 0984637 | 80x80x6cm z. ommanteling | wit | 202020055 | stuk | 532,00 | 281 | 1 |
| | 0995193 | 80x80x6cm z. ommanteling | pergamon | 202020014 | stuk | 532,00 | 281 | 1 |
| | 0984648 | 90x90x6cm z. ommanteling | wit | 202021055 | stuk | 532,00 | 281 | 1 |
| | 0984649 | 90x90x6cm z. ommanteling | pergamon | 202021014 | stuk | 532,00 | 281 | 1 |
| Douchewanden | 0984641 | 100x100x6cm z. ommanteling | wit | 202022055 | stuk | 532,00 | 281 | 1 |
| | 0980106 | 100x100x6cm z. ommanteling | pergamon | 202022014 | stuk | 532,00 | 281 | 1 |
| | ommanteling voor douchebak | | | | | | | |
| | 0995207 | 80cm kwartrond | wit | 202050055 | stuk | 112,00 | 281 | 1 |
| Toebehoren & afvoeren | 0995215 | 80cm kwartrond | pergamon | 202050014 | stuk | 112,00 | 281 | 1 |
| | 0984640 | 90cm kwartrond | wit | 202051055 | stuk | 112,00 | 281 | 1 |
| | 0995223 | 90cm kwartrond | pergamon | 202051014 | stuk | 112,00 | 281 | 1 |
| | 0995231 | 100cm kwartrond | wit | 202052055 | stuk | 112,00 | 281 | 1 |
| Spoel- & installatiesystemen | 0995258 | 100cm kwartrond | pergamon | 202052014 | stuk | 112,00 | 281 | 1 |
| | kunststof douchebak acryl vijfhoekig | | | | | | | |
| | 0984634 | 90x90x6cm z. ommanteling | wit | 202010055 | stuk | 532,00 | 281 | 1 |
| | 0995266 | 90x90x6cm z. ommanteling | pergamon | 202010014 | stuk | 532,00 | 281 | 1 |
| Badkamermeubelen en toiletkasten | 0995347 | 100x100x6cm z. ommanteling | wit | 202012055 | stuk | 532,00 | 281 | 1 |
| | 0995355 | 100x100x6cm z. ommanteling | pergamon | 202012014 | stuk | 532,00 | 281 | 1 |
| | ommanteling voor douchebak | | | | | | | |
| Gootstenen en wastroggen | 0985005 | 90cm vijfhoekig | wit | 202071055 | stuk | 112,00 | 281 | 1 |
| | 0995274 | 90cm vijfhoekig | pergamon | 202071014 | stuk | 112,00 | 281 | 1 |
| | 0995363 | 100cm vijfhoekig | wit | 202072055 | stuk | 112,00 | 281 | 1 |
| | 0995371 | 100cm vijfhoekig | pergamon | 202072014 | stuk | 112,00 | 281 | 1 |
| kunststof douchebak acryl half rond | | | | | | | | |
| Utiliteit | 0980450 | 114x90x6cm z. ommanteling | wit | 202025055 | stuk | 772,00 | 281 | 1 |
| | 0360678 | 114x90x6cm z. ommanteling | pergamon | 202025014 | stuk | 772,00 | 281 | 1 |
| ommanteling voor douchebak | | | | | | | | |
| | 0980500 | half rond | wit | 202055055 | stuk | 112,00 | 281 | 1 |
| | 0360686 | half rond | pergamon | 202055014 | stuk | 112,00 | 281 | 1 |

| Art.nr | Specificaties | Kleur | Lev.nr | Ehd | Prijs | Grp | CC |
|--|--------------------------------------|----------|-----------|------|--------|-----|----|
| Hüppe Purano | | | | | | | |
| kunststof douchebak acryl kwartrond | | | | | | | |
| 0980416 | 80x80cm z. ommanteling m. antislip | wit | 202150055 | stuk | 420,00 | 281 | 1 |
| 0980417 | 80x80cm z. ommanteling m. antislip | pergamon | 202150014 | stuk | 420,00 | 281 | 1 |
| 0983192 | 80x90cm z. ommanteling m. antislip | wit | 202155055 | stuk | 420,00 | 281 | 1 |
| 0983193 | 80x90cm z. ommanteling m. antislip | pergamon | 202155014 | stuk | 420,00 | 281 | 1 |
| 0983197 | 80x100cm z. ommanteling m. antislip | wit | 202148055 | stuk | 420,00 | 281 | 1 |
| 0983198 | 80x100cm z. ommanteling m. antislip | pergamon | 202148014 | stuk | 420,00 | 281 | 1 |
| 0983194 | 90x80cm z. ommanteling m. antislip | wit | 202156055 | stuk | 420,00 | 281 | 1 |
| 0983196 | 90x80cm z. ommanteling m. antislip | pergamon | 202156014 | stuk | 420,00 | 281 | 1 |
| 0980421 | 90x90cm z. ommanteling m. antislip | wit | 202151055 | stuk | 420,00 | 281 | 1 |
| 0980422 | 90x90cm z. ommanteling m. antislip | pergamon | 202151014 | stuk | 420,00 | 281 | 1 |
| 0983202 | 90x100cm z. ommanteling m. antislip | wit | 202153055 | stuk | 420,00 | 281 | 1 |
| 0983203 | 90x100cm z. ommanteling m. antislip | pergamon | 202153014 | stuk | 420,00 | 281 | 1 |
| 0983207 | 90x120cm z. ommanteling m. antislip | wit | 202146055 | stuk | 420,00 | 281 | 1 |
| 0983208 | 90x120cm z. ommanteling m. antislip | pergamon | 202146014 | stuk | 420,00 | 281 | 1 |
| 0983199 | 100x80cm z. ommanteling m. antislip | wit | 202149055 | stuk | 420,00 | 281 | 1 |
| 0983200 | 100x80cm z. ommanteling m. antislip | pergamon | 202149014 | stuk | 420,00 | 281 | 1 |
| 0983204 | 100x90cm z. ommanteling m. antislip | wit | 202154055 | stuk | 420,00 | 281 | 1 |
| 0983205 | 100x90cm z. ommanteling m. antislip | pergamon | 202154014 | stuk | 420,00 | 281 | 1 |
| 0983190 | 100x100cm z. ommanteling m. antislip | wit | 202152055 | stuk | 420,00 | 281 | 1 |
| 0983191 | 100x100cm z. ommanteling m. antislip | pergamon | 202152014 | stuk | 420,00 | 281 | 1 |
| 0983211 | 120x90cm z. ommanteling m. antislip | wit | 202147055 | stuk | 420,00 | 281 | 1 |
| 0983213 | 120x90cm z. ommanteling m. antislip | pergamon | 202147014 | stuk | 420,00 | 281 | 1 |
| ommanteling voor douchebak | | | | | | | |
| 0980418 | 80cm kwartrond | wit | 202170055 | stuk | 112,00 | 281 | 1 |
| 0980419 | 80cm kwartrond | pergamon | 202170014 | stuk | 112,00 | 281 | 1 |
| 0980423 | 90cm kwartrond | wit | 202171055 | stuk | 112,00 | 281 | 1 |
| 0980424 | 90cm kwartrond | pergamon | 202171014 | stuk | 112,00 | 281 | 1 |
| 0983214 | 100cm kwartrond | wit | 202172055 | stuk | 112,00 | 281 | 1 |
| 0983215 | 100cm kwartrond | pergamon | 202172014 | stuk | 112,00 | 281 | 1 |
| kunststof douchebak vierkant acryl | | | | | | | |
| 0980396 | 80x80cm z. ommanteling m. antislip | wit | 202160055 | stuk | 266,00 | 281 | 1 |
| 0980397 | 80x80cm z. ommanteling m. antislip | pergamon | 202160014 | stuk | 266,00 | 281 | 1 |
| 0980403 | 90x90cm z. ommanteling m. antislip | wit | 202161055 | stuk | 266,00 | 281 | 1 |
| 0980409 | 90x90cm z. ommanteling m. antislip | pergamon | 202161014 | stuk | 266,00 | 281 | 1 |
| 0983174 | 100x100cm z. ommanteling m. antislip | wit | 202162055 | stuk | 266,00 | 281 | 1 |
| 0983176 | 100x100cm z. ommanteling m. antislip | pergamon | 202162014 | stuk | 266,00 | 281 | 1 |
| kunststof douchebak rechthoekig acryl | | | | | | | |
| 0983177 | 120x80cm z. ommanteling m. antislip | wit | 202163055 | stuk | 266,00 | 281 | 1 |
| 0983178 | 120x80cm z. ommanteling m. antislip | pergamon | 202163014 | stuk | 266,00 | 281 | 1 |
| ommanteling voor douchebak | | | | | | | |
| 0980398 | 80x80cm vierkant | wit | 202180055 | stuk | 112,00 | 281 | 1 |
| 0980399 | 80x80cm vierkant | pergamon | 202180014 | stuk | 112,00 | 281 | 1 |
| 0980411 | 90x90cm vierkant | wit | 202181055 | stuk | 112,00 | 281 | 1 |
| 0980413 | 90x90cm vierkant | pergamon | 202181014 | stuk | 112,00 | 281 | 1 |
| 0983180 | 100x100cm vierkant | wit | 202182055 | stuk | 112,00 | 281 | 1 |
| 0983181 | 100x100cm vierkant | pergamon | 202182014 | stuk | 112,00 | 281 | 1 |
| 0983182 | 120x80cm rechthoekig | wit | 202183055 | stuk | 112,00 | 281 | 1 |
| 0983183 | 120x80cm rechthoekig | pergamon | 202183014 | stuk | 112,00 | 281 | 1 |
| plint voor nis | | | | | | | |
| 0980401 | 80cm | wit | 202185055 | stuk | 112,00 | 281 | 1 |
| 0980402 | 80cm | pergamon | 202185014 | stuk | 112,00 | 281 | 1 |
| 0980414 | 90cm | wit | 202186055 | stuk | 112,00 | 281 | 1 |
| 0980415 | 90cm | pergamon | 202186014 | stuk | 112,00 | 281 | 1 |
| 0983185 | 100cm | wit | 202187055 | stuk | 112,00 | 281 | 1 |
| 0983186 | 100cm | pergamon | 202187014 | stuk | 112,00 | 281 | 1 |
| 0983188 | 120cm | wit | 202188055 | stuk | 112,00 | 281 | 1 |
| 0983189 | 120cm | pergamon | 202188014 | stuk | 112,00 | 281 | 1 |

Sanitair producten

Baden /
douchebakken /
stoomcabines

Kranen

Douchegarnituur

Accessoires en
spiegels

Douchewanden

Toebehoren &
afvoerenSpoel- &
installatiesystemenBadkamermeubelen
en toiletkastenGootstenen en
wastroggen



Utiliteit











Kunststof baden /douchebakken JOOP!

| | Art.nr | Specificaties | Kleur | Lev.nr | Ehd | Prijs | Grp | CC | |
|---|-----------------------------------|--|-------|--------------|------|---------|-----|----|--|
| | JOOP! baden / douchebakken | | | | | | | | |
| | kunststof bad acryl | | | | | | | | |
| Sanitair producten | 0340103 | 150x90x65cm m. nekkussen grijs z. paneel | wit | S8JP62270000 | stuk | 2094,00 | 112 | 1 | |
| | paneel voor JP62270000 | | | | | | | | |
| | 0340106 | front | wit | S8JP80201000 | stuk | 2535,00 | 112 | 1 | |
| | 0340109 | wand rechts | wit | S8JP80211000 | stuk | 2072,00 | 112 | 1 | |
| Baden / douchebakken / stoomcabines | 0340112 | wand links | wit | S8JP80221000 | stuk | 2072,00 | 112 | 1 | |
| | 0340115 | vrijstaand | wit | S8JP80231000 | stuk | 3517,00 | 112 | 1 | |
| | kunststof bad acryl | | | | | | | | |
| | 0340104 | 180x90x47cm m. nekkussen grijs z. paneel | wit | S8JP62250000 | stuk | 2182,00 | 112 | 1 | |
| Kranen | | paneel voor JP62250000 | | | | | | | |
| | 0340107 | front | wit | S8JP80241000 | stuk | 2513,00 | 112 | 1 | |
| | 0340110 | wand rechts | wit | S8JP80251000 | stuk | 2051,00 | 112 | 1 | |
| | 0340113 | wand links | wit | S8JP80261000 | stuk | 2051,00 | 112 | 1 | |
| Douchegarnituur | 0340116 | vrijstaand | wit | S8JP80271000 | stuk | 3473,00 | 112 | 1 | |
| | kunststof bad acryl | | | | | | | | |
| | 0340105 | 190x90x43cm m. nekkussen grijs z. paneel | wit | S8JP62260000 | stuk | 2315,00 | 112 | 1 | |
| Accessoires en spiegels | | paneel voor JP62260000 | | | | | | | |
| | 0340108 | front | wit | S8JP80281000 | stuk | 2525,00 | 112 | 1 | |
| | 0340111 | wand rechts | wit | S8JP80291000 | stuk | 2061,00 | 112 | 1 | |
| | 0340114 | wand links | wit | S8JP80301000 | stuk | 2061,00 | 112 | 1 | |
| Douchewanden | 0340117 | vrijstaand | wit | S8JP80311000 | stuk | 3473,00 | 112 | 1 | |
| | kunststof douchebak | | | | | | | | |
| | 0340041 | 90x90x3.5 | wit | S8JP61310000 | stuk | 695,00 | 112 | 1 | |
| | 0340042 | 100x90x3.5 | wit | S8JP61320000 | stuk | 838,00 | 112 | 1 | |
| Toebehoren & afvoeren | 0340043 | 120x90x3.5 | wit | S8JP61330000 | stuk | 905,00 | 112 | 1 | |
| Spoel- & installatiesystemen | | | | | | | | | |
| Badkamermeubelen en toiletkasten | | | | | | | | | |
| Gootstenen en wastroggen | | | | | | | | | |
| Utiliteit | | | | | | | | | |

| Art.nr | Specificaties | Kleur | Lev.nr | Ehd | Prijs | Grp | CC |
|----------------------|-----------------------------|-------|---------------|------|---------|-----|----------------------|
| | | | | | | | Laufen Alessi |
| bad wandmodel | | | | | | | |
| 0080675 | 204x109.5cm | wit | 2429700000001 | stuk | 5598,82 | 035 | 1 |
| 0080676 | 204x109.5cm anti bacterieel | wit | 2429703000001 | stuk | 5931,17 | 035 | 1 |

- Sanitair producten
- Baden /
douchebakken /
stoomcabines**
- Kranen
- Douchegarnituur
- Accessoires en
spiegels
- Douchewanden
- Toebehoren &
afvoeren
- Spoel- &
installatiesystemen
- Badkamermeubelen
en toiletkasten
- Gootstenen en
wastroggen
- Utiliteit

| | Art.nr | Specificaties | Kleur | Lev.nr | Ehd | Prijs | Grp | CC | |
|---|---|---|----------------------|---------------|------------|--------|--------|-----|---|
| Sanitair producten | Laufen Alessi douchebakken | | | | | | | | |
| | douchebak keramisch | | | | | | | | |
| | 0080677 | 120x80cm links | wit | 8509710000001 | stuk | 180,25 | 035 | 1 | |
| | 0080678 | 120x80cm rechts | wit | 8509720000001 | stuk | 180,25 | 035 | 1 | |
| Baden / douchebakken / stoomcabines | douchebak keramisch kwartrond | | | | | | | | |
| | 0080679 | 90x90cm | wit | 8509740000001 | stuk | 439,50 | 035 | 1 | |
| Kranen | Novellini Victory-A | | | | | | | | |
| | kunststof douchebak acryl kwartrond | | | | | | | | |
| |  | 0321070 | 90x90x11.5 | wit | VIA901130 | stuk | 204,00 | 288 | 1 |
| | | 0982049 | 100x100x11.5 | wit | VIA1001130 | stuk | 204,00 | 288 | 1 |
| | 0360635 | douchebaksteun m. 5 verstelbare poten 125-195mm | | 5SGS | stuk | 33,00 | 062 | 0 | |
| Douchegarnituur | Novellini Victory-B | | | | | | | | |
| | kunststof douchebak acryl kwartrond | | | | | | | | |
| |  | 0321083 | 80x80x23 m. paneel | wit | VIB8030 | stuk | 288,00 | 288 | 1 |
| | | 0321094 | 80x80x23 m. paneel | pergamon | VIB8069 | stuk | 288,00 | 288 | 1 |
| | | 0321087 | 90x90x23 m. paneel | wit | VIB9030 | stuk | 288,00 | 288 | 0 |
| Accessoires en spiegels | | 0321095 | 90x90x23 m. paneel | pergamon | VIB9069 | stuk | 288,00 | 288 | 0 |
| | | 0982050 | 100x100x23 m. paneel | wit | VIB10030 | stuk | 288,00 | 288 | 1 |
| | | 0982051 | 100x100x23 m. paneel | pergamon | VIB10069 | stuk | 288,00 | 288 | 1 |
| | Douchewanden | Novellini Victory-P1 | | | | | | | |
| kunststof douchebak acryl vijfhoekig | | | | | | | | | |
| | | 0321089 | 90x90x23 m. paneel | wit | VIP19030 | stuk | 288,00 | 288 | 1 |
| | | 0321099 | 90x90x23 m. paneel | pergamon | VIP19069 | stuk | 288,00 | 288 | 1 |
| | | 0982060 | 100x100x23 m. paneel | wit | VIP110030 | stuk | 288,00 | 288 | 1 |
| | 0982061 | 100x100x23 m. paneel | pergamon | VIP110069 | stuk | 288,00 | 288 | 1 | |
| Toebehoren & afvoeren | | | | | | | | | |
| Spoel- & installatiesystemen | | | | | | | | | |
| Badkamermeubelen en toiletkasten | | | | | | | | | |
| Gootstenen en wastroggen | | | | | | | | | |
| Utiliteit | | | | | | | | | |

| Art.nr | Specificaties | Kleur | Lev.nr | Ehd | Prijs | Grp | CC | | |
|---|---------------------------|-----------|---------|------|--------|-----|----|---|---|
| | | | | | | | | Plieger Standaard | |
| voetzitbad kunststof | | | | | | | | | |
| 0940046 | 120x70cm m. poten | wit | 0940046 | stuk | 159,28 | 060 | 1 |  | Sanitair producten |
| | | | | | | | | Plieger Basic | |
| kunststof bad acryl rechthoekig | | | | | | | | | |
| 0944093 | 170x70cm m. poten | wit | 0944093 | stuk | 128,00 | 060 | 0 |  | Baden / douchebakken / stoomcabines |
| | | | | | | | | Plieger Bern | |
| kunststof bad acryl zeshoekig | | | | | | | | | |
| 0944017 | 190x80cm m. poten | wit | 0944017 | stuk | 324,29 | 060 | 0 |  | Kranen |
| 0944025 | 190x80cm m. poten | pergamon | 0944025 | stuk | 324,29 | 060 | 0 | | Douchegarnituur |
| | | | | | | | | Plieger Contour | |
| kunststof hoekbad acryl vijfhoekig | | | | | | | | | |
| 0940900 | 125x125cm z. paneel | wit | 0940900 | stuk | 377,65 | 060 | 0 |  | Accessoires en spiegels |
| 0940803 | 125x125cm m. paneel | wit | 0940803 | stuk | 577,40 | 060 | 0 | | Douchewanden |
| 0940807 | 125x125cm m. paneel | pergamon | 0940807 | stuk | 577,82 | 060 | 0 | | |
| voorpaneel voor hoekbad vijfhoekig | | | | | | | | | |
| 0940902 | 125cm | wit | 0940902 | stuk | 199,75 | 060 | 0 | | |
| | | | | | | | | Plieger Corfu | |
| kunststof bad acryl rechthoekig | | | | | | | | | |
| 0941410 | 180x80x48cm m. poten | wit | 0941410 | stuk | 348,03 | 060 | 0 |  | Toebehoren & afvoeren |
| 0941412 | 180x80x48cm m. poten | pergamon | 0941412 | stuk | 377,02 | 060 | 0 | | |
| | | | | | | | | Plieger Cyprus | |
| voorpaneel voor hoekbad kwart rond | | | | | | | | | |
| 0940934 | 160cm rechts | wit | 0940934 | stuk | 166,12 | 060 | 0 |  | Spoel- & installatiesystemen |
| 0940930 | 160cm links | wit | 0940930 | stuk | 166,12 | 060 | 0 | | Badkamermeubelen en toiletkasten |
| New kunststof hoekbad acryl | | | | | | | | | |
| 0941440 | 160x90cm links m. paneel | wit | 0941440 | stuk | 443,67 | 060 | 0 |  | Gootstenen en wastroggen |
| 0941441 | 160x90cm links z. paneel | wit | 0941441 | stuk | 277,55 | 060 | 0 | | |
| 0941442 | 160x90cm rechts m. paneel | wit | 0941442 | stuk | 443,67 | 060 | 0 | | |
| 0941443 | 160x90cm rechts z. paneel | wit | 0941443 | stuk | 277,55 | 060 | 0 | | Utiliteit |
| | | | | | | | | Plieger Douro | |
| kunststof bad acryl rechthoekig | | | | | | | | | |
| 0942512 | 180x80cm m. poten | wit | 0942512 | stuk | 300,25 | 060 | 0 |  | |
| 0942514 | 180x80cm m. poten | pergamon | 0942514 | stuk | 328,74 | 060 | 0 | | |
| | | | | | | | | Plieger Kreta | |
| kunststof hoekbad acryl kwart rond | | | | | | | | | |
| 0940904 | 135x135cm z. paneel | wit | 0940904 | stuk | 368,84 | 060 | 0 |  | |
| 0940908 | 135x135cm z. paneel | pergamon | 0940908 | stuk | 420,94 | 060 | 0 | | |
| 0940809 | 135x135cm m. paneel | wit | 0940809 | stuk | 533,33 | 060 | 0 | | |
| 0941002 | 135x135cm m. paneel | pergamon | 0941002 | stuk | 600,48 | 060 | 0 | | |
| 0941008 | 135x135cm m. paneel | edelweiss | 0941008 | stuk | 733,92 | 060 | 0 | | |
| voorpaneel voor hoekbad kwart rond | | | | | | | | | |
| 0940906 | 135cm | wit | 0940906 | stuk | 164,49 | 060 | 0 | | |
| 0940910 | 135cm | pergamon | 0940910 | stuk | 179,54 | 060 | 0 | | |
| | | | | | | | | Plieger Luzern | |
| kunststof bad acryl achthoekig | | | | | | | | | |
| 0944033 | 180x80cm m. poten | wit | 0944033 | stuk | 310,92 | 060 | 0 |  | |
| 0944041 | 180x80cm m. poten | pergamon | 0944041 | stuk | 310,92 | 060 | 0 | | |

| | Art.nr | Specificaties | Kleur | Lev.nr | Ehd | Prijs | Grp | CC |
|---|--|-----------------------------------|----------|---------|------|--------|-----|----|
| Sanitair producten | Plieger Milos | | | | | | | |
| | kunststof bad acryl rechthoekig | | | | | | | |
| | 0941180 | 180x80cm m. poten | wit | 0941180 | stuk | 300,25 | 060 | 0 |
| | 0941182 | 180x80cm m. poten | pergamon | 0941182 | stuk | 328,74 | 060 | 0 |
| Baden / douchebakken / stoomcabines | Plieger Naxos | | | | | | | |
| | kunststof bad acryl rechthoekig | | | | | | | |
| | 0941170 | 170x75cm m. poten | wit | 0941170 | stuk | 204,20 | 060 | 0 |
| Kranen | 0941172 | 170x75cm m. poten | pergamon | 0941172 | stuk | 221,97 | 060 | 0 |
| Douchegarnituur | Plieger Paros | | | | | | | |
| | kunststof bad acryl rechthoekig | | | | | | | |
| | 0941160 | 170x70cm m. poten | wit | 0941160 | stuk | 186,39 | 060 | 0 |
| Accessoires en spiegels | 0941162 | 170x70cm m. poten | pergamon | 0941162 | stuk | 186,39 | 060 | 0 |
| Douchewanden | Plieger Queen | | | | | | | |
| | New kunststof bad acryl rechthoekig | | | | | | | |
| | 0941430 | 170x70cm m. poten | wit | 0941430 | stuk | 183,87 | 060 | 0 |
| | 0941432 | 170x70cm m. poten | pergamon | 0941432 | stuk | 186,97 | 060 | 0 |
| Toebehoren & afvoeren | Plieger Royalty | | | | | | | |
| | New kunststof bad acryl rechthoekig | | | | | | | |
| | 0941420 | 170x75cm m. poten | wit | 0941420 | stuk | 203,74 | 060 | 0 |
| | 0941422 | 170x75cm m. poten | pergamon | 0941422 | stuk | 213,99 | 060 | 0 |
| Spoel- & installatiesystemen | Plieger Samos | | | | | | | |
| | kunststof bad acryl rechthoekig | | | | | | | |
| | 0941400 | 180x80x48cm m. poten m. rand 90mm | wit | 0941400 | stuk | 348,03 | 060 | 0 |
| Badkamermeubelen en toiletkasten | 0941402 | 180x80x48cm m. poten m. rand 90mm | pergamon | 0941402 | stuk | 377,02 | 060 | 0 |
| Gootstenen en wastroggen | Plieger Zurich | | | | | | | |
| | kunststof bad acryl ovaal | | | | | | | |
| | 0944068 | 180x90cm m. poten | wit | 0944068 | stuk | 324,29 | 060 | 0 |
| | 0944076 | 180x90cm m. poten | pergamon | 0944076 | stuk | 324,29 | 060 | 0 |
| Utiliteit | ombouwpaneel | | | | | | | |
| | 0941290 | 180x90cm. | wit | 0941290 | stuk | 215,71 | 060 | 0 |
| | 0941292 | 180x90cm. | pergamon | 0941292 | stuk | 215,71 | 060 | 0 |
| | Plieger Toebehoren | | | | | | | |
| | 0941300 | hoofdsteun universeel voor bad | wit | 0941300 | stuk | 35,42 | 060 | 0 |
| | 0341533 | badpoten universeel 5047 | per set | 5047 | stuk | 17,75 | 061 | 0 |
| | 0340079 | poten voor voetzitbad 105x65cm | | 0340079 | stuk | 22,75 | 062 | 0 |
| | 0340960 | badpoten per set universeel | | 0340960 | stuk | 38,00 | 073 | 0 |

| Art.nr | Specificaties | Kleur | Lev.nr | Ehd | Prijs | Grp | CC | | |
|---|--|----------|----------|------|--------|-----|----|------------------------|---|
| | | | | | | | | Plieger Liberty | |
| kunststof bad acryl rechthoekig m. poten | | | | | | | | | |
| 0948063 | 180x80x49cm | wit | 0948063 | stuk | 446,00 | 060 | 0 | | Sanitair producten |
| 0948071 | 180x80x49cm | pergamon | 0948071 | stuk | 499,00 | 060 | 0 | | |
| 0341967 | baddrager 180x80cm Liberty rechthoekig | | 17153691 | stuk | 298,00 | 082 | 1 | | |
| kunststof bad acryl ovaal | | | | | | | | | |
| 0947997 | 180x80cm | wit | 0947997 | stuk | 467,00 | 060 | 0 | | Baden / douchebakken / stoomcabines |
| 0948039 | 180x80cm | pergamon | 0948039 | stuk | 542,00 | 060 | 0 | | |
| 0341924 | baddrager 180x80cm Liberty ovaal | | 17053227 | stuk | 395,00 | 082 | 1 | | |
| mantel voor bad ovaal | | | | | | | | | |
| 0948047 | | wit | 0948047 | stuk | 372,00 | 060 | 0 | | Kranen |
| 0948055 | | pergamon | 0948055 | stuk | 435,00 | 060 | 0 | | |
| kunststof hoekbad acryl m. poten | | | | | | | | | |
| 0947954 | 135x135cm | wit | 0947954 | stuk | 579,00 | 060 | 0 | | Douchegarnituur |
| 0947962 | 135x135cm | pergamon | 0947962 | stuk | 674,00 | 060 | 0 | | |
| 0341916 | baddrager 135x135cm Liberty hoekbad | | 17053226 | stuk | 858,00 | 082 | 1 | | |
| voorpaneel voor hoekbad | | | | | | | | | |
| 0947970 | | wit | 0947970 | stuk | 261,00 | 060 | 0 | | Douchewanden |
| 0947989 | | pergamon | 0947989 | stuk | 308,00 | 060 | 0 | | |
| | | | | | | | | Plieger Spring | |
| kunststof bad acryl rechthoekig | | | | | | | | | |
| 0947121 | 170x75cm m. poten | wit | 0947121 | stuk | 322,00 | 060 | 0 | | Toebehoren & afvoeren |
| 0947148 | 170x75cm m. poten | pergamon | 0947148 | stuk | 322,00 | 060 | 0 | | |
| 0943223 | 180x80cm m. poten | wit | 0943223 | stuk | 375,00 | 060 | 0 | | |
| 0943231 | 180x80cm m. poten | pergamon | 0943231 | stuk | 375,00 | 060 | 0 | | |
| 0341959 | baddrager 180x80cm Spring | | 17153623 | stuk | 219,00 | 082 | 1 | | |
| Badkamermeubelen en toiletkasten | | | | | | | | | |
| Gootstenen en wastroggen | | | | | | | | | |
| Utiliteit | | | | | | | | | |

Bruisen maar...

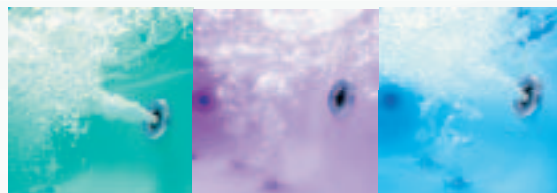

Hydro-Spa-Hydro&Spa

...in elk
Spring en
Liberty
bad

Whirlpoolsystemen met
zeer veel voordelen

- Korte levertijden
- Langdurige kwaliteit
- Unieke aluminium frames
- Geruisloze motoren
- Altijd compleet met afvoerset
- Massieve bodemjets
- Nederlands fabrikaat
- Service dienst
- Eigen ontwikkelde elektronica (voldoet aan KEMA eisen)
- Alle producten zijn CE gekeurd
- Pneumatische en elektronische bediening
- Flexibiliteit

| Art.nr | Specificaties | Kleur | Lev.nr | Ehd | Prijs | Grp | CC |
|--|---|-----------------|---------|------|---------|-----|----|
| Plieger whirlpoolsysteem Spa-1 | | | | | | | |
| kunststof bad acryl Liberty m. whirlpoolsysteem Spa-1 | | | | | | | |
| 0933708 | 180x80cm m. overloopcombinatie | wit/chroom | 0933708 | stuk | 1296,00 | 130 | 1 |
| 0933716 | 180x80cm m. overloopcombinatie | perg./chroom | 0933716 | stuk | 1296,00 | 130 | 1 |
| kunststof hoekbad acryl Liberty m. whirlpoolsysteem Spa-1 | | | | | | | |
| 0933730 | 135x135cm m. overloopcombinatie z. paneel | wit/chroom | 0933730 | stuk | 1369,00 | 130 | 1 |
| 0933731 | 135x135cm m. overloopcombinatie z. paneel | perg./chroom | 0933731 | stuk | 1369,00 | 130 | 1 |
| kunststof bad acryl Spring m. whirlpoolsysteem Spa-1 | | | | | | | |
| 0933740 | 170x75cm m. overloopcombinatie | wit/chroom | 0933740 | stuk | 1183,00 | 130 | 1 |
| 0933759 | 170x75cm m. overloopcombinatie | perg./chroom | 0933759 | stuk | 1183,00 | 130 | 1 |
| 0944505 | 180x80cm m. overloopcombinatie | wit/chroom | 0944505 | stuk | 1296,00 | 130 | 1 |
| 0944513 | 180x80cm m. overloopcombinatie | perg./chroom | 0944513 | stuk | 1296,00 | 130 | 1 |
| Plieger whirlpoolsysteem Hydro-2 | | | | | | | |
| kunststof bad acryl Liberty m. whirlpoolsysteem Hydro-2 | | | | | | | |
| 0933767 | 180x80cm m. overloopcombinatie | wit/chroom | 0933767 | stuk | 1220,00 | 130 | 1 |
| 0933775 | 180x80cm m. overloopcombinatie | perg./chroom | 0933775 | stuk | 1220,00 | 130 | 1 |
| kunststof hoekbad acryl Liberty m. whirlpoolsysteem Hydro-2 | | | | | | | |
| 0933736 | 135x135cm m. overloopcombinatie z. paneel | wit/chroom | 0933736 | stuk | 1293,00 | 130 | 1 |
| 0933733 | 135x135cm m. overloopcombinatie z. paneel | perg./chroom | 0933733 | stuk | 1293,00 | 130 | 1 |
| kunststof bad acryl Spring m. whirlpoolsysteem Hydro-2 | | | | | | | |
| 0933805 | 170x75cm m. overloopcombinatie | wit/chroom | 0933805 | stuk | 1107,00 | 130 | 1 |
| 0933813 | 170x75cm m. overloopcombinatie | perg./chroom | 0933813 | stuk | 1107,00 | 130 | 1 |
| 0944475 | 180x80cm m. overloopcombinatie | wit/chroom | 0944475 | stuk | 1220,00 | 130 | 1 |
| 0944483 | 180x80cm m. overloopcombinatie | perg./chroom | 0944483 | stuk | 1220,00 | 130 | 1 |
| Plieger whirlpoolsysteem Spa/Hydro-3 | | | | | | | |
| kunststof bad acryl Liberty m. whirlpoolsysteem Spa/Hydro-3 | | | | | | | |
| 0933821 | 180x80cm m. overloopcombinatie | wit/chroom | 0933821 | stuk | 1954,00 | 130 | 1 |
| 0933848 | 180x80cm m. overloopcombinatie | perg./chroom | 0933848 | stuk | 1954,00 | 130 | 1 |
| kunststof hoekbad acryl Liberty m. whirlpoolsysteem Spa/Hydro-3 | | | | | | | |
| 0933734 | 135x135cm m. overloopcombinatie z. paneel | wit/chroom | 0933734 | stuk | 2028,00 | 130 | 1 |
| 0933735 | 135x135cm m. overloopcombinatie z. paneel | perg./chroom | 0933735 | stuk | 2028,00 | 130 | 1 |
| kunststof bad acryl Spring m. whirlpoolsysteem Spa/Hydro-3 | | | | | | | |
| 0933872 | 170x75cm m. overloopcombinatie | wit/chroom | 0933872 | stuk | 1841,00 | 130 | 1 |
| 0933880 | 170x75cm m. overloopcombinatie | perg./chroom | 0933880 | stuk | 1841,00 | 130 | 1 |
| 0944548 | 180x80cm m. overloopcombinatie | wit/chroom | 0944548 | stuk | 1954,00 | 130 | 1 |
| 0944556 | 180x80cm m. overloopcombinatie | perg./chroom | 0944556 | stuk | 1954,00 | 130 | 1 |
| Plieger whirlpoolsysteem Toebehoren | | | | | | | |
| 0933738 | inspectie- en ventilatierooster met frame 40x30cm | gean. aluminium | 0933738 | stuk | 77,50 | 130 | 0 |
| 0933739 | inspectie- en ventilatierooster met frame 40x30cm | pergamon | 0933739 | stuk | 95,50 | 130 | 0 |
| 0933741 | inspectie- en ventilatierooster met frame 40x30cm | wit | 0933741 | stuk | 96,50 | 130 | 0 |

Sanitair producten

Baden /
douchebakken /
stoomcabines

Kranen

Douchegarnituur

Accessoires en
spiegels

Douchewanden

Toebehoren &
afvoerenSpoel- &
installatiesystemenBadkamermeubelen
en toiletkastenGootstenen en
wastroggen

Utiliteit

| | Art.nr | Specificaties | Kleur | Lev.nr | Ehd | Prijs | Grp | CC |
|---|---|---|----------|---------|------|--------|-----|----|
| | Plieger Luxury | | | | | | | |
| | kunststof douchebak acryl vierkant | | | | | | | |
| Sanitair producten | 0940836 | 80x80x9cm inbouw m. antislip | wit | 0940836 | stuk | 110,80 | 060 | 0 |
| | 0940502 | 80x80x9cm inbouw m. antislip | pergamon | 0940502 | stuk | 117,90 | 060 | 0 |
| | 0940850 | 80x80x9cm inbouw z. antislip | wit | 0940850 | stuk | 107,86 | 060 | 0 |
| Baden / douchebakken / stoomcabines | 0940852 | 80x80x9cm inbouw z. antislip | pergamon | 0940852 | stuk | 112,61 | 060 | 0 |
| | 0940933 | 90x90x9cm inbouw m. antislip | wit | 0940933 | stuk | 131,26 | 060 | 0 |
| | 0940968 | 90x90x9cm inbouw m. antislip | pergamon | 0940968 | stuk | 153,49 | 060 | 0 |
| | 0940854 | 90x90x9cm inbouw z. antislip | wit | 0940854 | stuk | 122,10 | 060 | 0 |
| | 0940856 | 90x90x9cm inbouw z. antislip | pergamon | 0940856 | stuk | 125,34 | 060 | 0 |
| | 0940986 | 80x80x18.5 opbouw m. antislip | wit | 0940986 | stuk | 133,03 | 060 | 0 |
| Kranen | 0940844 | 80x80x18.5 opbouw z. antislip | wit | 0940844 | stuk | 128,53 | 060 | 0 |
| | 0940846 | 80x80x18.5 opbouw z. antislip | pergamon | 0940846 | stuk | 134,16 | 060 | 0 |
| | 0940990 | 90x90x18.5 opbouw m. antislip | wit | 0940990 | stuk | 155,25 | 060 | 0 |
| Douchegarnituur | 0940996 | 90x90x18.5 opbouw z. antislip | wit | 0940996 | stuk | 155,25 | 060 | 0 |
| | 0940848 | 90x90x18.5 opbouw z. antislip | pergamon | 0940848 | stuk | 159,54 | 060 | 0 |
| | 0360635 | douchebaksteun m. 5 verstelbare poten 125-195mm | | 5SGS | stuk | 33,00 | 062 | 0 |
| | kunststof douchebak acryl vierkant ring vlak rond | | | | | | | |
| Accessoires en spiegels | 0941218 | 90x90x3cm | wit | 0941218 | stuk | 117,90 | 060 | 0 |
| | 0941220 | 90x90x3cm | pergamon | 0941220 | stuk | 131,26 | 060 | 0 |
| | 0360635 | douchebaksteun m. 5 verstelbare poten 125-195mm | | 5SGS | stuk | 33,00 | 062 | 0 |
| | kunststof douchebak acryl vierkant rond vlak | | | | | | | |
| Douchewanden | 0941202 | 90x90x3cm | wit | 0941202 | stuk | 117,90 | 060 | 0 |
| | 0941204 | 90x90x3cm | pergamon | 0941204 | stuk | 131,26 | 060 | 0 |
| | 0360635 | douchebaksteun m. 5 verstelbare poten 125-195mm | | 5SGS | stuk | 33,00 | 062 | 0 |
| | kunststof douchebak acryl vierkant toog | | | | | | | |
| Toebehoren & afvoeren | 0941206 | 90x90x3cm | wit | 0941206 | stuk | 111,39 | 060 | 0 |
| | 0941208 | 90x90x3cm | pergamon | 0941208 | stuk | 115,29 | 060 | 0 |
| | 0360635 | douchebaksteun m. 5 verstelbare poten 125-195mm | | 5SGS | stuk | 33,00 | 062 | 0 |
| | kunststof douchebak acryl kwartrond opbouw radius 55 | | | | | | | |
| Badkamermeubelen en toiletkasten | 0940992 | 90x90x18,5 | wit | 0940992 | stuk | 155,25 | 060 | 0 |
| | 0940840 | 90x90x18,5 | pergamon | 0940840 | stuk | 159,54 | 060 | 0 |
| | kunststof douchebak acryl vijfhoekig opbouw | | | | | | | |
| Gootstenen en wastroggen | 0940994 | 90x90x18,5 | wit | 0940994 | stuk | 155,25 | 060 | 0 |
| | 0940842 | 90x90x18,5 | pergamon | 0940842 | stuk | 159,54 | 060 | 0 |
| | Utiliteit | | | | | | | |

| Art.nr | Specificaties | Kleur | Lev.nr | Ehd | Prijs | Grp | CC |
|--------|---------------|-------|--------|-----|-------|-----|----|
|--------|---------------|-------|--------|-----|-------|-----|----|

Plieger Liberty

kunststof douchebak acryl vierkant

| | | | | | | | |
|---------|---|----------|---------|------|--------|-----|---|
| 0948225 | 90x90x4cm | wit | 0948225 | stuk | 196,00 | 060 | 0 |
| 0948233 | 90x90x4cm | pergamon | 0948233 | stuk | 196,00 | 060 | 0 |
| 0948219 | 100x100x4cm | wit | 0948219 | stuk | 205,00 | 060 | 0 |
| 0948213 | 100x100x4cm | pergamon | 0948213 | stuk | 205,00 | 060 | 0 |
| 0360635 | douchebaksteun m. 5 verstelbare poten 125-195mm | | 5SGS | stuk | 33,00 | 062 | 0 |



Sanitair producten

Baden /
douchebakken /
stoomcabines

kunststof douchebak acryl kwartrond

| | | | | | | | |
|---------|---|----------|---------|------|--------|-----|---|
| 0948101 | 90x90x4cm z. paneel | wit | 0948101 | stuk | 196,00 | 060 | 0 |
| 0948179 | 90x90x4cm z. paneel | pergamon | 0948179 | stuk | 196,00 | 060 | 0 |
| 0948211 | 100x100x4cm z. paneel | wit | 0948211 | stuk | 205,00 | 060 | 0 |
| 0948227 | 100x100x4cm z. paneel | pergamon | 0948227 | stuk | 205,00 | 060 | 0 |
| 0360635 | douchebaksteun m. 5 verstelbare poten 125-195mm | | 5SGS | stuk | 33,00 | 062 | 0 |



Kranen

voorpaneel voor douchebak 90cm

| | | | | | | | |
|---------|----------|----------|---------|------|--------|-----|---|
| 0948187 | m. poten | wit | 0948187 | stuk | 160,00 | 060 | 0 |
| 0948195 | m. poten | pergamon | 0948195 | stuk | 186,00 | 060 | 0 |

Douchegarnituur

kunststof douchebak acryl kwartrond

| | | | | | | | |
|---------|---------------------------------|----------|---------|------|--------|-----|---|
| 0969753 | 90x90cm m. paneel m. poten | wit | 0969753 | stuk | 258,00 | 060 | 0 |
| 0969761 | 90x90cm m. paneel m. poten | pergamon | 0969761 | stuk | 258,00 | 060 | 0 |
| 0948229 | 100x100x19cm m. paneel m. poten | wit | 0948229 | stuk | 268,00 | 060 | 0 |
| 0948223 | 100x100x19cm m. paneel m. poten | pergamon | 0948223 | stuk | 268,00 | 060 | 0 |

Accessoires en
spiegels

kunststof douchebak acryl vijfhoekig

| | | | | | | | |
|---------|--|----------|----------|------|--------|-----|---|
| 0948209 | 90x90cm | wit | 0948209 | stuk | 196,00 | 060 | 0 |
| 0948217 | 90x90cm | pergamon | 0948217 | stuk | 196,00 | 060 | 0 |
| 0948221 | 100x100x4cm | wit | 0948221 | stuk | 205,00 | 060 | 0 |
| 0948215 | 100x100x4cm | pergamon | 0948215 | stuk | 205,00 | 060 | 0 |
| 0341927 | douchebakdrager 100x100cm Plieger Liberty vijfhoekig | | 17037774 | stuk | 153,00 | 082 | 1 |
| 0360635 | douchebaksteun m. 5 verstelbare poten 125-195mm | | 5SGS | stuk | 33,00 | 062 | 0 |



Douchewanden

Toebehoren &
afvoeren

Plieger Spring

kunststof douchebak acryl

| | | | | | | | |
|---------|---|----------|----------|------|--------|-----|---|
| 0947156 | 90x90x8.5 | wit | 0947156 | stuk | 142,00 | 060 | 0 |
| 0947164 | 90x90x8.5 | pergamon | 0947164 | stuk | 142,00 | 060 | 0 |
| 0341878 | douchebakdrager 90x90x6.5cm Plieger Spring | | 17033314 | stuk | 128,00 | 082 | 1 |
| 0360635 | douchebaksteun m. 5 verstelbare poten 125-195mm | | 5SGS | stuk | 33,00 | 062 | 0 |



Spoel- &
installatiesystemen

Badkamermeubelen
en toiletkasten

Gootstenen en
wastroggen

Utiliteit

RIHO

Enjoy the RIHO lifestyle



SYDNEY
145 x 145cm



LUSSO

200x90cm 180x90cm
190x90cm 180x80cm
190x80cm 170x75cm



LIMA

200x90cm 170x75cm
190x90cm 160x70cm
180x80cm 150x70cm



ATLANTA

140 x 140cm

RIHO International B.V.

Hermesstraat 10

5047 TS Tilburg

T: +31 (0)13 5728 728

F: +31 (0)13 5720 262

E: info@riho.nl

I: www.riho.com

| Art.nr | Specificaties | Kleur | Lev.nr | Ehd | Prijs | Grp | CC |
|--------|---------------|-------|--------|-----|-------|-----|----|
|--------|---------------|-------|--------|-----|-------|-----|----|

Riho Alberta

kunststof bad acryl zeshoekig

| | | | | | | | |
|---------|-------------------|----------|------------|------|--------|-----|---|
| 0311170 | 190x80cm z. poten | wit | BA31005 | stuk | 630,00 | 103 | 0 |
| 0311189 | 190x80cm z. poten | pergamon | BA31049 | stuk | 630,00 | 103 | 1 |
| 0317675 | badpoten per set | | POOTSET01U | stuk | 10,00 | 103 | 0 |



Sanitair producten

Riho Atlanta

kunststof hoekbad acryl kwartrond

| | | | | | | | |
|---------|------------------------------|----------|------------|------|--------|-----|---|
| 0310527 | 140x140cm z. poten z. paneel | wit | BA70005 | stuk | 600,00 | 103 | 1 |
| 0310528 | 140x140cm z. poten z. paneel | pergamon | BA70049 | stuk | 600,00 | 103 | 1 |
| 0317675 | badpoten per set | | POOTSET01U | stuk | 10,00 | 103 | 0 |

Baden /
douchebakken /
stoomcabines

Riho Austin

kunststof hoekbad acryl vijfhoekig

| | | | | | | | |
|---------|------------------------------|----------|-----------|------|--------|-----|---|
| 0311357 | 145x145cm z. poten z. paneel | wit | BA11005 | stuk | 675,00 | 103 | 1 |
| 0311358 | 145x145cm z. poten z. paneel | pergamon | BA11049 | stuk | 675,00 | 103 | 1 |
| 0317676 | badpoten per set | | POOTSET07 | stuk | 40,00 | 103 | 0 |



Kranen

Douchegarnituur

Riho Bayline Milano

kunststof hoekbad acryl

| | | | | | | | |
|---------|--------------------|----------|------------|------|--------|-----|---|
| 0311104 | 135x135cm z. poten | wit | BQ25005 | stuk | 465,00 | 103 | 0 |
| 0311105 | 135x135cm z. poten | pergamon | BQ25049 | stuk | 465,00 | 103 | 1 |
| 0317675 | badpoten per set | | POOTSET01U | stuk | 10,00 | 103 | 0 |

Accessoires en
spiegels

Douchewanden

paneel voor hoekbad

| | | | | | | | |
|---------|--|----------|---------|------|--------|-----|---|
| 0311106 | | wit | PQ25005 | stuk | 285,00 | 103 | 0 |
| 0311107 | | pergamon | PQ25049 | stuk | 285,00 | 103 | 1 |

Toebehoren &
afvoeren

Riho Bayline Ortone

kunststof bad acryl rechthoekig

| | | | | | | | |
|---------|-------------------|----------|------------|------|--------|-----|---|
| 0311108 | 180x80cm z. poten | wit | BQ52005 | stuk | 265,00 | 103 | 0 |
| 0311109 | 180x80cm z. poten | pergamon | BQ52049 | stuk | 265,00 | 103 | 1 |
| 0317675 | badpoten per set | | POOTSET01U | stuk | 10,00 | 103 | 0 |

Spoel- &
installatiesystemen

Riho Bayline Porto

kunststof bad acryl rechthoekig

| | | | | | | | |
|---------|-------------------|----------|------------|------|--------|-----|---|
| 0311113 | 180x80cm z. poten | wit | BQ16005 | stuk | 265,00 | 103 | 0 |
| 0311114 | 180x80cm z. poten | pergamon | BQ16049 | stuk | 265,00 | 103 | 0 |
| 0317675 | badpoten per set | | POOTSET01U | stuk | 10,00 | 103 | 0 |

Badkamermeubelen
en toiletkastenGootstenen en
wastroggen

Riho Bayline Vicenza

kunststof bad acryl rechthoekig

| | | | | | | | |
|---------|-------------------|----------|------------|------|--------|-----|---|
| 0311110 | 170x75cm z. poten | wit | BQ07005 | stuk | 265,00 | 103 | 0 |
| 0311112 | 170x75cm z. poten | pergamon | BQ07049 | stuk | 265,00 | 103 | 1 |
| 0317675 | badpoten per set | | POOTSET01U | stuk | 10,00 | 103 | 0 |



Utiliteit

Riho Calgary

kunststof bad acryl rechthoekig

| | | | | | | | |
|---------|-------------------|----------|------------|------|--------|-----|---|
| 0317611 | 190x90cm z. poten | wit | BA14005 | stuk | 680,00 | 103 | 1 |
| 0317612 | 190x90cm z. poten | pergamon | BA14049 | stuk | 680,00 | 103 | 1 |
| 0317675 | badpoten per set | | POOTSET01U | stuk | 10,00 | 103 | 0 |



Riho Carolina

kunststof bad acryl rechthoekig

| | | | | | | | |
|---------|----------------------|----------|---------|------|--------|-----|---|
| 0310418 | 170x80cm z. overloop | wit | BB53005 | stuk | 365,00 | 103 | 1 |
| 0310419 | 170x80cm z. overloop | pergamon | BB53049 | stuk | 365,00 | 103 | 1 |
| 0310420 | 180x80cm z. overloop | wit | BB54005 | stuk | 415,00 | 103 | 1 |
| 0310421 | 180x80cm z. overloop | pergamon | BB54049 | stuk | 415,00 | 103 | 1 |
| 0310422 | 190x80cm z. overloop | wit | BB55005 | stuk | 470,00 | 103 | 1 |
| 0310423 | 190x80cm z. overloop | pergamon | BB55049 | stuk | 470,00 | 103 | 1 |



| | Art.nr | Specificaties | Kleur | Lev.nr | Ehd | Prijs | Grp | CC |
|---|---|------------------------|------------|------------|-------|---------|-----|----|
| Sanitair producten | Riho Colorado | | | | | | | |
| | kunststof bad acryl rond | | | | | | | |
| | 0310525 | 180cm Ø z. poten | wit | BB02005 | stuk | 2185,00 | 103 | 1 |
| | 0310526 | 180cm Ø z. poten | pergamon | BB02049 | stuk | 2185,00 | 103 | 1 |
| Baden / douchebakken / stoomcabines | badpoten pet set | | | | | | | |
| | 0317685 | | | POOTSET03 | stuk | 175,00 | 103 | 1 |
| Kranen | Riho Columbia | | | | | | | |
| | kunststof bad acryl rechthoekig | | | | | | | |
| | 0310515 | 140x70cm z. poten | wit | BA05005 | stuk | 365,00 | 103 | 1 |
| Douchegarnituur | 0310516 | 140x70cm z. poten | pergamon | BA05049 | stuk | 365,00 | 103 | 1 |
| | 0310511 | 150x75cm z. poten | wit | BA02005 | stuk | 390,00 | 103 | 1 |
| | 0310512 | 150x75cm z. poten | pergamon | BA02049 | stuk | 390,00 | 103 | 1 |
| | 0311205 | 160x75cm z. poten | wit | BA01005 | stuk | 430,00 | 103 | 1 |
| | 0310083 | 160x75cm z. poten | pergamon | BA01049 | stuk | 430,00 | 103 | 1 |
| | 0311200 | 175x80cm z. poten | wit | BA04005 | stuk | 470,00 | 103 | 1 |
| | 0311219 | 175x80cm z. poten | pergamon | BA04049 | stuk | 470,00 | 103 | 1 |
| Accessoires en spiegels | 0317675 | badpoten per set | | POOTSET01U | stuk | 10,00 | 103 | 0 |
| Douchewanden | Riho Daytona | | | | | | | |
| | kunststof bad acryl rechthoekig | | | | | | | |
| | 0310424 | 170x80cm m. handgrepen | wit | BB50005 | stuk | 570,00 | 103 | 1 |
| Toebehoren & afvoeren | 0310425 | 170x80cm m. handgrepen | pergamon | BB50049 | stuk | 570,00 | 103 | 1 |
| | 0310426 | 180x80cm m. handgrepen | wit | BB51005 | stuk | 625,00 | 103 | 1 |
| | 0310427 | 180x80cm m. handgrepen | pergamon | BB51049 | stuk | 625,00 | 103 | 1 |
| | 0310428 | 190x80cm m. handgrepen | wit | BB52005 | stuk | 675,00 | 103 | 1 |
| | 0310429 | 190x80cm m. handgrepen | pergamon | BB52049 | stuk | 675,00 | 103 | 1 |
| | 0317675 | badpoten per set | | POOTSET01U | stuk | 10,00 | 103 | 0 |
| | Spoel- & installatiesystemen | Riho Doppio | | | | | | |
| kunststof bad acryl rechthoekig afgeschuind z. poten | | | | | | | | |
| 0311244 | | 180x130cm links | wit | BA91005 | stuk | 780,00 | 103 | 1 |
| Badkamermeubelen en toiletkasten | 0311245 | 180x130cm links | pergamon | BA91049 | stuk | 780,00 | 103 | 1 |
| | 0311246 | 180x130cm rechts | wit | BA90005 | stuk | 780,00 | 103 | 1 |
| | 0311247 | 180x130cm rechts | pergamon | BA90049 | stuk | 780,00 | 103 | 1 |
| | 0317677 | badpoten per set | | POOTSET09 | stuk | 19,00 | 103 | 0 |
| Gootstenen en wastroggen | | | | | | | | |
| Utiliteit | Riho Dorado | | | | | | | |
| | kunststof bad acryl z. paneel z. poten | | | | | | | |
| | 0317607 | 170x75/90 links | wit | BA81005 | stuk | 595,00 | 103 | 1 |
| | 0317608 | 170x75/90 links | pergamon | BA81049 | stuk | 595,00 | 103 | 1 |
| | 0317609 | 170x75/90 rechts | wit | BA80005 | stuk | 595,00 | 103 | 1 |
| | 0317610 | 170x75/90 rechts | pergamon | BA80049 | stuk | 595,00 | 103 | 1 |
| 0317675 | badpoten per set | | POOTSET01U | stuk | 10,00 | 103 | 0 | |
| Utiliteit | Riho Future | | | | | | | |
| | kunststof bad acryl rechthoekig | | | | | | | |
| | 0311140 | 170x75cm z. poten | wit | BC28005 | stuk | 305,00 | 103 | 1 |
| | 0311141 | 170x75cm z. poten | pergamon | BC28049 | stuk | 305,00 | 103 | 1 |
| | 0310050 | 180x80cm z. poten | wit | BC31005 | stuk | 330,00 | 103 | 1 |
| | 0310045 | 180x80cm z. poten | pergamon | BC31049 | stuk | 330,00 | 103 | 1 |
| 0317675 | badpoten per set | | POOTSET01U | stuk | 10,00 | 103 | 0 | |

| Art.nr | Specificaties | Kleur | Lev.nr | Ehd | Prijs | Grp | CC |
|--------|---------------|-------|--------|-----|-------|-----|----|
|--------|---------------|-------|--------|-----|-------|-----|----|

Riho Geta

kunststof bad acryl afgeschuind z. poten z. paneel

| | | | | | | | |
|---------|------------------|----------|-----------|------|--------|-----|---|
| 0311211 | 160x90cm rechts | wit | BA86005R | stuk | 495,00 | 103 | 1 |
| 0311212 | 160x90cm rechts | pergamon | BA86049 | stuk | 495,00 | 103 | 1 |
| 0311213 | 160x90cm links | wit | BA87005 | stuk | 495,00 | 103 | 1 |
| 0311215 | 160x90cm links | pergamon | BA87049 | stuk | 495,00 | 103 | 1 |
| 0311218 | 170x90cm rechts | wit | BA88005 | stuk | 545,00 | 103 | 1 |
| 0311220 | 170x90cm rechts | pergamon | BA88049 | stuk | 545,00 | 103 | 1 |
| 0311221 | 170x90cm links | wit | BA89005 | stuk | 545,00 | 103 | 1 |
| 0311222 | 170x90cm links | pergamon | BA89049 | stuk | 545,00 | 103 | 1 |
| 0317677 | badpoten per set | | POOTSET09 | stuk | 19,00 | 103 | 0 |

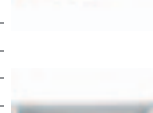

Sanitair producten

Baden /
douchebakken /
stoomcabines

Kranen

Douchegarnituur

Accessoires en
spiegels

Douchewanden

voorpaneel voor bad

| | | | | | | | |
|---------|-------|----------|---------|------|--------|-----|---|
| 0311231 | 160cm | wit | P087005 | stuk | 310,00 | 103 | 1 |
| 0311232 | 160cm | pergamon | P087049 | stuk | 310,00 | 103 | 1 |
| 0311216 | 170cm | wit | P088005 | stuk | 365,00 | 103 | 1 |
| 0311217 | 170cm | pergamon | P088049 | stuk | 365,00 | 103 | 1 |

Toebehoren &
afvoeren

Riho Lima

kunststof bad acryl rechthoekig

| | | | | | | | |
|---------|-------------------|----------|------------|------|--------|-----|---|
| 0310452 | 150x70cm z. poten | wit | BB40005 | stuk | 365,00 | 103 | 1 |
| 0310453 | 150x70cm z. poten | pergamon | BB40049 | stuk | 365,00 | 103 | 1 |
| 0310454 | 160x70cm z. poten | wit | BB42005 | stuk | 415,00 | 103 | 1 |
| 0310455 | 160x70cm z. poten | pergamon | BB42049 | stuk | 415,00 | 103 | 1 |
| 0310385 | 170x75cm z. poten | wit | BB44005 | stuk | 470,00 | 103 | 1 |
| 0310386 | 170x75cm z. poten | pergamon | BB44049 | stuk | 470,00 | 103 | 1 |
| 0310390 | 180x80cm z. poten | wit | BB46005 | stuk | 520,00 | 103 | 1 |
| 0310391 | 180x80cm z. poten | pergamon | BB46049 | stuk | 520,00 | 103 | 1 |
| 0310392 | 190x90cm z. poten | wit | BB48005 | stuk | 570,00 | 103 | 1 |
| 0310393 | 190x90cm z. poten | pergamon | BB48049 | stuk | 570,00 | 103 | 1 |
| 0310534 | 200x90cm z. poten | wit | 0310534 | stuk | 650,00 | 103 | 1 |
| 0310535 | 200x90cm z. poten | pergamon | 0310535 | stuk | 650,00 | 103 | 1 |
| 0317675 | badpoten per set | | POOTSET01U | stuk | 10,00 | 103 | 0 |

Spoel- &
installatiesystemenBadkamermeubelen
en toiletkastenGootstenen en
wastroggen

Utiliteit

Riho Lugano

kunststof bad acryl ovaal

| | | | | | | | |
|---------|-------------------|----------|-----------|------|--------|-----|---|
| 0317603 | 190x90cm z. poten | wit | BA78005 | stuk | 755,00 | 103 | 0 |
| 0317604 | 190x90cm z. poten | pergamon | BA78049 | stuk | 755,00 | 103 | 1 |
| 0310462 | badpoten per set | | POOTSET06 | stuk | 25,00 | 103 | 1 |













Riho Lusso

kunststof bad acryl rechthoekig

| | | | | | | | |
|---------|-------------------|----------|------------|------|--------|-----|---|
| 0310460 | 170x75cm z. poten | wit | BA18005 | stuk | 520,00 | 103 | 1 |
| 0310461 | 170x75cm z. poten | pergamon | BA18049 | stuk | 520,00 | 103 | 1 |
| 0317601 | 180x90cm z. poten | wit | BA77005 | stuk | 625,00 | 103 | 0 |
| 0317602 | 180x90cm z. poten | pergamon | BA77049 | stuk | 625,00 | 103 | 1 |
| 0310536 | 190x90cm z. poten | pergamon | BA99049 | stuk | 650,00 | 103 | 1 |
| 0317675 | badpoten per set | | POOTSET01U | stuk | 10,00 | 103 | 0 |



| | Art.nr | Specificaties | Kleur | Lev.nr | Ehd | Prijs | Grp | CC |
|---|---|-----------------------------|----------|------------|------|--------|-----|----|
| | Riho Lyra | | | | | | | |
| | kunststof hoekbad acryl kwartrond | | | | | | | |
| Sanitair producten | 0310517 | 140x90cm links z. poten | wit | BA66005 | stuk | 365,00 | 103 | 1 |
| | 0310518 | 140x90cm links z. poten | pergamon | BA66049 | stuk | 365,00 | 103 | 1 |
| | 0310519 | 140x90cm rechts z. poten | wit | BA65005 | stuk | 365,00 | 103 | 1 |
| | 0310520 | 140x90cm rechts z. poten | pergamon | BA65049 | stuk | 365,00 | 103 | 1 |
| Baden / douchebakken / stoomcabines | 0312037 | 153.5x100.5 links z. poten | wit | BA68005 | stuk | 430,00 | 103 | 1 |
| | 0312045 | 153.5x100.5 links z. poten | pergamon | BA68049 | stuk | 430,00 | 103 | 1 |
| | 0312002 | 153.5x100.5 rechts z. poten | wit | BA67005 | stuk | 430,00 | 103 | 0 |
| | 0312010 | 153.5x100.5 rechts z. poten | pergamon | BA67049 | stuk | 430,00 | 103 | 1 |
| Kranen | 0317675 | badpoten per set | | POOTSET01U | stuk | 10,00 | 103 | 0 |
| | | | | | | | | |
| Douchegarnituur | | | | | | | | |
| Accessoires en spiegels | | | | | | | | |
| | voorpaneel voor hoekbad acryl links/rechts | | | | | | | |
| | 0312046 | | wit | P070005 | stuk | 310,00 | 103 | 0 |
| | 0310049 | | pergamon | P070049 | stuk | 310,00 | 103 | 1 |
| | Riho Miami | | | | | | | |
| | kunststof bad acryl rechthoekig | | | | | | | |
| Douchewanden | 0310505 | 160x70cm z. poten | wit | BA60005 | stuk | 275,00 | 103 | 1 |
| | 0310506 | 160x70cm z. poten | pergamon | BA60049 | stuk | 275,00 | 103 | 1 |
| | 0310507 | 170x70cm z. poten | wit | BA62005 | stuk | 295,00 | 103 | 1 |
| | 0310508 | 170x70cm z. poten | pergamon | BA62049 | stuk | 295,00 | 103 | 1 |
| Toebehoren & afvoeren | 0317675 | badpoten per set | | POOTSET01U | stuk | 10,00 | 103 | 0 |
| | | | | | | | | |
| | Riho Modena | | | | | | | |
| | kunststof bad acryl rechthoekig | | | | | | | |
| Spoel- & installatiesystemen | 0311209 | 180x80cm z. poten | wit | BA79005 | stuk | 700,00 | 103 | 0 |
| | 0311210 | 180x80cm z. poten | pergamon | BA79049 | stuk | 700,00 | 103 | 1 |
| | 0317675 | badpoten per set | | POOTSET01U | stuk | 10,00 | 103 | 0 |
| Badkamermeubelen en toiletkasten | | | | | | | | |
| | Riho Montreal | | | | | | | |
| | kunststof bad acryl rechthoekig | | | | | | | |
| Gootstenen en wastroggen | 0312061 | 180x90cm z. poten z. paneel | wit | BA13005 | stuk | 650,00 | 103 | 1 |
| | 0312088 | 180x90cm z. poten z. paneel | pergamon | BA13049 | stuk | 650,00 | 103 | 1 |
| | 0317613 | 190x90cm z. poten z. paneel | wit | BA15005 | stuk | 730,00 | 103 | 0 |
| | 0317614 | 190x90cm z. poten z. paneel | pergamon | BA15049 | stuk | 730,00 | 103 | 1 |
| Utiliteit | 0317675 | badpoten per set | | POOTSET01U | stuk | 10,00 | 103 | 0 |
| | | | | | | | | |
| | voorpaneel acryl | | | | | | | |
| | 0312118 | 180x57cm | wit | P180005 | stuk | 200,00 | 103 | 1 |
| | 0312126 | 180x57cm | pergamon | P180049 | stuk | 200,00 | 103 | 1 |
| | zijpaneel acryl | | | | | | | |
| | 0312142 | 90x57cm | wit | P095005 | stuk | 130,00 | 103 | 1 |
| | 0312150 | 90x57cm | pergamon | P095049 | stuk | 130,00 | 103 | 1 |
| | Riho Neo | | | | | | | |
| | kunststof hoekbad acryl kwartrond | | | | | | | |
| | 0310529 | 140x140cm z. poten | wit | BC34005 | stuk | 625,00 | 103 | 1 |
| | 0310530 | 140x140cm z. poten | pergamon | BC34049 | stuk | 625,00 | 103 | 1 |
| | 0310531 | 150x150cm z. poten | wit | BC35005 | stuk | 730,00 | 103 | 1 |
| | 0310533 | 150x150cm z. poten | pergamon | BC35049 | stuk | 730,00 | 103 | 1 |
| | 0317675 | badpoten per set | | POOTSET01U | stuk | 10,00 | 103 | 0 |

| Art.nr | Specificaties | Kleur | Lev.nr | Ehd | Prijs | Grp | CC | | |
|--|------------------------------|----------|------------|------|--------|-----|----|---|---|
| | | | | | | | | Riho Nora | |
| kunststof hoekbad acryl | | | | | | | | | |
| 0310521 | 160x100/60cm links z. poten | wit | BA75005 | stuk | 460,00 | 103 | 1 |  | Sanitair producten |
| 0310522 | 160x100/60cm links z. poten | pergamon | BA75049 | stuk | 460,00 | 103 | 1 | | |
| 0310523 | 160x100/60cm rechts z. poten | wit | BA74005 | stuk | 460,00 | 103 | 1 | | |
| 0310524 | 160x100/60cm rechts z. poten | pergamon | BA74049 | stuk | 460,00 | 103 | 1 | | |
| 0317675 | badpoten per set | | POOTSET01U | stuk | 10,00 | 103 | 0 |  | Baden / douchebakken / stoomcabines |
| Riho Orion | | | | | | | | | |
| kunststof bad acryl rechthoekig | | | | | | | | | |
| 0317615 | 170x70cm z. poten | wit | BC01005 | stuk | 285,00 | 103 | 1 |  | Douchegarnituur |
| 0317616 | 170x70cm z. poten | pergamon | BC01049 | stuk | 285,00 | 103 | 1 | | |
| 0317675 | badpoten per set | | POOTSET01U | stuk | 10,00 | 103 | 0 | | |
| | | | | | | | | Riho Ottawa | |
| kunststof bad acryl rechthoekig | | | | | | | | | |
| 0311308 | 180x80cm z. poten | wit | BA52005 | stuk | 335,00 | 103 | 1 |  | Accessoires en spiegels |
| 0311316 | 180x80cm z. poten | pergamon | BA52049 | stuk | 335,00 | 103 | 1 | | |
| 0317675 | badpoten per set | | POOTSET01U | stuk | 10,00 | 103 | 0 | | |
| | | | | | | | | Riho Pasadena | |
| kunststof bad acryl zeshoekig | | | | | | | | | |
| 0317617 | 210x80cm z. poten | wit | BA42005 | stuk | 680,00 | 103 | 1 |  | Douchewanden |
| 0317618 | 210x80cm z. poten | pergamon | BA42049 | stuk | 680,00 | 103 | 1 | | |
| 0317675 | badpoten per set | | POOTSET01U | stuk | 10,00 | 103 | 0 | | |
| | | | | | | | | Riho Pegas | |
| kunststof bad acryl rechthoekig | | | | | | | | | |
| 0312284 | 180x80cm z. poten | wit | BC16005 | stuk | 380,00 | 103 | 1 |  | Toebehoren & afvoeren |
| 0310463 | 180x80cm z. poten | pergamon | BC16049 | stuk | 380,00 | 103 | 1 | | |
| 0317675 | badpoten per set | | POOTSET01U | stuk | 10,00 | 103 | 0 | | |
| | | | | | | | | Riho Perth | |
| kunststof bad acryl achthoekig | | | | | | | | | |
| 0310509 | 175x80cm z. poten | wit | BA43005 | stuk | 600,00 | 103 | 1 |  | Spoel- & installatiesystemen |
| 0310510 | 175x80cm z. poten | pergamon | BA43049 | stuk | 600,00 | 103 | 1 | | |
| 0317675 | badpoten per set | | POOTSET01U | stuk | 10,00 | 103 | 0 | | |
| | | | | | | | | Riho Seth | |
| kunststof bad acryl ovaal | | | | | | | | | |
| 0317629 | 180x86cm z. poten | wit | BB22005 | stuk | 600,00 | 103 | 0 |  | Badkamermeubelen en toiletkasten |
| 0317630 | 180x86cm z. poten | pergamon | BB22049 | stuk | 600,00 | 103 | 1 | | |
| 0317675 | badpoten per set | | POOTSET01U | stuk | 10,00 | 103 | 0 | | |
| | | | | | | | | Riho Sobek | |
| kunststof bad acryl rechthoekig | | | | | | | | | |
| 0317631 | 180x115cm z. poten | wit | BB28005 | stuk | 905,00 | 103 | 1 |  | Gootstenen en wastroggen |
| 0317632 | 180x115cm z. poten | pergamon | BB28049 | stuk | 905,00 | 103 | 1 | | |
| 0317675 | badpoten per set | | POOTSET01U | stuk | 10,00 | 103 | 0 | | |
| hoofdkussen | | | | | | | | | |
| 0310098 | | zwart | AH07110 | stuk | 51,00 | 103 | 1 | | Utiliteit |
| | | | | | | | | Riho Taurus | |
| kunststof bad acryl rechthoekig | | | | | | | | | |
| 0317635 | 170x80cm z. poten | wit | BC07005 | stuk | 340,00 | 103 | 1 |  | |
| 0317636 | 170x80cm z. poten | pergamon | BC07049 | stuk | 340,00 | 103 | 1 | | |
| 0317675 | badpoten per set | | POOTSET01U | stuk | 10,00 | 103 | 0 | | |
| | | | | | | | | Riho Tofield | |
| kunststof bad acryl rechthoekig | | | | | | | | | |
| 0311361 | 180x80cm z. poten | wit | BA37005 | stuk | 430,00 | 103 | 1 |  | |
| 0311363 | 180x80cm z. poten | pergamon | BA37049 | stuk | 430,00 | 103 | 1 | | |
| 0317675 | badpoten per set | | POOTSET01U | stuk | 10,00 | 103 | 0 | | |

| | Art.nr | Specificaties | Kleur | Lev.nr | Ehd | Prijs | Grp | CC |
|---|--|--------------------------------------|----------|------------|------|--------|-----|----|
| Sanitair producten | Riho Virgo | | | | | | | |
| | kunststof bad acryl rechthoekig | | | | | | | |
| | 0317637 | 170x75cm z. poten | wit | BZ07005 | stuk | 340,00 | 103 | 1 |
| | 0317638 | 170x75cm z. poten | pergamon | BZ07049 | stuk | 340,00 | 103 | 1 |
| | 0317675 | badpoten per set | | POOTSET01U | stuk | 10,00 | 103 | 0 |
| Baden / douchebakken / stoomcabines | Riho Winnipeg | | | | | | | |
| | kunststof hoekbad acryl zeshoekig | | | | | | | |
| | 0312266 | 145x145cm z. poten | wit | BA48005 | stuk | 565,00 | 103 | 0 |
| | 0317675 | badpoten per set | | POOTSET01U | stuk | 10,00 | 103 | 0 |
| Kranen | | | | | | | | |
| Douchegarnituur | voorpaneel voor bad | | | | | | | |
| | 0317680 | | wit | P027005 | stuk | 485,00 | 103 | 1 |
| Accessoires en spiegels | Riho Yukon | | | | | | | |
| | kunststof bad acryl rechthoekig | | | | | | | |
| | 0311472 | 160x90cm rechts afgeschuind z. poten | wit | BA34005 | stuk | 460,00 | 103 | 0 |
| | 0311480 | 160x90cm rechts afgeschuind z. poten | pergamon | BA34049 | stuk | 460,00 | 103 | 1 |
| | 0311502 | 160x90cm links afgeschuind z. poten | wit | BA35005 | stuk | 460,00 | 103 | 0 |
| Douchewanden | 0311510 | 160x90cm links afgeschuind z. poten | pergamon | BA35049 | stuk | 460,00 | 103 | 1 |
| | 0317677 | badpoten per set | | POOTSET09 | stuk | 19,00 | 103 | 0 |
| | paneel voor bad links/rechts | | | | | | | |
| Toebehoren & afvoeren | 0317681 | | wit | P085005 | stuk | 290,00 | 103 | 1 |
| | 0310073 | | pergamon | P085049 | stuk | 290,00 | 103 | 1 |
| Spoel- & installatiesystemen | | | | | | | | |
| Badkamermeubelen en toiletkasten | | | | | | | | |
| Gootstenen en wastroggen | | | | | | | | |
| Utiliteit | | | | | | | | |

| Art.nr | Specificaties | Kleur | Lev.nr | Ehd | Prijs | Grp | CC |
|--------|---------------|-------|--------|-----|-------|-----|----|
|--------|---------------|-------|--------|-----|-------|-----|----|

Riho Bayline Milano

kunststof hoekbad acryl m. whirlpoolsysteem-1

| | | | | | | | |
|---------|-----------|-----------------------|----------|------------------|------|---------|-------|
| 0311115 | 135x135cm | motor links m. poten | wit | BQ2500515PC00001 | stuk | 1205,00 | 135 1 |
| 0311116 | 135x135cm | motor links m. poten | pergamon | BQ2504915PC00001 | stuk | 1205,00 | 135 1 |
| 0311117 | 135x135cm | motor rechts m. poten | wit | BQ2500515PC00000 | stuk | 1205,00 | 135 1 |
| 0311118 | 135x135cm | motor rechts m. poten | pergamon | BQ2504915PC00000 | stuk | 1205,00 | 135 1 |



Sanitair producten

Baden /
douchebakken /
stoomcabines

kunststof hoekbad acryl m. whirlpoolsysteem-2

| | | | | | | | |
|---------|-----------|-----------------------|----------|-----------------|------|---------|-------|
| 0311135 | 135x135cm | motor links m. poten | wit | BQ25005557C0029 | stuk | 2425,00 | 135 1 |
| 0311136 | 135x135cm | motor links m. poten | pergamon | BQ25049557C0029 | stuk | 2425,00 | 135 1 |
| 0311137 | 135x135cm | motor rechts m. poten | wit | BQ25005557C0019 | stuk | 2425,00 | 135 1 |
| 0311139 | 135x135cm | motor rechts m. poten | pergamon | BQ25049557C0019 | stuk | 2425,00 | 135 1 |

Kranen

Riho Bayline Ortone

kunststof bad acryl m. whirlpoolsysteem-1

| | | | | | | | |
|---------|----------|-----------------------|----------|------------------|------|---------|-------|
| 0311119 | 180x80cm | motor links m. poten | wit | BQ5200515PC00001 | stuk | 1045,00 | 135 1 |
| 0311120 | 180x80cm | motor links m. poten | pergamon | BQ5204915PC00001 | stuk | 1045,00 | 135 1 |
| 0311121 | 180x80cm | motor rechts m. poten | wit | BQ5200515PC00000 | stuk | 1045,00 | 135 1 |
| 0311122 | 180x80cm | motor rechts m. poten | pergamon | BQ5204915PC00000 | stuk | 1045,00 | 135 1 |



Doucheapparatuur

Accessoires en
spiegels

Riho Bayline Porto

kunststof bad acryl m. whirlpoolsysteem-1

| | | | | | | | |
|---------|----------|-----------------------|----------|------------------|------|---------|-------|
| 0311127 | 180x80cm | motor links m. poten | wit | BQ1600515PC00001 | stuk | 1045,00 | 135 1 |
| 0311128 | 180x80cm | motor links m. poten | pergamon | BQ1604915PC00001 | stuk | 1045,00 | 135 1 |
| 0311129 | 180x80cm | motor rechts m. poten | wit | BQ1600515PC00000 | stuk | 1045,00 | 135 1 |
| 0311130 | 180x80cm | motor rechts m. poten | pergamon | BQ1604915PC00000 | stuk | 1045,00 | 135 1 |



Douchewanden

kunststof bad acryl m. whirlpoolsysteem-2

| | | | | | | | |
|---------|----------|-----------------------|----------|-----------------|------|---------|-------|
| 0311131 | 180x80cm | motor links m. poten | wit | BQ16005557C0029 | stuk | 2250,00 | 135 1 |
| 0311132 | 180x80cm | motor links m. poten | pergamon | BQ16049557C0029 | stuk | 2250,00 | 135 1 |
| 0311133 | 180x80cm | motor rechts m. poten | wit | BQ16005557C0019 | stuk | 2250,00 | 135 1 |
| 0311134 | 180x80cm | motor rechts m. poten | pergamon | BQ16049557C0019 | stuk | 2250,00 | 135 1 |

Toebehoren &
afvoerenSpoel- &
installatiesystemen

Riho Bayline Vicenza

kunststof bad acryl m. whirlpoolsysteem-1

| | | | | | | | |
|---------|----------|-----------------------|----------|------------------|------|---------|-------|
| 0311123 | 170x75cm | motor links m. poten | wit | BQ0700515PC00001 | stuk | 1045,00 | 135 1 |
| 0311124 | 170x75cm | motor links m. poten | pergamon | BQ0704915PC00001 | stuk | 1045,00 | 135 1 |
| 0311125 | 170x75cm | motor rechts m. poten | wit | BQ0700515PC00000 | stuk | 1045,00 | 135 1 |
| 0311126 | 170x75cm | motor rechts m. poten | pergamon | BQ0704915PC00000 | stuk | 1045,00 | 135 1 |

Badkamermeubelen
en toiletkasten

Riho Easypool Carolina

kunststof bad acryl m. easypool systeem

| | | | | | | | |
|---------|----------|--|----------|----------------|------|--------|-------|
| 0311248 | 180x80cm | | wit | BB5400516PR000 | stuk | 775,00 | 135 0 |
| 0311249 | 180x80cm | | pergamon | BB5404916PR000 | stuk | 775,00 | 135 1 |

Gootstenen en
wastroggen

Utiliteit

Riho Easypool Tofield

kunststof bad m. easypool systeem

| | | | | | | | |
|---------|----------|--|----------|-----------------|------|--------|-------|
| 0311195 | 180x80cm | | wit | BA3700516PR0000 | stuk | 756,00 | 135 0 |
| 0311196 | 180x80cm | | pergamon | BA3704916PR0000 | stuk | 756,00 | 135 1 |



Riho Toebehoren

| | | | | | | | |
|---------|---------------------------|--|--|----------|------|-------|-------|
| 0310137 | whirlpool reiniger 1liter | | | REDIS002 | stuk | 20,00 | 135 1 |
|---------|---------------------------|--|--|----------|------|-------|-------|

| Art.nr | Specificaties | Kleur | Lev.nr | Ehd | Prijs | Grp | CC |
|--------|---------------|-------|--------|-----|-------|-----|----|
|--------|---------------|-------|--------|-----|-------|-----|----|

Sanitair producten



| Riho 201 | | | | | | | |
|------------------------------------|---------------------|----------|---------|------|--------|-----|---|
| kunststof douchebak acryl vierkant | | | | | | | |
| 0310477 | 80x80x16cm z. poten | wit | DA01005 | stuk | 210,00 | 103 | 1 |
| 0310478 | 80x80x16cm z. poten | pergamon | DA01049 | stuk | 210,00 | 103 | 1 |

Baden /
douchebakken /
stoomcabines



| Riho 202 | | | | | | | |
|------------------------------------|---------------------|----------|---------|------|--------|-----|---|
| kunststof douchebak acryl vierkant | | | | | | | |
| 0312361 | 90x90x16cm z. poten | wit | DA04005 | stuk | 210,00 | 103 | 1 |
| 0310044 | 90x90x16cm z. poten | pergamon | DA04049 | stuk | 210,00 | 103 | 1 |

Kranen

Douchegarnituur



| Riho 207 | | | | | | | |
|-------------------------------------|---|----------|---------|------|--------|-----|---|
| kunststof douchebak acryl kwartrond | | | | | | | |
| 0310479 | 90x90x10cm z. poten z. paneel radius 55cm | wit | DA21005 | stuk | 210,00 | 103 | 1 |
| 0310480 | 90x90x10cm z. poten z. paneel radius 55cm | pergamon | DA21049 | stuk | 210,00 | 103 | 1 |

Accessoires en
spiegels

Douchewanden



| Riho 209 | | | | | | | |
|-------------------------------------|--|----------|---------|------|--------|-----|---|
| kunststof douchebak acryl kwartrond | | | | | | | |
| 0310481 | 90x90x6.5cm m. poten m. paneel radius 55cm | wit | DA18005 | stuk | 260,00 | 103 | 1 |
| 0310482 | 90x90x6.5cm m. poten m. paneel radius 55cm | pergamon | DA18049 | stuk | 260,00 | 103 | 1 |

Toebehoren &
afvoeren

Spoel- &
installatiesystemen



| Riho 210 | | | | | | | |
|-------------------------------------|-------------------------------|----------|---------|------|--------|-----|---|
| kunststof douchebak acryl kwartrond | | | | | | | |
| 0311391 | 90x90x10cm m. poten m. paneel | wit | DA19005 | stuk | 260,00 | 103 | 0 |
| 0311405 | 90x90x10cm m. poten m. paneel | pergamon | DA19049 | stuk | 260,00 | 103 | 1 |

Badkamermeubelen
en toiletkasten



| Riho 211 | | | | | | | |
|-------------------------------------|---|----------|---------|------|--------|-----|---|
| kunststof douchebak acryl kwartrond | | | | | | | |
| 0317639 | 90x90x6,5cm z. poten z. paneel | wit | DA20005 | stuk | 210,00 | 103 | 1 |
| 0317640 | 90x90x6,5cm z. poten z. paneel | pergamon | DA20049 | stuk | 210,00 | 103 | 1 |
| 0360635 | douchebaksteun m. 5 verstelbare poten 125-195mm | | 5SGS | stuk | 33,00 | 062 | 0 |

Gootstenen en
wastroggen

Utiliteit



| Riho 212 | | | | | | | |
|------------------------------------|---|----------|---------|------|--------|-----|---|
| kunststof douchebak acryl vierkant | | | | | | | |
| 0312290 | 90x90x4.5cm z. poten | wit | DA22005 | stuk | 210,00 | 103 | 0 |
| 0312304 | 90x90x4.5cm z. poten | pergamon | DA22049 | stuk | 210,00 | 103 | 1 |
| 0360635 | douchebaksteun m. 5 verstelbare poten 125-195mm | | 5SGS | stuk | 33,00 | 062 | 0 |



| Riho 213 | | | | | | | |
|--------------------------------------|---|----------|---------|------|--------|-----|---|
| kunststof douchebak acryl vijfhoekig | | | | | | | |
| 0317641 | 90x90x6,5cm z.poten z.paneel | wit | DA23005 | stuk | 210,00 | 103 | 0 |
| 0317642 | 90x90x6,5cm z.poten z.paneel | pergamon | DA23049 | stuk | 210,00 | 103 | 1 |
| 0360635 | douchebaksteun m. 5 verstelbare poten 125-195mm | | 5SGS | stuk | 33,00 | 062 | 0 |



| Riho 214 | | | | | | | |
|------------------------------------|---|----------|---------|------|--------|-----|---|
| kunststof douchebak acryl vierkant | | | | | | | |
| 0312320 | 100x100x4.5 z. poten | wit | DA25005 | stuk | 210,00 | 103 | 1 |
| 0312339 | 100x100x4.5 z. poten | pergamon | DA25049 | stuk | 210,00 | 103 | 1 |
| 0360635 | douchebaksteun m. 5 verstelbare poten 125-195mm | | 5SGS | stuk | 33,00 | 062 | 0 |

| Art.nr | Specificaties | Kleur | Lev.nr | Ehd | Prijs | Grp | CC |
|--------|---------------|-------|--------|-----|-------|-----|----|
|--------|---------------|-------|--------|-----|-------|-----|----|

Riho 215

kunststof douchebak acryl vijfhoekig

| | | | | | | | |
|---------|---|----------|---------|------|--------|-----|---|
| 0317643 | 100x100x6,5 z.poten z.paneel | wit | DA26005 | stuk | 210,00 | 103 | 0 |
| 0317644 | 100x100x6,5 z.poten z.paneel | pergamon | DA26049 | stuk | 210,00 | 103 | 1 |
| 0360635 | douchebaksteen m. 5 verstelbare poten 125-195mm | | 5SGS | stuk | 33,00 | 062 | 0 |



Sanitair producten

Riho 224

kunststof douchebak acryl rechthoekig

| | | | | | | | |
|---------|---|----------|---------|------|--------|-----|---|
| 0317649 | 90x80x14cm z.poten | wit | DA40005 | stuk | 210,00 | 103 | 1 |
| 0317650 | 90x80x14cm z.poten | pergamon | DA40049 | stuk | 210,00 | 103 | 1 |
| 0360635 | douchebaksteen m. 5 verstelbare poten 125-195mm | | 5SGS | stuk | 33,00 | 062 | 0 |

Baden /
douchebakken /
stoomcabines

Kranen

Riho 226

kunststof douchebak acryl rechthoekig

| | | | | | | | |
|---------|---|----------|---------|------|--------|-----|---|
| 0317651 | 100x80x14 z.poten | wit | DA43005 | stuk | 210,00 | 103 | 1 |
| 0317652 | 100x80x14 z.poten | pergamon | DA43049 | stuk | 210,00 | 103 | 1 |
| 0360635 | douchebaksteen m. 5 verstelbare poten 125-195mm | | 5SGS | stuk | 33,00 | 062 | 0 |

Douchegarnituur

Accessoires en
spiegels

Riho 228

kunststof douchebak acryl rechthoekig

| | | | | | | | |
|---------|---|-----|---------|------|--------|-----|---|
| 0317653 | 100x90x14 z.poten | wit | DA46005 | stuk | 210,00 | 103 | 1 |
| 0360635 | douchebaksteen m. 5 verstelbare poten 125-195mm | | 5SGS | stuk | 33,00 | 062 | 0 |

Douchewanden

Riho 248

kunststof douchebak acryl vierkant

| | | | | | | | |
|---------|---------------------|----------|---------|------|--------|-----|---|
| 0310483 | 80x80x4.5cm z.poten | wit | DA56005 | stuk | 190,00 | 103 | 1 |
| 0310484 | 80x80x4.5cm z.poten | pergamon | DA56049 | stuk | 190,00 | 103 | 1 |

Toebehoren &
afvoeren

Riho 250

kunststof douchebak acryl

| | | | | | | | |
|---------|----------------------------|----------|---------|------|--------|-----|---|
| 0311223 | 90x90x4cm vierkant z.poten | wit | DA58005 | stuk | 210,00 | 103 | 0 |
| 0311224 | 90x90x4cm vierkant z.poten | pergamon | DA58049 | stuk | 210,00 | 103 | 1 |

Spoel- &
installatiesystemen

Riho 252

kunststof douchebak acryl

| | | | | | | | |
|---------|--------------------------------|----------|---------|------|--------|-----|---|
| 0311225 | 100x90x4cm rechthoekig z.poten | wit | DA60005 | stuk | 235,00 | 103 | 0 |
| 0311226 | 100x90x4cm rechthoekig z.poten | pergamon | DA60049 | stuk | 235,00 | 103 | 1 |

Badkamermeubelen
en toiletkastenGootstenen en
wastroggen

Riho 254

kunststof douchebak acryl

| | | | | | | | |
|---------|--------------------------------|----------|---------|------|--------|-----|---|
| 0311228 | 120x90x4cm rechthoekig z.poten | wit | DA62005 | stuk | 260,00 | 103 | 0 |
| 0311229 | 120x90x4cm rechthoekig z.poten | pergamon | DA62049 | stuk | 260,00 | 103 | 1 |

Utiliteit

Riho 256

kunststof douchebak acryl

| | | | | | | | |
|---------|--------------------------------|----------|---------|------|--------|-----|---|
| 0311233 | 140x90x4cm rechthoekig z.poten | wit | DA64005 | stuk | 285,00 | 103 | 1 |
| 0311234 | 140x90x4cm rechthoekig z.poten | pergamon | DA64049 | stuk | 285,00 | 103 | 1 |

Riho 258

kunststof douchebak acryl rechthoekig

| | | | | | | | |
|---------|----------------------|----------|---------|------|--------|-----|---|
| 0310487 | 160x90x4.5cm z.poten | wit | DA66005 | stuk | 310,00 | 103 | 1 |
| 0310488 | 160x90x4.5cm z.poten | pergamon | DA66049 | stuk | 310,00 | 103 | 1 |

Riho 260

kunststof douchebak acryl vierkant

| | | | | | | | |
|---------|-----------------------|----------|---------|------|--------|-----|---|
| 0310485 | 100x100x4.5cm z.poten | wit | DA68005 | stuk | 260,00 | 103 | 1 |
| 0310486 | 100x100x4.5cm z.poten | pergamon | DA68049 | stuk | 260,00 | 103 | 1 |



| Art.nr | Specificaties | Kleur | Lev.nr | Ehd | Prijs | Grp | CC |
|--------|---------------|-------|--------|-----|-------|-----|----|
|--------|---------------|-------|--------|-----|-------|-----|----|



Riho 278

kunststof douchebak acryl kwartrond

| | | | | | | | |
|---------|--|----------|---------|------|--------|-----|---|
| 0310489 | 80x80x4.5cm z. poten z. paneel radius 55cm | wit | DA86005 | stuk | 190,00 | 103 | 1 |
| 0310490 | 80x80x4.5cm z. poten z. paneel radius 55cm | pergamon | DA86049 | stuk | 190,00 | 103 | 1 |

Riho 279

kunststof douchebak acryl kwartrond

| | | | | | | | |
|---------|--|----------|---------|------|--------|-----|---|
| 0310491 | 80x80x4.5cm m. poten m. paneel radius 55cm | wit | DA87005 | stuk | 240,00 | 103 | 1 |
| 0310492 | 80x80x4.5cm m. poten m. paneel radius 55cm | pergamon | DA87049 | stuk | 240,00 | 103 | 1 |

Riho 280

kunststof douchebak acryl kwartrond

| | | | | | | | |
|---------|--|----------|---------|------|--------|-----|---|
| 0310493 | 90x90x4.5cm z. poten z. paneel radius 55cm | wit | DA88005 | stuk | 210,00 | 103 | 1 |
| 0310494 | 90x90x4.5cm z. poten z. paneel radius 55cm | pergamon | DA88049 | stuk | 210,00 | 103 | 1 |

Riho 281

kunststof douchebak acryl kwartrond

| | | | | | | | |
|---------|--|----------|---------|------|--------|-----|---|
| 0310495 | 90x90x4.5cm m. poten m. paneel radius 55cm | wit | DA89005 | stuk | 260,00 | 103 | 1 |
| 0310496 | 90x90x4.5cm m. poten m. paneel radius 55cm | pergamon | DA89049 | stuk | 260,00 | 103 | 1 |

Riho 284

kunststof douchebak acryl kwartrond

| | | | | | | | |
|---------|--|----------|---------|------|--------|-----|---|
| 0310497 | 100x100x4.5cm z. poten z. paneel radius 55cm | wit | DA92005 | stuk | 235,00 | 103 | 1 |
| 0310498 | 100x100x4.5cm z. poten z. paneel radius 55cm | pergamon | DA92049 | stuk | 235,00 | 103 | 1 |

Riho 285

kunststof douchebak acryl kwartrond

| | | | | | | | |
|---------|--|----------|---------|------|--------|-----|---|
| 0310499 | 100x100x4.5cm m. poten m. paneel radius 55cm | wit | DA93005 | stuk | 285,00 | 103 | 1 |
| 0310500 | 100x100x4.5cm m. poten m. paneel radius 55cm | pergamon | DA93049 | stuk | 285,00 | 103 | 1 |

Riho 288

kunststof douchebak acryl kwartrond

| | | | | | | | |
|---------|--|----------|---------|------|--------|-----|---|
| 0310501 | 120x120x4.5cm z. poten z. paneel radius 55cm | wit | DA96005 | stuk | 310,00 | 103 | 1 |
| 0310502 | 120x120x4.5cm z. poten z. paneel radius 55cm | pergamon | DA96049 | stuk | 310,00 | 103 | 1 |

Riho 289

kunststof douchebak acryl kwartrond

| | | | | | | | |
|---------|--|----------|---------|------|--------|-----|---|
| 0310503 | 120x120x4.5cm m. poten m. paneel radius 55cm | wit | DA97005 | stuk | 365,00 | 103 | 1 |
| 0310504 | 120x120x4.5cm m. poten m. paneel radius 55cm | pergamon | DA97049 | stuk | 365,00 | 103 | 1 |

Riho Apollo

kunststof douchebak acryl vierkant

| | | | | | | | |
|---------|---|----------|---------|------|--------|-----|---|
| 0317669 | 80x80x14cm z. poten | wit | DC01005 | stuk | 210,00 | 103 | 1 |
| 0317670 | 80x80x14cm z. poten | pergamon | DC01049 | stuk | 210,00 | 103 | 1 |
| 0360635 | douchebaksteun m. 5 verstelbare poten 125-195mm | | 5SGS | stuk | 33,00 | 062 | 0 |



Riho Saturnus

kunststof douchebak acryl vierkant

| | | | | | | | |
|---------|---|----------|---------|------|--------|-----|---|
| 0317667 | 90x90x14cm z. poten | wit | DC04005 | stuk | 210,00 | 103 | 0 |
| 0317668 | 90x90x14cm z. poten | pergamon | DC04049 | stuk | 210,00 | 103 | 1 |
| 0360635 | douchebaksteun m. 5 verstelbare poten 125-195mm | | 5SGS | stuk | 33,00 | 062 | 0 |



| Art.nr | Specificaties | Kleur | Lev.nr | Ehd | Prijs | Grp | CC |
|--------|---------------|-------|--------|-----|-------|-----|----|
|--------|---------------|-------|--------|-----|-------|-----|----|

Sphinx 300

kunststof bad acryl rechthoekig

| | | | | | | | |
|---------|-----------------------------------|----------|-------------|------|--------|-----|---|
| 0082301 | 160x80x45cm z. poten | wit | S8H0U000000 | stuk | 387,00 | 099 | 1 |
| 0082302 | 160x80x45cm z. poten | pergamon | S8H0U000030 | stuk | 387,00 | 099 | 1 |
| 0082303 | 170x75x45cm z. poten | wit | S8H0V000000 | stuk | 397,00 | 099 | 1 |
| 0082304 | 170x75x45cm z. poten | pergamon | S8H0V000030 | stuk | 397,00 | 099 | 1 |
| 0082305 | 180x80x45cm z. poten | wit | S8H0W000000 | stuk | 431,00 | 099 | 1 |
| 0082306 | 180x80x45cm z. poten | pergamon | S8H0W000030 | stuk | 431,00 | 099 | 1 |
| 0082307 | 190x80x45cm z. poten | wit | S8H0Y000000 | stuk | 535,00 | 099 | 1 |
| 0082308 | 190x80x45cm z. poten | pergamon | S8H0Y000030 | stuk | 535,00 | 099 | 1 |
| 0330250 | badpotenset los voor Sphinx baden | | S8H991000 | stuk | 29,00 | 099 | 0 |
| 0330531 | badgreep per stuk chroom | | S8H790C00 | stuk | 73,00 | 099 | 1 |



Sanitair producten

Baden /
douchebakken /
stoomcabines

Kranen

Sphinx 380

kunststof bad acryl rechthoekig inbouw

| | | | | | | | |
|---------|-------------------|----------|-------------|------|--------|-----|---|
| 0282567 | 180x80cm z. poten | wit | S8H0G000000 | stuk | 607,00 | 099 | 1 |
| 0282546 | 180x80cm z. poten | pergamon | S8H0G000030 | stuk | 607,00 | 099 | 1 |



Douchegarnituur

Accessoires en
spiegels

kunststof bad acryl rechthoekig back-to-wall

| | | | | | | | |
|---------|-------------------|----------|-------------|------|--------|-----|---|
| 0282547 | 180x80cm z. poten | wit | S8H0I000000 | stuk | 546,00 | 099 | 1 |
| 0282548 | 180x80cm z. poten | pergamon | S8H0I000030 | stuk | 546,00 | 099 | 1 |



Douchewanden

Toebehoren &
afvoeren

voorpaneel voor bad

| | | | | | | | |
|---------|----------|----------|-------------|------|--------|-----|---|
| 0282549 | per stuk | wit | S8H0IPV0000 | stuk | 198,00 | 099 | 1 |
| 0282550 | per stuk | pergamon | S8H0IPV0030 | stuk | 198,00 | 099 | 1 |

zijpaneel voor bad

| | | | | | | | |
|---------|-------------|----------|-------------|------|--------|-----|---|
| 0282551 | per 2 stuks | wit | S8H0IPZ0000 | stuk | 232,00 | 099 | 1 |
| 0282552 | per 2 stuks | pergamon | S8H0IPZ0030 | stuk | 232,00 | 099 | 1 |

Sphinx 450

kunststof bad acryl rechthoekig

| | | | | | | | |
|---------|-----------------------------------|-----|-------------|------|--------|-----|---|
| 0332658 | 180x80cm z. poten m. hoofdkussen | wit | S8H0C000000 | stuk | 894,00 | 042 | 0 |
| 0330250 | badpotenset los voor Sphinx baden | | S8H991000 | stuk | 29,00 | 099 | 0 |

Badkamermeubelen
en toiletkastenGootstenen en
wastroggen

Sphinx Antibes

kunststof bad acryl rechthoekig

| | | | | | | | |
|---------|-----------------------------------|----------|-------------|------|--------|-----|---|
| 0331414 | 180x80cm z. poten | wit | S8H0H000000 | stuk | 674,00 | 099 | 1 |
| 0331422 | 180x80cm z. poten | pergamon | S8H0H000030 | stuk | 674,00 | 099 | 1 |
| 0330250 | badpotenset los voor Sphinx baden | | S8H991000 | stuk | 29,00 | 099 | 0 |



Utiliteit

Sphinx Atlantic

kunststof bad acryl rechthoekig

| | | | | | | | |
|---------|-----------------------------------|-----|-------------|------|---------|-----|---|
| 0332623 | 180x80cm z. poten | wit | S8H0D000000 | stuk | 1304,00 | 042 | 1 |
| 0330250 | badpotenset los voor Sphinx baden | | S8H991000 | stuk | 29,00 | 099 | 0 |



kunststof bad acryl ovaal

| | | | | | | | |
|---------|-----------------------------------|-----|-------------|------|---------|-----|---|
| 0331465 | 191x101cm z. poten | wit | S8H0K000000 | stuk | 1564,00 | 099 | 1 |
| 0330250 | badpotenset los voor Sphinx baden | | S8H991000 | stuk | 29,00 | 099 | 0 |



| | Art.nr | Specificaties | Kleur | Lev.nr | Ehd | Prijs | Grp | CC |
|---|--|-----------------------------------|-------------|-------------|--------|---------|-----|----|
| Sanitair producten | Sphinx ClarissaPlus | | | | | | | |
| | kunststof bad acryl rechthoekig | | | | | | | |
| | 0332674 | 180x80cm z. poten | wit | S8H0E000000 | stuk | 938,00 | 099 | 0 |
| | 0332682 | 180x80cm z. poten | pergamon | S8H0E000030 | stuk | 938,00 | 099 | 1 |
| | 0332683 | 190x90cm z. poten | wit | S8H0Z000000 | stuk | 1081,00 | 099 | 1 |
| Baden / douchebakken / stoomcabines | 0332684 | 190x90cm z. poten | pergamon | S8H0Z000030 | stuk | 1081,00 | 099 | 1 |
| | 0330250 | badpotenset los voor Sphinx baden | | S8H991000 | stuk | 29,00 | 099 | 0 |
| | Sphinx Continental | | | | | | | |
| Kranen | kunststof bad acryl rechthoekig | | | | | | | |
| | 0331120 | 170x75cm z. poten | wit | S8H07000000 | stuk | 401,00 | 099 | 1 |
| | 0331139 | 170x75cm z. poten | pergamon | S8H07000030 | stuk | 401,00 | 099 | 1 |
| | 0330250 | badpotenset los voor Sphinx baden | | S8H991000 | stuk | 29,00 | 099 | 0 |
| Douchegarnituur | Sphinx 360 | | | | | | | |
| | kunststof bad acryl rechthoekig | | | | | | | |
| | 0985640 | 180x80cm z. poten | wit | S8H0B000000 | stuk | 592,00 | 099 | 1 |
| | 0330250 | badpotenset los voor Sphinx baden | | S8H991000 | stuk | 29,00 | 099 | 0 |
| Accessoires en spiegels | Sphinx 340 | | | | | | | |
| | kunststof bad acryl rechthoekig | | | | | | | |
| | 0281999 | 170x75cm z. poten | wit | S8H0R000000 | stuk | 432,00 | 099 | 1 |
| Douchewanden | 0282006 | 170x75cm z. poten | pergamon | S8H0R000030 | stuk | 432,00 | 099 | 1 |
| | 0282049 | 180x80cm z. poten | wit | S8H0S000000 | stuk | 532,00 | 099 | 0 |
| | 0282057 | 180x80cm z. poten | pergamon | S8H0S000030 | stuk | 532,00 | 099 | 1 |
| | 0330250 | badpotenset los voor Sphinx baden | | S8H991000 | stuk | 29,00 | 099 | 0 |
| Toebehoren & afvoeren | Sphinx Milano | | | | | | | |
| | kunststof bad acryl rechthoekig | | | | | | | |
| | 0330183 | 170x75cm z. poten | wit | S8H03000000 | stuk | 457,00 | 099 | 1 |
| Spoel- & installatiesystemen | 0331562 | 180x80cm z. poten | wit | S8H09000000 | stuk | 572,00 | 099 | 0 |
| | 0330250 | badpotenset los voor Sphinx baden | | S8H991000 | stuk | 29,00 | 099 | 0 |
| Badkamermeubelen en toiletkasten | Sphinx Mycene | | | | | | | |
| | kunststof bad acryl achthoekig | | | | | | | |
| Gootstenen en wastroggen | 0331017 | 180x90cm z. poten | wit | S8H06000000 | stuk | 1669,00 | 099 | 1 |
| | 0330250 | badpotenset los voor Sphinx baden | | S8H991000 | stuk | 29,00 | 099 | 0 |
| Utiliteit | Sphinx Normaline | | | | | | | |
| | kunststof douchebak acryl vierkant | | | | | | | |
| | 0080579 | 80x80cm | wit | S8H31000000 | stuk | 188,00 | 099 | 1 |
| | 0080580 | 80x80cm | pergamon | S8H31000030 | stuk | 188,00 | 099 | 1 |
| | 0080587 | 90x90cm | wit | S8H32000000 | stuk | 191,00 | 099 | 1 |
| | 0080588 | 90x90cm | pergamon | S8H32000030 | stuk | 191,00 | 099 | 1 |
| | 0080597 | 100x100cm | wit | S8H38000000 | stuk | 206,00 | 099 | 1 |
| | 0080598 | 100x100cm | pergamon | S8H38000030 | stuk | 206,00 | 099 | 1 |
| | kunststof douchebak acryl rechthoekig | | | | | | | |
| | 0080585 | 90x75cm | wit | S8H33000000 | stuk | 191,00 | 099 | 1 |
| | 0080586 | 90x75cm | pergamon | S8H33000030 | stuk | 191,00 | 099 | 1 |
| | kunststof douchebak acryl kwart rond | | | | | | | |
| | 0080581 | 80x80cm z. paneel | wit | S8H34000000 | stuk | 244,00 | 099 | 1 |
| | 0080582 | 80x80cm z. paneel | pergamon | S8H34000030 | stuk | 244,00 | 099 | 1 |
| | 0080583 | 80x80cm m. paneel | wit | S8H34001000 | stuk | 365,00 | 099 | 1 |
| | 0080584 | 80x80cm m. paneel | pergamon | S8H34001030 | stuk | 365,00 | 099 | 1 |
| | 0080589 | 90x90cm z. paneel | wit | S8H35000000 | stuk | 262,00 | 099 | 1 |
| 0080590 | 90x90cm z. paneel | pergamon | S8H35000030 | stuk | 262,00 | 099 | 1 | |
| 0080591 | 90x90cm m. paneel | wit | S8H35001000 | stuk | 391,00 | 099 | 1 | |
| 0080592 | 90x90cm m. paneel | pergamon | S8H35001030 | stuk | 391,00 | 099 | 1 | |
| 0080599 | 100x100cm z. paneel | wit | S8H39000000 | stuk | 285,00 | 099 | 1 | |
| 0080600 | 100x100cm z. paneel | pergamon | S8H39000030 | stuk | 285,00 | 099 | 1 | |

| Art.nr | Specificaties | Kleur | Lev.nr | Ehd | Prijs | Grp | CC |
|---|-----------------------------------|----------|-------------|------|---------|-----|----|
| Sphinx Normaline | | | | | | | |
| kunststof douchebak acryl vijfhoekig | | | | | | | |
| 0080593 | 90x90cm z. paneel | wit | S8H36000000 | stuk | 258,00 | 099 | 1 |
| 0080594 | 90x90cm z. paneel | pergamon | S8H36000030 | stuk | 258,00 | 099 | 1 |
| 0080595 | 90x90cm m. paneel | wit | S8H36001000 | stuk | 385,00 | 099 | 1 |
| 0080596 | 90x90cm m. paneel | pergamon | S8H36001030 | stuk | 385,00 | 099 | 1 |
| 0080603 | 100x100cm z. paneel | wit | S8H37000000 | stuk | 348,00 | 099 | 1 |
| 0080604 | 100x100cm z. paneel | pergamon | S8H37000030 | stuk | 348,00 | 099 | 1 |
| 0080605 | 100x100cm m. paneel | wit | S8H37001000 | stuk | 523,00 | 099 | 1 |
| 0080606 | 100x100cm m. paneel | pergamon | S8H37001030 | stuk | 523,00 | 099 | 1 |
| Sphinx Progress | | | | | | | |
| kunststof bad acryl rechthoekig | | | | | | | |
| 0332690 | 180x80cm z. poten | wit | S8H0M000000 | stuk | 750,00 | 099 | 1 |
| 0332704 | 180x80cm z. poten | pergamon | S8H0M000030 | stuk | 750,00 | 099 | 1 |
| 0330250 | badpotenset los voor Sphinx baden | | S8H991000 | stuk | 29,00 | 099 | 0 |
| kunststof bad acryl ovaal | | | | | | | |
| 0332712 | 190x90cm z. poten | wit | S8H0F000000 | stuk | 976,00 | 099 | 1 |
| 0332720 | 190x90cm z. poten | pergamon | S8H0F000030 | stuk | 976,00 | 099 | 1 |
| 0330250 | badpotenset los voor Sphinx baden | | S8H991000 | stuk | 29,00 | 099 | 0 |
| kunststof bad acryl zeshoekig | | | | | | | |
| 0333108 | 190x90cm z. poten | wit | S8H0J000000 | stuk | 842,00 | 099 | 1 |
| 0333109 | 190x90cm z. poten | pergamon | S8H0J000030 | stuk | 842,00 | 099 | 1 |
| 0330250 | badpotenset los voor Sphinx baden | | S8H991000 | stuk | 29,00 | 099 | 0 |
| Sphinx Terra | | | | | | | |
| kunststof bad acryl rechthoekig | | | | | | | |
| 0332749 | 180x90cm z. poten | wit | S8H0X000000 | stuk | 1184,00 | 099 | 1 |
| 0332748 | 180x90cm z. poten | pergamon | S8H0X000030 | stuk | 1184,00 | 099 | 1 |
| 0332739 | 190x90cm z. poten | wit | S8H0T000000 | stuk | 1399,00 | 099 | 1 |
| 0332747 | 190x90cm z. poten | pergamon | S8H0T000030 | stuk | 1399,00 | 099 | 1 |
| 0330250 | badpotenset los voor Sphinx baden | | S8H991000 | stuk | 29,00 | 099 | 0 |
| Sphinx Toebehoren | | | | | | | |
| 0330531 | badgreep per stuk | chrom | S8H790C00 | stuk | 73,00 | 099 | 1 |
| 0330250 | badpotenset los voor Sphinx baden | | S8H991000 | stuk | 29,00 | 099 | 0 |

Sanitair producten

Baden /
douchebakken /
stoomcabines

Kranen

Douchegarnituur

Accessoires en
spiegels

Douchewanden

Toebehoren &
afvoerenSpoel- &
installatiesystemenBadkamermeubelen
en toiletkastenGootstenen en
wastroggen

Utiliteit

Kunststof douchebakken Sphinx

| | Art.nr | Specificaties | Kleur | Lev.nr | Ehd | Prijs | Grp | CC | |
|---|--|---|---|---------------|---------------|--------|--------|-----|---|
| Sanitair producten | Sphinx Antibes | | | | | | | | |
| | kunststof douchebak acryl rechthoekig | | | | | | | | |
| | 0331341 | 100x80x6.5 | wit | S8H27000000 | stuk | 346,00 | 099 | 0 | |
| | 0360635 | douchebaksteun m. 5 verstelbare poten 125-195mm | | 5SGS | stuk | 33,00 | 062 | 0 | |
| Baden / douchebakken / stoomcabines | Sphinx 340/Linate 360/Flash | | | | | | | | |
| | kunststof douchebak acryl vierkant | | | | | | | | |
| | 0332577 | 90x90cm | wit | S8H25000000 | stuk | 296,00 | 099 | 0 | |
| | 0360635 | douchebaksteun m. 5 verstelbare poten 125-195mm | | 5SGS | stuk | 33,00 | 062 | 0 | |
| Kranen | | | | | | | | | |
| Douchegarnituur | Sphinx Mycene | | | | | | | | |
| | kunststof douchebak acryl vierkant | | | | | | | | |
| | 0331016 | 90x90x15 | wit | S8H24000000 | stuk | 472,00 | 099 | 1 | |
| Accessoires en spiegels | Sphinx Plana | | | | | | | | |
| | kunststof douchebak acryl | | | | | | | | |
| | 0332186 | 90x80x5cm rechthoekig | wit | S8H2H000000 | stuk | 283,00 | 099 | 1 | |
| | 0332194 | 90x80x5cm rechthoekig | pergamon | S8H2H000030 | stuk | 283,00 | 099 | 1 | |
| Douchewanden | | 0331732 | 90x90cm vierkant | wit | S8H2A000000 | stuk | 300,00 | 099 | 1 |
| | | 0331740 | 90x90cm vierkant | pergamon | S8H2A000030 | stuk | 300,00 | 099 | 1 |
| | | 0332224 | 100x100x5cm vierkant | wit | S8H2B0000000 | stuk | 423,00 | 099 | 1 |
| | | 0332232 | 100x100x5cm vierkant | pergamon | S8H2B0000300 | stuk | 423,00 | 099 | 1 |
| | | 0332275 | 120x90x5cm rechthoekig | wit | S8H2K0000000 | stuk | 447,00 | 099 | 1 |
| Toebehoren & afvoeren | | 0332283 | 120x90x5cm rechthoekig | pergamon | S8H2K0000300 | stuk | 447,00 | 099 | 1 |
| | | 0360635 | douchebaksteun m. 5 verstelbare poten 125-195mm | | 5SGS | stuk | 33,00 | 062 | 0 |
| | | | | | | | | | |
| Spool- & installatiesystemen | | | | | | | | | |
| Badkamermeubelen en toiletkasten | | | | | | | | | |
| Gootstenen en wastroggen | kunststof douchebak acryl kwart rond | | | | | | | | |
| | | 0332313 | 80x80cm z. paneel | wit | S8H2J0000000 | stuk | 447,00 | 099 | 1 |
| | | 0332321 | 80x80cm z. paneel | pergamon | S8H2J0000300 | stuk | 447,00 | 099 | 1 |
| | | 0332364 | 80x80cm m. paneel | wit | S8H2J0010000 | stuk | 648,00 | 099 | 1 |
| | | 0332372 | 80x80cm m. paneel | pergamon | S8H2J0010300 | stuk | 648,00 | 099 | 1 |
| | | 0331899 | 90x90cm z. paneel | wit | S8H2D0000000 | stuk | 326,00 | 099 | 1 |
| | | 0331902 | 90x90cm z. paneel | pergamon | S8H2D0000300 | stuk | 326,00 | 099 | 1 |
| | | 0331864 | 90x90cm m. paneel | wit | S8H2D0010000 | stuk | 528,00 | 099 | 0 |
| | | 0331872 | 90x90cm m. paneel | pergamon | S8H2D0010300 | stuk | 528,00 | 099 | 1 |
| | | 0332410 | 100x100cm z. paneel | wit | S8H2E0000000 | stuk | 477,00 | 099 | 1 |
| Utiliteit | | 0332429 | 100x100cm z. paneel | pergamon | S8H2E0000300 | stuk | 477,00 | 099 | 1 |
| | | 0985610 | 100x100cm m. paneel | wit | S8H2E0010000 | stuk | 677,00 | 099 | 1 |
| | | 0988774 | 100x100cm m. paneel | pergamon | S8H2E0010300 | stuk | 677,00 | 099 | 1 |
| | kunststof douchebak acryl vijfhoekig | | | | | | | | |
| | | 0331821 | 90x90cm z. paneel | wit | S8H2C0000000 | stuk | 326,00 | 099 | 1 |
| | | 0331848 | 90x90cm z. paneel | pergamon | S8H2C0000300 | stuk | 326,00 | 099 | 1 |
| | | 0331791 | 90x90cm m. paneel | wit | S8H2C0010000 | stuk | 528,00 | 099 | 1 |
| | | 0331805 | 90x90cm m. paneel | pergamon | S8H2C0010300 | stuk | 528,00 | 099 | 1 |
| | | 0332488 | 100x100cm z. paneel | wit | S8H2L00000000 | stuk | 477,00 | 099 | 1 |
| | | 0332496 | 100x100cm z. paneel | pergamon | S8H2L00003000 | stuk | 477,00 | 099 | 1 |
| | 0332534 | 100x100cm m. paneel | wit | S8H2L00100000 | stuk | 677,00 | 099 | 1 | |
| | 0332542 | 100x100cm m. paneel | pergamon | S8H2L00103000 | stuk | 677,00 | 099 | 1 | |

| Art.nr | Specificaties | Kleur | Lev.nr | Ehd | Prijs | Grp | CC |
|--------|---------------|-------|--------|-----|-------|-----|----|
|--------|---------------|-------|--------|-----|-------|-----|----|

Sphinx Terra

kunststof douchebak acryl rechthoekig

| | | | | | | | |
|---------|---|----------|-------------|------|--------|-----|---|
| 0332852 | 100x90cm | wit | S8H2Q000000 | stuk | 543,00 | 099 | 1 |
| 0332860 | 100x90cm | pergamon | S8H2Q000030 | stuk | 543,00 | 099 | 1 |
| 0332879 | 120x90cm | wit | S8H2R000000 | stuk | 602,00 | 099 | 1 |
| 0332887 | 120x90cm | pergamon | S8H2R000030 | stuk | 602,00 | 099 | 1 |
| 0360635 | douchebaksteun m. 5 verstelbare poten 125-195mm | | 5SGS | stuk | 33,00 | 062 | 0 |



Sanitair producten

Baden /
douchebakken /
stoomcabines

Kranen

kunststof douchebak acryl

| | | | | | | | | |
|---------|---------|-------------|----------|-------------|------|--------|-----|---|
| 0333913 | 90x80cm | rechthoekig | wit | S8H2S000000 | stuk | 468,00 | 099 | 1 |
| 0333921 | 90x80cm | rechthoekig | pergamon | S8H2S000030 | stuk | 468,00 | 099 | 1 |
| 0333727 | 90x90cm | vierkant | wit | S8H2T000000 | stuk | 468,00 | 099 | 1 |
| 0333735 | 90x90cm | vierkant | pergamon | S8H2T000030 | stuk | 468,00 | 099 | 1 |

Doucheapparatuur

kunststof douchebak acryl kwarttrond

| | | | | | | | | |
|---------|-----------|-----------|----------|-------------|------|---------|-----|---|
| 0333794 | 90x90cm | z. paneel | wit | S8H2W000000 | stuk | 637,00 | 099 | 1 |
| 0333808 | 90x90cm | z. paneel | pergamon | S8H2W000030 | stuk | 637,00 | 099 | 1 |
| 0333875 | 100x100cm | z. paneel | wit | S8H2V000000 | stuk | 813,00 | 099 | 1 |
| 0333883 | 100x100cm | z. paneel | pergamon | S8H2V000030 | stuk | 813,00 | 099 | 1 |
| 0333816 | 90x90cm | m. paneel | wit | S8H2V001000 | stuk | 863,00 | 099 | 1 |
| 0333824 | 90x90cm | m. paneel | pergamon | S8H2V001030 | stuk | 863,00 | 099 | 1 |
| 0333891 | 100x100cm | m. paneel | wit | S8H2V001000 | stuk | 1038,00 | 099 | 1 |
| 0333905 | 100x100cm | m. paneel | pergamon | S8H2V001030 | stuk | 1038,00 | 099 | 1 |

Accessoires en
spiegels

Douchewanden

Toebehoren &
afvoerenSpoel- &
installatiesystemen

kunststof douchebak acryl vijfhoekig

| | | | | | | | | |
|---------|-----------|-----------|----------|-------------|------|---------|-----|---|
| 0333743 | 90x90cm | z. paneel | wit | S8H2Z000000 | stuk | 637,00 | 099 | 1 |
| 0333751 | 90x90cm | z. paneel | pergamon | S8H2Z000030 | stuk | 637,00 | 099 | 1 |
| 0333832 | 100x100cm | z. paneel | wit | S8H2Y000000 | stuk | 813,00 | 099 | 1 |
| 0333840 | 100x100cm | z. paneel | pergamon | S8H2Y000030 | stuk | 813,00 | 099 | 1 |
| 0333778 | 90x90cm | m. paneel | wit | S8H2Z001000 | stuk | 863,00 | 099 | 1 |
| 0333786 | 90x90cm | m. paneel | pergamon | S8H2Z001030 | stuk | 863,00 | 099 | 1 |
| 0333859 | 100x100cm | m. paneel | wit | S8H2Y001000 | stuk | 1038,00 | 099 | 1 |
| 0333867 | 100x100cm | m. paneel | pergamon | S8H2Y001030 | stuk | 1038,00 | 099 | 1 |

Badkamermeubelen
en toiletkastenGootstenen en
wastroggen

Sphinx douchebak toebehoren

| | | | | | | | |
|---------|----------------------------|--|-----------|------|-------|-----|---|
| 0340044 | set douchebakpoten 5-delig | | S8H863000 | stuk | 35,50 | 099 | 1 |
|---------|----------------------------|--|-----------|------|-------|-----|---|

Utiliteit

| | Art.nr | Specificaties | Kleur | Lev.nr | Ehd | Prijs | Grp | CC |
|---|--|--|----------|-----------------|------|---------|-----|----|
| | Ucosan Andromeda | | | | | | | |
| | kunststof bad acryl rechthoekig | | | | | | | |
| Sanitair producten | 0930636 | 170x80cm m. grepen z. poten | wit | BA170ANR2HU01 | stuk | 677,00 | 108 | 1 |
| | 0930644 | 170x80cm m. grepen z. poten | pergamon | BA170ANR2HU09 | stuk | 677,00 | 108 | 1 |
| | 0930652 | 180x80cm m. grepen z. poten | wit | BA180ANR2HU01 | stuk | 734,00 | 108 | 1 |
| | 0930660 | 180x80cm m. grepen z. poten | pergamon | BA180ANR2HU09 | stuk | 734,00 | 108 | 1 |
| Baden / douchebakken / stoomcabines | 0949647 | badpoten voor Ucosan acryl bad | | 9009020020 | stuk | 8,00 | 108 | 0 |
| | kunststof bad acryl ovaal | | | | | | | |
| | 0930695 | 195x95cm m. grepen m. paneel z. poten | wit | BA195ANR7PFHU01 | stuk | 2090,00 | 108 | 1 |
| | 0930709 | 195x95cm m. grepen m. paneel z. poten | pergamon | BA195ANR7PFHU09 | stuk | 2090,00 | 108 | 1 |
| Kranen | 0930679 | 195x95cm m. grepen z. poten | wit | BA195ANR7HU01 | stuk | 1356,00 | 108 | 1 |
| | 0930687 | 195x95cm m. grepen z. poten | pergamon | BA195ANR7HU09 | stuk | 1356,00 | 108 | 1 |
| | 0949647 | badpoten voor Ucosan acryl bad | | 9009020020 | stuk | 8,00 | 108 | 0 |
| | kunststof bad acryl zeshoekig | | | | | | | |
| Douchegarnituur | 0930717 | 190x90cm m. grepen z. poten | wit | BA190ANR6HU01 | stuk | 789,00 | 108 | 1 |
| | 0930725 | 190x90cm m. grepen z. poten | pergamon | BA190ANR6HU09 | stuk | 789,00 | 108 | 1 |
| | 0949647 | badpoten voor Ucosan acryl bad | | 9009020020 | stuk | 8,00 | 108 | 0 |
| | kunststof hoekbad acryl | | | | | | | |
| Accessoires en spiegels | 0930784 | 145x145cm m. grepen z. poten | wit | BA145ANR3HU01 | stuk | 904,00 | 108 | 1 |
| | 0930792 | 145x145cm m. grepen z. poten | pergamon | BA145ANR3HU09 | stuk | 904,00 | 108 | 1 |
| | 0930806 | 145x145cm m. grepen m. paneel z. poten | wit | BA145ANR3PFHU01 | stuk | 1411,00 | 108 | 1 |
| Douchewanden | 0930849 | 145x145cm m. grepen m. paneel z. poten | pergamon | BA145ANR3PFHU09 | stuk | 1411,00 | 108 | 1 |
| | 0930857 | 165x165cm m. grepen z. poten | wit | BA165ANR3HU01 | stuk | 1243,00 | 108 | 1 |
| | 0930865 | 165x165cm m. grepen z. poten | pergamon | BA165ANR3HU09 | stuk | 1243,00 | 108 | 1 |
| Toebehoren & afvoeren | 0930881 | 165x165cm m. grepen m. paneel z. poten | wit | BA165ANR3PFHU01 | stuk | 1864,00 | 108 | 1 |
| | 0930903 | 165x165cm m. grepen m. paneel z. poten | pergamon | BA165ANR3PFHU09 | stuk | 1864,00 | 108 | 1 |
| | 0930733 | 150x150cm m. grepen z. poten | wit | BA150ANR3HU01 | stuk | 1016,00 | 108 | 1 |
| | 0930741 | 150x150cm m. grepen z. poten | pergamon | BA150ANR3HU09 | stuk | 1016,00 | 108 | 1 |
| | 0930768 | 150x150cm m. grepen m. paneel z. poten | wit | BA150ANR3PFHU01 | stuk | 1525,00 | 108 | 1 |
| | 0930776 | 150x150cm m. grepen m. paneel z. poten | pergamon | BA150ANR3PFHU09 | stuk | 1525,00 | 108 | 1 |
| | 0949647 | badpoten voor Ucosan acryl bad | | 9009020020 | stuk | 8,00 | 108 | 0 |
| | Ucosan Cassandra | | | | | | | |
| | kunststof bad acryl rechthoekig | | | | | | | |
| Spoel- & installatiesystemen | 0930911 | 170x70cm z. poten | wit | BA177CAS2U01 | stuk | 385,00 | 108 | 1 |
| | 0930938 | 170x70cm z. poten | pergamon | BA177CAS2U09 | stuk | 385,00 | 108 | 1 |
| Badkamermeubelen en toiletkasten | 0930946 | 170x75cm z. poten | wit | BA170CAS2U01 | stuk | 385,00 | 108 | 0 |
| | 0930962 | 170x75cm z. poten | pergamon | BA170CAS2U09 | stuk | 385,00 | 108 | 1 |
| Gootstenen en wastroggen | 0930970 | 180x80cm z. poten | wit | BA180CAS2U01 | stuk | 436,00 | 108 | 0 |
| | 0930989 | 180x80cm z. poten | pergamon | BA180CAS2U09 | stuk | 436,00 | 108 | 1 |
| | 0930997 | 190x90cm z. poten | wit | BA190CAS2U01 | stuk | 604,00 | 108 | 0 |
| | 0931004 | 190x90cm z. poten | pergamon | BA190CAS2U09 | stuk | 604,00 | 108 | 1 |
| | 0949647 | badpoten voor Ucosan acryl bad | | 9009020020 | stuk | 8,00 | 108 | 0 |
| | kunststof bad acryl links | | | | | | | |
| Utiliteit | 0931020 | 180x80cm z. poten | wit | BA180CAS3LIU01 | stuk | 677,00 | 108 | 1 |
| | 0931039 | 180x80cm z. poten | pergamon | BA180CAS3LIU09 | stuk | 677,00 | 108 | 1 |
| | 0931063 | 180x80cm m. paneel z. poten | wit | BA180CAS3FLU01 | stuk | 1185,00 | 108 | 1 |
| | 0931071 | 180x80cm m. paneel z. poten | pergamon | BA180CAS3FLU09 | stuk | 1185,00 | 108 | 1 |
| | 0949647 | badpoten voor Ucosan acryl bad | | 9009020020 | stuk | 8,00 | 108 | 0 |
| | kunststof bad acryl rechts | | | | | | | |
| | 0931047 | 180x80cm z. poten | wit | BA180CAS3REU01 | stuk | 677,00 | 108 | 1 |
| | 0931055 | 180x80cm z. poten | pergamon | BA180CAS3REU09 | stuk | 677,00 | 108 | 1 |
| | 0931098 | 180x80cm m. paneel z. poten | wit | BA180CAS3FRU01 | stuk | 1185,00 | 108 | 1 |
| | 0931101 | 180x80cm m. paneel z. poten | pergamon | BA180CAS3FRU09 | stuk | 1185,00 | 108 | 1 |
| | 0949647 | badpoten voor Ucosan acryl bad | | 9009020020 | stuk | 8,00 | 108 | 0 |
| | Ucosan Dodona | | | | | | | |
| | kunststof bad acryl rechthoekig | | | | | | | |
| | 0933287 | 170x75cm z. poten | wit | BA170DOD2U01 | stuk | 395,00 | 108 | 0 |
| | 0933295 | 170x75cm z. poten | pergamon | BA170DOD2U09 | stuk | 395,00 | 108 | 1 |
| | 0933309 | 180x80cm z. poten | wit | BA180DOD2U01 | stuk | 508,00 | 108 | 1 |
| | 0933317 | 180x80cm z. poten | pergamon | BA180DOD2U09 | stuk | 508,00 | 108 | 1 |
| | 0949647 | badpoten voor Ucosan acryl bad | | 9009020020 | stuk | 8,00 | 108 | 0 |

| Art.nr | Specificaties | Kleur | Lev.nr | Ehd | Prijs | Grp | CC |
|--------|---------------|-------|--------|-----|-------|-----|----|
|--------|---------------|-------|--------|-----|-------|-----|----|

Ucosan Dodona

kunststof hoekbad acryl

| | | | | | | | |
|---------|--------------------------------|--------------------|----------|----------------|------|---------|-------|
| 0933325 | 120x120cm | z. poten | wit | BA120DOD3U01 | stuk | 621,00 | 108 1 |
| 0933333 | 120x120cm | z. poten | pergamon | BA120DOD3U09 | stuk | 621,00 | 108 1 |
| 0931128 | 120x120cm | m. paneel m. frame | wit | BA120DOD3PFU01 | stuk | 1129,00 | 108 1 |
| 0931136 | 120x120cm | m. paneel m. frame | pergamon | BA120DOD3PFU09 | stuk | 1129,00 | 108 1 |
| 0931144 | 135x135cm | z. poten | wit | BA135DOD3U01 | stuk | 734,00 | 108 1 |
| 0931152 | 135x135cm | z. poten | pergamon | BA135DOD3U09 | stuk | 734,00 | 108 1 |
| 0931160 | 135x135cm | m. paneel m. frame | wit | BA135DOD3PFU01 | stuk | 1242,00 | 108 1 |
| 0931179 | 135x135cm | m. paneel m. frame | pergamon | BA135DOD3PFU09 | stuk | 1242,00 | 108 1 |
| 0931187 | 145x145cm | z. poten | wit | BA145DOD3U01 | stuk | 677,00 | 108 1 |
| 0933341 | 145x145cm | z. poten | pergamon | BA145DOD3U09 | stuk | 677,00 | 108 1 |
| 0931195 | 145x145cm | m. paneel z. poten | wit | BA145DOD3PFU01 | stuk | 1185,00 | 108 1 |
| 0931209 | 145x145cm | m. paneel z. poten | pergamon | BA145DOD3PFU09 | stuk | 1185,00 | 108 1 |
| 0949647 | badpoten voor Ucosan acryl bad | | | 9009020020 | stuk | 8,00 | 108 0 |

kunststof hoek bad/douchecombinatie compleet m. kraan en afvoer

| | | | | | | | |
|---------|-----------|------------------------|----------|----------------|------|---------|-------|
| 0931217 | 145x145cm | links m. douchescherm | wit | EB145DOD3FLU01 | stuk | 3051,00 | 108 1 |
| 0931225 | 145x145cm | links m. douchescherm | pergamon | EB145DOD3FLU09 | stuk | 3051,00 | 108 1 |
| 0931233 | 145x145cm | rechts m. douchescherm | wit | EB145DOD3FRU01 | stuk | 3051,00 | 108 1 |

kunststof hoek/badcombinatie compleet m. kraan en afvoer

| | | | | | | | |
|---------|-----------|------------------------|----------|----------------|------|---------|-------|
| 0931241 | 145x145cm | rechts m. douchescherm | pergamon | EB145DOD3FRU09 | stuk | 3051,00 | 108 1 |
|---------|-----------|------------------------|----------|----------------|------|---------|-------|

kunststof bad acryl links

| | | | | | | | |
|---------|-----------|--------------------|----------|----------------|------|---------|-------|
| 0931268 | 150x100cm | z. poten | wit | BA150DOD3LIU01 | stuk | 621,00 | 108 1 |
| 0931276 | 150x100cm | z. poten | pergamon | BA150DOD3LIU09 | stuk | 621,00 | 108 1 |
| 0931306 | 150x100cm | m. paneel m. frame | wit | BA150DOD3FLU01 | stuk | 1129,00 | 108 1 |
| 0931314 | 150x100cm | m. paneel m. frame | pergamon | BA150DOD3FLU09 | stuk | 1129,00 | 108 1 |

kunststof bad acryl rechts

| | | | | | | | |
|---------|-----------|--------------------|----------|----------------|------|---------|-------|
| 0931284 | 150x100cm | z. poten | wit | BA150DOD3REU01 | stuk | 621,00 | 108 1 |
| 0931292 | 150x100cm | z. poten | pergamon | BA150DOD3REU09 | stuk | 621,00 | 108 1 |
| 0931322 | 150x100cm | m. paneel m. frame | wit | BA150DOD3FRU01 | stuk | 1129,00 | 108 1 |
| 0931330 | 150x100cm | m. paneel m. frame | pergamon | BA150DOD3FRU09 | stuk | 1129,00 | 108 1 |

kunststof hoek bad/douchecombinatie compleet m. kraan en afvoer

| | | | | | | | |
|---------|-----------|------------------------|----------|----------------|------|---------|-------|
| 0931349 | 150x100cm | links m. douchescherm | wit | EB150DOD3FLU01 | stuk | 2826,00 | 108 1 |
| 0931357 | 150x100cm | links m. douchescherm | pergamon | EB150DOD3FLU09 | stuk | 2826,00 | 108 1 |
| 0931365 | 150x100cm | rechts m. douchescherm | wit | EB150DOD3FRU01 | stuk | 2826,00 | 108 1 |
| 0931373 | 150x100cm | rechts m. douchescherm | pergamon | EB150DOD3FRU09 | stuk | 2826,00 | 108 1 |

kunststof bad acryl links

| | | | | | | | |
|---------|----------|--------------------|----------|----------------|------|---------|-------|
| 0931403 | 170x70cm | z. poten | wit | BA170DOD3LIU01 | stuk | 564,00 | 108 1 |
| 0931411 | 170x70cm | z. poten | pergamon | BA170DOD3LIU09 | stuk | 564,00 | 108 1 |
| 0931438 | 170x70cm | m. paneel m. frame | pergamon | BA170DOD3FLU09 | stuk | 1072,00 | 108 1 |
| 0933368 | 170x70cm | m. paneel m. frame | wit | BA170DOD3FLU01 | stuk | 1072,00 | 108 1 |

kunststof hoek bad/douchecombinatie compleet m. kraan en afvoer

| | | | | | | | |
|---------|----------|------------------------|----------|----------------|------|---------|-------|
| 0931446 | 170x70cm | links m. douchescherm | wit | EB170DOD3FLU01 | stuk | 2600,00 | 108 1 |
| 0931454 | 170x70cm | links m. douchescherm | pergamon | EB170DOD3FLU09 | stuk | 2600,00 | 108 1 |
| 0931462 | 170x70cm | rechts m. douchescherm | wit | EB170DOD3FRU01 | stuk | 2600,00 | 108 1 |
| 0931470 | 170x70cm | rechts m. douchescherm | pergamon | EB170DOD3FRU09 | stuk | 2600,00 | 108 1 |

kunststof bad acryl rechts

| | | | | | | | |
|---------|----------|--------------------|----------|----------------|------|---------|-------|
| 0931489 | 170x70cm | z. poten | wit | BA170DOD3REU01 | stuk | 564,00 | 108 1 |
| 0931497 | 170x70cm | z. poten | pergamon | BA170DOD3REU09 | stuk | 564,00 | 108 1 |
| 0931500 | 170x70cm | m. paneel m. frame | wit | BA170DOD3FRU01 | stuk | 1072,00 | 108 1 |
| 0931519 | 170x70cm | m. paneel m. frame | pergamon | BA170DOD3FRU09 | stuk | 1072,00 | 108 1 |

Ucosan Nayobe

kunststof bad acryl rechthoekig

| | | | | | | | |
|---------|--------------------------------|----------|----------|--------------|------|--------|-------|
| 0931527 | 170x75cm | z. poten | wit | BA170NAY2U01 | stuk | 451,00 | 108 1 |
| 0931535 | 170x75cm | z. poten | pergamon | BA170NAY2U09 | stuk | 451,00 | 108 1 |
| 0931543 | 180x80cm | z. poten | wit | BA180NAY2U01 | stuk | 508,00 | 108 1 |
| 0931551 | 180x80cm | z. poten | pergamon | BA180NAY2U09 | stuk | 508,00 | 108 1 |
| 0931578 | 180x90cm | z. poten | wit | BA189NAY2U01 | stuk | 564,00 | 108 1 |
| 0931586 | 180x90cm | z. poten | pergamon | BA189NAY2U09 | stuk | 564,00 | 108 1 |
| 0949647 | badpoten voor Ucosan acryl bad | | | 9009020020 | stuk | 8,00 | 108 0 |

| | Art.nr | Specificaties | Kleur | Lev.nr | Ehd | Prijs | Grp | CC |
|---|--|--------------------------------|---------------------------------|--------------|--------------|------------|--------|-------------|
| Sanitair producten | Ucosan Nayobe | | | | | | | |
| | kunststof bad acryl zeshoekig | | | | | | | |
| | | 0931594 | 195x80cm z. poten | wit | BA195NAY6U01 | stuk | 677,00 | 108 1 |
| | | 0931608 | 195x80cm z. poten | pergamon | BA195NAY6U09 | stuk | 677,00 | 108 1 |
| | | 0931616 | 205x90cm z. poten | wit | BA205NAY6U01 | stuk | 789,00 | 108 1 |
| Baden / douchebakken / stoomcabines | | 0931624 | 205x90cm z. poten | pergamon | BA205NAY6U09 | stuk | 789,00 | 108 1 |
| | | 0949647 | badpoten voor Ucosan acryl bad | | 9009020020 | stuk | 8,00 | 108 0 |
| Kranen | Ucosan Omain | | | | | | | |
| | kunststof bad acryl rechthoekig | | | | | | | |
| | | 0940251 | 180x80cm z. poten | wit | BA1800MA2V01 | stuk | 441,00 | 108 1 |
| | | 0947245 | 180x80cm z. poten | pergamon | BA1800MA2V09 | stuk | 441,00 | 108 1 |
| | | 0947253 | 180x80cm z. poten | klassiek wit | BA1800MA2V29 | stuk | 441,00 | 108 1 |
| Douchegarnituur | | 0949647 | badpoten voor Ucosan acryl bad | | 9009020020 | stuk | 8,00 | 108 0 |
| Accessoires en spiegels | Ucosan Toebehoren | | | | | | | |
| | | 0943363 | reparatieset voor bad en douche | | wit | 9217000010 | stuk | 44,75 108 0 |
| | | 0943371 | reparatieset voor bad en douche | | pergamon | 9217001820 | stuk | 44,75 108 1 |
| | 0949647 | badpoten voor Ucosan acryl bad | | 9009020020 | stuk | 8,00 | 108 0 | |
| Douchewanden | | | | | | | | |
| Toebehoren & afvoeren | | | | | | | | |
| Spoel- & installatiesystemen | | | | | | | | |
| Badkamermeubelen en toiletkasten | | | | | | | | |
| Gootstenen en wastroggen | | | | | | | | |
| Utiliteit | | | | | | | | |

| Art.nr | Specificaties | Kleur | Lev.nr | Ehd | Prijs | Grp | CC |
|--|--------------------------|------------|----------|---------------|-------|---------|-------|
| Ucosan Cassandra Easy Collection | | | | | | | |
| kunststof bad acryl rechthoekig m. whirlpoolsysteem | | | | | | | |
| 0943364 | 170x75cm | pneumatic | wit | PNW170CAS2U01 | stuk | 1322,00 | 139 1 |
| 0943387 | 170x75cm | pneumatic | pergamon | PNW170CAS2U09 | stuk | 1322,00 | 139 1 |
| 0943365 | 170x75cm | electronic | wit | ELW170CAS2U01 | stuk | 1965,00 | 139 1 |
| 0943384 | 170x75cm | electronic | pergamon | ELW170CAS2U09 | stuk | 1965,00 | 139 1 |
| 0943366 | 170x75cm | combi | wit | ELC170CAS2U01 | stuk | 2608,00 | 139 1 |
| 0943381 | 170x75cm | combi | pergamon | ELC170CAS2U09 | stuk | 2608,00 | 139 1 |
| 0943367 | 180x80cm | pneumatic | wit | PNW180CAS2U01 | stuk | 1373,00 | 139 1 |
| 0943388 | 180x80cm | pneumatic | pergamon | PNW180CAS2U09 | stuk | 1373,00 | 139 1 |
| 0943368 | 180x80cm | electronic | wit | ELW180CAS2U01 | stuk | 2016,00 | 139 1 |
| 0943385 | 180x80cm | electronic | pergamon | ELW180CAS2U09 | stuk | 2016,00 | 139 1 |
| 0943369 | 180x80cm | combi | wit | ELC180CAS2U01 | stuk | 2659,00 | 139 1 |
| 0943382 | 180x80cm | combi | pergamon | ELC180CAS2U09 | stuk | 2659,00 | 139 1 |
| 0943370 | 190x90cm | pneumatic | wit | PNW190CAS2U01 | stuk | 1541,00 | 139 1 |
| 0943389 | 190x90cm | pneumatic | pergamon | PNW190CAS2U09 | stuk | 1541,00 | 139 1 |
| 0943372 | 190x90cm | electronic | wit | ELW190CAS2U01 | stuk | 2184,00 | 139 1 |
| 0943386 | 190x90cm | electronic | pergamon | ELW190CAS2U09 | stuk | 2184,00 | 139 1 |
| 0943373 | 190x90cm | combi | wit | ELC190CAS2U01 | stuk | 2827,00 | 139 1 |
| 0943383 | 190x90cm | combi | pergamon | ELC190CAS2U09 | stuk | 2827,00 | 139 1 |
| Ucosan Dodona Easy Collection | | | | | | | |
| kunststof hoekbad acryl m. whirlpoolsysteem | | | | | | | |
| 0943374 | 135x135cm | pneumatic | wit | PNW135DOD3U01 | stuk | 1671,00 | 139 1 |
| 0943392 | 135x135cm | pneumatic | pergamon | PNW135DOD3U09 | stuk | 1671,00 | 139 1 |
| 0943375 | 135x135cm | electronic | wit | ELW135DOD3U01 | stuk | 2314,00 | 139 1 |
| 0943391 | 135x135cm | electronic | pergamon | ELW135DOD3U09 | stuk | 2314,00 | 139 1 |
| 0943376 | 135x135cm | combi | wit | ELC135DOD3U01 | stuk | 2957,00 | 139 1 |
| 0943390 | 135x135cm | combi | pergamon | ELC135DOD3U09 | stuk | 2957,00 | 139 1 |
| Ucosan Nayobe Easy Collection | | | | | | | |
| kunststof bad acryl zeshoekig m. whirlpoolsysteem | | | | | | | |
| 0943377 | 195x80cm | pneumatic | wit | PNW195NAY6U01 | stuk | 1614,00 | 139 1 |
| 0943395 | 195x80cm | pneumatic | pergamon | PNW195NAY6U09 | stuk | 1614,00 | 139 1 |
| 0943378 | 195x80cm | electronic | wit | ELW195NAY6U01 | stuk | 2257,00 | 139 1 |
| 0943394 | 195x80cm | electronic | pergamon | ELW195NAY6U09 | stuk | 2257,00 | 139 1 |
| 0943379 | 195x80cm | combi | wit | ELC195NAY6U01 | stuk | 2900,00 | 139 1 |
| 0943393 | 195x80cm | combi | pergamon | ELC195NAY6U09 | stuk | 2900,00 | 139 1 |
| Ucosan Toebehoren | | | | | | | |
| 0943380 | luchtrooster 19.8x18.8cm | wit | 88620068 | | stuk | 62,00 | 139 1 |

Sanitair producten

Baden /
douchebakken /
stoomcabines

Kranen

Douchegarnituur

Accessoires en
spiegels

Douchewanden

Toebehoren &
afvoerenSpoel- &
installatiesystemenBadkamermeubelen
en toiletkastenGootstenen en
wastroggen

Utiliteit

Kunststof douchebakken Ucosan

| | Art.nr | Specificaties | Kleur | Lev.nr | Ehd | Prijs | Grp | CC |
|---|---|---|-----------|-----------------|------|--------|-----|----|
| | Ucosan Denia | | | | | | | |
| | kunststof douchebak acryl | | | | | | | |
| Sanitair producten | 0931632 | 80x80x6cm vierkant | wit | DA0806DEN1U01 | stuk | 248,00 | 108 | 0 |
| | 0931640 | 80x80x6cm vierkant | pergamon | DA0806DEN1U09 | stuk | 248,00 | 108 | 1 |
| | 0931667 | 90x90x6cm vierkant | wit | DA0906DEN1U01 | stuk | 248,00 | 108 | 0 |
| | 0931675 | 90x90x6cm vierkant | pergamon | DA0906DEN1U09 | stuk | 248,00 | 108 | 1 |
| Baden / douchebakken / stoomcabines | 0931692 | 100x100x6cm vierkant | wit | DA1006DEN1U01 | stuk | 337,00 | 108 | 1 |
| | 0931693 | 100x100x6cm vierkant | pergamon | DA1006DEN1U09 | stuk | 337,00 | 108 | 1 |
| | 0931683 | 75x90x6cm rechthoekig | wit | DA9706DEN2U01 | stuk | 270,00 | 108 | 1 |
| | 0931691 | 75x90x6cm rechthoekig | pergamon | DA9706DEN2U09 | stuk | 270,00 | 108 | 1 |
| Kranen | 0931705 | 80x90x6cm rechthoekig | wit | DA9806DEN2U01 | stuk | 282,00 | 108 | 1 |
| | 0931713 | 80x90x6cm rechthoekig | pergamon | DA9806DEN2U09 | stuk | 282,00 | 108 | 1 |
| | 0931721 | 80x100cm rechthoekig | wit | DA1806DEN2U01 | stuk | 305,00 | 108 | 1 |
| | 0931748 | 80x100cm rechthoekig | pergamon | DA1806DEN2U09 | stuk | 305,00 | 108 | 1 |
| | 0931756 | 90x120cm rechthoekig | pergamon | DA1296DEN2U09 | stuk | 337,00 | 108 | 1 |
| Douchegarnituur | 0931764 | 90x120cm rechthoekig | wit | DA1296DEN2U01 | stuk | 337,00 | 108 | 1 |
| | 0360635 | douchebaksteun m. 5 verstelbare poten 125-195mm | | 5SGS | stuk | 33,00 | 062 | 0 |
| | kunststof douchebak acryl kwartrond links | | | | | | | |
| Accessoires en spiegels | 0931772 | 80x100x6cm z. paneel | wit | DA1806DEN3LIU01 | stuk | 337,00 | 108 | 1 |
| | 0931780 | 80x100x6cm z. paneel | pergamon | DA1806DEN3LIU09 | stuk | 337,00 | 108 | 1 |
| | 0931810 | 80x100cm m. paneel m. frame | wit | DA1806DEN3LLU01 | stuk | 451,00 | 108 | 1 |
| | 0931829 | 80x100cm m. paneel m. frame | pergamon | DA1806DEN3LLU09 | stuk | 451,00 | 108 | 1 |
| | 0360635 | douchebaksteun m. 5 verstelbare poten 125-195mm | | 5SGS | stuk | 33,00 | 062 | 0 |
| | kunststof douchebak acryl kwartrond rechts | | | | | | | |
| Douchewanden | 0931799 | 80x100x6cm z. paneel | wit | DA1806DEN3REU01 | stuk | 337,00 | 108 | 1 |
| | 0931802 | 80x100x6cm z. paneel | pergamon | DA1806DEN3REU09 | stuk | 337,00 | 108 | 1 |
| | 0931837 | 80x100cm m. paneel m. frame | wit | DA1806DEN3LRU01 | stuk | 451,00 | 108 | 1 |
| | 0931845 | 80x100cm m. paneel m. frame | pergamon | DA1806DEN3LRU09 | stuk | 451,00 | 108 | 1 |
| | 0360635 | douchebaksteun m. 5 verstelbare poten 125-195mm | | 5SGS | stuk | 33,00 | 062 | 0 |
| | kunststof douchebak acryl kwartrond | | | | | | | |
| Spoel- & installatiesystemen | 0931853 | 90x90x6cm z. paneel | wit | DA0906DEN4U01 | stuk | 248,00 | 108 | 0 |
| | 0933376 | 90x90x6cm z. paneel | pergamon | DA0906DEN4U09 | stuk | 248,00 | 108 | 1 |
| | 0931861 | 90x90cm m. paneel m. frame | wit | DA0906DEN4PFU01 | stuk | 361,00 | 108 | 0 |
| | 0931896 | 90x90cm m. paneel m. frame | pergamon | DA0906DEN4PFU09 | stuk | 361,00 | 108 | 1 |
| | 0931918 | 100x100x6cm z. paneel | wit | DA1006DEN4U01 | stuk | 337,00 | 108 | 1 |
| | 0931926 | 100x100x6cm z. paneel | pergamon | DA1006DEN4U09 | stuk | 337,00 | 108 | 1 |
| | 0931934 | 100x100cm m. paneel m. frame | wit | DA1006DEN4PFU01 | stuk | 451,00 | 108 | 1 |
| | 0931942 | 100x100cm m. paneel m. frame | pergamon | DA1006DEN4PFU09 | stuk | 451,00 | 108 | 1 |
| | 0360635 | douchebaksteun m. 5 verstelbare poten 125-195mm | | 5SGS | stuk | 33,00 | 062 | 0 |
| | kunststof douchebak acryl vijfhoekig | | | | | | | |
| Gootstenen en wastroggen | 0931950 | 90x90x6cm z. paneel | wit | DA0906DEN5U01 | stuk | 248,00 | 108 | 1 |
| | 0931969 | 90x90x6cm z. paneel | pergamon | DA0906DEN5U09 | stuk | 248,00 | 108 | 1 |
| | 0931977 | 90x90cm m. paneel m. frame | wit | DA0906DEN5PFU01 | stuk | 361,00 | 108 | 1 |
| | 0931985 | 90x90cm m. paneel m. frame | pergamon | DA0906DEN5PFU09 | stuk | 361,00 | 108 | 1 |
| | 0931993 | 100x100x6cm z. paneel | wit | DA1006DEN5U01 | stuk | 337,00 | 108 | 1 |
| | 0932000 | 100x100x6cm z. paneel | pergamon | DA1006DEN5U09 | stuk | 337,00 | 108 | 1 |
| Badkamermeubelen en toiletkasten | 0932019 | 100x100cm m. paneel m. frame | wit | DA1006DEN5PFU01 | stuk | 451,00 | 108 | 1 |
| | 0932027 | 100x100cm m. paneel m. frame | pergamon | DA1006DEN5PFU09 | stuk | 451,00 | 108 | 1 |
| | 0360635 | douchebaksteun m. 5 verstelbare poten 125-195mm | | 5SGS | stuk | 33,00 | 062 | 0 |
| | | Ucosan Sensis | | | | | | |
| | kunststof douchebak acryl vierkant | | | | | | | |
| | 0940453 | 80x80x15cm | wit | DA0815SEN1U01 | stuk | 292,00 | 108 | 1 |
| | 0941360 | 80x80x15cm | pergamon | DA0815SEN1U09 | stuk | 292,00 | 108 | 1 |
| | 0940631 | 90x90x15cm | wit | DA0915SEN1U01 | stuk | 350,00 | 108 | 1 |
| | 0941565 | 90x90x15cm | pergamon | DA0915SEN1U09 | stuk | 350,00 | 108 | 1 |
| | 0941557 | 90x90x15cm | manhattan | DA0915SEN1U15 | stuk | 350,00 | 108 | 1 |
| | 0946419 | 90x90x10cm | wit | DA0910SEN1U01 | stuk | 243,00 | 108 | 0 |
| | 0946427 | 90x90x10cm | pergamon | DA0910SEN1U09 | stuk | 243,00 | 108 | 1 |
| | 0360635 | douchebaksteun m. 5 verstelbare poten 125-195mm | | 5SGS | stuk | 33,00 | 062 | 0 |
| | kunststof douchebak acryl rechthoekig | | | | | | | |
| | 0940682 | 90x75x15cm | wit | DA9715SEN2U01 | stuk | 257,00 | 108 | 1 |
| | 0941611 | 90x75x15cm | pergamon | DA9715SEN2U09 | stuk | 257,00 | 108 | 1 |
| | 0943509 | 90x80x15cm | wit | DA9815SEN2U01 | stuk | 318,00 | 108 | 1 |
| | 0943517 | 90x80x15cm | pergamon | DA9815SEN2U09 | stuk | 318,00 | 108 | 1 |
| | 0360635 | douchebaksteun m. 5 verstelbare poten 125-195mm | | 5SGS | stuk | 33,00 | 062 | 0 |

| Art.nr | Specificaties | Kleur | Lev.nr | Ehd | Prijs | Grp | CC |
|--------|---------------|-------|--------|-----|-------|-----|----|
|--------|---------------|-------|--------|-----|-------|-----|----|

Ucosan Sensis

kunststof douchebak acryl kwartrond

| | | | | | | | |
|---------|---|----------|-----------------|------|--------|-----|---|
| 0946540 | 90x90x10cm z. paneel m. steun | wit | DA0910SEN4U01 | stuk | 384,00 | 108 | 1 |
| 0946559 | 90x90x10cm z. paneel m. steun | pergamon | DA0910SEN4U09 | stuk | 384,00 | 108 | 1 |
| 0946575 | 90x90x22cm m. paneel m. frame | wit | DA0910SEN4PFU01 | stuk | 443,00 | 108 | 1 |
| 0946583 | 90x90x22cm m. paneel m. frame | pergamon | DA0910SEN4PFU09 | stuk | 443,00 | 108 | 1 |
| 0360635 | douchebaksteun m. 5 verstelbare poten 125-195mm | | 5SGS | stuk | 33,00 | 062 | 0 |



Sanitair producten

Baden /
douchebakken /
stoomcabines**kunststof douchebak acryl vijfhoekig**

| | | | | | | | |
|---------|---|----------|-----------------|------|--------|-----|---|
| 0947695 | 90x90x10cm z. paneel m. steun | wit | DA0910SEN5U01 | stuk | 384,00 | 108 | 1 |
| 0947709 | 90x90x10cm z. paneel m. steun | pergamon | DA0910SEN5U09 | stuk | 384,00 | 108 | 1 |
| 0947725 | 90x90x22cm m. paneel m. frame | wit | DA0910SEN5PFU01 | stuk | 443,00 | 108 | 1 |
| 0947733 | 90x90x22cm m. paneel m. frame | pergamon | DA0910SEN5PFU09 | stuk | 443,00 | 108 | 1 |
| 0360635 | douchebaksteun m. 5 verstelbare poten 125-195mm | | 5SGS | stuk | 33,00 | 062 | 0 |



Kranen

Douchegarnituur











Accessoires en
spiegels

Douchewanden

Toebehoren &
afvoerenSpoel- &
installatiesystemenBadkamermeubelen
en toiletkastenGootstenen en
wastroggen

Utiliteit

| | Art.nr | Specificaties | Kleur | Lev.nr | Ehd | Prijs | Grp | CC |
|---|--|--|--------------|----------------|------|---------|-----|----|
| Sanitair producten | Villeroy & Boch Amadea | | | | | | | |
| | kunststof bad acryl | | | | | | | |
| | 0945000 | 180x80cm z. poten | wit | BA180AMD2V01 | stuk | 1485,00 | 108 | 1 |
| | 0945550 | 180x80cm z. poten | pergamon | BA180AMD2V09 | stuk | 1485,00 | 108 | 1 |
| | 0940026 | 190x90cm z. poten | wit | BA190AMD2V01 | stuk | 1722,00 | 108 | 1 |
| Baden / douchebakken / stoomcabines | 0944570 | 190x90cm z. poten | pergamon | BA190AMD2V09 | stuk | 1722,00 | 108 | 1 |
| | 0949639 | badpoten voor Villeroy & Boch acryl bad | | 4000000266 | stuk | 14,00 | 108 | 0 |
| | Villeroy & Boch Amata | | | | | | | |
| Kranen | kunststof bad acryl achthoekig | | | | | | | |
| | 0947768 | 185x80cm z. poten | wit | BA185AMT8V01 | stuk | 694,00 | 108 | 1 |
| | 0947776 | 185x80cm z. poten | pergamon | BA185AMT8V09 | stuk | 694,00 | 108 | 1 |
| | 0949647 | badpoten voor Ucosan acryl bad | | 9009020020 | stuk | 8,00 | 108 | 0 |
| Douchegarnituur | Villeroy & Boch Aveo | | | | | | | |
| | kunststof bad quarry ovaal | | | | | | | |
| | 0949976 | 190x95cm m. paneel en afvoer | wit | BQ194AVE9PDV01 | stuk | 4167,00 | 272 | 1 |
| | 0949977 | 190x95cm m. paneel en afvoer | pergamon | BQ194AVE9PDV09 | stuk | 4167,00 | 272 | 1 |
| | 0949974 | 190x95cm z. paneel | wit | BQ194AVE7V01 | stuk | 2113,00 | 272 | 1 |
| Accessoires en spiegels | 0949975 | 190x95cm z. paneel | pergamon | BQ194AVE7V09 | stuk | 2113,00 | 272 | 1 |
| Douchewanden | Villeroy & Boch Bellevue | | | | | | | |
| | kunststof bad acryl rechthoekig | | | | | | | |
| | 0940281 | 200x100cm inbouw | wit | BA200BEL2V01 | stuk | 1857,00 | 108 | 1 |
| | 0940282 | 200x100cm inbouw | pergamon | BA200BEL2V09 | stuk | 1857,00 | 108 | 1 |
| | 0940283 | 200x100cm inbouw links | wit | BA200BEL2MLV01 | stuk | 2069,00 | 108 | 1 |
| | 0940284 | 200x100cm inbouw links | pergamon | BA200BEL2MLV09 | stuk | 2069,00 | 108 | 1 |
| | 0940285 | 200x100cm inbouw rechts | wit | BA200BEL2MRV01 | stuk | 2069,00 | 108 | 1 |
| | 0940286 | 200x100cm inbouw rechts | pergamon | BA200BEL2MRV09 | stuk | 2069,00 | 108 | 1 |
| | 0940287 | 200x100cm wanduitvoering | wit | BA200BEL2MMV01 | stuk | 2175,00 | 108 | 1 |
| | 0940288 | 200x100cm wanduitvoering | pergamon | BA200BEL2MMV09 | stuk | 2175,00 | 108 | 1 |
| | 0940289 | 200x100cm nisuitvoering | wit | BA200BEL2MNV01 | stuk | 1963,00 | 108 | 1 |
| | 0940290 | 200x100cm nisuitvoering | pergamon | BA200BEL2MNV09 | stuk | 1963,00 | 108 | 1 |
| | 0940291 | 200x100cm vrijstaand | wit | BA200BEL2MFV01 | stuk | 2281,00 | 108 | 1 |
| | 0940292 | 200x100cm vrijstaand | pergamon | BA200BEL2MFV09 | stuk | 2281,00 | 108 | 1 |
| | 0940293 | 200x100cm vrijstaand m. houtpaneel | wit | BA200BEL2MHV01 | stuk | 3448,00 | 108 | 1 |
| | 0940294 | 200x100cm vrijstaand m. houtpaneel | pergamon | BA200BEL2MHV09 | stuk | 3448,00 | 108 | 1 |
| | Badkamermeubelen en toiletkasten | badinstallatie set compleet | | | | | | |
| 0940295 | | | | PSB200BEL2 | stuk | 311,00 | 108 | 1 |
| Gootstenen en wastroggen | Villeroy & Boch Century | | | | | | | |
| | kunststof bad acryl | | | | | | | |
| | 0947202 | 180x80cm z. poten | wit | BA180CEN9V01 | stuk | 1485,00 | 108 | 1 |
| | 0947210 | 180x80cm z. poten | pergamon | BA180CEN9V09 | stuk | 1485,00 | 108 | 1 |
| | 0949639 | badpoten voor Villeroy & Boch acryl bad | | 4000000266 | stuk | 14,00 | 108 | 0 |
| Utiliteit | Villeroy & Boch Ceta | | | | | | | |
| | kunststof bad quarry ovaal | | | | | | | |
| | 0944807 | 175x75cm vrijstaand m. poten | wit | BQ175CEA7V01 | stuk | 2079,00 | 108 | 1 |
| | 0944815 | 175x75cm vrijstaand m. poten | pergamon | BQ175CEA7V09 | stuk | 2079,00 | 108 | 1 |
| | 0944823 | 175x75cm vrijstaand m. poten | klassiek wit | BQ175CEA7V29 | stuk | 2079,00 | 108 | 1 |
| | 0944831 | 175x75cm vrijstaand m. poten | yellow | BQ175CEA7VC0 | stuk | 2368,00 | 108 | 1 |
| | 0944858 | 175x75cm vrijstaand m. poten | blauw | BQ175CEA7VE0 | stuk | 2368,00 | 108 | 1 |
| | 0944866 | afvoer/overloopcombinatie voor bad 175cm | chrom | 99300061 | stuk | 385,00 | 108 | 1 |
| | 0944874 | afvoer/overloopcombinatie | messing | 99300066 | stuk | 477,00 | 108 | 1 |
| | Villeroy & Boch Cetus | | | | | | | |
| | kunststof bad quarry ovaal | | | | | | | |
| | 0944572 | 175x75cm m. poten | wit | BQ175CEU7V01 | stuk | 952,00 | 108 | 1 |
| | 0944580 | 175x75cm m. poten | pergamon | BQ175CEU7V09 | stuk | 952,00 | 108 | 1 |
| | 0944793 | 175x75cm m. poten | klassiek wit | BQ175CEU7V29 | stuk | 952,00 | 108 | 1 |
| | 0944906 | 190x80cm m. poten | wit | BQ190CEU7V01 | stuk | 1326,00 | 108 | 1 |
| | 0949221 | 190x80cm m. poten | pergamon | BQ190CEU7V09 | stuk | 1326,00 | 108 | 1 |
| | badinstallatieset polystyreen | | | | | | | |
| | 0949418 | 175cm | | PSB175CEU7 | stuk | 461,00 | 108 | 1 |
| | 0949426 | 190cm | | PSB190CEU7 | stuk | 461,00 | 108 | 1 |

| Art.nr | Specificaties | Kleur | Lev.nr | Ehd | Prijs | Grp | CC | | | | |
|---|---|--------------|----------------|------|---------|-----|----|---|---|--|--|
| | | | | | | | | Villeroy & Boch Cetus | | | |
| kunststof bad quaryl zeshoekig | | | | | | | | | | | |
| 0948403 | 210x100cm m. poten | wit | BQ210CEU6V01 | stuk | 2099,00 | 108 | 1 |  | Sanitair producten | | |
| 0948411 | 210x100cm m. poten | pergamon | BQ210CEU6V09 | stuk | 2099,00 | 108 | 1 | | | | |
| 0948438 | 210x100cm m. poten | klassiek wit | BQ210CEU6V29 | stuk | 2099,00 | 108 | 1 | | | | |
| kunststof bad quaryl rechthoekig | | | | | | | | | | | |
| 0949978 | 170x75cm m. poten | wit | BQ170CEU2V01 | stuk | 683,00 | 108 | 1 |  | Baden / douchebakken / stoomcabines | | |
| 0949979 | 170x75cm m. poten | pergamon | BQ170CEU2V09 | stuk | 683,00 | 108 | 1 | | | | |
| 0949980 | 180x80cm m. poten | wit | BQ180CEU2V01 | stuk | 823,00 | 108 | 1 |  | Kranen | | |
| 0949981 | 180x80cm m. poten | pergamon | BQ180CEU2V09 | stuk | 823,00 | 108 | 1 | | | | |
| | | | | | | | | Villeroy & Boch Colorado | | | |
| kunststof bad acryl rechthoekig | | | | | | | | | | | |
| 0945366 | 200x120cm z. poten | wit | BA200COL2V01 | stuk | 2565,00 | 108 | 1 |  | Douchegarnituur | | |
| 0945374 | 200x120cm z. poten | pergamon | BA200COL2V09 | stuk | 2565,00 | 108 | 1 | | | | |
| 0945382 | 200x120cm z. poten | klassiek wit | BA200COL2V29 | stuk | 2565,00 | 108 | 1 | | | | |
| 0949639 | badpoten voor Villeroy & Boch acryl bad | | 4000000266 | stuk | 14,00 | 108 | 0 | | Accessoires en spiegels | | |
| | | | | | | | | Villeroy & Boch Epura | | | |
| kunststof bad acryl rechthoekig | | | | | | | | | | | |
| 0945309 | 180x80cm z. poten | wit | BA180EPU2V01 | stuk | 1194,00 | 108 | 1 |  | Douchewanden | | |
| 0947261 | 180x80cm z. poten | pergamon | BA180EPU2V09 | stuk | 1194,00 | 108 | 1 | | | | |
| 0949639 | badpoten voor Villeroy & Boch acryl bad | | 4000000266 | stuk | 14,00 | 108 | 0 | | | | |
| | | | | | | | | Villeroy & Boch Ingo | | | |
| kunststof bad acryl | | | | | | | | | | | |
| 0946354 | 150x100cm afgeschuind rechts z. poten | wit | BA150ING3REV01 | stuk | 822,00 | 108 | 1 |  | Toebehoren & afvoeren | | |
| 0946362 | 150x100cm afgeschuind rechts z. poten | pergamon | BA150ING3REV09 | stuk | 822,00 | 108 | 1 | | | | |
| 0946370 | 150x100cm afgeschuind rechts z. poten | klassiek wit | BA150ING3REV29 | stuk | 822,00 | 108 | 1 | | | | |
| 0949639 | badpoten voor Villeroy & Boch acryl bad | | 4000000266 | stuk | 14,00 | 108 | 0 | | | | |
| kunststof voorpaneel | | | | | | | | | | | |
| 0946372 | rechts | wit | BPA15001PR301 | stuk | 547,00 | 108 | 1 |  | Spoe- & installatiesystemen | | |
| 0946374 | rechts | pergamon | BPA15001PR309 | stuk | 547,00 | 108 | 1 | | | | |
| 0946376 | rechts | klassiek wit | BPA15001PR329 | stuk | 547,00 | 108 | 1 | | | | |
| kunststof bad acryl | | | | | | | | | | | |
| 0946311 | 150x100cm afgeschuind links z. poten | wit | BA150ING3LIV01 | stuk | 822,00 | 108 | 1 |  | Badkamermeubelen en toiletkasten | | |
| 0946338 | 150x100cm afgeschuind links z. poten | pergamon | BA150ING3LIV09 | stuk | 822,00 | 108 | 1 | | | | |
| 0946346 | 150x100cm afgeschuind links z. poten | klassiek wit | BA150ING3LIV29 | stuk | 822,00 | 108 | 1 | | | | |
| 0949639 | badpoten voor Villeroy & Boch acryl bad | | 4000000266 | stuk | 14,00 | 108 | 0 | | | | |
| kunststof voorpaneel | | | | | | | | | | | |
| 0946389 | links | wit | BPA15001PL301 | stuk | 547,00 | 108 | 1 |  | Gootstenen en wastroggen | | |
| 0946397 | links | pergamon | BPA15001PL309 | stuk | 547,00 | 108 | 1 | | | | |
| 0946400 | links | klassiek wit | BPA15001PL329 | stuk | 547,00 | 108 | 1 | | | | |
| | | | | | | | | Villeroy & Boch Isar | | | |
| kunststof bad acryl rechthoekig | | | | | | | | | | | |
| 0940208 | 170x80cm z. poten | wit | BA170ISA2V01 | stuk | 542,00 | 108 | 1 |  | Utiliteit | | |
| 0941085 | 170x80cm z. poten | pergamon | BA170ISA2V09 | stuk | 542,00 | 108 | 1 | | | | |
| 0943592 | 170x80cm z. poten | klassiek wit | BA170ISA2V29 | stuk | 542,00 | 108 | 1 | | | | |
| 0949639 | badpoten voor Villeroy & Boch acryl bad | | 4000000266 | stuk | 14,00 | 108 | 0 | | | | |
| | | | | | | | | Villeroy & Boch Libra | | | |
| kunststof bad quaryl rechthoekig | | | | | | | | | | | |
| 0949982 | 160x70cm m. poten | wit | BQ167LIB2V01 | stuk | 530,00 | 108 | 1 |  | | | |
| 0949983 | 160x70cm m. poten | pergamon | BQ167LIB2V09 | stuk | 530,00 | 108 | 1 | | | | |
| 0943401 | 170x75cm m. poten | wit | BQ170LIB2V01 | stuk | 530,00 | 108 | 0 | | | | |
| 0943428 | 170x75cm m. poten | pergamon | BQ170LIB2V09 | stuk | 530,00 | 108 | 0 | | | | |
| 0943444 | 170x75cm m. poten | klassiek wit | BQ170LIB2V29 | stuk | 530,00 | 108 | 1 | | | | |
| 0948276 | 180x80cm m. poten | wit | BQ180LIB2V01 | stuk | 705,00 | 108 | 0 | | | | |
| 0948584 | 180x80cm m. poten | pergamon | BQ180LIB2V09 | stuk | 705,00 | 108 | 1 | | | | |
| 0948292 | 180x80cm m. poten | klassiek wit | BQ180LIB2V29 | stuk | 705,00 | 108 | 1 | | | | |
| set grepen Libra voor BQ170/180 | | | | | | | | | | | |
| 0947903 | | chrom | 99250161 | stuk | 138,00 | 108 | 1 | | | | |

| | Art.nr | Specificaties | Kleur | Lev.nr | Ehd | Prijs | Grp | CC | |
|---|---|---|--------------------------------|--------------------|----------------|--------------|---------|--------|-----|
| Sanitair producten | Villeroy & Boch LuXXus | | | | | | | | |
| | kunststof hoekbad quaryl inbouw | | | | | | | | |
| | 0940296 | 190x190cm | wit | BQ145LUX3V01 | stuk | 3356,00 | 108 | 1 | |
| | 0940297 | 190x190cm | pergamon | BQ145LUX3V09 | stuk | 3356,00 | 108 | 1 | |
| Baden / douchebakken / stoomcabines | kunststof hoekbad quaryl | | | | | | | | |
| | 0940305 | 190x190cm | m. badpaneel teakhout | wit | BQ145LUX3LHV01 | stuk | 6712,00 | 108 | 1 |
| | 0940306 | 190x190cm | m. badpaneel teakhout | pergamon | BQ145LUX3LHV09 | stuk | 6712,00 | 108 | 1 |
| | 0940307 | 190x190cm | m. badpaneel aluminium | wit | BQ145LUX3LUV01 | stuk | 5896,00 | 108 | 1 |
| | 0940308 | 190x190cm | m. badpaneel aluminium | pergamon | BQ145LUX3LUV09 | stuk | 5896,00 | 108 | 1 |
| | 0940309 | 190x190cm | m. badpaneel kalksteen | wit | BQ145LUX3LSV01 | stuk | 6712,00 | 108 | 1 |
| Kranen | 0940310 | 190x190cm | m. badpaneel kalksteen | pergamon | BQ145LUX3LSV09 | stuk | 6712,00 | 108 | 1 |
| | hoofdsteun voor bad | | | | | | | | |
| | 0940311 | | pure grey | 90090600QG | stuk | 198,00 | 108 | 1 | |
| Douchegarnituur | 0940312 | | perl beige | 90090600QB | stuk | 198,00 | 108 | 1 | |
| Accessoires en spiegels | Villeroy & Boch Magnum | | | | | | | | |
| | kunststof bad quaryl zeshoekig | | | | | | | | |
| | 0944882 | 190x90cm | m. poten | wit | BQ190MAG6V01 | stuk | 1892,00 | 108 | 1 |
| Douchewanden | Villeroy & Boch Meander | | | | | | | | |
| | kunststof bad acryl rechthoekig | | | | | | | | |
| | 0940224 | 170x80cm | z. poten z. grepen | wit | BA170MEA2V01 | stuk | 588,00 | 108 | 1 |
| | 0941158 | 170x80cm | z. poten z. grepen | pergamon | BA170MEA2V09 | stuk | 588,00 | 108 | 1 |
| | 0943622 | 170x80cm | z. poten z. grepen | klassiek wit | BA170MEA2V29 | stuk | 588,00 | 108 | 1 |
| | 0941131 | 170x80cm | z. poten z. grepen | manhattan | BA170MEA2V15 | stuk | 588,00 | 108 | 1 |
| | 0940232 | 170x80cm | z. poten z. grepen | edelweiss | BA170MEA2V41 | stuk | 676,00 | 108 | 1 |
| | 0940240 | 170x80cm | z. poten m. greepvoorbereiding | wit | BA170MEA2HGV01 | stuk | 588,00 | 108 | 1 |
| | 0941115 | 170x80cm | z. poten m. greepvoorbereiding | pergamon | BA170MEA2HGV09 | stuk | 588,00 | 108 | 1 |
| | 0943606 | 170x80cm | z. poten m. greepvoorbereiding | klassiek wit | BA170MEA2HGV29 | stuk | 588,00 | 108 | 1 |
| | 0941999 | 180x90cm | z. poten z. grepen | wit | BA180MEA2V01 | stuk | 762,00 | 108 | 1 |
| | 0942677 | 180x90cm | z. poten z. grepen | pergamon | BA180MEA2V09 | stuk | 762,00 | 108 | 1 |
| | Toebehoren & afvoeren | 0943630 | 180x90cm | z. poten z. grepen | klassiek wit | BA180MEA2V29 | stuk | 762,00 | 108 |
| 0941905 | | 180x90cm | z. poten m. greepvoorbereiding | wit | BA180MEA2HGV01 | stuk | 762,00 | 108 | 1 |
| 0942634 | | 180x90cm | z. poten m. greepvoorbereiding | pergamon | BA180MEA2HGV09 | stuk | 762,00 | 108 | 1 |
| 0943614 | | 180x90cm | z. poten m. greepvoorbereiding | klassiek wit | BA180MEA2HGV29 | stuk | 762,00 | 108 | 1 |
| 0949639 | | badpoten voor Villeroy & Boch acryl bad | | | 4000000266 | stuk | 14,00 | 108 | 0 |
| Spoel- & installatiesystemen | | set badgrepen voor BA170/180 | | | | | | | |
| | 0948241 | | chromm | 91360061 | stuk | 133,00 | 108 | 1 | |
| Badkamermeubelen en toiletkasten | Villeroy & Boch Nagano | | | | | | | | |
| | kunststof bad quaryl rechthoekig | | | | | | | | |
| | 0948330 | 160x70cm | m. poten | wit | BQ160NAG2V01 | stuk | 1074,00 | 108 | 1 |
| | 0948349 | 160x70cm | m. poten | pergamon | BQ160NAG2V09 | stuk | 1074,00 | 108 | 1 |
| | 0948357 | 160x70cm | m. poten | klassiek wit | BQ160NAG2V29 | stuk | 1074,00 | 108 | 1 |
| Gootstenen en wastroggen | Villeroy & Boch NewWave | | | | | | | | |
| | kunststof bad acryl rechthoekig | | | | | | | | |
| | 0940352 | 170x70cm | z. poten | wit | BA177WNW2V01 | stuk | 966,00 | 108 | 1 |
| | 0940353 | 170x70cm | z. poten | pergamon | BA177WNW2V09 | stuk | 966,00 | 108 | 1 |
| | 0940355 | 180x80cm | z. poten | wit | BA180WNW2V01 | stuk | 1040,00 | 108 | 1 |
| | 0940356 | 180x80cm | z. poten | pergamon | BA180WNW2V09 | stuk | 1040,00 | 108 | 1 |
| | 0940358 | 190x90cm | z. poten | wit | BA199WNW2V01 | stuk | 1134,00 | 108 | 1 |
| | 0940359 | 190x90cm | z. poten | pergamon | BA199WNW2V09 | stuk | 1134,00 | 108 | 1 |
| | 0949639 | badpoten voor Villeroy & Boch acryl bad | | | 4000000266 | stuk | 14,00 | 108 | 0 |
| | Utiliteit | kunststof bad acryl ovaal | | | | | | | |
| 0940361 | | 180x80cm | z. poten | wit | BA180WNW7V01 | stuk | 1313,00 | 108 | 1 |
| 0940362 | | 180x80cm | z. poten | pergamon | BA180WNW7V09 | stuk | 1313,00 | 108 | 1 |
| | 0949639 | badpoten voor Villeroy & Boch acryl bad | | | 4000000266 | stuk | 14,00 | 108 | 0 |

| Art.nr | Specificaties | Kleur | Lev.nr | Ehd | Prijs | Grp | CC |
|--------|---------------|-------|--------|-----|-------|-----|----|
|--------|---------------|-------|--------|-----|-------|-----|----|

Villeroy & Boch NewWave

kunststof bad acryl zeshoekig

| | | | | | | | |
|---------|---|----------|---------------|------|---------|-----|---|
| 0940364 | 190x90cm z. poten | wit | BA199WNNW6V01 | stuk | 1313,00 | 108 | 1 |
| 0940365 | 190x90cm z. poten | pergamon | BA199WNNW6V09 | stuk | 1313,00 | 108 | 1 |
| 0949639 | badpoten voor Villeroy & Boch acryl bad | | 4000000266 | stuk | 14,00 | 108 | 0 |



Sanitair producten

Baden /
douchebakken /
stoomcabines

badinstallatie set compleet voor 170cm

| | | | | | | | |
|---------|--|--|-------------|------|--------|-----|---|
| 0940354 | | | PSB177WNNW2 | stuk | 311,00 | 108 | 1 |
|---------|--|--|-------------|------|--------|-----|---|

Kranen

badinstallatie set compleet voor 180cm

| | | | | | | | |
|---------|--|--|-------------|------|--------|-----|---|
| 0940357 | | | PSB180WNNW2 | stuk | 311,00 | 108 | 1 |
|---------|--|--|-------------|------|--------|-----|---|

Douchegarnituur

badinstallatie set compleet voor 190cm

| | | | | | | | |
|---------|--|--|-------------|------|--------|-----|---|
| 0940360 | | | PSB199WNNW2 | stuk | 311,00 | 108 | 1 |
|---------|--|--|-------------|------|--------|-----|---|

badinstallatie set compleet voor ovaal

| | | | | | | | |
|---------|--|--|-------------|------|--------|-----|---|
| 0940363 | | | PSB180WNNW7 | stuk | 311,00 | 108 | 1 |
|---------|--|--|-------------|------|--------|-----|---|

Accessoires en
spiegels

badinstallatie set compleet voor zeshoek

| | | | | | | | |
|---------|--|--|-------------|------|--------|-----|---|
| 0940366 | | | PSB199WNNW6 | stuk | 311,00 | 108 | 1 |
|---------|--|--|-------------|------|--------|-----|---|

Douchewanden

Villeroy & Boch Nexion

kunststof bad quaryl ovaal

| | | | | | | | |
|---------|------------------------------|-----|----------------|------|---------|-----|---|
| 0948446 | 180x80cm m. paneel en afvoer | wit | BQ180NE07APV01 | stuk | 1962,00 | 108 | 1 |
|---------|------------------------------|-----|----------------|------|---------|-----|---|

Toebehoren &
afvoeren

Villeroy & Boch Nexus

kunststof bad quaryl ovaal

| | | | | | | | |
|---------|-------------------|----------|--------------|------|---------|-----|---|
| 0948454 | 180x80cm m. poten | wit | BQ180NEU7V01 | stuk | 1502,00 | 108 | 1 |
| 0948462 | 180x80cm m. poten | pergamon | BQ180NEU7V09 | stuk | 1502,00 | 108 | 1 |

Spoel- &
installatiesystemen

Villeroy & Boch Oberon

kunststof bad quaryl rechthoekig

| | | | | | | | |
|---------|-------------------|--------------|--------------|------|--------|-----|---|
| 0949984 | 170x70cm m. poten | wit | BQ1770BE2V01 | stuk | 506,00 | 108 | 1 |
| 0949985 | 170x70cm m. poten | pergamon | BQ1770BE2V09 | stuk | 506,00 | 108 | 1 |
| 0944912 | 170x75cm m. poten | wit | BQ1700BE2V01 | stuk | 506,00 | 108 | 0 |
| 0944920 | 170x75cm m. poten | pergamon | BQ1700BE2V09 | stuk | 506,00 | 108 | 1 |
| 0944939 | 170x75cm m. poten | klassiek wit | BQ1700BE2V29 | stuk | 506,00 | 108 | 1 |
| 0948306 | 180x80cm m. poten | wit | BQ1800BE2V01 | stuk | 641,00 | 108 | 0 |
| 0948314 | 180x80cm m. poten | pergamon | BQ1800BE2V09 | stuk | 641,00 | 108 | 1 |
| 0948322 | 180x80cm m. poten | klassiek wit | BQ1800BE2V29 | stuk | 641,00 | 108 | 1 |
| 0940313 | 190x90cm m. poten | wit | BQ1990BE2V01 | stuk | 792,00 | 108 | 1 |
| 0940314 | 190x90cm m. poten | pergamon | BQ1990BE2V09 | stuk | 792,00 | 108 | 1 |

Badkamermeubelen
en toiletkastenGootstenen en
wastroggen

Utiliteit

Villeroy & Boch Omnia Architectura

kunststof bad acryl rechthoekig

| | | | | | | | |
|---------|---|----------|--------------|------|--------|-----|---|
| 0940413 | 170x75cm z. poten | wit | BA170ARA2V01 | stuk | 340,00 | 108 | 1 |
| 0940414 | 170x75cm z. poten | pergamon | BA170ARA2V09 | stuk | 340,00 | 108 | 1 |
| 0940415 | 170x80cm z. poten | wit | BA178ARA2V01 | stuk | 360,00 | 108 | 1 |
| 0940416 | 170x80cm z. poten | pergamon | BA178ARA2V09 | stuk | 360,00 | 108 | 1 |
| 0940417 | 180x80cm z. poten | wit | BA180ARA2V01 | stuk | 385,00 | 108 | 1 |
| 0940418 | 180x80cm z. poten | pergamon | BA180ARA2V09 | stuk | 385,00 | 108 | 1 |
| 0940419 | 190x90cm z. poten | wit | BA199ARA2V01 | stuk | 425,00 | 108 | 1 |
| 0940420 | 190x90cm z. poten | pergamon | BA199ARA2V09 | stuk | 425,00 | 108 | 1 |
| 0949639 | badpoten voor Villeroy & Boch acryl bad | | 4000000266 | stuk | 14,00 | 108 | 0 |



Villeroy & Boch Pavia

kunststof bad quaryl rechthoekig

| | | | | | | | |
|---------|-------------------|--------------|--------------|------|--------|-----|---|
| 0945056 | 170x75cm m. poten | wit | BQ170PAV2V01 | stuk | 572,00 | 108 | 1 |
| 0945064 | 170x75cm m. poten | pergamon | BQ170PAV2V09 | stuk | 572,00 | 108 | 1 |
| 0945072 | 170x75cm m. poten | klassiek wit | BQ170PAV2V29 | stuk | 572,00 | 108 | 1 |



| | Art.nr | Specificaties | Kleur | Lev.nr | Ehd | Prijs | Grp | CC |
|---|---------|---|--------------|----------------|------|---------|-----|----|
| Villeroy & Boch Pavia | | | | | | | | |
| kunststof bad quarry | | | | | | | | |
| Sanitair producten | 0948764 | 180x80cm m. poten | wit | BQ180PAV2V01 | stuk | 726,00 | 108 | 1 |
| | 0948772 | 180x80cm m. poten | pergamon | BQ180PAV2V09 | stuk | 726,00 | 108 | 1 |
| | 0948780 | 180x80cm m. poten | klassiek wit | BQ180PAV2V29 | stuk | 726,00 | 108 | 1 |
| Villeroy & Boch Parana | | | | | | | | |
| kunststof bad acryl rechthoekig | | | | | | | | |
| Baden / douchebakken / stoomcabines | 0948489 | 170x75cm z. poten | wit | BA170PAR2V01 | stuk | 393,00 | 108 | 0 |
| | 0948497 | 170x75cm z. poten | pergamon | BA170PAR2V09 | stuk | 393,00 | 108 | 1 |
| | 0948500 | 170x75cm z. poten | klassiek wit | BA170PAR2V29 | stuk | 393,00 | 108 | 1 |
| Kranen | 0948519 | 180x80cm z. poten | wit | BA180PAR2V01 | stuk | 442,00 | 108 | 0 |
| | 0948527 | 180x80cm z. poten | pergamon | BA180PAR2V09 | stuk | 442,00 | 108 | 0 |
| | 0949213 | 180x80cm z. poten | klassiek wit | BA180PAR2V29 | stuk | 442,00 | 108 | 1 |
| | 0948535 | 190x90cm z. poten | wit | BA190PAR2V01 | stuk | 492,00 | 108 | 1 |
| Douchegarnituur | 0948543 | 190x90cm z. poten | pergamon | BA190PAR2V09 | stuk | 492,00 | 108 | 1 |
| | 0948551 | 190x90cm z. poten | klassiek wit | BA190PAR2V29 | stuk | 492,00 | 108 | 1 |
| | 0949639 | badpoten voor Villeroy & Boch acryl bad | | 4000000266 | stuk | 14,00 | 108 | 0 |
| kunststof bad acryl afgeschuind | | | | | | | | |
| Accessoires en spiegels | 0948691 | 170x90cm links z. poten | wit | BA170PAR3LIV01 | stuk | 617,00 | 108 | 1 |
| | 0948705 | 170x90cm links z. poten | pergamon | BA170PAR3LIV09 | stuk | 617,00 | 108 | 1 |
| | 0948713 | 170x90cm links z. poten | klassiek wit | BA170PAR3LIV29 | stuk | 617,00 | 108 | 1 |
| | 0948721 | 170x90cm rechts z. poten | wit | BA170PAR3REV01 | stuk | 617,00 | 108 | 1 |
| Douchewanden | 0948748 | 170x90cm rechts z. poten | pergamon | BA170PAR3REV09 | stuk | 617,00 | 108 | 1 |
| | 0948756 | 170x90cm rechts z. poten | klassiek wit | BA170PAR3REV29 | stuk | 617,00 | 108 | 1 |
| | 0949639 | badpoten voor Villeroy & Boch acryl bad | | 4000000266 | stuk | 14,00 | 108 | 0 |
| kunststof bad acryl ovaal | | | | | | | | |
| Toebehoren & afvoeren | 0948578 | 180x80cm z. poten | wit | BA180PAR7V01 | stuk | 638,00 | 108 | 1 |
| | 0948586 | 180x80cm z. poten | pergamon | BA180PAR7V09 | stuk | 638,00 | 108 | 1 |
| | 0948594 | 180x80cm z. poten | klassiek wit | BA180PAR7V29 | stuk | 638,00 | 108 | 1 |
| | 0949639 | badpoten voor Villeroy & Boch acryl bad | | 4000000266 | stuk | 14,00 | 108 | 0 |
| badinstallatieset polystyreen | | | | | | | | |
| Spoel- & installatiesystemen | 0949566 | 180cm | | PSB180PAR7 | stuk | 461,00 | 108 | 1 |
| kunststof bad acryl zeshoekig | | | | | | | | |
| Badkamermeubelen en toiletkasten | 0948632 | 190x80cm z. poten | wit | BA190PAR6V01 | stuk | 638,00 | 108 | 1 |
| | 0948640 | 190x80cm z. poten | pergamon | BA190PAR6V09 | stuk | 638,00 | 108 | 1 |
| | 0948659 | 190x80cm z. poten | klassiek wit | BA190PAR6V29 | stuk | 638,00 | 108 | 1 |
| | 0940315 | 200x90cm z. poten | wit | BA200PAR6V01 | stuk | 697,00 | 108 | 1 |
| Gootstenen en wastroggen | 0940316 | 200x90cm z. poten | pergamon | BA200PAR6V09 | stuk | 697,00 | 108 | 1 |
| | 0949639 | badpoten voor Villeroy & Boch acryl bad | | 4000000266 | stuk | 14,00 | 108 | 0 |
| kunststof hoekbad acryl | | | | | | | | |
| Utiliteit | 0948667 | 135x135cm m. paneel m. frame | wit | BA135PAR3LPV01 | stuk | 1320,00 | 108 | 1 |
| | 0948675 | 135x135cm m. paneel m. frame | pergamon | BA135PAR3LPV09 | stuk | 1320,00 | 108 | 1 |
| | 0948683 | 135x135cm m. paneel m. frame | klassiek wit | BA135PAR3LPV29 | stuk | 1320,00 | 108 | 1 |
| | 0948608 | 135x135cm z. paneel z. poten | wit | BA135PAR3V01 | stuk | 736,00 | 108 | 1 |
| | 0948616 | 135x135cm z. paneel z. poten | pergamon | BA135PAR3V09 | stuk | 736,00 | 108 | 1 |
| | 0948624 | 135x135cm z. paneel z. poten | klassiek wit | BA135PAR3V29 | stuk | 736,00 | 108 | 1 |
| | 0949639 | badpoten voor Villeroy & Boch acryl bad | | 4000000266 | stuk | 14,00 | 108 | 0 |
| Villeroy & Boch Riante | | | | | | | | |
| kunststof bad acryl zeshoekig | | | | | | | | |
| | 0946273 | 205x80cm z. poten | wit | BA205RIA6V01 | stuk | 1059,00 | 108 | 1 |
| | 0946281 | 205x80cm z. poten | pergamon | BA205RIA6V09 | stuk | 1059,00 | 108 | 1 |
| | 0946303 | 205x80cm z. poten | klassiek wit | BA205RIA6V29 | stuk | 1059,00 | 108 | 1 |
| | 0949639 | badpoten voor Villeroy & Boch acryl bad | | 4000000266 | stuk | 14,00 | 108 | 0 |
| Villeroy & Boch Riogrande | | | | | | | | |
| kunststof bad acryl rechthoekig | | | | | | | | |
| | 0945919 | 200x150cm z. poten | wit | BA200RI09V01 | stuk | 3794,00 | 108 | 1 |
| | 0945927 | 200x150cm z. poten | pergamon | BA200RI09V09 | stuk | 3794,00 | 108 | 1 |
| | 0945935 | 200x150cm z. poten | klassiek wit | BA200RI09V29 | stuk | 3794,00 | 108 | 1 |
| | 0949639 | badpoten voor Villeroy & Boch acryl bad | | 4000000266 | stuk | 14,00 | 108 | 0 |
| afvoer- / overloopcombinatie | | | | | | | | |
| | 0941485 | | chromm | 99100061 | stuk | 246,00 | 108 | 1 |

| Art.nr | Specificaties | Kleur | Lev.nr | Ehd | Prijs | Grp | CC |
|--------|---------------|-------|--------|-----|-------|-----|----|
|--------|---------------|-------|--------|-----|-------|-----|----|

Villeroy & Boch Royale Hommage

kunststof bad acryl ovaal

| | | | | | | | | |
|---------|----------|---------------------|-----------------|--------------|------|---------|-----|---|
| 0945595 | 170x76cm | vrijstaand m. poten | wit/chroom | BA170HOM9V01 | stuk | 4259,00 | 108 | 1 |
| 0945609 | 170x76cm | vrijstaand m. poten | perg./chroom | BA170HOM9V09 | stuk | 4259,00 | 108 | 1 |
| 0945617 | 170x76cm | vrijstaand m. poten | klas.wit/chroom | BA170HOM9V29 | stuk | 4259,00 | 108 | 1 |



Sanitair producten

Baden /
douchebakken /
stoomcabines

Villeroy & Boch Saar

kunststof bad acryl zeshoekig

| | | | | | | | | |
|---------|---|----------|--------------|--------------|------|--------|-----|---|
| 0946214 | 190x90cm | z. poten | wit | BA190SAA6V01 | stuk | 817,00 | 108 | 1 |
| 0946222 | 190x90cm | z. poten | pergamon | BA190SAA6V09 | stuk | 817,00 | 108 | 1 |
| 0946230 | 190x90cm | z. poten | klassiek wit | BA190SAA6V29 | stuk | 817,00 | 108 | 1 |
| 0949639 | badpoten voor Villeroy & Boch acryl bad | | | 4000000266 | stuk | 14,00 | 108 | 0 |



Kranen

Villeroy & Boch Sagitta

kunststof bad quaryl zeshoekig

| | | | | | | | | |
|---------|----------|----------|--------------|--------------|------|---------|-----|---|
| 0945080 | 190x90cm | m. poten | wit | BQ190SAG6V01 | stuk | 1876,00 | 108 | 1 |
| 0945099 | 190x90cm | m. poten | pergamon | BQ190SAG6V09 | stuk | 1876,00 | 108 | 1 |
| 0945102 | 190x90cm | m. poten | klassiek wit | BQ190SAG6V29 | stuk | 1876,00 | 108 | 1 |



Douchegarnituur

Villeroy & Boch Sagrada

kunststof bad quaryl zeshoekig

| | | | | | | | | |
|---------|----------|----------|--------------|--------------|------|--------|-----|---|
| 0945110 | 170x75cm | m. poten | wit | BQ170SAR6V01 | stuk | 825,00 | 108 | 1 |
| 0945129 | 170x75cm | m. poten | pergamon | BQ170SAR6V09 | stuk | 825,00 | 108 | 1 |
| 0945137 | 170x75cm | m. poten | klassiek wit | BQ170SAR6V29 | stuk | 825,00 | 108 | 1 |



Accessoires en
spiegels

Douchewanden

Villeroy & Boch Sentique

kunststof bad acryl rechthoekig

| | | | | | | | | |
|---------|---|----------|----------|--------------|------|--------|-----|---|
| 0940421 | 170x70cm | z. poten | wit | BA177SEE2V01 | stuk | 545,00 | 108 | 1 |
| 0940423 | 170x70cm | z. poten | pergamon | BA177SEE2V09 | stuk | 545,00 | 108 | 1 |
| 0940424 | 180x80cm | z. poten | wit | BA180SEE2V01 | stuk | 595,00 | 108 | 1 |
| 0940425 | 180x80cm | z. poten | pergamon | BA180SEE2V09 | stuk | 595,00 | 108 | 1 |
| 0949639 | badpoten voor Villeroy & Boch acryl bad | | | 4000000266 | stuk | 14,00 | 108 | 0 |



Toebehoren &
afvoeren

Villeroy & Boch Seine

kunststof bad acryl rechthoekig

| | | | | | | | | |
|---------|---|----------|--------------|--------------|------|---------|-----|---|
| 0942103 | 170x75cm | z. poten | wit | BA170SEI2V01 | stuk | 764,00 | 108 | 1 |
| 0942766 | 170x75cm | z. poten | pergamon | BA170SEI2V09 | stuk | 764,00 | 108 | 1 |
| 0943711 | 170x75cm | z. poten | klassiek wit | BA170SEI2V29 | stuk | 764,00 | 108 | 1 |
| 0940410 | 180x80cm | z. poten | wit | BA180SEI2V01 | stuk | 935,00 | 108 | 1 |
| 0941328 | 180x80cm | z. poten | pergamon | BA180SEI2V09 | stuk | 935,00 | 108 | 1 |
| 0943738 | 180x80cm | z. poten | klassiek wit | BA180SEI2V29 | stuk | 935,00 | 108 | 1 |
| 0941301 | 180x80cm | z. poten | manhattan | BA180SEI2V15 | stuk | 935,00 | 108 | 1 |
| 0940429 | 180x80cm | z. poten | edelweiss | BA180SEI2V41 | stuk | 1075,00 | 108 | 1 |
| 0940437 | 185x90cm | z. poten | wit | BA185SEI2V01 | stuk | 1171,00 | 108 | 1 |
| 0941344 | 185x90cm | z. poten | pergamon | BA185SEI2V09 | stuk | 1171,00 | 108 | 1 |
| 0943746 | 185x90cm | z. poten | klassiek wit | BA185SEI2V29 | stuk | 1171,00 | 108 | 1 |
| 0940445 | 185x90cm | z. poten | edelweiss | BA185SEI2V41 | stuk | 1347,00 | 108 | 1 |
| 0949639 | badpoten voor Villeroy & Boch acryl bad | | | 4000000266 | stuk | 14,00 | 108 | 0 |



Spoel- &
installatiesystemen

Badkamermeubelen
en toiletkasten

Gootstenen en
wastroggen

Utiliteit

Villeroy & Boch Spica

kunststof bad quaryl rechthoekig

| | | | | | | | | |
|---------|----------|----------|--------------|--------------|------|---------|-----|---|
| 0945145 | 180x80cm | m. poten | wit | BQ180SPI2V01 | stuk | 1081,00 | 108 | 1 |
| 0945153 | 180x80cm | m. poten | pergamon | BQ180SPI2V09 | stuk | 1081,00 | 108 | 1 |
| 0945161 | 180x80cm | m. poten | klassiek wit | BQ180SPI2V29 | stuk | 1081,00 | 108 | 1 |



Villeroy & Boch Squaro

kunststof bad quaryl rechthoekig

| | | | | | | | | |
|---------|----------|----------|----------|--------------|------|--------|-----|---|
| 0940426 | 170x75cm | m. poten | wit | BQ170SQR2V01 | stuk | 645,00 | 108 | 1 |
| 0940431 | 170x75cm | m. poten | pergamon | BQ170SQR2V09 | stuk | 645,00 | 108 | 1 |
| 0940432 | 180x80cm | m. poten | wit | BQ180SQR2V01 | stuk | 695,00 | 108 | 1 |
| 0940433 | 180x80cm | m. poten | pergamon | BQ180SQR2V09 | stuk | 695,00 | 108 | 1 |



Villeroy & Boch Subway

kunststof bad acryl rechthoekig

| | | | | | | | | |
|---------|---|----------|----------|--------------|------|--------|-----|---|
| 0123226 | 170x75cm | z. poten | wit | BA170SUB2V01 | stuk | 583,00 | 108 | 1 |
| 0123232 | 170x75cm | z. poten | pergamon | BA170SUB2V09 | stuk | 583,00 | 108 | 1 |
| 0123229 | 180x80cm | z. poten | wit | BA180SUB2V01 | stuk | 638,00 | 108 | 0 |
| 0123235 | 180x80cm | z. poten | pergamon | BA180SUB2V09 | stuk | 638,00 | 108 | 1 |
| 0940317 | 190x90cm | z. poten | wit | BA199SUB2V01 | stuk | 691,00 | 108 | 1 |
| 0940318 | 190x90cm | z. poten | pergamon | BA199SUB2V09 | stuk | 691,00 | 108 | 1 |
| 0949639 | badpoten voor Villeroy & Boch acryl bad | | | 4000000266 | stuk | 14,00 | 108 | 0 |



| | Art.nr | Specificaties | Kleur | Lev.nr | Ehd | Prijs | Grp | CC |
|---|---|---|----------------|----------------|---------|---------|-----|----|
| | Villeroy & Boch Sunberry | | | | | | | |
| | kunststof bad acryl rechthoekig | | | | | | | |
| Sanitair producten | 0940319 | 170x70cm z. poten | wit | BA177SUR2V01 | stuk | 563,00 | 108 | 1 |
| | 0940320 | 170x70cm z. poten | pergamon | BA177SUR2V09 | stuk | 563,00 | 108 | 1 |
| | 0940327 | 170x75cm z. poten | wit | BA170SUR2V01 | stuk | 563,00 | 108 | 1 |
| Baden / douchebakken / stoomcabines | 0940337 | 170x75cm z. poten | pergamon | BA170SUR2V09 | stuk | 563,00 | 108 | 1 |
| | 0940344 | 180x80cm z. poten | wit | BA180SUR2V01 | stuk | 616,00 | 108 | 1 |
| | 0940345 | 180x80cm z. poten | pergamon | BA180SUR2V09 | stuk | 616,00 | 108 | 1 |
| | 0949639 | badpoten voor Villeroy & Boch acryl bad | | 4000000266 | stuk | 14,00 | 108 | 0 |
| | kunststof bad acryl rechthoekig m. frame | | | | | | | |
| Kranen | 0940321 | 170x70cm m. frontpaneel | wit | BA177SUR2PFV01 | stuk | 718,00 | 108 | 1 |
| | 0940322 | 170x70cm m. frontpaneel | pergamon | BA177SUR2PFV09 | stuk | 718,00 | 108 | 1 |
| | 0940323 | 170x70cm m. front-/ eindpaneel | wit | BA177SUR2PCV01 | stuk | 873,00 | 108 | 1 |
| | 0940324 | 170x70cm m. front-/ eindpaneel | pergamon | BA177SUR2PCV09 | stuk | 873,00 | 108 | 1 |
| | 0940325 | 170x70cm m. front-/2x eindpaneel | wit | BA177SUR2PWW01 | stuk | 1029,00 | 108 | 1 |
| Douchegarnituur | 0940326 | 170x70cm m. front-/2x eindpaneel | pergamon | BA177SUR2PWW09 | stuk | 1029,00 | 108 | 1 |
| | 0940338 | 170x75cm m. frontpaneel | wit | BA170SUR2PFV01 | stuk | 718,00 | 108 | 1 |
| | 0940339 | 170x75cm m. frontpaneel | pergamon | BA170SUR2PFV09 | stuk | 718,00 | 108 | 1 |
| | 0940340 | 170x75cm m. front-/ eindpaneel | wit | BA170SUR2PCV01 | stuk | 873,00 | 108 | 1 |
| Accessoires en spiegels | 0940341 | 170x75cm m. front-/ eindpaneel | pergamon | BA170SUR2PCV09 | stuk | 873,00 | 108 | 1 |
| | 0940342 | 170x75cm m. front-/2x eindpaneel | wit | BA170SUR2PWW01 | stuk | 1029,00 | 108 | 1 |
| | 0940343 | 170x75cm m. front-/2x eindpaneel | pergamon | BA170SUR2PWW09 | stuk | 1029,00 | 108 | 1 |
| Douchewanden | 0940346 | 180x80cm m. frontpaneel | wit | BA180SUR2PFV01 | stuk | 772,00 | 108 | 1 |
| | 0940347 | 180x80cm m. frontpaneel | pergamon | BA180SUR2PFV09 | stuk | 772,00 | 108 | 1 |
| | 0940348 | 180x80cm m. front-/ eindpaneel | wit | BA180SUR2PCV01 | stuk | 927,00 | 108 | 1 |
| | 0940349 | 180x80cm m. front-/ eindpaneel | pergamon | BA180SUR2PCV09 | stuk | 927,00 | 108 | 1 |
| | 0940350 | 180x80cm m. front-/2x eindpaneel | wit | BA180SUR2PWW01 | stuk | 1082,00 | 108 | 1 |
| 0940351 | 180x80cm m. front-/2x eindpaneel | pergamon | BA180SUR2PWW09 | stuk | 1082,00 | 108 | 1 | |
| | Villeroy & Boch Taurus | | | | | | | |
| | set grepen Taurus | | | | | | | |
| Toebehoren & afvoeren | 0947881 | | granito-grijs | 889000C01 | stuk | 122,00 | 108 | 1 |
| | 0947873 | | granito-beige | 889000C02 | stuk | 122,00 | 108 | 1 |
| | Villeroy & Boch Tucana | | | | | | | |
| | kunststof bad quaryl | | | | | | | |
| Spoel- & installatiesystemen | 0945293 | 160x75cm afgeschuind rechts m. poten | wit | BQ160TUC3REV01 | stuk | 566,00 | 108 | 1 |
| | 0945307 | 160x75cm afgeschuind rechts m. poten | pergamon | BQ160TUC3REV09 | stuk | 566,00 | 108 | 1 |
| | 0945315 | 160x75cm afgeschuind rechts m. poten | klassiek wit | BQ160TUC3REV29 | stuk | 566,00 | 108 | 1 |
| | 0945269 | 160x75cm afgeschuind links m. poten | wit | BQ160TUC3LIV01 | stuk | 566,00 | 108 | 1 |
| | 0945277 | 160x75cm afgeschuind links m. poten | pergamon | BQ160TUC3LIV09 | stuk | 566,00 | 108 | 1 |
| Badkamermeubelen en toiletkasten | 0945285 | 160x75cm afgeschuind links m. poten | klassiek wit | BQ160TUC3LIV29 | stuk | 566,00 | 108 | 1 |
| | | | | | | | | |
| | Villeroy & Boch Toebehoren | | | | | | | |
| Gootstenen en wastroggen | 0949639 | badpoten voor Villeroy & Boch acryl bad | | 4000000266 | stuk | 14,00 | 108 | 0 |
| | 0941486 | badpoten voor acryl bad m. ongelijke bodem | | 4000000256 | stuk | 14,00 | 108 | 1 |
| Utiliteit | 0949996 | hoofdkussen voor bad | | 9009060000 | stuk | 113,00 | 108 | 1 |
| | 0940434 | hoofdsteun zwart | | 9009061001 | stuk | 146,00 | 108 | 1 |
| | 0940435 | hoofdsteun lichtgrijs | | 9009061000 | stuk | 146,00 | 108 | 1 |
| | 0100123 | reparatieset acryl transparant | | 921700000000 | stuk | 35,75 | 108 | 1 |
| | 0100124 | reparatieset quaryl wit | | 921800000060 | stuk | 30,75 | 139 | 1 |
| | 0944866 | afvoer/overloopcombinatie voor bad 175cm chroom | | 99300061 | stuk | 385,00 | 108 | 1 |
| | 0944874 | afvoer/overloopcombinatie messing | | 99300066 | stuk | 477,00 | 108 | 1 |

| Art.nr | Specificaties | Kleur | Lev.nr | Ehd | Prijs | Grp | CC |
|---------|--|-------|-------------|------|--------|-----|----|
| 0100125 | afstandsbediening whisper combipool + luxe | | 4000000910K | stuk | 150,00 | 139 | 1 |
| 0100126 | afstandsbediening whisper airpool | | 4000000911K | stuk | 125,00 | 139 | 1 |
| 0100127 | afstandsbediening whisper whirlpool | | 4000000912K | stuk | 125,00 | 139 | 1 |
| 0100128 | afstandsbediening whisper air luxe | | 4000000913K | stuk | 150,00 | 139 | 1 |
| 0100129 | afstandsbediening clairpool | | 4000000914K | stuk | 125,00 | 139 | 1 |
| 0100130 | afstandsbediening clairpool luxe | | 4000000915K | stuk | 150,00 | 139 | 1 |
| 0100131 | afstandsbediening whisper whirlpool luxe | | 4000000916K | stuk | 125,00 | 139 | 1 |
| 0100133 | afstandsbediening twirlpool | | 4000000018 | stuk | 125,00 | 139 | 1 |
| 0100134 | afstandsbediening cleanpool + kliktoets | | 33280007967 | stuk | 150,00 | 139 | 1 |

Sanitair producten

Baden /
douchebakken /
stoomcabines

Kranen

Douchegarnituur

Accessoires en
spiegels

Douchewanden

Toebehoren &
afvoerenSpoel- &
installatiesystemenBadkamermeubelen
en toiletkastenGootstenen en
wastroggen

Utiliteit

| | Art.nr | Specificaties | Kleur | Lev.nr | Ehd | Prijs | Grp | CC |
|--|---|------------------------------|-----------------|-----------------|--------|--------|-----|----|
| Villeroy & Boch Avansis | | | | | | | | |
| Sanitair producten | kunststof douchebak quaryl vierkant | | | | | | | |
| | 0944149 | 80x80x8cm m. steun z. paneel | wit | DQ0808AVA1V01 | stuk | 337,00 | 108 | 1 |
| | 0944157 | 80x80x8cm m. steun z. paneel | pergamon | DQ0808AVA1V09 | stuk | 337,00 | 108 | 1 |
| | 0944165 | 80x80x8cm m. steun z. paneel | klassiek wit | DQ0808AVA1V29 | stuk | 337,00 | 108 | 1 |
| | 0944173 | 80x80x8cm m. steun m. paneel | wit | DQ0808AVA1LPV01 | stuk | 433,00 | 108 | 1 |
| | 0944181 | 80x80x8cm m. steun m. paneel | pergamon | DQ0808AVA1LPV09 | stuk | 433,00 | 108 | 1 |
| | 0944203 | 80x80x8cm m. steun m. paneel | klassiek wit | DQ0808AVA1LPV29 | stuk | 433,00 | 108 | 1 |
| | 0944084 | 90x90x8cm m. steun z. paneel | wit | DQ0908AVA1V01 | stuk | 364,00 | 108 | 1 |
| | 0944092 | 90x90x8cm m. steun z. paneel | pergamon | DQ0908AVA1V09 | stuk | 364,00 | 108 | 1 |
| | 0944106 | 90x90x8cm m. steun z. paneel | klassiek wit | DQ0908AVA1V29 | stuk | 364,00 | 108 | 1 |
| Kranen | 0944114 | 90x90x8cm m. steun m. paneel | wit | DQ0908AVA1LPV01 | stuk | 457,00 | 108 | 1 |
| | 0944122 | 90x90x8cm m. steun m. paneel | pergamon | DQ0908AVA1LPV09 | stuk | 457,00 | 108 | 1 |
| | 0944130 | 90x90x8cm m. steun m. paneel | klassiek wit | DQ0908AVA1LPV29 | stuk | 457,00 | 108 | 1 |
| kunststof douchebak quaryl kwart rond | | | | | | | | |
| Douchegarnituur | 0944211 | 80x80x8cm m. steun z. paneel | wit | DQ0808AVA4V01 | stuk | 582,00 | 108 | 1 |
| | 0944238 | 80x80x8cm m. steun z. paneel | pergamon | DQ0808AVA4V09 | stuk | 582,00 | 108 | 1 |
| | 0944246 | 80x80x8cm m. steun z. paneel | klassiek wit | DQ0808AVA4V29 | stuk | 582,00 | 108 | 1 |
| | 0944254 | 80x80x8cm m. steun m. paneel | wit | DQ0808AVA4LPV01 | stuk | 684,00 | 108 | 1 |
| Accessoires en spiegels | 0944262 | 80x80x8cm m. steun m. paneel | pergamon | DQ0808AVA4LPV09 | stuk | 684,00 | 108 | 1 |
| | 0944270 | 80x80x8cm m. steun m. paneel | klassiek wit | DQ0808AVA4LPV29 | stuk | 684,00 | 108 | 1 |
| | 0944289 | 90x90x8cm m. steun z. paneel | wit | DQ0908AVA4V01 | stuk | 633,00 | 108 | 1 |
| | 0944297 | 90x90x8cm m. steun z. paneel | pergamon | DQ0908AVA4V09 | stuk | 633,00 | 108 | 1 |
| Douchewanden | 0944300 | 90x90x8cm m. steun z. paneel | klassiek wit | DQ0908AVA4V29 | stuk | 633,00 | 108 | 1 |
| | 0944319 | 90x90x8cm m. steun m. paneel | wit | DQ0908AVA4LPV01 | stuk | 736,00 | 108 | 1 |
| | 0944327 | 90x90x8cm m. steun m. paneel | pergamon | DQ0908AVA4LPV09 | stuk | 736,00 | 108 | 1 |
| 0944335 | 90x90x8cm m. steun m. paneel | klassiek wit | DQ0908AVA4LPV29 | stuk | 736,00 | 108 | 1 | |
| kunststof douchebak quaryl vijfhoekig | | | | | | | | |
| Toebehoren & afvoeren | 0944343 | 90x90x8cm m. steun z. paneel | wit | DQ0908AVA5V01 | stuk | 633,00 | 108 | 1 |
| | 0944351 | 90x90x8cm m. steun z. paneel | pergamon | DQ0908AVA5V09 | stuk | 633,00 | 108 | 1 |
| | 0944378 | 90x90x8cm m. steun z. paneel | klassiek wit | DQ0908AVA5V29 | stuk | 633,00 | 108 | 1 |
| | 0944386 | 90x90x8cm m. steun m. paneel | wit | DQ0908AVA5LPV01 | stuk | 736,00 | 108 | 1 |
| Spoel- & installatiesystemen | 0944394 | 90x90x8cm m. steun m. paneel | pergamon | DQ0908AVA5LPV09 | stuk | 736,00 | 108 | 1 |
| | 0944408 | 90x90x8cm m. steun m. paneel | klassiek wit | DQ0908AVA5LPV29 | stuk | 736,00 | 108 | 1 |
| Villeroy & Boch Century | | | | | | | | |
| Badkamermeubelen en toiletkasten | kunststof douchebak acryl vierkant | | | | | | | |
| | 0940243 | 90x90x6cm | wit | DA0906CEN1V01 | stuk | 469,00 | 108 | 1 |
| | 0947172 | 90x90x8,5cm | pergamon | DA0906CEN1V09 | stuk | 469,00 | 108 | 1 |
| 0360635 | douchebaksteun m. 5 verstelbare poten 125-195mm | | 5SGS | stuk | 33,00 | 062 | 0 | |
| Villeroy & Boch Cumulus | | | | | | | | |
| Gootstenen en wastroggen | kunststof douchebak quaryl rechthoekig | | | | | | | |
| | 0943282 | 90x80x6cm m. steun | wit | DQ08906CUM2V01 | stuk | 395,00 | 108 | 1 |
| | 0943290 | 90x80x6cm m. steun | pergamon | DQ08906CUM2V09 | stuk | 395,00 | 108 | 1 |
| 0943940 | 90x80x6cm m. steun | klassiek wit | DQ8906CUM2V29 | stuk | 395,00 | 108 | 1 | |
| kunststof douchebak quaryl vierkant | | | | | | | | |
| Utiliteit | 0949986 | 90x90x6cm m. steun | wit | DQ0906CUM1V01 | stuk | 375,00 | 108 | 1 |
| | 0949987 | 90x90x6cm m. steun | pergamon | DQ0906CUM1V09 | stuk | 375,00 | 108 | 1 |
| | 0944440 | 100x100x6cm m. steun | wit | DQ1006CUM1V01 | stuk | 497,00 | 108 | 1 |
| | 0944459 | 100x100x6cm m. steun | pergamon | DQ1006CUM1V09 | stuk | 497,00 | 108 | 1 |
| | 0944467 | 100x100x6cm m. steun | klassiek wit | DQ1006CUM1V29 | stuk | 497,00 | 108 | 1 |

Art.nr Specificaties Kleur Lev.nr Ehd Prijs Grp CC

Villeroy & Boch Cumulus

kunststof douchebak quaryl vijfhoekig

| | | | | | | | | |
|---------|-------------|----------|--------------|---------------|------|--------|-----|---|
| 0944416 | 100x100x6cm | m. steun | wit | DQ1006CUM5V01 | stuk | 719,00 | 108 | 1 |
| 0944424 | 100x100x6cm | m. steun | pergamon | DQ1006CUM5V09 | stuk | 719,00 | 108 | 1 |
| 0944432 | 100x100x6cm | m. steun | klassiek wit | DQ1006CUM5V29 | stuk | 719,00 | 108 | 1 |



Sanitair producten

Baden /
douchebakken /
stoomcabines

kunststof douchebak quaryl kwartrond

| | | | | | | | | |
|---------|-----------|----------|----------|---------------|------|--------|-----|---|
| 0949988 | 90x90x6cm | m. steun | wit | DQ0906CUM4V01 | stuk | 543,00 | 108 | 1 |
| 0949989 | 90x90x6cm | m. steun | pergamon | DQ0906CUM4V09 | stuk | 543,00 | 108 | 1 |



Kranen

Douchegarnituur

Villeroy & Boch Futurion

kunststof douchebak quaryl vierkant

| | | | | | | | | |
|---------|--------------------------|----------|--------------|---------------|------|--------|-----|---|
| 0948810 | 80x80x6cm | z. steun | wit | DQ0806FUT1V01 | stuk | 292,00 | 108 | 1 |
| 0948829 | 80x80x6cm | z. steun | pergamon | DQ0806FUT1V09 | stuk | 292,00 | 108 | 1 |
| 0948837 | 80x80x6cm | z. steun | klassiek wit | DQ0806FUT1V29 | stuk | 292,00 | 108 | 1 |
| 0948845 | 90x90x6cm | z. steun | wit | DQ0906FUT1V01 | stuk | 292,00 | 108 | 0 |
| 0948853 | 90x90x6cm | z. steun | pergamon | DQ0906FUT1V09 | stuk | 292,00 | 108 | 1 |
| 0948861 | 90x90x6cm | z. steun | klassiek wit | DQ0906FUT1V29 | stuk | 292,00 | 108 | 1 |
| 0948888 | 100x100x6cm | z. steun | wit | DQ1006FUT1V01 | stuk | 378,00 | 108 | 0 |
| 0948896 | 100x100x6cm | z. steun | pergamon | DQ1006FUT1V09 | stuk | 378,00 | 108 | 1 |
| 0948918 | 100x100x6cm | z. steun | klassiek wit | DQ1006FUT1V29 | stuk | 378,00 | 108 | 1 |
| 0949205 | onderstel voor douchebak | | | 82990000 | stuk | 44,00 | 108 | 1 |



Accessoires en
spiegels

Douchewanden

Toebehoren &
afvoeren

kunststof douchebak quaryl kwartrond

| | | | | | | | | |
|---------|--------------------------|--------------------|--------------|-----------------|------|--------|-----|---|
| 0949140 | 90x90x18cm | m. paneel m. frame | wit | DQ0906FUT4PFV01 | stuk | 577,00 | 108 | 1 |
| 0949159 | 90x90x18cm | m. paneel m. frame | pergamon | DQ0906FUT4PFV09 | stuk | 577,00 | 108 | 1 |
| 0949167 | 90x90x18cm | m. paneel m. frame | klassiek wit | DQ0906FUT4PFV29 | stuk | 577,00 | 108 | 1 |
| 0949175 | 100x100x18 | m. paneel m. frame | wit | DQ1006FUT4PFV01 | stuk | 748,00 | 108 | 1 |
| 0949183 | 100x100x18 | m. paneel m. frame | pergamon | DQ1006FUT4PFV09 | stuk | 748,00 | 108 | 1 |
| 0949191 | 100x100x18 | m. paneel m. frame | klassiek wit | DQ1006FUT4PFV29 | stuk | 748,00 | 108 | 1 |
| 0949019 | 90x90x6cm | z. steun | wit | DQ0906FUT4V01 | stuk | 485,00 | 108 | 1 |
| 0949027 | 90x90x6cm | z. steun | pergamon | DQ0906FUT4V09 | stuk | 485,00 | 108 | 1 |
| 0949035 | 90x90x6cm | z. steun | klassiek wit | DQ0906FUT4V29 | stuk | 485,00 | 108 | 1 |
| 0949043 | 100x100x6cm | z. steun | wit | DQ1006FUT4V01 | stuk | 635,00 | 108 | 1 |
| 0949051 | 100x100x6cm | z. steun | pergamon | DQ1006FUT4V09 | stuk | 635,00 | 108 | 1 |
| 0949078 | 100x100x6cm | z. steun | klassiek wit | DQ1006FUT4V29 | stuk | 635,00 | 108 | 1 |
| 0949205 | onderstel voor douchebak | | | 82990000 | stuk | 44,00 | 108 | 1 |

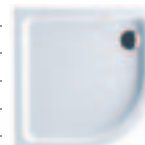

Spoel- &
installatiesystemen

Badkamermeubelen
en toiletkasten

Gootstenen en
wastroggen

kunststof douchebak quaryl vijfhoekig

| | | | | | | | | |
|---------|--------------------------|----------|--------------|---------------|------|--------|-----|---|
| 0949086 | 90x90x6cm | z. steun | wit | DQ0906FUT5V01 | stuk | 485,00 | 108 | 1 |
| 0949094 | 90x90x6cm | z. steun | pergamon | DQ0906FUT5V09 | stuk | 485,00 | 108 | 1 |
| 0949108 | 90x90x6cm | z. steun | klassiek wit | DQ0906FUT5V29 | stuk | 485,00 | 108 | 1 |
| 0949116 | 100x100x6cm | z. steun | wit | DQ1006FUT5V01 | stuk | 635,00 | 108 | 1 |
| 0949124 | 100x100x6cm | z. steun | pergamon | DQ1006FUT5V09 | stuk | 635,00 | 108 | 1 |
| 0949132 | 100x100x6cm | z. steun | klassiek wit | DQ1006FUT5V29 | stuk | 635,00 | 108 | 1 |
| 0949205 | onderstel voor douchebak | | | 82990000 | stuk | 44,00 | 108 | 1 |

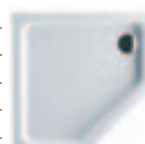

Utiliteit

kunststof douchebak quaryl rechthoekig

| | | | | | | | | |
|---------|--|----------|--------------|---------------|------|--------|-----|---|
| 0948926 | 90x75x6cm | z. steun | wit | DQ9706FUT2V01 | stuk | 340,00 | 108 | 1 |
| 0948934 | 90x75x6cm | z. steun | pergamon | DQ9706FUT2V09 | stuk | 340,00 | 108 | 1 |
| 0948942 | 90x75x6cm | z. steun | klassiek wit | DQ9706FUT2V29 | stuk | 340,00 | 108 | 1 |
| 0948950 | 90x80x6cm | z. steun | wit | DQ9806FUT2V01 | stuk | 340,00 | 108 | 1 |
| 0948969 | 90x80x6cm | z. steun | pergamon | DQ9806FUT2V09 | stuk | 340,00 | 108 | 1 |
| 0948977 | 90x80x6cm | z. steun | klassiek wit | DQ9806FUT2V29 | stuk | 340,00 | 108 | 1 |
| 0940367 | 100x80x6cm | z. steun | wit | DQ1806FUT2V01 | stuk | 431,00 | 108 | 1 |
| 0940368 | 100x80x6cm | z. steun | pergamon | DQ1806FUT2V09 | stuk | 431,00 | 108 | 1 |
| 0949990 | 120x80cm | z. steun | wit | DQ1286FUT2V01 | stuk | 497,00 | 108 | 1 |
| 0949991 | 120x80cm | z. steun | pergamon | DQ1286FUT2V09 | stuk | 497,00 | 108 | 1 |
| 0948985 | 120x90x6cm | z. steun | wit | DQ1296FUT2V01 | stuk | 497,00 | 108 | 1 |
| 0948993 | 120x90x6cm | z. steun | pergamon | DQ1296FUT2V09 | stuk | 497,00 | 108 | 1 |
| 0949248 | 120x90x6cm | z. steun | klassiek wit | DQ1296FUT2V29 | stuk | 497,00 | 108 | 1 |
| 0940370 | 150x100x6cm | z. steun | wit | DQ1516FUT2V01 | stuk | 650,00 | 108 | 1 |
| 0940371 | 150x100x6cm | z. steun | pergamon | DQ1516FUT2V09 | stuk | 650,00 | 108 | 1 |
| 0940373 | polystyreen ondersteuning voor 150x100x6cm | | | PSD51162 | stuk | 150,00 | 108 | 1 |



| | Art.nr | Specificaties | Kleur | Lev.nr | Ehd | Prijs | Grp | CC |
|---|---|---|--------------|-----------------|-------|--------|-----|----|
| Villeroy & Boch Futurion | | | | | | | | |
| Sanitair producten | onderstel voor douchebak | | | | | | | |
| | 0949205 | | | 82990000 | stuk | 44,00 | 108 | 1 |
| polystyreen ondersteuning voor 100x80x6cm | | | | | | | | |
| | 0940369 | | | PSD18162 | stuk | 86,00 | 108 | 1 |
| polystyreen ondersteuning voor 150x100x6cm | | | | | | | | |
| | 0940373 | | | PSD51162 | stuk | 150,00 | 108 | 1 |
| Villeroy & Boch Geos | | | | | | | | |
| kunststof douchebak acryl kwartrond | | | | | | | | |
| Kranen | 0947490 | 100x100x6 z. paneel | wit | DA1006GE04V01 | stuk | 354,00 | 108 | 1 |
| | 0947504 | 100x100x6 z. paneel | pergamon | DA1006GE04V09 | stuk | 354,00 | 108 | 1 |
| | 0947512 | 100x100x6 z. paneel | klassiek wit | DA1006GE04V29 | stuk | 354,00 | 108 | 1 |
| | 0947520 | 100x100x19 m. paneel m. frame | wit | DA1006GE04PFV01 | stuk | 495,00 | 108 | 1 |
| | 0947539 | 100x100x19 m. paneel m. frame | pergamon | DA1006GE04PFV09 | stuk | 495,00 | 108 | 1 |
| Douchegarnituur | 0947547 | 100x100x19 m. paneel m. frame | klassiek wit | DA1006GE04PFV29 | stuk | 495,00 | 108 | 1 |
| | 0946605 | 90x90x6cm z. paneel | wit | DA0906GE04V01 | stuk | 260,00 | 108 | 1 |
| Accessoires en spiegels | 0946613 | 90x90x6cm z. paneel | pergamon | DA0906GE04V09 | stuk | 260,00 | 108 | 1 |
| | 0946621 | 90x90x6cm z. paneel | klassiek wit | DA0906GE04V29 | stuk | 260,00 | 108 | 1 |
| | 0946648 | 90x90x19cm m. paneel m. frame | wit | DA0906GE04PFV01 | stuk | 399,00 | 108 | 1 |
| Douchewanden | 0946656 | 90x90x19cm m. paneel m. frame | pergamon | DA0906GE04PFV09 | stuk | 399,00 | 108 | 1 |
| | 0946664 | 90x90x19cm m. paneel m. frame | klassiek wit | DA0906GE04PFV29 | stuk | 399,00 | 108 | 1 |
| | 0360635 | douchebaksteun m. 5 verstelbare poten 125-195mm | | 5SGS | stuk | 33,00 | 062 | 0 |
| kunststof douchebak acryl vierkant | | | | | | | | |
| Toebehoren & afvoeren | 0949994 | 80x80x6cm | wit | DA0806GE01V01 | stuk | 260,00 | 108 | 1 |
| | 0949997 | 80x80x6cm | pergamon | DA0806GE01V09 | stuk | 260,00 | 108 | 1 |
| | 0946443 | 90x90x6cm | wit | DA0906GE01V01 | stuk | 260,00 | 108 | 0 |
| | 0946451 | 90x90x6cm | pergamon | DA0906GE01V09 | stuk | 260,00 | 108 | 1 |
| | 0946478 | 90x90x6cm | klassiek wit | DA0906GE01V29 | stuk | 260,00 | 108 | 1 |
| Spoel- & installatiesystemen | 0947423 | 100x100x6 z. paneel | wit | DA1006GE01V01 | stuk | 354,00 | 108 | 1 |
| | 0947431 | 100x100x6 z. paneel | pergamon | DA1006GE01V09 | stuk | 354,00 | 108 | 1 |
| | 0947458 | 100x100x6 z. paneel | klassiek wit | DA1006GE01V29 | stuk | 354,00 | 108 | 1 |
| | 0947466 | 100x100x19 m. paneel m. frame | wit | DA1006GE01PFV01 | stuk | 494,00 | 108 | 1 |
| | 0947474 | 100x100x19 m. paneel m. frame | pergamon | DA1006GE01PFV09 | stuk | 494,00 | 108 | 1 |
| Badkamermeubelen en toiletkasten | 0947482 | 100x100x19 m. paneel m. frame | klassiek wit | DA1006GE01PFV29 | stuk | 494,00 | 108 | 1 |
| | 0360635 | douchebaksteun m. 5 verstelbare poten 125-195mm | | 5SGS | stuk | 33,00 | 062 | 0 |
| kunststof douchebak acryl rechthoekig | | | | | | | | |
| Gootstenen en wastroggen | 0950291 | 90x75x6cm | wit | DA9706GE02V01 | stuk | 284,00 | 108 | 1 |
| | 0950292 | 90x75x6cm | pergamon | DA9706GE02V09 | stuk | 284,00 | 108 | 1 |
| | 0950293 | 90x80x6cm | wit | DA9806GE02V01 | stuk | 296,00 | 108 | 1 |
| | 0950294 | 90x80x6cm | pergamon | DA9806GE02V09 | stuk | 296,00 | 108 | 1 |
| | 0949992 | 120x80x6cm | wit | DA1286GE02V01 | stuk | 354,00 | 108 | 1 |
| Utiliteit | 0949993 | 120x80x6cm | pergamon | DA1286GE02V09 | stuk | 354,00 | 108 | 1 |
| | 0360635 | douchebaksteun m. 5 verstelbare poten 125-195mm | | 5SGS | stuk | 33,00 | 062 | 0 |
| | kunststof douchebak acryl vijfhoekig | | | | | | | |
| | 0947636 | 90x90x6cm z. paneel | wit | DA9006GE05V01 | stuk | 260,00 | 108 | 1 |
| | 0947644 | 90x90x6cm z. paneel | pergamon | DA9006GE05V09 | stuk | 260,00 | 108 | 1 |
| | 0947652 | 90x90x6cm z. paneel | klassiek wit | DA9006GE05V29 | stuk | 260,00 | 108 | 1 |
| | 0947660 | 90x90x19cm m. paneel m. frame | wit | DA9006GE05PFV01 | stuk | 399,00 | 108 | 1 |
| | 0947679 | 90x90x19cm m. paneel m. frame | pergamon | DA9006GE05PFV09 | stuk | 399,00 | 108 | 1 |
| | 0947687 | 90x90x19cm m. paneel m. frame | klassiek wit | DA9006GE05PFV29 | stuk | 399,00 | 108 | 1 |
| | 0947555 | 100x100x6cm z. paneel | wit | DA1006GE05V01 | stuk | 354,00 | 108 | 1 |
| | 0947563 | 100x100x6cm z. paneel | pergamon | DA1006GE05V09 | stuk | 354,00 | 108 | 1 |
| | 0947571 | 100x100x6cm z. paneel | klassiek wit | DA1006GE05V29 | stuk | 354,00 | 108 | 1 |
| | 0947598 | 100x100x19 m. paneel m. frame | wit | DA1006GE05PFV01 | stuk | 495,00 | 108 | 1 |
| | 0947601 | 100x100x19 m. paneel m. frame | pergamon | DA1006GE05PFV09 | stuk | 495,00 | 108 | 1 |
| | 0947628 | 100x100x19 m. paneel m. frame | klassiek wit | DA1006GE05PFV29 | stuk | 495,00 | 108 | 1 |
| 0360635 | douchebaksteun m. 5 verstelbare poten 125-195mm | | 5SGS | stuk | 33,00 | 062 | 0 | |
| Villeroy & Boch Magnum | | | | | | | | |
| kunststof douchebak quaryl vijfhoekig | | | | | | | | |
| | 0946737 | 90x90x8.7cm z.paneel m. steun | wit | DQ0907MAG5V01 | stuk | 694,00 | 108 | 1 |
| | 0946745 | 90x90x8.7cm z.paneel m. steun | pergamon | DQ0907MAG5V09 | stuk | 694,00 | 108 | 1 |
| | 0946761 | 90x90x17cm m.paneel m. steun | wit | DQ0907MAG5LPV01 | stuk | 794,00 | 108 | 1 |
| | 0946788 | 90x90x17cm m.paneel m. steun | pergamon | DQ0907MAG5LPV09 | stuk | 794,00 | 108 | 1 |

| Art.nr | Specificaties | Kleur | Lev.nr | Ehd | Prijs | Grp | CC |
|--|-------------------------------------|--------------|-----------------|------|--------|-----|----|
| Villeroy & Boch Tucana | | | | | | | |
| kunststof douchebak quaryl vijfhoekig | | | | | | | |
| 0946702 | 80x75x8cm rechts z.paneel m. steun | wit | DQ8708TUC5REV01 | stuk | 378,00 | 108 | 1 |
| 0946705 | 80x75x8cm rechts z.paneel m. steun | pergamon | DQ8708TUC5REV09 | stuk | 378,00 | 108 | 1 |
| 0946708 | 80x75x8cm rechts z.paneel m. steun | klassiek wit | DQ8708TUC5REV29 | stuk | 378,00 | 108 | 1 |
| 0946710 | 80x75x17cm rechts m.paneel m. steun | wit | DQ8708TUC5LRV01 | stuk | 478,00 | 108 | 1 |
| 0946727 | 80x75x17cm rechts m.paneel m. steun | pergamon | DQ8708TUC5LRV09 | stuk | 478,00 | 108 | 1 |
| 0946729 | 80x75x17cm rechts m.paneel m. steun | klassiek wit | DQ8708TUC5LRV29 | stuk | 478,00 | 108 | 1 |
| 0946670 | 80x75x8cm links z.paneel m. steun | wit | DQ8708TUC5LIV01 | stuk | 378,00 | 108 | 1 |
| 0946672 | 80x75x8cm links z.paneel m. steun | pergamon | DQ8708TUC5LIV09 | stuk | 378,00 | 108 | 1 |
| 0946678 | 80x75x8cm links z.paneel m. steun | klassiek wit | DQ8708TUC5LIV29 | stuk | 378,00 | 108 | 1 |
| 0946680 | 80x75x17cm links m.paneel m. steun | wit | DQ8708TUC5LLV01 | stuk | 478,00 | 108 | 1 |
| 0946697 | 80x75x17cm links m.paneel m. steun | pergamon | DQ8708TUC5LLV09 | stuk | 478,00 | 108 | 1 |
| 0946699 | 80x75x17cm links m.paneel m. steun | klassiek wit | DQ8708TUC5LLV29 | stuk | 478,00 | 108 | 1 |



Sanitair producten

Baden /
douchebakken /
stoomcabines

Kranen

Douchegarnituur

Accessoires en
spiegels

Douchewanden

Toebehoren &
afvoerenSpoel- &
installatiesystemenBadkamermeubelen
en toiletkastenGootstenen en
wastroggen

Utiliteit

Multifunctionele douches Duravit

| | Art.nr | Specificaties | Kleur | Lev.nr | Ehd | Prijs | Grp | CC |
|---|---|--|------------|-----------------|------|----------|-----|----|
| | Duravit multifunctionele douchecabines | | | | | | | |
| | multifunctionele douchecabine | | | | | | | |
| Sanitair producten | 0290832 | 180x110x202cm standaard | wit/helder | 730001001001000 | stuk | 19111,00 | 131 | 1 |
| | 0290833 | 180x110x202cm m. 2 speakers | wit/helder | 730001001391000 | stuk | 19430,00 | 131 | 1 |
| | 0290834 | 180x110x202cm m. gekleurd licht | | 730001001401000 | stuk | 20244,00 | 131 | 1 |
| | 0290835 | 180x110x202cm m. acryl inlegelementen | wit/helder | 730001001411000 | stuk | 19111,00 | 131 | 1 |
| Baden / douchebakken / stoomcabines | 0290836 | 180x110x202cm m. speakers m. gekleurd licht | wit/helder | 730001001421000 | stuk | 20563,00 | 131 | 1 |
| | 0290837 | 180x110x202cm m. speakers m. acryl inlegelementen | wit/helder | 730001001431000 | stuk | 19430,00 | 131 | 1 |
| | 0290838 | 180x110x202cm m. gekleurd licht m. inlegelementen | wit/helder | 730001001441000 | stuk | 20244,00 | 131 | 1 |
| | 0290839 | 180x110x202cm speakers, gekleurd licht, inlegelem. | wit/helder | 730001001451000 | stuk | 20563,00 | 131 | 1 |
| Kranen | | | | | | | | |
| Douchegarnituur | | | | | | | | |
| Accessoires en spiegels | | | | | | | | |
| Douchewanden | | | | | | | | |
| Toebehoren & afvoeren | | | | | | | | |
| Spoel- & installatiesystemen | | | | | | | | |
| Badkamermeubelen en toiletkasten | | | | | | | | |
| Gootstenen en wastroggen | | | | | | | | |
| Utiliteit | | | | | | | | |

| Art.nr | Specificaties | Kleur | Lev.nr | Ehd | Prijs | Grp | CC |
|--------|---------------|-------|--------|-----|-------|-----|----|
|--------|---------------|-------|--------|-----|-------|-----|----|

Hoesch Abano Basic

stoomcabine

| | | | | | | | |
|---------|---------------|-------------|-----------------|-----------------|------|---------|-------|
| 0380042 | 90x90x232cm | | chr/wit/helder | B5100010305 | stuk | 5579,00 | 126 1 |
| 0380043 | 90x90x232cm | | chr/wit/helder+ | B5101010305 | stuk | 5859,00 | 126 1 |
| 0380046 | 90x90x232cm | m. speakers | chr/wit/helder | B51000103056871 | stuk | 5824,00 | 126 1 |
| 0380047 | 90x90x232cm | m. speakers | chr/wit/helder+ | B51010103056871 | stuk | 6104,00 | 126 1 |
| 0380040 | 110x110x232cm | | chr/wit/helder | B6100010305 | stuk | 5961,00 | 126 1 |
| 0380041 | 110x110x232cm | | chr/wit/helder+ | B6101010305 | stuk | 6241,00 | 126 1 |
| 0380044 | 110x110x232cm | m. speakers | chr/wit/helder | B61000103056871 | stuk | 6206,00 | 126 1 |
| 0380045 | 110x110x232cm | m. speakers | chr/wit/helder+ | B61010103056871 | stuk | 6486,00 | 126 1 |

Hoesch Abano Mini

900 Maximaal stoomcabine

| | | | | | | | |
|---------|------|-------------------------|-----------------|----------------|------|---------|-------|
| 0383370 | 90cm | m. Tara grepen | wit/helder glas | GT101410010305 | stuk | 8527,00 | 126 1 |
| 0383371 | 90cm | m. Domani grepen | wit/helder glas | GD101410010305 | stuk | 8422,00 | 126 1 |
| 0383372 | 90cm | m. Belle de Jour grepen | wit/helder glas | GB101410010305 | stuk | 8575,00 | 126 1 |
| 0383373 | 90cm | m. Dreamworks grepen | wit/helder glas | GG101410010305 | stuk | 8527,00 | 126 1 |
| 0383374 | 90cm | m. Madison grepen | wit/helder glas | GM101410010305 | stuk | 8575,00 | 126 1 |

1100 Minimaal stoomcabine

| | | | | | | | |
|---------|-------|-------------------------|-----------------|----------------|------|---------|-------|
| 0383375 | 110cm | m. Tara grepen | wit/helder glas | HT101410010305 | stuk | 9661,00 | 126 1 |
| 0383377 | 110cm | m. Domani grepen | wit/helder glas | HD101410010305 | stuk | 9556,00 | 126 1 |
| 0383378 | 110cm | m. Belle de Jour grepen | wit/helder glas | HB101410010305 | stuk | 9720,00 | 126 1 |
| 0383379 | 110cm | m. Dreamworks grepen | wit/helder glas | HG101410010305 | stuk | 9661,00 | 126 1 |
| 0383380 | 110cm | m. Madison grepen | wit/helder glas | HM101410010305 | stuk | 9720,00 | 126 1 |

Hoesch Abano Uno 1300 Nova

1300 Maximaal stoomcabine

| | | | | | | | |
|---------|-------|-------------------------|-----------------|----------------|------|---------|-------|
| 0383381 | 130cm | m. Tara grepen | wit/helder glas | BT100410010305 | stuk | 9748,00 | 126 1 |
| 0383382 | 130cm | m. Domani grepen | wit/helder glas | BD100410010305 | stuk | 9643,00 | 126 1 |
| 0383383 | 130cm | m. Belle de Jour grepen | wit/helder glas | BB100410010305 | stuk | 9765,00 | 126 1 |
| 0383385 | 130cm | m. Dreamworks grepen | wit/helder glas | BG100410010305 | stuk | 9748,00 | 126 1 |
| 0383386 | 130cm | m. Madison grepen | wit/helder glas | BM100410010305 | stuk | 9765,00 | 126 1 |

Hoesch Abano Primo

stoomcabine

| | | | | | | | |
|---------|-------------|----------|------------------|----------------|------|---------|-------|
| 0383279 | 90x90x231 | maximaal | wit/transp./chr. | 32100410010305 | stuk | 5941,00 | 126 1 |
| 0383287 | 110x110x231 | maximaal | wit/transp./chr. | 41100410010305 | stuk | 6935,00 | 126 1 |



stoomcabine voor nis

| | | | | | | | |
|---------|-----------|----------|------------------|----------------|------|---------|-------|
| 0383260 | 90x90x231 | maximaal | wit/transp./chr. | 29100410010305 | stuk | 5941,00 | 126 1 |
|---------|-----------|----------|------------------|----------------|------|---------|-------|

Hoesch Foster

stoomcabine

| | | | | | | | |
|---------|-------------|----------|------------------|----------------|------|----------|-------|
| 0383317 | 120x115x230 | maximaal | wit/transp./chr. | 44100410010305 | stuk | 10045,00 | 126 1 |
| 0383325 | 160x115x230 | maximaal | wit/transp./chr. | 45100410010305 | stuk | 11400,00 | 126 1 |



Sanitair producten

Baden /
douchebakken /
stoomcabines

Kranen

Douchegarnituur

Accessoires en
spiegels

Douchewanden

Toebehoren &
afvoeren

Spoel- &
installatiesystemen

Badkamermeubelen
en toiletkasten

Gootstenen en
wastroggen

Utiliteit

| Art.nr | Specificaties | Kleur | Lev.nr | Ehd | Prijs | Grp | CC |
|--------|---------------|-------|--------|-----|-------|-----|----|
|--------|---------------|-------|--------|-----|-------|-----|----|



Hoesch Mini Nova

stoomcabine

| | | | | | | | |
|---------|-------------|----------|------------------|----------------|------|----------|-------|
| 0383295 | 90x90x240 | maximaal | wit/transp./chr. | 42100410010305 | stuk | 10971,00 | 126 1 |
| 0383309 | 110x110x240 | maximaal | wit/transp./chr. | 43100410010305 | stuk | 11702,00 | 126 1 |



Sanitair producten

Baden /
douchebakken /
stoomcabines

Kranen

Douchegarnituur

Accessoires en
spiegels

Douchewanden

Toebehoren &
afvoeren

Spoel- &
installatiesystemen

Badkamermeubelen
en toiletkasten

Gootstenen en
wastroggen

Utiliteit

| Art.nr | Specificaties | Kleur | Lev.nr | Ehd | Prijs | Grp | CC |
|--------|---------------|-------|--------|-----|-------|-----|----|
|--------|---------------|-------|--------|-----|-------|-----|----|

Huppe Entrada 2000

stoomcabine kwartrond compleet

| | | | | | | | |
|---------|-------------|--------------|--------------|------|---------|-----|---|
| 1030132 | 96x96x228cm | chrom/helder | 972100091321 | stuk | 4557,00 | 281 | 1 |
| 1030140 | 96x96x228cm | wit/helder | 972100055321 | stuk | 4060,00 | 281 | 1 |
| 1030159 | 96x96x228cm | perg./helder | 972100014321 | stuk | 4060,00 | 281 | 1 |

stoomcabine kwartrond compleet m. anti-plaque

| | | | | | | | |
|---------|-------------|--------------|--------------|------|---------|-----|---|
| 0995886 | 96x96x228cm | chrom/helder | 972100091322 | stuk | 4854,00 | 281 | 1 |
| 1030167 | 96x96x228cm | wit/helder | 972100055322 | stuk | 4357,00 | 281 | 1 |
| 1030175 | 96x96x228cm | perg./helder | 972100014322 | stuk | 4357,00 | 281 | 1 |



Sanitair producten

Baden /
douchebakken /
stoomcabines

Kranen

Huppe Entrada 5000

douchecabine kwartrond compleet

| | | | | | | | |
|---------|---|--------------|--------------|------|---------|-----|---|
| 0995894 | 110x110x204cm m. multifunctioneel douchesysteem | wit/wit | 972002055332 | stuk | 5395,00 | 281 | 1 |
| 0995908 | 110x110x204cm m. multifunctioneel douchesysteem | chrom/wit | 972002091332 | stuk | 5768,00 | 281 | 1 |
| 1030183 | 110x110x204cm m. multifunctioneel douchesysteem | wit/zilver | 972002055336 | stuk | 5395,00 | 281 | 1 |
| 1030191 | 110x110x204cm m. multifunctioneel douchesysteem | chrom/zilver | 972002091336 | stuk | 5768,00 | 281 | 1 |

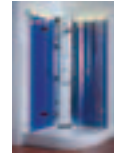

Douchegarnituur

Accessoires en
spiegels

douchecabine vierkant compleet

| | | | | | | | |
|---------|---|--------------|--------------|------|---------|-----|---|
| 0995916 | 110x110x204cm m. multifunctioneel douchesysteem | wit/wit | 972052055332 | stuk | 5395,00 | 281 | 1 |
| 0995924 | 110x110x204cm m. multifunctioneel douchesysteem | chrom/wit | 972052091332 | stuk | 5768,00 | 281 | 1 |
| 1030205 | 110x110x204cm m. multifunctioneel douchesysteem | wit/zilver | 972052055336 | stuk | 5395,00 | 281 | 1 |
| 1030213 | 110x110x204cm m. multifunctioneel douchesysteem | chrom/zilver | 972052091336 | stuk | 5768,00 | 281 | 1 |



Douchewanden

Toebehoren &
afvoeren

Spoel- &
installatiesystemen

Badkamermeubelen
en toiletkasten

Gootstenen en
wastroggen

Utiliteit

| | Art.nr | Specificaties | Kleur | Lev.nr | Ehd | Prijs | Grp | CC | |
|---|--|---------------|------------------|------------|---------|---------|---------|-----|---|
| Sanitair producten | Intersan Thermotub | | | | | | | | |
| | douchecabine m. glijstang m. 1-greepskraan m. gordijn | | | | | | | | |
| | 0900737 | 90x80x200 | wit | ST11/99.22 | stuk | 1104,00 | 356 | 1 | |
| | 0900818 | 90x80x200 | | SA111299 | stuk | 1228,00 | 356 | 1 | |
| Baden / douchebakken / stoomcabines | Intersan Isitub | | | | | | | | |
| | douchecabine m. kraan en gordijn z. slangen | | | | | | | | |
| | 0900656 | 77.5x77.5x193 | wit | EZ2332B00 | stuk | 515,00 | 356 | 0 | |
| | aansluitslang per set | | | | | | | | |
| | 0900443 | 1/2"x160cm | | EF3235 | stuk | 50,00 | 356 | 0 | |
| Kranen | Intersan Sonora | | | | | | | | |
| | douchecabine m. HansaRain kraan | | | | | | | | |
| | 0800041 | 96.5x206.5cm | z. zijspoeiers | wit | S02ALR0 | stuk | 4678,00 | 356 | 1 |
| Douchegarnituur | 0800042 | 96.5x206.5cm | m. 4 zijspoeiers | wit | S02ALR1 | stuk | 5434,00 | 356 | 1 |
| | | | | | | | | | |
| Accessoires en spiegels | | | | | | | | | |
| Douchewanden | | | | | | | | | |
| Toebehoren & afvoeren | | | | | | | | | |
| Spoel- & installatiesystemen | | | | | | | | | |
| Badkamermeubelen en toiletkasten | | | | | | | | | |
| Gootstenen en wastroggen | | | | | | | | | |
| Utiliteit | | | | | | | | | |

| Art.nr | Specificaties | Kleur | Lev.nr | Ehd | Prijs | Grp | CC |
|--------|---------------|-------|--------|-----|-------|-----|----|
|--------|---------------|-------|--------|-----|-------|-----|----|

Riho Majestic

stoomcabine

| | | | | | | | |
|---------|---------------------|-----|-----------------|------|---------|-----|---|
| 0310166 | 90x90x226cm rechts | wit | CA061025203C000 | stuk | 5400,00 | 134 | 1 |
| 0310168 | 90x90x226cm links | wit | CA061025203C001 | stuk | 5400,00 | 134 | 1 |
| 0310170 | 100x90x226cm rechts | wit | CA071025203C000 | stuk | 5500,00 | 134 | 1 |
| 0310172 | 100x90x226cm links | wit | CA071025203C001 | stuk | 5500,00 | 134 | 1 |



Sanitair producten

Baden /
douchebakken /
stoomcabines

Riho Memphis A

stoomcabine kwartrond

| | | | | | | | |
|---------|---------------|----------|-----------------|------|---------|-----|---|
| 0310163 | 100x100x221cm | wit | CE011014002C000 | stuk | 5500,00 | 134 | 1 |
| 0310165 | 100x100x221cm | pergamon | CE012014002C000 | stuk | 5700,00 | 134 | 1 |



Kranen

Riho Memphis B

stoomcabine kwartrond

| | | | | | | | |
|---------|---------------|----------|-----------------|------|---------|-----|---|
| 0310167 | 100x100x230cm | wit | CE021014002C000 | stuk | 5500,00 | 134 | 1 |
| 0310169 | 100x100x230cm | pergamon | CE022014002C000 | stuk | 5700,00 | 134 | 1 |

Douchegarnituur

Riho Madison A

stoomcabine vijfhoekig

| | | | | | | | |
|---------|---------------|----------|-----------------|------|---------|-----|---|
| 0310171 | 100x100x221cm | wit | CE111014002C000 | stuk | 5700,00 | 134 | 1 |
| 0310173 | 100x100x221cm | pergamon | CE112014002C000 | stuk | 5900,00 | 134 | 1 |



Accessoires en
spiegels

Douchewanden

Riho Madison B

stoomcabine vijfhoekig

| | | | | | | | |
|---------|---------------|----------|-----------------|------|---------|-----|---|
| 0310175 | 100x100x230cm | wit | CE121014002C000 | stuk | 5700,00 | 134 | 1 |
| 0310177 | 100x100x230cm | pergamon | CE122014002C000 | stuk | 5900,00 | 134 | 1 |

Toebehoren &
afvoeren

Riho Verona-tech 1

stoomcabine z. deur 1 persoons vijfhoekig

| | | | | | | | |
|---------|-------------------------------------|----------|-----------------|------|---------|-----|---|
| 0310140 | 120x120x234 Prof | wit | CA011017201C000 | stuk | 4850,00 | 134 | 1 |
| 0310142 | 120x120x234 Prof | pergamon | CA012017201C000 | stuk | 5050,00 | 134 | 1 |
| 0310147 | deur voor stoomcabine links chroom | | C00300C000000L | stuk | 1550,00 | 134 | 1 |
| 0310148 | deur voor stoomcabine rechts chroom | | C00300C000000R | stuk | 1550,00 | 134 | 1 |



Spoel- &
installatiesystemen

Badkamermeubelen
en toiletkasten

Riho Verona-tech 2

stoomcabine z. deur 2 persoons vijfhoekig

| | | | | | | | |
|---------|-------------------------------------|----------|-----------------|------|---------|-----|---|
| 0310144 | 141x141x234 Prof | wit | CA021017201C000 | stuk | 5275,00 | 134 | 1 |
| 0310146 | 141x141x234 Prof | pergamon | CA022017201C000 | stuk | 5475,00 | 134 | 1 |
| 0310147 | deur voor stoomcabine links chroom | | C00300C000000L | stuk | 1550,00 | 134 | 1 |
| 0310148 | deur voor stoomcabine rechts chroom | | C00300C000000R | stuk | 1550,00 | 134 | 1 |

Gootstenen en
wastroggen

deur voor stoomcabine

| | | | | | | | |
|---------|--------|--------|----------------|------|---------|-----|---|
| 0310147 | links | chroom | C00300C000000L | stuk | 1550,00 | 134 | 1 |
| 0310148 | rechts | chroom | C00300C000000R | stuk | 1550,00 | 134 | 1 |

Utiliteit

| | Art.nr | Specificaties | Kleur | Lev.nr | Ehd | Prijs | Grp | CC |
|---|------------------------------------|-------------------|-----------------|--------------|------|----------|-----|----|
| | Sphinx Wellness Pluvia | | | | | | | |
| | 100 stoomcabine 1-persoons | | | | | | | |
| Sanitair producten | 0332895 | 106.5x106.5x232 | wit/helder glas | S8PL7910201 | stuk | 9634,00 | 383 | 1 |
| | 0332909 | 106.5x106.5x232 | metallic/helder | S8PL7910501 | stuk | 10837,00 | 383 | 1 |
| | 130 stoomcabine 2-persoons | | | | | | | |
| Baden / douchebakken / stoomcabines | 0332917 | 128x128x232 | wit/helder glas | S8PL7920201 | stuk | 10718,00 | 383 | 1 |
| | 0332925 | 128x128x232 | metallic/helder | S8PL7920501 | stuk | 12042,00 | 383 | 1 |
| | 115L stoomcabine 1-persoons | | | | | | | |
| Kranen | 0333131 | 115x85x232 links | wit/helder glas | S8PL49840201 | stuk | 9634,00 | 383 | 1 |
| | 0333166 | 115x85x232 links | metallic/helder | S8PL49840501 | stuk | 10837,00 | 383 | 1 |
| | 115R stoomcabine 1-persoons | | | | | | | |
| Douchegarnituur | 0333158 | 115x85x232 rechts | wit/helder glas | S8PL19840201 | stuk | 9634,00 | 383 | 1 |
| | 0333174 | 115x85x232 rechts | metallic/helder | S8PL19840501 | stuk | 10837,00 | 383 | 1 |
| Accessoires en spiegels | | | | | | | | |
| Douchewanden | | | | | | | | |
| Toebehoren & afvoeren | | | | | | | | |
| Spoel- & installatiesystemen | | | | | | | | |
| Badkamermeubelen en toiletkasten | | | | | | | | |
| Gootstenen en wastroggen | | | | | | | | |
| Utiliteit | | | | | | | | |

| Art.nr | Specificaties | Kleur | Lev.nr | Ehd | Prijs | Grp | CC |
|--|----------------------|-------|-------------------|------|---------|-----|----|
| Ucosan Artica | | | | | | | |
| 92P opbouwcabine kwartrond m. draaideur | | | | | | | |
| 0931471 | 92x92x214 Basic | wit | SBA092ART4PB8U01 | stuk | 3101,00 | 126 | 1 |
| 0931472 | 92x92x214 Basic+ | wit | SBA092ART4PC8U01 | stuk | 3423,00 | 126 | 1 |
| 0931495 | 92x92x236 Standard | wit | SBA092ART4PS8U01 | stuk | 3851,00 | 126 | 1 |
| 0931483 | 92x92x236 Plus | wit | SCA092ART4PKZ8U01 | stuk | 5351,00 | 126 | 1 |
| 0931476 | 92x92x236 Extra | wit | SCA092ART4PLZ8U01 | stuk | 4280,00 | 126 | 1 |
| 0931487 | 92x92x236 Pro | wit | SCA092ART4PQZ8U01 | stuk | 5886,00 | 126 | 1 |
| 106P opbouwcabine wandmodel rond m. draaideur | | | | | | | |
| 0931499 | 104x104x233 Standard | wit | SBA106ART9JS8U01 | stuk | 3851,00 | 126 | 1 |
| 0931486 | 104x104x233 Plus | wit | SCA106ART9JKZ8U01 | stuk | 5351,00 | 126 | 1 |
| 0931479 | 104x104x233 Extra | wit | SCA106ART9JLZ8U01 | stuk | 4280,00 | 126 | 1 |
| 0931491 | 104x104x233 Pro | wit | SCA106ART9JQZ8U01 | stuk | 5886,00 | 126 | 1 |
| 106P opbouwcabine hoekmodel rond m. draaideur | | | | | | | |
| 0931498 | 104x104x233 Standard | wit | SBA106ART9PS8U01 | stuk | 3851,00 | 126 | 1 |
| 0931485 | 104x104x233 Plus | wit | SCA106ART9PKZ8U01 | stuk | 5351,00 | 126 | 1 |
| 0931478 | 104x104x233 Extra | wit | SCA106ART9PLZ8U01 | stuk | 4280,00 | 126 | 1 |
| 0931490 | 104x104x233 Pro | wit | SCA106ART9PQZ8U01 | stuk | 5886,00 | 126 | 1 |
| 115P opbouwcabine kwartrond m. draaideur | | | | | | | |
| 0931496 | 115x115x224 Standard | wit | SBA115ART4PS8U01 | stuk | 4387,00 | 126 | 1 |
| 0931484 | 115x115x224 Plus | wit | SCA115ART4PKZ8U01 | stuk | 5886,00 | 126 | 1 |
| 0931477 | 115x115x224 Extra | wit | SCA115ART4PLZ8U01 | stuk | 4815,00 | 126 | 1 |
| 0931488 | 115x115x224 Pro | wit | SCA115ART4PQZ8U01 | stuk | 6422,00 | 126 | 1 |
| 90P inbouwcabine links vierkant m. draaideur | | | | | | | |
| 0931494 | 90x90x230 Standard | wit | SBA090ART1RSL8U01 | stuk | 4280,00 | 126 | 1 |
| 0931482 | 90x90x230 Plus | wit | SCA090ART1RKX8U01 | stuk | 5886,00 | 126 | 1 |
| 0931475 | 90x90x230 Extra | wit | SCA090ART1RLX8U01 | stuk | 4815,00 | 126 | 1 |
| 90P inbouwcabine rechts vierkant m. draaideur | | | | | | | |
| 0940454 | 90x90x230 Standard | wit | SBA090ART1RSR8U01 | stuk | 4280,00 | 126 | 1 |
| 0940457 | 90x90x230 Extra | wit | SCA090ART1RLY8U01 | stuk | 4815,00 | 126 | 1 |
| 0940458 | 90x90x230 Plus | wit | SCA090ART1RKY8U01 | stuk | 5886,00 | 126 | 1 |
| 121P inbouwcabine rechthoekig m. draaideur | | | | | | | |
| 0931492 | 125x100x240 Standard | wit | SBA121ART2RS8U01 | stuk | 5351,00 | 126 | 1 |
| 0931480 | 125x100x240 Plus | wit | SCA121ART2RKZ8U01 | stuk | 6958,00 | 126 | 1 |
| 0931473 | 125x100x240 Extra | wit | SCA121ART2RLZ8U01 | stuk | 5886,00 | 126 | 1 |
| 200P inbouwcabine rechthoekig m. draaideur | | | | | | | |
| 0931493 | 200x125x240 Standard | wit | SBA200ART2RS8U01 | stuk | 7493,00 | 126 | 1 |
| 0931481 | 200x125x240 Plus | wit | SCA200ART2RKZ8U01 | stuk | 9100,00 | 126 | 1 |
| 0931474 | 200x125x240 Extra | wit | SCA200ART2RLZ8U01 | stuk | 8029,00 | 126 | 1 |

Sanitair producten

Baden /
douchebakken /
stoomcabines

Kranen

Douchegarnituur

Accessoires en
spiegels

Douchewanden



Toebehoren &
afvoeren

Spoel- &
installatiesystemen

Badkamermeubelen
en toiletkasten

Gootstenen en
wastroggen

Utiliteit









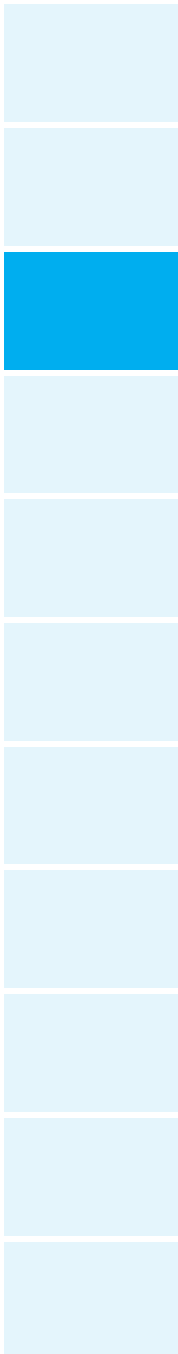

| | Art.nr | Specificaties | Kleur | Lev.nr | Ehd | Prijs | Grp | CC |
|---|--|--|----------|-------------------|------|----------|-----|----|
| Sanitair producten |  Villeroy & Boch Steam Fit Solo stoomcabine 1-persoons | | | | | | | |
| | 0949362 | 120x122x221cm | wit | SCQ122STE9PK8V01 | stuk | 9717,00 | 126 | 1 |
| | 0949363 | 120x122x221cm | pergamon | SCQ122STE9PK8V09 | stuk | 9717,00 | 126 | 1 |
| | 0949364 | 120x122x239cm m. polystyreen steun m. los paneel | wit | SCQ122STE9PKS8V01 | stuk | 9991,00 | 126 | 1 |
| | 0949365 | 120x122x239cm m. polystyreen steun m. los paneel | pergamon | SCQ122STE9PKS8V09 | stuk | 9991,00 | 126 | 1 |
| Baden / douchebakken / stoomcabines |  Duo stoomcabine 2-persoons | | | | | | | |
| | 0949366 | 145x140x221cm | wit | SCQ145STE9PK8V01 | stuk | 10809,00 | 126 | 1 |
| | 0949367 | 145x140x221cm | pergamon | SCQ145STE9PK8V09 | stuk | 10809,00 | 126 | 1 |
| | 0949368 | 145x140x239cm m. polystyreen steun m. los paneel | wit | SCQ145STE9PKS8V01 | stuk | 11098,00 | 126 | 1 |
| | 0949369 | 145x140x239cm m. polystyreen steun m. los paneel | pergamon | SCQ145STE9PKS8V09 | stuk | 11098,00 | 126 | 1 |
| Kranen | | | | | | | | |
| Douchegarnituur | | | | | | | | |
| Accessoires en spiegels | | | | | | | | |
| Douchewanden | | | | | | | | |
| Toebehoren & afvoeren | | | | | | | | |
| Spoel- & installatiesystemen | | | | | | | | |
| Badkamermeubelen en toiletkasten | | | | | | | | |
| Gootstenen en wastroggen | | | | | | | | |
| Utiliteit | | | | | | | | |

Kranen

| | |
|------------------------------|-----|
| Damixa kranen | 358 |
| Kranen Dornbracht | 371 |
| Kranen Fantini | 411 |
| Kranen Gessi | 413 |
| Kranen Grohe | 471 |
| Kranen Hansa | 506 |
| Kranen HansGrohe | 524 |
| Kranen Ideal Standard | 571 |
| Kranen Jado | 576 |
| Kranen Keuco | 582 |
| Kranen Kludi | 586 |
| Kranen KWC | 613 |
| Kranen Nobili | 615 |
| Kranen Oras | 617 |
| Kranen Plieger | 618 |
| Kranen Schell | 626 |
| Kranen Sphinx | 627 |
| Kranen Venlo | 631 |
| Kranen Villeroy & Boch | 647 |
| Keukenkranen Damixa | 655 |
| Keukenkranen Dornbracht | 660 |
| Keukenkranen Gessi | 663 |
| Keukenkranen Grohe | 672 |
| Keukenkranen Hansa | 676 |
| Keukenkranen Hansgrohe | 677 |
| Keukenkranen Ideal Standard | 679 |
| Keukenkranen Jado | 680 |
| Keukenkranen Kludi | 682 |
| Keukenkranen KWC | 687 |
| Keukenkranen Nobili | 691 |
| Keukenkranen Plieger | 692 |
| Keukenkranen Sphinx | 693 |
| Keukenkranen Venlo | 695 |
| Keukenkranen Villeroy & Boch | 699 |
| Ballofix kraan Toebehoren | 700 |
| De Beer kraan Toebehoren | 701 |
| F-Grohe kraan Toebehoren | 702 |
| Neoperl kraan Toebehoren | 703 |
| Nil kraan Toebehoren | 704 |
| Plieger kraan Toebehoren | 706 |
| Schell kraan Toebehoren | 708 |
| VSH kraan Toebehoren | 711 |

Kranen



| | Art.nr | Specificaties | Kleur | Lev.nr | Ehd | Prijs | Grp | CC |
|---|---|--|-------|------------|------|--------|-----|----|
| Sanitair producten | Damixa Arc | | | | | | | |
| |  | 1-gats wastafel-/bidetkraan m. waste 0460187 | chrom | 2682100B38 | stuk | 228,00 | 159 | 1 |
| Baden / douchebakken / stoomcabines |  | 1-gats wastafel-/bidetkraan m. ketting 0460188 | chrom | 2602100B | stuk | 217,00 | 159 | 1 |
| Kranen |  | badkraan m. omstel 0460189 | chrom | 2610000A | stuk | 305,00 | 159 | 1 |
| Douchegarnituur |  | douchekraan z. omstel HOH=15cm 0460190 | chrom | 2620000A | stuk | 250,00 | 159 | 1 |
| Accessoires en spiegels |  | badthermostaat m. omstel 0460192 | chrom | 2650000A | stuk | 305,00 | 159 | 1 |
| Douchewanden |  | douchethermostaat HOH=15cm z. omstel 0460191 | chrom | 2640000A | stuk | 250,00 | 159 | 1 |
| Toebehoren & afvoeren |  | 1-gats bidetkraan m. waste 0460261 | chrom | 4682100B | stuk | 122,00 | 159 | 1 |
| Spoel- & installatiesystemen |  | badkraan m. omstel 0460263 | chrom | 4710000B | stuk | 118,00 | 159 | 1 |
| Badkamermeubelen en toiletkasten | Damixa Eclipse | | | | | | | |
| Gootstenen en wastroggen |  | 1-gats wastafelkraan m. waste 0460260 | chrom | 4582100B | stuk | 96,00 | 159 | 1 |
| Utiliteit |  | 1-gats bidetkraan m. waste 0460261 | chrom | 4682100B | stuk | 122,00 | 159 | 1 |
| |  | badkraan m. omstel 0460263 | chrom | 4710000B | stuk | 118,00 | 159 | 1 |

| Art.nr | Specificaties | Kleur | Lev.nr | Ehd | Prijs | Grp | CC |
|--------|---------------|-------|--------|-----|-------|-----|----|
|--------|---------------|-------|--------|-----|-------|-----|----|

Damixa Eclipse

douchekraan z. omstel HOH=15cm

| | | | | | | | |
|---------|--|-------|----------|------|--------|-----|---|
| 0460264 | | chrom | 4720000B | stuk | 120,00 | 159 | 1 |
|---------|--|-------|----------|------|--------|-----|---|



Sanitair producten

Baden /
douchebakken /
stoomcabines**douchethermostaat HOH=15cm z. omstel**

| | | | | | | | |
|---------|--|-------|----------|------|--------|-----|---|
| 0460262 | | chrom | 4040000A | stuk | 137,00 | 159 | 1 |
|---------|--|-------|----------|------|--------|-----|---|



Kranen

Douchegarnituur

Damixa G Type V3.0

wastafelkraan m. draaibare uitloop m. waste

| | | | | | | | |
|---------|--|-------|------------|------|--------|-----|---|
| 0440034 | | chrom | 7282000B38 | stuk | 488,00 | 159 | 1 |
|---------|--|-------|------------|------|--------|-----|---|

Accessoires en
spiegels**bidetkraan m. draaibare uitloop m. waste**

| | | | | | | | |
|---------|--|-------|------------|------|--------|-----|---|
| 0440036 | | chrom | 7283000B38 | stuk | 517,00 | 159 | 1 |
|---------|--|-------|------------|------|--------|-----|---|



Douchewanden

Toebehoren &
afvoeren**badkraan HOH=15cm m. omstel m. handdouche**

| | | | | | | | |
|---------|--|-------|----------|------|--------|-----|---|
| 0440037 | | chrom | 7210000B | stuk | 805,00 | 159 | 1 |
|---------|--|-------|----------|------|--------|-----|---|

Spoel- &
installatiesystemen**badkraan m. omstel z. garnituur**

| | | | | | | | |
|---------|--|-------|----------|------|--------|-----|---|
| 0460146 | | chrom | 7211000B | stuk | 725,00 | 159 | 1 |
|---------|--|-------|----------|------|--------|-----|---|

Badkamermeubelen
en toiletkastenGootstenen en
wastroggen**douchekraan HOH=15cm m. handdouche**

| | | | | | | | |
|---------|--|-------|----------|------|--------|-----|---|
| 0440038 | | chrom | 7220000A | stuk | 631,00 | 159 | 1 |
|---------|--|-------|----------|------|--------|-----|---|



Utiliteit









douchekraan m. hoofdouche m. handdouche





| | | | | | | | |
|---------|--|-------|----------|------|--------|-----|---|
| 0440039 | | chrom | 7230000B | stuk | 976,00 | 159 | 1 |
|---------|--|-------|----------|------|--------|-----|---|

**douchekraan m. stortdouche**

| | | | | | | | |
|---------|--|-------|----------|------|--------|-----|---|
| 0460147 | | chrom | 7221000B | stuk | 858,00 | 159 | 1 |
|---------|--|-------|----------|------|--------|-----|---|

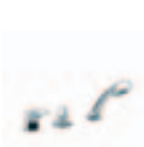

| | Art.nr | Specificaties | Kleur | Lev.nr | Ehd | Prijs | Grp | CC |
|---|---|--|-------|------------|------|---------|-----|----|
| Sanitair producten | Damixa G Type V3.0 | | | | | | | |
| | | douchethermostaat m. garnituur | | | | | | |
| | 0460149 | | chrom | 7240000A | stuk | 746,00 | 159 | 1 |
| Baden / douchebakken / stoomcabines |  | | | | | | | |
| Kranen | douchethermostaat m. stortdouche | | | | | | | |
| | | 0460150 | chrom | 7241000A | stuk | 1030,00 | 159 | 1 |
| Douchegarnituur |  | | | | | | | |
| Accessoires en spiegels | badthermostaat m. garnituur | | | | | | | |
| | | 0460148 | chrom | 7250000A | stuk | 949,00 | 159 | 1 |
| Douchewanden |  | | | | | | | |
| Toebehoren & afvoeren | douchethermostaat m. stortdouche m. handdouche | | | | | | | |
| | | 0460151 | chrom | 7260000A | stuk | 1149,00 | 159 | 1 |
| Toebehoren & afvoeren |  | | | | | | | |
| Spoel- & installatiesystemen | Damixa Gala | | | | | | | |
| | | 1-gats wastafelkraan Piccolo m. waste | | | | | | |
| | 0460177 | | chrom | 7072100A38 | stuk | 280,00 | 159 | 1 |
| Badkamermeubelen en toiletkasten |  | | | | | | | |
| Gootstenen en wastroggen | 1-gats wastafelkraan m. waste | | | | | | | |
| | | 0460176 | chrom | 7082100B | stuk | 256,00 | 159 | 1 |
| Gootstenen en wastroggen |  | | | | | | | |
| Utiliteit | 3-gats badoverloop vulcombinatie | | | | | | | |
| | | 0460180 | chrom | 7001200C | stuk | 468,00 | 159 | 1 |
| Utiliteit |  | | | | | | | |
| Utiliteit | 3-gats badkraan m. omstel | | | | | | | |
| | | 0460179 | chrom | 7001300C | stuk | 805,00 | 159 | 1 |
| Utiliteit |  | | | | | | | |
| Utiliteit | badkraan m. omstel | | | | | | | |
| | | 0460178 | chrom | 7010000B | stuk | 341,00 | 159 | 1 |
| Utiliteit |  | | | | | | | |

| Art.nr | Specificaties | Kleur | Lev.nr | Ehd | Prijs | Grp | CC | |
|---|---------------|--------|----------|------|--------|-----|----|---|
| Damixa Gala | | | | | | | | |
| opbouwdeel voor inbouwbadkraan m. omstel 0460183 | | chroom | 7070100B | stuk | 243,00 | 159 | 1 | |
| opbouwdeel voor inbouwdouchekraan 0460184 | | chroom | 7075100B | stuk | 171,00 | 159 | 1 | |
| Damixa Jupiter | | | | | | | | |
| 1-gats wastafelkraan Grande m. waste 0460220 | | chroom | 1592100B | stuk | 170,00 | 159 | 1 |  |
| 1-gats wastafelkraan Grande m. ketting 0460221 | | chroom | 1593000B | stuk | 155,00 | 159 | 1 |  |
| 1-gats wastafelkraan m. uittrekbare uitloop 0460222 | | chroom | 1595100B | stuk | 241,00 | 159 | 1 |  |
| fonteinkraan 0460230 | | chroom | 1583000D | stuk | 39,50 | 159 | 1 |  |
| 1-gats bidetkraan m. waste 0460223 | | chroom | 1583100B | stuk | 160,00 | 159 | 1 |  |
| douchekraan HOH=15cm z. omstel 0460227 | | chroom | 1520000B | stuk | 139,00 | 159 | 1 |  |
| badkraan z. omstel 0460224 | | chroom | 1550000B | stuk | 254,00 | 159 | 1 |  |
| 3-gats badoverloop vulcombinatie 0460229 | | chroom | 1501200C | stuk | 398,00 | 159 | 1 |  |

Sanitair producten

Baden /
douchebakken /
stoomcabines

Kranen











Douchegarnituur

Accessoires en
spiegels









Douchewanden

Toebehoren &
afvoerenSpoel- &
installatiesystemenBadkamermeubelen
en toiletkastenGootstenen en
wastroggen

Utiliteit

| | Art.nr | Specificaties | Kleur | Lev.nr | Ehd | Prijs | Grp | CC |
|---|-----------------------|--|-------|----------|------|--------|-----|----|
| | Damixa Jupiter | | | | | | | |
| Sanitair producten | | 3-gats badkraan m. omstel 0460228 | chrom | 1501300C | stuk | 575,00 | 159 | 1 |
|  | | | | | | | | |
| Baden / douchebakken / stoomcabines | | badkraan m. omstel 0460226 | chrom | 1510000B | stuk | 169,00 | 159 | 1 |
|  | | | | | | | | |
| Kranen | | douchethermostaat HOH=15cm z. omstel 0460225 | chrom | 1540000A | stuk | 202,00 | 159 | 1 |
|  | | | | | | | | |
| Douchegarnituur | | opbouwdeel voor inbouwbadkraan m. omstel 0460231 | chrom | 1570100B | stuk | 83,50 | 159 | 1 |
|  | | | | | | | | |
| Accessoires en spiegels | | opbouwdeel voor inbouwdouchekraan 0460232 | chrom | 1575100B | stuk | 78,00 | 159 | 1 |
|  | | | | | | | | |
| Douchewanden | | Damixa Luna | | | | | | |
| | | 1-gats wastafelkraan m. waste 0460165 | chrom | 2182100A | stuk | 311,00 | 159 | 1 |
|  | | | | | | | | |
| Spoel- & installatiesystemen | | fonteinkraan 0460169 | chrom | 2183000A | stuk | 93,00 | 159 | 1 |
|  | | | | | | | | |
| Badkamermeubelen en toiletkasten | | 1-gats bidetkraan m. waste 0460166 | chrom | 2183100A | stuk | 338,00 | 159 | 1 |
|  | | | | | | | | |
| Gootstenen en wastroggen | | badkraan m. omstel 0460167 | chrom | 2110000A | stuk | 313,00 | 159 | 1 |
|  | | | | | | | | |
| Utiliteit | | douchekraan HOH=15cm m. omstel 0460168 | chrom | 2120000A | stuk | 248,00 | 159 | 1 |
|  | | | | | | | | |

| Art.nr | Specificaties | Kleur | Lev.nr | Ehd | Prijs | Grp | CC | | |
|---|---------------|--------|----------|------|--------|-----|----|---|---|
| | | | | | | | | Damixa Merkur | |
| 1-gats wastafelkraan m. ketting 0460157 | | chroom | 1402100A | stuk | 258,00 | 159 | 1 |  | Sanitair producten |
| wastafelkraan m. waste 0440041 | | chroom | 1482100A | stuk | 265,00 | 159 | 1 |  | Baden / douchebakken / stoomcabines |
| wastafelkraan piccolo m. waste 0440046 | | chroom | 1472100A | stuk | 238,00 | 159 | 1 |  | Kranen |
| 1-gats wastafelkraan Piccolo m. ketting 0460158 | | chroom | 1473000A | stuk | 232,00 | 159 | 1 |  | Douchegarnituur |
| 3-gats wandkraan m. waste 0460161 | | chroom | 1472200A | stuk | 458,00 | 159 | 1 |  | Accessoires en spiegels |
| fonteinkraan 0440048 | | chroom | 1483000D | stuk | 84,50 | 159 | 1 |  | Douchewanden |
| bidetkraan m. waste 0440047 | | chroom | 1483100A | stuk | 287,00 | 159 | 1 |  | Toebehoren & afvoeren |
| badkraan HOH=15cm m. omstel 0440053 | | chroom | 1410000A | stuk | 267,00 | 159 | 1 |  | Spoel- & installatiesystemen |
| douchekraan HOH=15cm 0440054 | | chroom | 1420000A | stuk | 343,00 | 159 | 1 |  | Badkamermeubelen en toiletkasten |
| | | | | | | | | | Gootstenen en wastroggen |
| | | | | | | | | | Utiliteit |

| | Art.nr | Specificaties | Kleur | Lev.nr | Ehd | Prijs | Grp | CC |
|---|---|--|-------|----------|------|--------|-----|----|
| Sanitair producten | Damixa Merkur | | | | | | | |
| |  | badthermostaat HOH=15cm m. omstel 0440049 | chrom | 1450000A | stuk | 304,00 | 159 | 1 |
| Baden / douchebakken / stoomcabines |  | douchethermostaat HOH=15cm 0440050 | chrom | 1440000A | stuk | 224,00 | 159 | 1 |
| Kranen |  | 3-gats badoverloop vulcombinatie 0460160 | chrom | 1401200A | stuk | 548,00 | 159 | 1 |
| Douchegarnituur |  | 3-gats badkraan m. omstel 0460159 | chrom | 1401300A | stuk | 664,00 | 159 | 1 |
| Accessoires en spiegels | Damixa Object | | | | | | | |
| Douchewanden |  | 1-gats wastafelkraan m. waste laag 0460274 | chrom | 3001100L | stuk | 126,00 | 159 | 1 |
| |  | fonteinkraan 0460280 | chrom | 3001400L | stuk | 29,00 | 159 | 1 |
| Toebehoren & afvoeren |  | 1-gats wastafelkraan m. ketting hoog 0460276 | chrom | 3001800L | stuk | 50,50 | 159 | 1 |
| Spoel- & installatiesystemen |  | 1-gats wastafelkraan m. waste hoog 0460275 | chrom | 3002000L | stuk | 61,00 | 159 | 1 |
| Badkamermeubelen en toiletkasten |  | douchekraan HOH=15cm z. omstel 0460279 | chrom | 3002100L | stuk | 40,50 | 159 | 1 |
| Gootstenen en wastroggen | | | | | | | | |
| Utiliteit | | | | | | | | |

| Art.nr | Specificaties | Kleur | Lev.nr | Ehd | Prijs | Grp | CC |
|--------|---------------|-------|--------|-----|-------|-----|----|
|--------|---------------|-------|--------|-----|-------|-----|----|

Damixa Object

1-gats bidetkraan m. waste
0460277

chroom 3003200L stuk 94,00 159 1



Sanitair producten

Baden /
douchebakken /
stoomcabines

badkraan m. omstel
0460278

chroom 3002600L stuk 79,00 159 1



Kranen

Douchegarnituur

Damixa Saturn

1-gats wastafelkraan Grande m. waste
0460208

chroom 2592100A stuk 161,00 159 1

Accessoires en
spiegels

1-gats wastafelkraan Grande z. waste
0460209

chroom 2593000A stuk 155,00 159 1



Douchewanden

Toebehoren &
afvoeren

1-gats wastafelkraan Piccolo m. waste
0460210

chroom 2593300A stuk 193,00 159 1

Spoel- &
installatiesystemenBadkamermeubelen
en toiletkasten

1-gats wastafelkraan m. uittrekbare uitloop
0460211

chroom 2595100A stuk 258,00 159 1

Gootstenen en
wastroggen

1-gats bidetkraan m. waste
0460212

chroom 2583100A stuk 171,00 159 1



Utiliteit

badkraan m. omstel
0460213









chroom 2510000A stuk 185,00 159 1



douchekraan HOH=15cm z. omstel
0460214

chroom 2520000A stuk 154,00 159 1



| | Art.nr | Specificaties | Kleur | Lev.nr | Ehd | Prijs | Grp | CC |
|----------------------------------|---|--|-------|----------|------|--------|-----|----|
| | Damixa Saturn | | | | | | | |
| Sanitair producten | | opbouwdeel voor inbouwbadkraan m. omstel 0460215 | chrom | 2570100 | stuk | 83,50 | 159 | 1 |
| | | opbouwdeel voor inbouwdouchekraan 0460216 | chrom | 2575100 | stuk | 78,00 | 159 | 1 |
| | | Damixa Space | | | | | | |
| Kranen |  | 1-gats wastafelkraan m. waste 0460236 | chrom | 1082100B | stuk | 73,00 | 159 | 1 |
| Douchegarnituur |  | 1-gats wastafelkraan m. ketting 0460237 | chrom | 1002100B | stuk | 67,00 | 159 | 1 |
| Accessoires en spiegels | | | | | | | | |
| Douchewanden |  | 1-gats bidetkraan m. waste 0460238 | chrom | 1083100A | stuk | 73,50 | 159 | 1 |
| Toebehoren & afvoeren | | | | | | | | |
| Spoel- & installatiesystemen |  | badkraan m. omstel 0460239 | chrom | 1010000B | stuk | 84,00 | 159 | 1 |
| Badkamermeubelen en toiletkasten | | | | | | | | |
| Gootstenen en wastroggen |  | douchekraan HOH=15cm z. omstel 0460240 | chrom | 1020000B | stuk | 73,00 | 159 | 1 |
| Utiliteit | | | | | | | | |
| | Damixa Superstar | | | | | | | |
| |  | 1-gats wastafelkraan m. waste 0460251 | chrom | 3682100B | stuk | 163,00 | 159 | 1 |
| |  | 1-gats bidetkraan m. waste 0460252 | chrom | 3683100B | stuk | 235,00 | 159 | 1 |
| |  | badkraan m. omstel 0460253 | chrom | 3610000B | stuk | 183,00 | 159 | 1 |

| Art.nr | Specificaties | Kleur | Lev.nr | Ehd | Prijs | Grp | CC |
|--------|---------------|-------|--------|-----|-------|-----|----|
|--------|---------------|-------|--------|-----|-------|-----|----|

Damixa Superstar

douчекraan HOH=15cm z. omstel

| | | | | | | | |
|---------|--|-------|----------|------|--------|-----|---|
| 0460254 | | chrom | 3620000B | stuk | 158,00 | 159 | 1 |
|---------|--|-------|----------|------|--------|-----|---|



Sanitair producten

Baden /
douchebakken /
stoomcabines**opbouwdeel voor inbouwbadkraan m. omstel**

| | | | | | | | |
|---------|--|-------|----------|------|--------|-----|---|
| 0460255 | | chrom | 3605200B | stuk | 107,00 | 159 | 1 |
|---------|--|-------|----------|------|--------|-----|---|

opbouwdeel voor inbouwdouчекraan

| | | | | | | | |
|---------|--|-------|----------|------|-------|-----|---|
| 0460256 | | chrom | 3605700B | stuk | 84,50 | 159 | 1 |
|---------|--|-------|----------|------|-------|-----|---|

Kranen

Damixa Titan

1-gats wastafelkraan m. waste laag

| | | | | | | | |
|---------|--|-------|----------|------|--------|-----|---|
| 0460244 | | chrom | 6282000A | stuk | 160,00 | 159 | 1 |
|---------|--|-------|----------|------|--------|-----|---|



Douчegarnituur

Accessoires en
spiegels**1-gats wastafelkraan m. waste**

| | | | | | | | |
|---------|--|-------|----------|------|--------|-----|---|
| 0460243 | | chrom | 6282100A | stuk | 189,00 | 159 | 1 |
|---------|--|-------|----------|------|--------|-----|---|



Douчewanden

Toebehoren &
afvoeren**3-gats wandkraan m. waste**

| | | | | | | | |
|---------|--|-------|----------|------|--------|-----|---|
| 0460248 | | chrom | 6272200A | stuk | 401,00 | 159 | 1 |
|---------|--|-------|----------|------|--------|-----|---|

Spoel- &
installatiesystemen**fonteinkraan**

| | | | | | | | |
|---------|--|-------|----------|------|-------|-----|---|
| 0460247 | | chrom | 6283000A | stuk | 71,50 | 159 | 1 |
|---------|--|-------|----------|------|-------|-----|---|

Badkamermeubelen
en toiletkastenGootstenen en
wastroggen**1-gats bidetkraan m. waste**

| | | | | | | | |
|---------|--|-------|----------|------|--------|-----|---|
| 0460245 | | chrom | 6283100A | stuk | 256,00 | 159 | 1 |
|---------|--|-------|----------|------|--------|-----|---|



Utiliteit

douchethermostaat HOH=15cm z. omstel

| | | | | | | | |
|---------|--|-------|----------|------|--------|-----|---|
| 0460246 | | chrom | 6240000B | stuk | 192,00 | 159 | 1 |
|---------|--|-------|----------|------|--------|-----|---|











Damixa Tradition

1-gats wastafelkraan m. waste m. gegoten uitloop

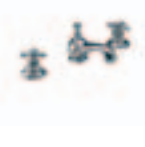
| | | | | | | | |
|---------|--|-------|---------|------|--------|-----|---|
| 0460286 | | chrom | 3702900 | stuk | 197,00 | 159 | 1 |
|---------|--|-------|---------|------|--------|-----|---|



| | Art.nr | Specificaties | Kleur | Lev.nr | Ehd | Prijs | Grp | CC |
|---|---|--|--------|---------|------|--------|-----|----|
| | Damixa Tradition | | | | | | | |
| Sanitair producten | | 1-gats wastafelkraan m. waste m. draaibare uitloop 0460289 | chroom | 3701300 | stuk | 162,00 | 159 | 1 |
| Baden / douchebakken / stoomcabines |  | | | | | | | |
| Kranen | | 1-gats wastafelkraan m. waste laag 0460285 | chroom | 3701000 | stuk | 170,00 | 159 | 1 |
| Douchegarnituur |  | | | | | | | |
| Accessoires en spiegels | | 1-gats wastafelkraan m. waste hoog 0460287 | chroom | 3702000 | stuk | 161,00 | 159 | 1 |
| Douchewanden |  | | | | | | | |
| Toebehoren & afvoeren | | 3-gats wastafelkraan m. hoge uitloop 0460291 | chroom | 3707800 | stuk | 264,00 | 159 | 1 |
| Spoel- & installatiesystemen |  | | | | | | | |
| Badkamermeubelen en toiletkasten | | 3-gats wastafelkraan m. lage uitloop 0460292 | chroom | 3708000 | stuk | 212,00 | 159 | 1 |
| Gootstenen en wastroggen |  | | | | | | | |
| Utiliteit | | fonteinkraan 0460300 | chroom | 3701400 | stuk | 60,00 | 159 | 1 |
| |  | | | | | | | |
| | | fonteinkraan m. hoge uitloop 0460301 | chroom | 3701600 | stuk | 67,50 | 159 | 1 |
| |  | | | | | | | |
| | | 1-gats bidetkraan m. waste 0460288 | chroom | 3703500 | stuk | 170,00 | 159 | 1 |
| |  | | | | | | | |
| | | 4-gats badkraan m. omstel 0460290 | chroom | 3700700 | stuk | 586,00 | 159 | 1 |
| |  | | | | | | | |

Art.nr Specificaties Kleur Lev.nr Ehd Prijs Grp CC

Damixa Tradition

douчекraan HOH=15cm z. omstel
0460299 chroom 3702100 stuk 105,00 159 1



Sanitair producten

Baden /
douchebakken /
stoomcabines

badkraan m. garnituur
0460297 chroom 3702500 stuk 232,00 159 1



Kranen

Douchegarnituur

badthermostaat m. garnituur
0460293 chroom 3704100 stuk 419,00 159 1



Accessoires en
spiegels

Douchewanden

bad/douchethermostaat
0460295 chroom 3705200 stuk 319,00 159 1



Toebehoren &
afvoeren

douchethermostaat HOH=15cm z. omstel m. onderaansluiting
0460294 chroom 3704200 stuk 287,00 159 1



Spoel- &
installatiesystemen

Badkamermeubelen
en toiletkasten

douchethermostaat HOH=15cm z. omstel m. bovenaansluiting
0460296 chroom 3705300 stuk 319,00 159 1



Gootstenen en
wastroggen

Utiliteit

douчекraan HOH=15cm z. uitloop m. omstel
0460298 chroom 3706000 stuk 142,00 159 1



Damixa Venus







wastafelkraan m. waste
0440055 m. draaibare uitloop 110mm chroom 1682100C stuk 206,00 159 1















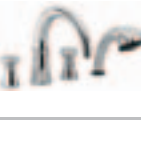





0440056 m. draaibare uitloop 165mm chroom 1692100C stuk 210,00 159 1

1-gats wastafelkraan uitloop=110mm
0460197 chroom 1662100C stuk 201,00 159 1



| | Art.nr | Specificaties | Kleur | Lev.nr | Ehd | Prijs | Grp | CC |
|---|---|---|--------|------------|------|--------|-----|----|
| | Damixa Venus | | | | | | | |
| Sanitair producten | | 3-gats wastafelkraan m. waste 0440061 | chroom | 1608000C | stuk | 477,00 | 159 | 1 |
| |  | | | | | | | |
| Baden / douchebakken / stoomcabines | | 3-gats inbouwastafelkraan m. waste compleet 0440063 | chroom | 1672200A | stuk | 458,00 | 159 | 1 |
| |  | | | | | | | |
| Kranen | | fonteinkraan 0440062 | chroom | 1683000D | stuk | 71,50 | 159 | 1 |
| |  | | | | | | | |
| Douchegarnituur | | bidetkraan m. draaibare uitloop m. waste 0440057 | chroom | 1683100C | stuk | 201,00 | 159 | 1 |
| |  | | | | | | | |
| Accessoires en spiegels | | badkraan HOH=15cm m. omstel 0440058 | chroom | 1610000B | stuk | 236,00 | 159 | 1 |
| |  | | | | | | | |
| Douchewanden | | douchekraan HOH=15cm 0440059 | chroom | 1620000B | stuk | 206,00 | 159 | 1 |
| |  | | | | | | | |
| Toebehoren & afvoeren | | 4-gats badkraan m. omstel 0440060 | chroom | 1601300C12 | stuk | 805,00 | 159 | 1 |
| |  | | | | | | | |
| Spoel- & installatiesystemen | | | | | | | | |
| Badkamermeubelen en toiletkasten | | | | | | | | |
| Gootstenen en wastroggen | | | | | | | | |
| | Damixa Universeel | | | | | | | |
| Utiliteit | | sokkel verhoogd 0460249 142mm | chroom | 3419000A | stuk | 101,00 | 159 | 1 |
| | | 0460162 157-140mm | chroom | 3429000A | stuk | 101,00 | 159 | 1 |
| | | 0460198 140mm | chroom | 3439000A | stuk | 101,00 | 159 | 1 |
| | | inbouwdeel voor inbouwbadkraan m. omstel 0460181 | | 4705100A | stuk | 133,00 | 159 | 1 |
| | | inbouwdeel voor inbouwdouchekraan 0460182 | | 4705600A | stuk | 113,00 | 159 | 1 |
| | | uitloop voor wandkraan 0460204 200mm | | 4807500A | stuk | 43,75 | 159 | 1 |
| | | 0460203 150mm | chroom | 4807600A | stuk | 43,75 | 159 | 1 |
| | | 0460206 300mm | | 4808900A | stuk | 58,00 | 159 | 1 |
| | | 0460205 250mm | chroom | 4809300A | stuk | 84,50 | 159 | 1 |
| | | 0460207 400mm | chroom | 4809400A | stuk | 96,00 | 159 | 1 |

| Art.nr | Specificaties | Kleur | Lev.nr | Ehd | Prijs | Grp | CC | | |
|--|---------------|-------------|------------|------|---------|-----|----|---|---|
| | | | | | | | | Dornbracht Belle de Jour | |
| Leverbaar tot 01-07-2007 | | | | | | | | | |
| greep voor kranen 0474592 | | chroom | 1114033500 | stuk | 34,25 | 172 | 1 |  | Sanitair producten |
| greep voor hoekstop-/inbouwstop-/3-gats wandkraan 0474835 | | chroom | 1114133500 | stuk | 34,25 | 172 | 1 |  | Baden / douchebakken / stoomcabines |
| 1-gats fonteinkraan z. knop 0473383 | | chroom | 1750033500 | stuk | 170,00 | 172 | 1 |  | Douchegarnituur |
| 0474592 greep voor kranen | chroom | | 1114033500 | stuk | 34,25 | 172 | 1 | | Accessoires en spiegels |
| 1-gats wastafelkraan z. grepen m. draaibare uitloop m. waste 0470011 | | chroom | 2251033500 | stuk | 375,00 | 172 | 1 |  | Douchewanden |
| 0474592 greep voor kranen | chroom | | 1114033500 | stuk | 34,25 | 172 | 1 | | Toebehoren & afvoeren |
| bidetkraan z. grepen m. waste 0472080 | | chroom | 2451033500 | stuk | 475,00 | 172 | 1 |  | Spoel- & installatiesystemen |
| 0474592 greep voor kranen | chroom | | 1114033500 | stuk | 34,25 | 172 | 1 | | Badkamermeubelen en toiletkasten |
| 4-gats badrandkraan z. grepen 0473278 | | chroom | 2751233500 | stuk | 1295,00 | 172 | 1 |  | Gootstenen en wastroggen |
| 0474592 greep voor kranen | chroom | | 1114033500 | stuk | 34,25 | 172 | 1 | | |
| | | | | | | | | Dornbracht Domani | |
| 1-gats wastafelkraan m. waste 0475246 | | chroom | 3350522500 | stuk | 311,00 | 172 | 1 |  | Utiliteit |
| | | | | | | | | Dornbracht Dreamscape | |
| Leverbaar tot 01-07-2007 | | | | | | | | | |
| kruisgreep 0472891 | | chroom | 1142047000 | stuk | 141,00 | 172 | 1 |  | |
| 1-gats wastafelkraan m. waste 125mm 0472840 | | chroom | 3350048000 | stuk | 366,00 | 172 | 1 |  | |
| 0470290 | | platina-mat | 3350048006 | stuk | 494,00 | 172 | 1 | | |

| | Art.nr | Specificaties | Kleur | Lev.nr | Ehd | Prijs | Grp | CC |
|---|---|---|-------------|------------|------|---------|-----|----|
| Dornbracht Dreamscape | | | | | | | | |
| Sanitair producten | 3-gats wastafelkraan m. waste | | | | | | | |
| | 0472859 | | chroom | 2071048000 | stuk | 641,00 | 172 | 1 |
| | 0470291 | | platina-mat | 2071048006 | stuk | 865,00 | 172 | 1 |
|  | | | | | | | | |
| Baden / douchebakken / stoomcabines | New afbouwdeel 3-gats wandkraan | | | | | | | |
| | 0433108 | 210mm | chroom | 3671248000 | stuk | 481,00 | 172 | 1 |
| | 0433109 | 210mm | platina-mat | 3671248006 | stuk | 646,00 | 172 | 1 |
| Kranen | 0433043 | inbouwset voor 3-gats muurkraan m. bronzen inbouwhuis | | 3570797090 | stuk | 167,00 | 172 | 0 |
| | 0433044 | inbouwset voor 3-gats muurkraan m. 3 bronzen inbouwhuizen | | 3571297090 | stuk | 147,00 | 172 | 0 |
|  | | | | | | | | |
| Douchegarnituur | 1-gats bidetkraan m. waste | | | | | | | |
| | 0472883 | | chroom | 3360048000 | stuk | 458,00 | 172 | 1 |
| | 0470293 | | platina-mat | 3360048006 | stuk | 663,00 | 172 | 1 |
|  | | | | | | | | |
| Accessoires en spiegels | stopkraan staande montage koud 1/2" | | | | | | | |
| | 0472999 | | chroom | 2000048000 | stuk | 131,00 | 172 | 1 |
| | 0470294 | | platina-mat | 2000048006 | stuk | 196,00 | 172 | 1 |
|  | | | | | | | | |
| Douchewanden | stopkraan staande montage warm 1/2" | | | | | | | |
| | 0473006 | | chroom | 2000048100 | stuk | 131,00 | 172 | 1 |
| | 0470295 | | platina-mat | 2000048106 | stuk | 196,00 | 172 | 1 |
|  | | | | | | | | |
| Toebehoren & afvoeren | New afbouwdeel 2/3 weg omstel | | | | | | | |
| | 0433110 | | chroom | 3610448000 | stuk | 213,00 | 172 | 1 |
| | 0433111 | | platina-mat | 3610448006 | stuk | 319,00 | 172 | 1 |
| Spoel- & installatiesystemen | 0433059 | 2-weg omstel voor inbouwmontage | chroom | 3512497090 | stuk | 211,00 | 172 | 0 |
| | 0433060 | 3-weg omstel voor inbouwmontage | chroom | 3510497090 | stuk | 257,00 | 172 | 1 |
|  | | | | | | | | |
| Badkamermeubelen en toiletkasten | 4-gats badrandcombinatie 225mm | | | | | | | |
| | 0472905 | | chroom | 2751248000 | stuk | 1132,00 | 172 | 1 |
| | 0470296 | | platina-mat | 2751248006 | stuk | 1698,00 | 172 | 1 |
| Gootstenen en wastroggen | 0470155 | Perfecto montagesysteem 1/2" voor 4-gats kraan | | 1261097090 | stuk | 555,00 | 172 | 0 |
| | 0470163 | Perfecto sierrozetten voor montagesysteem | chroom | 1280197000 | stuk | 27,75 | 172 | 0 |
|  | | | | | | | | |
| Utiliteit | thermostaat voor staande montage z. hendel | | | | | | | |
| | 0472765 | | chroom | 3452597000 | stuk | 1373,00 | 172 | 1 |
| | 0471618 | | platina-mat | 3452597006 | stuk | 1681,00 | 172 | 1 |
| | 0470588 | schaalgreep | chroom | 1142089000 | stuk | 141,00 | 172 | 0 |
| | 0471620 | schaalgreep | platina-mat | 1142089006 | stuk | 211,00 | 172 | 1 |
| | 0472719 | temperatuurgreep | chroom | 1142022000 | stuk | 141,00 | 172 | 1 |
|  | | | | | | | | |
| | kleurset voor badafvoer-, overloop- en vulcombinatie | | | | | | | |
| | 0470610 | | chroom | 3622697000 | stuk | 153,00 | 172 | 1 |
| | 0471622 | | platina-mat | 3622697006 | stuk | 244,00 | 172 | 1 |
| | 0470334 | | messaging | 3622697009 | stuk | 244,00 | 172 | 1 |
|  | | | | | | | | |
| | douchethermostaat 1/2" z. hendel m. koppelingen | | | | | | | |
| | 0472522 | | chroom | 3442097000 | stuk | 468,00 | 172 | 0 |
| | 0471637 | | platina-mat | 3442097006 | stuk | 703,00 | 172 | 1 |
| | 0471620 | schaalgreep | platina-mat | 1142089006 | stuk | 211,00 | 172 | 1 |
| | 0472719 | temperatuurgreep | chroom | 1142022000 | stuk | 141,00 | 172 | 1 |
|  | | | | | | | | |

| Art.nr | Specificaties | Kleur | Lev.nr | Ehd | Prijs | Grp | CC |
|--------|---------------|-------|--------|-----|-------|-----|----|
|--------|---------------|-------|--------|-----|-------|-----|----|

Dornbracht Dreamscape

douchethermostaat z. hendel m. hoofddouche m. koppelingen

| | | | | | | | |
|---------|--|-------------|------------|------|---------|-----|---|
| 0474451 | | chrom | 3445597800 | stuk | 1585,00 | 172 | 1 |
| 0474453 | | platina-mat | 3445597806 | stuk | 2374,00 | 172 | 1 |



Sanitair producten

Baden /
douchebakken /
stoomcabines**Xstream kleurset inbouwkraan z. omstel**

| | | | | | | | |
|---------|---------------------------------------|-------------|------------|------|--------|-----|---|
| 0474456 | | chrom | 3601548000 | stuk | 315,00 | 172 | 1 |
| 0474457 | | platina-mat | 3601548006 | stuk | 457,00 | 172 | 1 |
| 0475910 | inbouwdeel voor inbouwbad/douchekraan | | 3511597090 | stuk | 288,00 | 172 | 0 |



Kranen

Douchegarnituur

Xstream kleurset inbouwkraan m. omstel

| | | | | | | | |
|---------|---------------------------------------|-------------|------------|------|--------|-----|---|
| 0474454 | | chrom | 3611548000 | stuk | 401,00 | 172 | 1 |
| 0474455 | | platina-mat | 3611548006 | stuk | 581,00 | 172 | 1 |
| 0475910 | inbouwdeel voor inbouwbad/douchekraan | | 3511597090 | stuk | 288,00 | 172 | 0 |

Accessoires en
spiegels

Douchewanden

afbouwdeel inbouwstopkraan

| | | | | | | | |
|---------|-------------------------------------|-------------|------------|------|--------|-----|---|
| 0472604 | | chrom | 3631048000 | stuk | 95,00 | 172 | 1 |
| 0472605 | | platina-mat | 3631048006 | stuk | 143,00 | 172 | 1 |
| 0472671 | inbouwdeel voor stopkraan koud 1/2" | | 3562197090 | stuk | 62,50 | 172 | 0 |
| 0472672 | inbouwdeel voor stopkraan warm 1/2" | | 3567197090 | stuk | 62,50 | 172 | 0 |
| 0472673 | inbouwdeel voor stopkraan koud 3/4" | | 3562297090 | stuk | 81,00 | 172 | 0 |
| 0472674 | inbouwdeel voor stopkraan warm 3/4" | | 3567297090 | stuk | 81,00 | 172 | 0 |
| 0472675 | inbouwdeel voor stopkraan koud 15mm | | 3563197090 | stuk | 62,50 | 172 | 0 |
| 0472676 | inbouwdeel voor stopkraan warm 15mm | | 3568197090 | stuk | 62,50 | 172 | 0 |
| 0472677 | inbouwdeel voor stopkraan koud 22mm | | 3563397090 | stuk | 81,00 | 172 | 1 |
| 0472678 | inbouwdeel voor stopkraan warm 22mm | | 3568397090 | stuk | 81,00 | 172 | 1 |

Toebehoren &
afvoerenSpoel- &
installatiesystemen

Dornbracht Dreamworks

Leverbaar tot 01-07-2007

1-gats wastafelkraan m. waste

| | | | | | | | |
|---------|--|-------------|------------|------|--------|-----|---|
| 0473857 | | chrom | 2251047000 | stuk | 404,00 | 172 | 1 |
| 0470257 | | platina-mat | 2251047006 | stuk | 546,00 | 172 | 1 |

Badkamermeubelen
en toiletkastenGootstenen en
wastroggen**3-gats wastafelkraan m. uitloop 160mm m. waste**

| | | | | | | | |
|---------|--|-------------|------------|------|--------|-----|---|
| 0473855 | | chrom | 2071047000 | stuk | 641,00 | 172 | 1 |
| 0470258 | | platina-mat | 2071047006 | stuk | 865,00 | 172 | 1 |



Utiliteit

New afbouwdeel 3-gats wandkraan

| | | | | | | | |
|---------|---|-------------|------------|------|--------|-----|---|
| 0433106 | 210mm | chrom | 3671247000 | stuk | 481,00 | 172 | 1 |
| 0433107 | 210mm | platina-mat | 3671247006 | stuk | 646,00 | 172 | 1 |
| 0433043 | inbouwset voor 3-gats muurkraan m. bronzen inbouwhuis | | 3570797090 | stuk | 167,00 | 172 | 0 |
| 0433044 | inbouwset voor 3-gats muurkraan m. 3 bronzen inbouwhuizen | | 3571297090 | stuk | 147,00 | 172 | 0 |

**1-gats bidetkraan m. waste**











| | | | | | | | |
|---------|--|-------------|------------|------|--------|-----|---|
| 0474061 | | chrom | 2451047000 | stuk | 476,00 | 172 | 1 |
| 0470263 | | platina-mat | 2451047006 | stuk | 643,00 | 172 | 1 |









**thermostaat voor staande montage z. hendel**

| | | | | | | | |
|---------|-------------------------|-------------|------------|------|---------|-----|---|
| 0472765 | | chrom | 3452597000 | stuk | 1373,00 | 172 | 1 |
| 0471618 | | platina-mat | 3452597006 | stuk | 1681,00 | 172 | 1 |
| 0470588 | schaalgreep chrom | | 1142089000 | stuk | 141,00 | 172 | 0 |
| 0471620 | schaalgreep platina-mat | | 1142089006 | stuk | 211,00 | 172 | 1 |
| 0472719 | temperatuurgreep chrom | | 1142022000 | stuk | 141,00 | 172 | 1 |



| | Art.nr | Specificaties | Kleur | Lev.nr | Ehd | Prijs | Grp | CC |
|---|--|---|-------------|------------|------|---------|-----|----|
| | Dornbracht Dreamworks | | | | | | | |
| Sanitair producten | kleurset voor badafvoer-, overloop- en vulcombinatie | | | | | | | |
| | 0470610 | | chrom | 3622697000 | stuk | 153,00 | 172 | 1 |
| | 0471622 | | platina-mat | 3622697006 | stuk | 244,00 | 172 | 1 |
| | 0470334 | | messing | 3622697009 | stuk | 244,00 | 172 | 1 |
| Baden / douchebakken / stoomcabines | badkraan m. garnituur m. koppelingen | | | | | | | |
| Kranen | 0474029 | | chrom | 2513347000 | stuk | 890,00 | 172 | 1 |
| | 0470264 | | platina-mat | 2513347006 | stuk | 1201,00 | 172 | 1 |
| | douchekraan 1/2" z. omstel m. koppelingen | | | | | | | |
| Douchegarnituur | 0474223 | | chrom | 2610047000 | stuk | 518,00 | 172 | 1 |
| | 0470266 | | platina-mat | 2610047006 | stuk | 699,00 | 172 | 1 |
| | douchethermostaat 1/2" z. hendel m. koppelingen | | | | | | | |
| Accessoires en spiegels | 0472522 | | chrom | 3442097000 | stuk | 468,00 | 172 | 0 |
| | 0471637 | | platina-mat | 3442097006 | stuk | 703,00 | 172 | 1 |
| | 0471620 | schaalgreep | platina-mat | 1142089006 | stuk | 211,00 | 172 | 1 |
| | 0472719 | temperatuurgreep | chrom | 1142022000 | stuk | 141,00 | 172 | 1 |
| Douchewanden | douchethermostaat z. hendel m. hoofddouche m. koppelingen | | | | | | | |
| Toebehoren & afvoeren | 0474451 | | chrom | 3445597800 | stuk | 1585,00 | 172 | 1 |
| | 0474453 | | platina-mat | 3445597806 | stuk | 2374,00 | 172 | 1 |
| | Xtool afbouwdeel inbouwthermostaat z. stopkraan | | | | | | | |
| Spoel- & installatiesystemen | 0272611 | | chrom | 3641697800 | stuk | 354,00 | 172 | 1 |
| | afbouwdeel inbouwstopkraan | | | | | | | |
| Badkamermeubelen en toiletkasten | 0472606 | | chrom | 3631047000 | stuk | 95,00 | 172 | 1 |
| | 0472607 | | platina-mat | 3631047006 | stuk | 143,00 | 172 | 1 |
| | 0472671 | inbouwdeel voor stopkraan koud 1/2" | | 3562197090 | stuk | 62,50 | 172 | 0 |
| | 0472673 | inbouwdeel voor stopkraan koud 3/4" | | 3562297090 | stuk | 81,00 | 172 | 0 |
| | 0472675 | inbouwdeel voor stopkraan koud 15mm | | 3563197090 | stuk | 62,50 | 172 | 0 |
| | 0472677 | inbouwdeel voor stopkraan koud 22mm | | 3563397090 | stuk | 81,00 | 172 | 1 |
| Gootstenen en wastroggen | Dornbracht eMote | | | | | | | |
| Utiliteit | inbouwset voor infrarood wandkraan | | | | | | | |
| | 0474591 | | | 3573097090 | stuk | 529,00 | 172 | 1 |
| | afbouwdeel wandkraan infrarood 17cm z. mengknop | | | | | | | |
| | 0474547 | | chrom | 3675185000 | stuk | 587,00 | 172 | 1 |
| | 0474591 | inbouwset voor infrarood wandkraan | | 3573097090 | stuk | 529,00 | 172 | 1 |
| | afbouwdeel wandkraan infrarood 20cm z. mengknop | | | | | | | |
| | 0474548 | | chrom | 3675285000 | stuk | 598,00 | 172 | 1 |
| | 0474591 | inbouwset voor infrarood wandkraan | | 3573097090 | stuk | 529,00 | 172 | 1 |
| | Dornbracht eTech | | | | | | | |
| | afbouwdeel voor infrarood inbouwwandkraan | | | | | | | |
| | 0433136 | | chrom | 3673110000 | stuk | 674,00 | 172 | 1 |
| | 0433137 | | platina-mat | 3673110006 | stuk | 1011,00 | 172 | 1 |
| | 0433137 | afbouwdeel voor infrarood inbouwwandkraan | platina-mat | 3673110006 | stuk | 1011,00 | 172 | 1 |

| Art.nr | Specificaties | Kleur | Lev.nr | Ehd | Prijs | Grp | CC | | |
|---|---------------|-------|------------|------|---------|-----|----|---|---|
| | | | | | | | | Dornbracht Giorno | |
| Leverbaar tot 01-07-2007 | | | | | | | | | |
| 1-gats wastafelkraan 135mm m. waste 0473448 | | chrom | 3350075000 | stuk | 474,00 | 172 | 1 |  | Sanitair producten |
| 3-gats wastafelkraan m. waste 0473812 | | chrom | 2070075000 | stuk | 663,00 | 172 | 1 |  | Baden / douchebakken / stoomcabines |
| hoekstopkraan 1/2" 0473863 | | chrom | 2290075000 | stuk | 104,00 | 172 | 1 |  | Kranen |
| 1-gats bidetkraan m. waste 0473456 | | chrom | 3360075000 | stuk | 592,00 | 172 | 1 |  | Douchegarnituur |
| 4-gats badkraan 0473421 | | chrom | 2751275000 | stuk | 1326,00 | 172 | 1 |  | Accessoires en spiegels |
| 0470155 Perfecto montagesysteem 1/2" voor 4-gats kraan | | | 1261097090 | stuk | 555,00 | 172 | 0 | | |
| 0470163 Perfecto sierrozetten voor montagesysteem | chrom | | 1280197000 | stuk | 27,75 | 172 | 0 | | |
| douchethermostaat 1/2" z. hendel m. koppelingen 0472522 | | chrom | 3442097000 | stuk | 468,00 | 172 | 0 |  | Douchewanden |
| 0470588 schaalgreep | chrom | | 1142089000 | stuk | 141,00 | 172 | 0 | | |
| 0472719 temperatuurgreep | chrom | | 1142022000 | stuk | 141,00 | 172 | 1 | | |
| 0473871 temperatuurgreep | chrom | | 1142075000 | stuk | 135,00 | 172 | 1 | | |
| douchethermostaat z. hendel m. hoofddouche m. koppelingen 0474451 | | chrom | 3445597800 | stuk | 1585,00 | 172 | 1 |  | Badkamermeubelen en toiletkasten |
| 0472891 kruisgreep | chrom | | 1142047000 | stuk | 141,00 | 172 | 1 | | |
| 0473871 temperatuurgreep | chrom | | 1142075000 | stuk | 135,00 | 172 | 1 | | |
| Xstream kleurset inbouwkraan m. omstel 0474458 | | chrom | 3611575000 | stuk | 401,00 | 172 | 1 |  | Gootstenen en wastroggen |
| 0475910 inbouwdeel voor inbouwbad/douchekraan | | | 3511597090 | stuk | 288,00 | 172 | 0 | | |
| Xstream kleurset inbouwkraan z. omstel 0474459 | | chrom | 3601575000 | stuk | 311,00 | 172 | 1 |  | Utiliteit |
| 0475910 inbouwdeel voor inbouwbad/douchekraan | | | 3511597090 | stuk | 288,00 | 172 | 0 | | |
| kleurset voor badafvoer-, overloop- en vulcombinatie 0470610 | | chrom | 3622697000 | stuk | 153,00 | 172 | 1 |  | |

| | Art.nr | Specificaties | Kleur | Lev.nr | Ehd | Prijs | Grp | CC | |
|---|---|---------------|--|------------|------------|--------|---------|-----|---|
| Sanitair producten | Dornbracht Giorno | | | | | | | | |
| | temperatuurgreep | | | | | | | | |
| |  | 0473871 | chrom | 1142075000 | stuk | 135,00 | 172 | 1 | |
| Baden / douchebakken / stoomcabines | | | | | | | | | |
| Kranen | Dornbracht Lulu | | | | | | | | |
| | wastafelkraan m. waste | | | | | | | | |
| |  | 0272527 | sprong 125mm | chrom | 3350571000 | stuk | 445,00 | 172 | 1 |
| | | 0272526 | sprong 155mm | chrom | 3350071000 | stuk | 481,00 | 172 | 1 |
| Douchegarnituur | | | | | | | | | |
| Accessoires en spiegels | wastafelkraan z. waste | | | | | | | | |
| |  | 0272528 | sprong 125mm | chrom | 3352571000 | stuk | 414,00 | 172 | 1 |
| Douchewanden | | | | | | | | | |
| Toebehoren & afvoeren | verhoogde wastafelkraan z. waste | | | | | | | | |
| |  | 0272529 | sprong 215mm | chrom | 3353471000 | stuk | 650,00 | 172 | 1 |
| Spoel- & installatiesystemen | | | | | | | | | |
| Badkamermeubelen en toiletkasten | vrijstaande wastafelkraan z. waste | | | | | | | | |
| |  | 0272530 | sprong 215mm | chrom | 3358471000 | stuk | 1423,00 | 172 | 1 |
| | | 0272531 | inbouwset voor vloerbevestiging 1/2" | | 3594597090 | stuk | 419,00 | 172 | 1 |
| Badkamermeubelen en toiletkasten | | | | | | | | | |
| Gootstenen en wastroggen | inbouwset voor vloerbevestiging 1/2" | | | | | | | | |
| | | 0272531 | | | 3594597090 | stuk | 419,00 | 172 | 1 |
| Utiliteit | afbouwset voor wandkraan m. vaste uitloop | | | | | | | | |
| |  | 0272532 | sprong 200mm | chrom | 3681271000 | stuk | 398,00 | 172 | 1 |
| | | 0433129 | inbouwdeel eenhendelkraan rechts voor achterwand (Soho / Vero) | | 3581697090 | stuk | 193,00 | 172 | 1 |
| | | 0475432 | inbouwdeel wastafelwandkraan rechts | | 3580697090 | stuk | 168,00 | 172 | 0 |
| | | 0475527 | inbouwdeel wastafelwandkraan links | | 3580797090 | stuk | 168,00 | 172 | 0 |
| Utiliteit | bidetkraan m. waste | | | | | | | | |
| |  | 0272533 | sprong 125mm | chrom | 3360071000 | stuk | 601,00 | 172 | 1 |
| | | | | | | | | | |
| Utiliteit | vrijstaande badkraan m. standpijpen | | | | | | | | |
| | | 0272534 | | chrom | 2596371000 | stuk | 2264,00 | 172 | 1 |
| | | 0272531 | inbouwset voor vloerbevestiging 1/2" | | 3594597090 | stuk | 419,00 | 172 | 1 |
| Utiliteit | 3-gats badrandcombinatie | | | | | | | | |
| |  | 0272535 | | chrom | 2731271000 | stuk | 1087,00 | 172 | 1 |
| | | 0470155 | Perfecto montagesysteem 1/2" voor 4-gats kraan | | 1261097090 | stuk | 555,00 | 172 | 0 |
| | | 0470163 | Perfecto sierrozetten voor montagesysteem | chrom | 1280197000 | stuk | 27,75 | 172 | 0 |

| Art.nr | Specificaties | Kleur | Lev.nr | Ehd | Prijs | Grp | CC | |
|--|---------------|-------|------------|------|---------|-----|----|---|
| | | | | | | | | Dornbracht Lulu |
| badkraan voor bad-/tegelrandcombinatie 0272536 | | chrom | 2920071000 | stuk | 384,00 | 172 | 1 |  |
| vrijstaande baduitloop m. standpijp 0272537 sprong 215mm | | chrom | 1367271000 | stuk | 1124,00 | 172 | 1 | |
| 0272531 inbouwset voor vloerbevestiging 1/2" | | | 3594597090 | stuk | 419,00 | 172 | 1 | |
| baduitloop m. omstel 0272538 sprong 215mm | | chrom | 1351271000 | stuk | 474,00 | 172 | 1 |  |
| baduitloop voor wandmontage 0272539 sprong 200mm | | chrom | 1380171000 | stuk | 316,00 | 172 | 1 |  |
| badkraan m. garnituur 0272540 | | chrom | 3323371000 | stuk | 834,00 | 172 | 1 |  |
| badkraan z. garnituur 0272541 | | chrom | 3320071000 | stuk | 556,00 | 172 | 1 | |
| 0272542 adapter voor doucheuitlaat 3/8" chrom | | | 1220297900 | stuk | 25,00 | 172 | 1 |  |
| 2-weg omstel voor badrandkraan 0475103 | | chrom | 2914071000 | stuk | 427,90 | 172 | 1 | |
| adapter voor doucheuitlaat 3/8" 0272542 | | chrom | 1220297900 | stuk | 25,00 | 172 | 1 | |
| douchekraan 0272543 | | chrom | 3330071000 | stuk | 441,00 | 172 | 1 | |
| 0272542 adapter voor doucheuitlaat 3/8" chrom | | | 1220297900 | stuk | 25,00 | 172 | 1 |  |
| X-stream afbouwset voor inbouwbadkraan 0272544 | | chrom | 3611571000 | stuk | 394,00 | 172 | 1 | |
| 0272620 Xstream verlengset 20mm | | | 1207397090 | stuk | 149,00 | 172 | 1 | |
| 0475910 inbouwdeel voor inbouwbad/douchekraan | | | 3511597090 | stuk | 288,00 | 172 | 0 |  |

Sanitair producten

Baden /
douchebakken /
stoomcabines

Kranen









Douchegarnituur









Accessoires en
spiegels

Douchewanden

Toebehoren &
afvoerenSpoel- &
installatiesystemenBadkamermeubelen
en toiletkastenGootstenen en
wastroggen

Utiliteit

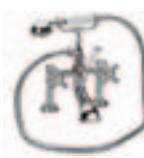
| | Art.nr | Specificaties | Kleur | Lev.nr | Ehd | Prijs | Grp | CC |
|---|--|---|-------------|------------|--------|---------|-----|----|
| | Dornbracht Lulu | | | | | | | |
| Sanitair producten | X-stream afbouwset voor inbouwdouchekraan | | | | | | | |
| | | 0272545 | chroom | 3601571000 | stuk | 281,00 | 172 | 1 |
| | | 0272619 Xstream verlengset 20mm | | 1207297090 | stuk | 130,00 | 172 | 1 |
| | 0475910 | inbouwdeel voor inbouwbad/douchekraan | | 3511597090 | stuk | 288,00 | 172 | 0 |
| Baden / douchebakken / stoomcabines |  | | | | | | | |
| | afbouwset voor inbouwdouchekraan | | | | | | | |
| Kranen | | 0272546 | chroom | 3600871000 | stuk | 222,00 | 172 | 1 |
| | | 0475537 inbouwdeel voor inbouwdouchekraan | | 3500897090 | stuk | 171,00 | 172 | 0 |
| Douchegarnituur |  | | | | | | | |
| | X-tool afbouwset voor inbouwthermostaat | | | | | | | |
| Accessoires en spiegels | | 0272547 | chroom | 3641671000 | stuk | 371,00 | 172 | 1 |
| | | 0474650 Xtool inbouwdeel voor inbouwthermostaat z. stopkraan 1/2" | | 3541697090 | stuk | 542,00 | 172 | 0 |
| | | 0474651 Xtool inbouwdeel voor inbouwthermostaat z. stopkraan 3/4" | | 3551697090 | stuk | 712,00 | 172 | 0 |
| Douchewanden |  | | | | | | | |
| | afbouwset voor stopkraanmoduul m. 3 stopkranen | | | | | | | |
| Toebehoren & afvoeren | | 0272548 | chroom | 3633071000 | stuk | 357,00 | 172 | 1 |
| | | 0433051 Xtool inbouwmoduul 3-stopkranen | | 3553697090 | stuk | 1002,00 | 172 | 0 |
| Douchewanden |  | | | | | | | |
| | afbouwset voor inbouwstopkraan | | | | | | | |
| Spoel- & installatiesystemen | | 0272549 | chroom | 3631071000 | stuk | 96,50 | 172 | 1 |
| | | 0472671 inbouwdeel voor stopkraan koud 1/2" | | 3562197090 | stuk | 62,50 | 172 | 0 |
| | | 0472673 inbouwdeel voor stopkraan koud 3/4" | | 3562297090 | stuk | 81,00 | 172 | 0 |
| | | 0472675 inbouwdeel voor stopkraan koud 15mm | | 3563197090 | stuk | 62,50 | 172 | 0 |
| | | 0472677 inbouwdeel voor stopkraan koud 22mm | | 3563397090 | stuk | 81,00 | 172 | 1 |
| Badkamermeubelen en toiletkasten |  | | | | | | | |
| | Dornbracht Madison | | | | | | | |
| Gootstenen en wastroggen | toiletkraan koud 1/2" | | | | | | | |
| | | 0470007 | chroom | 1750036000 | stuk | 156,00 | 172 | 1 |
| | | 0470194 | platina-mat | 1750036006 | stuk | 234,00 | 172 | 1 |
| | 0470589 | messaging | 1750036009 | stuk | 234,00 | 172 | 1 | |
| Utiliteit |  | | | | | | | |
| | toiletkraan koud wandmodel | | | | | | | |
| Utiliteit | | 0470009 | chroom | 3001036000 | stuk | 167,00 | 172 | 1 |
| | | 0470199 | platina-mat | 3001036006 | stuk | 251,00 | 172 | 1 |
| | | 0474096 | messaging | 3001036009 | stuk | 251,00 | 172 | 1 |
| Utiliteit |  | | | | | | | |
| | 1-gats wastafelkraan vaste lage uitloop 130mm m. waste | | | | | | | |
| Utiliteit | | 0470090 | chroom | 2250036000 | stuk | 481,00 | 172 | 1 |
| | | 0470169 | platina-mat | 2250036006 | stuk | 727,00 | 172 | 1 |
| | | 0470600 | messaging | 2250036009 | stuk | 727,00 | 172 | 1 |
| Utiliteit |  | | | | | | | |
| | 1-gats wastafelkraan vaste lage uitloop 100mm m. waste | | | | | | | |
| Utiliteit | | 0470251 | chroom | 2230536000 | stuk | 457,00 | 172 | 1 |
| | | 0470170 | platina-mat | 2230536006 | stuk | 685,00 | 172 | 1 |
| | | 0470260 | messaging | 2230536009 | stuk | 685,00 | 172 | 1 |
| Utiliteit |  | | | | | | | |

| Art.nr | Specificaties | Kleur | Lev.nr | Ehd | Prijs | Grp | CC | | |
|--|---|-------------|-------------------|------|---------|-----|----|---|---|
| | | | | | | | | Dornbracht Madison | |
| 1-gats wastafelkraan hoge uitloop 200mm m. waste | | | | | | | | | |
| 0470684 | | chroom | 2251236000 | stuk | 721,00 | 172 | 1 |  | Sanitair producten |
| 0470174 | | platina-mat | 2251236006 | stuk | 1082,00 | 172 | 1 | | |
| 0470705 | | messaging | 2251236009 | stuk | 1082,00 | 172 | 1 | | |
| 3-gats wastafelkraan vaste lage uitloop 135mm m. waste | | | | | | | | | |
| 0470015 | | chroom | 2070036000 | stuk | 764,00 | 172 | 1 |  | Baden / douchebakken / stoomcabines |
| 0470193 | | platina-mat | 2070036006 | stuk | 1146,00 | 172 | 1 | | |
| 3-gats wastafelkraan hoge uitloop 200mm m. waste | | | | | | | | | |
| 0473359 | | chroom | 2071536000 | stuk | 958,00 | 172 | 1 |  | Douchegarnituur |
| 0470012 | | platina-mat | 2071536006 | stuk | 1436,00 | 172 | 1 | | |
| 0473369 | | messaging | 2071536009 | stuk | 1436,00 | 172 | 1 | | |
| hoekstopkraan koud m. rozet | | | | | | | | | |
| 0470104 | 1/2"x10mm | chroom | 2290036000 | stuk | 105,00 | 172 | 1 |  | Accessoires en spiegels |
| 0470195 | 1/2"x10mm | platina-mat | 2290036006 | stuk | 158,00 | 172 | 1 | | |
| 0470651 | 1/2"x10mm | messaging | 2290036009 | stuk | 158,00 | 172 | 1 | | |
| hoekstopkraan warm m. rozet | | | | | | | | | |
| 0470112 | 1/2"x10mm | chroom | 2290036100 | stuk | 105,00 | 172 | 1 | | Douchewanden |
| 0470196 | 1/2"x10mm | platina-mat | 2290036106 | stuk | 158,00 | 172 | 1 | | |
| 0470678 | 1/2"x10mm | messaging | 2290036109 | stuk | 158,00 | 172 | 1 | | |
| New afbouwdeel 3-gats wandkraan | | | | | | | | | |
| 0433102 | | chroom | 3671236000 | stuk | 578,00 | 172 | 1 |  | Toebehoren & afvoeren |
| 0433103 | | platina-mat | 3671236006 | stuk | 863,00 | 172 | 1 | | |
| 0433112 | | messaging | 3671236009 | stuk | 863,00 | 172 | 1 | | |
| 0433043 | inbouwset voor 3-gats muurkraan m. bronzen inbouwhuis | | 3570797090 | stuk | 167,00 | 172 | 0 | | Spoel- & installatiesystemen |
| 0433044 | inbouwset voor 3-gats muurkraan m. 3 bronzen inbouwhuizen | | 3571297090 | stuk | 147,00 | 172 | 0 | | |
| 1-gats bidetkraan m. waste | | | | | | | | | |
| 0470120 | | chroom | 2451036000 | stuk | 601,00 | 172 | 1 |  | Badkamermeubelen en toiletkasten |
| 0470200 | | platina-mat | 2451036006 | stuk | 902,00 | 172 | 1 | | |
| 0470643 | | messaging | 2451036009 | stuk | 902,00 | 172 | 1 | | |
| badkraan m. garnituur m. standpijpen | | | | | | | | | |
| 0473243 | | chroom | 2594336000 | stuk | 2052,00 | 172 | 1 |  | Gootstenen en wastroggen |
| 0470202 | | platina-mat | 2594336006 | stuk | 3078,00 | 172 | 1 | | |
| 0470308 | | messaging | 2594336009 | stuk | 3078,00 | 172 | 1 | | |
| badkraan staand m. garnituur | | | | | | | | | |
| 0473235 | | chroom | 2503336000 | stuk | 960,00 | 172 | 1 |  | Utiliteit |
| 0470203 | | platina-mat | 2503336006 | stuk | 1454,00 | 172 | 1 | | |
| 0470307 | | messaging | 2503336009 | stuk | 1454,00 | 172 | 1 | | |
| 4-gats badkraan 225mm m. omstel m. garnituur m. uitloop | | | | | | | | | |
| 0470058 | | chroom | 2750236000 | stuk | 1616,00 | 172 | 1 |  | |
| 0470635 | | messaging | 2750236009 | stuk | 2181,00 | 172 | 1 | | |
| 0470204 | | platina-mat | 2750236006 | stuk | 2181,00 | 172 | 1 | | |
| 0470155 | Perfecto montagesysteem 1/2" voor 4-gats kraan | | 1261097090 | stuk | 555,00 | 172 | 0 | | |
| 0470163 | Perfecto sierrozetten voor montagesysteem | | chroom 1280197000 | stuk | 27,75 | 172 | 0 | | |

| | Art.nr | Specificaties | Kleur | Lev.nr | Ehd | Prijs | Grp | CC |
|--|---|-------------------------|-------------|------------|------|---------|-----|----|
| | Dornbracht Madison | | | | | | | |
| | thermostaat voor staande montage z. hendel | | | | | | | |
| Sanitair producten | 0472765 | | chroom | 3452597000 | stuk | 1373,00 | 172 | 1 |
| | 0471618 | | platina-mat | 3452597006 | stuk | 1681,00 | 172 | 1 |
| | 0470588 | schaalgreep chroom | | 1142089000 | stuk | 141,00 | 172 | 0 |
| | 0471620 | schaalgreep platina-mat | | 1142089006 | stuk | 211,00 | 172 | 1 |
| Baden / douchebakken / stoomcabines | 0472719 | temperatuurgreep chroom | | 1142022000 | stuk | 141,00 | 172 | 1 |
| | douchegarnituur voor badrand | | | | | | | |
| Kranen | 0470013 | | chroom | 2770336000 | stuk | 309,00 | 172 | 1 |
| | 0470205 | | platina-mat | 2770336006 | stuk | 459,00 | 172 | 1 |
| | 0470311 | | messaging | 2770336009 | stuk | 459,00 | 172 | 1 |
| Douchegarnituur | baduitloop wandmontage | | | | | | | |
| Accessoires en spiegels | 0472613 | 3/4"x17cm | chroom | 1380138000 | stuk | 538,00 | 172 | 1 |
| | 0470206 | 3/4"x17cm | platina-mat | 1380138006 | stuk | 726,00 | 172 | 1 |
| | 0470309 | 3/4"x17cm | messaging | 1380138009 | stuk | 726,00 | 172 | 1 |
| Douchewanden | kleurset voor badafvoer-, overloop- en vulcombinatie | | | | | | | |
| Toebehoren & afvoeren | 0470610 | | chroom | 3622697000 | stuk | 153,00 | 172 | 1 |
| | 0471622 | | platina-mat | 3622697006 | stuk | 244,00 | 172 | 1 |
| | 0470334 | | messaging | 3622697009 | stuk | 244,00 | 172 | 1 |
| Spoel- & installatiesystemen | badkraan m. omstel m. koppelingen z. garnituur | | | | | | | |
| Badkamermeubelen en toiletkasten | 0470139 | | chroom | 2502336000 | stuk | 836,00 | 172 | 1 |
| | 0470627 | | messaging | 2502336009 | stuk | 1253,00 | 172 | 1 |
| | 0470629 | | platina-mat | 2502336006 | stuk | 1253,00 | 172 | 1 |
| Gootstenen en wastroggen | badkraan m. omstel z. garnituur m. koppelingen | | | | | | | |
| Utiliteit | 0441239 | | chroom | 2500036000 | stuk | 554,00 | 172 | 1 |
| | 0470207 | | platina-mat | 2500036006 | stuk | 831,00 | 172 | 1 |
| | 0470306 | | messaging | 2500036009 | stuk | 831,00 | 172 | 1 |
| douchekraan HOH=15cm z. omstel m. koppelingen | | | | | | | | |
| | 0470223 | | chroom | 2610136000 | stuk | 409,00 | 172 | 1 |
| | 0470208 | | platina-mat | 2610136006 | stuk | 613,00 | 172 | 1 |
| | 0470619 | | messaging | 2610136009 | stuk | 613,00 | 172 | 1 |
| douchekraan m. regendouche m. garnituur m koppelingen | | | | | | | | |
| | 0290052 | | chroom | 2660136000 | stuk | 1705,00 | 172 | 1 |
| | 0470209 | | platina-mat | 2660136006 | stuk | 2557,00 | 172 | 1 |
| | 0470305 | | messaging | 2660136009 | stuk | 2557,00 | 172 | 1 |
| douchethermostaat 1/2" z. hendel m. koppelingen | | | | | | | | |
| | 0472522 | | chroom | 3442097000 | stuk | 468,00 | 172 | 0 |
| | 0470049 | | messaging | 3442097009 | stuk | 703,00 | 172 | 1 |
| | 0471637 | | platina-mat | 3442097006 | stuk | 703,00 | 172 | 1 |
| | 0471620 | schaalgreep platina-mat | | 1142089006 | stuk | 211,00 | 172 | 1 |
| | 0472719 | temperatuurgreep chroom | | 1142022000 | stuk | 141,00 | 172 | 1 |
| Xtool afbouwdeel inbouwthermostaat z. stopkraan | | | | | | | | |
| | 0272607 | | chroom | 3641697700 | stuk | 354,00 | 172 | 1 |
| | 0272608 | | platina-mat | 3641697706 | stuk | 530,00 | 172 | 1 |
| | 0272609 | | messaging | 3641697709 | stuk | 530,00 | 172 | 1 |

| Art.nr | Specificaties | Kleur | Lev.nr | Ehd | Prijs | Grp | CC |
|--------|---------------|-------|--------|-----|-------|-----|----|
|--------|---------------|-------|--------|-----|-------|-----|----|

Dornbracht Madison

New afbouwdeel 2/3 weg omstel

| | | | | | | | |
|---------|---------------------------------|-------------|------------|------|--------|-----|---|
| 0433104 | | chroom | 3610436000 | stuk | 220,00 | 172 | 1 |
| 0433105 | | platina-mat | 3610436006 | stuk | 359,00 | 172 | 1 |
| 0433059 | 2-weg omstel voor inbouwmontage | chroom | 3512497090 | stuk | 211,00 | 172 | 0 |
| 0433060 | 3-weg omstel voor inbouwmontage | chroom | 3510497090 | stuk | 257,00 | 172 | 1 |



Sanitair producten

Baden /
douchebakken /
stoomcabines

afbouwdeel inbouwstopkraan

| | | | | | | | |
|---------|-------------------------------------|-------------|------------|------|--------|-----|---|
| 0472685 | koud/warm | chroom | 3631036000 | stuk | 115,00 | 172 | 1 |
| 0470215 | koud/warm | platina-mat | 3631036006 | stuk | 166,00 | 172 | 1 |
| 0272610 | koud/warm | messaging | 3631036009 | stuk | 166,00 | 172 | 1 |
| 0472671 | inbouwdeel voor stopkraan koud 1/2" | | 3562197090 | stuk | 62,50 | 172 | 0 |
| 0472673 | inbouwdeel voor stopkraan koud 3/4" | | 3562297090 | stuk | 81,00 | 172 | 0 |
| 0472675 | inbouwdeel voor stopkraan koud 15mm | | 3563197090 | stuk | 62,50 | 172 | 0 |
| 0472677 | inbouwdeel voor stopkraan koud 22mm | | 3563397090 | stuk | 81,00 | 172 | 1 |



Kranen

Douchegarnituur

Dornbracht Madison Flair

hendelinzet los groot

| | | | | | | | |
|---------|--|-------------|------------|------|-------|-----|---|
| 0470246 | | platina-mat | 1117037006 | stuk | 56,00 | 172 | 1 |
| 0472549 | | wit | 1117037012 | stuk | 56,00 | 172 | 1 |

Accessoires en
spiegels

2-gats keuken-/wastafelkraan z. hendel

| | | | | | | | |
|---------|-----------------------|-------------|------------|------|---------|-----|---|
| 0474169 | | chroom | 1912537000 | stuk | 743,00 | 172 | 1 |
| 0470249 | | platina-mat | 1912537006 | stuk | 1114,00 | 172 | 1 |
| 0470246 | hendelinzet los groot | platina-mat | 1117037006 | stuk | 56,00 | 172 | 1 |



Douchewanden

Toebehoren &
afvoeren

2-gats badkraan z. hendel

| | | | | | | | |
|---------|--|-------------|------------|------|---------|-----|---|
| 0470253 | | platina-mat | 2503337006 | stuk | 1326,00 | 172 | 1 |
| 0474266 | | messaging | 2503337009 | stuk | 1326,00 | 172 | 1 |

Spoel- &
installatiesystemenBadkamermeubelen
en toiletkasten

4-gats badrandcombinatie z. hendel

| | | | | | | | |
|---------|--|-------------|------------|------|---------|-----|---|
| 0474207 | | chroom | 2750237000 | stuk | 1582,00 | 172 | 1 |
| 0470254 | | platina-mat | 2750237006 | stuk | 2135,00 | 172 | 1 |
| 0474215 | | messaging | 2750237009 | stuk | 2135,00 | 172 | 1 |
| 0470155 | Perfecto montagesysteem 1/2" voor 4-gats kraan | | 1261097090 | stuk | 555,00 | 172 | 0 |
| 0470163 | Perfecto sierrozetten voor montagesysteem | chroom | 1280197000 | stuk | 27,75 | 172 | 0 |
| 0472549 | hendelinzet los groot | wit | 1117037012 | stuk | 56,00 | 172 | 1 |

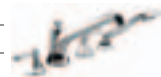
Gootstenen en
wastroggen

thermostaat voor staande montage z. hendel

| | | | | | | | |
|---------|------------------|-------------|------------|------|---------|-----|---|
| 0472765 | | chroom | 3452597000 | stuk | 1373,00 | 172 | 1 |
| 0471618 | | platina-mat | 3452597006 | stuk | 1681,00 | 172 | 1 |
| 0470588 | schaalgreep | chroom | 1142089000 | stuk | 141,00 | 172 | 0 |
| 0471620 | schaalgreep | platina-mat | 1142089006 | stuk | 211,00 | 172 | 1 |
| 0472719 | temperatuurgreep | chroom | 1142022000 | stuk | 141,00 | 172 | 1 |



Utiliteit

badkraan m. omstel m. garnituur z. hendel m.koppelingen









| | | | | | | | |
|---------|--|-------------|------------|------|---------|-----|---|
| 0474225 | | chroom | 2502337000 | stuk | 762,00 | 172 | 1 |
| 0470255 | | platina-mat | 2502337006 | stuk | 1126,00 | 172 | 1 |
| 0474231 | | messaging | 2502337009 | stuk | 1126,00 | 172 | 1 |



















douchekraan z. omstel z. hendel m. koppelingen







| | | | | | | | |
|---------|--|-------------|------------|------|--------|-----|---|
| 0474274 | | chroom | 2610137000 | stuk | 303,00 | 172 | 1 |
| 0470256 | | platina-mat | 2610137006 | stuk | 454,00 | 172 | 1 |
| 0474282 | | messaging | 2610137009 | stuk | 454,00 | 172 | 1 |



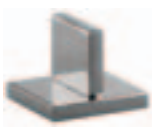







| | Art.nr | Specificaties | Kleur | Lev.nr | Ehd | Prijs | Grp | CC |
|---|---|--|-------------------------------------|------------|--------|------------|------|--------------|
| | Dornbracht Madison Flair | | | | | | | |
| Sanitair producten | douchethermostaat 1/2" z. hendel m. koppelingen | | | | | | | |
| |  | 0472522 | chroom | 3442097000 | stuk | 468,00 | 172 | 0 |
| | | 0470049 | messaging | 3442097009 | stuk | 703,00 | 172 | 1 |
| | | 0471637 | platina-mat | 3442097006 | stuk | 703,00 | 172 | 1 |
| Baden / douchebakken / stoomcabines | | 0471620 schaalgreep platina-mat | | 1142089006 | stuk | 211,00 | 172 | 1 |
| | | 0472719 temperatuurgreep chroom | | 1142022000 | stuk | 141,00 | 172 | 1 |
| Kranen | kleurset voor badafvoer-, overloop- en vulcombinatie | | | | | | | |
| |  | 0470610 | chroom | 3622697000 | stuk | 153,00 | 172 | 1 |
| | | 0471622 | platina-mat | 3622697006 | stuk | 244,00 | 172 | 1 |
| | | 0470334 | messaging | 3622697009 | stuk | 244,00 | 172 | 1 |
| | Dornbracht Mem | | | | | | | |
| Douchegarnituur | wastafelkraan m. vaste uitloop | | | | | | | |
| | | 0272582 sprong 165mm | chroom | 3350078000 | stuk | 569,00 | 172 | 1 |
| Accessoires en spiegels |  | 2-gats wastafelkraan m. afdekplaat m. waste | | 0474510 | chroom | 3354378000 | stuk | 549,00 172 1 |
| | | | | | | | | |
| Douchewanden | | | | | | | | |
| Toebehoren & afvoeren |  | 2-gats wastafelkraan m. sokkel m. waste | | 0474511 | chroom | 3351378000 | stuk | 596,00 172 1 |
| | | | | | | | | |
| Spoel- & installatiesystemen |  | 3-gats wastafelkraan m. rozetten m. waste | | 0474512 | chroom | 2071378000 | stuk | 759,00 172 1 |
| | | | | | | | | |
| Badkamermeubelen en toiletkasten | | | | | | | | |
| Gootstenen en wastroggen |  | 3-gats wastafelkraan m. afdekplaat m. waste | | 0474513 | chroom | 2072378000 | stuk | 830,00 172 1 |
| | | | | | | | | |
| Utiliteit | | 3-gats wastafelkraan verhoogd | | 0272583 | chroom | 2071878000 | stuk | 911,00 172 1 |
| | | | | | | | | |
| |  | 2-gats wastafelkraan 165mm m. rozetten m. waste | | 0433022 | chroom | 3251378000 | stuk | 526,00 172 1 |
| | | | | | | | | |
| |  | 2-gats wandkraan m. rozetten | | 0474514 | chroom | 3681078000 | stuk | 419,00 172 1 |
| | | 0475432 | inbouwdeel wastafelwandkraan rechts | | | 3580697090 | stuk | 168,00 172 0 |
| | | 0475459 | inbouwdeel wastafelwandkraan boven | | | 3580897090 | stuk | 168,00 172 1 |
| | | 0475527 | inbouwdeel wastafelwandkraan links | | | 3580797090 | stuk | 168,00 172 0 |

| Art.nr | Specificaties | Kleur | Lev.nr | Ehd | Prijs | Grp | CC | | |
|--|---|-------|---------------|------|--------|-----|----|---|---|
| | | | | | | | | Dornbracht Mem | |
| 2-gats wandkraan m. afdekplaat | | | | | | | | | |
| 0474515 | | chrom | 3682078000 | stuk | 489,00 | 172 | 1 |  | Sanitair producten |
| 0475432 | inbouwdeel wastafelwandkraan rechts | | 3580697090 | stuk | 168,00 | 172 | 0 | | Baden / douchebakken / stoomcabines |
| 0475527 | inbouwdeel wastafelwandkraan links | | 3580797090 | stuk | 168,00 | 172 | 0 | | |
| 2-gats wandkraan 200mm m. rozetten | | | | | | | | | |
| 0433024 | | chrom | 3681278000 | stuk | 447,00 | 172 | 1 |  | Kranen |
| 0475432 | inbouwdeel wastafelwandkraan rechts | | 3580697090 | stuk | 168,00 | 172 | 0 | | Douchegarnituur |
| 0475459 | inbouwdeel wastafelwandkraan boven | | 3580897090 | stuk | 168,00 | 172 | 1 | | Accessoires en spiegels |
| 0475527 | inbouwdeel wastafelwandkraan links | | 3580797090 | stuk | 168,00 | 172 | 0 | | Douchewanden |
| 2-gats wandkraan 200mm m. afdekplaat | | | | | | | | | |
| 0433025 | | chrom | 3682278000 | stuk | 517,00 | 172 | 1 |  | Toebehoren & afvoeren |
| 0475432 | inbouwdeel wastafelwandkraan rechts | | 3580697090 | stuk | 168,00 | 172 | 0 | | Spoel- & installatiesystemen |
| 0475527 | inbouwdeel wastafelwandkraan links | | 3580797090 | stuk | 168,00 | 172 | 0 | | Badkamermeubelen en toiletkasten |
| 3-gats wandkraan m. rozetten | | | | | | | | | |
| 0433026 | 170mm | chrom | 3670778000 | stuk | 515,00 | 172 | 1 |  | Gootstenen en wastroggen |
| 0433028 | 200mm | chrom | 3671278000 | stuk | 543,00 | 172 | 1 | | Utiliteit |
| 0433043 | inbouwset voor 3-gats muurkraan m. bronzen inbouwhuis | | 3570797090 | stuk | 167,00 | 172 | 0 | | |
| 0433044 | inbouwset voor 3-gats muurkraan m. 3 bronzen inbouwhuizen | | 3571297090 | stuk | 147,00 | 172 | 0 | | |
| 3-gats wandkraan m. afdekplaat | | | | | | | | | |
| 0433027 | 170mm | chrom | 3670878000 | stuk | 586,00 | 172 | 1 |  | |
| 0433029 | 200mm | chrom | 3671378000 | stuk | 614,00 | 172 | 1 | | |
| 0433043 | inbouwset voor 3-gats muurkraan m. bronzen inbouwhuis | | 3570797090 | stuk | 167,00 | 172 | 0 | | |
| afbouwdeel inbouwkraan m. garnituur m. afdekplaat | | | | | | | | | |
| 0474554 | | chrom | 3600978000 | stuk | 884,00 | 172 | 1 |  | |
| 0475467 | inbouwdeel douchekraan rechts | | 3500697090 | stuk | 171,00 | 172 | 1 | | |
| 0475475 | inbouwdeel douchekraan links | | 3500797090 | stuk | 171,00 | 172 | 1 | | |
| afbouwdeel inbouwkraan m. garnituur m. rozetten | | | | | | | | | |
| 0474553 | | chrom | 3601078000 | stuk | 813,00 | 172 | 1 |  | |
| 0475467 | inbouwdeel douchekraan rechts | | 3500697090 | stuk | 171,00 | 172 | 1 | | |
| 0475475 | inbouwdeel douchekraan links | | 3500797090 | stuk | 171,00 | 172 | 1 | | |
| afbouwdeel inbouwkraan voor douche + bidet m. rozet | | | | | | | | | |
| 0474551 | | chrom | 3600878000 | stuk | 229,00 | 172 | 1 |  | |
| 0433126 | inbouwdeel voor inbouwbidetkraan 1/2" | | 3580997090 | stuk | 168,00 | 172 | 1 | | |
| 0475537 | inbouwdeel voor inbouwdouchekraan | | 3500897090 | stuk | 171,00 | 172 | 0 | | |
| bidetkraan m. vaste uitloop | | | | | | | | | |
| 0272584 | | chrom | 3360078000 | stuk | 711,00 | 172 | 1 | | |
| bidet staaf handdouche | | | | | | | | | |
| 0433030 | | chrom | 0412110790000 | stuk | 132,00 | 172 | 1 | | |

| | Art.nr | Specificaties | Kleur | Lev.nr | Ehd | Prijs | Grp | CC |
|---|---|--|-------|------------|------|---------|-----|----|
| Sanitair producten | Dornbracht Mem | | | | | | | |
| | hoekstopkraan | | | | | | | |
| | 0433031 | | chrom | 2290178000 | stuk | 104,00 | 172 | 1 |
| Baden / douchebakken / stoomcabines |  | | | | | | | |
| Kranen | Xstream kleurset inbouwkraan z. omstel | | | | | | | |
| | 0474555 | | chrom | 3601578000 | stuk | 313,00 | 172 | 1 |
| | 0475910 | inbouwdeel voor inbouwbad/douchekraan | | 3511597090 | stuk | 288,00 | 172 | 0 |
| Douchegarnituur |  | | | | | | | |
| Accessoires en spiegels | 4-gats badrandcombinatie m. rozetten | | | | | | | |
| | 0474516 | | chrom | 2753278000 | stuk | 1256,00 | 172 | 1 |
| | 0470155 | Perfecto montagesysteem 1/2" voor 4-gats kraan | | 1261097090 | stuk | 555,00 | 172 | 0 |
| | 0470163 | Perfecto sierrozetten voor montagesysteem | chrom | 1280197000 | stuk | 27,75 | 172 | 0 |
| Douchewanden |  | | | | | | | |
| Toebehoren & afvoeren | 4-gats badrandcombinatie m. afdekplaat | | | | | | | |
| | 0474549 | | chrom | 2754278000 | stuk | 1402,00 | 172 | 1 |
| | 0470155 | Perfecto montagesysteem 1/2" voor 4-gats kraan | | 1261097090 | stuk | 555,00 | 172 | 0 |
| | 0470163 | Perfecto sierrozetten voor montagesysteem | chrom | 1280197000 | stuk | 27,75 | 172 | 0 |
| Douchewanden |  | | | | | | | |
| Spoel- & installatiesystemen | Xstream kleurset inbouwkraan m. omstel | | | | | | | |
| | 0474550 | | chrom | 3611578000 | stuk | 402,00 | 172 | 1 |
| | 0475910 | inbouwdeel voor inbouwbad/douchekraan | | 3511597090 | stuk | 288,00 | 172 | 0 |
| Badkamermeubelen en toiletkasten |  | | | | | | | |
| Gootstenen en wastroggen | uitloop voor montage badrand | | | | | | | |
| | 0474556 | | chrom | 1351278000 | stuk | 562,00 | 172 | 1 |
| Gootstenen en wastroggen |  | | | | | | | |
| Utiliteit | uitloop voor wandmontage | | | | | | | |
| | 0474557 | | chrom | 1380178000 | stuk | 351,00 | 172 | 1 |
| Utiliteit |  | | | | | | | |
| Badkamermeubelen en toiletkasten | douchegarnituur voor badrandmontage | | | | | | | |
| | 0474564 | | chrom | 2770878000 | stuk | 301,00 | 172 | 1 |
| Badkamermeubelen en toiletkasten |  | | | | | | | |
| Utiliteit | bekersifon m. rozet | | | | | | | |
| | 0433023 | | chrom | 1006078000 | stuk | 186,00 | 172 | 1 |
| Utiliteit |  | | | | | | | |

| Art.nr | Specificaties | Kleur | Lev.nr | Ehd | Prijs | Grp | CC | | |
|---|---------------|-------|------------|------|---------|-----|----|---|---|
| | | | | | | | | Dornbracht Mem | |
| baduitloop 1/2" voor wandmontage 110mm 0433047 | | chrom | 1341078000 | stuk | 513,00 | 172 | 1 |  | Sanitair producten |
| stopkraan staande montage 0433045 rechts | | chrom | 2000078000 | stuk | 158,00 | 172 | 1 |  | Baden / douchebakken / stoomcabines |
| stopkraan staaende montage 0433046 links | | chrom | 2000078100 | stuk | 158,00 | 172 | 1 | | Kranen |
| 2+3 weg omstel voor inbouwmontage m. rozet 0433058 | | chrom | 3610478000 | stuk | 252,00 | 172 | 0 |  | Douchegarnituur |
| 0433059 2-weg omstel voor inbouwmontage | chrom | | 3512497090 | stuk | 211,00 | 172 | 0 | | Accessoires en spiegels |
| 0433060 3-weg omstel voor inbouwmontage | chrom | | 3510497090 | stuk | 257,00 | 172 | 1 | | |
| Xtool afbouwdeel inbouwstopkraan 0433052 | | chrom | 3631078000 | stuk | 103,00 | 172 | 1 |  | Douchewanden |
| 0433049 Xtool inbouwmoduul 1-stopkraan | | | 3543697090 | stuk | 669,00 | 172 | 0 | | Toebehoren & afvoeren |
| 0433050 Xtool inbouwmoduul 2-stopkranen | | | 3552697090 | stuk | 939,00 | 172 | 0 | | |
| 0433051 Xtool inbouwmoduul 3-stopkranen | | | 3553697090 | stuk | 1002,00 | 172 | 0 | | |
| 0472671 inbouwdeel voor stopkraan koud 1/2" | | | 3562197090 | stuk | 62,50 | 172 | 0 | | |
| 0472672 inbouwdeel voor stopkraan warm 1/2" | | | 3567197090 | stuk | 62,50 | 172 | 0 | | |
| 0472673 inbouwdeel voor stopkraan koud 3/4" | | | 3562297090 | stuk | 81,00 | 172 | 0 | | |
| 0472674 inbouwdeel voor stopkraan warm 3/4" | | | 3567297090 | stuk | 81,00 | 172 | 0 | | |
| 0472675 inbouwdeel voor stopkraan koud 15mm | | | 3563197090 | stuk | 62,50 | 172 | 0 | | |
| 0472676 inbouwdeel voor stopkraan warm 15mm | | | 3568197090 | stuk | 62,50 | 172 | 0 | | |
| 0472677 inbouwdeel voor stopkraan koud 22mm | | | 3563397090 | stuk | 81,00 | 172 | 1 | | |
| 0472678 inbouwdeel voor stopkraan warm 22mm | | | 3568397090 | stuk | 81,00 | 172 | 1 | Spoel- & installatiesystemen | |
| Xtool afbouwdeel inbouwthermostaat z. stopkraan 0433048 | | chrom | 3641678000 | stuk | 389,00 | 172 | 1 |  | Badkamermeubelen en toiletkasten |
| 0433049 Xtool inbouwmoduul 1-stopkraan | | | 3543697090 | stuk | 669,00 | 172 | 0 | | Gootstenen en wastroggen |
| 0433050 Xtool inbouwmoduul 2-stopkranen | | | 3552697090 | stuk | 939,00 | 172 | 0 | | |
| 0433051 Xtool inbouwmoduul 3-stopkranen | | | 3553697090 | stuk | 1002,00 | 172 | 0 | | |
| 0474650 Xtool inbouwdeel voor inbouwthermostaat z. stopkraan 1/2" | | | 3541697090 | stuk | 542,00 | 172 | 0 | | |
| 0474651 Xtool inbouwdeel voor inbouwthermostaat z. stopkraan 3/4" | | | 3551697090 | stuk | 712,00 | 172 | 0 | | |
| Xtool inbouwmoduul 1-stopkraan 0433049 | | | 3543697090 | stuk | 669,00 | 172 | 0 |  | Utiliteit |
| Xtool inbouwmoduul 2-stopkranen 0433050 | | | 3552697090 | stuk | 939,00 | 172 | 0 |  | |
| Xtool inbouwmoduul 3-stopkranen 0433051 | | | 3553697090 | stuk | 1002,00 | 172 | 0 |  | |
| inbouwthermostaatmoduul m. 3 uitlaten 0272614 | | | 3554697090 | stuk | 1018,00 | 172 | 1 | | |









| | Art.nr | Specificaties | Kleur | Lev.nr | Ehd | Prijs | Grp | CC |
|---|---|-------------------------------------|--------------|------------|------|---------|-----|----|
| Sanitair producten | Dornbracht Mem | | | | | | | |
| | Xtool inbouwdeel voor inbouwthermostaat z. stopkraan | | | | | | | |
| | 0474650 | 1/2" | | 3541697090 | stuk | 542,00 | 172 | 0 |
| | 0474651 | 3/4" | | 3551697090 | stuk | 712,00 | 172 | 0 |
| Baden / douchebakken / stoomcabines |  | | | | | | | |
| Kranen | Dornbracht Meta Luce | | | | | | | |
| | 1-gats wastafelkraan m. waste | | | | | | | |
| | 0472795 | | chroom/blauw | 3350063077 | stuk | 336,00 | 172 | 1 |
| Douchegarnituur |  | | | | | | | |
| Accessoires en spiegels | Dornbracht Meta Pur | | | | | | | |
| | Leverbaar tot 01-07-2007 | | | | | | | |
| | 1-gats wastafelkraan 125mm m. waste | | | | | | | |
| | 0472409 | | chroom | 3350062000 | stuk | 336,00 | 172 | 0 |
| | 0470152 | | platina-mat | 3350062006 | stuk | 454,00 | 172 | 1 |
| Douchewanden |  | | | | | | | |
| Toebehoren & afvoeren | afbouwdeel wandkraan | | | | | | | |
| | 0474535 | 170mm | chroom | 3681062000 | stuk | 349,00 | 172 | 1 |
| | 0470153 | 170mm | platina-mat | 3681062006 | stuk | 471,00 | 172 | 1 |
| | 0474536 | 200mm | chroom | 3681262000 | stuk | 372,00 | 172 | 1 |
| | 0470154 | 200mm | platina-mat | 3681262006 | stuk | 502,00 | 172 | 1 |
| | 0474537 | 250mm | chroom | 3681662000 | stuk | 400,00 | 172 | 1 |
| | 0470156 | 250mm | platina-mat | 3681662006 | stuk | 539,00 | 172 | 1 |
| | 0475432 | inbouwdeel wastafelwandkraan rechts | | 3580697090 | stuk | 168,00 | 172 | 0 |
| Spoel- & installatiesystemen | 0475459 | inbouwdeel wastafelwandkraan boven | | 3580897090 | stuk | 168,00 | 172 | 1 |
| | 0475527 | inbouwdeel wastafelwandkraan links | | 3580797090 | stuk | 168,00 | 172 | 0 |
| | 1-gats bidetkraan m. waste | | | | | | | |
| Badkamermeubelen en toiletkasten | 0472417 | | chroom | 3360062000 | stuk | 421,00 | 172 | 1 |
| | 0470160 | | platina-mat | 3360062006 | stuk | 568,00 | 172 | 1 |
| |  | | | | | | | |
| Gootstenen en wastroggen | 4-gats badrandcombinatie | | | | | | | |
| | 0472523 | z. hendel | chroom | 2751288000 | stuk | 1047,00 | 172 | 1 |
| | 0470343 | z. hendel | platina-mat | 2751288006 | stuk | 1571,00 | 172 | 1 |
| |  | | | | | | | |
| Utiliteit | badkraan m. omstel z. garnituur m. koppelingen | | | | | | | |
| | 0472425 | | chroom | 3320062000 | stuk | 518,00 | 172 | 1 |
| | 0470161 | | platina-mat | 3320062006 | stuk | 699,00 | 172 | 1 |
| |  | | | | | | | |
| | douchekraan HOH=15cm z. omstel z. garnituur m. koppelingen | | | | | | | |
| | 0472433 | | chroom | 3330062000 | stuk | 340,00 | 172 | 1 |
| | 0470162 | | platina-mat | 3330062006 | stuk | 459,00 | 172 | 1 |
| |  | | | | | | | |
| | douchethermostaat 1/2" z. hendel m. koppelingen | | | | | | | |
| | 0472522 | | chroom | 3442097000 | stuk | 468,00 | 172 | 0 |
| | 0471637 | | platina-mat | 3442097006 | stuk | 703,00 | 172 | 1 |
| | 0471620 | schaalgreep | platina-mat | 1142089006 | stuk | 211,00 | 172 | 1 |
| | 0472719 | temperatuurgreep | chroom | 1142022000 | stuk | 141,00 | 172 | 1 |
| |  | | | | | | | |

| Art.nr | Specificaties | Kleur | Lev.nr | Ehd | Prijs | Grp | CC | | |
|---|---------------------------|-------------|------------|------|---------|-----|----|---|---|
| | | | | | | | | Dornbracht Meta Pur | |
| douchethermostaat 1/2" m. regendouche m. handdouche m. koppelingen | | | | | | | | | |
| 0471639 | | chrom | 3445697000 | stuk | 1526,00 | 172 | 1 |  | Sanitair producten |
| 0471640 | | platina-mat | 3445697006 | stuk | 2289,00 | 172 | 1 | | Baden / douchebakken / stoomcabines |
| 0471620 | schaalgreep | platina-mat | 1142089006 | stuk | 211,00 | 172 | 1 | | |
| 0472719 | temperatuurgreep | chrom | 1142022000 | stuk | 141,00 | 172 | 1 | | |
| afbouwdeel inbouwdouchekraan m. rozet | | | | | | | | | |
| 0474542 | | chrom | 3600862000 | stuk | 208,00 | 172 | 1 |  | Kranen |
| afbouwdeel inbouwstopkraan z. hendel | | | | | | | | | |
| 0472681 | | chrom | 3631088000 | stuk | 42,50 | 172 | 0 |  | Douchegarnituur |
| 0472682 | | platina-mat | 3631088006 | stuk | 64,00 | 172 | 1 | | Accessoires en spiegels |
| 0472379 | kraanhendel | chrom | 1117088000 | stuk | 46,75 | 172 | 0 | | |
| 0472671 | inbouwdeel voor stopkraan | koud 1/2" | 3562197090 | stuk | 62,50 | 172 | 0 | | |
| 0472672 | inbouwdeel voor stopkraan | warm 1/2" | 3567197090 | stuk | 62,50 | 172 | 0 | | |
| 0472673 | inbouwdeel voor stopkraan | koud 3/4" | 3562297090 | stuk | 81,00 | 172 | 0 | | |
| 0472674 | inbouwdeel voor stopkraan | warm 3/4" | 3567297090 | stuk | 81,00 | 172 | 0 | | |
| 0472675 | inbouwdeel voor stopkraan | koud 15mm | 3563197090 | stuk | 62,50 | 172 | 0 | | Douchewanden |
| 0472676 | inbouwdeel voor stopkraan | warm 15mm | 3568197090 | stuk | 62,50 | 172 | 0 | | |
| 0472677 | inbouwdeel voor stopkraan | koud 22mm | 3563397090 | stuk | 81,00 | 172 | 1 | | |
| 0472678 | inbouwdeel voor stopkraan | warm 22mm | 3568397090 | stuk | 81,00 | 172 | 1 | | |
| baduitloop 3/4" wandmontage | | | | | | | | | |
| 0472611 | | chrom | 1380189000 | stuk | 319,00 | 172 | 0 |  | Toebehoren & afvoeren |
| 0475718 | | platina-mat | 1380189006 | stuk | 479,00 | 172 | 1 | | Spoel- & installatiesystemen |
| kleurset voor badafvoer-, overloop- en vulcombinatie | | | | | | | | | |
| 0470610 | | chrom | 3622697000 | stuk | 153,00 | 172 | 1 |  | Badkamermeubelen en toiletkasten |
| 0471622 | | platina-mat | 3622697006 | stuk | 244,00 | 172 | 1 | | |
| 0470334 | | messing | 3622697009 | stuk | 244,00 | 172 | 1 | | Gootstenen en wastroggen |
| | | | | | | | | Dornbracht Meta Tec | |
| Leverbaar tot 01-07-2007 | | | | | | | | | |
| 1-gats wastafelkraan m. waste | | | | | | | | | |
| 0472087 | | chrom/alu | 3350065045 | stuk | 387,00 | 172 | 0 |  | Utiliteit |
| 4-gats badrandcombinatie | | | | | | | | | |
| 0472523 | z. hendel | chrom | 2751288000 | stuk | 1047,00 | 172 | 1 |  | |
| 0470343 | z. hendel | platina-mat | 2751288006 | stuk | 1571,00 | 172 | 1 | | |
| badkraan m. omstel z. garnituur m. koppelingen | | | | | | | | | |
| 0472091 | | chrom/alu | 3320065045 | stuk | 595,00 | 172 | 1 |  | |
| douchethermostaat 1/2" z. hendel m. koppelingen | | | | | | | | | |
| 0472522 | | chrom | 3442097000 | stuk | 468,00 | 172 | 0 |  | |
| 0470588 | schaalgreep | chrom | 1142089000 | stuk | 141,00 | 172 | 0 | | |
| 0472719 | temperatuurgreep | chrom | 1142022000 | stuk | 141,00 | 172 | 1 | | |
| 0473871 | temperatuurgreep | chrom | 1142075000 | stuk | 135,00 | 172 | 1 | | |

| | Art.nr | Specificaties | Kleur | Lev.nr | Ehd | Prijs | Grp | CC |
|---|---|-------------------------------------|-------------|------------|------|---------|-----|----|
| Sanitair producten | Dornbracht Meta Tec | | | | | | | |
| | douchethermostaat 1/2" m. regendouche m. handdouche m. koppelingen | | | | | | | |
| | 0471639 | | chrom | 3445697000 | stuk | 1526,00 | 172 | 1 |
| | 0470588 | schaalgreep chrom | | 1142089000 | stuk | 141,00 | 172 | 0 |
| Baden / douchebakken / stoomcabines | 0472719 | temperatuurgreep chrom | | 1142022000 | stuk | 141,00 | 172 | 1 |
| | <hr/> | | | | | | | |
| Kranen | douchekraan z. omstel m. koppelingen | | | | | | | |
| | 0441209 | | chrom/alu | 3330065045 | stuk | 391,00 | 172 | 1 |
| Douchegarnituur | afbouwdeel inbouwdouchekraan m. rozet | | | | | | | |
| | 0474545 | | chrom/alu | 3600865045 | stuk | 208,00 | 172 | 1 |
| | 0475537 | inbouwdeel voor inbouwdouchekraan | | 3500897090 | stuk | 171,00 | 172 | 0 |
| Accessoires en spiegels | <hr/> | | | | | | | |
| | afbouwdeel inbouwdouchekraan m. garnituur | | | | | | | |
| Douchewanden | 0474544 | | chrom/alu | 3601065045 | stuk | 647,00 | 172 | 1 |
| | 0475467 | inbouwdeel douchekraan rechts | | 3500697090 | stuk | 171,00 | 172 | 1 |
| | 0475475 | inbouwdeel douchekraan links | | 3500797090 | stuk | 171,00 | 172 | 1 |
| Toebehoren & afvoeren | <hr/> | | | | | | | |
| | afbouwdeel inbouwstopkraan z. hendel | | | | | | | |
| Spoel- & installatiesystemen | 0472681 | | chrom | 3631088000 | stuk | 42,50 | 172 | 0 |
| | 0472379 | kraanhendel chrom | | 1117088000 | stuk | 46,75 | 172 | 0 |
| | 0472671 | inbouwdeel voor stopkraan koud 1/2" | | 3562197090 | stuk | 62,50 | 172 | 0 |
| | 0472672 | inbouwdeel voor stopkraan warm 1/2" | | 3567197090 | stuk | 62,50 | 172 | 0 |
| | 0472673 | inbouwdeel voor stopkraan koud 3/4" | | 3562297090 | stuk | 81,00 | 172 | 0 |
| | 0472674 | inbouwdeel voor stopkraan warm 3/4" | | 3567297090 | stuk | 81,00 | 172 | 0 |
| | 0472675 | inbouwdeel voor stopkraan koud 15mm | | 3563197090 | stuk | 62,50 | 172 | 0 |
| | 0472676 | inbouwdeel voor stopkraan warm 15mm | | 3568197090 | stuk | 62,50 | 172 | 0 |
| Badkamermeubelen en toiletkasten | 0472677 | inbouwdeel voor stopkraan koud 22mm | | 3563397090 | stuk | 81,00 | 172 | 1 |
| | 0472678 | inbouwdeel voor stopkraan warm 22mm | | 3568397090 | stuk | 81,00 | 172 | 1 |
| Gootstenen en wastroggen | kleurset voor badafvoer-, overloop- en vulcombinatie | | | | | | | |
| | 0470610 | | chrom | 3622697000 | stuk | 153,00 | 172 | 1 |
| Utiliteit | <hr/> | | | | | | | |
| | Dornbracht Meta.02 | | | | | | | |
| | toiletkraan sprong 10cm | | | | | | | |
| | 0475099 | | chrom | 1750062500 | stuk | 207,80 | 172 | 1 |
| | 0475100 | | platina mat | 1750062506 | stuk | 280,50 | 172 | 1 |
| | <hr/> | | | | | | | |
| | 1-gats wastafelkraan 125mm m. waste | | | | | | | |
| | 0474424 | | chrom | 3350162500 | stuk | 308,00 | 172 | 1 |
| | 0474425 | | platina-mat | 3350162506 | stuk | 416,00 | 172 | 1 |

| Art.nr | Specificaties | Kleur | Lev.nr | Ehd | Prijs | Grp | CC | | |
|--|-------------------------------------|-------------|------------|------|--------|-----|----|---|---|
| | | | | | | | | Dornbracht Meta.02 | |
| 1-gats wastafelkraan 13cm | | | | | | | | | |
| 0475097 | | chrom | 3350262500 | stuk | 336,60 | 172 | 1 |  | Sanitair producten |
| 0475098 | | platina mat | 3350262506 | stuk | 454,50 | 172 | 1 | | Baden / douchebakken / stoomcabines |
| wastafelkraan voor boiler m. waste | | | | | | | | | |
| 0474426 | | chrom | 3355162500 | stuk | 339,00 | 172 | 1 |  | Kranen |
| 0474427 | | platina-mat | 3355162506 | stuk | 458,00 | 172 | 1 | | |
| wastafelkraan voor boiler z. waste | | | | | | | | | |
| 0474429 | | chrom | 3355662500 | stuk | 305,00 | 172 | 1 |  | Douchegarnituur |
| 0474430 | | platina-mat | 3355662506 | stuk | 412,00 | 172 | 1 | | Accessoires en spiegels |
| 1-gats wastafelkraan 105mm z. waste | | | | | | | | | |
| 0474431 | | chrom | 3352562500 | stuk | 254,00 | 172 | 1 |  | Douchewanden |
| 0474432 | | platina-mat | 3352562506 | stuk | 342,00 | 172 | 1 | | |
| 1-gats wastafelkraan 115mm m. waste | | | | | | | | | |
| 0475238 | | chrom | 3350062500 | stuk | 295,00 | 172 | 0 |  | Toebehoren & afvoeren |
| 0470114 | | platina-mat | 3350062506 | stuk | 398,00 | 172 | 1 | | |
| 1-gats wastafelkraan verhoogd uitloop=290mm m. waste | | | | | | | | | |
| 0475254 | | chrom | 3353662500 | stuk | 467,00 | 172 | 1 |  | Spoel- & installatiesystemen |
| 0470115 | | platina-mat | 3353662506 | stuk | 631,00 | 172 | 1 | | |
| 1-gats wastafelkraan verhoogd uitloop=310mm m. waste | | | | | | | | | |
| 0475262 | | chrom | 3353862500 | stuk | 493,00 | 172 | 1 |  | Badkamermeubelen en toiletkasten |
| 0470116 | | platina-mat | 3353862506 | stuk | 665,00 | 172 | 1 | | |
| 1-gats wastafelkraan verhoogd uitloop=310mm m. waste | | | | | | | | | |
| 0475262 | | chrom | 3353862500 | stuk | 493,00 | 172 | 1 |  | Gootstenen en wastroggen |
| 0470116 | | platina-mat | 3353862506 | stuk | 665,00 | 172 | 1 | | |
| 2-gats wastafelkraan m. draaibare uitloop 16cm m. waste | | | | | | | | | |
| 0475270 | | chrom | 3250062500 | stuk | 501,00 | 172 | 1 |  | Utiliteit |
| 0470118 | | platina-mat | 3250062506 | stuk | 677,00 | 172 | 1 | | |
| afbouwdeel wastafelwandkraan m. rozet | | | | | | | | | |
| 0475297 | uitloop 170mm | chrom | 3681062500 | stuk | 333,00 | 172 | 1 |  | |
| 0470121 | uitloop 170mm | platina-mat | 3681062506 | stuk | 449,00 | 172 | 1 | | |
| 0475319 | uitloop 200mm | chrom | 3681262500 | stuk | 354,00 | 172 | 1 | | |
| 0470123 | uitloop 200mm | platina-mat | 3681262506 | stuk | 478,00 | 172 | 1 | | |
| 0475335 | uitloop 250mm | chrom | 3681662500 | stuk | 381,00 | 172 | 1 | | |
| 0470125 | uitloop 250mm | platina-mat | 3681662506 | stuk | 514,00 | 172 | 1 | | |
| 0475432 | inbouwdeel wastafelwandkraan rechts | | 3580697090 | stuk | 168,00 | 172 | 0 | | |
| 0475459 | inbouwdeel wastafelwandkraan boven | | 3580897090 | stuk | 168,00 | 172 | 1 | | |
| 0475527 | inbouwdeel wastafelwandkraan links | | 3580797090 | stuk | 168,00 | 172 | 0 | | |

| | Art.nr | Specificaties | Kleur | Lev.nr | Ehd | Prijs | Grp | CC | |
|--|---|------------------------------|-------------------------------------|-------------------------------------|-------------|------------|---------|--------|-------|
| Dornbracht Meta.02 | | | | | | | | | |
| Sanitair producten | afbouwdeel wastafelwandkraan m. afdekplaat | | | | | | | | |
| | | 0475300 | uitloop 170mm | chroom | 3682062500 | stuk | 410,00 | 172 1 | |
| | | 0470122 | uitloop 170mm | platina-mat | 3682062506 | stuk | 553,00 | 172 1 | |
| | | 0475327 | uitloop 200mm | chroom | 3682262500 | stuk | 432,00 | 172 1 | |
| | | 0470124 | uitloop 200mm | platina-mat | 3682262506 | stuk | 583,00 | 172 1 | |
| | Baden / douchebakken / stoomcabines | | 0475343 | uitloop 250mm | chroom | 3682662500 | stuk | 458,00 | 172 1 |
| | | | 0470126 | uitloop 250mm | platina-mat | 3682662506 | stuk | 618,00 | 172 1 |
| | | | 0475432 | inbouwdeel wastafelwandkraan rechts | | 3580697090 | stuk | 168,00 | 172 0 |
| | Kranen | | 0475459 | inbouwdeel wastafelwandkraan boven | | 3580897090 | stuk | 168,00 | 172 1 |
| | | 0475527 | inbouwdeel wastafelwandkraan links | | 3580797090 | stuk | 168,00 | 172 0 | |
| afbouwdeel wastafelwandkraan m. rozet | | | | | | | | | |
| Douchegarnituur | | 0475351 | uitloop 225mm | chroom | 3683462500 | stuk | 509,00 | 172 1 | |
| | | 0470127 | uitloop 225mm | platina-mat | 3683462506 | stuk | 712,00 | 172 1 | |
| | | 0475432 | inbouwdeel wastafelwandkraan rechts | | 3580697090 | stuk | 168,00 | 172 0 | |
| | | 0475459 | inbouwdeel wastafelwandkraan boven | | 3580897090 | stuk | 168,00 | 172 1 | |
| | | 0475527 | inbouwdeel wastafelwandkraan links | | 3580797090 | stuk | 168,00 | 172 0 | |
| Accessoires en spiegels | afbouwdeel wastafelwandkraan m. afdekplaat | | | | | | | | |
| | | 0475378 | uitloop 225mm | chroom | 3684462500 | stuk | 586,00 | 172 1 | |
| | | 0470128 | uitloop 225mm | platina-mat | 3684462506 | stuk | 791,00 | 172 1 | |
| | | 0475432 | inbouwdeel wastafelwandkraan rechts | | 3580697090 | stuk | 168,00 | 172 0 | |
| | | 0475459 | inbouwdeel wastafelwandkraan boven | | 3580897090 | stuk | 168,00 | 172 1 | |
| Douchewanden | | 0475527 | inbouwdeel wastafelwandkraan links | | 3580797090 | stuk | 168,00 | 172 0 | |
| | 1-gats bidetkraan m. waste | | | | | | | | |
| Toebehoren & afvoeren | | 0475386 | | chroom | 3360062500 | stuk | 369,00 | 172 1 | |
| | | 0470129 | | platina-mat | 3360062506 | stuk | 498,00 | 172 1 | |
| Spoel- & installatiesystemen | afbouwdeel doucheset m. garnituur m. rozet | | | | | | | | |
| | | 0475394 | | chroom | 3601062500 | stuk | 674,00 | 172 1 | |
| | | 0470130 | | platina-mat | 3601062506 | stuk | 909,00 | 172 1 | |
| | Badkamermeubelen en toiletkasten | | 0475467 | inbouwdeel douchekraan rechts | | 3500697090 | stuk | 171,00 | 172 1 |
| | | | 0475475 | inbouwdeel douchekraan links | | 3500797090 | stuk | 171,00 | 172 1 |
| Gootstenen en wastroggen | afbouwdeel doucheset m. garnituur m. afdekplaat | | | | | | | | |
| | | 0475408 | | chroom | 3600962500 | stuk | 750,00 | 172 1 | |
| | | 0470132 | | platina-mat | 3600962506 | stuk | 1012,00 | 172 1 | |
| | | 0475467 | inbouwdeel douchekraan rechts | | 3500697090 | stuk | 171,00 | 172 1 | |
| Utiliteit | | 0475475 | inbouwdeel douchekraan links | | 3500797090 | stuk | 171,00 | 172 1 | |
| | afbouwdeel doucheset m. handdouche m. rozet | | | | | | | | |
| | | 0475416 | | chroom | 3601262500 | stuk | 509,00 | 172 1 | |
| | | 0470133 | | platina-mat | 3601262506 | stuk | 687,00 | 172 1 | |
| | | 0475467 | inbouwdeel douchekraan rechts | | 3500697090 | stuk | 171,00 | 172 1 | |
| | | 0475475 | inbouwdeel douchekraan links | | 3500797090 | stuk | 171,00 | 172 1 | |
| | afbouwdeel doucheset m. handdouche m. afdekplaat | | | | | | | | |
| | | 0475424 | | chroom | 3601162500 | stuk | 573,00 | 172 1 | |
| | | 0470134 | | platina-mat | 3601162506 | stuk | 791,00 | 172 1 | |
| | | 0475467 | inbouwdeel douchekraan rechts | | 3500697090 | stuk | 171,00 | 172 1 | |
| | 0475475 | inbouwdeel douchekraan links | | 3500797090 | stuk | 171,00 | 172 1 | | |

| Art.nr | Specificaties | Kleur | Lev.nr | Ehd | Prijs | Grp | CC | | |
|---|---------------|-------------|------------|------|---------|-----|----|---|---|
| | | | | | | | | Dornbracht Meta.02 | |
| inbouwdeel wastafelwandkraan rechts | | | | | | | | | |
| 0475432 | | | 3580697090 | stuk | 168,00 | 172 | 0 |  | Sanitair producten |
| inbouwdeel wastafelwandkraan links | | | | | | | | | |
| 0475427 | | | 3580797090 | stuk | 168,00 | 172 | 0 |  | Baden / douchebakken / stoomcabines |
| inbouwdeel wastafelwandkraan boven | | | | | | | | | |
| 0475459 | | | 3580897090 | stuk | 168,00 | 172 | 1 |  | Douchegarnituur |
| inbouwdeel douchekraan rechts | | | | | | | | | |
| 0475467 | | | 3500697090 | stuk | 171,00 | 172 | 1 |  | Accessoires en spiegels |
| inbouwdeel douchekraan links | | | | | | | | | |
| 0475475 | | | 3500797090 | stuk | 171,00 | 172 | 1 |  | Douchewanden |
| badkraan m. omstel z. garnituur m. koppelingen | | | | | | | | | |
| 0474532 | | chroom | 3320062500 | stuk | 412,00 | 172 | 1 |  | Toebehoren & afvoeren |
| 0474434 | | platina-mat | 3320062506 | stuk | 556,00 | 172 | 1 | | |
| badkraan m. omstel m. garnituur m. koppelingen | | | | | | | | | |
| 0474531 | | chroom | 3323362500 | stuk | 616,00 | 172 | 1 |  | Spoon- & installatiesystemen |
| 0474437 | | platina-mat | 3323362506 | stuk | 831,00 | 172 | 1 | | |
| badkraan voor bad-/tegelrandcombinatie | | | | | | | | | |
| 0272589 | | chroom | 2920062500 | stuk | 328,00 | 172 | 1 | | Badkamermeubelen en toiletkasten |
| 0470345 | | platina-mat | 2920062506 | stuk | 443,00 | 172 | 1 | | |
| baduitloop m. omstel | | | | | | | | | |
| 0272590 | sprong 220mm | chroom | 1351262500 | stuk | 460,00 | 172 | 1 | | Gootstenen en wastroggen |
| 0433142 | sprong 220mm | platina-mat | 1351262506 | stuk | 620,70 | 172 | 1 | | |
| vaste baduitloop voor wand 20cm | | | | | | | | | |
| 0475101 | | chroom | 1380162500 | stuk | 302,90 | 172 | 1 |  | Utiliteit |
| 0475102 | | platina mat | 1380162506 | stuk | 408,90 | 172 | 1 | | |
| 3-gats badrandkraan | | | | | | | | | |
| 0433140 | | chroom | 2731262500 | stuk | 1017,70 | 172 | 1 | | |
| 0433141 | | platina-mat | 2731262506 | stuk | 1373,90 | 172 | 1 | | |

| | Art.nr | Specificaties | Kleur | Lev.nr | Ehd | Prijs | Grp | CC | |
|---|---|---|---------------------------------------|-------------|------------|--------|--------|-----|---|
| | Dornbracht Meta.02 | | | | | | | | |
| Sanitair producten |  | douchekraan z. omstel m. koppelingen | | | | | | | |
| | | 0474534 | | chroom | 3330062500 | stuk | 268,00 | 172 | 1 |
| | | 0474439 | | platina-mat | 3330062506 | stuk | 361,00 | 172 | 1 |
| Baden / douchebakken / stoomcabines | | douchethermostaat 1/2" z. hendel | | | | | | | |
| | | 0470316 | | chroom | 3444097900 | stuk | 374,00 | 172 | 1 |
| | | 0470335 | | platina-mat | 3444097906 | stuk | 561,00 | 172 | 1 |
| Kranen |  | Xstream kleurset inbouwkraan m. omstel | | | | | | | |
| | | 0474440 | | chroom | 3611562500 | stuk | 289,00 | 172 | 1 |
| | | 0474441 | | platina-mat | 3611562506 | stuk | 390,00 | 172 | 1 |
| | | 0475910 | inbouwdeel voor inbouwbad/douchekraan | | 3511597090 | stuk | 288,00 | 172 | 0 |
| Douchegarnituur | | | | | | | | | |
| Accessoires en spiegels | | afbouwset voor inbouwstopkraan | | | | | | | |
| | | 0272593 | | chroom | 3631097900 | stuk | 83,00 | 172 | 1 |
| | | 0272594 | | platina-mat | 3631097906 | stuk | 124,00 | 172 | 1 |
| Douchewanden |  | wandaansluitbocht 1/2" | | | | | | | |
| | | 0474442 | | chroom | 2845062500 | stuk | 59,50 | 172 | 1 |
| | | 0474443 | | platina-mat | 2845062506 | stuk | 80,00 | 172 | 1 |
| Toebehoren & afvoeren | | hendel voor stopkraan | | | | | | | |
| | | 0470315 | | chroom | 1143097900 | stuk | 55,50 | 172 | 1 |
| | | 0470336 | | platina-mat | 1143097906 | stuk | 83,50 | 172 | 1 |
| Spoel- & installatiesystemen |  | Dornbracht Tara schaalgreep | | | | | | | |
| | | 0470588 | | chroom | 1142089000 | stuk | 141,00 | 172 | 0 |
| | | 0471620 | | platina-mat | 1142089006 | stuk | 211,00 | 172 | 1 |
| Badkamermeubelen en toiletkasten | | | | | | | | | |
| Gootstenen en wastroggen |  | toiletkraan 1/2" staand | | | | | | | |
| | | 0472476 | | chroom | 1750089000 | stuk | 208,00 | 172 | 0 |
| | | 0472027 | | platina-mat | 1750089006 | stuk | 312,00 | 172 | 1 |
| Utiliteit |  | toiletkraan 1/2" wandmodel | | | | | | | |
| | | 0472484 | | chroom | 3001089000 | stuk | 220,00 | 172 | 0 |
| | | 0473626 | | platina-mat | 3001089006 | stuk | 330,00 | 172 | 1 |
|  | toiletkraan wandmodel sprong 20cm | | | | | | | | |
| | 0470026 | | chroom | 3002089000 | stuk | 253,00 | 172 | 1 | |
| | | 0471605 | | platina-mat | 3002089006 | stuk | 380,00 | 172 | 1 |
|  | 1-gats wastafelkraan m. waste 165mm | | | | | | | | |
| | 0471615 | | chroom | 2251389000 | stuk | 385,00 | 172 | 0 | |
| | 0471617 | | platin | 2251389008 | stuk | 577,00 | 172 | 1 | |
| | 0470614 | | platina-mat | 2251389006 | stuk | 577,00 | 172 | 1 | |
| | | 0470236 | | messing | 2251389009 | stuk | 616,00 | 172 | 1 |

| Art.nr | Specificaties | Kleur | Lev.nr | Ehd | Prijs | Grp | CC |
|--------|---------------|-------|--------|-----|-------|-----|----|
|--------|---------------|-------|--------|-----|-------|-----|----|

Dornbracht Tara

1-gats wastafelkraan

| | | | | | | | |
|---------|----------------|-------------|------------|------|--------|-----|---|
| 0470686 | 135mm m. waste | chroom | 2251289000 | stuk | 363,00 | 172 | 0 |
| 0470337 | 135mm m. waste | platina | 2251289008 | stuk | 545,00 | 172 | 1 |
| 0475696 | 135mm m. waste | platina-mat | 2251289006 | stuk | 545,00 | 172 | 1 |
| 0470683 | 135mm m. waste | messing | 2251289009 | stuk | 581,00 | 172 | 1 |
| 0472735 | 100mm m. waste | chroom | 2230289000 | stuk | 345,00 | 172 | 1 |
| 0470338 | 100mm m. waste | platina | 2230289008 | stuk | 517,00 | 172 | 1 |
| 0473502 | 100mm m. waste | platina-mat | 2230289006 | stuk | 517,00 | 172 | 1 |
| 0470314 | 100mm m. waste | messing | 2230289009 | stuk | 552,00 | 172 | 1 |

1-gats wastafelkraan verhoogd m. waste

| | | | | | | | |
|---------|--|-------------|------------|------|--------|-----|---|
| 0086274 | | chroom | 2253489000 | stuk | 548,00 | 172 | 1 |
| 0086282 | | platina-mat | 2253489006 | stuk | 821,00 | 172 | 1 |
| 0086290 | | platina | 2253489008 | stuk | 821,00 | 172 | 1 |

**2-gats wastafelkraan m. draaibare uitloop**

| | | | | | | | |
|---------|--|-------------|------------|------|--------|-----|---|
| 0472740 | | chroom | 1912389000 | stuk | 529,00 | 172 | 1 |
| 0473464 | | platina-mat | 1912389006 | stuk | 793,00 | 172 | 1 |

**3-gats wastafelkraan**

| | | | | | | | |
|---------|----------------|-------------|------------|------|--------|-----|---|
| 0470020 | 165mm m. waste | chroom | 2071389000 | stuk | 647,00 | 172 | 1 |
| 0473499 | 165mm m. waste | platina-mat | 2071389006 | stuk | 970,00 | 172 | 1 |
| 0470694 | 135mm m. waste | chroom | 2071089000 | stuk | 610,00 | 172 | 1 |
| 0473480 | 135mm m. waste | platina-mat | 2071089006 | stuk | 915,00 | 172 | 1 |

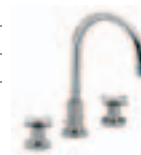
**New afbouwdeel voor 3-gats wandkraan**

| | | | | | | | |
|---------|---|-------------|------------|------|--------|-----|---|
| 0433088 | 16cm | chroom | 3670789000 | stuk | 434,00 | 172 | 0 |
| 0433089 | 16cm | platina | 3670789006 | stuk | 651,00 | 172 | 1 |
| 0433090 | 19cm | chroom | 3671289000 | stuk | 456,00 | 172 | 0 |
| 0470317 | 19cm | platina-mat | 3671289006 | stuk | 684,00 | 172 | 1 |
| 0433091 | 19cm | platina | 3671289008 | stuk | 684,00 | 172 | 1 |
| 0433092 | 24cm | chroom | 3671789000 | stuk | 482,00 | 172 | 0 |
| 0470318 | 24cm | platina-mat | 3671789006 | stuk | 723,00 | 172 | 1 |
| 0433093 | 24cm | platina | 3671789008 | stuk | 723,00 | 172 | 1 |
| 0433043 | inbouwset voor 3-gats muurkraan m. bronzen inbouwhuis | | 3570797090 | stuk | 167,00 | 172 | 0 |
| 0433044 | inbouwset voor 3-gats muurkraan m. 3 bronzen inbouwhuizen | | 3571297090 | stuk | 147,00 | 172 | 0 |

**3-gats muurwastafelkraan 17cm (Soho/Vero)**

| | | | | | | | |
|---------|--|-------------|------------|------|--------|-----|---|
| 0470086 | | chroom | 2972089000 | stuk | 604,00 | 172 | 1 |
| 0470340 | | platina | 2972089008 | stuk | 906,00 | 172 | 1 |
| 0471604 | | platina-mat | 2972089006 | stuk | 906,00 | 172 | 1 |

**1-gats bidetkraan m. waste**

| | | | | | | | |
|---------|--|-------------|------------|------|--------|-----|---|
| 0470708 | | chroom | 2451089000 | stuk | 454,00 | 172 | 1 |
| 0473510 | | platina-mat | 2451089006 | stuk | 680,00 | 172 | 1 |
| 0471619 | | platin | 2451089008 | stuk | 680,00 | 172 | 1 |

**3-gats bidetkraan 11cm m. waste**

| | | | | | | | |
|---------|--|-------------|------------|------|--------|-----|---|
| 0471607 | | chroom | 2461089000 | stuk | 614,00 | 172 | 1 |
| 0471608 | | platina-mat | 2461089006 | stuk | 921,00 | 172 | 1 |

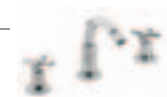
**zijkraan 1/2" m. rozet**

| | | | | | | | |
|---------|--|-------------|------------|------|--------|-----|---|
| 0472727 | | chroom | 2000089000 | stuk | 115,00 | 172 | 1 |
| 0473472 | | platina-mat | 2000089006 | stuk | 173,00 | 172 | 1 |



Sanitair producten

Baden /
douchebakken /
stoomcabines

Kranen









Douchegarnituur

Accessoires en
spiegels

Douchewanden

Toebehoren &
afvoerenSpoel- &
installatiesystemenBadkamermeubelen
en toiletkastenGootstenen en
wastroggen

Utiliteit

| | Art.nr | Specificaties | Kleur | Lev.nr | Ehd | Prijs | Grp | CC | |
|---|---|---|--|-------------|------------|--------|---------|-----|---|
| | Dornbracht Tara | | | | | | | | |
| Sanitair producten |  | bidetuitloop sprong 110mm m.waste | | | | | | | |
| | | 0471610 | | chroom | 1390089000 | stuk | 375,00 | 172 | 1 |
| | | 0471611 | | platina-mat | 1390089006 | stuk | 562,00 | 172 | 1 |
| Baden / douchebakken / stoomcabines | | | | | | | | | |
| Kranen |  | hoekstopkraan koud/warm m. rozet | | | | | | | |
| | | 0470716 | 1/2"x10mm | chroom | 2290089000 | stuk | 106,00 | 172 | 1 |
| | | 0470035 | 1/2"x10mm | platina-mat | 2290089006 | stuk | 158,00 | 172 | 1 |
| Douchegarnituur | | | | | | | | | |
| Accessoires en spiegels |  | badkraan vloermontage 930mm m. garnituur | | | | | | | |
| | | 0472487 | | chroom | 2594389000 | stuk | 1967,00 | 172 | 1 |
| | | 0471612 | | platina-mat | 2594389006 | stuk | 2950,00 | 172 | 1 |
| | | 0470571 | inbouwdeel bodemplaat compleet | | 3594397090 | stuk | 269,00 | 172 | 1 |
| Douchewanden | | | | | | | | | |
| Toebehoren & afvoeren |  | badrandcombinatie m. garnituur | | | | | | | |
| | | 0472486 | | chroom | 2504389000 | stuk | 1319,00 | 172 | 1 |
| | | 0473529 | | platina-mat | 2504389006 | stuk | 1979,00 | 172 | 1 |
| Spoel- & installatiesystemen |  | 4-gats badkraan uitloop 220mm | | | | | | | |
| | | 0472565 | | chroom | 2751289000 | stuk | 1108,00 | 172 | 0 |
| | | 0471613 | | platina-mat | 2751289006 | stuk | 1661,00 | 172 | 1 |
| | | 0470155 | Perfecto montagesysteem 1/2" voor 4-gats kraan | | 1261097090 | stuk | 555,00 | 172 | 0 |
| | | 0470163 | Perfecto sierrozetten voor montagesysteem | chroom | 1280197000 | stuk | 27,75 | 172 | 0 |
| Badkamermeubelen en toiletkasten | | | | | | | | | |
| Gootstenen en wastroggen |  | thermostaat voor staande montage z. hendel | | | | | | | |
| | | 0471618 | | platina-mat | 3452597006 | stuk | 1681,00 | 172 | 1 |
| | | 0472765 | | chroom | 3452597000 | stuk | 1373,00 | 172 | 1 |
| | | 0470588 | schaalgreep | chroom | 1142089000 | stuk | 141,00 | 172 | 0 |
| | | 0471620 | schaalgreep | platina-mat | 1142089006 | stuk | 211,00 | 172 | 1 |
| | 0472719 | temperatuurgreep | chroom | 1142022000 | stuk | 141,00 | 172 | 1 | |
| Utiliteit | | | | | | | | | |
| |  | 2-weg omstelling voor badrandcombinatie | | | | | | | |
| | | 0472774 | | chroom | 2914089000 | stuk | 410,00 | 172 | 1 |
| | | 0476145 | | platina-mat | 2914089006 | stuk | 615,00 | 172 | 1 |
| | | | | | | | | | |
| |  | douchegarnituur voor badrandmontage | | | | | | | |
| | | 0474402 | | chroom | 2770297900 | stuk | 290,00 | 172 | 1 |
| | | 0474403 | | platina-mat | 2770297906 | stuk | 400,00 | 172 | 1 |
| | | | | | | | | | |
| |  | baduitloop m. omstel | | | | | | | |
| | | 0441204 | | chroom | 1351289000 | stuk | 511,00 | 172 | 1 |
| | | 0471621 | | platina-mat | 1351289006 | stuk | 766,00 | 172 | 1 |

| Art.nr | Specificaties | Kleur | Lev.nr | Ehd | Prijs | Grp | CC |
|--------|---------------|-------|--------|-----|-------|-----|----|
|--------|---------------|-------|--------|-----|-------|-----|----|

Dornbracht Tara

baduitloop 3/4" wandmontage

| | | | | | | | |
|---------|--|-------------|------------|------|--------|-----|---|
| 0472611 | | chroom | 1380189000 | stuk | 319,00 | 172 | 0 |
| 0475718 | | platina-mat | 1380189006 | stuk | 479,00 | 172 | 1 |



Sanitair producten

Baden /
douchebakken /
stoomcabines**kleurset voor badafvoer-, overloop- en vulcombinatie**

| | | | | | | | |
|---------|--|-------------|------------|------|--------|-----|---|
| 0470610 | | chroom | 3622697000 | stuk | 153,00 | 172 | 1 |
| 0471622 | | platina-mat | 3622697006 | stuk | 244,00 | 172 | 1 |
| 0470334 | | messaging | 3622697009 | stuk | 244,00 | 172 | 1 |



Kranen

Douchegarnituur

badkraan m.omstel m. garnituur m. koppelingen

| | | | | | | | |
|---------|--|-------------|------------|------|---------|-----|---|
| 0471623 | | chroom | 2513389000 | stuk | 769,00 | 172 | 0 |
| 0473545 | | platina-mat | 2513389006 | stuk | 1153,00 | 172 | 1 |

Accessoires en
spiegels**badkraan m. omstel z. garnituur m. koppelingen**

| | | | | | | | |
|---------|--|-------------|------------|------|--------|-----|---|
| 0470724 | | chroom | 2510089000 | stuk | 507,00 | 172 | 1 |
| 0473537 | | platina-mat | 2510089006 | stuk | 761,00 | 172 | 1 |



Douchewanden

Toebehoren &
afvoeren**badkraan m. regendouche m. handdouche m. koppelingen**

| | | | | | | | |
|---------|--------------------|-------------|------------|------|---------|-----|---|
| 0470760 | gebogen douchepijp | chroom | 2560389000 | stuk | 1808,00 | 172 | 1 |
| 0473553 | gebogen douchepijp | platina-mat | 2560389006 | stuk | 2712,00 | 172 | 1 |
| 0471626 | hoekige douchepijp | chroom | 2561389000 | stuk | 1808,00 | 172 | 1 |
| 0471627 | hoekige douchepijp | platina-mat | 2561389006 | stuk | 2712,00 | 172 | 1 |

Spoel- &
installatiesystemenBadkamermeubelen
en toiletkastenGootstenen en
wastroggen**douchekraan HOH=15cm m. koppelingen z. omstel**

| | | | | | | | |
|---------|--|-------------|------------|------|--------|-----|---|
| 0470732 | | chroom | 2610089000 | stuk | 409,00 | 172 | 0 |
| 0473588 | | platina-mat | 2610089006 | stuk | 614,00 | 172 | 1 |



Utiliteit

douchekraan m. regendouche m. handdouche m. koppelingen

| | | | | | | | |
|---------|--|-------------|------------|------|---------|-----|---|
| 0471630 | | chroom | 2661189000 | stuk | 1477,00 | 172 | 1 |
| 0471632 | | platina-mat | 2661189006 | stuk | 2216,00 | 172 | 1 |









**douchethermostaat 1/2" z. hendel m. koppelingen**

| | | | | | | | |
|---------|------------------|-------------|------------|------|--------|-----|---|
| 0472522 | | chroom | 3442097000 | stuk | 468,00 | 172 | 0 |
| 0470049 | | messaging | 3442097009 | stuk | 703,00 | 172 | 1 |
| 0471637 | | platina-mat | 3442097006 | stuk | 703,00 | 172 | 1 |
| 0471620 | schaalgreep | platina-mat | 1142089006 | stuk | 211,00 | 172 | 1 |
| 0472719 | temperatuurgreep | chroom | 1142022000 | stuk | 141,00 | 172 | 1 |

**douchethermostaat 1/2" m. regendouche m. handdouche m. koppelingen**

| | | | | | | | |
|---------|------------------|-------------|------------|------|---------|-----|---|
| 0471639 | | chroom | 3445697000 | stuk | 1526,00 | 172 | 1 |
| 0471640 | | platina-mat | 3445697006 | stuk | 2289,00 | 172 | 1 |
| 0471620 | schaalgreep | platina-mat | 1142089006 | stuk | 211,00 | 172 | 1 |
| 0472719 | temperatuurgreep | chroom | 1142022000 | stuk | 141,00 | 172 | 1 |



| | Art.nr | Specificaties | Kleur | Lev.nr | Ehd | Prijs | Grp | CC | |
|---|---|---------------|-------------------------------------|-------------|------------|--------|--------|-----|---|
| | Dornbracht Tara | | | | | | | | |
| | afbouwdeel inbouwstopkraan | | | | | | | | |
| Sanitair producten |  | 0472680 | chroom | 3631089000 | stuk | 75,00 | 172 | 0 | |
| | | 0472679 | platina-mat | 3631089006 | stuk | 112,00 | 172 | 1 | |
| | | 0272606 | platina | 3631089008 | stuk | 112,00 | 172 | 1 | |
| | | 0472671 | inbouwdeel voor stopkraan koud 1/2" | | 3562197090 | stuk | 62,50 | 172 | 0 |
| | | 0472673 | inbouwdeel voor stopkraan koud 3/4" | | 3562297090 | stuk | 81,00 | 172 | 0 |
| | | 0472675 | inbouwdeel voor stopkraan koud 15mm | | 3563197090 | stuk | 62,50 | 172 | 0 |
| Baden / douchebakken / stoomcabines | | 0472677 | inbouwdeel voor stopkraan koud 22mm | | 3563397090 | stuk | 81,00 | 172 | 1 |
| | New afbouwdeel 2/3 weg omstel | | | | | | | | |
| Kranen |  | 0433094 | chroom | 3610489000 | stuk | 192,00 | 172 | 0 | |
| | | 0470319 | platina-mat | 3610489006 | stuk | 288,00 | 172 | 1 | |
| | | 0433095 | platina | 3610489008 | stuk | 288,00 | 172 | 1 | |
| | | 0433059 | 2-weg omstel voor inbouwmontage | chroom | 3512497090 | stuk | 211,00 | 172 | 0 |
| | | 0433060 | 3-weg omstel voor inbouwmontage | chroom | 3510497090 | stuk | 257,00 | 172 | 1 |
| Douchegarnituur | | | | | | | | | |
| | Dornbracht Tara Classic | | | | | | | | |
| | kraanhendel | | | | | | | | |
| Accessoires en spiegels |  | 0472379 | chroom | 1117088000 | stuk | 46,75 | 172 | 0 | |
| | | 0472384 | platin | 1117088008 | stuk | 46,75 | 172 | 1 | |
| | | 0472382 | platina-mat | 1117088006 | stuk | 46,75 | 172 | 0 | |
| | | 0472222 | messaging | 1117088009 | stuk | 46,75 | 172 | 1 | |
| | | 0472791 | matzwart | 1117088033 | stuk | 46,75 | 172 | 1 | |
| Douchewanden | | | | | | | | | |
| | toiletkraan 100mm m. uitloop m. hendel rechts | | | | | | | | |
| Toebehoren & afvoeren |  | 0472492 | chroom | 1751088000 | stuk | 229,00 | 172 | 0 | |
| | | 0473669 | platina-mat | 1751088006 | stuk | 343,00 | 172 | 1 | |
| | toiletkraan 100mm m. uitloop m. hendel links | | | | | | | | |
| Spoel- & installatiesystemen |  | 0474118 | chroom | 1751088100 | stuk | 229,00 | 172 | 1 | |
| | | 0470073 | platina-mat | 1751088106 | stuk | 343,00 | 172 | 1 | |
| Badkamermeubelen en toiletkasten | | | | | | | | | |
| | toiletkraan rechts | | | | | | | | |
| Gootstenen en wastroggen |  | 0433120 | 135mm | chroom | 1751288000 | stuk | 240,00 | 172 | 1 |
| | | 0433121 | 135mm | platina-mat | 1751288006 | stuk | 361,00 | 172 | 1 |
| | | 0433122 | 135mm | platina | 1751288008 | stuk | 361,00 | 172 | 1 |
| Utiliteit | | | | | | | | | |
| | wastafelkraan 100mm m. uitloop m. hendel links + rechts | | | | | | | | |
|  | 0474126 | chroom | 2232188000 | stuk | 299,00 | 172 | 1 | | |
| | 0476153 | platina-mat | 2232188006 | stuk | 449,00 | 172 | 1 | | |
| | 1-gats wastafelkraan z. hendel rechts m. waste m. uitloop 165mm | | | | | | | | |
|  | 0472557 | chroom | 3351388000 | stuk | 449,00 | 172 | 0 | | |
| | 0473723 | platina-mat | 3351388006 | stuk | 674,00 | 172 | 1 | | |
| | 0472382 | kraanhendel | platina-mat | 1117088006 | stuk | 46,75 | 172 | 0 | |
| | 1-gats wastafelkraan z. hendel links m. waste m. uitloop 165mm | | | | | | | | |
|  | 0470068 | chroom | 3351388100 | stuk | 449,00 | 172 | 1 | | |
| | 0470069 | platina-mat | 3351388106 | stuk | 674,00 | 172 | 1 | | |
| | 0472382 | kraanhendel | platina-mat | 1117088006 | stuk | 46,75 | 172 | 0 | |

| Art.nr | Specificaties | Kleur | Lev.nr | Ehd | Prijs | Grp | CC |
|--------|---------------|-------|--------|-----|-------|-----|----|
|--------|---------------|-------|--------|-----|-------|-----|----|

Dornbracht Tara Classic

1-gats wastafelkraan z. hendel m. waste m. uitloop 135mm

| | | | | | | | |
|---------|-------------------------|-------------|------------|------|--------|-----|---|
| 0472352 | | chroom | 3350088000 | stuk | 428,00 | 172 | 0 |
| 0473715 | | platina-mat | 3350088006 | stuk | 642,00 | 172 | 1 |
| 0472382 | kraanhendel platina-mat | | 1117088006 | stuk | 46,75 | 172 | 0 |



Sanitair producten

Baden /
douchebakken /
stoomcabines**wastafelkraan m. verhoogde voet z. hendel m. waste**

| | | | | | | | |
|---------|-------------------------|-------------|------------|------|--------|-----|---|
| 0470070 | | chroom | 3353488000 | stuk | 612,00 | 172 | 1 |
| 0470071 | | platina-mat | 3353488006 | stuk | 917,00 | 172 | 1 |
| 0472382 | kraanhendel platina-mat | | 1117088006 | stuk | 46,75 | 172 | 0 |



Kranen

Douchegarnituur

2-gats wastafelkraan z. hendel

| | | | | | | | |
|---------|-------------------------|-------------|------------|------|--------|-----|---|
| 0470092 | | chroom | 1912388000 | stuk | 483,00 | 172 | 1 |
| 0470072 | | platina-mat | 1912388006 | stuk | 724,00 | 172 | 1 |
| 0472382 | kraanhendel platina-mat | | 1117088006 | stuk | 46,75 | 172 | 0 |

Accessoires en
spiegels**3-gats wastafelkraan z. hendel 135mm m. waste**

| | | | | | | | |
|---------|---|-------------|------------|------|--------|-----|---|
| 0473200 | | chroom | 2071088000 | stuk | 578,00 | 172 | 1 |
| 0475726 | | platina-mat | 2071088006 | stuk | 866,00 | 172 | 1 |
| 0472382 | kraanhendel platina-mat | | 1117088006 | stuk | 46,75 | 172 | 0 |
| 0475556 | handdouchegarnituur voor 2/3-gats wastafelkraan | platina-mat | 2771897006 | stuk | 397,00 | 172 | 1 |

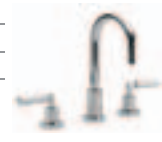

Douchewanden

Toebehoren &
afvoeren**3-gats wastafelkraan z. hendel 165mm m. waste**

| | | | | | | | |
|---------|---|-------------|------------|------|--------|-----|---|
| 0472697 | | chroom | 2071388000 | stuk | 607,00 | 172 | 1 |
| 0472695 | | platina-mat | 2071388006 | stuk | 910,00 | 172 | 1 |
| 0472382 | kraanhendel platina-mat | | 1117088006 | stuk | 46,75 | 172 | 0 |
| 0475556 | handdouchegarnituur voor 2/3-gats wastafelkraan | platina-mat | 2771897006 | stuk | 397,00 | 172 | 1 |

afbouwdeel wandkraan z. hendel

| | | | | | | | |
|---------|-------------------------------------|-------------|------------|------|--------|-----|---|
| 0474518 | 170mm | chroom | 3681088000 | stuk | 302,00 | 172 | 1 |
| 0470074 | 170mm | platina-mat | 3681088006 | stuk | 453,00 | 172 | 1 |
| 0474519 | 200mm | chroom | 3681288000 | stuk | 325,00 | 172 | 1 |
| 0470075 | 200mm | platina-mat | 3681288006 | stuk | 488,00 | 172 | 1 |
| 0474520 | 250mm | chroom | 3681688000 | stuk | 353,00 | 172 | 1 |
| 0470076 | 250mm | platina-mat | 3681688006 | stuk | 529,00 | 172 | 1 |
| 0475432 | inbouwdeel wastafelwandkraan rechts | | 3580697090 | stuk | 168,00 | 172 | 0 |
| 0475459 | inbouwdeel wastafelwandkraan boven | | 3580897090 | stuk | 168,00 | 172 | 1 |
| 0475527 | inbouwdeel wastafelwandkraan links | | 3580797090 | stuk | 168,00 | 172 | 0 |

Badkamermeubelen
en toiletkastenGootstenen en
wastroggen**afbouwdeel wandkraan 225mm z. hendel m. draaibare uitloop**

| | | | | | | | |
|---------|-------------------------------------|-------------|------------|------|--------|-----|---|
| 0474521 | | chroom | 3683488000 | stuk | 487,00 | 172 | 1 |
| 0470077 | | platina-mat | 3683488006 | stuk | 731,00 | 172 | 1 |
| 0475432 | inbouwdeel wastafelwandkraan rechts | | 3580697090 | stuk | 168,00 | 172 | 0 |
| 0475459 | inbouwdeel wastafelwandkraan boven | | 3580897090 | stuk | 168,00 | 172 | 1 |
| 0475527 | inbouwdeel wastafelwandkraan links | | 3580797090 | stuk | 168,00 | 172 | 0 |



Utiliteit









wanduitloop 20cm









| | | | | | | | |
|---------|--|-------------|------------|------|--------|-----|---|
| 0470175 | | chroom | 1380589000 | stuk | 288,00 | 172 | 1 |
| 0470341 | | platina | 1380589008 | stuk | 432,00 | 172 | 1 |
| 0470342 | | platina-mat | 1380589006 | stuk | 432,00 | 172 | 1 |

**New afbouwdeel muurkraan z. hendel**

| | | | | | | | |
|---------|---|--------|------------|------|--------|-----|---|
| 0433082 | 16cm | chroom | 3670788000 | stuk | 382,00 | 172 | 1 |
| 0433083 | 16cm | platin | 3670788008 | stuk | 573,00 | 172 | 1 |
| 0433084 | 19cm | chroom | 3671288000 | stuk | 401,00 | 172 | 0 |
| 0433085 | 19cm | platin | 3671288008 | stuk | 601,00 | 172 | 1 |
| 0433043 | inbouwset voor 3-gats muurkraan m. bronzen inbouwhuis | | 3570797090 | stuk | 167,00 | 172 | 0 |
| 0433044 | inbouwset voor 3-gats muurkraan m. 3 bronzen inbouwhuizen | | 3571297090 | stuk | 147,00 | 172 | 0 |



| | Art.nr | Specificaties | Kleur | Lev.nr | Ehd | Prijs | Grp | CC | |
|---|---|---|-------------------------|-------------|------------|---------|---------|-----|---|
| Dornbracht Tara Classic | | | | | | | | | |
| Sanitair producten |  | 1-gats bidetkraan z. hendel m. waste | | | | | | | |
| | | 0470038 | | chrom | 3360088000 | stuk | 535,00 | 172 | 1 |
| | | 0473731 | | platina-mat | 3360088006 | stuk | 802,00 | 172 | 1 |
| | 0472382 | kraanhendel platina-mat | | 1117088006 | stuk | 46,75 | 172 | 0 | |
| Baden / douchebakken / stoomcabines | | | | | | | | | |
| Kranen |  | bidetuitloop sprong 110mm m.waste | | | | | | | |
| | | 0471610 | | chrom | 1390089000 | stuk | 375,00 | 172 | 1 |
| | 0471611 | | platina-mat | 1390089006 | stuk | 562,00 | 172 | 1 | |
| Douchegarnituur | | | | | | | | | |
| Accessoires en spiegels |  | hoekstopkraan koud/warm m. rozet | | | | | | | |
| | | 0470716 | 1/2"x10mm | chrom | 2290089000 | stuk | 106,00 | 172 | 1 |
| | | 0470035 | 1/2"x10mm | platina-mat | 2290089006 | stuk | 158,00 | 172 | 1 |
| Douchewanden | | | | | | | | | |
| Toebehoren & afvoeren |  | 2-gats badrandcombinatie m. garnituur | | | | | | | |
| | | 0472525 | z. hendel | chrom | 2504388000 | stuk | 1319,00 | 172 | 1 |
| | | 0473677 | z. hendel | platina-mat | 2504388006 | stuk | 1979,00 | 172 | 1 |
| | | 0472382 | kraanhendel platina-mat | | 1117088006 | stuk | 46,75 | 172 | 0 |
| Spoel- & installatiesystemen | | | | | | | | | |
| Badkamermeubelen en toiletkasten |  | 4-gats badrandcombinatie | | | | | | | |
| | | 0472523 | z. hendel | chrom | 2751288000 | stuk | 1047,00 | 172 | 1 |
| | | 0470343 | z. hendel | platina-mat | 2751288006 | stuk | 1571,00 | 172 | 1 |
| | | thermostaat voor staande montage z. hendel | | | | | | | |
| | | 0472765 | | chrom | 3452597000 | stuk | 1373,00 | 172 | 1 |
| | 0471618 | | platina-mat | 3452597006 | stuk | 1681,00 | 172 | 1 | |
| Gootstenen en wastroggen |  | 0470588 | schaalgreep chrom | | 1142089000 | stuk | 141,00 | 172 | 0 |
| | | 0471620 | schaalgreep platina-mat | | 1142089006 | stuk | 211,00 | 172 | 1 |
| | | 0472719 | temperatuurgreep chrom | | 1142022000 | stuk | 141,00 | 172 | 1 |
| | | baduitloop m. omstel | | | | | | | |
| Utiliteit |  | 0441204 | | chrom | 1351289000 | stuk | 511,00 | 172 | 1 |
| | | 0471621 | | platina-mat | 1351289006 | stuk | 766,00 | 172 | 1 |
| | | | | | | | | | |
| |  | baduitloop 3/4" wandmontage | | | | | | | |
| | | 0472611 | | chrom | 1380189000 | stuk | 319,00 | 172 | 0 |
| | 0475718 | | platina-mat | 1380189006 | stuk | 479,00 | 172 | 1 | |
| | | | | | | | | | |
| |  | badkraan z. hendel m. garnituur m. koppelingen | | | | | | | |
| | | 0470018 | | chrom | 2513388000 | stuk | 701,00 | 172 | 1 |
| | | 0473685 | | platina-mat | 2513388006 | stuk | 1051,00 | 172 | 1 |
| | | 0472379 | kraanhendel chrom | | 1117088000 | stuk | 46,75 | 172 | 0 |
| | | 0472382 | kraanhendel platina-mat | | 1117088006 | stuk | 46,75 | 172 | 0 |

| Art.nr | Specificaties | Kleur | Lev.nr | Ehd | Prijs | Grp | CC | | | |
|---|-------------------------------------|-------------|------------|------|---------|-----|----|---|---|--|
| | | | | | | | | Dornbracht Tara Classic | | |
| badkraan m. omstel z. hendel z. garnituur m. koppelingen | | | | | | | | | | |
| 0474003 | | chroom | 2510088000 | stuk | 405,00 | 172 | 1 |  | Sanitair producten | |
| 0470088 | | platina-mat | 2510088006 | stuk | 607,00 | 172 | 1 | | Baden / douchebakken / stoomcabines | |
| 0472382 | kraanhendel | platina-mat | 1117088006 | stuk | 46,75 | 172 | 0 | | Kranen | |
| douchekraan z. omstel z. hendel m. koppelingen | | | | | | | | | | |
| 0470736 | | chroom | 2610088000 | stuk | 360,00 | 172 | 1 |  | | |
| 0473693 | | platina-mat | 2610088006 | stuk | 540,00 | 172 | 1 | | Douchegarnituur | |
| 0472382 | kraanhendel | platina-mat | 1117088006 | stuk | 46,75 | 172 | 0 | | Accessoires en spiegels | |
| douchethermostaat 1/2" z. hendel m. koppelingen | | | | | | | | | | |
| 0472522 | | chroom | 3442097000 | stuk | 468,00 | 172 | 0 |  | | |
| 0470049 | | messaging | 3442097009 | stuk | 703,00 | 172 | 1 | | Douchewanden | |
| 0471637 | | platina-mat | 3442097006 | stuk | 703,00 | 172 | 1 | | | |
| 0471620 | schaalgreep | platina-mat | 1142089006 | stuk | 211,00 | 172 | 1 | | | |
| 0472719 | temperatuurgreep | chroom | 1142022000 | stuk | 141,00 | 172 | 1 | | | |
| douchethermostaat 1/2" m. regendouche m. handdouche m. koppelingen | | | | | | | | | | |
| 0471639 | | chroom | 3445697000 | stuk | 1526,00 | 172 | 1 |  | | |
| 0471640 | | platina-mat | 3445697006 | stuk | 2289,00 | 172 | 1 | | Toebehoren & afvoeren | |
| 0471620 | schaalgreep | platina-mat | 1142089006 | stuk | 211,00 | 172 | 1 | | Spool- & installatiesystemen | |
| 0472719 | temperatuurgreep | chroom | 1142022000 | stuk | 141,00 | 172 | 1 | | | |
| afbouwdeel inbouwdouchekraan m. garnituur z. hendel | | | | | | | | | | |
| 0474522 | | chroom | 3601088000 | stuk | 667,00 | 172 | 1 |  | | |
| 0470095 | | platina-mat | 3601088006 | stuk | 1000,00 | 172 | 1 | | Badkamermeubelen en toiletkasten | |
| 0472379 | kraanhendel | chroom | 1117088000 | stuk | 46,75 | 172 | 0 | | Gootstenen en wastroggen | |
| 0472382 | kraanhendel | platina-mat | 1117088006 | stuk | 46,75 | 172 | 0 | | Utiliteit | |
| 0475467 | inbouwdeel douchekraan rechts | | 3500697090 | stuk | 171,00 | 172 | 1 | | | |
| 0475475 | inbouwdeel douchekraan links | | 3500797090 | stuk | 171,00 | 172 | 1 | | | |
| afbouwdeel inbouwdouchekraan m. rozet | | | | | | | | | | |
| 0474523 | | chroom | 3600888000 | stuk | 161,00 | 172 | 1 |  | | |
| 0470098 | | platina-mat | 3600888006 | stuk | 241,00 | 172 | 1 | | | |
| 0472382 | kraanhendel | platina-mat | 1117088006 | stuk | 46,75 | 172 | 0 | | | |
| 0475537 | inbouwdeel voor inbouwdouchekraan | | 3500897090 | stuk | 171,00 | 172 | 0 | | | |
| afbouwdeel inbouwstopkraan z. hendel | | | | | | | | | | |
| 0472681 | | chroom | 3631088000 | stuk | 42,50 | 172 | 0 |  | | |
| 0472682 | | platina-mat | 3631088006 | stuk | 64,00 | 172 | 1 | | | |
| 0472379 | kraanhendel | chroom | 1117088000 | stuk | 46,75 | 172 | 0 | | | |
| 0472671 | inbouwdeel voor stopkraan koud 1/2" | | 3562197090 | stuk | 62,50 | 172 | 0 | | | |
| 0472672 | inbouwdeel voor stopkraan warm 1/2" | | 3567197090 | stuk | 62,50 | 172 | 0 | | | |
| 0472673 | inbouwdeel voor stopkraan koud 3/4" | | 3562297090 | stuk | 81,00 | 172 | 0 | | | |
| 0472674 | inbouwdeel voor stopkraan warm 3/4" | | 3567297090 | stuk | 81,00 | 172 | 0 | | | |
| 0472675 | inbouwdeel voor stopkraan koud 15mm | | 3563197090 | stuk | 62,50 | 172 | 0 | | | |
| 0472676 | inbouwdeel voor stopkraan warm 15mm | | 3568197090 | stuk | 62,50 | 172 | 0 | | | |
| 0472677 | inbouwdeel voor stopkraan koud 22mm | | 3563397090 | stuk | 81,00 | 172 | 1 | | | |
| 0472678 | inbouwdeel voor stopkraan warm 22mm | | 3568397090 | stuk | 81,00 | 172 | 1 | | | |
| New kleurset voor 2/3 weg omstel z. hendel | | | | | | | | | | |
| 0433086 | | chroom | 3610488000 | stuk | 183,00 | 172 | 1 | |  | |
| 0433087 | | platina | 3610488008 | stuk | 274,00 | 172 | 1 | | | |
| 0433123 | | platina-mat | 3610488006 | stuk | 274,00 | 172 | 1 | | | |
| 0433059 | 2-weg omstel voor inbouwmontage | chroom | 3512497090 | stuk | 211,00 | 172 | 0 | | | |
| 0433060 | 3-weg omstel voor inbouwmontage | chroom | 3510497090 | stuk | 257,00 | 172 | 1 | | | |
| 0472384 | kraanhendel | platin | 1117088008 | stuk | 46,75 | 172 | 1 | | | |
| afbouwdeel inbouwstopkraan | | | | | | | | | | |
| 0472680 | | chroom | 3631089000 | stuk | 75,00 | 172 | 0 |  | | |
| 0472679 | | platina-mat | 3631089006 | stuk | 112,00 | 172 | 1 | | | |
| 0272606 | | platina | 3631089008 | stuk | 112,00 | 172 | 1 | | | |
| 0472671 | inbouwdeel voor stopkraan koud 1/2" | | 3562197090 | stuk | 62,50 | 172 | 0 | | | |
| 0472673 | inbouwdeel voor stopkraan koud 3/4" | | 3562297090 | stuk | 81,00 | 172 | 0 | | | |
| 0472675 | inbouwdeel voor stopkraan koud 15mm | | 3563197090 | stuk | 62,50 | 172 | 0 | | | |
| 0472677 | inbouwdeel voor stopkraan koud 22mm | | 3563397090 | stuk | 81,00 | 172 | 1 | | | |

TARA.LOGIC









<physical>













DORN
BRACHT











the SPIRIT of WATER

TARA .LOGIC is een nieuwe, progressieve armaturensérie. Zij is gebaseerd op de vormtaal van de TARA CLASSIC, een eigentijdse designklassieker, maar wordt gekenmerkt door een verlengde en opwaartse vormgeving. TARA .LOGIC is vormgegeven door Sieger Design. Aloys F. Dornbracht GmbH & Co. KG, Köbbingser Mühle 6, D-58640 Iserlohn, Germany. Onze TARA .LOGIC-brochure kunt u direct aanvragen bij: Burgmans Agenturen B.V., Hoofdweg 92, 2908 LC Capelle a/d IJssel, Tel. +31 (0)10 - 450 8451, Fax +31 (0)10 - 458 8670, E-Mail info@burgmans.nl www.dornbracht.com

| Art.nr | Specificaties | Kleur | Lev.nr | Ehd | Prijs | Grp | CC | | |
|--|---------------|-------------|------------|------|---------|-----|----|---|---|
| | | | | | | | | Dornbracht Tara Logic | |
| 1-gats wastafelkraan 17cm | | | | | | | | | |
| 0475010 | | chroom | 3350088500 | stuk | 421,60 | 172 | 1 |  | Sanitair producten |
| 0475011 | | platina mat | 3350088506 | stuk | 632,30 | 172 | 1 | | |
| 1-gats wastafelkraan 12cm | | | | | | | | | |
| 0475012 | | chroom | 3351088500 | stuk | 398,80 | 172 | 1 |  | Baden / douchebakken / stoomcabines |
| 0475013 | | platina mat | 3351088506 | stuk | 598,10 | 172 | 1 | | |
| 1-gats wastafelkraan verhoogd 20cm | | | | | | | | | |
| 0475014 | | chroom | 3353388500 | stuk | 590,70 | 172 | 1 |  | Douchegarnituur |
| 0475015 | | platina mat | 3353388506 | stuk | 886,00 | 172 | 1 | | |
| 1-gats wastafelkraan m. standpijp | | | | | | | | | |
| 0475016 | | chroom | 3358488500 | stuk | 1286,50 | 172 | 1 |  | Douchewanden |
| 0475018 | | platina mat | 3358488506 | stuk | 1929,70 | 172 | 1 | | |
| toiletkraan m. draaibare uitloop 12cm | | | | | | | | | |
| 0475019 | | chroom | 1750088500 | stuk | 211,10 | 172 | 1 |  | Toebehoren & afvoeren |
| 0475020 | | platina mat | 1750088506 | stuk | 316,60 | 172 | 1 | | |
| afbouwdeel voor wandkraan 20cm | | | | | | | | | |
| 0475021 | | chroom | 3682288500 | stuk | 468,90 | 172 | 1 |  | Spoel- & installatiesystemen |
| 0475022 | | platina mat | 3682288506 | stuk | 703,40 | 172 | 1 | | |
| 1-gats bidetkraan 11cm | | | | | | | | | |
| 0475023 | | chroom | 3360088500 | stuk | 524,10 | 172 | 1 |  | Badkamermeubelen en toiletkasten |
| 0475024 | | platina mat | 3360088506 | stuk | 786,20 | 172 | 1 | | |
| 3-gats bad-/tegelrand kraan | | | | | | | | | |
| 0475026 | | chroom | 2731288500 | stuk | 1062,10 | 172 | 1 |  | Gootstenen en wastroggen |
| 0475027 | | platina mat | 2731288506 | stuk | 1593,20 | 172 | 1 | | |
| 3-gats tegelrandkraan m. afdekplaat | | | | | | | | | |
| 0475028 | | chroom | 2732288500 | stuk | 1130,50 | 172 | 1 | | Utiliteit |
| 0475029 | | platina mat | 2732288506 | stuk | 1695,70 | 172 | 1 | | |

| | Art.nr | Specificaties | Kleur | Lev.nr | Ehd | Prijs | Grp | CC | |
|---|---|--|-------|-------------|------------|-------|---------|-------|---|
| | Dornbracht Tara Logic | | | | | | | | |
| Sanitair producten |  | 1-gats bad-/tegelrand kraan | | | | | | | |
| | | 0475030 | | chroom | 2920088500 | stuk | 375,70 | 172 | 1 |
| | | 0475031 | | platina mat | 2920088506 | stuk | 563,50 | 172 1 | |
| Baden / douchebakken / stoomcabines | | 2-weg omstel voor badrandkraan | | | | | | | |
| Kranen |  | 0475032 | | chroom | 2914097900 | stuk | 397,50 | 172 1 | |
| | | 0475034 | | platina mat | 2914097906 | stuk | 596,20 | 172 1 | |
| Douchegarnituur | | baduitloop m. omstel | | | | | | | |
| Accessoires en spiegels |  | 0475035 | | chroom | 1351288500 | stuk | 492,70 | 172 1 | |
| | | 0475036 | | platina mat | 1351288506 | stuk | 738,90 | 172 1 | |
| Douchewanden | | baduitloop m. standpijp | | | | | | | |
| Toebehoren & afvoeren |  | 0475037 | | chroom | 1367288500 | stuk | 910,50 | 172 1 | |
| | | 0475038 | | platina mat | 1367288506 | stuk | 1365,80 | 172 1 | |
| Spoel- & installatiesystemen | | baduitloop voor wand | | | | | | | |
| Badkamermeubelen en toiletkasten |  | 0475039 | | chroom | 1380188500 | stuk | 310,30 | 172 1 | |
| | | 0475040 | | platina mat | 1380188506 | stuk | 465,40 | 172 1 | |
| Gootstenen en wastroggen | | badkraan m. omstel m. garnituur | | | | | | | |
| Utiliteit |  | 0475042 | | chroom | 3323388500 | stuk | 816,60 | 172 1 | |
| | | 0475043 | | platina mat | 3323388506 | stuk | 1224,90 | 172 1 | |
| | | badkraan m. omstel z. garnituur | | | | | | | |
| |  | 0475044 | | chroom | 3320088500 | stuk | 544,00 | 172 1 | |
| | | 0475045 | | platina mat | 3320088506 | stuk | 816,00 | 172 1 | |
| | | douchekraan z. omstel HOH=15cm | | | | | | | |
| |  | 0475046 | | chroom | 3330088500 | stuk | 431,40 | 172 1 | |
| | | 0475047 | | platina mat | 3330088506 | stuk | 647,00 | 172 1 | |
| | Dornbracht Yota | | | | | | | | |
| |  | 1-gats wastafelkraan m. waste | | | | | | | |
| | | 0085952 | | chroom | 3350087000 | stuk | 350,00 | 172 1 | |
| | | 0085960 | | platina-mat | 3350087006 | stuk | 524,00 | 172 1 | |

| Art.nr | Specificaties | Kleur | Lev.nr | Ehd | Prijs | Grp | CC | | |
|---|---|-------------|------------|------|--------|-----|----|---|---|
| | | | | | | | | Dornbracht Yota | |
| 1-gats wastafelkraan z. waste | | | | | | | | | |
| 0474410 | | chroom | 3352587000 | stuk | 293,00 | 172 | 1 |  | Sanitair producten |
| 0474411 | | platina-mat | 3352587006 | stuk | 440,00 | 172 | 1 | | Baden / douchebakken / stoomcabines |
| 1-gats wastafelkraan verhoogd m. waste | | | | | | | | | |
| 0474412 | | chroom | 3353687000 | stuk | 517,00 | 172 | 1 |  | Kranen |
| 0474413 | | platina-mat | 3353687006 | stuk | 776,00 | 172 | 1 | | |
| 1-gats wastafelkraan verhoogd z. waste | | | | | | | | | |
| 0474414 | | chroom | 3353787000 | stuk | 466,00 | 172 | 1 |  | Douchegarnituur |
| 0474415 | | platina-mat | 3353787006 | stuk | 699,00 | 172 | 1 | | Accessoires en spiegels |
| 3-gats wastafelkraan m. waste | | | | | | | | | |
| 0085979 | | chroom | 2070087000 | stuk | 635,00 | 172 | 1 |  | Douchewanden |
| 0085987 | | platina-mat | 2070087006 | stuk | 952,00 | 172 | 1 | | |
| 0475289 | handdouchegarnituur voor 2/3-gats wastafelkraan | chroom | 2771897000 | stuk | 265,00 | 172 | 1 | | |
| 0475556 | handdouchegarnituur voor 2/3-gats wastafelkraan | platina-mat | 2771897006 | stuk | 397,00 | 172 | 1 | | |
| afbouwdeel wandkraan 160mm | | | | | | | | | |
| 0474524 | | chroom | 3681087000 | stuk | 367,00 | 172 | 1 |  | Toebehoren & afvoeren |
| 0470100 | | platina-mat | 3681087006 | stuk | 550,00 | 172 | 1 | | |
| 0475432 | inbouwdeel wastafelwandkraan rechts | | 3580697090 | stuk | 168,00 | 172 | 0 | | |
| 0475459 | inbouwdeel wastafelwandkraan boven | | 3580897090 | stuk | 168,00 | 172 | 1 | | |
| 0475527 | inbouwdeel wastafelwandkraan links | | 3580797090 | stuk | 168,00 | 172 | 0 | | |
| afbouwdeel wandkraan 200mm | | | | | | | | | |
| 0474526 | | chroom | 3681287000 | stuk | 391,00 | 172 | 1 |  | Badkamermeubelen en toiletkasten |
| 0470103 | | platina-mat | 3681287006 | stuk | 587,00 | 172 | 1 | | |
| 0475432 | inbouwdeel wastafelwandkraan rechts | | 3580697090 | stuk | 168,00 | 172 | 0 | | |
| 0475459 | inbouwdeel wastafelwandkraan boven | | 3580897090 | stuk | 168,00 | 172 | 1 | | |
| 0475527 | inbouwdeel wastafelwandkraan links | | 3580797090 | stuk | 168,00 | 172 | 0 | | |
| New afbouwdeel 3-gats wandkraan | | | | | | | | | |
| 0433096 | 20cm | chroom | 3671287000 | stuk | 473,00 | 172 | 1 |  | Gootstenen en wastroggen |
| 0433043 | inbouwset voor 3-gats muurkraan m. bronzen inbouwhuis | | 3570797090 | stuk | 167,00 | 172 | 0 | | |
| 0433044 | inbouwset voor 3-gats muurkraan m. 3 bronzen inbouwhuizen | | 3571297090 | stuk | 147,00 | 172 | 0 | | |
| 1-gats bidetkraan | | | | | | | | | |
| 0086010 | | chroom | 3360087000 | stuk | 438,00 | 172 | 1 |  | Utiliteit |
| 0086029 | | platina-mat | 3360087006 | stuk | 657,00 | 172 | 1 | | |
| stopkraan staand rechts | | | | | | | | | |
| 0086118 | | chroom | 2000087000 | stuk | 120,00 | 172 | 1 |  | |
| 0086126 | | platina-mat | 2000087006 | stuk | 179,00 | 172 | 1 | | |
| stopkraan staand links | | | | | | | | | |
| 0086134 | | chroom | 2000087100 | stuk | 120,00 | 172 | 1 |  | |
| 0086142 | | platina-mat | 2000087106 | stuk | 179,00 | 172 | 1 | | |

| | Art.nr | Specificaties | Kleur | Lev.nr | Ehd | Prijs | Grp | CC |
|---|---|--|-------------|------------|------|---------|-----|----|
| | Dornbracht Yota | | | | | | | |
| | afbouwdeel 4-gats badkraan | | | | | | | |
| Sanitair producten |  | 0086037 | chroom | 2750287000 | stuk | 1141,00 | 172 | 1 |
| | | 0086045 | platina-mat | 2750287006 | stuk | 1711,00 | 172 | 1 |
| | | 0470155 Perfecto montagesysteem 1/2" voor 4-gats kraan | | 1261097090 | stuk | 555,00 | 172 | 0 |
| | | 0470163 Perfecto sierrozetten voor montagesysteem | chroom | 1280197000 | stuk | 27,75 | 172 | 0 |
| Baden / douchebakken / stoomcabines |  | thermostaat voor staande montage z. hendel | | | | | | |
| | | 0472765 | chroom | 3452597000 | stuk | 1373,00 | 172 | 1 |
| | | 0471618 | platina-mat | 3452597006 | stuk | 1681,00 | 172 | 1 |
| Kranen | | 0470588 schaalgreep | chroom | 1142089000 | stuk | 141,00 | 172 | 0 |
| | | 0471620 schaalgreep | platina-mat | 1142089006 | stuk | 211,00 | 172 | 1 |
| | | 0472719 temperatuurgreep | chroom | 1142022000 | stuk | 141,00 | 172 | 1 |
| Douchegarnituur |  | douchegarnituur voor badrandmontage | | | | | | |
| | | 0474402 | chroom | 2770297900 | stuk | 290,00 | 172 | 1 |
| | | 0474403 | platina-mat | 2770297906 | stuk | 400,00 | 172 | 1 |
| Accessoires en spiegels | | baduitloop 3/4" wandmontage | | | | | | |
| |  | 0472611 | chroom | 1380189000 | stuk | 319,00 | 172 | 0 |
| Douchewanden | | 0475718 | platina-mat | 1380189006 | stuk | 479,00 | 172 | 1 |
| Toebehoren & afvoeren |  | kleurset voor badafvoer, overloop- en vulcombinatie | | | | | | |
| | | 0470610 | chroom | 3622697000 | stuk | 153,00 | 172 | 1 |
| | | 0471622 | platina-mat | 3622697006 | stuk | 244,00 | 172 | 1 |
| Spoel- & installatiesystemen | | 0470334 | messing | 3622697009 | stuk | 244,00 | 172 | 1 |
| Badkamermeubelen en toiletkasten |  | badkraan m. omstel m. garnituur m. koppelingen | | | | | | |
| | | 0474416 | chroom | 3323387000 | stuk | 689,00 | 172 | 1 |
| | | 0474417 | platina-mat | 3323387006 | stuk | 1033,00 | 172 | 1 |
| Gootstenen en wastroggen | | badkraan m. omstel z. garnituur m. koppelingen | | | | | | |
| |  | 0474418 | chroom | 3320087000 | stuk | 476,00 | 172 | 1 |
| | | 0474419 | platina-mat | 3320087006 | stuk | 714,00 | 172 | 1 |
| Utiliteit |  | douchekraan z. omstel m. koppelingen | | | | | | |
| | | 0474420 | chroom | 3330087000 | stuk | 309,00 | 172 | 1 |
| | | 0474421 | platina-mat | 3330087006 | stuk | 464,00 | 172 | 1 |
| |  | douchethermostaat 1/2" z. hendel m. koppelingen | | | | | | |
| | | 0472522 | chroom | 3442097000 | stuk | 468,00 | 172 | 0 |
| | | 0470049 | messing | 3442097009 | stuk | 703,00 | 172 | 1 |
| | | 0471637 | platina-mat | 3442097006 | stuk | 703,00 | 172 | 1 |
| | | 0471620 schaalgreep | platina-mat | 1142089006 | stuk | 211,00 | 172 | 1 |
| | | 0472719 temperatuurgreep | chroom | 1142022000 | stuk | 141,00 | 172 | 1 |
| |  | Xstream afbouwdeel inbouwbadkraan | | | | | | |
| | | 0474529 | chroom | 3611587000 | stuk | 305,00 | 172 | 1 |
| | | 0470106 | platina-mat | 3611587006 | stuk | 458,00 | 172 | 1 |
| | | 0475910 inbouwdeel voor inbouwbad/douchekraan | | 3511597090 | stuk | 288,00 | 172 | 0 |

| Art.nr | Specificaties | Kleur | Lev.nr | Ehd | Prijs | Grp | CC |
|--------|---------------|-------|--------|-----|-------|-----|----|
|--------|---------------|-------|--------|-----|-------|-----|----|

Dornbracht Yota

Xstream afbouwdeel inbouwdouchekraan

| | | | | | | | |
|---------|---------------------------------------|-------------|------------|------|--------|-----|---|
| 0474530 | | chroom | 3601587000 | stuk | 212,00 | 172 | 1 |
| 0470107 | | platina-mat | 3601587006 | stuk | 318,00 | 172 | 1 |
| 0475910 | inbouwdeel voor inbouwbad/douchekraan | | 3511597090 | stuk | 288,00 | 172 | 0 |



Sanitair producten

Baden /
douchebakken /
stoomcabines**afbouwdeel inbouwdouchekraan m. garnituur**

| | | | | | | | |
|---------|--------------------------------|-------------|------------|------|---------|-----|---|
| 0474527 | | chroom | 3601087000 | stuk | 721,00 | 172 | 1 |
| 0470108 | | platina-mat | 3601087006 | stuk | 1082,00 | 172 | 1 |
| 0475467 | inbouwdeel douche kraan rechts | | 3500697090 | stuk | 171,00 | 172 | 1 |
| 0475475 | inbouwdeel douche kraan links | | 3500797090 | stuk | 171,00 | 172 | 1 |



Kranen

Douchegarnituur

afbouwdeel inbouwdouchekraan m. rozet

| | | | | | | | |
|---------|-----------------------------------|-------------|------------|------|--------|-----|---|
| 0474528 | | chroom | 3600887000 | stuk | 215,00 | 172 | 1 |
| 0470109 | | platina-mat | 3600887006 | stuk | 323,00 | 172 | 1 |
| 0475537 | inbouwdeel voor inbouwdouchekraan | | 3500897090 | stuk | 171,00 | 172 | 0 |

Accessoires en
spiegels**afbouwdeel inbouwstopkraan**

| | | | | | | | |
|---------|-------------------------------------|-------------|------------|------|--------|-----|---|
| 0472683 | | chroom | 3631087000 | stuk | 78,00 | 172 | 1 |
| 0472684 | | platina-mat | 3631087006 | stuk | 117,00 | 172 | 1 |
| 0472671 | inbouwdeel voor stopkraan koud 1/2" | | 3562197090 | stuk | 62,50 | 172 | 0 |
| 0472672 | inbouwdeel voor stopkraan warm 1/2" | | 3567197090 | stuk | 62,50 | 172 | 0 |
| 0472673 | inbouwdeel voor stopkraan koud 3/4" | | 3562297090 | stuk | 81,00 | 172 | 0 |
| 0472674 | inbouwdeel voor stopkraan warm 3/4" | | 3567297090 | stuk | 81,00 | 172 | 0 |
| 0472675 | inbouwdeel voor stopkraan koud 15mm | | 3563197090 | stuk | 62,50 | 172 | 0 |
| 0472676 | inbouwdeel voor stopkraan warm 15mm | | 3568197090 | stuk | 62,50 | 172 | 0 |
| 0472677 | inbouwdeel voor stopkraan koud 22mm | | 3563397090 | stuk | 81,00 | 172 | 1 |
| 0472678 | inbouwdeel voor stopkraan warm 22mm | | 3568397090 | stuk | 81,00 | 172 | 1 |



Douchewanden

Toebehoren &
afvoeren**New afbouwdeel 2/3 weg omstel**

| | | | | | | | |
|---------|---------------------------------|-------------|------------|------|--------|-----|---|
| 0433098 | | chroom | 3610487000 | stuk | 200,00 | 172 | 1 |
| 0433099 | | platina-mat | 3610487006 | stuk | 300,00 | 172 | 1 |
| 0433059 | 2-weg omstel voor inbouwmontage | chroom | 3512497090 | stuk | 211,00 | 172 | 0 |
| 0433060 | 3-weg omstel voor inbouwmontage | chroom | 3510497090 | stuk | 257,00 | 172 | 1 |

Spoel- &
installatiesystemenBadkamermeubelen
en toiletkastenGootstenen en
wastroggen

Dornbracht Interiors

Turn Around passpiegel op wielen 45x180cm

| | | | | | | | |
|---------|--|--|--------|------|--------|-----|---|
| 0471106 | | | 111901 | stuk | 900,00 | 172 | 1 |
|---------|--|--|--------|------|--------|-----|---|



Utiliteit









Me spiegel staand

| | | | | | | | |
|---------|--|----------------|--------|------|-------|-----|---|
| 0471122 | | alu. gestraald | 101701 | stuk | 79,00 | 172 | 1 |
|---------|--|----------------|--------|------|-------|-----|---|

**Float 1 handdoekhouder vrijhangend enkel**

| | | | | | | | |
|---------|--|----------|--------|------|--------|-----|---|
| 0471129 | | alu./mat | 131101 | stuk | 102,00 | 172 | 1 |
|---------|--|----------|--------|------|--------|-----|---|



| | Art.nr | Specificaties | Kleur | Lev.nr | Ehd | Prijs | Grp | CC |
|---|---|---|----------------|------------|------|---------|-----|----|
| | Dornbracht Interiors | | | | | | | |
| Sanitair producten |  | Float 2 handdoekhouder vrijhangend dubbel 0471130 | alu./mat | 131102 | stuk | 133,00 | 172 | 1 |
| Baden / douchebakken / stoomcabines | | | | | | | | |
| Kranen |  | Melt tafel m. handdoekhouder 0471123 | alu.-mat/ahorn | 141601 | stuk | 365,00 | 172 | 1 |
| Douchegarnituur | | | | | | | | |
| Accessoires en spiegels |  | Big Pill hangkast rond 0471128 | wit/staal | 171001 | stuk | 268,00 | 172 | 1 |
| Douchewanden |  | Think Bank bank inklapbaar 140cm 0471131 | edelstaal/hout | 191401 | stuk | 1334,00 | 172 | 1 |
| Toebehoren & afvoeren | | | | | | | | |
| Spoel- & installatiesystemen |  | Cross Over badplanchet 75cm 0471132 | alu./gestraald | 212101 | stuk | 156,00 | 172 | 1 |
| Badkamermeubelen en toiletkasten |  | Cross Over Set badplanchet 75cm m. spiegel m. boekensteun 0471133 | alu.gestraald | 212102 | stuk | 302,00 | 172 | 1 |
| Gootstenen en wastroggen |  | Cross Over 800 badplanchet 80cm 0471134 | alu./gestraald | 212103 | stuk | 164,00 | 172 | 1 |
| Utiliteit | | | | | | | | |
| | | Cross Over Mirror spiegel voor badplanchet 0471138 | alu./gestraald | 212107 | stuk | 89,50 | 172 | 1 |
| | Dornbracht Universeel | | | | | | | |
| |  | Perfecto sierrozetten voor montagesysteem 0470163 | chrom | 1280197000 | stuk | 27,75 | 172 | 0 |
| |  | Perfecto montagesysteem 1/2" voor 4-gats kraan 0470155 | | 1261097090 | stuk | 555,00 | 172 | 0 |

| Art.nr | Specificaties | Kleur | Lev.nr | Ehd | Prijs | Grp | CC |
|--------|---------------|-------|--------|-----|-------|-----|----|
|--------|---------------|-------|--------|-----|-------|-----|----|

Dornbracht Universeel

inbouwdeel voor inbouwbidetkraan 1/2"

| | | | | | | | |
|---------|--|--|------------|------|--------|-----|---|
| 0433126 | | | 3580997090 | stuk | 168,00 | 172 | 1 |
|---------|--|--|------------|------|--------|-----|---|



Sanitair producten

Baden /
douchebakken /
stoomcabines**hoekstopkraan**

| | | | | | | | |
|---------|--|-------------|------------|------|--------|-----|---|
| 0433100 | | chroom | 2290197900 | stuk | 94,00 | 172 | 1 |
| 0433101 | | platina-mat | 2290197906 | stuk | 141,00 | 172 | 1 |
| 0433113 | | platina | 2290197908 | stuk | 141,00 | 172 | 1 |



Kranen

Douchegarnituur

badthermostaat z. garnituur m. koppelingen

| | | | | | | | |
|---------|--|-------------|------------|------|--------|-----|---|
| 0475050 | | chroom | 3420097900 | stuk | 504,60 | 172 | 1 |
| 0475051 | | platina mat | 3420097906 | stuk | 757,20 | 172 | 1 |

Accessoires en
spiegels**badthermostaat m. garnituur m. koppelingen**

| | | | | | | | |
|---------|--|-------------|------------|------|---------|-----|---|
| 0475048 | | chroom | 3423397900 | stuk | 713,10 | 172 | 1 |
| 0475049 | | platina mat | 3423397906 | stuk | 1069,60 | 172 | 1 |



Douchewanden

Toebehoren &
afvoeren**douchethermostaat HOH=15cm m. rainshower**

| | | | | | | | |
|---------|--|-------------|------------|------|---------|-----|---|
| 0475052 | | chroom | 3445697900 | stuk | 1632,50 | 172 | 1 |
| 0475053 | | platina mat | 3445697906 | stuk | 2448,70 | 172 | 1 |

Spoel- &
installatiesystemenBadkamermeubelen
en toiletkasten**afbouwset voor X-Stream douchekraan**

| | | | | | | | |
|---------|--|-------------|------------|------|--------|-----|---|
| 0475056 | | chroom | 3601562500 | stuk | 199,70 | 172 | 1 |
| 0475057 | | platina mat | 3601562506 | stuk | 269,60 | 172 | 1 |

Gootstenen en
wastroggen**temperatuurgreep**

| | | | | | | | |
|---------|--|-------------|------------|------|--------|-----|---|
| 0472719 | | chroom | 1142022000 | stuk | 141,00 | 172 | 1 |
| 0470344 | | platina-mat | 1142022006 | stuk | 211,00 | 172 | 1 |



Utiliteit

thermostaat voor staande montage z. hendel









| | | | | | | | |
|---------|------------------|-------------|------------|------|---------|-----|---|
| 0472765 | | chroom | 3452597000 | stuk | 1373,00 | 172 | 1 |
| 0471618 | | platina-mat | 3452597006 | stuk | 1681,00 | 172 | 1 |
| 0470588 | schaalgreep | chroom | 1142089000 | stuk | 141,00 | 172 | 0 |
| 0471620 | schaalgreep | platina-mat | 1142089006 | stuk | 211,00 | 172 | 1 |
| 0472719 | temperatuurgreep | chroom | 1142022000 | stuk | 141,00 | 172 | 1 |

**handdouchegarnituur voor 2/3-gats wastafelkraan**

| | | | | | | | |
|---------|--|-------------|------------|------|--------|-----|---|
| 0475289 | | chroom | 2771897000 | stuk | 265,00 | 172 | 1 |
| 0475556 | | platina-mat | 2771897006 | stuk | 397,00 | 172 | 1 |



| | Art.nr | Specificaties | Kleur | Lev.nr | Ehd | Prijs | Grp | CC |
|---|--|---------------|-------------|-------------|------|---------|-----|----|
| | Dornbracht Universeel | | | | | | | |
| | inbouwdeel voor stopkraan koud | | | | | | | |
| Sanitair producten | 0472671 | 1/2" | | 3562197090 | stuk | 62,50 | 172 | 0 |
| | 0472673 | 3/4" | | 3562297090 | stuk | 81,00 | 172 | 0 |
| | 0472675 | 15mm | | 3563197090 | stuk | 62,50 | 172 | 0 |
| | 0472677 | 22mm | | 3563397090 | stuk | 81,00 | 172 | 1 |
| Baden / douchebakken / stoomcabines | | | | | | | | |
| | inbouwdeel voor stopkraan warm | | | | | | | |
| Kranen | 0472672 | 1/2" | | 3567197090 | stuk | 62,50 | 172 | 0 |
| | 0472674 | 3/4" | | 3567297090 | stuk | 81,00 | 172 | 0 |
| | 0472676 | 15mm | | 3568197090 | stuk | 62,50 | 172 | 0 |
| | 0472678 | 22mm | | 3568397090 | stuk | 81,00 | 172 | 1 |
| | stop voor afvoergarnituur | | | | | | | |
| Douchegarnituur | 0471602 | | chroom | 09312002000 | stuk | 22,75 | 172 | 1 |
| | 0471603 | | platina-mat | 09312002006 | stuk | 34,00 | 172 | 1 |
| | bidetsifon 5/4" | | | | | | | |
| Accessoires en spiegels | 0470159 | | chroom | 1005097000 | stuk | 43,50 | 172 | 1 |
| | 0471606 | | platina-mat | 1005097006 | stuk | 217,00 | 172 | 1 |
| | waste m. trekknop | | | | | | | |
| Douchewanden | 0470105 | | chroom | 1020097000 | stuk | 81,50 | 172 | 1 |
| | afbouwdeel pijponderbreker | | | | | | | |
| Toebehoren & afvoeren | 0470615 | | chroom | 3615097000 | stuk | 45,75 | 172 | 1 |
| | 0471624 | | platina-mat | 3615097006 | stuk | 78,00 | 172 | 1 |
| | douchemand voor buismontage | | | | | | | |
| Badkamermeubelen en toiletkasten | 0471651 | | chroom | 8229097000 | stuk | 111,00 | 172 | 1 |
| | 0471652 | | platina-mat | 8229097006 | stuk | 178,00 | 172 | 1 |
| | douchethermostaat z. hendel m. hoofddouche m. koppelingen | | | | | | | |
| Gootstenen en wastroggen | 0474451 | | chroom | 3445597800 | stuk | 1585,00 | 172 | 1 |
| | 0474453 | | platina-mat | 3445597806 | stuk | 2374,00 | 172 | 1 |
| Utiliteit | | | | | | | | |
| | Xtool afbouwdeel inbouwthermostaat z. stopkraan | | | | | | | |
| | 0272603 | | chroom | 3641697900 | stuk | 354,00 | 172 | 1 |
| | 0272604 | | platina-mat | 3641697906 | stuk | 530,00 | 172 | 1 |
| | 0272605 | | platina | 3641697908 | stuk | 530,00 | 172 | 1 |
| | X-tool inbouwmoduul thermostatisch 1-uitlaat | | | | | | | |
| | 0474622 | | | 3543597090 | stuk | 662,00 | 172 | 1 |
| | X-tool inbouwmoduul thermostatisch 3-uitlaten | | | | | | | |
| | 0474606 | | | 3553597090 | stuk | 981,00 | 172 | 1 |

| Art.nr | Specificaties | Kleur | Lev.nr | Ehd | Prijs | Grp | CC | | |
|--|---------------|-------------|------------|------|--------|-----|----|---|--|
| | | | | | | | | Dornbracht Universeel | |
| X-tool inbouwthermostaat z. stopkraan 1/2" 0474630 | | | 3541297090 | stuk | 542,00 | 172 | 1 |  | Sanitair producten |
| X-tool inbouwthermostaat z. stopkraan 3/4" 0474649 | | | 3551297090 | stuk | 712,00 | 172 | 1 | | Baden / douchebakken / stoomcabines |
| 3-weg omstel voor inbouwmontage 0433060 | | chrom | 3510497090 | stuk | 257,00 | 172 | 1 |  | Kranen Douchegarnituur |
| 2-weg omstel voor inbouwmontage 0433059 | | chrom | 3512497090 | stuk | 211,00 | 172 | 0 |  | Accessoires en spiegels Douchewanden |
| inbouwdeel eenhendelkraan rechts voor achterwand (Soho / Vero) 0433129 | | | 3581697090 | stuk | 193,00 | 172 | 1 |  | Toebehoren & afvoeren |
| inbouwset voor 3-gats muurkraan m. bronzen inbouwhuis 0433043 | | | 3570797090 | stuk | 167,00 | 172 | 0 |  | Badkamermeubelen en toiletkasten |
| inbouwset voor 3-gats muurkraan m. 3 bronzen inbouwhuizen 0433044 | | | 3571297090 | stuk | 147,00 | 172 | 0 |  | Gootstenen en wastroggen |
| inbouwdeel bodemplaat compleet 0470571 | | | 3594397090 | stuk | 269,00 | 172 | 1 |  | Utiliteit |
| inbouwdeel voor inbouwdouchekraan 0475537 | | | 3500897090 | stuk | 171,00 | 172 | 0 |  | |
| design afdekplaat 0272612 | | chrom | 1266097900 | stuk | 425,00 | 172 | 1 | | |
| 0272613 | | platina-mat | 1266097906 | stuk | 638,00 | 172 | 1 | | |

| | Art.nr | Specificaties | Kleur | Lev.nr | Ehd | Prijs | Grp | CC |
|---|---------------------------------|---------------------------------------|-------------|---------------|------|--------|-----|----|
| | Dornbracht Universeel | | | | | | | |
| | verlengset 50mm | | | | | | | |
| Sanitair producten | 0272616 | | chrom | 1207197000 | stuk | 128,00 | 172 | 1 |
| | 0272617 | | platina-mat | 1207197006 | stuk | 172,00 | 172 | 1 |
| | 0272618 | | messing | 1207197009 | stuk | 172,00 | 172 | 1 |
| | Xstream verlengset 20mm | | | | | | | |
| Baden / douchebakken / stoomcabines | 0272619 | | | 1207297090 | stuk | 130,00 | 172 | 1 |
| | 0272620 | | | 1207397090 | stuk | 149,00 | 172 | 1 |
| | spindel verlengstuk 28mm | | | | | | | |
| | 0272621 | | | 1217797090 | stuk | 30,50 | 172 | 1 |
| Kranen | spindel verlengstuk 46mm | | | | | | | |
| | 0272622 | | | 1217897090 | stuk | 30,50 | 172 | 1 |
| | Dornbracht Onderdelen | | | | | | | |
| Douchegarnituur | 0472832 | cartouche voor 1-greeps kranen | | 9015050100090 | stuk | 52,50 | 172 | 0 |
| | 0470177 | kenplaatje cold | | 09260101090 | stuk | 8,60 | 172 | 1 |
| | 0470187 | kenplaatje warm | | 09260101190 | stuk | 8,60 | 172 | 1 |
| Accessoires en spiegels | 0472573 | klemstuk voor keramisch binnenwerk | | 09121200290 | stuk | 2,60 | 172 | 1 |
| | 0472786 | toevoerbuis voor wastafel/bidet koper | | 0424020460100 | stuk | 23,50 | 172 | 1 |
| | 0472803 | keramisch binnenwerk 1/2" links | | 0490031420090 | stuk | 39,25 | 172 | 1 |
| | 0472805 | keramisch binnenwerk 1/2" rechts | | 0490031430090 | stuk | 39,25 | 172 | 1 |
| Douchewanden | 0472807 | cartouche voor eengreepskraan | | 9015050300090 | stuk | 52,50 | 172 | 1 |
| | 0470060 | douchegordijn gestreept zwart/wit | | 846519706531 | stuk | 458,00 | 172 | 1 |
| | 0470050 | douchegordijn lichtgrijs | | 8465197065 | stuk | 458,00 | 172 | 1 |
| Toebehoren & afvoeren | | | | | | | | |
| Spoel- & installatiesystemen | | | | | | | | |
| Badkamermeubelen en toiletkasten | | | | | | | | |
| Gootstenen en wastroggen | | | | | | | | |
| Utiliteit | | | | | | | | |

| Art.nr | Specificaties | Kleur | Lev.nr | Ehd | Prijs | Grp | CC |
|--|---------------|------------|------------|------|--------|-----|----|
| Fantini Copernico | | | | | | | |
| wastafelkraan m. waste 0740020 | | chroom | 57021104F | stuk | 400,00 | 369 | 1 |
| badkraan m. garnituur 0740023 | | chroom | 57021115 | stuk | 570,00 | 369 | 1 |
| Fantini Stilo-Sfera | | | | | | | |
| wastafelkraan m. waste z. greep 0740193 | | chroom | 70021204SF | stuk | 255,00 | 369 | 1 |
| badkraan m. garnituur z. greep 0740197 | | chroom | 70021215S | stuk | 450,00 | 369 | 1 |
| inbouwdouchekraan z. omstel z. greep 0740195 | | chroom | 70021263S | stuk | 175,00 | 369 | 1 |
| inbouwbadkraan m. omstel z. greep 0744026 | | chroom | 70021222S | stuk | 270,00 | 369 | 1 |
| Sfera greep voor 1204 - 1215 0740320 | | chroom/ice | 70C12148 | stuk | 45,00 | 369 | 1 |
| Stilo greep voor 1204 - 1215 0740191 | | chroom | 70022248 | stuk | 45,00 | 369 | 1 |
| Sfera greep voor 1263 - 1222 0740310 | | chroom/ice | 70C12149 | stuk | 45,00 | 369 | 1 |
| Stilo greep voor 1222 - 1263 0740111 | | chroom | 70022249 | stuk | 45,00 | 369 | 1 |



Sanitair producten

Baden /
douchebakken /
stoomcabines

Kranen

Douchegarnituur

Accessoires en
spiegels

Douchewanden

Toebehoren &
afvoerenSpoel- &
installatiesystemenBadkamermeubelen
en toiletkastenGootstenen en
wastroggen







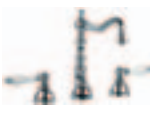

Utiliteit

RettangoloXL

GESSIG

 **PLIEGER**

Plieger BV Zaltbommel NL 0418 - 682 682/www.plieger.nl

| Art.nr | Specificaties | Kleur | Lev.nr | Ehd | Prijs | Grp | CC | | |
|--|---------------|--------|----------|------|--------|-----|----|---|---|
| | | | | | | | | Gessi la Dolce Vita Mito | |
| toiletkraan 0463116 | | chroom | 8717031 | stuk | 126,00 | 169 | 1 |  | Sanitair producten |
| 3-gats wastafelkraan m. waste 0463051 | | chroom | 8600031 | stuk | 367,00 | 169 | 1 |  | Baden / douchebakken / stoomcabines |
| 3-gats bidetkraan m. waste 0464252 | | chroom | 8603031 | stuk | 364,00 | 169 | 1 |  | Kranen |
| badkraan m. koppelingen m. omstel m. telefoonhaak m. handdouche m. slang 150cm 0463078 | | chroom | 8615031 | stuk | 477,00 | 169 | 1 |  | Douchegarnituur |
| 4-gats badrandcombinatie m. omstel m. uitloop m. uittrekbare handdouche 0463086 | | chroom | 8651031 | stuk | 538,00 | 169 | 1 |  | Accessoires en spiegels |
| douchekraan z. omstel 0463108 | | chroom | 8660031 | stuk | 242,00 | 169 | 1 |  | Douchewanden |
| | | | | | | | | Gessi Eclix | |
| 1-gats wastafelkraan m. waste 0467359 | | chroom | 17501031 | stuk | 237,00 | 169 | 0 |  | Badkamermeubelen en toiletkasten |
| 0460445 | | inox | 17501142 | stuk | 322,00 | 169 | 1 | | |
| 1-gats wastafelkraan verhoogd m. waste 0467367 | | chroom | 11913031 | stuk | 274,00 | 169 | 1 |  | Gootstenen en wastroggen |
| 0460446 | | inox | 11913142 | stuk | 373,00 | 169 | 1 | | |
| 1-gats bidetkraan m. waste 0467375 | | chroom | 17507031 | stuk | 237,00 | 169 | 1 |  | Utiliteit |
| 0460447 | | inox | 17507142 | stuk | 322,00 | 169 | 1 | | |

| Art.nr | Specificaties | Kleur | Lev.nr | Ehd | Prijs | Grp | CC |
|--------|---------------|-------|--------|-----|-------|-----|----|
|--------|---------------|-------|--------|-----|-------|-----|----|

Gessi Eclix

inbouwwandkraan compleet; inbouwdeel + afbouwdeel

| | | | | | | | |
|---------|----------------|-------|----------|------|--------|-----|---|
| 0467383 | uitloop 16.5cm | chrom | 17585031 | stuk | 396,00 | 169 | 1 |
| 0460448 | uitloop 16.5cm | inox | 17585142 | stuk | 534,00 | 169 | 1 |
| 0467405 | uitloop 23cm | chrom | 17591031 | stuk | 413,00 | 169 | 1 |
| 0460449 | uitloop 23cm | inox | 17591142 | stuk | 557,00 | 169 | 1 |



Sanitair producten

Baden /
douchebakken /
stoomcabines

Kranen

Douchegarnituur



uitloop

| | | | | | | | | |
|---------|--------|-----------------|-------|----------|------|--------|-----|---|
| 0463469 | 16.5cm | m. schroefdraad | chrom | 13300031 | stuk | 95,00 | 169 | 0 |
| 0463061 | 16.5cm | m. schroefdraad | inox | 13300142 | stuk | 137,00 | 169 | 1 |
| 0463477 | 23cm | m. schroefdraad | chrom | 13303031 | stuk | 119,00 | 169 | 0 |
| 0463062 | 23cm | m. schroefdraad | inox | 13303142 | stuk | 161,00 | 169 | 1 |

Accessoires en
spiegels



inbouwwastafelkraan z. uitloop compleet; inbouwdeel + afbouwdeel

| | | | | | | | | |
|---------|--|--|-------|----------|------|--------|-----|---|
| 0467464 | | | chrom | 17606031 | stuk | 178,00 | 169 | 0 |
| 0460450 | | | inox | 17606142 | stuk | 242,00 | 169 | 1 |

Douchewanden

Toebehoren &
afvoeren



badkraan m. omstel z. garnituur m. koppelingen

| | | | | | | | | |
|---------|--|--|-------|----------|------|--------|-----|---|
| 0467499 | | | chrom | 17513031 | stuk | 312,00 | 169 | 1 |
| 0460451 | | | inox | 17513142 | stuk | 424,00 | 169 | 1 |

Spoel- &
installatiesystemen



Badkamermeubelen
en toiletkasten

Gootstenen en
wastroggen



badkraan m. omstel m. slang m. handdouche m. koppelingen

| | | | | | | | |
|---------|-----------------------|-------|----------|------|--------|-----|---|
| 0467502 | m. vaste houder | chrom | 17519031 | stuk | 384,00 | 169 | 0 |
| 0460452 | m. vaste houder | inox | 17519142 | stuk | 513,00 | 169 | 1 |
| 0467510 | m. verstelbare houder | chrom | 17525031 | stuk | 403,00 | 169 | 1 |

Utiliteit

badthermostaat m. omstel z. garnituur m. koppelingen

| | | | | | | | | |
|---------|--|--|-------|----------|------|--------|-----|---|
| 0463139 | | | chrom | 19581031 | stuk | 427,00 | 169 | 1 |
| 0460454 | | | inox | 19581142 | stuk | 576,00 | 169 | 1 |



badthermostaat m. omstel m. slang m. handdouche m. koppelingen

| | | | | | | | |
|---------|---------------------------|-------|----------|------|--------|-----|---|
| 0463141 | m. vaste wandhouder | chrom | 19583031 | stuk | 497,00 | 169 | 1 |
| 0460455 | m. vaste wandhouder | inox | 19583142 | stuk | 726,00 | 169 | 1 |
| 0463142 | m. verstelbare wandhouder | chrom | 19585031 | stuk | 517,00 | 169 | 1 |
| 0460456 | m. verstelbare wandhouder | inox | 19585142 | stuk | 753,00 | 169 | 1 |



| Art.nr | Specificaties | Kleur | Lev.nr | Ehd | Prijs | Grp | CC |
|--------|---------------|-------|--------|-----|-------|-----|----|
|--------|---------------|-------|--------|-----|-------|-----|----|

Gessi Eclix

3-gats badrandcombinatie m. uitloop m. slang 150cm m. handdouche

| | | | | | | | |
|---------|--|--------|----------|------|--------|-----|---|
| 0467529 | | chroom | 17537031 | stuk | 447,00 | 169 | 0 |
| 0460457 | | inox | 17537142 | stuk | 604,00 | 169 | 1 |



Sanitair producten

Baden /
douchebakken /
stoomcabines**3-gats badkraan voor badvulcombinatie z. uitloop m. slang 150cm m. handdouche**

| | | | | | | | |
|---------|--|--------|----------|------|--------|-----|---|
| 0467537 | | chroom | 17543031 | stuk | 387,00 | 169 | 1 |
| 0460458 | | inox | 17543142 | stuk | 525,00 | 169 | 1 |



Kranen

Doucheapparatuur

douchekraan z. omstel m. koppelingen

| | | | | | | | |
|---------|--|--------|----------|------|--------|-----|---|
| 0467634 | | chroom | 17531031 | stuk | 259,00 | 169 | 1 |
| 0460461 | | inox | 17531142 | stuk | 352,00 | 169 | 1 |

Accessoires en
spiegels**douchethermostaat z. omstel m. koppelingen**

| | | | | | | | |
|---------|--|--------|----------|------|--------|-----|---|
| 0463113 | | chroom | 19451031 | stuk | 352,00 | 169 | 0 |
|---------|--|--------|----------|------|--------|-----|---|



Douchewanden

Toebehoren &
afvoeren**inbouwdouchekraan 1/2" z. omstel compleet; inbouw + afbouwdeel**

| | | | | | | | |
|---------|--|--------|----------|------|--------|-----|---|
| 0467642 | | chroom | 17549031 | stuk | 288,00 | 169 | 1 |
| 0460463 | | inox | 17549142 | stuk | 388,00 | 169 | 1 |

Spoel- &
installatiesystemenBadkamermeubelen
en toiletkasten**inbouwbadkraan 1/2" m. omstel compleet; inbouw + afbouwdeel**

| | | | | | | | |
|---------|--|--------|----------|------|--------|-----|---|
| 0467677 | | chroom | 17567031 | stuk | 325,00 | 169 | 1 |
| 0460464 | | inox | 17567142 | stuk | 439,00 | 169 | 1 |

Gootstenen en
wastroggen**inbouwdouchethermostaat z. omstel m. stopkraan 1/2" compleet**

| | | | | | | | |
|---------|---------------------|--------|----------|------|--------|-----|---|
| 0462683 | inbouw + afbouwdeel | chroom | 13331031 | stuk | 494,00 | 169 | 0 |
|---------|---------------------|--------|----------|------|--------|-----|---|



Utiliteit

inbouwbadthermostaat m. omstel m. stopkraan 1/2" compleet

| | | | | | | | |
|---------|---------------------|--------|----------|------|--------|-----|---|
| 0462691 | inbouw + afbouwdeel | chroom | 13333031 | stuk | 549,00 | 169 | 0 |
|---------|---------------------|--------|----------|------|--------|-----|---|

**inbouwbadthermostaat m. 3-weg omstel m. stopkraan 1/2" compleet**

| | | | | | | | |
|---------|---------------------|--------|----------|------|--------|-----|---|
| 0462705 | inbouw + afbouwdeel | chroom | 13335031 | stuk | 578,00 | 169 | 1 |
|---------|---------------------|--------|----------|------|--------|-----|---|



| Art.nr | Specificaties | Kleur | Lev.nr | Ehd | Prijs | Grp | CC |
|--------|---------------|-------|--------|-----|-------|-----|----|
|--------|---------------|-------|--------|-----|-------|-----|----|

Gessi Eclix

wanduitloop voor inbouwdeel 13297

| | | | | | | | |
|---------|----------------|--------|----------|------|--------|-----|---|
| 0462330 | 165mm m. inbus | chroom | 13304031 | stuk | 95,00 | 169 | 0 |
| 0463884 | 165mm m. inbus | inox | 13304142 | stuk | 137,00 | 169 | 1 |



Sanitair producten

Baden /
douchebakken /
stoomcabines

wanduitloop voor bad

| | | | | | | | |
|---------|------|--------|----------|------|--------|-----|---|
| 0462349 | 23cm | chroom | 13315031 | stuk | 119,00 | 169 | 0 |
| 0463081 | 23cm | inox | 13315142 | stuk | 161,00 | 169 | 1 |

Kranen

inbouwstopkraan 1/2" compleet; inbouw + afbouwdeel

| | | | | | | | |
|---------|--|--------|----------|------|--------|-----|---|
| 0462772 | | chroom | 12903031 | stuk | 106,00 | 169 | 0 |
|---------|--|--------|----------|------|--------|-----|---|



Douchegarnituur

Accessoires en
spiegels

Gessi Font

1-gats wastafelkraan m. waste

| | | | | | | | |
|---------|--|--------|----------|------|--------|-----|---|
| 0462187 | | chroom | 14201031 | stuk | 263,00 | 169 | 0 |
| 0460123 | | inox | 14201142 | stuk | 357,00 | 169 | 1 |



Douchewanden

Toebehoren &
afvoeren

1-gats bidetkraan m. waste

| | | | | | | | |
|---------|--|--------|----------|------|--------|-----|---|
| 0462276 | | chroom | 14207031 | stuk | 263,00 | 169 | 1 |
| 0460474 | | inox | 14207142 | stuk | 357,00 | 169 | 1 |



Spoel- &
installatiesystemen

1-gats wastafelkraan verhoogde draaibare uitloop voorsprong 11cm m. waste

| | | | | | | | |
|---------|--|--------|----------|------|--------|-----|---|
| 0462195 | | chroom | 14202031 | stuk | 302,00 | 169 | 0 |
| 0460475 | | inox | 14202142 | stuk | 411,00 | 169 | 1 |



Badkamermeubelen
en toiletkasten

Gootstenen en
wastroggen

1-gats wastafelkraan verhoogde draaibare uitloop voorsprong 19cm m. waste

| | | | | | | | |
|---------|--|--------|----------|------|--------|-----|---|
| 0462209 | | chroom | 14210031 | stuk | 302,00 | 169 | 1 |
| 0460476 | | inox | 14210142 | stuk | 411,00 | 169 | 1 |



Utiliteit

wastafelkraan vrijstaand hoogte 1meter

| | | | | | | | |
|---------|--|--------|----------|------|---------|-----|---|
| 0464414 | | chroom | 14211031 | stuk | 794,00 | 169 | 1 |
| 0464422 | | inox | 14211142 | stuk | 1079,00 | 169 | 1 |



1-gats wastafelkraan joystick m. waste

| | | | | | | | |
|---------|--|--------|----------|------|--------|-----|---|
| 0462217 | | chroom | 14203031 | stuk | 287,00 | 169 | 0 |
| 0460477 | | inox | 14203142 | stuk | 390,00 | 169 | 1 |



| Art.nr | Specificaties | Kleur | Lev.nr | Ehd | Prijs | Grp | CC |
|--------|---------------|-------|--------|-----|-------|-----|----|
|--------|---------------|-------|--------|-----|-------|-----|----|

Gessi Font

1-gats wastafelkraan joystick verhoogd m. waste

| | | | | | | | |
|---------|--|--------|----------|------|--------|-----|---|
| 0462225 | | chroom | 14204031 | stuk | 314,00 | 169 | 1 |
| 0460478 | | inox | 14204142 | stuk | 427,00 | 169 | 1 |



Sanitair producten

Baden /
douchebakken /
stoomcabines**wandkraan joystick z. waste compleet; inbouwdeel + afbouwdeel**

| | | | | | | | |
|---------|--|--------|----------|------|--------|-----|---|
| 0462233 | | chroom | 14206031 | stuk | 401,00 | 169 | 1 |
| 0460479 | | inox | 14206142 | stuk | 513,00 | 169 | 1 |



Kranen

Douchegarnituur

afbouwdeel v. wandkraan joystick z. waste

| | | | | | | | |
|---------|--|--------|----------|------|--------|-----|---|
| 0460480 | | chroom | 14298031 | stuk | 312,00 | 169 | 1 |
| 0460481 | | inox | 14298142 | stuk | 424,00 | 169 | 1 |

Accessoires en
spiegels**2-gats inbouwwandkraan compleet; inbouwdeel + afbouwdeel**

| | | | | | | | |
|---------|----------------|--------|----------|------|--------|-----|---|
| 0462241 | uitloop 16.5cm | chroom | 14285031 | stuk | 396,00 | 169 | 0 |
| 0460131 | uitloop 16.5cm | inox | 14285142 | stuk | 534,00 | 169 | 1 |



Douchewanden

Toebehoren &
afvoeren**afbouwdeel v. 2-gats inbouw wandkraan m. uitloop 16.5cm**

| | | | | | | | |
|---------|--|--------|----------|------|--------|-----|---|
| 0460482 | | chroom | 14288031 | stuk | 265,00 | 169 | 1 |
| 0460483 | | inox | 14288142 | stuk | 403,00 | 169 | 1 |

Spoel- &
installatiesystemenBadkamermeubelen
en toiletkasten**2-gats inbouwwandkraan compleet; inbouwdeel + afbouwdeel**

| | | | | | | | |
|---------|--------------|--------|----------|------|--------|-----|---|
| 0462268 | uitloop 23cm | chroom | 14291031 | stuk | 413,00 | 169 | 0 |
| 0460132 | uitloop 23cm | inox | 14291142 | stuk | 557,00 | 169 | 1 |

Gootstenen en
wastroggen**afbouwdeel v. 2-gats inbouw wandkraan m. uitloop 23cm**

| | | | | | | | |
|---------|--|--------|----------|------|--------|-----|---|
| 0460484 | | chroom | 14294031 | stuk | 282,00 | 169 | 1 |
| 0460485 | | inox | 14294142 | stuk | 426,00 | 169 | 1 |



Utiliteit

uitloop

| | | | | | | | | |
|---------|--------|-----------------|--------|----------|------|--------|-----|---|
| 0463469 | 16.5cm | m. schroefdraad | chroom | 13300031 | stuk | 95,00 | 169 | 0 |
| 0463061 | 16.5cm | m. schroefdraad | inox | 13300142 | stuk | 137,00 | 169 | 1 |
| 0463477 | 23cm | m. schroefdraad | chroom | 13303031 | stuk | 119,00 | 169 | 0 |
| 0463062 | 23cm | m. schroefdraad | inox | 13303142 | stuk | 161,00 | 169 | 1 |

**inbouwwastafelkraan z. uitloop compleet; inbouwdeel + afbouwdeel**

| | | | | | | | |
|---------|--|--------|----------|------|--------|-----|---|
| 0463590 | | chroom | 14306031 | stuk | 178,00 | 169 | 0 |
| 0460486 | | inox | 14306142 | stuk | 242,00 | 169 | 1 |



| | Art.nr | Specificaties | Kleur | Lev.nr | Ehd | Prijs | Grp | CC |
|---|--|---------------|-------|----------|------|--------|-----|----|
| | Gessi Font | | | | | | | |
| | afbouwdeel v. inbouwvastafelkraan z. uitloop | | | | | | | |
| Sanitair producten | 0460488 | | chrom | 14312031 | stuk | 87,00 | 169 | 1 |
| | 0460489 | | inox | 14312142 | stuk | 151,00 | 169 | 1 |
| Baden / douchebakken / stoomcabines |  | | | | | | | |
| | badkraan m. omstel z. garnituur | | | | | | | |
| Kranen | 0463604 | | chrom | 14213031 | stuk | 324,00 | 169 | 1 |
| | 0460490 | | inox | 14213142 | stuk | 437,00 | 169 | 1 |
| Douchegarnituur |  | | | | | | | |
| | badkraan m. omstel m. slang m. handdouche m. wandhouder | | | | | | | |
| Accessoires en spiegels | 0462381 | | chrom | 14219031 | stuk | 386,00 | 169 | 0 |
| | 0460491 | | inox | 14219142 | stuk | 521,00 | 169 | 1 |
| Douchewanden |  | | | | | | | |
| | badkraan m. omstel m. slang m. handdouche m. verstelbare wandhouder | | | | | | | |
| Toebehoren & afvoeren | 0460492 | | chrom | 14225031 | stuk | 398,00 | 169 | 1 |
| |  | | | | | | | |
| | badthermostaat m. omstel z. garnituur | | | | | | | |
| Spoel- & installatiesystemen | 0463119 | | chrom | 19441031 | stuk | 427,00 | 169 | 1 |
| Badkamermeubelen en toiletkasten |  | | | | | | | |
| | badkraan m. omstel m. slang m. handdouche m. verstelbare wandhouder | | | | | | | |
| Gootstenen en wastroggen | 0460493 | | inox | 14225142 | stuk | 537,00 | 169 | 1 |
| |  | | | | | | | |
| Utiliteit | badthermostaat m. omstel m. slang 150cm m. handdouche m. wandhouder | | | | | | | |
| | 0463137 | | chrom | 19443031 | stuk | 491,00 | 169 | 1 |
| |  | | | | | | | |
| | badthermostaat m. omstel m. slang 150cm m. handdouche m. verstelbare wandhouder | | | | | | | |
| | 0463138 | | chrom | 19445031 | stuk | 511,00 | 169 | 1 |
| |  | | | | | | | |
| | douchekraan z. omstel | | | | | | | |
| | 0462292 | | chrom | 14231031 | stuk | 299,00 | 169 | 0 |
| | 0460497 | | inox | 14231142 | stuk | 407,00 | 169 | 1 |
| |  | | | | | | | |

| Art.nr | Specificaties | Kleur | Lev.nr | Ehd | Prijs | Grp | CC |
|--------|---------------|-------|--------|-----|-------|-----|----|
|--------|---------------|-------|--------|-----|-------|-----|----|

Gessi Font

3-gats badrandcombinatie m. uitloop m. slang 150cm m. handdouche

| | | | | | | | |
|---------|--|--------|----------|------|--------|-----|---|
| 0462403 | | chroom | 14237031 | stuk | 472,00 | 169 | 0 |
|---------|--|--------|----------|------|--------|-----|---|



Sanitair producten

Baden /
douchebakken /
stoomcabines**douchethermostaat z. omstel m. koppelingen**

| | | | | | | | |
|---------|--|--------|----------|------|--------|-----|---|
| 0463113 | | chroom | 19451031 | stuk | 352,00 | 169 | 0 |
|---------|--|--------|----------|------|--------|-----|---|



Kranen

Douchegarnituur

3-gats badrandcombinatie m. uitloop m. slang 150cm m. handdouche

| | | | | | | | |
|---------|--|------|----------|------|--------|-----|---|
| 0460499 | | inox | 14237142 | stuk | 637,00 | 169 | 1 |
|---------|--|------|----------|------|--------|-----|---|

Accessoires en
spiegels**3-gats badkraan voor badvulcombinatie z. uitloop m. slang 150cm m. handdouche**

| | | | | | | | |
|---------|--|--------|----------|------|--------|-----|---|
| 0463612 | | chroom | 14243031 | stuk | 417,00 | 169 | 1 |
|---------|--|--------|----------|------|--------|-----|---|

| | | | | | | | |
|---------|--|------|----------|------|--------|-----|---|
| 0460500 | | inox | 14243142 | stuk | 563,00 | 169 | 1 |
|---------|--|------|----------|------|--------|-----|---|



Douchewanden

Toebehoren &
afvoeren**1-weg inbouwdouchekraan 1/2" cartouche=Ø35mm compleet; inbouw + afbouwdeel**

| | | | | | | | |
|---------|--|--------|----------|------|--------|-----|---|
| 0462306 | | chroom | 14249031 | stuk | 288,00 | 169 | 1 |
|---------|--|--------|----------|------|--------|-----|---|

| | | | | | | | |
|---------|--|------|----------|------|--------|-----|---|
| 0460133 | | inox | 14249142 | stuk | 388,00 | 169 | 1 |
|---------|--|------|----------|------|--------|-----|---|

Spoel- &
installatiesystemenBadkamermeubelen
en toiletkasten**afbouwdeel v. 1-weg inbouwdouchekraan 1/2"**

| | | | | | | | |
|---------|--|--------|----------|------|--------|-----|---|
| 0460501 | | chroom | 14261031 | stuk | 197,00 | 169 | 1 |
|---------|--|--------|----------|------|--------|-----|---|

| | | | | | | | |
|---------|--|------|----------|------|--------|-----|---|
| 0460502 | | inox | 14261142 | stuk | 297,00 | 169 | 1 |
|---------|--|------|----------|------|--------|-----|---|

Gootstenen en
wastroggen

Utiliteit

inbouwbadkraan 1/2" cartouche=Ø35mm m. omstel compleet; inbouw + afbouwdeel

| | | | | | | | |
|---------|--|--------|----------|------|--------|-----|---|
| 0462322 | | chroom | 14267031 | stuk | 325,00 | 169 | 1 |
|---------|--|--------|----------|------|--------|-----|---|

**afbouwdeel v. inbouwbadkraan 1/2" m. omstel**







| | | | | | | | |
|---------|--|--------|----------|------|--------|-----|---|
| 0460503 | | chroom | 14279031 | stuk | 208,00 | 169 | 1 |
|---------|--|--------|----------|------|--------|-----|---|

| | | | | | | | |
|---------|--|------|----------|------|--------|-----|---|
| 0460504 | | inox | 14279142 | stuk | 322,00 | 169 | 1 |
|---------|--|------|----------|------|--------|-----|---|

**inbouwdouchethermostaat z. omstel m. stopkraan 1/2" compleet**

| | | | | | | | |
|---------|---------------------|--------|----------|------|--------|-----|---|
| 0462683 | inbouw + afbouwdeel | chroom | 13331031 | stuk | 494,00 | 169 | 0 |
|---------|---------------------|--------|----------|------|--------|-----|---|



| | Art.nr | Specificaties | Kleur | Lev.nr | Ehd | Prijs | Grp | CC | |
|---|---|--|----------------|----------|----------|---------|--------|-----|---|
| | Gessi Font | | | | | | | | |
| Sanitair producten | | inbouwbadthermostaat m. omstel m. stopkraan 1/2" compleet | | | | | | | |
| | 0462691 | inbouw + afbouwdeel | chroom | 13333031 | stuk | 549,00 | 169 | 0 | |
| Baden / douchebakken / stoomcabines |  | | | | | | | | |
| Kranen | | inbouwbadthermostaat m. 3-weg omstel m. stopkraan 1/2" compleet | | | | | | | |
| | 0462705 | inbouw + afbouwdeel | chroom | 13335031 | stuk | 578,00 | 169 | 1 | |
| Douchegarnituur |  | | | | | | | | |
| | wanduitloop voor inbouwdeel 13297 | | | | | | | | |
| | 0462330 | 165mm m. inbus | chroom | 13304031 | stuk | 95,00 | 169 | 0 | |
| Accessoires en spiegels |  | 0463884 | 165mm m. inbus | inox | 13304142 | stuk | 137,00 | 169 | 1 |
| Douchewanden | | wanduitloop voor bad | | | | | | | |
| | 0462349 | 23cm | chroom | 13315031 | stuk | 119,00 | 169 | 0 | |
| | 0463081 | 23cm | inox | 13315142 | stuk | 161,00 | 169 | 1 | |
| Toebehoren & afvoeren | | inbouwstopkraan 1/2" compleet; inbouw + afbouwdeel | | | | | | | |
| | 0462772 | | chroom | 12903031 | stuk | 106,00 | 169 | 0 | |
| Spoel- & installatiesystemen |  | | | | | | | | |
| Badkamermeubelen en toiletkasten | | hendel los | | | | | | | |
| | 0462373 | | chroom | 14399031 | stuk | 23,75 | 169 | 1 | |
| Gootstenen en wastroggen |  | | | | | | | | |
| | Gessi Font5 | | | | | | | | |
| | 1-gats wastafelkraan m. waste | | | | | | | | |
| | 0462845 | | chroom | 14701031 | stuk | 263,00 | 169 | 1 | |
| Utiliteit |  | 0460612 | | inox | 14701142 | stuk | 357,00 | 169 | 1 |
| | | 1-gats wastafelkraan verhoogd draaibaar uitloop=110mm m. waste | | | | | | | |
| | 0462853 | | chroom | 14702031 | stuk | 302,00 | 169 | 1 | |
| | 0460134 | | inox | 14702142 | stuk | 411,00 | 169 | 1 | |
| |  | | | | | | | | |
| | 1-gats wastafelkraan verhoogd draaibaar uitloop=190mm m. waste | | | | | | | | |
| | 0460613 | | chroom | 14710031 | stuk | 302,00 | 169 | 1 | |
| | 0460614 | | inox | 14710142 | stuk | 411,00 | 169 | 1 | |
| | wastafelkraan vrijstaand hoog 1m | | | | | | | | |
| | 0460615 | | chroom | 14711031 | stuk | 794,00 | 169 | 1 | |
| | 0460616 | | inox | 14711142 | stuk | 1079,00 | 169 | 1 | |

| Art.nr | Specificaties | Kleur | Lev.nr | Ehd | Prijs | Grp | CC |
|--------|---------------|-------|--------|-----|-------|-----|----|
|--------|---------------|-------|--------|-----|-------|-----|----|

Gessi Font5

1-gats bidetkraan m. waste

| | | | | | | | |
|---------|--|--------|----------|------|--------|-----|---|
| 0462934 | | chroom | 14707031 | stuk | 263,00 | 169 | 1 |
| 0460128 | | inox | 14707142 | stuk | 357,00 | 169 | 1 |



Sanitair producten

Baden /
douchebakken /
stoomcabines**1-gats wastafelkraan joystick m. waste**

| | | | | | | | |
|---------|--|--------|----------|------|--------|-----|---|
| 0462861 | | chroom | 14703031 | stuk | 287,00 | 169 | 1 |
| 0460135 | | inox | 14703142 | stuk | 390,00 | 169 | 1 |



Kranen

Douchegarnituur

1-gats wastafelkraan joystick verhoogd m. waste

| | | | | | | | |
|---------|--|--------|----------|------|--------|-----|---|
| 0462888 | | chroom | 14704031 | stuk | 314,00 | 169 | 1 |
| 0460126 | | inox | 14704142 | stuk | 427,00 | 169 | 1 |

Accessoires en
spiegels**wandkraan joystick z. waste compleet; inbouwdeel + afbouwdeel**

| | | | | | | | |
|---------|--|--------|----------|------|--------|-----|---|
| 0462896 | | chroom | 14706031 | stuk | 401,00 | 169 | 1 |
| 0460136 | | inox | 14706142 | stuk | 513,00 | 169 | 1 |



Douchewanden

Toebehoren &
afvoeren**afbouwdeel v. wandkraan joystick z. waste**

| | | | | | | | |
|---------|--|--------|----------|------|--------|-----|---|
| 0460617 | | chroom | 14798031 | stuk | 312,00 | 169 | 1 |
| 0460618 | | inox | 14798142 | stuk | 424,00 | 169 | 1 |

2-gats inbouwwandkraan compleet; inbouwdeel + afbouwdeel

| | | | | | | | |
|---------|----------------|--------|----------|------|--------|-----|---|
| 0462241 | uitloop 16.5cm | chroom | 14285031 | stuk | 396,00 | 169 | 0 |
| 0460131 | uitloop 16.5cm | inox | 14285142 | stuk | 534,00 | 169 | 1 |
| 0462268 | uitloop 23cm | chroom | 14291031 | stuk | 413,00 | 169 | 0 |
| 0460132 | uitloop 23cm | inox | 14291142 | stuk | 557,00 | 169 | 1 |

Badkamermeubelen
en toiletkastenGootstenen en
wastroggen

Utiliteit

uitloop

| | | | | | | | | |
|---------|--------|-----------------|--------|----------|------|--------|-----|---|
| 0463469 | 16.5cm | m. schroefdraad | chroom | 13300031 | stuk | 95,00 | 169 | 0 |
| 0463061 | 16.5cm | m. schroefdraad | inox | 13300142 | stuk | 137,00 | 169 | 1 |
| 0463477 | 23cm | m. schroefdraad | chroom | 13303031 | stuk | 119,00 | 169 | 0 |
| 0463062 | 23cm | m. schroefdraad | inox | 13303142 | stuk | 161,00 | 169 | 1 |

**inbouwwastafelkraan z. uitloop compleet; inbouwdeel + afbouwdeel**

| | | | | | | | |
|---------|----------------------------------|--------|----------|------|--------|-----|---|
| 0463590 | | chroom | 14306031 | stuk | 178,00 | 169 | 0 |
| 0467928 | afdekplaat rond voor inbouwkraan | chroom | 13398031 | stuk | 33,00 | 169 | 0 |

**afdekplaat rond voor inbouwkraan**

| | | | | | | | |
|---------|--|--------|----------|------|-------|-----|---|
| 0467928 | | chroom | 13398031 | stuk | 33,00 | 169 | 0 |
| 0460487 | | inox | 13398142 | stuk | 46,50 | 169 | 1 |



| Art.nr | Specificaties | Kleur | Lev.nr | Ehd | Prijs | Grp | CC |
|--------|---------------|-------|--------|-----|-------|-----|----|
|--------|---------------|-------|--------|-----|-------|-----|----|

Gessi Font5

badkraan joystick m. omstel m. slang 150cm m. handdouche m. vaste wandhouder

| | | | | | | | |
|---------|--|-------|----------|------|--------|-----|---|
| 0462942 | | chrom | 14719031 | stuk | 386,00 | 169 | 1 |
| 0460129 | | inox | 14719142 | stuk | 521,00 | 169 | 1 |

badkraan joystick m. omstel m. slang 150cm m. handdouche

| | | | | | | | |
|---------|---------------------------|-------|----------|------|--------|-----|---|
| 0460620 | m. verstelbare wandhouder | chrom | 14725031 | stuk | 398,00 | 169 | 1 |
| 0460621 | m. verstelbare wandhouder | inox | 14725142 | stuk | 537,00 | 169 | 1 |

badthermostaat m. omstel z. garnituur

| | | | | | | | |
|---------|--|-------|----------|------|--------|-----|---|
| 0463119 | | chrom | 19441031 | stuk | 427,00 | 169 | 1 |
|---------|--|-------|----------|------|--------|-----|---|



badthermostaat m. omstel m. slang 150cm m. handdouche m. wandhouder

| | | | | | | | |
|---------|--|-------|----------|------|--------|-----|---|
| 0463137 | | chrom | 19443031 | stuk | 491,00 | 169 | 1 |
|---------|--|-------|----------|------|--------|-----|---|



badthermostaat m. omstel m. slang 150cm m. handdouche

| | | | | | | | |
|---------|---------------------------|-------|----------|------|--------|-----|---|
| 0463138 | m. verstelbare wandhouder | chrom | 19445031 | stuk | 511,00 | 169 | 1 |
|---------|---------------------------|-------|----------|------|--------|-----|---|



douchekraan z. omstel

| | | | | | | | |
|---------|--|-------|----------|------|--------|-----|---|
| 0462969 | | chrom | 14731031 | stuk | 299,00 | 169 | 1 |
| 0460130 | | inox | 14731142 | stuk | 407,00 | 169 | 1 |



hendel v. 14285, 14291, 14306, 14237, 14243, 14249 en 14267

| | | | | | | | |
|---------|--|-------|----------|------|-------|-----|---|
| 0460610 | | chrom | 14400031 | stuk | 39,00 | 169 | 1 |
| 0460611 | | inox | 14400142 | stuk | 49,50 | 169 | 1 |



douchethermostaat z. omstel m. koppelingen

| | | | | | | | |
|---------|--|-------|----------|------|--------|-----|---|
| 0463113 | | chrom | 19451031 | stuk | 352,00 | 169 | 0 |
|---------|--|-------|----------|------|--------|-----|---|



3-gats badrandcombinatie m. uitloop m. slang 150cm m. handdouche

| | | | | | | | |
|---------|--|-------|----------|------|--------|-----|---|
| 0462403 | | chrom | 14237031 | stuk | 472,00 | 169 | 0 |
|---------|--|-------|----------|------|--------|-----|---|



3-gats badkraan voor badvulcombinatie z. uitloop m. slang 150cm m. handdouche

| | | | | | | | |
|---------|--|-------|----------|------|--------|-----|---|
| 0463612 | | chrom | 14243031 | stuk | 417,00 | 169 | 1 |
|---------|--|-------|----------|------|--------|-----|---|



| Art.nr | Specificaties | Kleur | Lev.nr | Ehd | Prijs | Grp | CC |
|--------|---------------|-------|--------|-----|-------|-----|----|
|--------|---------------|-------|--------|-----|-------|-----|----|

Gessi Font5

1-weg inbouwdouchekraan 1/2" cartouche=Ø35mm compleet; inbouw + afbouwdeel

| | | | | | | | |
|---------|--|-------|----------|--|------|--------|-------|
| 0462306 | | chrom | 14249031 | | stuk | 288,00 | 169 1 |
| 0460133 | | inox | 14249142 | | stuk | 388,00 | 169 1 |



Sanitair producten

Baden /
douchebakken /
stoomcabines**inbouwbadkraan 1/2" cartouche=Ø35mm m. omstel compleet; inbouw + afbouwdeel**

| | | | | | | | |
|---------|--|-------|----------|--|------|--------|-------|
| 0462322 | | chrom | 14267031 | | stuk | 325,00 | 169 1 |
|---------|--|-------|----------|--|------|--------|-------|



Kranen

Douchegarnituur

inbouwdouchethermostaat z. omstel m. stopkraan 1/2" compleet

| | | | | | | | |
|---------|---------------------|-------|----------|--|------|--------|-------|
| 0462683 | inbouw + afbouwdeel | chrom | 13331031 | | stuk | 494,00 | 169 0 |
|---------|---------------------|-------|----------|--|------|--------|-------|

Accessoires en
spiegels**inbouwbadthermostaat m. omstel m. stopkraan 1/2" compleet**

| | | | | | | | |
|---------|---------------------|-------|----------|--|------|--------|-------|
| 0462691 | inbouw + afbouwdeel | chrom | 13333031 | | stuk | 549,00 | 169 0 |
|---------|---------------------|-------|----------|--|------|--------|-------|



Douchewanden

Toebehoren &
afvoeren**inbouwbadthermostaat m. 3-weg omstel m. stopkraan 1/2" compleet**

| | | | | | | | |
|---------|---------------------|-------|----------|--|------|--------|-------|
| 0462705 | inbouw + afbouwdeel | chrom | 13335031 | | stuk | 578,00 | 169 1 |
|---------|---------------------|-------|----------|--|------|--------|-------|

Spoel- &
installatiesystemenBadkamermeubelen
en toiletkasten**inbouwstopkraan 1/2" compleet; inbouw + afbouwdeel**

| | | | | | | | |
|---------|--|-------|----------|--|------|--------|-------|
| 0462772 | | chrom | 12903031 | | stuk | 106,00 | 169 0 |
|---------|--|-------|----------|--|------|--------|-------|

Gootstenen en
wastroggen

Utiliteit

Gessi Mamilla

1-gats wastafelkraan m. vaste uitloop m. waste

| | | | | | | | |
|---------|--|------------|---------|--|------|--------|-------|
| 0461377 | | chrom | 3743031 | | stuk | 189,00 | 169 0 |
| 0461423 | | chrom/goud | 3743081 | | stuk | 215,00 | 169 1 |

**1-gats wastafelkraan m. hoge draaibare uitloop 5/4" m. waste**

| | | | | | | | |
|---------|--|------------|---------|--|------|--------|-------|
| 0463088 | | chrom | 3737031 | | stuk | 191,00 | 169 0 |
| 0463089 | | chrom/goud | 3737081 | | stuk | 219,00 | 169 1 |

**3-gats wastafelkraan m. vaste lage uitloop**

| | | | | | | | |
|---------|--|------------|---------|--|------|--------|-------|
| 0461385 | | chrom | 3707031 | | stuk | 191,00 | 169 0 |
| 0461431 | | chrom/goud | 3707081 | | stuk | 216,00 | 169 1 |

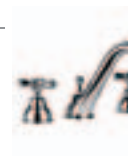

| Art.nr | Specificaties | Kleur | Lev.nr | Ehd | Prijs | Grp | CC |
|--------|---------------|-------|--------|-----|-------|-----|----|
|--------|---------------|-------|--------|-----|-------|-----|----|

Gessi Mamilla

3-gats wastafelkraan m. draaibare hoge uitloop

| | | | | | | | |
|---------|--|------------|---------|------|--------|-----|---|
| 0466913 | | chrom | 3701031 | stuk | 189,00 | 169 | 1 |
| 0463092 | | chrom/goud | 3701081 | stuk | 216,00 | 169 | 1 |



Sanitair producten

Baden /
douchebakken /
stoomcabines

inbouwwandkraan compleet; inbouw + afbouwdeel

| | | | | | | | |
|---------|----------------|------------|---------|------|--------|-----|---|
| 0466891 | uitloop 16.5cm | chrom | 3716031 | stuk | 250,00 | 169 | 1 |
| 0463090 | uitloop 16.5cm | chrom/goud | 3716081 | stuk | 283,00 | 169 | 1 |
| 0466905 | uitloop 23cm | chrom | 3719031 | stuk | 273,00 | 169 | 0 |
| 0463091 | uitloop 23cm | chrom/goud | 3719081 | stuk | 326,00 | 169 | 1 |



Kranen

Douchegarnituur

fonteinkraan

| | | | | | | | |
|---------|--|------------|---------|------|--------|-----|---|
| 0462144 | | chrom | 3993031 | stuk | 124,00 | 169 | 0 |
| 0462152 | | chrom/goud | 3993081 | stuk | 139,00 | 169 | 1 |



Accessoires en
spiegels

Douchewanden

1-gats bidetkraan m. waste

| | | | | | | | |
|---------|--|------------|---------|------|--------|-----|---|
| 0461415 | | chrom | 3749031 | stuk | 189,00 | 169 | 1 |
| 0461474 | | chrom/goud | 3749081 | stuk | 215,00 | 169 | 1 |



Toebehoren &
afvoeren

Spoel- &
installatiesystemen

3-gats bidetkraan m. waste

| | | | | | | | |
|---------|--|------------|---------|------|--------|-----|---|
| 0463093 | | chrom | 3713031 | stuk | 189,00 | 169 | 1 |
| 0463095 | | chrom/goud | 3713081 | stuk | 211,00 | 169 | 1 |

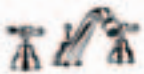

Badkamermeubelen
en toiletkasten

Gootstenen en
wastroggen

douchekraan m. koppelingen z. omstel

| | | | | | | | |
|---------|--|------------|---------|------|--------|-----|---|
| 0461407 | | chrom | 3941031 | stuk | 137,00 | 169 | 0 |
| 0461466 | | chrom/goud | 3941081 | stuk | 164,00 | 169 | 1 |



Utiliteit

inbouwdouchekraan 1/2" z. omstel cartouche=Ø35mm compleet;

| | | | | | | | |
|---------|---------------------|------------|---------|------|--------|-----|---|
| 0463096 | inbouw + afbouwdeel | chrom | 3971031 | stuk | 237,00 | 169 | 1 |
| 0463097 | inbouw + afbouwdeel | chrom/goud | 3971081 | stuk | 241,00 | 169 | 1 |



afbouwdeel v. inbouwdouchekraan z. omstel

| | | | | | | | |
|---------|--|------------|---------|------|--------|-----|---|
| 0460624 | | chrom | 3975031 | stuk | 146,00 | 169 | 1 |
| 0460625 | | chrom/goud | 3975081 | stuk | 150,00 | 169 | 1 |



badkraan m. koppelingen m. omstel m. telefoonhaak m. handdouche m. slang 150cm

| | | | | | | | |
|---------|--|------------|---------|------|--------|-----|---|
| 0461393 | | chrom | 3755031 | stuk | 254,00 | 169 | 0 |
| 0461458 | | chrom/goud | 3755081 | stuk | 317,00 | 169 | 1 |



| Art.nr | Specificaties | Kleur | Lev.nr | Ehd | Prijs | Grp | CC |
|--------|---------------|-------|--------|-----|-------|-----|----|
|--------|---------------|-------|--------|-----|-------|-----|----|

Gessi Mamilla

inbouwbadkraan 1/2" m. omstel cartouche=Ø35mm compleet; inbouw + afbouwdeel

| | | | | | | | |
|---------|--|------------|---------|------|--------|-----|---|
| 0463098 | | chrom | 3983031 | stuk | 280,00 | 169 | 1 |
| 0463099 | | chrom/goud | 3983081 | stuk | 295,00 | 169 | 1 |



Sanitair producten

Baden /
douchebakken /
stoomcabines**afbouwdeel v. inbouwbadkraan m. omstel**

| | | | | | | | |
|---------|--|------------|---------|------|--------|-----|---|
| 0460626 | | chrom | 3987031 | stuk | 163,00 | 169 | 1 |
| 0460627 | | chrom/goud | 3987081 | stuk | 177,00 | 169 | 1 |



Kranen

Douchegarnituur

4-gats badrandcombinatie m. omstel m. uitloop m. uittrekbare handdouche

| | | | | | | | |
|---------|--|------------|---------|------|--------|-----|---|
| 0461504 | | chrom | 3857031 | stuk | 388,00 | 169 | 0 |
| 0461512 | | chrom/goud | 3857081 | stuk | 437,00 | 169 | 1 |

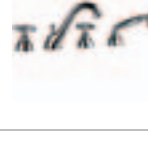
Accessoires en
spiegels**inbouwstopkraan compleet**

| | | | | | | | |
|---------|--|------------|---------|------|-------|-----|---|
| 0462128 | | chrom | 4017031 | stuk | 78,00 | 169 | 1 |
| 0462136 | | chrom/goud | 4017081 | stuk | 80,50 | 169 | 1 |



Douchewanden

Toebehoren &
afvoeren**afbouwdeel v. inbouwstopkraan**

| | | | | | | | |
|---------|--|------------|---------|------|-------|-----|---|
| 0460636 | | chrom | 4021031 | stuk | 30,50 | 169 | 1 |
| 0460637 | | chrom/goud | 4021081 | stuk | 33,00 | 169 | 1 |

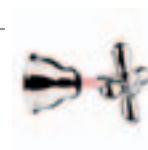
Spoel- &
installatiesystemenBadkamermeubelen
en toiletkasten**1-weg inbouwthermostaat m. aansluitingen 1/2" compleet; inbouw + afbouwdeel**

| | | | | | | | |
|---------|--|------------|---------|------|--------|-----|---|
| 0463100 | | chrom | 4130031 | stuk | 342,00 | 169 | 1 |
| 0460628 | | chrom/goud | 4130081 | stuk | 381,00 | 169 | 1 |

Gootstenen en
wastroggen

Utiliteit

afbouwdeel v. 1-weg inbouwthermostaat

| | | | | | | | |
|---------|--|------------|---------|------|--------|-----|---|
| 0460629 | | chrom | 4131031 | stuk | 98,50 | 169 | 1 |
| 0460630 | | chrom/goud | 4131081 | stuk | 138,00 | 169 | 1 |

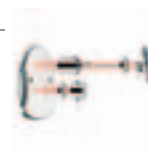
**2-weg inbouwthermostaat m. aansluitingen 1/2" m. omstel compleet;**

| | | | | | | | |
|---------|---------------------|------------|---------|------|--------|-----|---|
| 0463101 | inbouw + afbouwdeel | chrom | 4133031 | stuk | 396,00 | 169 | 1 |
| 0460631 | inbouw + afbouwdeel | chrom/goud | 4133081 | stuk | 435,00 | 169 | 1 |

**afbouwdeel v. 2-weg inbouwthermostaat m. omstel**

| | | | | | | | |
|---------|--|------------|---------|------|--------|-----|---|
| 0460632 | | chrom | 4134031 | stuk | 98,50 | 169 | 1 |
| 0460633 | | chrom/goud | 4134081 | stuk | 138,00 | 169 | 1 |

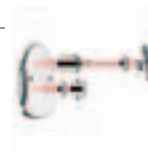

| Art.nr | Specificaties | Kleur | Lev.nr | Ehd | Prijs | Grp | CC |
|--------|---------------|-------|--------|-----|-------|-----|----|
|--------|---------------|-------|--------|-----|-------|-----|----|

Gessi Mamilla

3-weg inbouwthermostaat m. aansluitingen 1/2" m. omstel compleet;

| | | | | | | | |
|---------|---------------------|------------|---------|------|--------|-----|---|
| 0462829 | inbouw + afbouwdeel | chrom | 4136031 | stuk | 426,00 | 169 | 1 |
| 0462837 | inbouw + afbouwdeel | chrom/goud | 4136081 | stuk | 465,00 | 169 | 1 |



Sanitair producten

Baden /
douchebakken /
stoomcabines

afbouwdeel v. 3-weg inbouwthermostaat m. omstel

| | | | | | | | |
|---------|--|------------|---------|------|--------|-----|---|
| 0460634 | | chrom | 4137031 | stuk | 98,50 | 169 | 1 |
| 0460635 | | chrom/goud | 4137081 | stuk | 138,00 | 169 | 1 |



Kranen

Douchegarnituur

Gessi Mania

1-gats wastafelkraan m. waste

| | | | | | | | |
|---------|--|-------|----------|------|--------|-----|---|
| 0462411 | | chrom | 12801031 | stuk | 296,00 | 169 | 0 |
|---------|--|-------|----------|------|--------|-----|---|



Accessoires en
spiegels

Douchewanden

1-gats wastafelkraan verhoogd m. waste

| | | | | | | | |
|---------|--|-------|----------|------|--------|-----|---|
| 0462438 | | chrom | 11901031 | stuk | 325,00 | 169 | 1 |
|---------|--|-------|----------|------|--------|-----|---|



Toebehoren &
afvoeren

1-gats bidetkraan m. waste

| | | | | | | | |
|---------|--|-------|----------|------|--------|-----|---|
| 0462446 | | chrom | 12807031 | stuk | 296,00 | 169 | 1 |
|---------|--|-------|----------|------|--------|-----|---|



Spoel- &
installatiesystemen

Badkamermeubelen
en toiletkasten

badkraan joystick m. omstel z. garnituur

| | | | | | | | |
|---------|--|-------|----------|------|--------|-----|---|
| 0463396 | | chrom | 12813031 | stuk | 349,00 | 169 | 1 |
|---------|--|-------|----------|------|--------|-----|---|



Gootstenen en
wastroggen

Utiliteit

badkraan m. omstel m. slang 150cm m. anti-kalk handdouche m. vaste houder

| | | | | | | | |
|---------|--|-------|----------|------|--------|-----|---|
| 0462454 | | chrom | 12819031 | stuk | 415,00 | 169 | 0 |
|---------|--|-------|----------|------|--------|-----|---|



badkraan m. omstel m. slang 150cm m. handdouche m. verstelbare houder

| | | | | | | | |
|---------|--|-------|----------|------|--------|-----|---|
| 0463118 | | chrom | 12825031 | stuk | 433,00 | 169 | 1 |
|---------|--|-------|----------|------|--------|-----|---|







badthermostaat m. omstel z. garnituur

| | | | | | | | |
|---------|--|-------|----------|------|--------|-----|---|
| 0463119 | | chrom | 19441031 | stuk | 427,00 | 169 | 1 |
|---------|--|-------|----------|------|--------|-----|---|



badthermostaat m. omstel m. slang 150cm m. handdouche

| | | | | | | | |
|---------|--------------------|-------|----------|------|--------|-----|---|
| 0463120 | m. houder recht | chrom | 19403031 | stuk | 491,00 | 169 | 1 |
| 0463121 | m. houder afgerond | chrom | 19405031 | stuk | 511,00 | 169 | 1 |

| Art.nr | Specificaties | Kleur | Lev.nr | Ehd | Prijs | Grp | CC | | |
|--|----------------|-------|----------|------|--------|-----|----|---|---|
| | | | | | | | | Gessi Mania | |
| douchekraan z. omstel | | | | | | | | | |
| 0462470 | | chrom | 12831031 | stuk | 299,00 | 169 | 0 |  | Sanitair producten |
| douchethermostaat z. omstel m. koppelingen | | | | | | | | | |
| 0463113 | | chrom | 19451031 | stuk | 352,00 | 169 | 0 |  | Baden / douchebakken / stoomcabines |
| 3-gats badrandcombinatie m. uitloop m. slang 150cm m. handdouche | | | | | | | | | |
| 0462462 | | chrom | 12837031 | stuk | 438,00 | 169 | 0 |  | Douchegarnituur |
| 3-gats badkraan voor badvulcombinatie z. uitloop m. slang 150cm m. handdouche | | | | | | | | | |
| 0463418 | | chrom | 12843031 | stuk | 385,00 | 169 | 1 |  | Douchewanden |
| 1-weg inbouw-douchekraan 1/2" cartouche=Ø35mm compleet; inbouw + afbouwdeel | | | | | | | | | |
| 0462497 | | chrom | 12849031 | stuk | 185,00 | 169 | 1 |  | Toebehoren & afvoeren |
| 2-weg inbouwbadkraan 1/2" cartouche=Ø35mm compleet; inbouw + afbouwdeel | | | | | | | | | |
| 0462500 | | chrom | 12867031 | stuk | 224,00 | 169 | 1 |  | Badkamermeubelen en toiletkasten |
| 1-weg inbouwthermostaat m. aansluitingen 1/2" compleet; inbouw + afbouwdeel | | | | | | | | | |
| 0463123 | | chrom | 12891031 | stuk | 395,00 | 169 | 1 | | Spoel- & installatiesystemen |
| 2-weg inbouwthermostaat m. aansluitingen 1/2" m. omstel compleet; inbouw + afbouwdeel | | | | | | | | | |
| 0462756 | | chrom | 12897031 | stuk | 450,00 | 169 | 1 | | Gootstenen en wastroggen |
| 3-weg inbouwthermostaat m. aansluitingen 1/2" m. omstel compleet; inbouw + afbouwdeel | | | | | | | | | |
| 0462764 | | chrom | 12900031 | stuk | 479,00 | 169 | 1 | | Utiliteit |
| wanduitloop voor inbouwdeel 13297 | | | | | | | | | |
| 0462330 | 165mm m. inbus | chrom | 13304031 | stuk | 95,00 | 169 | 0 |  | |
| 0463884 | 165mm m. inbus | inox | 13304142 | stuk | 137,00 | 169 | 1 | | |
| wanduitloop voor bad | | | | | | | | | |
| 0462349 | 23cm | chrom | 13315031 | stuk | 119,00 | 169 | 0 | | |
| 0463081 | 23cm | inox | 13315142 | stuk | 161,00 | 169 | 1 | | |

| | Art.nr | Specificaties | Kleur | Lev.nr | Ehd | Prijs | Grp | CC |
|---|--------------------|--|-------|----------|------|--------|-----|----|
| Sanitair producten | Gessi Mania | | | | | | | |
| | | inbouwstopkraan 1/2" compleet; inbouw + afbouwdeel 0462772 | chrom | 12903031 | stuk | 106,00 | 169 | 0 |
| Baden / douchebakken / stoomcabines | | hendel los 0462535 | chrom | 12905031 | stuk | 23,75 | 169 | 1 |
| Kranen | Gessi Ovale | | | | | | | |
| | | 1-gats wastafelkraan m. waste 0463001 | chrom | 23001031 | stuk | 288,00 | 169 | 0 |
| Douchegarnituur | | 1-gats wastafelkraan m. verhoogde uitloop 12cm 0463002 | chrom | 11941031 | stuk | 347,00 | 169 | 1 |
| Accessoires en spiegels | | 1-gats wastafelkraan m. verhoogde uitloop 18cm 0463003 | chrom | 11943031 | stuk | 347,00 | 169 | 1 |
| Douchewanden | | 2-gats inbouw wandkraan m. uitloop compleet; inbouwdeel + afbouwdeel 0463004 | chrom | 23085031 | stuk | 416,00 | 169 | 1 |
| Toebehoren & afvoeren | | uitloop 0463007 | chrom | 23100031 | stuk | 117,00 | 169 | 1 |
| Spoel- & installatiesystemen | | inbouwstopkraan 1/2" 0463008 | chrom | 23106031 | stuk | 196,00 | 169 | 1 |
| Badkamermeubelen en toiletkasten | | 1-gats bidetkraan m. waste 0463011 | chrom | 23007031 | stuk | 288,00 | 169 | 1 |
| Gootstenen en wastroggen | | | | | | | | |
| Utiliteit | | | | | | | | |

| Art.nr | Specificaties | Kleur | Lev.nr | Ehd | Prijs | Grp | CC |
|--------|---------------|-------|--------|-----|-------|-----|----|
|--------|---------------|-------|--------|-----|-------|-----|----|

Gessi Ovale

1-gats wastafelkraan m. waste
0463012

chrom 23201031 stuk 329,00 169 0



Sanitair producten

3-gats wastafelkraan m. uitloop 15x21cm
0463013

chrom 23301031 stuk 465,00 169 1

Baden /
douchebakken /
stoomcabines

Kranen

3-gats wastafelkraan m. uitloop 30x21cm
0463014

chrom 23302031 stuk 482,00 169 1



Douchegarnituur

Accessoires en
spiegels

3-gats wandkraan
0463015

chrom 23285031 stuk 373,00 169 1



Douchewanden

Toebehoren &
afvoeren

3-gats bidetkraan m. waste
0463016

chrom 23307031 stuk 405,00 169 1

Spoel- &
installatiesystemenBadkamermeubelen
en toiletkasten

badkraan m. omstel z. garnituur
0463017

chrom 21513031 stuk 450,00 169 1

Gootstenen en
wastroggen

badkraan m. omstel m. slang m. handdouche m. vaste wandhouder
0463018

chrom 21519031 stuk 621,00 169 0



Utiliteit

badkraan m. omstel m. slang m. handdouche m. verstelbare wandhouder
0463020









chrom 21525031 stuk 694,00 169 1



badthermostaat m. omstel z. garnituur
0463021

chrom 21611031 stuk 530,00 169 0



| | Art.nr | Specificaties | Kleur | Lev.nr | Ehd | Prijs | Grp | CC |
|---|---|--|-------|----------|------|--------|-----|----|
| | Gessi Ovale | | | | | | | |
| Sanitair producten | 0463022 | badthermostaat m. omstel m. slang m. handdouche m. vaste wandhouder | chrom | 21613031 | stuk | 701,00 | 169 | 1 |
| |  | | | | | | | |
| Baden / douchebakken / stoomcabines | | | | | | | | |
| Kranen | 0463023 | badthermostaat m. omstel m. slang m. handdouche m. verstelbare wandhouder | chrom | 21615031 | stuk | 774,00 | 169 | 1 |
| |  | | | | | | | |
| Douchegarnituur | | | | | | | | |
| Accessoires en spiegels | 0463024 | 3-gats badrandcombinatie m. uitloop m. slang m. handdouche | chrom | 23037031 | stuk | 736,00 | 169 | 0 |
| |  | | | | | | | |
| Douchewanden | | | | | | | | |
| Toebehoren & afvoeren | 0463025 | 3-gats badkraan voor badvulcombinatie z. uitloop m. slang m. handdouche | chrom | 23043031 | stuk | 659,00 | 169 | 1 |
| |  | | | | | | | |
| Spoel- & installatiesystemen | 0460139 | slangdoorvoer voor badrandmontage | | 23172031 | stuk | 53,00 | 169 | 1 |
| |  | | | | | | | |
| Badkamermeubelen en toiletkasten | | | | | | | | |
| Gootstenen en wastroggen | 0460140 | doucheslang voor badrandmontage | | 1098031 | stuk | 18,75 | 169 | 1 |
| |  | | | | | | | |
| Utiliteit | 0463032 | wanduitloop | chrom | 23181031 | stuk | 117,00 | 169 | 1 |
| |  | | | | | | | |
| | 0463033 | douchekraan | chrom | 21531031 | stuk | 360,00 | 169 | 1 |
| |  | | | | | | | |
| | 0463034 | douchethermostaat | chrom | 21621031 | stuk | 455,00 | 169 | 0 |
| |  | | | | | | | |

| Art.nr | Specificaties | Kleur | Lev.nr | Ehd | Prijs | Grp | CC |
|--------|---------------|-------|--------|-----|-------|-----|----|
|--------|---------------|-------|--------|-----|-------|-----|----|

Gessi Ovale

| | | | | | | | |
|---------|---|-------|----------|------|---------|-----|---|
| 0460644 | thermostatische douchezuil m. hoofddouche en handdouche m. glijstang | chrom | 21631031 | stuk | 1761,00 | 169 | 1 |
|---------|---|-------|----------|------|---------|-----|---|



Sanitair producten

Baden /
douchebakken /
stoomcabines

| | | | | | | | |
|---------|--|-------|----------|------|---------|-----|---|
| 0460645 | thermostatische douchezuil m. hoofddouche en handdouche | chrom | 21635031 | stuk | 2412,00 | 169 | 1 |
|---------|--|-------|----------|------|---------|-----|---|



Kranen

Douchegarnituur

| | | | | | | | |
|---------|---|-------|----------|------|--------|-----|---|
| 0463036 | 1-weg inbouwdouchekraan 1/2" cartouche=Ø35mm compleet; inbouw + afbouwdeel | chrom | 23049031 | stuk | 296,00 | 169 | 1 |
|---------|---|-------|----------|------|--------|-----|---|

Accessoires en
spiegels

| | | | | | | | |
|---------|--|-------|----------|------|--------|-----|---|
| 0463039 | 2-weg inbouwbadkraan 1/2" cartouche=Ø35mm compleet; inbouw + afbouwdeel | chrom | 23067031 | stuk | 338,00 | 169 | 1 |
|---------|--|-------|----------|------|--------|-----|---|



Douchewanden

Toebehoren &
afvoeren

| | | | | | | | |
|---------|--|-------|----------|------|--------|-----|---|
| 0463046 | 2-weg inbouwthermostaat m. aansluitingen 1/2" m. omstel compleet; inbouw + afbouwdeel | chrom | 23133031 | stuk | 671,00 | 169 | 0 |
|---------|--|-------|----------|------|--------|-----|---|

Spoel- &
installatiesystemenBadkamermeubelen
en toiletkasten

| | | | | | | | |
|---------|--|-------|----------|------|--------|-----|---|
| 0463049 | 3-weg inbouwthermostaat m. aansluitingen 1/2" m. omstel compleet; inbouw + afbouwdeel | chrom | 23135031 | stuk | 701,00 | 169 | 1 |
|---------|--|-------|----------|------|--------|-----|---|

Gootstenen en
wastroggen

| | | | | | | | |
|---------|---|-------|----------|------|--------|-----|---|
| 0463053 | inbouwstopkraan 1/2" compleet; inbouw + afbouwdeel | chrom | 23163031 | stuk | 151,00 | 169 | 1 |
|---------|---|-------|----------|------|--------|-----|---|











Utiliteit

| | | | | | | | |
|---------|--|-------|----------|------|--------|-----|---|
| 0463009 | afbouwdeel voor 1-weg inbouwkraan los | chrom | 23109031 | stuk | 105,00 | 169 | 1 |
|---------|--|-------|----------|------|--------|-----|---|



| | | | | | | | |
|---------|--------------------------------------|-------|----------|------|--------|-----|---|
| 0463005 | afbouwdeel voor wandkraan los | chrom | 23088031 | stuk | 285,00 | 169 | 1 |
|---------|--------------------------------------|-------|----------|------|--------|-----|---|



| | Art.nr | Specificaties | Kleur | Lev.nr | Ehd | Prijs | Grp | CC |
|---|---|---|--------|----------|------|--------|-----|----|
| | Gessi Ovale | | | | | | | |
| Sanitair producten | | afbouwdeel voor inbouwdouchekraan los | | | | | | |
| | 0463038 | | chroom | 23061031 | stuk | 205,00 | 169 | 1 |
| Baden / douchebakken / stoomcabines |  | | | | | | | |
| | | afbouwdeel voor inbouwbadkraan los | | | | | | |
| | 0463041 | | chroom | 23079031 | stuk | 221,00 | 169 | 1 |
| Kranen |  | | | | | | | |
| Douchegarnituur | | afbouwdeel voor inbouwthermostaat los | | | | | | |
| | 0463045 | | chroom | 23132031 | stuk | 374,00 | 169 | 1 |
| | 0463048 | | chroom | 23134031 | stuk | 374,00 | 169 | 1 |
| Accessoires en spiegels |  | 0463052 | chroom | 23136031 | stuk | 374,00 | 169 | 1 |
| Douchewanden | | afbouwdeel voor inbouwstopkraan los | | | | | | |
| | 0463055 | | chroom | 23166031 | stuk | 104,00 | 169 | 1 |
| Toebehoren & afvoeren |  | | | | | | | |
| | Gessi Oxygene | | | | | | | |
| | | toiletkraan laag model | | | | | | |
| | 0460105 | | chroom | 20511031 | stuk | 135,00 | 169 | 0 |
| Spoel- & installatiesystemen | | toiletkraan hoge uitloop 117mm | | | | | | |
| | 0460138 | | chroom | 00915031 | stuk | 120,00 | 169 | 0 |
| Badkamermeubelen en toiletkasten | | 0460108 | inox | 915142 | stuk | 155,00 | 169 | 0 |
| | Gessi Ozone | | | | | | | |
| | | 1-gats wastafelkraan m. waste | | | | | | |
| | 0462977 | | chroom | 13801031 | stuk | 230,00 | 169 | 0 |
| Gootstenen en wastroggen |  | | | | | | | |
| | | 1-gats wastafelkraan verhoogd m. waste | | | | | | |
| | 0462985 | | chroom | 11905031 | stuk | 254,00 | 169 | 0 |
| Utiliteit |  | | | | | | | |
| | | 1-gats wastafelkraan m. waste | | | | | | |
| | 0460647 | m. uittrekbare handdouche | chroom | 13915031 | stuk | 319,00 | 169 | 1 |
| |  | | | | | | | |
| | | 1-gats bidetkraan m. waste | | | | | | |
| | 0462993 | | chroom | 13807031 | stuk | 230,00 | 169 | 1 |
| |  | | | | | | | |

| Art.nr | Specificaties | Kleur | Lev.nr | Ehd | Prijs | Grp | CC |
|--------|---------------|-------|--------|-----|-------|-----|----|
|--------|---------------|-------|--------|-----|-------|-----|----|

Gessi Ozone

2-gats inbouwwandkraan compleet; inbouwdeel + afbouwdeel

| | | | | | | | |
|---------|----------------|--------|----------|------|--------|-----|---|
| 0463000 | uitloop 16.5cm | chroom | 13885031 | stuk | 396,00 | 169 | 1 |
| 0463019 | uitloop 23cm | chroom | 13891031 | stuk | 413,00 | 169 | 0 |



Sanitair producten

Baden /
douchebakken /
stoomcabines

Kranen

uitloop

| | | | | | | | | |
|---------|--------|-----------------|--------|----------|------|-------|-----|---|
| 0463469 | 16.5cm | m. schroefdraad | chroom | 13300031 | stuk | 95,00 | 169 | 0 |
|---------|--------|-----------------|--------|----------|------|-------|-----|---|



Douchegarnituur

afbouwset v. 2-gats inbouwwandkraan m. uitloop 16.5cm

| | | | | | | | |
|---------|--|--------|----------|------|--------|-----|---|
| 0460648 | | chroom | 13888031 | stuk | 265,00 | 169 | 1 |
|---------|--|--------|----------|------|--------|-----|---|

Accessoires en
spiegels

Douchewanden

afbouwset v. 2-gats inbouwwandkraan m. uitloop 23cm

| | | | | | | | |
|---------|--|--------|----------|------|--------|-----|---|
| 0460649 | | chroom | 13894031 | stuk | 282,00 | 169 | 1 |
|---------|--|--------|----------|------|--------|-----|---|

Toebehoren &
afvoerenSpoel- &
installatiesystemen**uitloop**

| | | | | | | | | |
|---------|--------|-----------------|--------|----------|------|--------|-----|---|
| 0463061 | 16.5cm | m. schroefdraad | inox | 13300142 | stuk | 137,00 | 169 | 1 |
| 0463477 | 23cm | m. schroefdraad | chroom | 13303031 | stuk | 119,00 | 169 | 0 |
| 0463062 | 23cm | m. schroefdraad | inox | 13303142 | stuk | 161,00 | 169 | 1 |

Badkamermeubelen
en toiletkasten**inbouwwastafelkraan z. uitloop compleet; inbouw + afbouwdeel**

| | | | | | | | |
|---------|--|--------|----------|------|--------|-----|---|
| 0463107 | | chroom | 13906031 | stuk | 178,00 | 169 | 0 |
|---------|--|--------|----------|------|--------|-----|---|

Gootstenen en
wastroggen

Utiliteit









badkraan m. omstel z. garnituur

| | | | | | | | |
|---------|--|--------|----------|------|--------|-----|---|
| 0464244 | | chroom | 13813031 | stuk | 315,00 | 169 | 1 |
|---------|--|--------|----------|------|--------|-----|---|

**badkraan m. omstel m. slang 150cm m. anti-kalk handdouche m. vaste wandhouder**

| | | | | | | | |
|---------|--|--------|----------|------|--------|-----|---|
| 0463027 | | chroom | 13819031 | stuk | 379,00 | 169 | 1 |
|---------|--|--------|----------|------|--------|-----|---|



| | Art.nr | Specificaties | Kleur | Lev.nr | Ehd | Prijs | Grp | CC |
|---|---|---|-------|----------|------|--------|-----|----|
| | Gessi Ozone | | | | | | | |
| Sanitair producten | 0463109 | badkraan m. omstel m. slang 150cm m. handdouche m. verstelbare wandhouder | chrom | 13825031 | stuk | 399,00 | 169 | 1 |
| |  | | | | | | | |
| Baden / douchebakken / stoomcabines | | | | | | | | |
| Kranen | 0463110 | badthermostaat m. omstel | chrom | 19461031 | stuk | 427,00 | 169 | 1 |
| |  | | | | | | | |
| Douchegarnituur | | | | | | | | |
| Accessoires en spiegels | 0463111 | badthermostaat m. omstel m. slang 150cm m. handdouche m. wandhouder recht | chrom | 19463031 | stuk | 491,00 | 169 | 1 |
| |  | | | | | | | |
| Douchewanden | | | | | | | | |
| Toebehoren & afvoeren | 0463112 | badthermostaat m. omstel m. slang 150cm m. handdouche m. wandhouder afgerond | chrom | 19465031 | stuk | 511,00 | 169 | 1 |
| |  | | | | | | | |
| Spoel- & installatiesystemen | 0463043 | douchekraan z. omstel | chrom | 13831031 | stuk | 240,00 | 169 | 1 |
| |  | | | | | | | |
| Badkamermeubelen en toiletkasten | | | | | | | | |
| Gootstenen en wastroggen | 0463113 | douchethermostaat z. omstel m. koppelingen | chrom | 19451031 | stuk | 352,00 | 169 | 0 |
| |  | | | | | | | |
| Utiliteit | | | | | | | | |
| | 0463035 | 3-gats badrandcombinatie m. uitloop m. slang 150cm m. handdouche | chrom | 13837031 | stuk | 472,00 | 169 | 0 |
| |  | | | | | | | |
| | 0460651 | 3-gats badrandcombinatie z. uitloop m. slang 150cm m. handdouche | chrom | 13843031 | stuk | 417,00 | 169 | 1 |
| |  | | | | | | | |
| | 0463114 | 1-weg inbouwdouchekraan 1/2" compleet; inbouw + afbouwdeel | chrom | 13849031 | stuk | 288,00 | 169 | 1 |
| |  | | | | | | | |

| Art.nr | Specificaties | Kleur | Lev.nr | Ehd | Prijs | Grp | CC |
|--------|---------------|-------|--------|-----|-------|-----|----|
|--------|---------------|-------|--------|-----|-------|-----|----|

Gessi Ozone

inbouwdoouchethermostaat z. omstel m. stopkraan 1/2" compleet

| | | | | | | | |
|---------|---------------------|-------|----------|------|--------|-----|---|
| 0462683 | inbouw + afbouwdeel | chrom | 13331031 | stuk | 494,00 | 169 | 0 |
|---------|---------------------|-------|----------|------|--------|-----|---|



Sanitair producten

Baden /
douchebakken /
stoomcabines**inbouwbadthermostaat m. omstel m. stopkraan 1/2" compleet**

| | | | | | | | |
|---------|---------------------|-------|----------|------|--------|-----|---|
| 0462691 | inbouw + afbouwdeel | chrom | 13333031 | stuk | 549,00 | 169 | 0 |
|---------|---------------------|-------|----------|------|--------|-----|---|



Kranen

Douchegarnituur

inbouwbadthermostaat m. 3-weg omstel m. stopkraan 1/2" compleet

| | | | | | | | |
|---------|---------------------|-------|----------|------|--------|-----|---|
| 0462705 | inbouw + afbouwdeel | chrom | 13335031 | stuk | 578,00 | 169 | 1 |
|---------|---------------------|-------|----------|------|--------|-----|---|

Accessoires en
spiegels**thermostatische douchezuil**

| | | | | | | | |
|---------|----------------------|-------|----------|------|---------|-----|---|
| 0460536 | recht m. hoofddouche | chrom | 23461031 | stuk | 1488,00 | 169 | 1 |
| 0460537 | recht m. hoofddouche | inox | 23461142 | stuk | 1934,00 | 169 | 1 |



Douchewanden

Toebehoren &
afvoeren**wanduitloop voor inbouwdeel 13297**

| | | | | | | | |
|---------|----------------|-------|----------|------|--------|-----|---|
| 0462330 | 165mm m. inbus | chrom | 13304031 | stuk | 95,00 | 169 | 0 |
| 0463884 | 165mm m. inbus | inox | 13304142 | stuk | 137,00 | 169 | 1 |

Spoel- &
installatiesystemenBadkamermeubelen
en toiletkasten**wanduitloop voor bad**

| | | | | | | | |
|---------|------|-------|----------|------|--------|-----|---|
| 0462349 | 23cm | chrom | 13315031 | stuk | 119,00 | 169 | 0 |
|---------|------|-------|----------|------|--------|-----|---|

thermostatische douchezuil

| | | | | | | | |
|---------|------------------------|-------|----------|------|---------|-----|---|
| 0460538 | gebogen m. hoofddouche | chrom | 23471031 | stuk | 1412,00 | 169 | 1 |
| 0460539 | gebogen m. hoofddouche | inox | 23471142 | stuk | 1836,00 | 169 | 1 |

Gootstenen en
wastroggen

Utiliteit

wanduitloop voor bad

| | | | | | | | |
|---------|------|------|----------|------|--------|-----|---|
| 0463081 | 23cm | inox | 13315142 | stuk | 161,00 | 169 | 1 |
|---------|------|------|----------|------|--------|-----|---|

**inbouwstopkraan 1/2" compleet; inbouw + afbouwdeel**

| | | | | | | | |
|---------|--|-------|----------|------|--------|-----|---|
| 0462772 | | chrom | 12903031 | stuk | 106,00 | 169 | 0 |
|---------|--|-------|----------|------|--------|-----|---|



| Art.nr | Specificaties | Kleur | Lev.nr | Ehd | Prijs | Grp | CC |
|--------|---------------|-------|--------|-----|-------|-----|----|
|--------|---------------|-------|--------|-----|-------|-----|----|

Gessi Ozone

thermostatische douchezuil recht m. hoofddouche m. handdouche

| | | | | | | | |
|---------|--|--------|----------|------|---------|-----|---|
| 0460540 | | chroom | 23463031 | stuk | 1783,00 | 169 | 1 |
| 0460541 | | inox | 23463142 | stuk | 2316,00 | 169 | 1 |



Sanitair producten

Baden /
douchebakken /
stoomcabines

thermostatische douchezuil gebogen m. hoofddouche m. handdouche

| | | | | | | | |
|---------|--|--------|----------|------|---------|-----|---|
| 0460542 | | chroom | 23473031 | stuk | 1706,00 | 169 | 1 |
| 0460543 | | inox | 23473142 | stuk | 2218,00 | 169 | 1 |



Kranen

Douchegarnituur

thermostatische douchezuil recht m. hoofddouche en handdouche m glijstang

| | | | | | | | |
|---------|--|--------|----------|------|---------|-----|---|
| 0460544 | | chroom | 23465031 | stuk | 1674,00 | 169 | 1 |
| 0460545 | | inox | 23465142 | stuk | 2175,00 | 169 | 1 |



Accessoires en
spiegels

Douchewanden

thermostatische douchezuil gebogen m. hoofddouche en handdouche m glijstang

| | | | | | | | |
|---------|--|--------|----------|------|---------|-----|---|
| 0460546 | | chroom | 23475031 | stuk | 1597,00 | 169 | 1 |
| 0460547 | | inox | 23475142 | stuk | 2076,00 | 169 | 1 |



Toebehoren &
afvoeren

2-wegs inbouw omstelkraan compleet; inbouw en afbouwdeel

| | | | | | | | |
|---------|--|--------|----------|------|--------|-----|---|
| 0460550 | | chroom | 14381031 | stuk | 230,00 | 169 | 1 |
| 0460551 | | inox | 14381142 | stuk | 296,00 | 169 | 1 |



Spoel- &
installatiesystemen

Badkamermeubelen
en toiletkasten

3-wegs inbouw omstelkraan compleet; inbouw en afbouwdeel

| | | | | | | | |
|---------|--|--------|----------|------|--------|-----|---|
| 0460552 | | chroom | 14383031 | stuk | 230,00 | 169 | 1 |
| 0460553 | | inox | 14383142 | stuk | 296,00 | 169 | 1 |



Gootstenen en
wastroggen

Utiliteit

afbouwdeel v. inbouw stopkraan

| | | | | | | | |
|---------|--|--------|----------|------|-------|-----|---|
| 0460554 | | chroom | 12915031 | stuk | 58,50 | 169 | 1 |
| 0460555 | | inox | 12915142 | stuk | 98,50 | 169 | 1 |



Gessi Profumi Luce









wanduitloop voor inbouwdeel 13297

| | | | | | | | | |
|---------|-------|----------|--------|----------|------|--------|-----|---|
| 0462330 | 165mm | m. inbus | chroom | 13304031 | stuk | 95,00 | 169 | 0 |
| 0463884 | 165mm | m. inbus | inox | 13304142 | stuk | 137,00 | 169 | 1 |



wanduitloop voor bad

| | | | | | | | | |
|---------|------|--|--------|----------|------|--------|-----|---|
| 0462349 | 23cm | | chroom | 13315031 | stuk | 119,00 | 169 | 0 |
| 0463081 | 23cm | | inox | 13315142 | stuk | 161,00 | 169 | 1 |

| Art.nr | Specificaties | Kleur | Lev.nr | Ehd | Prijs | Grp | CC | | | |
|---|----------------|-----------------|----------|----------|--------|--------|-----|---|---|-----------|
| | | | | | | | | Gessi Quadro | | |
| 1-gats wastafelkraan m. waste | | | | | | | | | | |
| 0462543 | | chroom | 15001031 | stuk | 289,00 | 169 | 0 |  | Sanitair producten | |
| 0463639 | | inox | 15001142 | stuk | 393,00 | 169 | 0 | | | |
| wastafelkraan verhoogd uitloop 110mm m. waste | | | | | | | | | | |
| 0462551 | | chroom | 11907031 | stuk | 348,00 | 169 | 0 |  | Baden / douchebakken / stoomcabines | |
| 0463647 | | inox | 11907142 | stuk | 470,00 | 169 | 1 | | | |
| wastafelkraan verhoogd uitloop 190mm m. waste | | | | | | | | | | |
| 0462578 | | chroom | 11911031 | stuk | 348,00 | 169 | 1 |  | Douchegarnituur | |
| 0463655 | | inox | 11911142 | stuk | 470,00 | 169 | 1 | | | |
| 2-gats inbouwwandkraan compleet; inbouwdeel + afbouwdeel | | | | | | | | | | |
| 0462586 | uitloop 16.5cm | chroom | 15085031 | stuk | 417,00 | 169 | 1 |  | Douchewanden | |
| 0463663 | uitloop 16.5cm | inox | 15085142 | stuk | 562,00 | 169 | 1 | | | |
| 0462594 | uitloop 23cm | chroom | 15091031 | stuk | 434,00 | 169 | 0 | | | |
| 0463671 | uitloop 23cm | inox | 15091142 | stuk | 586,00 | 169 | 1 | | | |
| afbouwdeel v. wandkraan m. uitloop 16.5cm | | | | | | | | | | |
| 0460654 | | chroom | 15088031 | stuk | 286,00 | 169 | 1 |  | Toebehoren & afvoeren | |
| 0460655 | | inox | 15088142 | stuk | 431,00 | 169 | 1 | | | |
| afbouwdeel v. wandkraan m. uitloop 23cm | | | | | | | | | | |
| 0460656 | | chroom | 15094031 | stuk | 303,00 | 169 | 1 |  | Badkamermeubelen en toiletkasten | |
| 0460657 | | inox | 15094142 | stuk | 455,00 | 169 | 1 | | | |
| 1-gats bidetkraan m. waste | | | | | | | | | | |
| 0462608 | | chroom | 15007031 | stuk | 289,00 | 169 | 1 |  | Gootstenen en wastroggen | |
| 0463698 | | inox | 15007142 | stuk | 393,00 | 169 | 1 | | | |
| uitloop | | | | | | | | | | |
| 0463469 | 16.5cm | m. schroefdraad | chroom | 13300031 | stuk | 95,00 | 169 | 0 |  | Utiliteit |
| 0463061 | 16.5cm | m. schroefdraad | inox | 13300142 | stuk | 137,00 | 169 | 1 | | |
| 0463477 | 23cm | m. schroefdraad | chroom | 13303031 | stuk | 119,00 | 169 | 0 | | |
| 0463062 | 23cm | m. schroefdraad | inox | 13303142 | stuk | 161,00 | 169 | 1 | | |
| inbouwwastafelkraan z. uitloop compleet; inbouwdeel + afbouwdeel | | | | | | | | | | |
| 0463485 | | chroom | 15106031 | stuk | 197,00 | 169 | 1 |  | | |
| 0463825 | | inox | 15106142 | stuk | 263,00 | 169 | 1 | | | |

| Art.nr | Specificaties | Kleur | Lev.nr | Ehd | Prijs | Grp | CC |
|--------|---------------|-------|--------|-----|-------|-----|----|
|--------|---------------|-------|--------|-----|-------|-----|----|

Gessi Quadro

afbouwdeel v. inbouw wastafelkraan

| | | | | | | | |
|---------|--|-------|----------|------|--------|-----|---|
| 0460659 | | chrom | 15109031 | stuk | 106,00 | 169 | 1 |
| 0460660 | | inox | 15109142 | stuk | 172,00 | 169 | 1 |



Sanitair producten

Baden /
douchebakken /
stoomcabines

afdekplaat rond voor inbouwkraan

| | | | | | | | |
|---------|--|-------|----------|------|-------|-----|---|
| 0467928 | | chrom | 13398031 | stuk | 33,00 | 169 | 0 |
| 0460487 | | inox | 13398142 | stuk | 46,50 | 169 | 1 |



Kranen

Douchegarnituur

badkraan m. omstel z. garnituur

| | | | | | | | |
|---------|--|-------|----------|------|--------|-----|---|
| 0463493 | | chrom | 15013031 | stuk | 492,00 | 169 | 0 |
| 0463833 | | inox | 15013142 | stuk | 660,00 | 169 | 1 |



Accessoires en
spiegels

Douchewanden

badkraan m. omstel m. slang 150cm m. anti-kalk handdouche m. vaste wandhouder

| | | | | | | | |
|---------|--|-------|----------|------|--------|-----|---|
| 0462616 | | chrom | 15019031 | stuk | 557,00 | 169 | 0 |
| 0463701 | | inox | 15019142 | stuk | 746,00 | 169 | 1 |



Toebehoren &
afvoeren

Spoel- &
installatiesystemen

badkraan m. omstel m. slang 150cm m. handdouche m. verstelbare wandhouder

| | | | | | | | |
|---------|--|-------|----------|------|--------|-----|---|
| 0463063 | | chrom | 15025031 | stuk | 576,00 | 169 | 1 |
| 0463064 | | inox | 15025142 | stuk | 773,00 | 169 | 1 |



Badkamermeubelen
en toiletkasten

Gootstenen en
wastroggen

badthermostaat m. omstel

| | | | | | | | |
|---------|--|-------|----------|------|--------|-----|---|
| 0463065 | | chrom | 19421031 | stuk | 558,00 | 169 | 0 |
| 0463066 | | inox | 19421142 | stuk | 742,00 | 169 | 1 |



Utiliteit

badthermostaat m. omstel m. slang 150cm m. handdouche m. wandhouder recht

| | | | | | | | |
|---------|--|-------|----------|------|--------|-----|---|
| 0463067 | | chrom | 19423031 | stuk | 622,00 | 169 | 0 |
| 0463068 | | inox | 19423142 | stuk | 828,00 | 169 | 1 |



badthermostaat m. omstel m. slang 150cm m. handdouche m. wandhouder afgerond

| | | | | | | | |
|---------|--|-------|----------|------|--------|-----|---|
| 0463069 | | chrom | 19425031 | stuk | 642,00 | 169 | 1 |
| 0463070 | | inox | 19425142 | stuk | 855,00 | 169 | 1 |



staande badkraan met garnituur; inbouwdeel en afbouwdeel

| | | | | | | | |
|---------|--------------|-------|----------|------|---------|-----|---|
| 0460661 | hoog 107.9cm | chrom | 24905031 | stuk | 1369,00 | 169 | 1 |
| 0460662 | hoog 107.9cm | inox | 24905142 | stuk | 1779,00 | 169 | 1 |



| Art.nr | Specificaties | Kleur | Lev.nr | Ehd | Prijs | Grp | CC |
|--------|---------------|-------|--------|-----|-------|-----|----|
|--------|---------------|-------|--------|-----|-------|-----|----|

Gessi Quadro

afbouwdeel v. staande badkraan

| | | | | | | | |
|---------|--|--------|----------|------|---------|-----|---|
| 0460663 | | chroom | 24908031 | stuk | 1213,00 | 169 | 1 |
| 0460711 | | inox | 24908142 | stuk | 1624,00 | 169 | 1 |



Sanitair producten

Baden /
douchebakken /
stoomcabines**douchekraan z. omstel**

| | | | | | | | |
|---------|--|--------|----------|------|--------|-----|---|
| 0462632 | | chroom | 15031031 | stuk | 414,00 | 169 | 0 |
| 0463736 | | inox | 15031142 | stuk | 554,00 | 169 | 1 |



Kranen

Douchegarnituur

douchethermostaat

| | | | | | | | |
|---------|--|--------|----------|------|--------|-----|---|
| 0463071 | | chroom | 19431031 | stuk | 479,00 | 169 | 0 |
| 0463072 | | inox | 19431142 | stuk | 647,00 | 169 | 0 |

Accessoires en
spiegels**thermostatische douche kraan m. pijp en hoofddouche**

| | | | | | | | |
|---------|-------|--------|----------|------|---------|-----|---|
| 0460975 | 117cm | chroom | 23423031 | stuk | 1429,00 | 169 | 1 |
| 0460976 | 117cm | inox | 23423142 | stuk | 1857,00 | 169 | 1 |
| 0460759 | 177cm | chroom | 23421031 | stuk | 1685,00 | 169 | 1 |
| 0460760 | 177cm | inox | 23421142 | stuk | 2191,00 | 169 | 1 |



Douchewanden

Toebehoren &
afvoerenSpoel- &
installatiesystemenBadkamermeubelen
en toiletkasten**thermostatische douche kraan m. pijp, hoofddouche en handdouche**

| | | | | | | | |
|---------|-------|--------|----------|------|---------|-----|---|
| 0460979 | 117cm | chroom | 23427031 | stuk | 1754,00 | 169 | 1 |
| 0460980 | 117cm | inox | 23427142 | stuk | 2280,00 | 169 | 1 |
| 0460977 | 177cm | chroom | 23425031 | stuk | 2010,00 | 169 | 1 |
| 0460978 | 177cm | inox | 23425142 | stuk | 2613,00 | 169 | 1 |









Gootstenen en
wastroggen









Utiliteit

thermostatische douche kraan m. pijp, hoofddouche en handdouche m glijtang

| | | | | | | | |
|---------|-------|--------|----------|------|---------|-----|---|
| 0460983 | 117cm | chroom | 23431031 | stuk | 1882,00 | 169 | 1 |
| 0460984 | 117cm | inox | 23431142 | stuk | 2446,00 | 169 | 1 |
| 0460981 | 177cm | chroom | 23429031 | stuk | 2139,00 | 169 | 1 |
| 0460982 | 177cm | inox | 23429142 | stuk | 2780,00 | 169 | 1 |



| | Art.nr | Specificaties | Kleur | Lev.nr | Ehd | Prijs | Grp | CC |
|---|--|----------------|--------|----------|------|--------|-----|----|
| | Gessi Quadro | | | | | | | |
| Sanitair producten | 3-gats badkraan m. uitloop m. slang 150cm m. handdouche | | | | | | | |
| | 0462624 | | chroom | 15037031 | stuk | 531,00 | 169 | 0 |
| | 0463728 | | inox | 15037142 | stuk | 715,00 | 169 | 1 |
| Baden / douchebakken / stoomcabines |  | | | | | | | |
| Kranen | wanduitloop voor inbouwdeel 13297 | | | | | | | |
| | 0462330 | 165mm m. inbus | chroom | 13304031 | stuk | 95,00 | 169 | 0 |
| | 0463884 | 165mm m. inbus | inox | 13304142 | stuk | 137,00 | 169 | 1 |
| Douchegarnituur |  | | | | | | | |
| Accessoires en spiegels | wanduitloop voor bad | | | | | | | |
| | 0462349 | 23cm | chroom | 13315031 | stuk | 119,00 | 169 | 0 |
| | 0463081 | 23cm | inox | 13315142 | stuk | 161,00 | 169 | 1 |
| Douchewanden |  | | | | | | | |
| Toebehoren & afvoeren | 3-gats badkraan voor badvulcombinatie z. uitloop m. slang 150cm m. handdouche | | | | | | | |
| | 0463507 | | chroom | 15043031 | stuk | 500,00 | 169 | 1 |
| | 0463841 | | inox | 15043142 | stuk | 674,00 | 169 | 1 |
| Spoel- & installatiesystemen |  | | | | | | | |
| Badkamermeubelen en toiletkasten | 1-weg inbouwdoouchekraan 1/2" cartouche=Ø35mm compleet; inbouw + afbouwdeel | | | | | | | |
| | 0462667 | | chroom | 15049031 | stuk | 306,00 | 169 | 1 |
| | 0463752 | | inox | 15049142 | stuk | 412,00 | 169 | 1 |
| Gootstenen en wastroggen |  | | | | | | | |
| Utiliteit | afbouwdeel v. 1-weg inbouwdoouchekraan | | | | | | | |
| | 0460712 | | chroom | 15061031 | stuk | 215,00 | 169 | 1 |
| | 0460713 | | inox | 15061142 | stuk | 322,00 | 169 | 1 |
| |  | | | | | | | |
| | 2-weg inbouwbadkraan 1/2" cartouche=Ø35mm compleet; inbouw + afbouwdeel | | | | | | | |
| | 0462675 | | chroom | 15067031 | stuk | 351,00 | 169 | 1 |
| | 0463760 | | inox | 15067142 | stuk | 474,00 | 169 | 1 |
| |  | | | | | | | |
| | afbouwdeel v. 2-weg inbouwbadkraan | | | | | | | |
| | 0460714 | | chroom | 15079031 | stuk | 234,00 | 169 | 1 |
| | 0460715 | | inox | 15079142 | stuk | 356,00 | 169 | 1 |
| |  | | | | | | | |
| | inbouwstopkraan 1/2" compleet; inbouw + afbouwdeel | | | | | | | |
| | 0464007 | | chroom | 15118031 | stuk | 134,00 | 169 | 1 |
| | 0464015 | | inox | 15118142 | stuk | 181,00 | 169 | 1 |
| |  | | | | | | | |

| Art.nr | Specificaties | Kleur | Lev.nr | Ehd | Prijs | Grp | CC | | |
|---|---------------|--------|----------|------|--------|-----|----|---|---|
| | | | | | | | | Gessi Rettangolo | |
| 1-gats wastafelkraan m. waste | | | | | | | | | |
| 0463192 | | chroom | 20001031 | stuk | 308,00 | 169 | 0 |  | Sanitair producten |
| 0463314 | | inox | 20001142 | stuk | 401,00 | 169 | 0 | | |
| 1-gats wastafelkraan verhoogd draaibaar uitloop=125mm m. waste | | | | | | | | | |
| 0463194 | | chroom | 11921031 | stuk | 373,00 | 169 | 1 |  | Baden / douchebakken / stoomcabines |
| 0463315 | | inox | 11921142 | stuk | 485,00 | 169 | 1 | | |
| 1-gats wastafelkraan m. verhoogde uitloop=210mm m. waste | | | | | | | | | |
| 0463196 | | chroom | 11923031 | stuk | 373,00 | 169 | 1 |  | Douchegarnituur |
| 0463316 | | inox | 11923142 | stuk | 485,00 | 169 | 1 | | |
| kraan z. uitloop v. wastafel | | | | | | | | | |
| 0463198 | | chroom | 20005031 | stuk | 146,00 | 169 | 1 |  | Douchewanden |
| 0463317 | | inox | 20005142 | stuk | 190,00 | 169 | 1 | | |
| wanduitloop voor wastafel | | | | | | | | | |
| 0463207 | 21.2cm | chroom | 20100031 | stuk | 184,00 | 169 | 1 |  | Toebehoren & afvoeren |
| 0463322 | 21.2cm | inox | 20100142 | stuk | 238,00 | 169 | 1 | | |
| uitloop v. bladmontage | | | | | | | | | |
| 0463200 | hoog 30.8cm | chroom | 20091031 | stuk | 343,00 | 169 | 1 |  | Badkamermeubelen en toiletkasten |
| 0463318 | hoog 30.8cm | inox | 20091142 | stuk | 445,00 | 169 | 1 | | |
| vloeruitloop | | | | | | | | | |
| 0463202 | hoog 115.1cm | chroom | 20095031 | stuk | 653,00 | 169 | 1 |  | Gootstenen en wastroggen |
| 0463319 | hoog 115.1cm | inox | 20095142 | stuk | 849,00 | 169 | 1 | | |
| plafonduitloop | | | | | | | | | |
| 0463204 | lang 160cm | chroom | 20099031 | stuk | 514,00 | 169 | 1 |  | Utiliteit |
| 0463320 | lang 160cm | inox | 20099142 | stuk | 668,00 | 169 | 1 | | |
| 2-gats inbouwwandkraan compleet; inbouwdeel + afbouwdeel | | | | | | | | | |
| 0463206 | | chroom | 20085031 | stuk | 454,00 | 169 | 1 |  | |
| 0463321 | | inox | 20085142 | stuk | 590,00 | 169 | 1 | | |

| Art.nr | Specificaties | Kleur | Lev.nr | Ehd | Prijs | Grp | CC |
|--------|---------------|-------|--------|-----|-------|-----|----|
|--------|---------------|-------|--------|-----|-------|-----|----|

Gessi Rettangolo

afbouwdeel v. 2-gats inbouwwandkraan

| | | | | | | | |
|---------|--|--------|----------|------|--------|-----|---|
| 0460987 | | chroom | 20088031 | stuk | 323,00 | 169 | 1 |
| 0460988 | | inox | 20088142 | stuk | 459,00 | 169 | 1 |



Sanitair producten

Baden /
douchebakken /
stoomcabines

inbouwwastafelkraan z. uitloop compleet; inbouwdeel + afbouwdeel

| | | | | | | | |
|---------|--|--------|----------|------|--------|-----|---|
| 0463208 | | chroom | 20106031 | stuk | 249,00 | 169 | 1 |
| 0463323 | | inox | 20106142 | stuk | 323,00 | 169 | 1 |



Kranen

Douchegarnituur

afbouwdeel v. inbouwwastafelkraan z. uitloop

| | | | | | | | |
|---------|--|--------|----------|------|--------|-----|---|
| 0460989 | | chroom | 20109031 | stuk | 158,00 | 169 | 1 |
| 0460991 | | inox | 20109142 | stuk | 232,00 | 169 | 1 |



Accessoires en
spiegels

Douchewanden

1-gats bidetkraan m. waste

| | | | | | | | |
|---------|--|--------|----------|------|--------|-----|---|
| 0463209 | | chroom | 20007031 | stuk | 308,00 | 169 | 1 |
| 0463324 | | inox | 20007142 | stuk | 401,00 | 169 | 1 |



Toebehoren &
afvoeren

Spoel- &
installatiesystemen

badkraan m. omstel z. garnituur

| | | | | | | | |
|---------|--|--------|----------|------|--------|-----|---|
| 0463210 | | chroom | 20013031 | stuk | 509,00 | 169 | 1 |
| 0463325 | | inox | 20013142 | stuk | 662,00 | 169 | 1 |



Badkamermeubelen
en toiletkasten

badkraan m. omstel m. slang 150cm m. handdouche

| | | | | | | | |
|---------|-----------------------|--------|----------|------|--------|-----|---|
| 0463211 | m. houder vast | chroom | 20019031 | stuk | 680,00 | 169 | 0 |
| 0463326 | m. houder vast | inox | 20019142 | stuk | 883,00 | 169 | 1 |
| 0463212 | m. houder verstelbaar | chroom | 20025031 | stuk | 757,00 | 169 | 1 |
| 0463327 | m. houder verstelbaar | inox | 20025142 | stuk | 984,00 | 169 | 1 |



Gootstenen en
wastroggen

Utiliteit



slangdoorvoer voor bad

| | | | | | | | |
|---------|--|--------|---------|------|-------|-----|---|
| 0463193 | | chroom | 1487031 | stuk | 62,50 | 169 | 1 |
| 0463195 | | inox | 1487142 | stuk | 78,00 | 169 | 1 |



badthermostaat m. omstel z. garnituur

| | | | | | | | |
|---------|--|--------|----------|------|--------|-----|---|
| 0463214 | | chroom | 20111031 | stuk | 556,00 | 169 | 0 |
| 0463328 | | inox | 20111142 | stuk | 723,00 | 169 | 1 |



| Art.nr | Specificaties | Kleur | Lev.nr | Ehd | Prijs | Grp | CC |
|--------|---------------|-------|--------|-----|-------|-----|----|
|--------|---------------|-------|--------|-----|-------|-----|----|

Gessi Rettangolo

badthermostaat m. omstel m. slang 150cm m. handdouche

| | | | | | | | |
|---------|-----------------------|--------|----------|------|---------|-----|---|
| 0463215 | m. houder vast | chroom | 20113031 | stuk | 727,00 | 169 | 0 |
| 0463330 | m. houder vast | inox | 20113142 | stuk | 944,00 | 169 | 1 |
| 0463216 | m. houder verstelbaar | chroom | 20115031 | stuk | 804,00 | 169 | 1 |
| 0463331 | m. houder verstelbaar | inox | 20115142 | stuk | 1046,00 | 169 | 1 |



Sanitair producten

Baden /
douchebakken /
stoomcabines

Kranen

3-gats badkraan m. uitloop m. slang m. handdouche

| | | | | | | | |
|---------|--|--------|----------|------|--------|-----|---|
| 0463217 | | chroom | 20037031 | stuk | 693,00 | 169 | 0 |
| 0463332 | | inox | 20037142 | stuk | 901,00 | 169 | 1 |



Douchegarnituur

Accessoires en
spiegels**3-gats badkraan z. uitloop m. slang m. handdouche**

| | | | | | | | |
|---------|--|--------|----------|------|--------|-----|---|
| 0463218 | | chroom | 20043031 | stuk | 622,00 | 169 | 1 |
| 0463333 | | inox | 20043142 | stuk | 809,00 | 169 | 1 |



Douchewanden

baduitloop

| | | | | | | | |
|---------|--|--------|----------|------|--------|-----|---|
| 0463303 | | chroom | 20103031 | stuk | 184,00 | 169 | 1 |
| 0463405 | | inox | 20103142 | stuk | 238,00 | 169 | 1 |

Toebehoren &
afvoerenSpoel- &
installatiesystemen**staande gebogen baduitloop**

| | | | | | | | |
|---------|--|--------|----------|------|--------|-----|---|
| 0461024 | | chroom | 20187031 | stuk | 348,00 | 169 | 1 |
| 0461025 | | inox | 20187142 | stuk | 452,00 | 169 | 1 |

Badkamermeubelen
en toiletkasten**3-gats badrandcombinatie m. vloeruitloop**

| | | | | | | | |
|---------|--|--------|----------|------|---------|-----|---|
| 0461026 | | chroom | 20039031 | stuk | 1455,00 | 169 | 1 |
| 0461027 | | inox | 20039142 | stuk | 1891,00 | 169 | 1 |

Gootstenen en
wastroggen

Utiliteit

staande badkraan met garnituur; inbouwdeel en afbouwdeel

| | | | | | | | |
|---------|------------|--------|----------|------|---------|-----|---|
| 0461028 | hoog 107cm | chroom | 24925031 | stuk | 1369,00 | 169 | 1 |
| 0461029 | hoog 107cm | inox | 24925142 | stuk | 1779,00 | 169 | 1 |

**afbouwdeel v. staande badkraan**

| | | | | | | | |
|---------|------------|--------|----------|------|---------|-----|---|
| 0461030 | hoog 107cm | chroom | 24928031 | stuk | 1213,00 | 169 | 1 |
| 0461031 | hoog 107cm | inox | 24928142 | stuk | 1624,00 | 169 | 1 |



| | Art.nr | Specificaties | Kleur | Lev.nr | Ehd | Prijs | Grp | CC |
|---|--|---------------|-------|----------|------|---------|-----|----|
| | Gessi Rettangolo | | | | | | | |
| Sanitair producten | doucheuitloop | | | | | | | |
| | 0463304 | | chrom | 20104031 | stuk | 184,00 | 169 | 1 |
| | 0463406 | | inox | 20104142 | stuk | 238,00 | 169 | 1 |
| Baden / douchebakken / stoomcabines | | | | | | | | |
| Kranen | douchekraan z. omstel | | | | | | | |
| | 0463306 | | chrom | 20031031 | stuk | 424,00 | 169 | 1 |
| | 0463408 | | inox | 20031142 | stuk | 551,00 | 169 | 1 |
| Douchegarnituur | | | | | | | | |
| | 1-weg inbouwdouchekraan 1/2" compleet; inbouw + afbouwdeel | | | | | | | |
| | 0463425 | | chrom | 20049031 | stuk | 296,00 | 169 | 1 |
| | 0463427 | | inox | 20049142 | stuk | 385,00 | 169 | 1 |
| Accessoires en spiegels | | | | | | | | |
| Douchewanden | afbouwdeel v. 1-weg inbouwdouchekraan | | | | | | | |
| | 0460992 | | chrom | 20061031 | stuk | 205,00 | 169 | 1 |
| | 0460993 | | inox | 20061142 | stuk | 294,00 | 169 | 1 |
| Toebehoren & afvoeren | | | | | | | | |
| Spoel- & installatiesystemen | douchethermostaat | | | | | | | |
| | 0463071 | | chrom | 19431031 | stuk | 479,00 | 169 | 0 |
| | 0463072 | | inox | 19431142 | stuk | 647,00 | 169 | 0 |
| Badkamermeubelen en toiletkasten | | | | | | | | |
| Gootstenen en wastroggen | 2-weg inbouwbadkraan 1/2" compleet; inbouwdeel + afbouwdeel | | | | | | | |
| | 0463428 | | chrom | 20067031 | stuk | 336,00 | 169 | 1 |
| | 0463429 | | inox | 20067142 | stuk | 436,00 | 169 | 1 |
| Utiliteit | | | | | | | | |
| | afbouwdeel v. 2-weg inbouwbadkraan | | | | | | | |
| | 0460994 | | chrom | 20079031 | stuk | 218,00 | 169 | 1 |
| | 0460995 | | inox | 20079142 | stuk | 319,00 | 169 | 1 |
| | douchethermostaat m. hoofddouche h=177.4cm | | | | | | | |
| | 0463225 | | chrom | 23401031 | stuk | 1685,00 | 169 | 1 |
| | 0463340 | | inox | 23401142 | stuk | 2191,00 | 169 | 1 |
| | douchethermostaat m. hoofddouche h=117cm | | | | | | | |
| | 0463421 | | chrom | 23403031 | stuk | 1429,00 | 169 | 1 |
| | 0463422 | | inox | 23403142 | stuk | 1857,00 | 169 | 1 |

| Art.nr | Specificaties | Kleur | Lev.nr | Ehd | Prijs | Grp | CC |
|--------|---------------|-------|--------|-----|-------|-----|----|
|--------|---------------|-------|--------|-----|-------|-----|----|

Gessi Rettangolo

douchethermostaat m. hoofddouche h=177.4cm m. garnituur

| | | | | | | | |
|---------|--------|----------|------|---------|-----|---|---|
| 0463226 | chroom | 23405031 | stuk | 2010,00 | 169 | 1 |  |
| 0463341 | inox | 23405142 | stuk | 2613,00 | 169 | 1 | |

Sanitair producten

Baden /
douchebakken /
stoomcabines**douchethermostaat m. hoofddouche h=117cm m. garnituur**

| | | | | | | | |
|---------|--------|----------|------|---------|-----|---|---|
| 0463227 | chroom | 23407031 | stuk | 1754,00 | 169 | 1 |  |
| 0463342 | inox | 23407142 | stuk | 2280,00 | 169 | 1 | |

Kranen

Douchegarnituur

douchethermostaat m. hoofddouche h=177.4cm m. garnituur verstelbaar

| | | | | | | | |
|---------|--------|----------|------|---------|-----|---|---|
| 0463228 | chroom | 23409031 | stuk | 2139,00 | 169 | 0 |  |
| 0463343 | inox | 23409142 | stuk | 2780,00 | 169 | 1 | |

Accessoires en
spiegels**douchethermostaat m. hoofddouche h=117cm m. garnituur verstelbaar**

| | | | | | | | |
|---------|--------|----------|------|---------|-----|---|---|
| 0463423 | chroom | 23411031 | stuk | 1882,00 | 169 | 1 |  |
| 0463424 | inox | 23411142 | stuk | 2446,00 | 169 | 1 | |

Douchewanden

Toebehoren &
afvoeren**douchethermostaat m. hoofddouche h=107.4cm m. garnituur verstelbaar**

| | | | | | | | |
|---------|--------|----------|------|---------|-----|---|---|
| 0461014 | chroom | 23451031 | stuk | 1882,00 | 169 | 1 |  |
| 0461015 | inox | 23451142 | stuk | 2446,00 | 169 | 1 | |

Spoel- &
installatiesystemenBadkamermeubelen
en toiletkasten**douchethermostaat m. hoofddouche h=107.4cm m. garnituur**

| | | | | | | | |
|---------|--------|----------|------|---------|-----|---|---|
| 0461016 | chroom | 23447031 | stuk | 1754,00 | 169 | 1 |  |
| 0461017 | inox | 23447142 | stuk | 2280,00 | 169 | 1 | |

Gootstenen en
wastroggen

Utiliteit

1-weg inbouwthermostaat m. aansluitingen 1/2" compleet; inbouw + afbouwdeel

| | | | | | | | |
|---------|--------|----------|------|--------|-----|---|---|
| 0463430 | chroom | 20131031 | stuk | 619,00 | 169 | 1 |  |
| 0463431 | inox | 20131142 | stuk | 823,00 | 169 | 1 | |

2-weg inbouwthermostaat m. aansluitingen 1/2" compleet; inbouw + afbouwdeel

| | | | | | | | |
|---------|--------|----------|------|--------|-----|---|---|
| 0463432 | chroom | 20133031 | stuk | 674,00 | 169 | 0 |  |
| 0463433 | inox | 20133142 | stuk | 877,00 | 169 | 1 | |

3-weg inbouwthermostaat m. aansluitingen 1/2" compleet; inbouw + afbouwdeel

| | | | | | | | |
|---------|--------|----------|------|--------|-----|---|---|
| 0463435 | chroom | 20135031 | stuk | 703,00 | 169 | 1 |  |
| 0463436 | inox | 20135142 | stuk | 907,00 | 169 | 1 | |

| Art.nr | Specificaties | Kleur | Lev.nr | Ehd | Prijs | Grp | CC |
|--------|---------------|-------|--------|-----|-------|-----|----|
|--------|---------------|-------|--------|-----|-------|-----|----|

Gessi Rettangolo

afbouwdeel v. 1-weg inbouwthermostaat

| | | | | | | | |
|---------|--|--------|----------|------|--------|-----|---|
| 0460716 | | chroom | 20132031 | stuk | 376,00 | 169 | 1 |
| 0460717 | | inox | 20132142 | stuk | 580,00 | 169 | 1 |



Sanitair producten

Baden /
douchebakken /
stoomcabines

afbouwdeel v. 2-weg inbouwthermostaat

| | | | | | | | |
|---------|--|--------|----------|------|--------|-----|---|
| 0460998 | | chroom | 20134031 | stuk | 376,00 | 169 | 1 |
| 0460999 | | inox | 20134142 | stuk | 580,00 | 169 | 1 |



Kranen

Douchegarnituur

afbouwdeel v. 3-weg inbouwthermostaat

| | | | | | | | |
|---------|--|--------|----------|------|--------|-----|---|
| 0460720 | | chroom | 20136031 | stuk | 376,00 | 169 | 1 |
| 0460721 | | inox | 20136142 | stuk | 580,00 | 169 | 1 |



Accessoires en
spiegels

Douchewanden

designsifon vierhoekig 5/4"

| | | | | | | | |
|---------|----------------------|--------|---------|------|--------|-----|---|
| 0463313 | m. muurbuis m. rozet | chroom | 1410031 | stuk | 206,00 | 169 | 0 |
| 0463413 | m. muurbuis m. rozet | inox | 1410142 | stuk | 276,00 | 169 | 1 |



Toebehoren &
afvoeren

inbouwstopkraan 1/2" compleet; inbouw + afbouwdeel

| | | | | | | | |
|---------|--|--------|----------|------|--------|-----|---|
| 0463437 | | chroom | 20163031 | stuk | 151,00 | 169 | 1 |
| 0463438 | | inox | 20163142 | stuk | 196,00 | 169 | 1 |



Spoel- &
installatiesystemen

Badkamermeubelen
en toiletkasten

afbouwdeel v. inbouwstopkraan

| | | | | | | | |
|---------|--|--------|----------|------|--------|-----|---|
| 0461002 | | chroom | 20166031 | stuk | 104,00 | 169 | 1 |
| 0461003 | | inox | 20166142 | stuk | 149,00 | 169 | 1 |



Gootstenen en
wastroggen

hoekstopkraan 4-hoekig 1/2"

| | | | | | | | |
|---------|--|--------|---------|------|--------|-----|---|
| 0463439 | | chroom | 1412031 | stuk | 102,00 | 169 | 0 |
| 0463440 | | inox | 1412142 | stuk | 146,00 | 169 | 1 |



Utiliteit

Gessi Rettangolo C

3-gats wastafelkraan m. uitloop hoekig 95mm

| | | | | | | | |
|---------|--|--------|----------|------|--------|-----|---|
| 0463505 | | chroom | 21801031 | stuk | 455,00 | 169 | 1 |
| 0463506 | | inox | 21801142 | stuk | 591,00 | 169 | 1 |



3-gats wastafelkraan m. waste m. uitloop hoekig 15x15cm

| | | | | | | | |
|---------|--|--------|----------|------|--------|-----|---|
| 0463508 | | chroom | 21802031 | stuk | 462,00 | 169 | 1 |
| 0463509 | | inox | 21802142 | stuk | 601,00 | 169 | 1 |



3-gats wastafelkraan m. waste m. uitloop hoekig 15x21cm

| | | | | | | | |
|---------|--|--------|----------|------|--------|-----|---|
| 0463510 | | chroom | 21803031 | stuk | 472,00 | 169 | 1 |
| 0463511 | | inox | 21803142 | stuk | 614,00 | 169 | 1 |



| Art.nr | Specificaties | Kleur | Lev.nr | Ehd | Prijs | Grp | CC |
|--------|---------------|-------|--------|-----|-------|-----|----|
|--------|---------------|-------|--------|-----|-------|-----|----|

Gessi Rettangolo C

3-gats wastafelkraan m. waste m. uitloop hoekig 30x21cm

| | | | | | | | |
|---------|--|--------|----------|------|--------|-----|---|
| 0463512 | | chroom | 21805031 | stuk | 517,00 | 169 | 1 |
| 0463513 | | inox | 21805142 | stuk | 672,00 | 169 | 1 |



Sanitair producten

Baden /
douchebakken /
stoomcabines**3-gats wastafelkraan m. waste m. uitloop rond 25cm**

| | | | | | | | |
|---------|--|--------|----------|------|--------|-----|---|
| 0463514 | | chroom | 21806031 | stuk | 485,00 | 169 | 1 |
| 0463516 | | inox | 21806142 | stuk | 631,00 | 169 | 1 |



Kranen

3-gats wastafelkraan m. waste m. uitloop rond 40cm

| | | | | | | | |
|---------|--|--------|----------|------|--------|-----|---|
| 0463517 | | chroom | 21807031 | stuk | 501,00 | 169 | 1 |
| 0463518 | | inox | 21807142 | stuk | 652,00 | 169 | 1 |



Douchegarnituur

Accessoires en
spiegels**hendels voor kraan los**

| | | | | | | | |
|---------|--|--------|----------|------|--------|-----|---|
| 0463519 | | chroom | 21808031 | stuk | 235,00 | 169 | 1 |
| 0463520 | | inox | 21808142 | stuk | 305,00 | 169 | 1 |



Douchewanden

3-gats inbouwwandkraan compleet; inbouwdeel + afbouwdeel

| | | | | | | | |
|---------|--|--------|----------|------|--------|-----|---|
| 0463521 | | chroom | 21785031 | stuk | 472,00 | 169 | 1 |
| 0463522 | | inox | 21785142 | stuk | 614,00 | 169 | 1 |

Toebehoren &
afvoerenSpoel- &
installatiesystemen**afbouwdeel v. 3-gats inbouwwandkraan**

| | | | | | | | |
|---------|--|--------|----------|------|--------|-----|---|
| 0461045 | | chroom | 21788031 | stuk | 338,00 | 169 | 1 |
| 0461046 | | inox | 21788142 | stuk | 479,00 | 169 | 1 |

Badkamermeubelen
en toiletkastenGootstenen en
wastroggen**3-gats bidetkraan m. waste m. uitloop**

| | | | | | | | |
|---------|--|--------|----------|------|--------|-----|---|
| 0463524 | | chroom | 21817031 | stuk | 436,00 | 169 | 1 |
| 0463525 | | inox | 21817142 | stuk | 567,00 | 169 | 1 |



Utiliteit

badkraan m. omstel z. garnituur

| | | | | | | | |
|---------|--|--------|----------|------|--------|-----|---|
| 0463528 | | chroom | 21713031 | stuk | 462,00 | 169 | 1 |
| 0463529 | | inox | 21713142 | stuk | 601,00 | 169 | 1 |

**badkraan m. omstel m. slang 150cm m. handdouche**

| | | | | | | | |
|---------|-----------------------|--------|----------|------|--------|-----|---|
| 0463530 | m. houder vast | chroom | 21719031 | stuk | 625,00 | 169 | 1 |
| 0463532 | m. houder vast | inox | 21719142 | stuk | 812,00 | 169 | 1 |
| 0463533 | m. houder verstelbaar | chroom | 21725031 | stuk | 702,00 | 169 | 1 |
| 0463534 | m. houder verstelbaar | inox | 21725142 | stuk | 912,00 | 169 | 1 |

**4-gats badrandcombinatie m. uitloop m. slang m. handdouche**

| | | | | | | | |
|---------|--|--------|----------|------|--------|-----|---|
| 0463535 | | chroom | 21737031 | stuk | 697,00 | 169 | 1 |
| 0463536 | | inox | 21737142 | stuk | 906,00 | 169 | 1 |



| Art.nr | Specificaties | Kleur | Lev.nr | Ehd | Prijs | Grp | CC |
|--------|---------------|-------|--------|-----|-------|-----|----|
|--------|---------------|-------|--------|-----|-------|-----|----|

Gessi Rettangolo C

4-gats badkraan voor badvulcombinatie z. uitloop m. slang m. handdouche

| | | | | | | | |
|---------|--|--------|----------|------|--------|-----|---|
| 0463537 | | chroom | 21743031 | stuk | 637,00 | 169 | 1 |
| 0463538 | | inox | 21743142 | stuk | 828,00 | 169 | 1 |



Sanitair producten

Baden /
douchebakken /
stoomcabines

douchekraan z. omstel

| | | | | | | | |
|---------|--|--------|----------|------|--------|-----|---|
| 0463539 | | chroom | 21731031 | stuk | 377,00 | 169 | 1 |
| 0463540 | | inox | 21731142 | stuk | 490,00 | 169 | 1 |



Kranen

Gessi Rettangolo J

1-gats wastafelkraan m. waste

| | | | | | | | |
|---------|--|--------|----------|------|--------|-----|---|
| 0463441 | | chroom | 20601031 | stuk | 308,00 | 169 | 0 |
| 0463443 | | inox | 20601142 | stuk | 401,00 | 169 | 1 |



Douchegarnituur

Accessoires en
spiegels

1-gats wastafelkraan verhoogd draaibaar uitloop=125mm m. waste

| | | | | | | | |
|---------|--|--------|----------|------|--------|-----|---|
| 0463444 | | chroom | 11925031 | stuk | 373,00 | 169 | 1 |
| 0463445 | | inox | 11925142 | stuk | 485,00 | 169 | 1 |



Douchewanden

1-gats wastafelkraan verhoogd draaibaar uitloop=210mm m. waste

| | | | | | | | |
|---------|--|--------|----------|------|--------|-----|---|
| 0463446 | | chroom | 11927031 | stuk | 373,00 | 169 | 1 |
| 0463447 | | inox | 11927142 | stuk | 485,00 | 169 | 1 |



Toebehoren &
afvoeren

Spoel- &
installatiesystemen

wastafelkraan vrijstaand hoogte=1meter

| | | | | | | | |
|---------|--|--------|----------|------|---------|-----|---|
| 0463448 | | chroom | 20603031 | stuk | 1053,00 | 169 | 1 |
| 0463449 | | inox | 20603142 | stuk | 1316,00 | 169 | 1 |



Badkamermeubelen
en toiletkasten

Gootstenen en
wastroggen

hendel voor wastafelkraan

| | | | | | | | |
|---------|--|--------|----------|------|--------|-----|---|
| 0463451 | | chroom | 20605031 | stuk | 146,00 | 169 | 1 |
| 0463452 | | inox | 20605142 | stuk | 190,00 | 169 | 1 |



Utiliteit

uitloop v. bladmontage







| | | | | | | | |
|---------|-------------|--------|----------|------|--------|-----|---|
| 0463200 | hoog 30.8cm | chroom | 20091031 | stuk | 343,00 | 169 | 1 |
| 0463318 | hoog 30.8cm | inox | 20091142 | stuk | 445,00 | 169 | 1 |



vloeruitloop

| | | | | | | | |
|---------|--------------|--------|----------|------|--------|-----|---|
| 0463202 | hoog 115.1cm | chroom | 20095031 | stuk | 653,00 | 169 | 1 |
| 0463319 | hoog 115.1cm | inox | 20095142 | stuk | 849,00 | 169 | 1 |



| Art.nr | Specificaties | Kleur | Lev.nr | Ehd | Prijs | Grp | CC | | |
|---|---------------|--------|----------|------|--------|-----|----|---|---|
| | | | | | | | | Gessi Rettangolo J | |
| plafonduitloop | | | | | | | | | |
| 0463204 | lang 160cm | chroom | 20099031 | stuk | 514,00 | 169 | 1 |  | Sanitair producten |
| 0463320 | lang 160cm | inox | 20099142 | stuk | 668,00 | 169 | 1 | | Baden / douchebakken / stoomcabines |
| 2-gats inbouwwandkraan compleet; inbouwdeel + afbouwdeel | | | | | | | | | |
| 0463453 | | chroom | 20685031 | stuk | 454,00 | 169 | 1 |  | Kranen |
| 0463454 | | inox | 20685142 | stuk | 590,00 | 169 | 1 | | |
| afbouwdeel v. 2-gats inbouwwandkraan | | | | | | | | | |
| 0461018 | | chroom | 20688031 | stuk | 323,00 | 169 | 1 |  | Douchegarnituur |
| 0461019 | | inox | 20688142 | stuk | 459,00 | 169 | 1 | | Accessoires en spiegels |
| inbouwdeel v. 2-gats inbouwwandkraan | | | | | | | | | |
| 0461020 | | | 20697031 | stuk | 132,00 | 169 | 1 | | Douchewanden |
| wanduitloop voor wastafel | | | | | | | | | |
| 0463207 | 21.2cm | chroom | 20100031 | stuk | 184,00 | 169 | 1 |  | Toebehoren & afvoeren |
| 0463322 | 21.2cm | inox | 20100142 | stuk | 238,00 | 169 | 1 | | |
| inbouwwastafelkraan z. uitloop compleet; inbouwdeel + afbouwdeel | | | | | | | | | |
| 0463455 | | chroom | 20706031 | stuk | 249,00 | 169 | 1 |  | Spoel- & installatiesystemen |
| 0463456 | | inox | 20706142 | stuk | 323,00 | 169 | 1 | | |
| afbouwdeel v. inbouwwastafelkraan z. uitloop | | | | | | | | | |
| 0461021 | | chroom | 20709031 | stuk | 158,00 | 169 | 1 |  | Gootstenen en wastroggen |
| 0461022 | | inox | 20709142 | stuk | 232,00 | 169 | 1 | | |
| inbouwdeel v. inbouwwastafelkraan z. uitloop | | | | | | | | | |
| 0461023 | | | 20712031 | stuk | 91,00 | 169 | 1 |  | Utiliteit |
| 1-gats bidetkraan m. waste | | | | | | | | | |
| 0463457 | | chroom | 20607031 | stuk | 308,00 | 169 | 1 |  | |
| 0463458 | | inox | 20607142 | stuk | 401,00 | 169 | 1 | | |
| badkraan m. omstel z. garnituur | | | | | | | | | |
| 0463210 | | chroom | 20013031 | stuk | 509,00 | 169 | 1 |  | |
| 0463325 | | inox | 20013142 | stuk | 662,00 | 169 | 1 | | |

| Art.nr | Specificaties | Kleur | Lev.nr | Ehd | Prijs | Grp | CC |
|--------|---------------|-------|--------|-----|-------|-----|----|
|--------|---------------|-------|--------|-----|-------|-----|----|

Gessi Rettangolo J

badkraan m. omstel m. slang 150cm m. handdouche

| | | | | | | | |
|---------|-----------------------|--------|----------|------|--------|-----|---|
| 0463211 | m. houder vast | chroom | 20019031 | stuk | 680,00 | 169 | 0 |
| 0463326 | m. houder vast | inox | 20019142 | stuk | 883,00 | 169 | 1 |
| 0463212 | m. houder verstelbaar | chroom | 20025031 | stuk | 757,00 | 169 | 1 |
| 0463327 | m. houder verstelbaar | inox | 20025142 | stuk | 984,00 | 169 | 1 |



Sanitair producten

Baden /
douchebakken /
stoomcabines

Kranen

badthermostaat m. omstel z. garnituur

| | | | | | | | |
|---------|--|--------|----------|------|--------|-----|---|
| 0463214 | | chroom | 20111031 | stuk | 556,00 | 169 | 0 |
| 0463328 | | inox | 20111142 | stuk | 723,00 | 169 | 1 |



Douchegarnituur

Accessoires en
spiegels

badthermostaat m. omstel m. slang 150cm m. handdouche

| | | | | | | | |
|---------|-----------------------|--------|----------|------|---------|-----|---|
| 0463215 | m. houder vast | chroom | 20113031 | stuk | 727,00 | 169 | 0 |
| 0463330 | m. houder vast | inox | 20113142 | stuk | 944,00 | 169 | 1 |
| 0463216 | m. houder verstelbaar | chroom | 20115031 | stuk | 804,00 | 169 | 1 |
| 0463331 | m. houder verstelbaar | inox | 20115142 | stuk | 1046,00 | 169 | 1 |



Douchewanden

Toebehoren &
afvoeren



Spoel- &
installatiesystemen

3-gats badkraan m. uitloop m. slang m. handdouche

| | | | | | | | |
|---------|--|--------|----------|------|--------|-----|---|
| 0463217 | | chroom | 20037031 | stuk | 693,00 | 169 | 0 |
| 0463332 | | inox | 20037142 | stuk | 901,00 | 169 | 1 |



Badkamermeubelen
en toiletkasten

Gootstenen en
wastroggen

3-gats badkraan z. uitloop m. slang m. handdouche

| | | | | | | | |
|---------|--|--------|----------|------|--------|-----|---|
| 0463218 | | chroom | 20043031 | stuk | 622,00 | 169 | 1 |
| 0463333 | | inox | 20043142 | stuk | 809,00 | 169 | 1 |



Utiliteit

douchethermostaat m. hoofddouche h=177.4cm









| | | | | | | | |
|---------|--|--------|----------|------|---------|-----|---|
| 0463225 | | chroom | 23401031 | stuk | 1685,00 | 169 | 1 |
| 0463340 | | inox | 23401142 | stuk | 2191,00 | 169 | 1 |



douchethermostaat m. hoofddouche h=177.4cm m. garnituur

| | | | | | | | |
|---------|--|--------|----------|------|---------|-----|---|
| 0463226 | | chroom | 23405031 | stuk | 2010,00 | 169 | 1 |
| 0463341 | | inox | 23405142 | stuk | 2613,00 | 169 | 1 |



| Art.nr | Specificaties | Kleur | Lev.nr | Ehd | Prijs | Grp | CC | | |
|--|---------------|--------|----------|------|---------|-----|----|---|---|
| | | | | | | | | Gessi Rettangolo J | |
| douchethermostaat m. hoofddouche h=117cm m. garnituur | | | | | | | | | |
| 0463227 | | chroom | 23407031 | stuk | 1754,00 | 169 | 1 |  | Sanitair producten |
| 0463342 | | inox | 23407142 | stuk | 2280,00 | 169 | 1 | | |
| douchethermostaat m. hoofddouche h=177.4cm m. garnituur verstelbaar | | | | | | | | | |
| 0463228 | | chroom | 23409031 | stuk | 2139,00 | 169 | 0 |  | Baden / douchebakken / stoomcabines |
| 0463343 | | inox | 23409142 | stuk | 2780,00 | 169 | 1 | | |
| douchethermostaat m. hoofddouche h=117cm | | | | | | | | | |
| 0463421 | | chroom | 23403031 | stuk | 1429,00 | 169 | 1 |  | Douchegarnituur |
| 0463422 | | inox | 23403142 | stuk | 1857,00 | 169 | 1 | | |
| douchethermostaat m. hoofddouche h=117cm m. garnituur verstelbaar | | | | | | | | | |
| 0463423 | | chroom | 23411031 | stuk | 1882,00 | 169 | 1 |  | Accessoires en spiegels |
| 0463424 | | inox | 23411142 | stuk | 2446,00 | 169 | 1 | | |
| baduitloop | | | | | | | | | |
| 0463303 | | chroom | 20103031 | stuk | 184,00 | 169 | 1 |  | Douchewanden |
| 0463405 | | inox | 20103142 | stuk | 238,00 | 169 | 1 | | |
| doucheuitloop | | | | | | | | | |
| 0463304 | | chroom | 20104031 | stuk | 184,00 | 169 | 1 |  | Toebehoren & afvoeren |
| 0463406 | | inox | 20104142 | stuk | 238,00 | 169 | 1 | | |
| douchekraan z. omstel | | | | | | | | | |
| 0463306 | | chroom | 20031031 | stuk | 424,00 | 169 | 1 |  | Spoel- & installatiesystemen |
| 0463408 | | inox | 20031142 | stuk | 551,00 | 169 | 1 | | |
| douchethermostaat | | | | | | | | | |
| 0463071 | | chroom | 19431031 | stuk | 479,00 | 169 | 0 |  | Badkamermeubelen en toiletkasten |
| 0463072 | | inox | 19431142 | stuk | 647,00 | 169 | 0 | | |
| 1-weg inbouwdouchekraan 1/2" compleet; inbouw + afbouwdeel | | | | | | | | | |
| 0463425 | | chroom | 20049031 | stuk | 296,00 | 169 | 1 |  | Gootstenen en wastroggen |
| 0463427 | | inox | 20049142 | stuk | 385,00 | 169 | 1 | | |
| Utiliteit | | | | | | | | | |

| Art.nr | Specificaties | Kleur | Lev.nr | Ehd | Prijs | Grp | CC |
|--------|---------------|-------|--------|-----|-------|-----|----|
|--------|---------------|-------|--------|-----|-------|-----|----|

Gessi Rettangolo J

2-weg inbouwbadkraan 1/2" compleet; inbouwdeel + afbouwdeel

| | | | | | | | |
|---------|--|--------|----------|------|--------|-----|---|
| 0463428 | | chroom | 20067031 | stuk | 336,00 | 169 | 1 |
| 0463429 | | inox | 20067142 | stuk | 436,00 | 169 | 1 |



Sanitair producten

Baden /
douchebakken /
stoomcabines

1-weg inbouwthermostaat m. aansluitingen 1/2" compleet; inbouw + afbouwdeel

| | | | | | | | |
|---------|--|--------|----------|------|--------|-----|---|
| 0463430 | | chroom | 20131031 | stuk | 619,00 | 169 | 1 |
| 0463431 | | inox | 20131142 | stuk | 823,00 | 169 | 1 |



Kranen

Douchegarnituur

2-weg inbouwthermostaat m. aansluitingen 1/2" compleet; inbouw + afbouwdeel

| | | | | | | | |
|---------|--|--------|----------|------|--------|-----|---|
| 0463432 | | chroom | 20133031 | stuk | 674,00 | 169 | 0 |
| 0463433 | | inox | 20133142 | stuk | 877,00 | 169 | 1 |



Accessoires en
spiegels

Douchewanden

3-weg inbouwthermostaat m. aansluitingen 1/2" compleet; inbouw + afbouwdeel

| | | | | | | | |
|---------|--|--------|----------|------|--------|-----|---|
| 0463435 | | chroom | 20135031 | stuk | 703,00 | 169 | 1 |
| 0463436 | | inox | 20135142 | stuk | 907,00 | 169 | 1 |



Toebehoren &
afvoeren

inbouwstopkraan 1/2" compleet; inbouw + afbouwdeel

| | | | | | | | |
|---------|--|--------|----------|------|--------|-----|---|
| 0463437 | | chroom | 20163031 | stuk | 151,00 | 169 | 1 |
| 0463438 | | inox | 20163142 | stuk | 196,00 | 169 | 1 |



Spoel- &
installatiesystemen

Badkamermeubelen
en toiletkasten

designsifon vierhoekig 5/4"

| | | | | | | | |
|---------|----------------------|--------|---------|------|--------|-----|---|
| 0463313 | m. muurbuis m. rozet | chroom | 1410031 | stuk | 206,00 | 169 | 0 |
| 0463413 | m. muurbuis m. rozet | inox | 1410142 | stuk | 276,00 | 169 | 1 |



Gootstenen en
wastroggen

hoekstopkraan 4-hoekig 1/2"

| | | | | | | | |
|---------|--|--------|---------|------|--------|-----|---|
| 0463439 | | chroom | 1412031 | stuk | 102,00 | 169 | 0 |
| 0463440 | | inox | 1412142 | stuk | 146,00 | 169 | 1 |



Utiliteit

Gessi Rettangolo P

1-gats wastafelkraan m. waste en gebogen uitloop

| | | | | | | | |
|---------|--|--------|----------|------|--------|-----|---|
| 0461047 | | chroom | 21901031 | stuk | 468,00 | 169 | 1 |
| 0461048 | | inox | 21901142 | stuk | 598,00 | 169 | 1 |



1-gats wastafelkraan m. waste en hoekige uitloop

| | | | | | | | |
|---------|--|--------|----------|------|--------|-----|---|
| 0461049 | | chroom | 21902031 | stuk | 468,00 | 169 | 1 |
| 0461050 | | inox | 21902142 | stuk | 598,00 | 169 | 1 |



| Art.nr | Specificaties | Kleur | Lev.nr | Ehd | Prijs | Grp | CC |
|--------|---------------|-------|--------|-----|-------|-----|----|
|--------|---------------|-------|--------|-----|-------|-----|----|

Gessi Rettangolo P

1-gats wastafelkraan hoog m. waste en gebogen uitloop

| | | | | | | |
|---------|--------|----------|------|--------|-----|---|
| 0461051 | chroom | 21903031 | stuk | 519,00 | 169 | 1 |
| 0461052 | inox | 21903142 | stuk | 675,00 | 169 | 1 |



Sanitair producten

Baden /
douchebakken /
stoomcabines**1-gats wastafelkraan hoog m. waste en hoekige uitloop**

| | | | | | | |
|---------|--------|----------|------|--------|-----|---|
| 0461053 | chroom | 21904031 | stuk | 519,00 | 169 | 1 |
| 0461054 | inox | 21904142 | stuk | 675,00 | 169 | 1 |



Kranen

Douchegarnituur

1-gats bidetkraan m. waste en gebogen uitloop

| | | | | | | |
|---------|--------|----------|------|--------|-----|---|
| 0461055 | chroom | 21907031 | stuk | 468,00 | 169 | 1 |
| 0461056 | inox | 21907142 | stuk | 598,00 | 169 | 1 |

Accessoires en
spiegels**1-gats bidetkraan m. waste en hoekige uitloop**

| | | | | | | |
|---------|--------|----------|------|--------|-----|---|
| 0461057 | chroom | 21908031 | stuk | 468,00 | 169 | 1 |
| 0461058 | inox | 21908142 | stuk | 598,00 | 169 | 1 |



Douchewanden

Toebehoren &
afvoeren**3-gats wastafelkraan m. waste m. gebogen uitloop 25cm**

| | | | | | | |
|---------|--------|----------|------|--------|-----|---|
| 0463541 | chroom | 22001031 | stuk | 485,00 | 169 | 1 |
| 0463542 | inox | 22001142 | stuk | 631,00 | 169 | 1 |

Spoel- &
installatiesystemenBadkamermeubelen
en toiletkasten**3-gats wastafelkraan m. waste m. gebogen uitloop 40cm**

| | | | | | | |
|---------|--------|----------|------|--------|-----|---|
| 0463543 | chroom | 22004031 | stuk | 501,00 | 169 | 1 |
| 0463544 | inox | 22004142 | stuk | 652,00 | 169 | 1 |

Gootstenen en
wastroggen**3-gats wastafelkraan m. hoekige uitloop 15cm**

| | | | | | | |
|---------|--------|----------|------|--------|-----|---|
| 0463545 | chroom | 22002031 | stuk | 462,00 | 169 | 1 |
| 0463546 | inox | 22002142 | stuk | 601,00 | 169 | 1 |



Utiliteit

3-gats wastafelkraan m. hoekige uitloop 33cm

| | | | | | | |
|---------|--------|----------|------|--------|-----|---|
| 0463547 | chroom | 22005031 | stuk | 517,00 | 169 | 1 |
| 0463548 | inox | 22005142 | stuk | 672,00 | 169 | 1 |

**hendels voor kraan los**

| | | | | | | |
|---------|--------|----------|------|--------|-----|---|
| 0463549 | chroom | 22008031 | stuk | 235,00 | 169 | 1 |
| 0463550 | inox | 22008142 | stuk | 305,00 | 169 | 1 |



| | Art.nr | Specificaties | Kleur | Lev.nr | Ehd | Prijs | Grp | CC |
|---|---|-----------------------|--------|----------|------|--------|-----|----|
| Sanitair producten | Gessi Rettangolo P | | | | | | | |
| | vloeruitloop hoekig | | | | | | | |
| | 0463551 | | chroom | 21995031 | stuk | 653,00 | 169 | 1 |
| | 0463552 | | inox | 21995142 | stuk | 849,00 | 169 | 1 |
| Baden / douchebakken / stoomcabines | | | | | | | | |
| Kranen | vloeruitloop gebogen | | | | | | | |
| | 0463553 | | chroom | 21997031 | stuk | 731,00 | 169 | 1 |
| | 0463554 | | inox | 21997142 | stuk | 950,00 | 169 | 1 |
| Douchegarnituur | | | | | | | | |
| Accessoires en spiegels | 3-gats inbouwwandkraan compleet; inbouwdeel + afbouwdeel | | | | | | | |
| | 0463555 | | chroom | 21985031 | stuk | 472,00 | 169 | 1 |
| | 0463556 | | inox | 21985142 | stuk | 614,00 | 169 | 1 |
| Douchewanden | | | | | | | | |
| Toebehoren & afvoeren | afbouwdeel v. 3-gats inbouwwandkraan | | | | | | | |
| | 0461059 | | chroom | 21988031 | stuk | 338,00 | 169 | 1 |
| | 0461060 | | inox | 21988142 | stuk | 479,00 | 169 | 1 |
| Spoel- & installatiesystemen | | | | | | | | |
| Badkamermeubelen en toiletkasten | 3-gats bidetkraan m. uitloop m. waste | | | | | | | |
| | 0463557 | | chroom | 22017031 | stuk | 436,00 | 169 | 1 |
| | 0463559 | | inox | 22017142 | stuk | 567,00 | 169 | 1 |
| Gootstenen en wastroggen | | | | | | | | |
| Utiliteit | badkraan m. omstel z. garnituur | | | | | | | |
| | 0463562 | | chroom | 21913031 | stuk | 462,00 | 169 | 1 |
| | 0463563 | | inox | 21913142 | stuk | 601,00 | 169 | 1 |
| Utiliteit | badkraan m. omstel m. slang 150cm m. handdouche | | | | | | | |
| | 0463564 | m. houder vast | chroom | 21919031 | stuk | 625,00 | 169 | 1 |
| | 0463565 | m. houder vast | inox | 21919142 | stuk | 812,00 | 169 | 1 |
| | 0463567 | m. houder verstelbaar | chroom | 21925031 | stuk | 702,00 | 169 | 1 |
| | 0463568 | m. houder verstelbaar | inox | 21925142 | stuk | 912,00 | 169 | 1 |
| Utiliteit | 4-gats inbouwbadkraan; inbouw- en afbouwdeel | | | | | | | |
| | 0461061 | | chroom | 21922031 | stuk | 689,00 | 169 | 1 |
| | 0461062 | | inox | 21922142 | stuk | 891,00 | 169 | 1 |

| Art.nr | Specificaties | Kleur | Lev.nr | Ehd | Prijs | Grp | CC |
|--------|---------------|-------|--------|-----|-------|-----|----|
|--------|---------------|-------|--------|-----|-------|-----|----|

Gessi Rettangolo P

afbouwdeel v. 4-gats inbouwbadkraan

| | | | | | | | |
|---------|--|--------|----------|------|--------|-----|---|
| 0461063 | | chroom | 21923031 | stuk | 555,00 | 169 | 1 |
| 0461064 | | inox | 21923142 | stuk | 756,00 | 169 | 1 |



Sanitair producten

Baden /
douchebakken /
stoomcabines**inbouwdeel v. 4-gats inbouwbadkraan**

| | | | | | | | |
|---------|--|--|----------|------|--------|-----|---|
| 0461065 | | | 20498031 | stuk | 135,00 | 169 | 1 |
|---------|--|--|----------|------|--------|-----|---|



Kranen

Douchegarnituur

4-gats badrandcombinatie m. gebogen uitloop m. slang m. handdouche

| | | | | | | | |
|---------|--|--------|----------|------|--------|-----|---|
| 0463569 | | chroom | 21937031 | stuk | 697,00 | 169 | 1 |
| 0463570 | | inox | 21937142 | stuk | 906,00 | 169 | 1 |

Accessoires en
spiegels**4-gats badrandcombinatie m. hoekige uitloop m. slang m. handdouche**

| | | | | | | | |
|---------|--|--------|----------|------|--------|-----|---|
| 0461066 | | chroom | 21940031 | stuk | 697,00 | 169 | 1 |
| 0461067 | | inox | 21940142 | stuk | 906,00 | 169 | 1 |



Douchewanden

Toebehoren &
afvoeren**4-gats badkraan voor badvulcombinatie z. uitloop m. slang m. handdouche**

| | | | | | | | |
|---------|--|--------|----------|------|--------|-----|---|
| 0463571 | | chroom | 21943031 | stuk | 637,00 | 169 | 1 |
| 0463572 | | inox | 21943142 | stuk | 828,00 | 169 | 1 |

Spoel- &
installatiesystemenBadkamermeubelen
en toiletkasten**douchekraan z. omstel**

| | | | | | | | |
|---------|--|--------|----------|------|--------|-----|---|
| 0463573 | | chroom | 21931031 | stuk | 377,00 | 169 | 1 |
| 0463575 | | inox | 21931142 | stuk | 490,00 | 169 | 1 |

Gootstenen en
wastroggen**inbouwstopkraan 1/2" compleet**

| | | | | | | | |
|---------|--|--------|----------|------|--------|-----|---|
| 0461068 | | chroom | 22066031 | stuk | 151,00 | 169 | 1 |
| 0461069 | | inox | 22066142 | stuk | 196,00 | 169 | 1 |



Utiliteit

afbouwdeel v. inbouwstopkraan

| | | | | | | | |
|---------|--|--------|----------|------|--------|-----|---|
| 0461070 | | chroom | 22063031 | stuk | 104,00 | 169 | 1 |
| 0461071 | | inox | 22063142 | stuk | 149,00 | 169 | 1 |

**2-wegs inbouwomstelrichting; inbouw- en afbouwdeel**

| | | | | | | | |
|---------|--|--------|----------|------|--------|-----|---|
| 0461072 | | chroom | 22071031 | stuk | 274,00 | 169 | 1 |
| 0461073 | | inox | 22071142 | stuk | 356,00 | 169 | 1 |



| | Art.nr | Specificaties | Kleur | Lev.nr | Ehd | Prijs | Grp | CC |
|---|--|---------------|--------|----------|------|--------|-----|----|
| | Gessi Rettangolo P | | | | | | | |
| Sanitair producten | 3-wegs inbouwomstelinrichting; inbouw- en afbouwdeel | | | | | | | |
| | 0461074 | | chroom | 22073031 | stuk | 274,00 | 169 | 1 |
| | 0461075 | | inox | 22073142 | stuk | 356,00 | 169 | 1 |
| Baden / douchebakken / stoomcabines | | | | | | | | |
| Kranen | afbouwdeel v. inbouw 2- en 3-wegs omstelinrichting | | | | | | | |
| | 0461076 | | chroom | 22075031 | stuk | 110,00 | 169 | 1 |
| | 0461077 | | inox | 22075142 | stuk | 192,00 | 169 | 1 |
| Douchegarnituur | | | | | | | | |
| | Gessi Rettangolo T | | | | | | | |
| Accessoires en spiegels | 1-gats wastafelkraan m. waste | | | | | | | |
| | 0463459 | | chroom | 20301031 | stuk | 349,00 | 169 | 1 |
| | 0463460 | | inox | 20301142 | stuk | 453,00 | 169 | 1 |
| Douchewanden | | | | | | | | |
| Toebehoren & afvoeren | 1-gats wastafelkraan m. waste m. hoge uitloop | | | | | | | |
| | 0463461 | | chroom | 20303031 | stuk | 400,00 | 169 | 1 |
| | 0463462 | | inox | 20303142 | stuk | 519,00 | 169 | 1 |
| Spoel- & installatiesystemen | | | | | | | | |
| Badkamermeubelen en toiletkasten | 3-gats wastafelkraan m. waste m. uitloop hoekig 95mm | | | | | | | |
| | 0463465 | | chroom | 20401031 | stuk | 455,00 | 169 | 1 |
| | 0463466 | | inox | 20401142 | stuk | 591,00 | 169 | 1 |
| Gootstenen en wastroggen | | | | | | | | |
| Utiliteit | 3-gats wastafelkraan m. waste m. uitloop hoekig 15x15cm | | | | | | | |
| | 0463467 | | chroom | 20402031 | stuk | 462,00 | 169 | 1 |
| | 0463468 | | inox | 20402142 | stuk | 601,00 | 169 | 1 |
| | 3-gats wastafelkraan m. wast m. uitloop hoekig 15x21cm | | | | | | | |
| | 0463470 | | chroom | 20403031 | stuk | 472,00 | 169 | 1 |
| | 0463471 | | inox | 20403142 | stuk | 614,00 | 169 | 1 |
| | 3-gats wastafelkraan m. wast m. uitloop hoekig 30x21cm | | | | | | | |
| | 0463472 | | chroom | 20405031 | stuk | 517,00 | 169 | 1 |
| | 3-gats wastafelkraan m. wast m. uitloop rond 25cm | | | | | | | |
| | 0463474 | | chroom | 20406031 | stuk | 485,00 | 169 | 1 |
| | 0463475 | | inox | 20406142 | stuk | 631,00 | 169 | 1 |

| Art.nr | Specificaties | Kleur | Lev.nr | Ehd | Prijs | Grp | CC |
|--------|---------------|-------|--------|-----|-------|-----|----|
|--------|---------------|-------|--------|-----|-------|-----|----|

Gessi Rettangolo T

3-gats wastafelkraan m. waste m. uitloop rond 40cm

| | | | | | | | |
|---------|--|--------|----------|------|--------|-----|---|
| 0463476 | | chroom | 20407031 | stuk | 501,00 | 169 | 1 |
| 0463478 | | inox | 20407142 | stuk | 652,00 | 169 | 1 |



Sanitair producten

Baden /
douchebakken /
stoomcabines**3-gats inbouwwandkraan compleet; inbouwdeel + afbouwdeel**

| | | | | | | | |
|---------|--|--------|----------|------|--------|-----|---|
| 0463486 | | chroom | 20485031 | stuk | 472,00 | 169 | 1 |
| 0463487 | | inox | 20485142 | stuk | 614,00 | 169 | 1 |



Kranen

Douchegarnituur

afbouwdeel v. 3-gats inbouwwandkraan

| | | | | | | | |
|---------|--|--------|----------|------|--------|-----|---|
| 0461032 | | chroom | 20488031 | stuk | 338,00 | 169 | 1 |
| 0461033 | | inox | 20488142 | stuk | 479,00 | 169 | 1 |

Accessoires en
spiegels**inbouwdeel v. 3-gats inbouwwandkraan**

| | | | | | | | |
|---------|--|--|----------|------|--------|-----|---|
| 0461034 | | | 20497031 | stuk | 135,00 | 169 | 1 |
|---------|--|--|----------|------|--------|-----|---|

Douchewanden

hendels voor kraan los

| | | | | | | | |
|---------|--|--------|----------|------|--------|-----|---|
| 0463479 | | chroom | 20408031 | stuk | 235,00 | 169 | 1 |
| 0463480 | | inox | 20408142 | stuk | 305,00 | 169 | 1 |

Toebehoren &
afvoeren**1-gats bidetkraan m. waste**

| | | | | | | | |
|---------|--|--------|----------|------|--------|-----|---|
| 0463463 | | chroom | 20307031 | stuk | 349,00 | 169 | 1 |
| 0463464 | | inox | 20307142 | stuk | 453,00 | 169 | 1 |

Spoel- &
installatiesystemenBadkamermeubelen
en toiletkasten**3-gats bidetkraan m. uitloop**

| | | | | | | | |
|---------|--|--------|----------|------|--------|-----|---|
| 0463488 | | chroom | 20417031 | stuk | 436,00 | 169 | 1 |
| 0463489 | | inox | 20417142 | stuk | 567,00 | 169 | 1 |

Gootstenen en
wastroggen**vloeruitloop rond**

| | | | | | | | |
|---------|--|--------|----------|------|--------|-----|---|
| 0463483 | | chroom | 20397031 | stuk | 731,00 | 169 | 1 |
| 0463484 | | inox | 20397142 | stuk | 950,00 | 169 | 1 |



Utiliteit

plafonduitloop

| | | | | | | | |
|---------|------------|--------|----------|------|--------|-----|---|
| 0463204 | lang 160cm | chroom | 20099031 | stuk | 514,00 | 169 | 1 |
| 0463320 | lang 160cm | inox | 20099142 | stuk | 668,00 | 169 | 1 |

**douchekraan**

| | | | | | | | |
|---------|--|--------|----------|------|--------|-----|---|
| 0463503 | | chroom | 20331031 | stuk | 377,00 | 169 | 1 |
| 0463504 | | inox | 20331142 | stuk | 490,00 | 169 | 1 |



| Art.nr | Specificaties | Kleur | Lev.nr | Ehd | Prijs | Grp | CC |
|--------|---------------|-------|--------|-----|-------|-----|----|
|--------|---------------|-------|--------|-----|-------|-----|----|

Gessi Rettangolo T

badkraan m. omstel z. garnituur

| | | | | | | | |
|---------|--|--------|----------|------|--------|-----|---|
| 0463492 | | chroom | 20313031 | stuk | 462,00 | 169 | 1 |
| 0463494 | | inox | 20313142 | stuk | 601,00 | 169 | 1 |



Sanitair producten

Baden /
douchebakken /
stoomcabines

badkraan m. omstel m. slang 150cm m. handdouche

| | | | | | | | |
|---------|-----------------------|--------|----------|------|--------|-----|---|
| 0463495 | m. houder vast | chroom | 20319031 | stuk | 625,00 | 169 | 1 |
| 0463496 | m. houder vast | inox | 20319142 | stuk | 812,00 | 169 | 1 |
| 0463497 | m. houder verstelbaar | chroom | 20325031 | stuk | 702,00 | 169 | 1 |
| 0463498 | m. houder verstelbaar | inox | 20325142 | stuk | 912,00 | 169 | 1 |



Kranen

Douchegarnituur



Accessoires en
spiegels

4-gats badrandcombinatie m. uitloop m. slang m. handdouche

| | | | | | | | |
|---------|--|--------|----------|------|--------|-----|---|
| 0463499 | | chroom | 20337031 | stuk | 697,00 | 169 | 1 |
| 0463500 | | inox | 20337142 | stuk | 906,00 | 169 | 1 |



Douchewanden

Toebehoren &
afvoeren

4-gats badkraan voor badvulcombinatie z. uitloop m. slang m. handdouche

| | | | | | | | |
|---------|--|--------|----------|------|--------|-----|---|
| 0463501 | | chroom | 20343031 | stuk | 637,00 | 169 | 1 |
| 0463502 | | inox | 20343142 | stuk | 828,00 | 169 | 1 |



Spoel- &
installatiesystemen

badthermostaat m. omstel z. garnituur

| | | | | | | | |
|---------|--|--------|----------|------|--------|-----|---|
| 0463214 | | chroom | 20111031 | stuk | 556,00 | 169 | 0 |
| 0463328 | | inox | 20111142 | stuk | 723,00 | 169 | 1 |



Badkamermeubelen
en toiletkasten

Gootstenen en
wastroggen

badthermostaat m. omstel m. slang 150cm m. handdouche

| | | | | | | | |
|---------|-----------------------|--------|----------|------|---------|-----|---|
| 0463215 | m. houder vast | chroom | 20113031 | stuk | 727,00 | 169 | 0 |
| 0463330 | m. houder vast | inox | 20113142 | stuk | 944,00 | 169 | 1 |
| 0463216 | m. houder verstelbaar | chroom | 20115031 | stuk | 804,00 | 169 | 1 |
| 0463331 | m. houder verstelbaar | inox | 20115142 | stuk | 1046,00 | 169 | 1 |



Utiliteit



douchethermostaat m. hoofddouche h=177.4cm

| | | | | | | | |
|---------|--|--------|----------|------|---------|-----|---|
| 0463225 | | chroom | 23401031 | stuk | 1685,00 | 169 | 1 |
| 0463340 | | inox | 23401142 | stuk | 2191,00 | 169 | 1 |



douchethermostaat m. hoofddouche h=177.4cm m. garnituur

| | | | | | | | |
|---------|--|--------|----------|------|---------|-----|---|
| 0463226 | | chroom | 23405031 | stuk | 2010,00 | 169 | 1 |
| 0463341 | | inox | 23405142 | stuk | 2613,00 | 169 | 1 |



| Art.nr | Specificaties | Kleur | Lev.nr | Ehd | Prijs | Grp | CC |
|--------|---------------|-------|--------|-----|-------|-----|----|
|--------|---------------|-------|--------|-----|-------|-----|----|

Gessi Rettangolo T

douchethermostaat m. hoofddouche h=117cm m. garnituur

| | | | | | | | |
|---------|--|--------|----------|------|---------|-----|---|
| 0463227 | | chroom | 23407031 | stuk | 1754,00 | 169 | 1 |
| 0463342 | | inox | 23407142 | stuk | 2280,00 | 169 | 1 |



Sanitair producten

Baden /
douchebakken /
stoomcabines**douchethermostaat m. hoofddouche h=177.4cm m. garnituur verstelbaar**

| | | | | | | | |
|---------|--|--------|----------|------|---------|-----|---|
| 0463228 | | chroom | 23409031 | stuk | 2139,00 | 169 | 0 |
| 0463343 | | inox | 23409142 | stuk | 2780,00 | 169 | 1 |



Kranen

Douchegarnituur

douchethermostaat m. hoofddouche h=117cm

| | | | | | | | |
|---------|--|--------|----------|------|---------|-----|---|
| 0463421 | | chroom | 23403031 | stuk | 1429,00 | 169 | 1 |
| 0463422 | | inox | 23403142 | stuk | 1857,00 | 169 | 1 |

Accessoires en
spiegels

Douchewanden

douchethermostaat m. hoofddouche h=117cm m. garnituur verstelbaar

| | | | | | | | |
|---------|--|--------|----------|------|---------|-----|---|
| 0463423 | | chroom | 23411031 | stuk | 1882,00 | 169 | 1 |
| 0463424 | | inox | 23411142 | stuk | 2446,00 | 169 | 1 |

Toebehoren &
afvoeren**baduitloop**

| | | | | | | | |
|---------|--|--------|----------|------|--------|-----|---|
| 0463303 | | chroom | 20103031 | stuk | 184,00 | 169 | 1 |
| 0463405 | | inox | 20103142 | stuk | 238,00 | 169 | 1 |

Spoel- &
installatiesystemen**doucheuitloop**

| | | | | | | | |
|---------|--|--------|----------|------|--------|-----|---|
| 0463304 | | chroom | 20104031 | stuk | 184,00 | 169 | 1 |
|---------|--|--------|----------|------|--------|-----|---|

Badkamermeubelen
en toiletkastenGootstenen en
wastroggen**inbouwstopkraan 1/2" compleet**

| | | | | | | | |
|---------|--|--------|----------|------|--------|-----|---|
| 0461035 | | chroom | 20466031 | stuk | 151,00 | 169 | 1 |
| 0461036 | | inox | 20466142 | stuk | 196,00 | 169 | 1 |



Utiliteit

douchethermostaat

| | | | | | | | |
|---------|--|--------|----------|------|--------|-----|---|
| 0463071 | | chroom | 19431031 | stuk | 479,00 | 169 | 0 |
| 0463072 | | inox | 19431142 | stuk | 647,00 | 169 | 0 |

**1-weg inbouwdouchekraan 1/2" compleet; inbouw + afbouwdeel**

| | | | | | | | |
|---------|--|--------|----------|------|--------|-----|---|
| 0463425 | | chroom | 20049031 | stuk | 296,00 | 169 | 1 |
| 0463427 | | inox | 20049142 | stuk | 385,00 | 169 | 1 |



| Art.nr | Specificaties | Kleur | Lev.nr | Ehd | Prijs | Grp | CC |
|--------|---------------|-------|--------|-----|-------|-----|----|
|--------|---------------|-------|--------|-----|-------|-----|----|

Gessi Rettangolo T

2-weg inbouwbadkraan 1/2" compleet; inbouwdeel + afbouwdeel

| | | | | | | | |
|---------|--|--------|----------|------|--------|-----|---|
| 0463428 | | chroom | 20067031 | stuk | 336,00 | 169 | 1 |
| 0463429 | | inox | 20067142 | stuk | 436,00 | 169 | 1 |



Sanitair producten

Baden /
douchebakken /
stoomcabines

1-weg inbouwthermostaat m. aansluitingen 1/2" compleet; inbouw + afbouwdeel

| | | | | | | | |
|---------|--|--------|----------|------|--------|-----|---|
| 0463430 | | chroom | 20131031 | stuk | 619,00 | 169 | 1 |
| 0463431 | | inox | 20131142 | stuk | 823,00 | 169 | 1 |



Kranen

Douchegarnituur

afbouwdeel v. inbouwstopkraan

| | | | | | | | |
|---------|--|--------|----------|------|--------|-----|---|
| 0461037 | | chroom | 20463031 | stuk | 104,00 | 169 | 1 |
| 0461038 | | inox | 20463142 | stuk | 149,00 | 169 | 1 |

Accessoires en
spiegels

2-weg inbouwthermostaat m. aansluitingen 1/2" compleet; inbouw + afbouwdeel

| | | | | | | | |
|---------|--|--------|----------|------|--------|-----|---|
| 0463432 | | chroom | 20133031 | stuk | 674,00 | 169 | 0 |
| 0463433 | | inox | 20133142 | stuk | 877,00 | 169 | 1 |



Douchewanden

3-weg inbouwthermostaat m. aansluitingen 1/2" compleet; inbouw + afbouwdeel

| | | | | | | | |
|---------|--|--------|----------|------|--------|-----|---|
| 0463435 | | chroom | 20135031 | stuk | 703,00 | 169 | 1 |
| 0463436 | | inox | 20135142 | stuk | 907,00 | 169 | 1 |



Toebehoren &
afvoeren

Spoel- &
installatiesystemen

designsifon vierhoekig 5/4"

| | | | | | | | |
|---------|----------------------|--------|---------|------|--------|-----|---|
| 0463313 | m. muurbuis m. rozet | chroom | 1410031 | stuk | 206,00 | 169 | 0 |
| 0463413 | m. muurbuis m. rozet | inox | 1410142 | stuk | 276,00 | 169 | 1 |



Badkamermeubelen
en toiletkasten

inbouwstopkraan 1/2" compleet; inbouw + afbouwdeel

| | | | | | | | |
|---------|--|--------|----------|------|--------|-----|---|
| 0463437 | | chroom | 20163031 | stuk | 151,00 | 169 | 1 |
| 0463438 | | inox | 20163142 | stuk | 196,00 | 169 | 1 |



Gootstenen en
wastroggen

Utiliteit

hoekstopkraan 4-hoekig 1/2"

| | | | | | | | |
|---------|--|--------|---------|------|--------|-----|---|
| 0463439 | | chroom | 1412031 | stuk | 102,00 | 169 | 0 |
| 0463440 | | inox | 1412142 | stuk | 146,00 | 169 | 1 |



inbouw 2-wegs omstelkraan compleet

| | | | | | | | |
|---------|--|--------|----------|------|--------|-----|---|
| 0461039 | | chroom | 20471031 | stuk | 274,00 | 169 | 1 |
| 0461040 | | inox | 20471142 | stuk | 356,00 | 169 | 1 |



| Art.nr | Specificaties | Kleur | Lev.nr | Ehd | Prijs | Grp | CC |
|--------|---------------|-------|--------|-----|-------|-----|----|
|--------|---------------|-------|--------|-----|-------|-----|----|

Gessi Rettangolo T

inbouw 3-wegs omstelkraan compleet

| | | | | | | | |
|---------|--|--------|----------|------|--------|-----|---|
| 0461041 | | chroom | 20473031 | stuk | 274,00 | 169 | 1 |
| 0461042 | | inox | 20473142 | stuk | 356,00 | 169 | 1 |



Sanitair producten

Baden /
douchebakken /
stoomcabines

Kranen

afbouwdeel v. inbouw 2- en 3-wegsomstelkraan

| | | | | | | | |
|---------|--|--------|----------|------|--------|-----|---|
| 0461043 | | chroom | 20475031 | stuk | 110,00 | 169 | 1 |
| 0461044 | | inox | 20475142 | stuk | 192,00 | 169 | 1 |

Douchegarnituur

Gessi Rettangolo XL

1-gats wastafelkraan m. waste

| | | | | | | | |
|---------|--|--------|----------|------|--------|-----|---|
| 0461078 | | chroom | 26101031 | stuk | 390,00 | 169 | 0 |
| 0461079 | | inox | 26101142 | stuk | 506,00 | 169 | 1 |

Accessoires en
spiegels

Douchewanden

1-gats wastafelkraan hoog m. waste

| | | | | | | | |
|---------|--|--------|----------|------|--------|-----|---|
| 0461080 | | chroom | 11953031 | stuk | 459,00 | 169 | 1 |
| 0461081 | | inox | 11953142 | stuk | 597,00 | 169 | 1 |

Toebehoren &
afvoerenSpoel- &
installatiesystemen**wastafelkraan vloerstaand**

| | | | | | | | |
|---------|--|--------|----------|------|---------|-----|---|
| 0461082 | | chroom | 26103031 | stuk | 1149,00 | 169 | 1 |
| 0461083 | | inox | 26103142 | stuk | 1494,00 | 169 | 1 |

Badkamermeubelen
en toiletkasten**inbouwwandkraan m. uitloop: inbouw- en afbouwdeel**

| | | | | | | | |
|---------|--|--------|----------|------|--------|-----|---|
| 0461084 | | chroom | 26106031 | stuk | 420,00 | 169 | 0 |
| 0461085 | | inox | 26106142 | stuk | 546,00 | 169 | 1 |

Gootstenen en
wastroggen

Utiliteit









afbouwdeel v. inbouwwandkraan m. uitloop

| | | | | | | | |
|---------|--|--------|----------|------|--------|-----|---|
| 0461086 | | chroom | 26295031 | stuk | 331,00 | 169 | 1 |
| 0461087 | | inox | 26295142 | stuk | 457,00 | 169 | 1 |

**inbouwwandkraan m. uitloop: inbouw- en afbouwdeel**

| | | | | | | | |
|---------|--|--------|----------|------|--------|-----|---|
| 0461089 | | chroom | 26185031 | stuk | 481,00 | 169 | 1 |
| 0461090 | | inox | 26185142 | stuk | 625,00 | 169 | 1 |



| | Art.nr | Specificaties | Kleur | Lev.nr | Ehd | Prijs | Grp | CC |
|---|---|---------------|--------|----------|------|---------|-----|----|
| | Gessi Rettangolo XL | | | | | | | |
| | afbouwdeel v. inbouwwandkraan m. uitloop | | | | | | | |
| Sanitair producten | 0461091 | | chroom | 26188031 | stuk | 350,00 | 169 | 1 |
| | 0461092 | | inox | 26188142 | stuk | 494,00 | 169 | 1 |
| Baden / douchebakken / stoomcabines |  | | | | | | | |
| | wanduitloop 21.3cm | | | | | | | |
| Kranen | 0461093 | | chroom | 26200031 | stuk | 205,00 | 169 | 1 |
| | 0461094 | | inox | 26200142 | stuk | 267,00 | 169 | 1 |
| Douchegarnituur |  | | | | | | | |
| | inbouwwandkraan: inbouw- en afbouwdeel | | | | | | | |
| Accessoires en spiegels | 0461095 | | chroom | 26206031 | stuk | 249,00 | 169 | 1 |
| | 0461096 | | inox | 26206142 | stuk | 323,00 | 169 | 1 |
| Douchewanden |  | | | | | | | |
| | inbouwdeel v. inbouwwandkraan | | | | | | | |
| Toebehoren & afvoeren | 0461088 | | | 26298031 | stuk | 89,50 | 169 | 1 |
| |  | | | | | | | |
| | 1-gats bidetkraan m. waste | | | | | | | |
| Spoel- & installatiesystemen | 0461097 | | chroom | 26107031 | stuk | 390,00 | 169 | 1 |
| | 0461098 | | inox | 26107142 | stuk | 506,00 | 169 | 1 |
| Badkamermeubelen en toiletkasten |  | | | | | | | |
| | badkraan m. garnituur m. vaste wandhouder | | | | | | | |
| Gootstenen en wastroggen | 0461100 | | chroom | 26119031 | stuk | 725,00 | 169 | 0 |
| | 0461100 | | inox | 26119142 | stuk | 929,00 | 169 | 1 |
| Utiliteit |  | | | | | | | |
| | badkraan m. garnituur m. verstelbare wandhouder | | | | | | | |
| Utiliteit | 0461101 | | chroom | 26125031 | stuk | 793,00 | 169 | 1 |
| | 0461102 | | inox | 26125142 | stuk | 1031,00 | 169 | 1 |
| |  | | | | | | | |
| | 3-gats badrandcombinatie z. uitloop | | | | | | | |
| Utiliteit | 0461103 | | chroom | 26137031 | stuk | 748,00 | 169 | 1 |
| | 0461104 | | inox | 26137142 | stuk | 972,00 | 169 | 1 |
| |  | | | | | | | |
| | douchekraan | | | | | | | |
| Utiliteit | 0461109 | | chroom | 26131031 | stuk | 458,00 | 169 | 1 |
| | 0461110 | | inox | 26131142 | stuk | 596,00 | 169 | 1 |
| |  | | | | | | | |

| Art.nr | Specificaties | Kleur | Lev.nr | Ehd | Prijs | Grp | CC |
|--------|---------------|-------|--------|-----|-------|-----|----|
|--------|---------------|-------|--------|-----|-------|-----|----|

Gessi Rettangolo XL

thermostatische douchezuil m. hoofddouche

| | | | | | | | |
|---------|--|--------|----------|------|---------|-----|---|
| 0461105 | | chroom | 26237031 | stuk | 1937,00 | 169 | 1 |
| 0461106 | | inox | 26237142 | stuk | 2519,00 | 169 | 1 |



Sanitair producten

Baden /
douchebakken /
stoomcabines**thermostatische douchezuil m. hoofddouche en handdouche m. glijstang**

| | | | | | | | |
|---------|--|--------|----------|------|---------|-----|---|
| 0461107 | | chroom | 26239031 | stuk | 2459,00 | 169 | 1 |
| 0461108 | | inox | 26239142 | stuk | 3197,00 | 169 | 1 |



Kranen

Douchegarnituur

Gessi Small

1-gats wastafelkraan m. waste

| | | | | | | | |
|---------|--|--------|----------|------|--------|-----|---|
| 0461111 | | chroom | 24101031 | stuk | 186,00 | 169 | 1 |
| 0461112 | | inox | 24101142 | stuk | 253,00 | 169 | 1 |

Accessoires en
spiegels**1-gats wastafelkraan verhoogd uitloop = 11cm m. waste**

| | | | | | | | |
|---------|--|--------|----------|------|--------|-----|---|
| 0461113 | | chroom | 11945031 | stuk | 216,00 | 169 | 1 |
| 0461114 | | inox | 11945142 | stuk | 294,00 | 169 | 1 |



Douchewanden

Toebehoren &
afvoeren**1-gats wastafelkraan verhoogd uitloop = 19cm m. waste**

| | | | | | | | |
|---------|--|--------|----------|------|--------|-----|---|
| 0461115 | | chroom | 11947031 | stuk | 216,00 | 169 | 1 |
| 0461116 | | inox | 11947142 | stuk | 294,00 | 169 | 1 |

Spoel- &
installatiesystemenBadkamermeubelen
en toiletkasten**1-gats bidetkraan m. waste**

| | | | | | | | |
|---------|--|--------|----------|------|--------|-----|---|
| 0461117 | | chroom | 24107031 | stuk | 186,00 | 169 | 1 |
| 0461118 | | inox | 24107142 | stuk | 253,00 | 169 | 1 |

Gootstenen en
wastroggen

Utiliteit

2-gats inbouwwandkraan compleet; inbouwdeel + afbouwdeel uitloop 16.5cm

| | | | | | | | |
|---------|--|--------|----------|------|--------|-----|---|
| 0461119 | | chroom | 19685031 | stuk | 396,00 | 169 | 1 |
| 0461120 | | inox | 19685142 | stuk | 534,00 | 169 | 1 |

**2-gats inbouwwandkraan compleet; inbouwdeel + afbouwdeel uitloop 23cm**

| | | | | | | | |
|---------|--|--------|----------|------|--------|-----|---|
| 0461177 | | chroom | 19691031 | stuk | 413,00 | 169 | 1 |
| 0461178 | | inox | 19691142 | stuk | 557,00 | 169 | 1 |

**afbouwdeel v. 2-gats inbouwwandkraan uitloop = 16.5cm**

| | | | | | | | |
|---------|--|--------|----------|------|--------|-----|---|
| 0461175 | | chroom | 19688031 | stuk | 265,00 | 169 | 1 |
| 0461176 | | inox | 19688142 | stuk | 403,00 | 169 | 1 |



| Art.nr | Specificaties | Kleur | Lev.nr | Ehd | Prijs | Grp | CC |
|--------|---------------|-------|--------|-----|-------|-----|----|
|--------|---------------|-------|--------|-----|-------|-----|----|

Gessi Small

afbouwdeel v. 2-gats inbouwwandkraan uitloop = 23cm

| | | | | | | | |
|---------|--|--------|----------|------|--------|-----|---|
| 0461179 | | chroom | 19694031 | stuk | 282,00 | 169 | 1 |
| 0461180 | | inox | 19694142 | stuk | 426,00 | 169 | 1 |



Sanitair producten

Baden /
douchebakken /
stoomcabines

badkraan m. omstel z. garnituur m. koppelingen

| | | | | | | | |
|---------|--|--------|----------|------|--------|-----|---|
| 0461181 | | chroom | 19613031 | stuk | 302,00 | 169 | 1 |
| 0461182 | | inox | 19613142 | stuk | 410,00 | 169 | 1 |



Kranen

Douchegarnituur

badkraan m. omstel m. slang m. handdouche m. koppelingen

| | | | | | | | |
|---------|---------------------------|--------|----------|------|--------|-----|---|
| 0461183 | m. vaste wandhouder | chroom | 19619031 | stuk | 375,00 | 169 | 1 |
| 0461184 | m. vaste wandhouder | inox | 19619142 | stuk | 509,00 | 169 | 1 |
| 0461185 | m. verstelbare wandhouder | chroom | 19625031 | stuk | 386,00 | 169 | 1 |
| 0461186 | m. verstelbare wandhouder | inox | 19625142 | stuk | 525,00 | 169 | 1 |



Accessoires en
spiegels

Douchewanden

Toebehoren &
afvoeren

badthermostaat m. omstel m. slang m. handdouche m. koppelingen

| | | | | | | | |
|---------|---------------------------|--------|----------|------|--------|-----|---|
| 0461188 | m. vaste wandhouder | chroom | 19723031 | stuk | 502,00 | 169 | 1 |
| 0461189 | m. vaste wandhouder | inox | 19723142 | stuk | 679,00 | 169 | 1 |
| 0461190 | m. verstelbare wandhouder | chroom | 19725031 | stuk | 522,00 | 169 | 1 |
| 0461191 | m. verstelbare wandhouder | inox | 19725142 | stuk | 706,00 | 169 | 1 |



Spoel- &
installatiesystemen

Badkamermeubelen
en toiletkasten

Gootstenen en
wastroggen

3-gats badrandcombinatie m. uitloop m. slang 150cm m. handdouche

| | | | | | | | |
|---------|--|--------|----------|------|--------|-----|---|
| 0461192 | | chroom | 24137031 | stuk | 451,00 | 169 | 1 |
| 0461193 | | inox | 24137142 | stuk | 612,00 | 169 | 1 |



3-gats badrandcombinatie z. uitloop m. slang 150cm m. handdouche

| | | | | | | | |
|---------|--|--------|----------|------|--------|-----|---|
| 0461194 | | chroom | 24143031 | stuk | 392,00 | 169 | 1 |
| 0461195 | | inox | 24143142 | stuk | 534,00 | 169 | 1 |



Gessi Universeel

wanduitloop voor inbouwdeel 13297

| | | | | | | | | |
|---------|-------|----------|--------|----------|------|--------|-----|---|
| 0462330 | 165mm | m. inbus | chroom | 13304031 | stuk | 95,00 | 169 | 0 |
| 0463884 | 165mm | m. inbus | inox | 13304142 | stuk | 137,00 | 169 | 1 |



| Art.nr | Specificaties | Kleur | Lev.nr | Ehd | Prijs | Grp | CC |
|--------|---------------|-------|--------|-----|-------|-----|----|
|--------|---------------|-------|--------|-----|-------|-----|----|

Gessi Universeel

wanduitloop voor bad

| | | | | | | | |
|---------|--------|--------|----------|------|--------|-----|---|
| 0462333 | 16,5cm | chroom | 13005031 | stuk | 95,00 | 169 | 1 |
| 0462334 | 16,5cm | inox | 13005142 | stuk | 137,00 | 169 | 1 |

wanduitloop voor 13297

| | | | | | | | | |
|---------|------|----------|--------|----------|------|--------|-----|---|
| 0462331 | 23cm | m. inbus | chroom | 13305031 | stuk | 119,00 | 169 | 1 |
| 0462332 | 23cm | m. inbus | inox | 13305142 | stuk | 161,00 | 169 | 1 |

wanduitloop voor bad

| | | | | | | | | |
|---------|------|--|--------|----------|------|--------|-----|---|
| 0462349 | 23cm | | chroom | 13315031 | stuk | 119,00 | 169 | 0 |
| 0463081 | 23cm | | inox | 13315142 | stuk | 161,00 | 169 | 1 |

inbouwdeel voor wandkraan m. uitloop

| | | | | | | | |
|---------|--|--|----------|------|--------|-----|---|
| 0463060 | | | 23097031 | stuk | 132,00 | 169 | 0 |
|---------|--|--|----------|------|--------|-----|---|



Sanitair producten

Baden /
douchebakken /
stoomcabines

Kranen

Douchegarnituur

inbouwdouchethermostaat z. omstel m. stopkraan 1/2" compleet

| | | | | | | | |
|---------|---------------------|--------|----------|------|--------|-----|---|
| 0462683 | inbouw + afbouwdeel | chroom | 13331031 | stuk | 494,00 | 169 | 0 |
| 0460471 | inbouw + afbouwdeel | inox | 13331142 | stuk | 662,00 | 169 | 1 |

Accessoires en
spiegels

Douchewanden

afbouwdeel v. inbouwdouchethermostaat z. omstel 1/2"

| | | | | | | | |
|---------|--|--------|----------|------|--------|-----|---|
| 0460505 | | chroom | 13332031 | stuk | 251,00 | 169 | 1 |
| 0460506 | | inox | 13332142 | stuk | 419,00 | 169 | 1 |

Toebehoren &
afvoerenSpoel- &
installatiesystemen**inbouwbadthermostaat m. omstel m. stopkraan 1/2" compleet**

| | | | | | | | |
|---------|---------------------|--------|----------|------|--------|-----|---|
| 0462691 | inbouw + afbouwdeel | chroom | 13333031 | stuk | 549,00 | 169 | 0 |
| 0460472 | inbouw + afbouwdeel | inox | 13333142 | stuk | 716,00 | 169 | 1 |

Badkamermeubelen
en toiletkasten**afbouwdeel v. inbouwbadthermostaat m. omstel 1/2"**

| | | | | | | | |
|---------|--|--------|----------|------|--------|-----|---|
| 0460507 | | chroom | 13334031 | stuk | 251,00 | 169 | 1 |
| 0460508 | | inox | 13334142 | stuk | 419,00 | 169 | 1 |

Gootstenen en
wastroggen

Utiliteit









inbouwbadthermostaat m. 3-weg omstel m. stopkraan 1/2" compleet

| | | | | | | | |
|---------|---------------------|--------|----------|------|--------|-----|---|
| 0462705 | inbouw + afbouwdeel | chroom | 13335031 | stuk | 578,00 | 169 | 1 |
| 0460473 | inbouw + afbouwdeel | inox | 13335142 | stuk | 746,00 | 169 | 1 |

**inbouwdeel voor 1-weg inbouwthermostaat**

| | | | | | | | |
|---------|--|--|---------|------|--------|-----|---|
| 0463073 | | | 9255031 | stuk | 244,00 | 169 | 0 |
|---------|--|--|---------|------|--------|-----|---|



| | Art.nr | Specificaties | Kleur | Lev.nr | Ehd | Prijs | Grp | CC |
|--|-------------------------|--|--------|----------|------|---------|-----|----|
| | Gessi Universeel | | | | | | | |
| Sanitair producten | | inbouwdeel voor 2-weg inbouwthermostaat | | | | | | |
|  | 0463074 | | | 9257031 | stuk | 298,00 | 169 | 0 |
| Baden / douchebakken / stoomcabines | | inbouwdeel voor 3-weg inbouwthermostaat | | | | | | |
|  | 0463075 | | | 9259031 | stuk | 328,00 | 169 | 0 |
| Kranen | | afbouwdeel v. inbouwbadthermostaat m. 3-weg omstel 1/2" | | | | | | |
|  | 0460509 | | chroom | 13338031 | stuk | 251,00 | 169 | 1 |
| | 0460521 | | inox | 13338142 | stuk | 419,00 | 169 | 1 |
| Accessoires en spiegels | | inbouwstopkraan 1/2" compleet; inbouw + afbouwdeel | | | | | | |
|  | 0462772 | | chroom | 12903031 | stuk | 106,00 | 169 | 0 |
| Douchewanden | | afdekplaat rond voor inbouwkraan | | | | | | |
|  | 0467928 | | chroom | 13398031 | stuk | 33,00 | 169 | 0 |
| | 0460487 | | inox | 13398142 | stuk | 46,50 | 169 | 1 |
| Badkamermeubelen en toiletkasten | | badthermostaat m. omstel z. garnituur | | | | | | |
|  | 0463119 | | chroom | 19441031 | stuk | 427,00 | 169 | 1 |
| | 0460494 | | inox | 19441142 | stuk | 576,00 | 169 | 1 |
| Gootstenen en wastroggen | | badthermostaat m. omstel m. slang 150cm m. handdouche m. wandhouder | | | | | | |
|  | 0463137 | | chroom | 19443031 | stuk | 491,00 | 169 | 1 |
| | 0460495 | | inox | 19443142 | stuk | 664,00 | 169 | 1 |
| Utiliteit | | badthermostaat m. omstel m. slang 150cm m. handdouche m. verstelbare wandhouder | | | | | | |
|  | 0463138 | | chroom | 19445031 | stuk | 511,00 | 169 | 1 |
| | | staande badkraan m. garnituur | | | | | | |
|  | 0460524 | hoog 113.5cm | chroom | 24931031 | stuk | 1200,00 | 169 | 1 |
| | 0460525 | hoog 113.5cm | inox | 24931142 | stuk | 1559,00 | 169 | 1 |

| Art.nr | Specificaties | Kleur | Lev.nr | Ehd | Prijs | Grp | CC |
|--------|---------------|-------|--------|-----|-------|-----|----|
|--------|---------------|-------|--------|-----|-------|-----|----|

Gessi Universeel

afbouwdeel v. staande badkraan m. garnituur

| | | | | | | | |
|---------|--------------|--------|----------|------|---------|-----|---|
| 0460526 | hoog 113.5cm | chroom | 24934031 | stuk | 1044,00 | 169 | 1 |
| 0460527 | hoog 113.5cm | inox | 24934142 | stuk | 1403,00 | 169 | 1 |



Sanitair producten

Baden /
douchebakken /
stoomcabines**inbouwdeel voor staande badkraan**

| | | | | | | | |
|---------|--|--|----------|------|--------|-----|---|
| 0461613 | | | 24999031 | stuk | 156,00 | 169 | 1 |
|---------|--|--|----------|------|--------|-----|---|



Kranen

Douchegarnituur

douchethermostaat z. omstel m. koppelingen

| | | | | | | | |
|---------|--|-----------|----------|------|--------|-----|---|
| 0463113 | | chroom | 19451031 | stuk | 352,00 | 169 | 0 |
| 0460462 | | inox | 19451142 | stuk | 473,00 | 169 | 1 |
| 0463122 | | matchroom | 19451045 | stuk | 473,00 | 169 | 1 |

Accessoires en
spiegels**douchekraan recht m. hoofddouche en handdouche**

| | | | | | | | |
|---------|--|--------|----------|------|---------|-----|---|
| 0463592 | | chroom | 23491031 | stuk | 1581,00 | 169 | 1 |
| 0463593 | | inox | 23491142 | stuk | 2054,00 | 169 | 1 |



Douchewanden

Toebehoren &
afvoeren**douchekraan gebogen m. hoofddouche en handdouche**

| | | | | | | | |
|---------|--|--------|----------|------|---------|-----|---|
| 0463594 | | chroom | 23493031 | stuk | 1505,00 | 169 | 1 |
| 0463595 | | inox | 23493142 | stuk | 1956,00 | 169 | 1 |

Spoel- &
installatiesystemenBadkamermeubelen
en toiletkasten**inbouwdeel voor 1-weg wastafelkraan**

| | | | | | | | |
|---------|--|--|----------|------|-------|-----|---|
| 0463010 | | | 23112031 | stuk | 91,00 | 169 | 0 |
|---------|--|--|----------|------|-------|-----|---|

Gootstenen en
wastroggen**inbouwdeel voor inbouwstopkraan 1/2"**

| | | | | | | | |
|---------|--|--|----------|------|-------|-----|---|
| 0463054 | | | 23165031 | stuk | 47,75 | 169 | 0 |
|---------|--|--|----------|------|-------|-----|---|



Utiliteit









inbouwdeel voor 1-weg inbouwdouchekraan

| | | | | | | | |
|---------|--|--|---------|------|-------|-----|---|
| 0463037 | | | 9955031 | stuk | 91,00 | 169 | 0 |
|---------|--|--|---------|------|-------|-----|---|

**inbouwdeel voor wandkraan m. uitloop**

| | | | | | | | |
|---------|--|--|----------|------|--------|-----|---|
| 0460302 | | | 13297031 | stuk | 132,00 | 169 | 0 |
|---------|--|--|----------|------|--------|-----|---|



| | Art.nr | Specificaties | Kleur | Lev.nr | Ehd | Prijs | Grp | CC |
|---|---|---|-------|----------|------|--------|-----|----|
| | Gessi Universeel | | | | | | | |
| Sanitair producten | | inbouwdeel voor 1-weg wastafelkraan | | | | | | |
| | 0460303 | | | 13312031 | stuk | 91,00 | 169 | 0 |
| Baden / douchebakken / stoomcabines |  | | | | | | | |
| Kranen | | inbouwdeel voor 2-weg bad-/douchekraan | | | | | | |
| | 0460304 | | | 9973031 | stuk | 118,00 | 169 | 0 |
| Douchegarnituur |  | | | | | | | |
| Accessoires en spiegels | | inbouwdeel voor inbouwstopkraan 1/2" | | | | | | |
| | 0460305 | | | 9109031 | stuk | 47,75 | 169 | 0 |
| Douchewanden |  | | | | | | | |
| Toebehoren & afvoeren | | inbouwdeel voor 2-weg omstelkraan | | | | | | |
| | 0460306 | | | 9271031 | stuk | 164,00 | 169 | 0 |
| Spoel- & installatiesystemen |  | | | | | | | |
| Badkamermeubelen en toiletkasten | | inbouwdeel voor 3-weg omstelkraan | | | | | | |
| | 0460307 | | | 9273031 | stuk | 164,00 | 169 | 0 |
| Gootstenen en wastroggen |  | | | | | | | |
| Utiliteit | | inbouwdeel voor wandkraan m. joystick | | | | | | |
| | 0460312 | | | 14299031 | stuk | 89,50 | 169 | 0 |
| |  | | | | | | | |
| | | inbouwdeel voor 2-weg omstelkraan | | | | | | |
| | 0460313 | | | 23192031 | stuk | 164,00 | 169 | 0 |
| |  | | | | | | | |
| | | inbouwdeel voor 3-weg omstelkraan | | | | | | |
| | 0461611 | | | 23194031 | stuk | 164,00 | 169 | 1 |
| |  | | | | | | | |

| Art.nr | Specificaties | Kleur | Lev.nr | Ehd | Prijs | Grp | CC |
|--------|---------------|-------|--------|-----|-------|-----|----|
|--------|---------------|-------|--------|-----|-------|-----|----|

Gessi Universeel

verlengset v. inbouwkraan

| | | | | | | | |
|---------|----------------------|--------|---------|------|-------|-----|---|
| 0460562 | diam. 35mm m. omstel | chroom | 9250031 | stuk | 48,25 | 169 | 1 |
| 0460564 | diam. 35mm m. omstel | inox | 9250142 | stuk | 69,00 | 169 | 1 |
| 0460565 | diam. 35mm z. omstel | chroom | 9251031 | stuk | 42,25 | 169 | 1 |
| 0460566 | diam. 35mm z. omstel | inox | 9251142 | stuk | 62,00 | 169 | 1 |
| 0460569 | diam. 40mm m. omstel | chroom | 9252031 | stuk | 48,25 | 169 | 1 |
| 0460570 | diam. 40mm m. omstel | inox | 9252142 | stuk | 69,00 | 169 | 1 |
| 0460572 | diam. 40mm z. omstel | chroom | 9253031 | stuk | 42,25 | 169 | 1 |
| 0460574 | diam. 40mm z. omstel | inox | 9253142 | stuk | 62,00 | 169 | 1 |

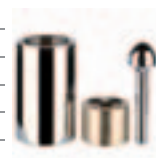

Sanitair producten

Baden /
douchebakken /
stoomcabines

Kranen

Douchegarnituur

Accessoires en
spiegels

Douchewanden

Toebehoren &
afvoerenSpoel- &
installatiesystemenBadkamermeubelen
en toiletkastenGootstenen en
wastroggen

Utiliteit

Gessi Onderdelen

| | | | | | | | |
|---------|--|--------|----------|------|--------|-----|---|
| 0464392 | set flexibele slang voor 15001 / 15007 à 2 stuks | chroom | 1382031 | stuk | 9,90 | 169 | 1 |
| 0464406 | set flexibele slang voor 15001 / 15007 à 2 stuks | inox | 1382142 | stuk | 14,25 | 169 | 1 |
| 0460137 | slang voor uitloop naar slangdoorvoer | | 1174031 | stuk | 13,25 | 169 | 1 |
| 0463469 | uitloop 16.5cm m. schroefdraad | chroom | 13300031 | stuk | 95,00 | 169 | 0 |
| 0463061 | uitloop 16.5cm m. schroefdraad | inox | 13300142 | stuk | 137,00 | 169 | 1 |
| 0463477 | uitloop 23cm m. schroefdraad | chroom | 13303031 | stuk | 119,00 | 169 | 0 |
| 0463062 | uitloop 23cm m. schroefdraad | inox | 13303142 | stuk | 161,00 | 169 | 1 |
| 0461394 | staande koppeling 125mm | chroom | 1344031 | stuk | 87,50 | 169 | 1 |
| 0461395 | staande koppeling 125mm | inox | 1344142 | stuk | 119,00 | 169 | 1 |
| 0461571 | bovendeel keramisch 1/2" 90° | | 1126031 | stuk | 11,75 | 169 | 0 |
| 0461355 | bovendeel keramisch 1/2" 90° | | 1545031 | stuk | 31,75 | 169 | 1 |
| 0461555 | cartouche Ø40mm | | 01154031 | stuk | 32,25 | 169 | 0 |
| 0461563 | cartouche Ø 35mm | | 1156031 | stuk | 31,75 | 169 | 0 |
| 0462713 | cartouche Ø25mm | | 1354031 | stuk | 32,25 | 169 | 0 |
| 0462748 | cartouche voor inbouwthermostaat | | 1166031 | stuk | 79,00 | 169 | 0 |
| 0462357 | cartouche Ø 32mm | | 1324031 | stuk | 37,25 | 169 | 1 |
| 0461556 | cartouche voor thermostaat | | 1473 | stuk | 48,00 | 169 | 0 |
| 0463580 | cartouche Ø 25mm | | 1805 | stuk | 32,25 | 169 | 1 |
| 0463574 | kniehevelventiel 5/4" afvoer- & overloopvent. | chroom | 1346031 | stuk | 26,75 | 169 | 1 |
| 0463085 | kniehevelventiel 5/4" afvoer- & overloopvent. | inox | 1346142 | stuk | 36,00 | 169 | 1 |
| 0463582 | trekwaste 5/4" chroom | | 1350031 | stuk | 39,75 | 169 | 0 |
| 0463087 | trekwaste 5/4" inox | | 1350142 | stuk | 56,50 | 169 | 1 |
| 0461396 | plug afsluiter H/60 m. overloop | chroom | 1408031 | stuk | 47,25 | 169 | 0 |
| 0461400 | plug afsluiter H/60 m. overloop | inox | 1408142 | stuk | 94,50 | 169 | 1 |
| 0461398 | plug afsluiter H/60 z. overloop | chroom | 1420031 | stuk | 47,25 | 169 | 1 |
| 0461402 | plug afsluiter H/60 z. overloop | inox | 1420142 | stuk | 94,50 | 169 | 1 |
| 0461397 | plug afsluiter H/90 m. overloop | chroom | 1422031 | stuk | 55,50 | 169 | 1 |
| 0461401 | plug afsluiter H/90 m. overloop | inox | 1422142 | stuk | 111,00 | 169 | 1 |
| 0461399 | plug afsluiter H/90 z. overloop | chroom | 1423031 | stuk | 55,50 | 169 | 1 |
| 0461403 | plug afsluiter H/90 z. overloop | inox | 1423142 | stuk | 111,00 | 169 | 1 |
| 0460308 | knop voor Quadro kraan | chroom | 15124031 | stuk | 42,75 | 169 | 1 |
| 0460309 | knop voor Quadro kraan | inox | 15124142 | stuk | 56,00 | 169 | 1 |
| 0460310 | knop voor Quadro kraan | chroom | 15127031 | stuk | 49,50 | 169 | 1 |
| 0460311 | knop voor Quadro kraan | inox | 15127142 | stuk | 62,50 | 169 | 1 |
| 0461933 | straalbreker antikalk | chroom | 1355031 | stuk | 4,33 | 921 | 1 |
| 0461934 | straalbreker antikalk 28mm | chroom | 1381031 | stuk | 5,60 | 921 | 1 |
| 0461936 | straalbreker M22x1" | chroom | 1102031 | stuk | 3,72 | 921 | 1 |
| 0461940 | straalbreker M22x1" | inox | 1102142 | stuk | 4,95 | 921 | 1 |
| 0461941 | straalbreker M24x1" | inox | 1108142 | stuk | 4,95 | 921 | 1 |
| 0461926 | straalbreker M28x1 | chroom | 1114031 | stuk | 5,60 | 921 | 1 |

| Art.nr | Specificaties | Kleur | Lev.nr | Ehd | Prijs | Grp | CC |
|-------------------------|--------------------------|-------|---------|------|-------|-----|----|
| Gessi Onderdelen | | | | | | | |
| 0461942 | straalbreker M28x1" inox | | 1114142 | stuk | 7,50 | 921 | 1 |

Sanitair producten

Baden /
douchebakken /
stoomcabines

Kranen

Douchegarnituur

Accessoires en
spiegels

Douchewanden

Toebehoren &
afvoeren

Spoel- &
installatiesystemen

Badkamermeubelen
en toiletkasten

Gootstenen en
wastroggen

Utiliteit

| Art.nr | Specificaties | Kleur | Lev.nr | Ehd | Prijs | Grp | CC |
|--------|---------------|-------|--------|-----|-------|-----|----|
|--------|---------------|-------|--------|-----|-------|-----|----|

Grohe Allure

1-gats wastafelkraan m. lage uitloop
0434011

chroom

32144000

stuk

413,00

162

1



Sanitair producten

1-gats wastafelkraan m. hoge uitloop
0434012

chroom

32146000

stuk

477,00

162

1

Baden /
douchebakken /
stoomcabines

Kranen

1-gats verhoogde wastafelkraan
0434007

chroom

32248000

stuk

588,00

162

1



Douchegarnituur

Accessoires en
spiegels

1-gats verhoogde wastafelkraan m. verhoogde uitloop
0434008

chroom

32249000

stuk

636,00

162

1



Douchewanden

Toebehoren &
afvoeren

afbouwset voor 2-gats inbouwwandkraan
0434013 sprong=180mm

chroom

19309000

stuk

365,00

162

1

Spoel- &
installatiesystemen

inbouwdeel voor 2-gats wandkraan
0434055

chroom

33769000

stuk

192,00

162

1

Badkamermeubelen
en toiletkasten

3-gats wandkraan
0434009 sprong=180mm

chroom

20144000

stuk

668,00

162

1

Gootstenen en
wastroggen

Utiliteit

3-gats wastafelkraan
0434010

chroom

20143000

stuk

636,00

162

1



bidetkraan
0434014

chroom

32147000







stuk











413,00

162

1



| | Art.nr | Specificaties | Kleur | Lev.nr | Ehd | Prijs | Grp | CC |
|---|---|---|---|----------|------|--------|-----|----|
| Sanitair producten | Grohe Allure | | | | | | | |
| | | douchekraan z. omstel | | | | | | |
| | 0434019 | | chrom | 32149000 | stuk | 608,00 | 162 | 1 |
| Baden / douchebakken / stoomcabines |  | | | | | | | |
| | | badkraan m. omstel | | | | | | |
| | 0434018 | | chrom | 32148000 | stuk | 736,00 | 162 | 1 |
| Kranen |  | | | | | | | |
| | | douchebuis | | | | | | |
| | 0434017 | | chrom | 32149000 | stuk | 608,00 | 162 | 1 |
| Douchegarnituur |  | | | | | | | |
| | | afbouwset voor 3-gats tegelrandkraan | | | | | | |
| | 0434022 | | chrom | 19316000 | stuk | 828,00 | 162 | 1 |
| Accessoires en spiegels | | 0442216 | inbouwdeel 3-gats badrandcombinatie voor tegelrandmontage | 33339000 | stuk | 984,00 | 162 | 1 |
| | | douchethermostaat | | | | | | |
| | 0434024 | | chrom | 34236000 | stuk | 668,00 | 162 | 1 |
| Douchewanden |  | | | | | | | |
| | | baduitloop | | | | | | |
| | 0434057 | | chrom | 13201000 | stuk | 186,00 | 162 | 1 |
| Toebehoren & afvoeren |  | | | | | | | |
| | | afbouwset voor inbouwdouchekraan | | | | | | |
| | 0434017 | | chrom | 19317000 | stuk | 240,00 | 162 | 1 |
| Spoel- & installatiesystemen | | 0439428 | inbouwdeel bad-/douchekraan m. omstel 1/2" | 33961000 | stuk | 220,00 | 162 | 0 |
| | | afbouwset voor inbouwbadkraan | | | | | | |
| | 0434015 | | chrom | 19315000 | stuk | 288,00 | 162 | 1 |
| Badkamermeubelen en toiletkasten | | 0439428 | inbouwdeel bad-/douchekraan m. omstel 1/2" | 33961000 | stuk | 220,00 | 162 | 0 |
| | | afbouwset voor inbouwthermostaat | | | | | | |
| | 0434020 | | chrom | 19307000 | stuk | 336,00 | 162 | 1 |
| Gootstenen en wastroggen | | 0450483 | inbouwdeel douchethermostaat 1/2" chrom | 34211000 | stuk | 217,00 | 163 | 0 |
| | | opbouwdeel voor stopkraan | | | | | | |
| | 0434056 | | chrom | 19334000 | stuk | 96,00 | 162 | 1 |
| Utiliteit |  | | | | | | | |
| | | opbouwdeel voor stopkraan | | | | | | |
| | 0434056 | | chrom | 19334000 | stuk | 96,00 | 162 | 1 |

| Art.nr | Specificaties | Kleur | Lev.nr | Ehd | Prijs | Grp | CC | | |
|--|---|--------|----------|------|--------|-----|----|---|---|
| | | | | | | | | Grohe Atlanta | |
| toiletkraan 1/2" | | | | | | | | | |
| 0432768 | | chroom | 20094000 | stuk | 41,25 | 210 | 0 |  | Sanitair producten |
| 0434930 | keramisch | chroom | 20155000 | stuk | 57,00 | 210 | 0 | | |
| toiletkraan 1/2" m. draaibare uitloop | | | | | | | | | |
| 0432792 | | chroom | 20454000 | stuk | 73,00 | 210 | 0 |  | Baden / douchebakken / stoomcabines |
| toiletkraan m. hoge uitloop | | | | | | | | | |
| 0438195 | | chroom | 30834000 | stuk | 81,00 | 210 | 1 |  | Douchegarnituur |
| 1-gats wastafelkraan m. inzinkbare ketting m. draaibare buisuitloop | | | | | | | | | |
| 0432865 | | chroom | 21236000 | stuk | 87,00 | 210 | 0 |  | Accessoires en spiegels |
| 1-gats wastafelkraan m. inzinkbare ketting m. gegoten uitloop | | | | | | | | | |
| 0434965 | keramisch | chroom | 21067000 | stuk | 151,00 | 210 | 0 |  | Douchewanden |
| 1-gats wastafelkraan m. waste m. gegoten uitloop | | | | | | | | | |
| 0433128 | | chroom | 21238000 | stuk | 211,00 | 210 | 0 |  | Toebehoren & afvoeren |
| 1-gats wastafelkraan m. inzinkbare ketting m. gegoten uitloop | | | | | | | | | |
| 0434752 | | chroom | 21353000 | stuk | 142,00 | 210 | 1 |  | Spoel- & installatiesystemen |
| badkraan onderuitloop z. koppelingen m. omstel z. garnituur | | | | | | | | | |
| 0435686 | | chroom | 25344000 | stuk | 90,50 | 210 | 1 |  | Badkamermeubelen en toiletkasten |
| 0430420 | S-koppeling m. rozet per paar 1/2"x3/4" | chroom | 1200100M | paar | 10,75 | 210 | 0 | | |
| 0430447 | muurplaatkoppeling per paar 3/4"x15mm | chroom | 1201800M | paar | 16,00 | 210 | 0 | | |
| badkraan HOH=15cm z. koppelingen m. omstel z. garnituur | | | | | | | | | |
| 0435341 | keramisch | chroom | 25426000 | stuk | 143,00 | 210 | 0 |  | Gootstenen en wastroggen |
| 0430420 | S-koppeling m. rozet per paar 1/2"x3/4" | chroom | 1200100M | paar | 10,75 | 210 | 0 | | |
| 0430447 | muurplaatkoppeling per paar 3/4"x15mm | chroom | 1201800M | paar | 16,00 | 210 | 0 | | |
| douchekraan HOH=15cm z. koppelingen z. omstel | | | | | | | | | |
| 0435716 | | chroom | 26280000 | stuk | 65,50 | 210 | 0 |  | Utiliteit |
| 0435554 | keramisch | chroom | 26336000 | stuk | 84,50 | 210 | 0 | | |
| 0430420 | S-koppeling m. rozet per paar 1/2"x3/4" | chroom | 1200100M | paar | 10,75 | 210 | 0 | | |
| 0430447 | muurplaatkoppeling per paar 3/4"x15mm | chroom | 1201800M | paar | 16,00 | 210 | 0 | | |

| Art.nr | Specificaties | Kleur | Lev.nr | Ehd | Prijs | Grp | CC |
|--------|---------------|-------|--------|-----|-------|-----|----|
|--------|---------------|-------|--------|-----|-------|-----|----|

Grohe Atlanta

douchekraan HOH=12cm z. koppelingen z. omstel

| | | | | | | | |
|---------|---|-------|----------|------|-------|-----|---|
| 0435732 | | chrom | 26291000 | stuk | 60,50 | 210 | 0 |
| 0430412 | S-koppeling m. rozet per paar 3/8"x1/2" | chrom | 1200000M | paar | 10,25 | 210 | 0 |
| 0430439 | muurplaatkoppeling per paar 1/2"x12mm | chrom | 1201700M | paar | 12,75 | 210 | 0 |



Sanitair producten

Baden /
douchebakken /
stoomcabines

douchekraan HOH=15cm z. koppelingen m. omstel z. uitloop

| | | | | | | | |
|---------|---|-------|----------|------|--------|-----|---|
| 0435708 | | chrom | 26265000 | stuk | 113,00 | 210 | 0 |
| 0430420 | S-koppeling m. rozet per paar 1/2"x3/4" | chrom | 1200100M | paar | 10,75 | 210 | 0 |
| 0430447 | muurplaatkoppeling per paar 3/4"x15mm | chrom | 1201800M | paar | 16,00 | 210 | 0 |



Kranen

douchekraan HOH=12cm z. koppelingen m. omstel z. uitloop

| | | | | | | | |
|---------|---|-------|----------|------|-------|-----|---|
| 0435759 | | chrom | 26780000 | stuk | 65,00 | 210 | 0 |
| 0430412 | S-koppeling m. rozet per paar 3/8"x1/2" | chrom | 1200000M | paar | 10,25 | 210 | 0 |
| 0430439 | muurplaatkoppeling per paar 1/2"x12mm | chrom | 1201700M | paar | 12,75 | 210 | 0 |



Douchegarnituur

Accessoires en
spiegels

douchekraan 1/2" m. doucheaansluiting 3/4" koud/warm

| | | | | | | | |
|---------|--|-------|----------|------|-------|-----|---|
| 0435724 | | chrom | 26284000 | stuk | 34,50 | 210 | 1 |
|---------|--|-------|----------|------|-------|-----|---|



Douchewanden

tapkraan 1/2" m. S-uitloop

| | | | | | | | |
|---------|--|-------|----------|------|-------|-----|---|
| 0435775 | | chrom | 30472000 | stuk | 47,75 | 210 | 0 |
|---------|--|-------|----------|------|-------|-----|---|



Toebehoren &
afvoeren

Spoel- &
installatiesystemen

tapkraan 1/2"

| | | | | | | | |
|---------|--|-------|----------|------|-------|-----|---|
| 0435767 | | chrom | 30084000 | stuk | 36,50 | 210 | 0 |
|---------|--|-------|----------|------|-------|-----|---|



Badkamermeubelen
en toiletkasten

Gootstenen en
wastroggen

tapkraan 1/2" m. slangwartel

| | | | | | | | |
|---------|--|-------|----------|------|-------|-----|---|
| 0438952 | | chrom | 30086000 | stuk | 41,50 | 210 | 1 |
|---------|--|-------|----------|------|-------|-----|---|



Utiliteit

wandkraan z. koppelingen m. vaste uitloop

| | | | | | | | |
|---------|---|-------|----------|------|--------|-----|---|
| 0300578 | | chrom | 32120000 | stuk | 152,00 | 210 | 1 |
| 0430420 | S-koppeling m. rozet per paar 1/2"x3/4" | chrom | 1200100M | paar | 10,75 | 210 | 0 |
| 0430447 | muurplaatkoppeling per paar 3/4"x15mm | chrom | 1201800M | paar | 16,00 | 210 | 0 |



hoekstopkraan m. rozet m. steeksleutel

| | | | | | | | |
|---------|-----------|-------|----------|------|-------|-----|---|
| 0431141 | 1/2"x10mm | chrom | 22917000 | stuk | 31,00 | 210 | 1 |
|---------|-----------|-------|----------|------|-------|-----|---|











Grohe Atrio-Ypsilon

toiletkraan

| | | | | | | | |
|---------|--|-------|----------|------|--------|-----|---|
| 0464962 | | chrom | 20021000 | stuk | 208,00 | 162 | 0 |
|---------|--|-------|----------|------|--------|-----|---|



| Art.nr | Specificaties | Kleur | Lev.nr | Ehd | Prijs | Grp | CC | | |
|---|---|-------|----------|------|---------|-----|----|---|---|
| | | | | | | | | Grohe Atrio-Ypsilon | |
| wastafelkraan 0464964 | | chrom | 32457000 | stuk | 412,00 | 162 | 1 |  | Sanitair producten |
| 1-gats wastafelkraan m. waste hoogmodel 0464929 | | chrom | 21019000 | stuk | 412,00 | 162 | 0 |  | Baden / douchebakken / stoomcabines |
| 3-gats wastafelkraan m. waste m. hoge uitloop 0464899 | | chrom | 20008000 | stuk | 642,00 | 162 | 1 |  | Kranen |
| 3-gats wandkraan inbouwdeel + afbouwdeel 0410005 | | chrom | 20000000 | stuk | 577,00 | 162 | 1 |  | Douchegarnituur |
| badkraan m. omstel m. koppelingen 0464953 | | chrom | 25010000 | stuk | 541,00 | 162 | 0 |  | Accessoires en spiegels |
| badkraan vrijstaande montage m. standpijpen 765mm 0464867 | | chrom | 25044000 | stuk | 1948,00 | 162 | 1 |  | Douchewanden |
| badkraan staand 0442479 | | chrom | 25059000 | stuk | 1019,00 | 162 | 1 |  | Toebehoren & afvoeren |
| opbouwdeel voor 4-gats badrandcombinatie 0464866 | | chrom | 19141000 | stuk | 859,00 | 162 | 1 |  | Spoel- & installatiesystemen |
| 0443395 | inbouwdeel 4-gats badrandcombinatie voor tegelrandmontage | | 34086000 | stuk | 1437,00 | 218 | 1 | | Badkamermeubelen en toiletkasten |
| douchekraan z. omstel m. koppelingen 0464988 | | chrom | 26003000 | stuk | 385,00 | 162 | 1 |  | Gootstenen en wastroggen |
| | | | | | | | | | Utiliteit |

| | Art.nr | Specificaties | Kleur | Lev.nr | Ehd | Prijs | Grp | CC |
|---|----------------------------|---|-------|----------|------|--------|-----|----|
| | Grohe Atrio-Ypsilon | | | | | | | |
| Sanitair producten | | badthermostaat m. omstel m. koppelingen | | | | | | |
|  | 0465011 | | chrom | 34061000 | stuk | 842,00 | 218 | 1 |
| Baden / douchebakken / stoomcabines | | douchethermostaat z. omstel m. koppelingen | | | | | | |
|  | 0465003 | | chrom | 34010000 | stuk | 599,00 | 218 | 0 |
| Kranen | | opbouwdeel voor inbouwbadkraan | | | | | | |
|  | 0464865 | | chrom | 19135000 | stuk | 486,00 | 162 | 1 |
| Douchegarnituur | 0443336 | inbouwdeel voor inbouwbadthermostaat 3/4" | | 34103000 | stuk | 693,00 | 218 | 0 |
| Accessoires en spiegels | | opbouwdeel voor thermostatische douchekraan | | | | | | |
|  | 0464864 | | chrom | 19144000 | stuk | 486,00 | 162 | 1 |
| Douchewanden | 0721387 | inbouwdeel douchethermostaat | | 34100000 | stuk | 249,00 | 218 | 0 |
| Toebehoren & afvoeren | | centraal thermostaat opbouwdeel voor 34101/34102 | | | | | | |
|  | 0464872 | | chrom | 19147000 | stuk | 357,00 | 162 | 1 |
| Spoel- & installatiesystemen | 0443344 | inbouwdeel centraal thermostaat 1/2" | | 34101000 | stuk | 200,00 | 218 | 1 |
| | 0443352 | inbouwdeel centraal thermostaat 3/4" | | 34102000 | stuk | 422,00 | 218 | 1 |
| | 0721395 | verlengset voor 1/2" thermostaat | | 47653000 | stuk | 197,00 | 218 | 1 |
| Badkamermeubelen en toiletkasten | | opbouwdeel voor stopkraan 29800/29818 | | | | | | |
|  | 0464856 | | chrom | 19069000 | stuk | 113,00 | 162 | 1 |
| | 0434167 | inbouwdeel Longlife inbouwstopkraan z. greep 1/2" | | 29800000 | stuk | 15,50 | 210 | 0 |
| Gootstenen en wastroggen | | baduitloop | | | | | | |
|  | 0464848 | | chrom | 13139000 | stuk | 155,00 | 162 | 1 |
| Utiliteit | | Grohe Atrio-Jota | | | | | | |
|  | | toiletkraan | | | | | | |
| | 0464962 | | chrom | 20021000 | stuk | 208,00 | 162 | 0 |
| | | wastafelkraan | | | | | | |
|  | 0464964 | | chrom | 32457000 | stuk | 412,00 | 162 | 1 |

| Art.nr | Specificaties | Kleur | Lev.nr | Ehd | Prijs | Grp | CC |
|--------|---------------|-------|--------|-----|-------|-----|----|
|--------|---------------|-------|--------|-----|-------|-----|----|

Grohe Atrio-Jota

1-gats wastafelkraan m. waste hoogmodel

| | | | | | | | |
|---------|--|-------|----------|------|--------|-----|---|
| 0465100 | | chrom | 21022000 | stuk | 412,00 | 162 | 0 |
|---------|--|-------|----------|------|--------|-----|---|



Sanitair producten

3-gats wastafelkraan m. waste hoge uitloop

| | | | | | | | |
|---------|--|-------|----------|------|--------|-----|---|
| 0465070 | | chrom | 20009000 | stuk | 642,00 | 162 | 1 |
|---------|--|-------|----------|------|--------|-----|---|

Baden /
douchebakken /
stoomcabines

Kranen

3-gats wandkraan inbouwdeel + afbouwdeel

| | | | | | | | |
|---------|--|-------|----------|------|--------|-----|---|
| 0410014 | | chrom | 20019000 | stuk | 577,00 | 162 | 1 |
|---------|--|-------|----------|------|--------|-----|---|



Douchegarnituur

Accessoires en
spiegels**badkraan m. omstel m. koppelingen**

| | | | | | | | |
|---------|--|-------|----------|------|--------|-----|---|
| 0465135 | | chrom | 25011000 | stuk | 541,00 | 162 | 1 |
|---------|--|-------|----------|------|--------|-----|---|



Douchewanden

Toebehoren &
afvoeren**badkraan vrijstaande montage m. standpijpen 765mm**

| | | | | | | | |
|---------|--|-------|----------|------|---------|-----|---|
| 0464868 | | chrom | 25046000 | stuk | 1948,00 | 162 | 1 |
|---------|--|-------|----------|------|---------|-----|---|

Spoel- &
installatiesystemen**badkraan staand**

| | | | | | | | |
|---------|--|-------|----------|------|---------|-----|---|
| 0442480 | | chrom | 25062000 | stuk | 1019,00 | 162 | 1 |
|---------|--|-------|----------|------|---------|-----|---|

Badkamermeubelen
en toiletkastenGootstenen en
wastroggen**douchekraan z. omstel m. koppelingen**

| | | | | | | | |
|---------|--|-------|----------|------|--------|-----|---|
| 0465151 | | chrom | 26004000 | stuk | 385,00 | 162 | 1 |
|---------|--|-------|----------|------|--------|-----|---|



Utiliteit

badthermostaat m. omstel m. koppelingen

| | | | | | | | |
|---------|--|-------|----------|------|--------|-----|---|
| 0465186 | | chrom | 34062000 | stuk | 842,00 | 218 | 1 |
|---------|--|-------|----------|------|--------|-----|---|

**douchethermostaat z. omstel m. koppelingen**









| | | | | | | | |
|---------|--|-------|----------|------|--------|-----|---|
| 0465178 | | chrom | 34011000 | stuk | 599,00 | 218 | 0 |
|---------|--|-------|----------|------|--------|-----|---|

**thermostatische douchekraan opbouwdeel voor 34100**

| | | | | | | | |
|---------|--|-------|----------|------|--------|-----|---|
| 0465046 | | chrom | 19145000 | stuk | 486,00 | 162 | 1 |
|---------|--|-------|----------|------|--------|-----|---|

| | | | | | | | |
|---------|------------------------------|--|----------|------|--------|-----|---|
| 0721387 | inbouwdeel douchethermostaat | | 34100000 | stuk | 249,00 | 218 | 0 |
|---------|------------------------------|--|----------|------|--------|-----|---|



| | Art.nr | Specificaties | Kleur | Lev.nr | Ehd | Prijs | Grp | CC |
|---|---|---|--------|----------|------|--------|-----|----|
| | Grohe Atrio-Jota | | | | | | | |
| | centraal thermostaat opbouwdeel voor 34101/34102 | | | | | | | |
| Sanitair producten |  | 0465054 | chroom | 19148000 | stuk | 357,00 | 162 | 1 |
| | | 0443344 inbouwdeel centraal thermostaat 1/2" | | 34101000 | stuk | 200,00 | 218 | 1 |
| | | 0443352 inbouwdeel centraal thermostaat 3/4" | | 34102000 | stuk | 422,00 | 218 | 1 |
| | | 0721395 verlengset voor 1/2" thermostaat | | 47653000 | stuk | 197,00 | 218 | 1 |
| Baden / douchebakken / stoomcabines | | | | | | | | |
| | opbouwdeel voor stopkraan | | | | | | | |
| Kranen |  | 0465038 | chroom | 19088000 | stuk | 113,00 | 162 | 1 |
| | | 0434167 inbouwdeel Longlife inbouwstopkraan z. greep 1/2" | | 29800000 | stuk | 15,50 | 210 | 0 |
| | | 0434175 inbouwdeel Longlife inbouwstopkraan z. greep 15mm | | 29801000 | stuk | 16,75 | 210 | 0 |
| | | 0434183 inbouwdeel Longlife inbouwstopkraan z. greep 3/4" | | 29802000 | stuk | 26,25 | 210 | 1 |
| | | 0434191 inbouwdeel Longlife inbouwstopkraan z. greep 22mm | | 29804000 | stuk | 26,75 | 210 | 1 |
| Douchegarnituur | | | | | | | | |
| | baduitloop | | | | | | | |
| Accessoires en spiegels |  | 0464848 | chroom | 13139000 | stuk | 155,00 | 162 | 1 |
| | | | | | | | | |
| | Grohe Concetto | | | | | | | |
| Douchewanden |  | 1-gats toiletkraan | | | | | | |
| | | 0434047 | chroom | 32207000 | stuk | 79,00 | 163 | 1 |
| Toebehoren & afvoeren | | | | | | | | |
| Spoel- & installatiesystemen |  | 1-gats wastafelkraan m. waste | | | | | | |
| | | 0434034 | chroom | 32204000 | stuk | 99,50 | 162 | 1 |
| Badkamermeubelen en toiletkasten | | | | | | | | |
| Gootstenen en wastroggen |  | 1-gats bidetkraan m. waste | | | | | | |
| | | 0434035 | chroom | 32208000 | stuk | 99,50 | 162 | 1 |
| Utiliteit | | | | | | | | |
| |  | 1-gats wastafelkraan m. ketting | | | | | | |
| | | 0434048 | chroom | 32206000 | stuk | 88,50 | 163 | 1 |
| | badkraan m. doucheset | | | | | | | |
| |  | 0434036 | chroom | 32212000 | stuk | 187,00 | 162 | 1 |
| | | | | | | | | |
| | badkraan | | | | | | | |
| |  | 0434037 | chroom | 32211000 | stuk | 143,00 | 162 | 1 |

| Art.nr | Specificaties | Kleur | Lev.nr | Ehd | Prijs | Grp | CC |
|--------|---------------|-------|--------|-----|-------|-----|----|
|--------|---------------|-------|--------|-----|-------|-----|----|

Grohe Concetto

douchekraan

| | | | | | | | |
|---------|--|-------|----------|------|-------|-----|---|
| 0434038 | | chrom | 32210000 | stuk | 99,50 | 162 | 1 |
|---------|--|-------|----------|------|-------|-----|---|



Sanitair producten

Baden /
douchebakken /
stoomcabines**opbouwdeel voor inbouwdouchekraan**

| | | | | | | | |
|---------|--|-------|----------|------|-------|-----|---|
| 0434049 | | chrom | 19345000 | stuk | 51,50 | 163 | 1 |
|---------|--|-------|----------|------|-------|-----|---|



Kranen

Douchegarnituur

opbouwdeel voor inbouwbadkraan

| | | | | | | | |
|---------|--|-------|----------|------|-------|-----|---|
| 0434050 | | chrom | 19346000 | stuk | 75,00 | 163 | 1 |
|---------|--|-------|----------|------|-------|-----|---|

Accessoires en
spiegels

Douchewanden

Grohe Grohtherm-1000

douchethermostaat HOH=15cm

| | | | | | | | |
|---------|---|-------|----------|------|--------|-----|---|
| 0102478 | m. koppelingen | chrom | 34143000 | stuk | 186,00 | 218 | 0 |
| 0102479 | z. koppelingen | chrom | 34146000 | stuk | 179,00 | 218 | 0 |
| 0430420 | S-koppeling m. rozet per paar 1/2"x3/4" | chrom | 1200100M | paar | 10,75 | 210 | 0 |
| 0430447 | muurplaatkoppeling per paar 3/4"x15mm | chrom | 1201800M | paar | 16,00 | 210 | 0 |

Toebehoren &
afvoeren**douchethermostaat HOH=12cm**

| | | | | | | | |
|---------|---|-------|----------|------|--------|-----|---|
| 0102480 | z. koppelingen | chrom | 34147000 | stuk | 179,00 | 218 | 0 |
| 0430412 | S-koppeling m. rozet per paar 3/8"x1/2" | chrom | 1200000M | paar | 10,25 | 210 | 0 |
| 0430439 | muurplaatkoppeling per paar 1/2"x12mm | chrom | 1201700M | paar | 12,75 | 210 | 0 |

Spoel- &
installatiesystemenBadkamermeubelen
en toiletkasten**renovatieset = 1xthermostaat 34146 HOH=15cm**

| | | | | | | | |
|---------|---|-------|----------|------|--------|-----|---|
| 0102483 | | chrom | 34152000 | stuk | 230,00 | 250 | 0 |
| 0430420 | S-koppeling m. rozet per paar 1/2"x3/4" | chrom | 1200100M | paar | 10,75 | 210 | 0 |
| 0430447 | muurplaatkoppeling per paar 3/4"x15mm | chrom | 1201800M | paar | 16,00 | 210 | 0 |

Gootstenen en
wastroggen**renovatieset = 1xthermostaat 34147 HOH=12cm**

| | | | | | | | |
|---------|---|-------|----------|------|--------|-----|---|
| 0102485 | | chrom | 34153000 | stuk | 230,00 | 250 | 0 |
| 0430412 | S-koppeling m. rozet per paar 3/8"x1/2" | chrom | 1200000M | paar | 10,25 | 210 | 0 |
| 0430439 | muurplaatkoppeling per paar 1/2"x12mm | chrom | 1201700M | paar | 12,75 | 210 | 0 |



Utiliteit

badthermostaat m. omstel m. koppelingen

| | | | | | | | |
|---------|--|-------|----------|------|--------|-----|---|
| 0102486 | | chrom | 34155000 | stuk | 225,00 | 218 | 0 |
|---------|--|-------|----------|------|--------|-----|---|

**badthermostaat m. omstel z. koppelingen**

| | | | | | | | |
|---------|---|-------|----------|------|--------|-----|---|
| 0102487 | | chrom | 34156000 | stuk | 217,00 | 218 | 0 |
| 0430420 | S-koppeling m. rozet per paar 1/2"x3/4" | chrom | 1200100M | paar | 10,75 | 210 | 0 |
| 0430447 | muurplaatkoppeling per paar 3/4"x15mm | chrom | 1201800M | paar | 16,00 | 210 | 0 |



| Art.nr | Specificaties | Kleur | Lev.nr | Ehd | Prijs | Grp | CC |
|--------|---------------|-------|--------|-----|-------|-----|----|
|--------|---------------|-------|--------|-----|-------|-----|----|

Grohe Grohtherm-1000

opbouwdeel voor stopkraan 29800 - 29806

| | | | | | | | |
|---------|---|-------|----------|------|-------|-----|---|
| 0450465 | | chrom | 19237000 | stuk | 32,25 | 163 | 1 |
| 0434167 | inbouwdeel Longlife inbouwstopkraan z. greep 1/2" | | 29800000 | stuk | 15,50 | 210 | 0 |



Sanitair producten

Baden /
douchebakken /
stoomcabines

inbouw centraalthermostaat compleet

| | | | | | | | |
|---------|--|-------|----------|------|--------|-----|---|
| 0450466 | | chrom | 34160000 | stuk | 202,00 | 163 | 1 |
|---------|--|-------|----------|------|--------|-----|---|



Kranen

Douchegarnituur

inbouw douchethermostaat compleet

| | | | | | | | |
|---------|--|-------|----------|------|--------|-----|---|
| 0450467 | | chrom | 34161000 | stuk | 249,00 | 163 | 1 |
|---------|--|-------|----------|------|--------|-----|---|



Accessoires en
spiegels

Douchewanden

Grohe Grohtherm-2000

douchethermostaat HOH=15cm

| | | | | | | | |
|---------|------------------------------------|-------|----------|------|--------|-----|---|
| 0102488 | m. koppelingen | chrom | 34169000 | stuk | 252,00 | 218 | 0 |
| 0102489 | z. koppelingen | chrom | 34170000 | stuk | 241,00 | 218 | 0 |
| 0430142 | S-koppeling compleet 1/2"x3/4" wit | | 12058L00 | stuk | 25,25 | 210 | 0 |



Toebehoren &
afvoeren

Spoel- &
installatiesystemen

douchethermostaat HOH=12cm

| | | | | | | | |
|---------|---|-------|----------|------|--------|-----|---|
| 0102490 | z. koppelingen | chrom | 34171000 | stuk | 241,00 | 218 | 0 |
| 0430412 | S-koppeling m. rozet per paar 3/8"x1/2" chrom | | 1200000M | paar | 10,25 | 210 | 0 |
| 0430439 | muurplaatkoppeling per paar 1/2"x12mm chrom | | 1201700M | paar | 12,75 | 210 | 0 |



Badkamermeubelen
en toiletkasten

badthermostaat m. omstel m. koppelingen HOH=15cm

| | | | | | | | |
|---------|--|-------|----------|------|--------|-----|---|
| 0102491 | | chrom | 34174000 | stuk | 303,00 | 218 | 0 |
|---------|--|-------|----------|------|--------|-----|---|



Gootstenen en
wastroggen

Utiliteit

badthermostaat m. omstel z. koppelingen HOH=15cm

| | | | | | | | |
|---------|------------------------------------|-------|----------|------|--------|-----|---|
| 0102492 | | chrom | 34175000 | stuk | 291,00 | 218 | 0 |
| 0430142 | S-koppeling compleet 1/2"x3/4" wit | | 12058L00 | stuk | 25,25 | 210 | 0 |



badthermostaat m. staande koppelingen

| | | | | | | | |
|---------|--|-------|----------|------|--------|-----|---|
| 0102493 | | chrom | 34176000 | stuk | 377,00 | 218 | 1 |
|---------|--|-------|----------|------|--------|-----|---|



renovatieset = 1xthermostaat 34149 HOH=15cm

| | | | | | | | |
|---------|--|-------|----------|------|--------|-----|---|
| 0102497 | | chrom | 34195000 | stuk | 393,00 | 218 | 0 |
|---------|--|-------|----------|------|--------|-----|---|



| Art.nr | Specificaties | Kleur | Lev.nr | Ehd | Prijs | Grp | CC |
|--------|---------------|-------|--------|-----|-------|-----|----|
|--------|---------------|-------|--------|-----|-------|-----|----|

Grohe Grohtherm-2000

opbouwdeel voor inbouwcentraalthermostaat 34213 - 34214

| | | | | | | | |
|---------|---------------------------------------|--------|----------|------|--------|-----|---|
| 0450468 | | chroom | 19240000 | stuk | 71,00 | 163 | 1 |
| 0450485 | inbouwdeel centraalthermostaat 1/2" | chroom | 34213000 | stuk | 191,00 | 163 | 1 |
| 0450486 | inbouwdeel centraalthermostaat 3/4" | chroom | 34214000 | stuk | 307,00 | 163 | 1 |
| 0450487 | verlengset voor 34211 - 34213 - 34214 | | 47200000 | stuk | 94,50 | 163 | 1 |



Sanitair producten

Baden /
douchebakken /
stoomcabines

opbouwdeel voor inbouwdouchethermostaat 34211

| | | | | | | | |
|---------|---------------------------------------|--------|----------|------|--------|-----|---|
| 0450469 | | chroom | 19241000 | stuk | 85,50 | 163 | 1 |
| 0450483 | inbouwdeel douchethermostaat 1/2" | chroom | 34211000 | stuk | 217,00 | 163 | 0 |
| 0450487 | verlengset voor 34211 - 34213 - 34214 | | 47200000 | stuk | 94,50 | 163 | 1 |



Kranen

Douchegarnituur

opbouwdeel voor inbouwbadthermostaat 34212

| | | | | | | | |
|---------|--------------------------------|--------|----------|------|--------|-----|---|
| 0450470 | | chroom | 19242000 | stuk | 85,50 | 163 | 1 |
| 0450484 | inbouwdeel badthermostaat 1/2" | chroom | 34212000 | stuk | 260,00 | 163 | 0 |
| 0450488 | verlengset voor 34212 | | 47201000 | stuk | 142,00 | 163 | 1 |

Accessoires en
spiegels

opbouwdeel voor stopkraan 29800 - 29806

| | | | | | | | |
|---------|---|--------|----------|------|-------|-----|---|
| 0450471 | | chroom | 19243000 | stuk | 39,75 | 163 | 1 |
| 0434167 | inbouwdeel Longlife inbouwstopkraan z. greep 1/2" | | 29800000 | stuk | 15,50 | 210 | 0 |



Douchewanden

Toebehoren &
afvoeren

Grohe Grohtherm-3000

douchethermostaat HOH=15cm m. koppelingen

| | | | | | | | |
|---------|--|--------|----------|------|--------|-----|---|
| 0102494 | | chroom | 34179000 | stuk | 344,00 | 218 | 0 |
|---------|--|--------|----------|------|--------|-----|---|

Spoel- &
installatiesystemenBadkamermeubelen
en toiletkasten

badthermostaat m. omstel m. koppelingen

| | | | | | | | |
|---------|--|--------|----------|------|--------|-----|---|
| 0102495 | | chroom | 34185000 | stuk | 413,00 | 218 | 0 |
|---------|--|--------|----------|------|--------|-----|---|

Gootstenen en
wastroggen

badthermostaat m. staande koppelingen

| | | | | | | | |
|---------|--|--------|----------|------|--------|-----|---|
| 0102496 | | chroom | 34187000 | stuk | 516,00 | 218 | 1 |
|---------|--|--------|----------|------|--------|-----|---|



Utiliteit

renovatieset = 1xthermostaat 34179 HOH=15cm









| | | | | | | | |
|---------|--|--------|----------|------|--------|-----|---|
| 0102498 | | chroom | 34196000 | stuk | 485,00 | 218 | 0 |
|---------|--|--------|----------|------|--------|-----|---|











opbouwdeel voor inbouwcentraalthermostaat 34213 - 34214

| | | | | | | | |
|---------|---------------------------------------|--------|----------|------|--------|-----|---|
| 0450479 | | chroom | 19250000 | stuk | 128,00 | 163 | 1 |
| 0450485 | inbouwdeel centraalthermostaat 1/2" | chroom | 34213000 | stuk | 191,00 | 163 | 1 |
| 0450486 | inbouwdeel centraalthermostaat 3/4" | chroom | 34214000 | stuk | 307,00 | 163 | 1 |
| 0450487 | verlengset voor 34211 - 34213 - 34214 | | 47200000 | stuk | 94,50 | 163 | 1 |



| | Art.nr | Specificaties | Kleur | Lev.nr | Ehd | Prijs | Grp | CC |
|---|---|---|-------|----------|------|---------|-----|----|
| | Grohe Grohtherm-3000 | | | | | | | |
| Sanitair producten | opbouwdeel voor inbouwbadthermostaat 34212 | | | | | | | |
| | 0450480 | | chrom | 19253000 | stuk | 142,00 | 163 | 1 |
| | 0450484 | inbouwdeel badthermostaat 1/2" chrom | | 34212000 | stuk | 260,00 | 163 | 0 |
| | 0450488 | verlengset voor 34212 | | 47201000 | stuk | 142,00 | 163 | 1 |
| Baden / douchebakken / stoomcabines |  | | | | | | | |
| | opbouwdeel voor inbouwdouchethermostaat 34211 | | | | | | | |
| Kranen | 0450481 | | chrom | 19255000 | stuk | 142,00 | 163 | 1 |
| | 0450483 | inbouwdeel douchethermostaat 1/2" chrom | | 34211000 | stuk | 217,00 | 163 | 0 |
| | 0450487 | verlengset voor 34211 - 34213 - 34214 | | 47200000 | stuk | 94,50 | 163 | 1 |
| |  | | | | | | | |
| Douchegarnituur | opbouwdeel voor stopkraan 29800 - 29806 | | | | | | | |
| Accessoires en spiegels | 0450482 | | chrom | 19258000 | stuk | 46,50 | 163 | 1 |
| | 0434167 | inbouwdeel Longlife inbouwstopkraan z. greep 1/2" | | 29800000 | stuk | 15,50 | 210 | 0 |
| |  | | | | | | | |
| Douchewanden | Grohe Grohtherm XL | | | | | | | |
| Toebehoren & afvoeren | thermostaatkraan 1 1/2" z. koppelingen | | | | | | | |
| | 0442526 | | chrom | 35085000 | stuk | 1341,00 | 218 | 1 |
| |  | | | | | | | |
| Spoel- & installatiesystemen | thermostaatkraan 2" z. koppelingen | | | | | | | |
| | 0442534 | | chrom | 35087000 | stuk | 1459,00 | 333 | 1 |
| |  | | | | | | | |
| Badkamermeubelen en toiletkasten | Micro onderbouwthermostaat | | | | | | | |
| Gootstenen en wastroggen | 0442798 | | | 34023000 | stuk | 111,00 | 218 | 0 |
| | |  | | | | | | |
| Utiliteit | Grohe Chiara | | | | | | | |
| | 1-gats wastafelkraan m. waste | | | | | | | |
| | 0437109 | | chrom | 32303000 | stuk | 293,00 | 162 | 0 |
| | |  | | | | | | |
| | 1-gats wastafelkraan m. waste m. uittrekbare uitloop | | | | | | | |
| | 0437117 | | chrom | 32304000 | stuk | 388,00 | 162 | 1 |
| |  | | | | | | | |
| | 1-gats bidetkraan m. waste | | | | | | | |
| | 0437125 | | chrom | 32305000 | stuk | 389,00 | 162 | 1 |
| |  | | | | | | | |

| Art.nr | Specificaties | Kleur | Lev.nr | Ehd | Prijs | Grp | CC | | |
|--|---------------|-------|----------|------|--------|-----|----|---|---|
| | | | | | | | | Grohe Chiara | |
| badkraan m. koppelingen m. omstel 0437133 | | chrom | 32306000 | stuk | 366,00 | 162 | 0 |  | Sanitair producten |
| douchekraan HOH=15cm m. koppelingen 0437176 | | chrom | 32307000 | stuk | 278,00 | 162 | 1 |  | Baden / douchebakken / stoomcabines |
| badthermostaat m. omstel m. koppelingen 0437206 | | chrom | 34070000 | stuk | 665,00 | 218 | 1 |  | Douchegarnituur |
| douchethermostaat z. omstel m. koppelingen 0437214 | | chrom | 34071000 | stuk | 558,00 | 218 | 0 |  | Accessoires en spiegels |
| opbouwdeel voor inbouwbadkraan 0434091 | | chrom | 19155000 | stuk | 241,00 | 162 | 0 |  | Douchewanden |
| 0439428 inbouwdeel bad-/douchekraan m. omstel 1/2" | | | 33961000 | stuk | 220,00 | 162 | 0 | | |
| opbouwdeel voor inbouwstopkraan 0437273 | | chrom | 19838000 | stuk | 73,00 | 162 | 1 |  | Toebehoren & afvoeren |
| opbouwdeel voor drieweg-omstelling 0434100 | | chrom | 19906000 | stuk | 109,00 | 218 | 1 |  | Badkamermeubelen en toiletkasten |
| 0434169 inbouwdeel 3-weg omstelling keramisch | | | 29706000 | stuk | 132,00 | 210 | 1 | | |
| baduitloop 3/4"x17cm 0442585 | | chrom | 13614000 | stuk | 143,00 | 210 | 1 |  | Gootstenen en wastroggen |
| | | | | | | | | Grohe Contropress | |
| 1-gats wastafelkraan zelfsluitend 1/2" 0720447 | | chrom | 36173000 | stuk | 101,00 | 218 | 0 |  | Utiliteit |

| | Art.nr | Specificaties | Kleur | Lev.nr | Ehd | Prijs | Grp | CC |
|---|---|--|----------|----------|-------|--------|-----|----|
| Sanitair producten | Grohe Contropress | | | | | | | |
| | | tapkraan zelfsluitend 1/2" | | | | | | |
| | | 0720448 warm | chrom | 36177000 | stuk | 83,50 | 162 | 1 |
| | 0437046 koud | chrom | 36176000 | stuk | 83,50 | 162 | 1 | |
| Baden / douchebakken / stoomcabines |  | | | | | | | |
| Kranen |  | | | | | | | |
| Douchegarnituur | Grohe Costa | | | | | | | |
| |  | toiletkraan 1/2" waterbesparend | | | | | | |
| | 0436127 | | chrom | 20404000 | stuk | 27,25 | 163 | 0 |
| Accessoires en spiegels | | | | | | | | |
| Douchewanden |  | toiletkraan 1/2" m. gegoten uitloop | | | | | | |
| | 0439995 | | chrom | 20017000 | stuk | 25,25 | 163 | 0 |
| Toebehoren & afvoeren | | | | | | | | |
| Spoel- & installatiesystemen |  | toiletkraan 1/2" hoog model waterbesparend | | | | | | |
| | 0442623 | | chrom | 30982000 | stuk | 48,00 | 163 | 0 |
| Badkamermeubelen en toiletkasten | | | | | | | | |
| Gootstenen en wastroggen |  | toiletkraan 1/2" m. hoge uitloop | | | | | | |
| | 0431400 | | chrom | 20477000 | stuk | 54,00 | 163 | 0 |
| Utiliteit | | | | | | | | |
| |  | 1-gats wastafelkraan m. inzinkbare ketting m. draaibare uitloop | | | | | | |
| | 0431494 | | chrom | 21337000 | stuk | 55,50 | 163 | 0 |
| |  | 1-gats wastafelkraan m. waste m. draaibare uitloop | | | | | | |
| | 0431516 | | chrom | 21343000 | stuk | 100,00 | 163 | 1 |
| |  | 1-gats bidetkraan m. waste | | | | | | |
| | 0434787 | | chrom | 24481000 | stuk | 115,00 | 163 | 1 |

| Art.nr | Specificaties | Kleur | Lev.nr | Ehd | Prijs | Grp | CC |
|--------|---------------|-------|--------|-----|-------|-----|----|
|--------|---------------|-------|--------|-----|-------|-----|----|

Grohe Costa

douчекraan HOH=12cm z. koppelingen z. omstel

| | | | | | | | |
|---------|---|--------|----------|------|-------|-----|---|
| 0431990 | | chroom | 26345000 | stuk | 42,75 | 163 | 0 |
| 0430412 | S-koppeling m. rozet per paar 3/8"x1/2" | chroom | 1200000M | paar | 10,25 | 210 | 0 |
| 0430439 | muurplaatkoppeling per paar 1/2"x12mm | chroom | 1201700M | paar | 12,75 | 210 | 0 |



Sanitair producten

douчекraan HOH=12cm z. koppelingen m. omstel S-uitloop

| | | | | | | | |
|---------|---|--------|----------|------|-------|-----|---|
| 0432059 | | chroom | 26781000 | stuk | 59,00 | 163 | 0 |
| 0430412 | S-koppeling m. rozet per paar 3/8"x1/2" | chroom | 1200000M | paar | 10,25 | 210 | 0 |
| 0430439 | muurplaatkoppeling per paar 1/2"x12mm | chroom | 1201700M | paar | 12,75 | 210 | 0 |

Baden /
douchebakken /
stoomcabines

Kranen

douчекraan HOH=12cm z. koppelingen m. omstel z. uitloop

| | | | | | | | |
|---------|---|--------|----------|------|-------|-----|---|
| 0432318 | | chroom | 26782000 | stuk | 42,25 | 163 | 0 |
| 0430412 | S-koppeling m. rozet per paar 3/8"x1/2" | chroom | 1200000M | paar | 10,25 | 210 | 0 |
| 0430439 | muurplaatkoppeling per paar 1/2"x12mm | chroom | 1201700M | paar | 12,75 | 210 | 0 |



Doucheapparatuur

douчекraan HOH=15cm z. koppelingen z. omstel

| | | | | | | | |
|---------|---|--------|----------|------|-------|-----|---|
| 0431907 | | chroom | 26308000 | stuk | 41,75 | 163 | 0 |
| 0430420 | S-koppeling m. rozet per paar 1/2"x3/4" | chroom | 1200100M | paar | 10,75 | 210 | 0 |
| 0430447 | muurplaatkoppeling per paar 3/4"x15mm | chroom | 1201800M | paar | 16,00 | 210 | 0 |

Accessoires en
spiegels**badkraan z. koppelingen m. omstel z. garnituur**

| | | | | | | | |
|---------|---|--------|----------|------|-------|-----|---|
| 0434566 | | chroom | 25453000 | stuk | 73,00 | 163 | 0 |
| 0430420 | S-koppeling m. rozet per paar 1/2"x3/4" | chroom | 1200100M | paar | 10,75 | 210 | 0 |
| 0430447 | muurplaatkoppeling per paar 3/4"x15mm | chroom | 1201800M | paar | 16,00 | 210 | 0 |



Douchewanden

tapkraan 1/2"

| | | | | | | | |
|---------|--|--------|----------|------|-------|-----|---|
| 0432407 | | chroom | 30089000 | stuk | 32,25 | 163 | 0 |
|---------|--|--------|----------|------|-------|-----|---|

Toebehoren &
afvoerenSpoel- &
installatiesystemen**tapkraan 1/2" m. beluchter**

| | | | | | | | |
|---------|--|--------|----------|------|-------|-----|---|
| 0438197 | | chroom | 30008000 | stuk | 21,00 | 163 | 0 |
|---------|--|--------|----------|------|-------|-----|---|

Badkamermeubelen
en toiletkastenGootstenen en
wastroggen

Grohe Essence

1-gats wastafelkraan m. waste

| | | | | | | | |
|---------|--|--------|----------|------|--------|-----|---|
| 0102499 | | chroom | 33562000 | stuk | 158,00 | 162 | 0 |
|---------|--|--------|----------|------|--------|-----|---|



Utiliteit









1-gats wastafelkraan m. ketting

| | | | | | | | |
|---------|--|--------|----------|------|--------|-----|---|
| 0102501 | | chroom | 33596000 | stuk | 147,00 | 162 | 0 |
|---------|--|--------|----------|------|--------|-----|---|

**1-gats bidetkraan m. waste**

| | | | | | | | |
|---------|--|--------|----------|------|--------|-----|---|
| 0102502 | | chroom | 33603000 | stuk | 222,00 | 162 | 1 |
|---------|--|--------|----------|------|--------|-----|---|



| | Art.nr | Specificaties | Kleur | Lev.nr | Ehd | Prijs | Grp | CC |
|---|---|---|------------|----------|------|--------|-----|----|
| | Grohe Essence | | | | | | | |
| Sanitair producten | | badkraan m. omstel | | | | | | |
|  | 0102503 | | chrom | 33624000 | stuk | 193,00 | 162 | 0 |
| Baden / douchebakken / stoomcabines | | | | | | | | |
| | badkraan m. Tempesta Trio | | | | | | | |
|  | 0102504 | | chrom | 33628000 | stuk | 260,00 | 162 | 0 |
| Kranen | | | | | | | | |
| | douchekraan | | | | | | | |
|  | 0102505 | | chrom | 33636000 | stuk | 158,00 | 162 | 0 |
| Douchegarnituur | | | | | | | | |
| Accessoires en spiegels | | | | | | | | |
| | opbouwdeel voor inbouwbadkraan 33961 | | | | | | | |
|  | 0442476 | | chrom | 19285000 | stuk | 111,00 | 162 | 1 |
| Douchewanden | 0439428 | inbouwdeel bad-/douchekraan m. omstel 1/2" | | 33961000 | stuk | 220,00 | 162 | 0 |
| Toebehoren & afvoeren | | | | | | | | |
| | opbouwdeel voor inbouwdouchekraan 33962 | | | | | | | |
|  | 0442475 | | chrom | 19286000 | stuk | 76,50 | 162 | 1 |
| Spoel- & installatiesystemen | 0439428 | inbouwdeel bad-/douchekraan m. omstel 1/2" | | 33961000 | stuk | 220,00 | 162 | 0 |
| Badkamermeubelen en toiletkasten | 0439444 | inbouwdeel douchekraan z. omstel 1/2" | | 33962000 | stuk | 149,00 | 162 | 0 |
| | Grohe Eurodisc | | | | | | | |
|  | | 2-gats wastafelkraan m. uittrekbare handdouche | | | | | | |
| Gootstenen en wastroggen | 0436232 | | wit/chroom | 33086000 | stuk | 228,00 | 210 | 1 |
| | wandkraan keramisch m. koppelingen m. onderuitloop | | | | | | | |
|  | 0437085 | | chrom | 33772000 | stuk | 208,00 | 210 | 0 |
| Utiliteit | | | | | | | | |
| | wandkraan keramisch m. koppelingen m. bovenuitloop | | | | | | | |
|  | 0437090 | | chrom | 33773000 | stuk | 208,00 | 210 | 1 |
| | Grohe Eurodisc2 | | | | | | | |
|  | | 1-gats wastafelkraan m. inzinkbare ketting | | | | | | |
| | 0437151 | | chrom | 33178001 | stuk | 144,00 | 163 | 0 |

| Art.nr | Specificaties | Kleur | Lev.nr | Ehd | Prijs | Grp | CC |
|--------|---------------|-------|--------|-----|-------|-----|----|
|--------|---------------|-------|--------|-----|-------|-----|----|

Grohe Eurodisc2

1-gats wastafelkraan m. waste
0437152

chromm 33183001 stuk 151,00 163 0



Sanitair producten

Baden /
douchebakken /
stoomcabines

1-gats wastafelkraan z. waste
0437150

chromm 32469001 stuk 144,00 163 0



Kranen

Douchegarnituur

1-gats bidetkraan m. waste
0437153

chromm 33244001 stuk 170,00 163 0

Accessoires en
spiegels

Douchewanden

Toebehoren &
afvoeren

douchekraan m. koppelingen z. omstel
0437156

chromm 33569001 stuk 151,00 163 0

Spoel- &
installatiesystemenBadkamermeubelen
en toiletkasten

badkraan m. koppelingen m. omstel
0437154

chromm 33390001 stuk 191,00 163 0

Gootstenen en
wastroggen

Utiliteit

badkraan m. koppelingen m. douchegarnituur
0437155

chromm 33395001 stuk 231,00 163 0



opbouwdeel voor inbouwdouchekraan 33962
0437149

chromm 19549001 stuk 70,00 163 1

0439444 inbouwdeel douchekraan z. omstel 1/2"

33962000 stuk 149,00 162 0



opbouwdeel voor inbouwbadkraan 33961
0437148

chromm 19548001 stuk 89,50 163 1

0439428 inbouwdeel bad-/douchekraan m. omstel 1/2"

33961000 stuk 220,00 162 0



Grohe Eurodisc SE

zelfsluitende wastafelkraan 1/2" m. menging
0410028

chromm 36233000 stuk 282,00 383 1



| | Art.nr | Specificaties | Kleur | Lev.nr | Ehd | Prijs | Grp | CC |
|---|---|------------------|-------|----------|------|--------|-----|----|
| | Grohe Eurodisc SE | | | | | | | |
| | zelfsluitende wastafelkraan 1/2" z. menging | | | | | | | |
| Sanitair producten | 0410027 | blauwe markering | | 36249000 | stuk | 245,00 | 383 | 1 |
| | 0410026 | rode markering | chrom | 36250000 | stuk | 245,00 | 383 | 1 |
| | Grohe Euroeco | | | | | | | |
| | 1-gats wastafelkraan 120mm m. hendel m. vaste uitloop | | | | | | | |
| Baden / douchebakken / stoomcabines | 0439037 | | chrom | 33108000 | stuk | 147,00 | 215 | 1 |
| | Grohe Europlus | | | | | | | |
| | 1-gats wastafelkraan body glad | | | | | | | |
| Kranen | 0439038 | | chrom | 33119000 | stuk | 179,00 | 210 | 1 |
| Douchegarnituur |  | | | | | | | |
| | 1-gats wastafelkraan laminaar glad | | | | | | | |
| Accessoires en spiegels | 0439039 | | chrom | 33124000 | stuk | 127,00 | 210 | 1 |
| Douchewanden |  | | | | | | | |
| | 1-gats wastafelkraan verhoogd m. hendel | | | | | | | |
| Toebehoren & afvoeren | 0438859 | | chrom | 33388000 | stuk | 208,00 | 210 | 1 |
| Spoel- & installatiesystemen |  | | | | | | | |
| | wandkraan z. koppelingen m. hendel 120mm m. draaibare uitloop | | | | | | | |
| Badkamermeubelen en toiletkasten | 0438857 | sprong 159mm | chrom | 33378000 | stuk | 166,00 | 210 | 1 |
| Gootstenen en wastroggen |  | | | | | | | |
| | wandkraan z. koppelingen m. hendel 170mm m. vaste uitloop | | | | | | | |
| | 0439030 | sprong 173mm | chrom | 33376000 | stuk | 200,00 | 210 | 1 |
| | 0438995 | sprong 170mm | chrom | 33371000 | stuk | 229,00 | 215 | 1 |
| Utiliteit |  | | | | | | | |
| | wandkraan z. koppelingen m. hendel 170mm m. draaibare uitloop | | | | | | | |
| | 0439029 | sprong 218mm | chrom | 33374000 | stuk | 196,00 | 215 | 1 |
| | 0431040 | sprong 219mm | chrom | 33379000 | stuk | 175,00 | 163 | 1 |
| |  | | | | | | | |
| |  | | | | | | | |
| | Grohe Europlus | | | | | | | |
| | montageset voor wastafelkraan | | | | | | | |
| | 0438717 | | chrom | 46122000 | stuk | 6,20 | 210 | 1 |

| Art.nr | Specificaties | Kleur | Lev.nr | Ehd | Prijs | Grp | CC |
|--------|---------------|-------|--------|-----|-------|-----|----|
|--------|---------------|-------|--------|-----|-------|-----|----|

Grohe Europlus2

1-gats wastafelkraan m. waste
0437143

chroom

33991001

stuk

243,00

163

0



Sanitair producten

1-gats wastafelkraan m. waste laag
0437136

chroom

33156001

stuk

234,00

163

0

Baden /
douchebakken /
stoomcabines

Kranen

1-gats wastafelkraan z. waste
0437137

chroom

33163001

stuk

234,00

163

0



Douchegarnituur

Accessoires en
spiegels

1-gats bidetkraan m. waste
0437138

chroom

33241001

stuk

254,00

163

1



Douchewanden

Toebehoren &
afvoeren

douchekraan m. koppelingen z. omstel
0437142

chroom

33577001

stuk

243,00

163

0

Spoel- &
installatiesystemen

badkraan m. koppelingen m. omstel
0437141

chroom

33553001

stuk

319,00

163

0

Badkamermeubelen
en toiletkastenGootstenen en
wastroggen

badkraan m. staande koppelingen m. omstel
0437139

chroom

33540001

stuk

376,00

163

1



Utiliteit

badkraan m. koppelingen m. douchegarnituur
0437140

chroom

33547001

stuk

356,00

163

0



opbouwdeel voor inbouwdouchekraan 33962
0437135

chroom

19537001

stuk

150,00

163

1

0439444 inbouwdeel douchekraan z. omstel 1/2"

33962000

stuk

149,00

162

0



| | Art.nr | Specificaties | Kleur | Lev.nr | Ehd | Prijs | Grp | CC |
|---|---|--|-------|----------|------|--------|-----|----|
| Sanitair producten | Grohe Europlus2 | | | | | | | |
| | opbouwdeel voor inbouwbadkraan 33961 | | | | | | | |
| Baden / douchebakken / stoomcabines | 0437134 | | chrom | 19536001 | stuk | 178,00 | 163 | 1 |
| | 0439428 | inbouwdeel bad-/douchekraan m. omstel 1/2" | | 33961000 | stuk | 220,00 | 162 | 0 |
| Kranen | Grohe Europlus E | | | | | | | |
| | infrarood elektronica voor wastafel m. menging | | | | | | | |
| Douchegarnituur | 0410025 | m. transformator 230V | chrom | 36015000 | stuk | 453,00 | 383 | 1 |
| | infrarood elektronica voor wastafel z. menging | | | | | | | |
| Accessoires en spiegels | 4333821 | batterijvoedig | chrom | 36208000 | stuk | 348,00 | 383 | 1 |
| | 0410024 | m. transformator 230V | chrom | 36016000 | stuk | 424,00 | 383 | 1 |
| Douchewanden | wastafelkraan infrarood 6V | | | | | | | |
| | 0410029 | | chrom | 36207000 | stuk | 380,00 | 383 | 1 |
| Toebehoren & afvoeren | Grohe Eurosmart2 | | | | | | | |
| | 1-gats wastafelkraan m. inzinkbare ketting | | | | | | | |
| Spoel- & installatiesystemen | 0437187 | | chrom | 33188001 | stuk | 75,00 | 163 | 0 |
| | 1-gats wastafelkraan m. waste | | | | | | | |
| Badkamermeubelen en toiletkasten | 0437185 | | chrom | 32925001 | stuk | 88,00 | 163 | 0 |
| | 1-gats bidetkraan m. waste | | | | | | | |
| Gootstenen en wastroggen | 0437186 | | chrom | 32929001 | stuk | 108,00 | 163 | 1 |
| | douchekraan z. omstel m. koppelingen | | | | | | | |
| Utiliteit | 0437191 | | chrom | 33555001 | stuk | 88,00 | 163 | 0 |
| | badkraan m. omstel m. koppelingen | | | | | | | |
| | 0437188 | | chrom | 33300001 | stuk | 113,00 | 163 | 0 |

| Art.nr | Specificaties | Kleur | Lev.nr | Ehd | Prijs | Grp | CC |
|--------|---------------|-------|--------|-----|-------|-----|----|
|--------|---------------|-------|--------|-----|-------|-----|----|

Grohe Eurosmart2

badkraan m. douchegarnituur m. koppelingen

| | | | | | | | |
|---------|--|-------|----------|------|--------|-----|---|
| 0437189 | | chrom | 33302001 | stuk | 141,00 | 163 | 0 |
|---------|--|-------|----------|------|--------|-----|---|



Sanitair producten

Baden /
douchebakken /
stoomcabines**opbouwdeel voor inbouwdouchekraan 33962**

| | | | | | | | |
|---------|--|-------|----------|------|-------|-----|---|
| 0437184 | | chrom | 19451001 | stuk | 37,50 | 163 | 1 |
|---------|--|-------|----------|------|-------|-----|---|

| | | | | | | | |
|---------|---------------------------------------|--|----------|------|--------|-----|---|
| 0439444 | inbouwdeel douchekraan z. omstel 1/2" | | 33962000 | stuk | 149,00 | 162 | 0 |
|---------|---------------------------------------|--|----------|------|--------|-----|---|



Kranen

Douchegarnituur

opbouwdeel voor inbouwbadkraan 33961

| | | | | | | | |
|---------|--|-------|----------|------|-------|-----|---|
| 0437183 | | chrom | 19450001 | stuk | 51,50 | 163 | 1 |
|---------|--|-------|----------|------|-------|-----|---|

| | | | | | | | |
|---------|--|--|----------|------|--------|-----|---|
| 0439428 | inbouwdeel bad-/douchekraan m. omstel 1/2" | | 33961000 | stuk | 220,00 | 162 | 0 |
|---------|--|--|----------|------|--------|-----|---|

Accessoires en
spiegels

Douchewanden

Grohe Eurostyle

wandkraan m. koppelingen m. onderuitloop

| | | | | | | | |
|---------|--|-------|----------|------|--------|-----|---|
| 0442828 | | chrom | 33982000 | stuk | 147,00 | 163 | 1 |
|---------|--|-------|----------|------|--------|-----|---|

Toebehoren &
afvoeren

Grohe Eurostyle2

1-gats wastafelkraan m. inzinkbare ketting

| | | | | | | | |
|---------|--|-------|----------|------|-------|-----|---|
| 0437163 | | chrom | 33557001 | stuk | 87,00 | 163 | 0 |
|---------|--|-------|----------|------|-------|-----|---|

Spoel- &
installatiesystemenBadkamermeubelen
en toiletkasten**1-gats wastafelkraan m. waste**

| | | | | | | | |
|---------|--|-------|----------|------|--------|-----|---|
| 0437162 | | chrom | 33552001 | stuk | 102,00 | 163 | 0 |
|---------|--|-------|----------|------|--------|-----|---|

Gootstenen en
wastroggen

Utiliteit

1-gats wastafelkraan m. hoge uitloop z. waste

| | | | | | | | |
|---------|--|-------|----------|------|--------|-----|---|
| 0437161 | | chrom | 32444001 | stuk | 119,00 | 163 | 1 |
|---------|--|-------|----------|------|--------|-----|---|





**1-gats bidetkraan m. waste**



| | | | | | | | |
|---------|--|-------|----------|------|--------|-----|---|
| 0437177 | | chrom | 33565001 | stuk | 117,00 | 163 | 1 |
|---------|--|-------|----------|------|--------|-----|---|

**douchekraan m. koppelingen z. omstel**











| | | | | | | | |
|---------|--|-------|----------|------|--------|-----|---|
| 0437178 | | chrom | 33590001 | stuk | 102,00 | 163 | 0 |
|---------|--|-------|----------|------|--------|-----|---|













| | Art.nr | Specificaties | Kleur | Lev.nr | Ehd | Prijs | Grp | CC |
|---|---|---|-------|----------|------|--------|-----|----|
| | Grohe Eurostyle2 | | | | | | | |
| Sanitair producten | | badkraan m. koppelingen m. omstel | | | | | | |
| | 0437179 | | chrom | 33591001 | stuk | 127,00 | 163 | 0 |
| |  | | | | | | | |
| Baden / douchebakken / stoomcabines | | badkraan m. koppelingen m. douchegarnituur | | | | | | |
| | 0437180 | | chrom | 33592001 | stuk | 155,00 | 163 | 1 |
| |  | | | | | | | |
| Kranen | | opbouwdeel voor inbouwdouchekraan 33962 | | | | | | |
| | 0437160 | | chrom | 19507001 | stuk | 46,75 | 163 | 1 |
| | 0439444 | inbouwdeel douchekraan z. omstel 1/2" | | 33962000 | stuk | 149,00 | 162 | 0 |
| |  | | | | | | | |
| Douchegarnituur | | opbouwdeel voor inbouwbadkraan 33961 | | | | | | |
| | 0437159 | | chrom | 19506001 | stuk | 65,50 | 163 | 1 |
| | 0439428 | inbouwdeel bad-/douchekraan m. omstel 1/2" | | 33961000 | stuk | 220,00 | 162 | 0 |
| |  | | | | | | | |
| Accessoires en spiegels | | | | | | | | |
| Douchewanden | | | | | | | | |
| Toebehoren & afvoeren | | | | | | | | |
| Spoel- & installatiesystemen | | Grohe Lineare | | | | | | |
| | | 1-gats wastafelkraan m. waste | | | | | | |
| | 0434026 | | chrom | 32109000 | stuk | 225,00 | 162 | 1 |
| |  | | | | | | | |
| Badkamermeubelen en toiletkasten | | 1-gats verhoogde wastafelkraan | | | | | | |
| | 0434025 | | chrom | 32250000 | stuk | 336,00 | 162 | 1 |
| |  | | | | | | | |
| Gootstenen en wastroggen | | 1-gats wastafelkraan m. waste | | | | | | |
| | 0434027 | | chrom | 32115000 | stuk | 225,00 | 162 | 1 |
| |  | | | | | | | |
| Utiliteit | | 1-gats bidetkraan | | | | | | |
| | 0434028 | | chrom | 33848000 | stuk | 225,00 | 162 | 1 |
| |  | | | | | | | |
| | badkraan m. doucheset | | | | | | | |
| | 0434029 | | chrom | 33850000 | stuk | 471,00 | 162 | 1 |
| |  | | | | | | | |

| Art.nr | Specificaties | Kleur | Lev.nr | Ehd | Prijs | Grp | CC | | |
|--|---------------|-------|----------|------|--------|-----|----|---|---|
| | | | | | | | | Grohe Lineare | |
| badkraan 0434030 | | chrom | 33849000 | stuk | 352,00 | 162 | 1 |  | Sanitair producten |
| douchekraan 0434031 | | chrom | 33865000 | stuk | 284,00 | 162 | 1 |  | Baden / douchebakken / stoomcabines |
| afbouwset voor inbouwdouchekraan 0434032 | | chrom | 19296000 | stuk | 111,00 | 162 | 1 |  | Kranen |
| afbouwset voor inbouwbadkraan 0434033 | | chrom | 19297000 | stuk | 150,00 | 162 | 1 |  | Douchegarnituur |
| | | | | | | | | Grohe Pulsomat | |
| trafo 4x12V aansluiting 0720446 | | | 36155000 | stuk | 393,00 | 210 | 1 | | Accessoires en spiegels |
| | | | | | | | | Grohe Sentosa | |
| toiletkraan m. gegoten uitloop 0438731 | | chrom | 20003000 | stuk | 78,00 | 162 | 0 |  | Douchewanden |
| 1-gats wastafelkraan m. waste m. vaste uitloop 0438758 | | chrom | 21105000 | stuk | 216,00 | 162 | 0 |  | Toebehoren & afvoeren |
| 1-gats wastafelkraan m. waste m. draaibare gegoten uitloop 0438766 | | chrom | 21106000 | stuk | 224,00 | 162 | 0 |  | Spoel- & installatiesystemen |
| 3-gats wastafelkraan m. waste m. gegoten uitloop 0430057 | | chrom | 20893000 | stuk | 371,00 | 162 | 1 |  | Badkamermeubelen en toiletkasten |
| 1-gats bidetkraan m. waste 0438774 | | chrom | 24407000 | stuk | 288,00 | 162 | 1 |  | Gootstenen en wastroggen |
| | | | | | | | | | Utiliteit |

| | Art.nr | Specificaties | Kleur | Lev.nr | Ehd | Prijs | Grp | CC |
|---|---|--|-------|----------|------|---------|-----|----|
| Sanitair producten | Grohe Sentosa | | | | | | | |
| | | douchekraan HOH=15cm m. koppelingen z. omstel | | | | | | |
| | 0438812 | | chrom | 26347000 | stuk | 126,00 | 162 | 0 |
| Baden / douchebakken / stoomcabines | badkraan m. koppelingen m. omstel z. garnituur | | | | | | | |
| | 0438782 | | chrom | 25007000 | stuk | 216,00 | 162 | 0 |
| Kranen | badkraan m. koppelingen m. omstel m. garnituur | | | | | | | |
| | 0438790 | | chrom | 25008000 | stuk | 311,00 | 162 | 0 |
| Douchegarnituur | 4-gats badrandcombinatie 3/4" m. uitloop | | | | | | | |
| Accessoires en spiegels | | | chrom | 25551000 | stuk | 1306,00 | 162 | 1 |
| Douchewanden | opbouwdeel 3-weg omstelling | | | | | | | |
| Toebehoren & afvoeren | 0434097 | | chrom | 19903000 | stuk | 90,50 | 162 | 1 |
| | 0434169 | inbouwdeel 3-weg omstelling keramisch | | 29706000 | stuk | 132,00 | 210 | 1 |
| Spoel- & installatiesystemen | opbouwdeel 5-weg omstelling | | | | | | | |
| | 0436868 | | chrom | 19905000 | stuk | 90,50 | 210 | 1 |
| Badkamermeubelen en toiletkasten | 0436869 | inbouwdeel voor 5-weg omstel keramisch | | 29708000 | stuk | 147,00 | 210 | 1 |
| | douchethermostaat keramisch z. omstel m. koppelingen | | | | | | | |
| Gootstenen en wastroggen | 0430095 | | chrom | 34686000 | stuk | 333,00 | 218 | 0 |
| Utiliteit | badthermostaat m. omstel m. koppelingen | | | | | | | |
| | 0430085 | | chrom | 34551000 | stuk | 400,00 | 218 | 0 |
| | opbouwdeel voor inbouwstopkraan | | | | | | | |
| | 0436870 | blauw | chrom | 19852000 | stuk | 27,75 | 210 | 1 |
| | 0436871 | rood | chrom | 19853000 | stuk | 27,75 | 210 | 1 |
| | opbouwdeel voor inbouwbadthermostaat 34968 | | | | | | | |
| | 0430700 | | chrom | 19666000 | stuk | 274,00 | 218 | 1 |
| | 0439472 | inbouwdeel badthermostaat 1/2" | | 34968000 | stuk | 253,00 | 218 | 0 |

| Art.nr | Specificaties | Kleur | Lev.nr | Ehd | Prijs | Grp | CC | | |
|---|-----------------------------------|-------|----------|------|---------|-----|----|---|---|
| | | | | | | | | Grohe Sentosa | |
| opbouwdeel voor inbouwdouchethermostaat | | | | | | | | | |
| 0437095 | | chrom | 19667000 | stuk | 246,00 | 210 | 1 |  | Sanitair producten |
| 0439495 | inbouwdeel douchethermostaat 1/2" | | 34966000 | stuk | 195,00 | 218 | 0 | | Baden / douchebakken / stoomcabines |
| | | | | | | | | Grohe Sinfonia | |
| toiletkraan 1/2" | | | | | | | | | |
| 0441759 | | chrom | 20013000 | stuk | 206,00 | 162 | 1 |  | Kranen |
| wastafelkraan m. waste m. vaste uitloop | | | | | | | | | |
| 0441767 | | chrom | 21012000 | stuk | 362,00 | 162 | 1 |  | Douchegarnituur |
| wastafelkraan m. waste m. draaibare uitloop | | | | | | | | | |
| 0441775 | | chrom | 21014000 | stuk | 411,00 | 162 | 1 |  | Accessoires en spiegels |
| 3-gats wastafelkraan m. waste 139mm lage uitloop | | | | | | | | | |
| 0441783 | | chrom | 20014000 | stuk | 488,00 | 162 | 1 |  | Douchewanden |
| 3-gats wastafelkraan m. waste 140mm hoge uitloop | | | | | | | | | |
| 0441791 | | chrom | 20015000 | stuk | 493,00 | 162 | 1 |  | Toebehoren & afvoeren |
| bidetkraan m. waste | | | | | | | | | |
| 0441805 | | chrom | 24003000 | stuk | 391,00 | 162 | 1 |  | Spoel- & installatiesystemen |
| badkraan m. omstel m. koppelingen | | | | | | | | | |
| 0441813 | | chrom | 25030000 | stuk | 362,00 | 162 | 1 |  | Badkamermeubelen en toiletkasten |
| 4-gats badkraan 220mm | | | | | | | | | |
| 0441821 | | chrom | 25032000 | stuk | 1295,00 | 162 | 1 |  | Gootstenen en wastroggen |
| 4-gats badkraan m. hoge uitloop | | | | | | | | | |
| 0441848 | | chrom | 25033000 | stuk | 1295,00 | 162 | 1 |  | Utiliteit |
| douchekraan z. omstel m. koppelingen | | | | | | | | | |
| 0441856 | | chrom | 26000000 | stuk | 228,00 | 162 | 1 |  | |

| | Art.nr | Specificaties | Kleur | Lev.nr | Ehd | Prijs | Grp | CC |
|---|-----------------------|--|-------|----------|------|--------|-----|----|
| | Grohe Sinfonia | | | | | | | |
| Sanitair producten | | opbouwdeel voor inbouwstopkraan | | | | | | |
|  | 0441872 | | chrom | 19031000 | stuk | 75,00 | 162 | 1 |
| Baden / douchebakken / stoomcabines | | hoekstopkraan | | | | | | |
|  | 0441880 | | chrom | 22007000 | stuk | 81,50 | 162 | 1 |
| Kranen | | 4-weg omstelling | | | | | | |
|  | 0441899 | | chrom | 29010000 | stuk | 284,00 | 162 | 1 |
| Douchegarnituur | | 5-weg omstelling | | | | | | |
|  | 0441902 | | chrom | 29011000 | stuk | 284,00 | 162 | 1 |
| Accessoires en spiegels | | baduitloop 178mm | | | | | | |
|  | 0441910 | | chrom | 13132000 | stuk | 232,00 | 162 | 1 |
| Douchewanden | | Grohe Supra | | | | | | |
| | | toiletkraan laag model waterbesparend | | | | | | |
|  | 0436461 | | chrom | 20405000 | stuk | 38,00 | 163 | 0 |
| Toebehoren & afvoeren | | toiletkraan hoog model waterbesparend | | | | | | |
|  | 0439053 | | chrom | 30985000 | stuk | 59,50 | 163 | 0 |
| Spoel- & installatiesystemen | | 1-gats wastafelkraan m. inzinkbare ketting m. draaibare uitloop | | | | | | |
|  | 0436496 | | chrom | 21338000 | stuk | 77,00 | 163 | 0 |
| Badkamermeubelen en toiletkasten | | 1-gats wastafelkraan m. waste m. draaibare uitloop | | | | | | |
|  | 0436488 | | chrom | 21257000 | stuk | 126,00 | 163 | 0 |
| Gootstenen en wastroggen | | 1-gats wastafelkraan m. waste m. lage uitloop | | | | | | |
|  | 0436518 | | chrom | 21255000 | stuk | 170,00 | 163 | 1 |
| Utiliteit | | | | | | | | |

| Art.nr | Specificaties | Kleur | Lev.nr | Ehd | Prijs | Grp | CC |
|--------|---------------|-------|--------|-----|-------|-----|----|
|--------|---------------|-------|--------|-----|-------|-----|----|

Grohe Supra

1-gats wastafelkraan m. waste m. draaibare gegoten uitloop

| | | | | | | | |
|---------|--|-------|----------|------|--------|-----|---|
| 0438278 | | chrom | 21002000 | stuk | 176,00 | 163 | 1 |
|---------|--|-------|----------|------|--------|-----|---|



Sanitair producten

Baden /
douchebakken /
stoomcabines**1-gats bidetkraan m. waste**

| | | | | | | | |
|---------|--|-------|----------|------|--------|-----|---|
| 0435432 | | chrom | 24474000 | stuk | 141,00 | 163 | 1 |
|---------|--|-------|----------|------|--------|-----|---|



Kranen

Douchegarnituur

douchekraan HOH=12cm z. koppelingen z. omstel

| | | | | | | | |
|---------|--|-------|----------|------|-------|-----|---|
| 0436550 | | chrom | 26319000 | stuk | 64,50 | 163 | 0 |
|---------|--|-------|----------|------|-------|-----|---|

Accessoires en
spiegels**douchekraan HOH=12cm z. koppelingen m. omstel m. S-uitloop**

| | | | | | | | |
|---------|--|-------|----------|------|-------|-----|---|
| 0438294 | | chrom | 26788000 | stuk | 79,50 | 163 | 0 |
|---------|--|-------|----------|------|-------|-----|---|



Douchewanden

douchekraan HOH=15cm z. koppelingen z. omstel

| | | | | | | | |
|---------|--|-------|----------|------|-------|-----|---|
| 0438286 | | chrom | 26318000 | stuk | 63,50 | 163 | 0 |
|---------|--|-------|----------|------|-------|-----|---|

Toebehoren &
afvoeren**badkraan z. koppelingen m. omstel z. garnituur**

| | | | | | | | |
|---------|--|-------|----------|------|-------|-----|---|
| 0436542 | | chrom | 25485000 | stuk | 94,50 | 163 | 0 |
|---------|--|-------|----------|------|-------|-----|---|

Spoel- &
installatiesystemenBadkamermeubelen
en toiletkasten

Grohe Taron

badkraan m. koppelingen m. omstel

| | | | | | | | |
|---------|--|--------------|----------|------|--------|-----|---|
| 0439371 | | chr./matchr. | 33524IP0 | stuk | 411,00 | 162 | 1 |
|---------|--|--------------|----------|------|--------|-----|---|

Gootstenen en
wastroggen**rozet voor badrandkraan**

| | | | | | | | |
|---------|--|--|----------|------|-------|-----|---|
| 0442472 | | | 46484000 | stuk | 42,00 | 162 | 1 |
|---------|--|--|----------|------|-------|-----|---|

Utiliteit

Grohe Tenso









wastafelkraan m. waste













| | | | | | | | |
|---------|--|-------|----------|------|--------|-----|---|
| 0442909 | | chrom | 33347000 | stuk | 408,00 | 162 | 0 |
|---------|--|-------|----------|------|--------|-----|---|

**verhoogde wastafelmengkraan**

| | | | | | | | |
|---------|--|-------|----------|------|--------|-----|---|
| 0442905 | | chrom | 32443000 | stuk | 544,00 | 162 | 1 |
|---------|--|-------|----------|------|--------|-----|---|



| | Art.nr | Specificaties | Kleur | Lev.nr | Ehd | Prijs | Grp | CC |
|---|---|--|--------|----------|------|--------|-----|----|
| Sanitair producten | Grohe Tenso | | | | | | | |
| | bidetkraan m. waste | | | | | | | |
| | 0442917 | | chroom | 33348000 | stuk | 499,00 | 162 | 1 |
| Baden / douchebakken / stoomcabines |  | | | | | | | |
| Kranen | opbouwdeel voor inbouwbadkraan | | | | | | | |
| | 0442925 | | chroom | 19050000 | stuk | 404,00 | 162 | 1 |
| | 0439428 | inbouwdeel bad-/douchekraan m. omstel 1/2" | | 33961000 | stuk | 220,00 | 162 | 0 |
| Douchegarnituur |  | | | | | | | |
| Accessoires en spiegels | opbouwdeel voor inbouwdouchekraan 33962 | | | | | | | |
| | 0442933 | | chroom | 19051000 | stuk | 318,00 | 162 | 1 |
| | 0439444 | inbouwdeel douche kraan z. omstel 1/2" | | 33962000 | stuk | 149,00 | 162 | 0 |
| Douchewanden |  | | | | | | | |
| Toebehoren & afvoeren | badkraan m. omstel m. koppelingen | | | | | | | |
| | 0442941 | | chroom | 33349000 | stuk | 516,00 | 162 | 1 |
| Toebehoren & afvoeren |  | | | | | | | |
| Spoel- & installatiesystemen | badthermostaat m. omstel m. koppelingen | | | | | | | |
| | 0442968 | | chroom | 34026000 | stuk | 571,00 | 218 | 0 |
| Badkamermeubelen en toiletkasten |  | | | | | | | |
| Badkamermeubelen en toiletkasten | douchethermostaat z. omstel m. koppelingen | | | | | | | |
| | 0442976 | | chroom | 34027000 | stuk | 519,00 | 218 | 0 |
| Badkamermeubelen en toiletkasten |  | | | | | | | |
| Gootstenen en wastroggen | opbouwdeel voor inbouw douchethermostaat | | | | | | | |
| | 0442984 | | chroom | 19066000 | stuk | 253,00 | 162 | 1 |
| | 0721387 | inbouwdeel douchethermostaat | | 34100000 | stuk | 249,00 | 218 | 0 |
| Utiliteit |  | | | | | | | |
| Utiliteit | opbouwdeel voor inbouw centraalthermostaat 34101/34102 | | | | | | | |
| | 0442992 | | chroom | 19067000 | stuk | 206,00 | 162 | 1 |
| | 0443344 | inbouwdeel centraal thermostaat 1/2" | | 34101000 | stuk | 200,00 | 218 | 1 |
| | 0443352 | inbouwdeel centraal thermostaat 3/4" | | 34102000 | stuk | 422,00 | 218 | 1 |
| Utiliteit |  | | | | | | | |
| Utiliteit | opbouwdeel voor inbouwbadthermostaat 34103 | | | | | | | |
| | 0443018 | | chroom | 19060000 | stuk | 253,00 | 162 | 1 |
| | 0443336 | inbouwdeel voor inbouwbadthermostaat 3/4" | | 34103000 | stuk | 693,00 | 218 | 0 |
| Utiliteit |  | | | | | | | |
| Utiliteit | baduitloop 17,4cm m. mousseur | | | | | | | |
| | 0443026 | | chroom | 13135000 | stuk | 121,00 | 162 | 1 |
| Utiliteit | | | | | | | | |

| Art.nr | Specificaties | Kleur | Lev.nr | Ehd | Prijs | Grp | CC | | |
|--|---|--------|----------|------|---------|-----|----|---|---|
| | | | | | | | | Grohe Tenso | |
| opbouwdeel voor 3-gats badrandcombinatie m. uitloop | | | | | | | | | |
| 0443034 | | chroom | 19153000 | stuk | 602,00 | 162 | 1 |  | Sanitair producten |
| 0442143 | inbouwdeel 3-gats badrandcombinatie voor tegelrandmontage | | 33341000 | stuk | 1062,00 | 162 | 1 |  | |
| opbouwdeel voor stopkraan | | | | | | | | | |
| 0443069 | | chroom | 19801000 | stuk | 120,00 | 162 | 1 |  | Baden / douchebakken / stoomcabines |
| | | | | | | | | Grohe Universeel | |
| inbouwdeel 3-gats badrandcombinatie voor tegelrandmontage | | | | | | | | | |
| 0442216 | | | 33339000 | stuk | 984,00 | 162 | 1 |  | Douchegarnituur |
| 0442143 | | | 33341000 | stuk | 1062,00 | 162 | 1 |  | Accessoires en spiegels |
| inbouwdeel 4-gats badrandcombinatie voor tegelrandmontage | | | | | | | | | |
| 0443395 | | | 34086000 | stuk | 1437,00 | 218 | 1 |  | Douchewanden |
| inbouwdeel douchekraan z. omstel | | | | | | | | | |
| 0439444 | 1/2" | | 33962000 | stuk | 149,00 | 162 | 0 |  | Toebehoren & afvoeren |
| inbouwdeel bad-/douchekraan m. omstel | | | | | | | | | |
| 0439428 | 1/2" | | 33961000 | stuk | 220,00 | 162 | 0 |  | Spoel- & installatiesystemen |
| inbouwdeel douchethermostaat | | | | | | | | | |
| 0721387 | | | 34100000 | stuk | 249,00 | 218 | 0 |  | Badkamermeubelen en toiletkasten |
| 0439495 | 1/2" | | 34966000 | stuk | 195,00 | 218 | 0 |  | Gootstenen en wastroggen |
| inbouwdeel 1/2" voor douchethermostaat | | | | | | | | | |
| 0438006 | | | 34954000 | stuk | 235,00 | 218 | 0 |  | Utiliteit |
| inbouwdeel 1/2" voor douchethermostaat | | | | | | | | | |
| 0438006 | | | 34954000 | stuk | 235,00 | 218 | 0 |  | |

| | Art.nr | Specificaties | Kleur | Lev.nr | Ehd | Prijs | Grp | CC |
|---|---|--|-------|----------|------|--------|-----|----|
| Sanitair producten | Grohe Universeel | | | | | | | |
| | inbouwdeel badthermostaat | | | | | | | |
| | 0439472 | 1/2" | | 34968000 | stuk | 253,00 | 218 | 0 |
| Baden / douchebakken / stoomcabines | inbouwdeel voor inbouwbadthermostaat | | | | | | | |
| | 0443336 | 3/4" | | 34103000 | stuk | 693,00 | 218 | 0 |
| Kranen | inbouwdeel centraal thermostaat | | | | | | | |
| | 0443344 | 1/2" | | 34101000 | stuk | 200,00 | 218 | 1 |
| Douchegarnituur | 0443352 | 3/4" | | 34102000 | stuk | 422,00 | 218 | 1 |
| | Accessoires en spiegels | verlengset voor 1/2" thermostaat | | | | | | |
| 0721395 | | | | 47653000 | stuk | 197,00 | 218 | 1 |
| Douchewanden | inbouwdeel Longlife inbouwstopkraan z. greep | | | | | | | |
| | 0434167 | 1/2" | | 29800000 | stuk | 15,50 | 210 | 0 |
| Toebehoren & afvoeren | 0434183 | 3/4" | | 29802000 | stuk | 26,25 | 210 | 1 |
| | 0434175 | 15mm | | 29801000 | stuk | 16,75 | 210 | 0 |
| Spoel- & installatiesystemen | 0434191 | 22mm | | 29804000 | stuk | 26,75 | 210 | 1 |
| | Badkamermeubelen en toiletkasten | inbouwdeel 3-weg omstelling keramisch | | | | | | |
| 0434169 | | | | 29706000 | stuk | 132,00 | 210 | 1 |
| Gootstenen en wastroggen | inbouwdeel voor 5-weg omstel keramisch | | | | | | | |
| | 0436869 | | | 29708000 | stuk | 147,00 | 210 | 1 |
| Utiliteit | | | | | | | | |

| Art.nr | Specificaties | Kleur | Lev.nr | Ehd | Prijs | Grp | CC |
|--------|---------------|-------|--------|-----|-------|-----|----|
|--------|---------------|-------|--------|-----|-------|-----|----|

Grohe Universeel

opbouwdeel inbouwstopkraan m. rozet

| | | | | | | | |
|---------|--|-------|----------|------|-------|-----|---|
| 0433985 | | chrom | 19820000 | stuk | 33,50 | 210 | 0 |
|---------|--|-------|----------|------|-------|-----|---|



Sanitair producten

Baden /
douchebakken /
stoomcabines**opbouwdeel inbouwstopkraan m. rozet m. steeksleutel**

| | | | | | | | |
|---------|--|-------|----------|------|-------|-----|---|
| 0434078 | | chrom | 19840000 | stuk | 24,75 | 210 | 1 |
|---------|--|-------|----------|------|-------|-----|---|



Kranen

Douchegarnituur

baduitloop m. straalbreker 3/4"x140

| | | | | | | | |
|---------|--|-------|----------|------|-------|-----|---|
| 0430501 | | chrom | 13540000 | stuk | 62,00 | 210 | 1 |
|---------|--|-------|----------|------|-------|-----|---|

Accessoires en
spiegels**inbouwdeel douchethermostaat 1/2"**

| | | | | | | | |
|---------|--|-------|----------|------|--------|-----|---|
| 0450483 | | chrom | 34211000 | stuk | 217,00 | 163 | 0 |
|---------|--|-------|----------|------|--------|-----|---|



Douchewanden

Toebehoren &
afvoeren**inbouwdeel badthermostaat**

| | | | | | | | |
|--------------|--|-------|----------|------|--------|-----|---|
| 0450484 1/2" | | chrom | 34212000 | stuk | 260,00 | 163 | 0 |
|--------------|--|-------|----------|------|--------|-----|---|

Spoel- &
installatiesystemen**inbouwdeel centraalthermostaat 1/2"**

| | | | | | | | |
|---------|--|-------|----------|------|--------|-----|---|
| 0450485 | | chrom | 34213000 | stuk | 191,00 | 163 | 1 |
|---------|--|-------|----------|------|--------|-----|---|

Badkamermeubelen
en toiletkastenGootstenen en
wastroggen**inbouwdeel centraalthermostaat 3/4"**

| | | | | | | | |
|---------|--|-------|----------|------|--------|-----|---|
| 0450486 | | chrom | 34214000 | stuk | 307,00 | 163 | 1 |
|---------|--|-------|----------|------|--------|-----|---|



Utiliteit

verlengset voor 34211 - 34213 - 34214

| | | | | | | | |
|---------|--|--|----------|------|-------|-----|---|
| 0450487 | | | 47200000 | stuk | 94,50 | 163 | 1 |
|---------|--|--|----------|------|-------|-----|---|

verlengset voor 34212

| | | | | | | | |
|---------|--|--|----------|------|--------|-----|---|
| 0450488 | | | 47201000 | stuk | 142,00 | 163 | 1 |
|---------|--|--|----------|------|--------|-----|---|

Grohe Toebehoren

| | | | | | | | |
|---------|--|-------|----------|------|-------|-----|---|
| 0430412 | S-koppeling m. rozet per paar 3/8"x1/2" | chrom | 1200000M | paar | 10,25 | 210 | 0 |
| 0433748 | S-koppeling m. rozet per paar 3/8"x3/4" | chrom | 1205000M | paar | 23,50 | 210 | 0 |
| 0430420 | S-koppeling m. rozet per paar 1/2"x3/4" | chrom | 1200100M | paar | 10,75 | 210 | 0 |
| 0433766 | S-koppeling m. rozet per stuk 1/2"x3/4" | chrom | 12005000 | stuk | 31,50 | 210 | 1 |
| 0434849 | S-koppeling geruisarm per stuk 1/2"x3/4" | chrom | 12075000 | stuk | 18,25 | 210 | 0 |
| 0432520 | S-koppeling afsluitbaar per paar 1/2"x3/4" | chrom | 1240000M | paar | 75,00 | 210 | 0 |
| 0430142 | S-koppeling compleet 1/2"x3/4" | wit | 12058L00 | stuk | 25,25 | 210 | 0 |
| 0430439 | muurplaatkoppeling per paar 1/2"x12mm | chrom | 1201700M | paar | 12,75 | 210 | 0 |
| 0430447 | muurplaatkoppeling per paar 3/4"x15mm | chrom | 1201800M | paar | 16,00 | 210 | 0 |

**THERMONOORD****PLIEGER**

Plieger groep

| | Art.nr | Specificaties | Kleur | Lev.nr | Ehd | Prijs | Grp | CC |
|---|-------------------------|--|--------|----------|------|--------|-----|----|
| | Grohe Toebehoren | | | | | | | |
| | 0430982 | staande koppeling verstellen 12,5mm per stuk 1/2"x3/4" | chroom | 12041000 | stuk | 55,00 | 210 | 1 |
| Sanitair producten | 0438709 | staande koppeling hoogte 85mm per stuk 1/2"x3/4" | chroom | 12030000 | stuk | 70,50 | 210 | 0 |
| | 0431252 | staande koppeling per stuk Chiara 1/2" | chroom | 12091000 | stuk | 181,00 | 210 | 1 |
| | 0438690 | staande koppeling Europlus/Florida per stuk 1/2" | | 12036000 | stuk | 149,00 | 210 | 0 |
| | 0432067 | aansluitpijp koper 10x300mm | | 12803000 | stuk | 6,30 | 210 | 1 |
| Baden / douchebakken / stoomcabines | 0436588 | flexibele aansluitslang | | 0633200U | stuk | 6,00 | 210 | 0 |
| | 0436589 | klem voor flexibele aansluitslang | | 01049000 | stuk | 0,82 | 210 | 0 |
| | 0436402 | draaibare S-uitloop m. straalregelaar 3/4"x200mm | chroom | 13084000 | stuk | 24,50 | 210 | 0 |
| | 0433691 | draaibare S-uitloop m. straalregelaar M22x200mm | chroom | 13051000 | stuk | 23,75 | 210 | 0 |
| | 0430455 | draaibare S-uitloop m. straalregelaar 3/4"x150mm | chroom | 13005000 | stuk | 23,00 | 210 | 0 |
| Kranen | 0430056 | draaibare S-uitloop m. straalregelaar 3/4"x300mm | chroom | 13017000 | stuk | 35,25 | 210 | 0 |
| | 0436410 | hoge draaibare uitloop m. straalregelaar 3/4"x140mm | chroom | 13071000 | stuk | 25,75 | 210 | 0 |
| | 0436445 | hoge draaibare uitloop m. straalregelaar 3/4"x140mm | chroom | 13076000 | stuk | 24,50 | 210 | 1 |
| | 0436429 | hoge draaibare uitloop m. straalregelaar 3/4"x185mm | chroom | 13070000 | stuk | 27,25 | 210 | 0 |
| | 0436437 | hoge draaibare uitloop m. straalregelaar 3/4"x235mm | chroom | 13077000 | stuk | 36,00 | 210 | 0 |
| Douchegarnituur | 0432687 | hoge draaibare uitloop m. straalregelaar M22x140mm | chroom | 13072000 | stuk | 24,75 | 210 | 0 |
| | 0432725 | hoge draaibare uitloop m. straalregelaar M22x180mm | chroom | 13073000 | stuk | 32,25 | 210 | 0 |
| | 0436399 | draaibare U-uitloop m. straalregelaar 3/4"x200mm | chroom | 13028000 | stuk | 22,75 | 210 | 0 |
| | 0430072 | draaibare U-uitloop m. straalregelaar 3/4"x300mm | chroom | 13034000 | stuk | 37,50 | 210 | 1 |
| Accessoires en spiegels | 0430919 | mousseur M22x1 binnendraad | | 13928000 | stuk | 9,80 | 210 | 0 |
| | 0434892 | mousseur M24x1 buitendraad | | 13929000 | stuk | 10,25 | 210 | 0 |
| | 0438960 | mousseur waterbesparend M22x1 binnendraad | | 13950000 | stuk | 11,50 | 210 | 0 |
| | 0438979 | mousseur waterbesparend M24x1 buitendraad | | 13951000 | stuk | 11,50 | 210 | 1 |
| Douchewanden | 0434795 | bovendeel z. greep 3/8" | | 06170000 | stuk | 8,00 | 210 | 0 |
| | 0436585 | bovendeel z. greep 1/2" | | 07146000 | stuk | 9,80 | 210 | 0 |
| | 0430846 | bovendeel m. Trecorn greep koud 3/8" | | 11003000 | stuk | 17,50 | 210 | 0 |
| | 0430862 | bovendeel m. Trecorn greep koud 1/2" | | 11101000 | stuk | 14,50 | 210 | 0 |
| | 0430854 | bovendeel m. Trecorn greep warm 3/8" | | 11006000 | stuk | 17,50 | 210 | 1 |
| Toebehoren & afvoeren | 0430870 | bovendeel m. Trecorn greep warm 1/2" | | 11102000 | stuk | 14,50 | 210 | 0 |
| | 0433683 | bovendeel keramisch rechtsdraaiend z. greep 3/8" | | 45142000 | stuk | 23,50 | 210 | 0 |
| | 0433680 | bovendeel keramisch rechtsdraaiend z. greep 1/2" | | 45346000 | stuk | 24,00 | 210 | 0 |
| | 0438385 | bovendeel keramisch linksdraaiend z. greep 1/2" | | 45342000 | stuk | 25,50 | 210 | 0 |
| Spool- & installatiesystemen | 0430366 | bovendeel m. Trecorn-luxgreep 1/2" | | 11111000 | stuk | 26,50 | 210 | 1 |
| | 0433616 | bovendeel m. Trefloggreep koud/warm 3/8" | | 11083000 | stuk | 23,25 | 210 | 1 |
| | 0433624 | bovendeel m. Trefloggreep koud/warm 1/2" | | 11086000 | stuk | 25,25 | 210 | 1 |
| | 0433365 | kraangreep 1/2" Trecorn-lux koud chroom | | 06487000 | stuk | 22,75 | 210 | 1 |
| | 0433500 | kraangreep 1/2" Trecorn-lux neutraal chroom | | 06486000 | stuk | 22,75 | 210 | 1 |
| Badkamermeubelen en toiletkasten | 0433535 | kraangreep 1/2" Brillant neutraal chroom | | 06705000 | stuk | 17,75 | 210 | 1 |
| | 0430159 | greep m. extra aanslag v. Grohtherm 1000 | chroom | 47739000 | stuk | 25,25 | 255 | 1 |
| | 0430158 | greep m. extra aanslag v. Grohtherm 2000 | chroom | 47286000 | stuk | 28,75 | 255 | 1 |
| | 0430157 | greep m. extra aanslag v. Grohtherm 3000 | chroom | 47757000 | stuk | 31,75 | 255 | 1 |
| Gootstenen en wastroggen | Grohe Onderdelen | | | | | | | |
| | 0102514 | Grohclean onverdund 250ml | | 45934000 | stuk | 10,75 | 210 | 1 |
| | 0436252 | schroevenset van 2-stuks | | 0096800M | stuk | 3,59 | 210 | 1 |
| Utiliteit | 0430106 | O-ring set van 10stuks | | 0119600M | stuk | 6,10 | 210 | 1 |
| | 0434253 | O-ring set van 10stuks | | 0122400M | zak | 3,59 | 210 | 1 |
| | 0434251 | O-ring set van 20stuks | | 0128300M | stuk | 10,25 | 210 | 1 |
| | 0430091 | O-ring set van 20stuks | | 0128500M | stuk | 17,50 | 210 | 1 |
| | 0430120 | zitting | | 01460000 | stuk | 6,20 | 210 | 1 |
| | 0434261 | verlenghuls | | 01693000 | stuk | 46,00 | 210 | 1 |
| | 0434395 | stofkap | | 01734000 | stuk | 10,25 | 210 | 1 |
| | 0436600 | rozet set van 2-stuks | | 0221000M | stuk | 13,00 | 210 | 1 |
| | 0430059 | schroef 2-stuks | | 0242600M | stuk | 12,75 | 210 | 1 |
| | 0430049 | afdekkap set van 2stuks | | 02490LOM | stuk | 11,25 | 210 | 1 |
| | 0434259 | borgschroefje set van 10stuks | | 0265300M | stuk | 1,31 | 210 | 1 |
| | 0434225 | pakkingset van 10stuks | | 0311900M | stuk | 4,59 | 210 | 1 |
| | 0434256 | kraanleertje bol per stuk 1/2" | | 0363800M | stuk | 0,64 | 210 | 0 |
| | 0434260 | aanslagring | | 03758000 | stuk | 14,50 | 210 | 1 |
| | 0433338 | stofkap | | 03827000 | stuk | 6,90 | 210 | 1 |
| | 0434252 | O-ring set van 10stuks | | 0392400M | stuk | 5,80 | 210 | 1 |
| | 0434257 | borgring set van 5stuks | | 0485300M | stuk | 7,60 | 210 | 1 |
| | 0433336 | pakkingset van 5stuks | | 0506500M | stuk | 8,40 | 210 | 1 |
| | 0432003 | douchekopring kunststof | | 05195XXO | stuk | 0,57 | 255 | 1 |
| | 0433335 | dichtset voor bovendeeel per 50 stuks 1/2" | | 0529100M | doos | 30,50 | 210 | 1 |
| | 0430069 | inzetstukje set van 10stuks | | 0538600M | stuk | 11,25 | 210 | 0 |
| | 0436254 | borgring set van 10stuks | | 0585000M | stuk | 12,25 | 210 | 1 |
| | 0434273 | trekstang chroom | | 06048000 | stuk | 11,50 | 255 | 1 |
| | 0430302 | verlengstuk | | 06427000 | stuk | 13,00 | 210 | 1 |
| | 0433362 | nippel 1/2"x3/4" | | 06619000 | stuk | 12,00 | 162 | 1 |
| | 0434810 | regelknop voor thermostaat | | 06880000 | stuk | 39,75 | 210 | 1 |

| Art.nr | Specificaties | Kleur | Lev.nr | Ehd | Prijs | Grp | CC |
|-------------------------|--|-------|----------|------|-------|-----|----|
| Grohe Onderdelen | | | | | | | |
| 0434809 | cartouche kunststof | | 07000000 | stuk | 57,50 | 210 | 0 |
| 0434104 | vuilzeef set van 2stuks | | 0700200M | stuk | 3,01 | 210 | 1 |
| 0438907 | kogelstang | | 07052000 | stuk | 11,50 | 210 | 1 |
| 0437045 | stop voor waste chroom | | 07182000 | stuk | 16,25 | 255 | 1 |
| 0434274 | terughaalveer | | 07240000 | stuk | 14,50 | 255 | 1 |
| 0434271 | afdekplaat voor Euromix | | 07244000 | stuk | 11,00 | 210 | 1 |
| 0434280 | omstelknop Costa/Eurodisc/Europlus | | 07526000 | stuk | 9,30 | 210 | 1 |
| 0436591 | terugslagklep | | 08565000 | stuk | 4,50 | 210 | 1 |
| 0436605 | snelkoppeling | | 08568000 | stuk | 9,80 | 210 | 1 |
| 0434532 | omstelling | | 08915000 | stuk | 41,50 | 210 | 1 |
| 0434817 | armhendel bovendeele sprong 160mm 1/2" | | 11046000 | stuk | 61,50 | 210 | 1 |
| 0430374 | bovendeele m. trecorn lux greep warm | | 11112000 | stuk | 26,50 | 210 | 1 |
| 0430363 | bovenstuk Trecorn | | 11501000 | stuk | 33,75 | 163 | 1 |
| 0434847 | S-koppeling m. rozet per stuk 1/2"x1/2" chroom | | 12004000 | stuk | 11,75 | 210 | 0 |
| 0430007 | S-koppeling p/stuk chroom | | 12023000 | stuk | 30,75 | 210 | 1 |
| 0438693 | nippel voor montage badmengkraan 3/4" chroom | | 12037000 | stuk | 30,25 | 210 | 0 |
| 0433749 | staande koppeling 1/2" p/stuk chroom | | 12060000 | stuk | 64,00 | 210 | 1 |
| 0432531 | afvoerbocht 3/4"x1/2" chroom | | 12407000 | stuk | 61,50 | 210 | 1 |
| 0433240 | bevestigingsset treflogreep | | 45123000 | stuk | 8,10 | 210 | 0 |
| 0432528 | stopkraan chroom | | 12409000 | stuk | 52,50 | 163 | 1 |
| 0431126 | moer set van 2stuks | | 1290100M | stuk | 4,52 | 210 | 0 |
| 0432068 | klemkoppeling 2stuks 1/2"x10mm | | 1291500M | stuk | 5,60 | 210 | 1 |
| 0430127 | draadverlengstuk M28x1.5 | | 12926000 | stuk | 36,25 | 210 | 1 |
| 0430075 | uitloop chroom | | 13049000 | stuk | 57,50 | 210 | 1 |
| 0430503 | baduitloop 1/2"x130mm chroom | | 13537000 | stuk | 51,50 | 210 | 1 |
| 0438905 | mousseur m. gewricht M24 chroom | | 13915000 | stuk | 31,25 | 210 | 1 |
| 0102473 | mousseur m. kogelgewricht chroom | | 13920000 | stuk | 53,50 | 210 | 1 |
| 0436594 | mousseur M28x1" chroom | | 13927000 | stuk | 10,50 | 210 | 0 |
| 0434891 | mousseur M24x1" goud | | 13929G00 | stuk | 82,50 | 210 | 1 |
| 0436603 | mousseur M28x1.5" chroom | | 13930000 | stuk | 10,25 | 210 | 1 |
| 0450492 | mousseur-M 28x1 chroom | | 13906000 | stuk | 11,50 | 163 | 1 |
| 0434193 | laminaar straalregelaar M22 | | 13959000 | stuk | 8,30 | 210 | 1 |
| 0434195 | laminaar straalregelaar M24 | | 13960000 | stuk | 8,40 | 210 | 1 |
| 0430093 | Relaxa douchepijp 1/2" chroom | | 27304000 | stuk | 56,50 | 255 | 1 |
| 0430050 | vaatdouchegarnituur zwart | | 27824000 | stuk | 85,00 | 210 | 1 |
| 0438910 | waste-garnituur chroom | | 28910000 | stuk | 59,00 | 210 | 1 |
| 0436258 | bekersifon 5/4" chroom | | 28920000 | stuk | 48,00 | 210 | 1 |
| 0439278 | S-sifon 5/4" chroom | | 28926000 | stuk | 77,00 | 255 | 1 |
| 0434192 | opbouw omstelling 1/2"x3/4" | | 29736000 | stuk | 76,50 | 210 | 1 |
| 0439270 | pijpbeugel voor douchepijp chroom | | 36129000 | stuk | 23,75 | 255 | 1 |
| 0438913 | druktoets voor 45187 chroom | | 45188000 | stuk | 21,25 | 210 | 0 |
| 0102465 | trekstang servoset | | 43540000 | stuk | 3,99 | 210 | 1 |
| 0102481 | tegenmoer voor toiletkraan | | 45000000 | stuk | 7,60 | 210 | 1 |
| 0438901 | set voor mousseur M24-M22 | | 45002000 | stuk | 8,40 | 210 | 1 |
| 0436256 | aansluitset M26x1.5" | | 45012000 | stuk | 8,90 | 210 | 1 |
| 0436597 | set voor mousseur 13927 M28 | | 45029000 | stuk | 12,00 | 210 | 1 |
| 0434150 | wartelmoer 3/4" chroom | | 45044000 | stuk | 11,50 | 210 | 0 |
| 0434185 | omstelling | | 45048000 | stuk | 25,25 | 163 | 1 |
| 0434187 | omstelling | | 45050000 | stuk | 10,00 | 163 | 1 |
| 0434299 | dichtingsset m. moer 1/2" | | 45053000 | stuk | 9,00 | 210 | 1 |
| 0434345 | dichtingsset m. moer 3/8" | | 45054000 | stuk | 8,10 | 210 | 1 |
| 0434346 | rozet m. huls chroom | | 45060000 | stuk | 19,75 | 210 | 1 |
| 0434339 | Trecorngreep m. stopkap blauw chroom | | 45080000 | stuk | 10,50 | 210 | 1 |
| 0434342 | Trecorngreep m. stopkap rood chroom | | 45081000 | stuk | 10,50 | 210 | 1 |
| 0433631 | bevestigingsset voor Costa | | 45121000 | stuk | 4,14 | 210 | 1 |
| 0431030 | omstelknop | | 45127000 | stuk | 10,50 | 259 | 1 |
| 0433684 | bevestigingsset M28x1.5" | | 45143000 | stuk | 5,30 | 210 | 1 |
| 0436592 | kraangreep Costa chroom | | 45144000 | stuk | 8,40 | 210 | 1 |
| 0430031 | automatische omstelling | | 45187000 | stuk | 29,25 | 210 | 1 |
| 0438915 | druktoets voor 45187 goud | | 45188G00 | stuk | 56,50 | 210 | 1 |
| 0432015 | geleidehuls | | 45202000 | stuk | 12,00 | 210 | 1 |
| 0438903 | verlengset voor inbouwstopkraan | | 45203000 | stuk | 15,75 | 210 | 1 |
| 0436249 | rozet chroom | | 45217000 | stuk | 6,50 | 210 | 1 |
| 0436250 | rozet compleet chroom | | 45219000 | stuk | 8,30 | 210 | 1 |
| 0438515 | nippel M22x3/4" | | 45247000 | stuk | 15,25 | 210 | 1 |
| 0439031 | hendel 80mm blauw/rood | | 45248000 | stuk | 35,00 | 210 | 1 |
| 0430058 | verlengset 40mm | | 45268000 | stuk | 96,50 | 210 | 1 |
| 0438512 | aansluitknie binnen- x buitendraad 1/2"x1/2" | | 45304000 | stuk | 28,25 | 255 | 1 |
| 0430081 | kraanhendel 150mm chroom | | 45314000 | stuk | 50,50 | 210 | 1 |
| 0436257 | hendel lang 100mm chroom | | 45316000 | stuk | 45,50 | 210 | 1 |

Sanitair producten

Baden /
douchebakken /
stoomcabines

Kranen

Douchegarnituur

Accessoires en
spiegels

Douchewanden

Toebehoren &
afvoerenSpoel- &
installatiesystemenBadkamermeubelen
en toiletkastenGootstenen en
wastroggen

Utiliteit

| | Art.nr | Specificaties | Kleur | Lev.nr | Ehd | Prijs | Grp | CC |
|---|---------------------------------------|--|----------|----------|--------|--------|-----|----|
| | Grohe Onderdelen | | | | | | | |
| Sanitair producten | 0438511 | Supragreep blauw p/stuk | | 45354000 | stuk | 20,50 | 210 | 1 |
| | 0438518 | Supragreep rood p/stuk | | 45355000 | stuk | 20,50 | 210 | 1 |
| | 0432001 | afdekkap voor glijstang 28666 chroom | | 45363000 | stuk | 8,70 | 255 | 0 |
| Baden / douchebakken / stoomcabines | 0436260 | bevestigingsset voor uitloop | | 45457000 | stuk | 4,08 | 210 | 1 |
| | 0436595 | Costa bovendeel | | 45534000 | stuk | 12,00 | 210 | 0 |
| | 0433292 | armaturenvet per tube 25-gram | | 45937000 | stuk | 16,00 | 384 | 0 |
| | 0437002 | afdekkapje chroom | | 45652000 | stuk | 11,00 | 210 | 1 |
| | 0432005 | afdekkap voor glijstang 28666 mat-chroom | | 45652P00 | stuk | 9,80 | 255 | 0 |
| Kranen | 0431003 | doucheplaat voor Top-4 handdouche | | 45660000 | stuk | 40,25 | 255 | 1 |
| | 0433254 | doucheplaat voor Dual hoofddouche | | 45663000 | stuk | 37,25 | 255 | 1 |
| | 0430132 | stofkap/spindel | | 45778000 | stuk | 28,50 | 210 | 1 |
| | 0430017 | bovendeel keramisch 1/2" rechtsdraaiend | | 45882000 | stuk | 22,00 | 210 | 1 |
| Douchegarnituur | 0432734 | Costa kraangreep koud/warm p/stuk | | 45970000 | stuk | 8,20 | 210 | 0 |
| | 0434533 | omstelknop Eurodisc/Euroline | | 46007000 | stuk | 17,50 | 210 | 1 |
| | 0432018 | kopstuk m. O-ring Euromix | | 46022000 | stuk | 8,90 | 210 | 1 |
| | 0434477 | bovenstuk z. hendel | | 46023000 | stuk | 30,50 | 210 | 1 |
| | 0434507 | hendel m. klemringen | | 46026000 | stuk | 29,50 | 210 | 1 |
| Accessoires en spiegels | 0438661 | handdouche voor keukenkraan chroom | | 46312IE0 | stuk | 102,00 | 210 | 1 |
| | 0434509 | hendel m. klemring 33860840/880 chroom | | 46027000 | stuk | 38,75 | 210 | 1 |
| | 0435198 | service-set voor Euromix | | 46029000 | stuk | 65,00 | 210 | 1 |
| Douchewanden | 0435228 | dichtingsset voor cartouche 6890 | | 46033000 | stuk | 13,25 | 210 | 1 |
| | 0434388 | cartouche keramisch | | 46048000 | stuk | 43,25 | 210 | 0 |
| | 0102463 | handdouche voor Ladylux wit | | 46050L00 | stuk | 46,25 | 210 | 1 |
| | 0437000 | hendel voor Eurodisc chroom | | 46053000 | stuk | 31,75 | 210 | 1 |
| | 0434520 | omstel Costa tot bouwjaar 1989 | | 46056000 | stuk | 23,00 | 210 | 1 |
| Toebehoren & afvoeren | 0436265 | rozet voor 33465 chroom | | 46057000 | stuk | 37,00 | 210 | 1 |
| | 0434523 | afdekklep voor Eurodisc | | 46063000 | stuk | 11,50 | 210 | 1 |
| | 0434442 | dichtingsset 33840 | | 46065000 | stuk | 18,75 | 210 | 1 |
| | 0434469 | dichtingsset 33860 | | 46066000 | stuk | 15,75 | 210 | 1 |
| Spoel- & installatiesystemen | 0434221 | bovenstuk m. kap z. hendel | | 46074000 | stuk | 84,50 | 210 | 1 |
| | 0438715 | dichtingsset voor Eurodisc/Europlus/Eurowing | | 46077000 | stuk | 16,75 | 210 | 0 |
| | 0438716 | bevestigingsset Europlus 33861 | | 46078000 | stuk | 18,00 | 210 | 1 |
| | 0436251 | afdekplaat voor 46093 chroom | | 46081000 | stuk | 14,00 | 210 | 1 |
| | 0436875 | dichtingsset voor 07000 | | 46090000 | stuk | 8,50 | 210 | 1 |
| Badkamermeubelen en toiletkasten | 0438669 | slang 150cm voor keukenkraan chroom | | 46092000 | stuk | 37,75 | 210 | 0 |
| | 0433454 | hendel compleet | | 46093000 | stuk | 79,50 | 210 | 1 |
| | 0438718 | drukknop | | 46106000 | stuk | 10,75 | 210 | 1 |
| | 0438469 | omstelknop Eurowing badkamer | | 46107000 | stuk | 23,75 | 210 | 1 |
| | 0436434 | uitloop voor 33480 chroom | | 46108000 | stuk | 99,00 | 210 | 1 |
| Gootstenen en wastroggen | 0438719 | hendel voor Eurowing chroom/matchr. | | 46125IP0 | stuk | 35,25 | 162 | 1 |
| | 0434534 | stofkap Eurowing matchroom | | 46126P00 | stuk | 18,00 | 210 | 1 |
| | 0434522 | afdekkap Europlus chroom | | 46130000 | stuk | 17,75 | 210 | 1 |
| | 0434524 | afdekkap Europlus chroom/goud | | 46130IG0 | stuk | 80,00 | 210 | 1 |
| | 0434525 | afdekkap Euroline chroom | | 46142000 | stuk | 4,52 | 210 | 1 |
| Utiliteit | 0438912 | veiligheidsblokkering Eurodisc | | 46153000 | stuk | 15,25 | 210 | 1 |
| | 0434530 | hendel Eurodisc/Spirit chroom | | 46183000 | stuk | 30,25 | 210 | 1 |
| | 0434527 | afdekplaat Eurodisc chroom | | 46184000 | stuk | 4,65 | 210 | 1 |
| | 0438911 | doucheaanluitnippel Eurodisc | | 46188000 | stuk | 6,60 | 210 | 1 |
| | 0438902 | trekstang Euroeco/disc | | 46213000 | stuk | 5,60 | 210 | 1 |
| | 0430084 | thermostaat-element 1/2" omgekeerd | | 47282000 | stuk | 93,50 | 210 | 0 |
| | 0438937 | stofkap chroom | | 46242000 | stuk | 5,30 | 210 | 1 |
| | 0432198 | afdekplaat voor Euroeco chroom | | 46243000 | stuk | 5,90 | 210 | 1 |
| | 0434222 | handdouche Europlus/Supra mocca | | 46252H00 | stuk | 57,50 | 210 | 1 |
| | 0434220 | handdouche Europlus/Supra chroom | | 46252IX0 | stuk | 57,50 | 210 | 0 |
| | 0434001 | handdouche Europlus/Supra wit | | 46252L00 | stuk | 57,50 | 210 | 1 |
| | 0434223 | aanslagbegrenzer voor 46048 | | 46308000 | stuk | 15,25 | 210 | 1 |
| | 0434370 | hendel Eurodisc | | 46439000 | stuk | 28,25 | 210 | 1 |
| | 0439805 | thermo-element 1/2" | | 47010000 | stuk | 169,00 | 210 | 1 |
| | 0439802 | thermo-element 1/2" | | 47012000 | stuk | 185,00 | 255 | 1 |
| 0438909 | thermo-element 3/4" tot 1981 | | 47019000 | stuk | 244,00 | 210 | 1 | |
| 0438906 | instelknop | | 47093000 | stuk | 30,50 | 210 | 1 | |
| 0434250 | moer voor bovendeel per 50 stuks 1/2" | | 0529200M | zak | 19,50 | 210 | 1 | |
| 0436602 | aanslagring m. regelmoer | | 47167000 | stuk | 8,80 | 210 | 1 | |
| 0437001 | verlengset voor 34300 | | 47172000 | stuk | 101,00 | 210 | 1 | |
| 0436244 | aan/uitknop | | 47187000 | stuk | 15,50 | 210 | 1 | |
| 0436247 | terugslagklep set 2stuks chroom | | 47189000 | stuk | 59,50 | 210 | 1 | |
| 0433252 | spaargreep Basic chroom | | 47245000 | stuk | 25,50 | 210 | 1 | |
| 0438299 | spaargreep Clova chroom/goud | | 47246IG0 | stuk | 134,00 | 210 | 1 | |
| 0436596 | thermostaatknop chroom | | 47255000 | stuk | 28,00 | 210 | 0 | |
| 0438298 | instelknop Clova chroom/goud | | 47256IG0 | stuk | 134,00 | 210 | 1 | |

| Art.nr | Specificaties | Kleur | Lev.nr | Ehd | Prijs | Grp | CC |
|-------------------------|---|--------|----------|------|--------|-----|----|
| Grohe Onderdelen | | | | | | | |
| 0430301 | verlengset voor inbouwthermostaat | | 47261000 | stuk | 135,00 | 218 | 1 |
| 0434272 | omstelinrichting compleet voor douchemengkraan 3/8" | | 06110000 | stuk | 19,00 | 210 | 1 |
| 0433250 | nippel voor douchethermostaat 3000 | | 47327000 | stuk | 30,25 | 210 | 1 |
| 0438908 | instelknop | | 47352000 | stuk | 25,25 | 210 | 0 |
| 0430128 | spaarknop voor Grohtherm 1000 | | 47353000 | stuk | 15,25 | 210 | 1 |
| 0433251 | verlengset voor inbouwkraan | | 47358000 | stuk | 83,00 | 210 | 1 |
| 0430146 | aquadimmer | | 47364000 | stuk | 58,00 | 210 | 1 |
| 0435265 | slangdoorvoer | | 47417000 | stuk | 24,50 | 162 | 1 |
| 0431033 | verlengset | | 47461000 | stuk | 210,00 | 210 | 1 |
| 0431032 | tussenring chroom | | 47464000 | stuk | 58,00 | 210 | 1 |
| 0102470 | slang 70cm voor 33065 | | 46104000 | stuk | 30,25 | 162 | 0 |
| 0432741 | doucheslang voor kappersmengkraan 3/8"x150cm | chroom | 28112000 | stuk | 38,00 | 255 | 1 |

Sanitair producten

Baden /
douchebakken /
stoomcabines

Kranen

Douchegarnituur

Accessoires en
spiegels

Douchewanden

Toebehoren &
afvoerenSpoel- &
installatiesystemenBadkamermeubelen
en toiletkastenGootstenen en
wastroggen

Utiliteit

| | Art.nr | Specificaties | Kleur | Lev.nr | Ehd | Prijs | Grp | CC |
|---|--|---|-------|----------|------|---------|-----|----|
| Sanitair producten | Hansa Canyon | | | | | | | |
| | wastafelkraan elektronisch | | | | | | | |
| | 0300666 | hoogte 256mm | chrom | 07612201 | stuk | 1471,00 | 262 | 1 |
| | 0300667 | hoogte 206mm | chrom | 07602201 | stuk | 1471,00 | 262 | 1 |
| Baden / douchebakken / stoomcabines | waste garnituur push-push bediening | | | | | | | |
| | 0300668 | | chrom | 07630100 | stuk | 56,50 | 262 | 1 |
| Kranen | afbouwdeel voor elektronisch bedieningspaneel z. uitloop | | | | | | | |
| | 0300669 | | chrom | 07650101 | stuk | 1337,00 | 262 | 1 |
| Douchegarnituur | 0300671 | inbouwdeel elektronisch bedieningspaneel z. uitloop en badkraan | | 07700100 | stuk | 107,00 | 262 | 1 |
| Accessoires en spiegels | afbouwdeel voor elektronisch badkraan m. glasuitloop m. omstel | | | | | | | |
| | 0300670 | | chrom | 07662101 | stuk | 2139,00 | 262 | 1 |
| Douchewanden | 0300671 | inbouwdeel elektronisch bedieningspaneel z. uitloop en badkraan | | 07700100 | stuk | 107,00 | 262 | 1 |
| Toebehoren & afvoeren | inbouwdeel elektronisch bedieningspaneel z. uitloop en badkraan | | | | | | | |
| | 0300671 | | | 07700100 | stuk | 107,00 | 262 | 1 |
| Spoel- & installatiesystemen | afbouwdeel voor elektronische vaste hoofddouche / baduitloop m. glasuitloop | | | | | | | |
| | 0300672 | | chrom | 07692100 | stuk | 803,00 | 262 | 1 |
| Badkamermeubelen en toiletkasten | 0300673 | inbouwdeel elektronische hoofddouche / baduitloop | | 07710100 | stuk | 83,00 | 262 | 1 |
| Gootstenen en wastroggen | inbouwdeel elektronische hoofddouche / baduitloop 07692100 | | | | | | | |
| | 0300673 | | | 07710100 | stuk | 83,00 | 262 | 1 |
| Utiliteit | wandaansluitbocht 1/2" | | | | | | | |
| | 0300674 | | chrom | 50220100 | stuk | 74,00 | 262 | 1 |
| | adapter m. 1.5 en 6meter kabel | | | | | | | |
| | 0300676 | | | 58290100 | stuk | 94,00 | 262 | 1 |
| | inbouwdeel elektronische aansluiting voor in meterkast | | | | | | | |
| | 0300677 | m. 10meter kabel | | 58300100 | stuk | 94,00 | 262 | 1 |

| Art.nr | Specificaties | Kleur | Lev.nr | Ehd | Prijs | Grp | CC |
|--------|---------------|-------|--------|-----|-------|-----|----|
|--------|---------------|-------|--------|-----|-------|-----|----|

Hansa Canyon

afdekplaat voor elektronisch deel van 0760 -0761
0300678

RVS

0762010096

stuk

37,50

262

1



Sanitair producten

Baden /
douchebakken /
stoomcabines

Hansa Designo

1-gats wastafelkraan m. hendel
0394291

chrom

51032101

stuk

379,00

262

0



Kranen

Douchegarnituur

fonteinkraan
0395234

chrom

51352102

stuk

239,00

262

1

Accessoires en
spiegels

Style 1-gats wastafelkraan m. waste
0396141

chrom

51712101

stuk

308,00

262

0



Douchewanden

Toebehoren &
afvoeren

wastafelkraan 2-greeps m. temperatuur-instelling
0395226

chrom

51072102

stuk

526,00

262

1

Spoel- &
installatiesystemenBadkamermeubelen
en toiletkasten

3-gats wastafelkraan
0395242

chrom

51052102

stuk

699,00

262

1

Gootstenen en
wastroggen

Elektronik wastafelkraan m. waste m. batterij
0396125

chrom

51792211

stuk

454,00

369

1



Utiliteit

Tiptronik wastafelkraan elektronisch m. batterij z. garnituur
0396133

chrom

51762211

stuk

311,00

369

1



Solar wastafelkraan elektronisch m. waste m. batterij
0396117

chrom

51792220

stuk

432,00

369

1



| | Art.nr | Specificaties | Kleur | Lev.nr | Ehd | Prijs | Grp | CC |
|--|---|---|-------|----------|------|---------|-----|----|
| | Hansa Designo | | | | | | | |
| Sanitair producten | afbouwset voor 3-gats wandkraan | | | | | | | |
| | 0395250 | | chrom | 51062102 | stuk | 349,00 | 262 | 1 |
| | 0395269 | inbouwset voor 3-gats wandkraan | | 51200100 | stuk | 210,00 | 262 | 1 |
| Baden / douchebakken / stoomcabines | afbouwset voor inbouwbadthermostaat m. omstel | | | | | | | |
| | 0395919 | | chrom | 51149102 | stuk | 336,00 | 262 | 1 |
| | 0395005 | inbouwset voor inbouwbad-/douchethermostaat | | 08080190 | stuk | 343,00 | 262 | 0 |
| Douchegarnituur | afbouwset voor inbouwdouchethermostaat | | | | | | | |
| | 0395927 | | chrom | 51139102 | stuk | 324,00 | 262 | 1 |
| | 0395005 | inbouwset voor inbouwbad-/douchethermostaat | | 08080190 | stuk | 343,00 | 262 | 0 |
| Douchewanden | afbouwset voor inbouwstopkraan | | | | | | | |
| | 0394153 | | chrom | 02289132 | stuk | 94,00 | 262 | 1 |
| | 0394152 | inbouwdeel voor stopkraan 1/2" | | 02250100 | stuk | 74,00 | 262 | 1 |
| Badthermostaat HOH=15cm m. omstel | badthermostaat HOH=15cm m. omstel | | | | | | | |
| | 0395277 | | chrom | 51392102 | stuk | 411,00 | 262 | 1 |
| douchethermostaat HOH=15cm | douchethermostaat HOH=15cm | | | | | | | |
| | 0395285 | | chrom | 51380102 | stuk | 369,00 | 262 | 1 |
| Gootstenen en wastroggen | afbouwset voor 4-gats badrandkraan | | | | | | | |
| | 0395978 | | chrom | 53122031 | stuk | 994,00 | 262 | 1 |
| | 0395943 | inbouwset voor 4-gats badrandkraan m. uitloop | | 53020200 | stuk | 1383,00 | 262 | 1 |
| | 0395951 | inbouwset voor 4-gats badrandkraan m. staande uitloop | | 53040200 | stuk | 629,00 | 262 | 1 |
| afbouwset voor 4-gats badrandkraan m. temperatuur instelling | afbouwset voor 4-gats badrandkraan m. temperatuur instelling | | | | | | | |
| | 0395986 | | chrom | 53162032 | stuk | 1188,00 | 262 | 1 |
| | 0395943 | inbouwset voor 4-gats badrandkraan m. uitloop | | 53020200 | stuk | 1383,00 | 262 | 1 |
| | 0395951 | inbouwset voor 4-gats badrandkraan m. staande uitloop | | 53040200 | stuk | 629,00 | 262 | 1 |
| Hansa Disc | | | | | | | | |
| 1-gats wastafelkraan m. waste | 1-gats wastafelkraan m. waste | | | | | | | |
| | 0396079 | | chrom | 01012204 | stuk | 153,00 | 262 | 1 |
| douchekraan | douchekraan | | | | | | | |
| | 0396095 | | chrom | 01680104 | stuk | 147,00 | 262 | 1 |

| Art.nr | Specificaties | Kleur | Lev.nr | Ehd | Prijs | Grp | CC |
|--------|---------------|-------|--------|-----|-------|-----|----|
|--------|---------------|-------|--------|-----|-------|-----|----|

Hansa Disc

badkraan

| | | | | | | | |
|---------|--|-------|----------|------|--------|-----|---|
| 0396109 | | chrom | 01782104 | stuk | 190,00 | 262 | 1 |
|---------|--|-------|----------|------|--------|-----|---|



Sanitair producten

afbouwset voor inbouwdouchekraan

| | | | | | | | |
|---------|--|-------|----------|------|-------|-----|---|
| 0396087 | | chrom | 01879104 | stuk | 36,00 | 262 | 1 |
|---------|--|-------|----------|------|-------|-----|---|

| | | | | | | | |
|---------|---------------------------------------|--|----------|------|--------|-----|---|
| 0394874 | inbouwset voor inbouwbad-/douchekraan | | 02000100 | stuk | 168,00 | 262 | 1 |
|---------|---------------------------------------|--|----------|------|--------|-----|---|

Baden /
douchebakken /
stoomcabines

Kranen

Hansa Hansamotion

1-gats wastafelkraan m. waste

| | | | | | | | |
|---------|--|-------|----------|------|--------|-----|---|
| 0300646 | | chrom | 53602201 | stuk | 360,00 | 262 | 1 |
|---------|--|-------|----------|------|--------|-----|---|



Douchegarnituur

Accessoires en
spiegels**badkraan m. koppelingen HOH=15cm**

| | | | | | | | |
|---------|--|-------|----------|------|--------|-----|---|
| 0300647 | | chrom | 53682101 | stuk | 448,00 | 262 | 1 |
|---------|--|-------|----------|------|--------|-----|---|



Douchewanden

Toebehoren &
afvoeren**douchekraan m. koppelingen HOH=15cm**

| | | | | | | | |
|---------|--|-------|----------|------|--------|-----|---|
| 0300648 | | chrom | 53690101 | stuk | 334,00 | 262 | 1 |
|---------|--|-------|----------|------|--------|-----|---|

Spoel- &
installatiesystemen**afbouwset voor inbouwbadkraan m. omstel**

| | | | | | | | |
|---------|--|-------|----------|------|--------|-----|---|
| 0300650 | | chrom | 53629101 | stuk | 191,00 | 262 | 1 |
|---------|--|-------|----------|------|--------|-----|---|

| | | | | | | | |
|---------|---------------------------------------|--|----------|------|--------|-----|---|
| 0394874 | inbouwset voor inbouwbad-/douchekraan | | 02000100 | stuk | 168,00 | 262 | 1 |
|---------|---------------------------------------|--|----------|------|--------|-----|---|

Badkamermeubelen
en toiletkastenGootstenen en
wastroggen**afbouwset voor inbouwdouchekraan z. omstel**

| | | | | | | | |
|---------|--|-------|----------|------|--------|-----|---|
| 0300651 | | chrom | 53619101 | stuk | 120,00 | 262 | 1 |
|---------|--|-------|----------|------|--------|-----|---|

| | | | | | | | |
|---------|---------------------------------------|--|----------|------|--------|-----|---|
| 0394874 | inbouwset voor inbouwbad-/douchekraan | | 02000100 | stuk | 168,00 | 262 | 1 |
|---------|---------------------------------------|--|----------|------|--------|-----|---|



Utiliteit

baduitloop

| | | | | | | | |
|---------|--------------|-------|----------|------|--------|-----|---|
| 0300652 | sprong 167mm | chrom | 53672100 | stuk | 253,00 | 262 | 1 |
|---------|--------------|-------|----------|------|--------|-----|---|











Hansa Hansamurano

1-gats wastafelkraan m. waste

| | | | | | | | |
|---------|--|------------|------------|------|--------|-----|---|
| 0395610 | | chrom/glas | 5609210178 | stuk | 809,00 | 262 | 1 |
|---------|--|------------|------------|------|--------|-----|---|









| | | | | | | | |
|---------|--|---------------|------------|------|--------|-----|---|
| 0395612 | | chrom/matglas | 5609210179 | stuk | 809,00 | 262 | 1 |
|---------|--|---------------|------------|------|--------|-----|---|











| | Art.nr | Specificaties | Kleur | Lev.nr | Ehd | Prijs | Grp | CC |
|---|---|---|---------------|--------------|------|--------|-----|----|
| | Hansa Hansamurano | | | | | | | |
| Sanitair producten | 1-gats wastafelkraan Piccolo m. waste | | | | | | | |
| | 0395614 | | chrom/glas | 5606320178 | stuk | 791,00 | 262 | 1 |
| | 0395616 | | chrom/matglas | 5606320179 | stuk | 791,00 | 262 | 1 |
| Baden / douchebakken / stoomcabines |  | | | | | | | |
| | hoofddouche/baduitloop | | | | | | | |
| Kranen | 0395618 | | chrom/glas | 5617010078 | stuk | 773,00 | 262 | 1 |
| | 0395620 | | chrom/matglas | 5617010079 | stuk | 773,00 | 262 | 1 |
| |  | | | | | | | |
| Douchegarnituur | afbouwset voor inbouwbadthermostaat m. omstel m. hendel | | | | | | | |
| Accessoires en spiegels | 0395622 | | chrom | 56629101 | stuk | 773,00 | 262 | 1 |
| | 0395005 | inbouwset voor inbouwbad-/douchethermostaat | | 08080190 | stuk | 343,00 | 262 | 0 |
| |  | | | | | | | |
| Douchewanden | afbouwset voor inbouwdouchethermostaat z. omstel m. hendel | | | | | | | |
| Toebehoren & afvoeren | 0395624 | | chrom | 56619101 | stuk | 681,00 | 262 | 1 |
| | 0395005 | inbouwset voor inbouwbad-/douchethermostaat | | 08080190 | stuk | 343,00 | 262 | 0 |
| |  | | | | | | | |
| Spoel- & installatiesystemen | afbouwset voor inbouwdouchethermostaat z. omstel z. hendel | | | | | | | |
| Badkamermeubelen en toiletkasten | 0395626 | | chrom | 56609101 | stuk | 555,00 | 262 | 1 |
| | 0395005 | inbouwset voor inbouwbad-/douchethermostaat | | 08080190 | stuk | 343,00 | 262 | 0 |
| |  | | | | | | | |
| Gootstenen en wastroggen | afbouwset voor inbouwstopkraan | | | | | | | |
| Utiliteit | 0395628 | | chrom | 56289131 | stuk | 210,00 | 262 | 1 |
| |  | | | | | | | |
| | wandaansluitbocht 1/2" | | | | | | | |
| | 0395630 | | chrom | 56180100 | stuk | 144,00 | 262 | 1 |
| |  | | | | | | | |
| | Hansa Hansanova | | | | | | | |
| Utiliteit | toiletkraan laag model | | | | | | | |
| | 0394521 | | chrom | 008921160050 | stuk | 47,75 | 262 | 0 |
| |  | | | | | | | |
| | toiletkraan 90mm m. vaste uitloop | | | | | | | |
| | 0394505 | | chrom | 00938101 | stuk | 91,00 | 262 | 0 |
| |  | | | | | | | |

| Art.nr | Specificaties | Kleur | Lev.nr | Ehd | Prijs | Grp | CC | | |
|--|---------------|-------|----------|------|--------|-----|----|---|---|
| Hansa Hansanova | | | | | | | | | |
| toiletkraan 127mm m. vaste uitloop 0394513 | | chrom | 00918101 | stuk | 91,00 | 262 | 0 |  | Sanitair producten |
| 1-gats wastafelkraan m. inzinkbare ketting m. draaibare uitloop 12cm 0394491 | | chrom | 00082106 | stuk | 139,00 | 262 | 1 |  | Baden / douchebakken / stoomcabines |
| 1-gats wastafelkraan m. inzinkbare ketting m. draaibare uitloop 18cm 0394475 | | chrom | 00042106 | stuk | 151,00 | 262 | 1 |  | Kranen |
| 1-gats wastafelkraan m. waste m. draaibare uitloop 12cm 0394483 | | chrom | 00072106 | stuk | 179,00 | 262 | 1 |  | Douchegarnituur |
| 1-gats wastafelkraan m. waste m. draaibare uitloop 18cm 0394467 | | chrom | 00032106 | stuk | 191,00 | 262 | 1 |  | Accessoires en spiegels |
| douchekraan HOH=15cm m. koppelingen z. omstel 0394556 | | chrom | 04730106 | stuk | 121,00 | 262 | 1 |  | Douchewanden |
| badkraan m. koppelingen m. omstel 0394548 | | chrom | 04452106 | stuk | 163,00 | 262 | 1 |  | Toebehoren & afvoeren |
| tapkraan 1/2" 106mm keramisch bovendeeel 0300594 | | chrom | 00868101 | stuk | 71,00 | 262 | 0 |  | Spoel- & installatiesystemen |
| tapkraan 1/2" 180mm keramisch bovendeeel 0300608 | | chrom | 00968101 | stuk | 82,00 | 262 | 0 |  | Badkamermeubelen en toiletkasten |
| Hansa Hansapolo | | | | | | | | | |
| 1-gats wastafelkraan m. waste 0395447 | | chrom | 51402203 | stuk | 80,00 | 262 | 0 |  | Gootstenen en wastroggen |
| | | | | | | | | | Utiliteit |

| | Art.nr | Specificaties | Kleur | Lev.nr | Ehd | Prijs | Grp | CC |
|---|---|--|-------|----------|------|--------|-----|----|
| | Hansa Hansapolo | | | | | | | |
| Sanitair producten |  | 1-gats wastafelkraan m. inzinkbare ketting 0395455 | chrom | 51412203 | stuk | 70,00 | 262 | 1 |
| Baden / douchebakken / stoomcabines |  | 1-gats wastafelkraan z. boring 0395463 | chrom | 51422203 | stuk | 68,50 | 262 | 1 |
| Kranen | | | | | | | | |
| Douchegarnituur |  | 1-gats bidetkraan 0395498 | chrom | 51433203 | stuk | 84,50 | 262 | 1 |
| Accessoires en spiegels | | | | | | | | |
| Douchewanden |  | douchekraan 0395501 | chrom | 51450103 | stuk | 75,50 | 262 | 1 |
| Toebehoren & afvoeren |  | badkraan 0395528 | chrom | 51442103 | stuk | 96,50 | 262 | 1 |
| Spoel- & installatiesystemen |  | inbouw douchekraan compleet; inbouw + afbouwset 0395544 | chrom | 50610103 | stuk | 128,00 | 262 | 1 |
| Badkamermeubelen en toiletkasten |  | inbouw badkraan m. omstel compleet; inbouw + afbouwset 0395536 | chrom | 50600103 | stuk | 151,00 | 262 | 1 |
| Gootstenen en wastroggen | | | | | | | | |
| Utiliteit | | | | | | | | |
| | Hansa Hansaprisma | | | | | | | |
| |  | douchethermostaat z. omstel z. koppelingen 0395153 HOH=15cm | chrom | 08420001 | stuk | 182,00 | 262 | 0 |
| | | 0396001 HOH=12cm | chrom | 08530001 | stuk | 182,00 | 262 | 1 |
| |  | badthermostaat m. omstel m. koppelingen 0395145 | chrom | 08472101 | stuk | 240,00 | 262 | 0 |
| | Hansa Hansaronda | | | | | | | |
| |  | kraanhendel gesloten 0394835 | | 03880002 | stuk | 49,25 | 262 | 1 |
| |  | kraanhendel open 0394837 | | 03890005 | stuk | 61,00 | 262 | 1 |

| Art.nr | Specificaties | Kleur | Lev.nr | Ehd | Prijs | Grp | CC | | |
|--|---------------|---------------|----------|------|--------|-----|----|---|---|
| Hansa Hansaronda | | | | | | | | | |
| 1-gats wastafelkraan m. waste z. hendel 0394240 | | chrom | 03092100 | stuk | 236,00 | 262 | 1 |  | Sanitair producten |
| 1-gats bidetkraan m. waste z. hendel 0394831 | | chrom | 03063200 | stuk | 278,00 | 262 | 1 |  | Baden / douchebakken / stoomcabines |
| douchekraan m. koppelingen z. omstel z. hendel 0394248 | | chrom | 03670100 | stuk | 240,00 | 262 | 1 |  | Kranen |
| badkraan m. koppelingen m. omstel z. hendel 0394256 | | chrom | 03742100 | stuk | 295,00 | 262 | 1 |  | Douchegarnituur |
| afbouwset voor inbouwdouchekraan z. hendel 0394566 | | chrom | 03869100 | stuk | 47,00 | 262 | 1 |  | Accessoires en spiegels |
| 0394874 inbouwset voor inbouwbad-/douchekraan | | | 02000100 | stuk | 168,00 | 262 | 1 | | Douchewanden |
| afbouwset voor inbouwbadthermostaat m. omstel 0394461 | | chrom | 08649195 | stuk | 208,00 | 262 | 1 |  | Toebehoren & afvoeren |
| 0395005 inbouwset voor inbouwbad-/douchethermostaat | | | 08080190 | stuk | 343,00 | 262 | 0 | | Spoel- & installatiesystemen |
| Hansa Hansaronda Style | | | | | | | | | |
| gesloten greep 0300597 | | chrom | 43880003 | stuk | 44,00 | 262 | 1 |  | Gootstenen en wastroggen |
| 0300598 | | chrom/matglas | 43900003 | stuk | 93,00 | 262 | 1 | | Utiliteit |
| open greep 0300599 | | chrom | 43890005 | stuk | 51,50 | 262 | 1 |  | |
| verlengde open greep 0300600 | | chrom | 43880006 | stuk | 89,00 | 262 | 1 |  | |

| | Art.nr | Specificaties | Kleur | Lev.nr | Ehd | Prijs | Grp | CC |
|---|---|---------------|--|----------------|-----------|--------|--------|-------|
| Hansa Hansaronda Style | | | | | | | | |
| Sanitair producten | wastafelkraan m. waste z. greep | | | | | | | |
| | | 0300601 | | chroom | 43022200 | stuk | 266,00 | 262 1 |
| |  | 0300597 | gesloten greep | chroom | 43880003 | stuk | 44,00 | 262 1 |
| | | 0300598 | gesloten greep | chroom/matglas | 43900003 | stuk | 93,00 | 262 1 |
| | | 0300599 | open greep | chroom | 43890005 | stuk | 51,50 | 262 1 |
| Baden / douchebakken / stoomcabines | | 0440175 | Comfort hoekstopkraan m. rozet m. knop 3/8"x10mm | chroom | 050980699 | stuk | 6,50 | 210 0 |
| Kranen | thermostatische wastafelkraan m. waste m. greep | | | | | | | |
| |  | 0300603 | | chroom | 43102201 | stuk | 401,00 | 262 1 |
| Douchegarnituur | wastafelkraan z. waste z. greep | | | | | | | |
| | | 0300604 | | chroom | 43082100 | stuk | 218,00 | 262 1 |
| Accessoires en spiegels |  | 0300597 | gesloten greep | chroom | 43880003 | stuk | 44,00 | 262 1 |
| | | 0300598 | gesloten greep | chroom/matglas | 43900003 | stuk | 93,00 | 262 1 |
| | | 0300599 | open greep | chroom | 43890005 | stuk | 51,50 | 262 1 |
| | | 0300600 | verlengde open greep | chroom | 43880006 | stuk | 89,00 | 262 1 |
| Douchewanden | wastafelkraan XS m. waste z. greep | | | | | | | |
| | | 0300605 | sprong 9.8cm | chroom | 43072100 | stuk | 241,00 | 262 1 |
| |  | 0300597 | gesloten greep | chroom | 43880003 | stuk | 44,00 | 262 1 |
| | | 0300598 | gesloten greep | chroom/matglas | 43900003 | stuk | 93,00 | 262 1 |
| | | 0300599 | open greep | chroom | 43890005 | stuk | 51,50 | 262 1 |
| Toebehoren & afvoeren | | 0300600 | verlengde open greep | chroom | 43880006 | stuk | 89,00 | 262 1 |
| Spoel- & installatiesystemen | wastafelkraan m. uittrekbare handdouche m. waste z. greep | | | | | | | |
| | | 0300607 | | chroom | 43012180 | stuk | 310,00 | 262 1 |
| |  | 0300597 | gesloten greep | chroom | 43880003 | stuk | 44,00 | 262 1 |
| | | 0300598 | gesloten greep | chroom/matglas | 43900003 | stuk | 93,00 | 262 1 |
| | | 0300599 | open greep | chroom | 43890005 | stuk | 51,50 | 262 1 |
| Badkamermeubelen en toiletkasten | | 0300600 | verlengde open greep | chroom | 43880006 | stuk | 89,00 | 262 1 |
| Gootstenen en wastroggen | wandkraan z. greep | | | | | | | |
| | | 0300606 | sprong 16cm | chroom | 43962100 | stuk | 228,00 | 262 1 |
| |  | 0300609 | sprong 17.1cm | chroom | 43962200 | stuk | 258,00 | 262 1 |
| | | 0300611 | sprong 23.5cm | chroom | 43942100 | stuk | 232,00 | 262 1 |
| | | 0300597 | gesloten greep | chroom | 43880003 | stuk | 44,00 | 262 1 |
| | | 0300598 | gesloten greep | chroom/matglas | 43900003 | stuk | 93,00 | 262 1 |
| Utiliteit | | 0300599 | open greep | chroom | 43890005 | stuk | 51,50 | 262 1 |
| | | 0300600 | verlengde open greep | chroom | 43880006 | stuk | 89,00 | 262 1 |
| | electronische wandkraan | | | | | | | |
|  | 0300610 | 16.5cm | chroom | 43722200 | stuk | 474,00 | 262 1 | |
| thermostatische wandkraan m. greep | thermostatische wandkraan m. greep | | | | | | | |
| |  | 0300612 | 24cm | chroom | 43732201 | stuk | 438,00 | 262 1 |

| Art.nr | Specificaties | Kleur | Lev.nr | Ehd | Prijs | Grp | CC |
|--------|---------------|-------|--------|-----|-------|-----|----|
|--------|---------------|-------|--------|-----|-------|-----|----|

Hansa Hansaronda Style

bidetkraan m. waste z. greep

| | | | | | | | |
|---------|----------------------|----------------|----------|------|--------|-----|---|
| 0300613 | | chroom | 43063200 | stuk | 241,00 | 262 | 1 |
| 0300597 | gesloten greep | chroom | 43880003 | stuk | 44,00 | 262 | 1 |
| 0300598 | gesloten greep | chroom/matglas | 43900003 | stuk | 93,00 | 262 | 1 |
| 0300599 | open greep | chroom | 43890005 | stuk | 51,50 | 262 | 1 |
| 0300600 | verlengde open greep | chroom | 43880006 | stuk | 89,00 | 262 | 1 |



Sanitair producten

Baden /
douchebakken /
stoomcabines**badkraan m. garnituur z. greep**

| | | | | | | | |
|---------|----------------------|----------------|----------|------|--------|-----|---|
| 0300615 | | chroom | 43742130 | stuk | 457,00 | 262 | 1 |
| 0300597 | gesloten greep | chroom | 43880003 | stuk | 44,00 | 262 | 1 |
| 0300598 | gesloten greep | chroom/matglas | 43900003 | stuk | 93,00 | 262 | 1 |
| 0300599 | open greep | chroom | 43890005 | stuk | 51,50 | 262 | 1 |
| 0300600 | verlengde open greep | chroom | 43880006 | stuk | 89,00 | 262 | 1 |

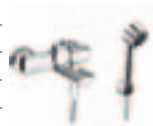

Kranen

Douchegarnituur

badkraan HOH=15cm z. greep

| | | | | | | | |
|---------|----------------------|----------------|----------|------|--------|-----|---|
| 0300614 | sprong 165mm | chroom | 43742100 | stuk | 315,00 | 262 | 1 |
| 0300597 | gesloten greep | chroom | 43880003 | stuk | 44,00 | 262 | 1 |
| 0300598 | gesloten greep | chroom/matglas | 43900003 | stuk | 93,00 | 262 | 1 |
| 0300599 | open greep | chroom | 43890005 | stuk | 51,50 | 262 | 1 |
| 0300600 | verlengde open greep | chroom | 43880006 | stuk | 89,00 | 262 | 1 |

Accessoires en
spiegels

Douchewanden

douchekraan m. koppelingen z. greep

| | | | | | | | |
|---------|----------------------|----------------|----------|------|--------|-----|---|
| 0300616 | | chroom | 43670100 | stuk | 257,00 | 262 | 1 |
| 0300597 | gesloten greep | chroom | 43880003 | stuk | 44,00 | 262 | 1 |
| 0300598 | gesloten greep | chroom/matglas | 43900003 | stuk | 93,00 | 262 | 1 |
| 0300599 | open greep | chroom | 43890005 | stuk | 51,50 | 262 | 1 |
| 0300600 | verlengde open greep | chroom | 43880006 | stuk | 89,00 | 262 | 1 |

Toebehoren &
afvoeren**douchethermostaat m. koppelingen m. greep**

| | | | | | | | |
|---------|--|--------|----------|------|--------|-----|---|
| 0300617 | | chroom | 43680100 | stuk | 417,00 | 262 | 1 |
|---------|--|--------|----------|------|--------|-----|---|

Spoel- &
installatiesystemenBadkamermeubelen
en toiletkasten**inbouwdeel voor 3-gats tegelrandcombinatie**

| | | | | | | | |
|---------|--|--|----------|------|---------|-----|---|
| 0300618 | | | 53010200 | stuk | 1290,00 | 262 | 1 |
|---------|--|--|----------|------|---------|-----|---|

Gootstenen en
wastroggen**inbouwdeel voor 3-gats badrandcombinatie**

| | | | | | | | |
|---------|--|--|----------|------|--------|-----|---|
| 0300619 | | | 53030200 | stuk | 882,00 | 262 | 1 |
|---------|--|--|----------|------|--------|-----|---|











Utiliteit









afbouwdeel voor 3-gats bad-/tegelrandkraan z. greep

| | | | | | | | |
|---------|--|----------------|----------|------|---------|-----|---|
| 0300620 | | chroom | 43259030 | stuk | 371,00 | 262 | 1 |
| 0300597 | gesloten greep | chroom | 43880003 | stuk | 44,00 | 262 | 1 |
| 0300598 | gesloten greep | chroom/matglas | 43900003 | stuk | 93,00 | 262 | 1 |
| 0300599 | open greep | chroom | 43890005 | stuk | 51,50 | 262 | 1 |
| 0300600 | verlengde open greep | chroom | 43880006 | stuk | 89,00 | 262 | 1 |
| 0300618 | inbouwdeel voor 3-gats tegelrandcombinatie | | 53010200 | stuk | 1290,00 | 262 | 1 |
| 0300619 | inbouwdeel voor 3-gats badrandcombinatie | | 53030200 | stuk | 882,00 | 262 | 1 |



| | Art.nr | Specificaties | Kleur | Lev.nr | Ehd | Prijs | Grp | CC |
|---|---|---|-------|----------|------|--------|-----|----|
| | Hansa Hansaronda Style | | | | | | | |
| | afbouwdeel voor inbouwthermostaat z. omstel | | | | | | | |
| | 0300621 | | chrom | 08639145 | stuk | 205,00 | 262 | 1 |
| Sanitair producten | 0395005 | inbouwset voor inbouwbad-/douchethermostaat | | 08080190 | stuk | 343,00 | 262 | 0 |
| | afbouwdeel voor inbouwthermostaat m. omstel | | | | | | | |
| | 0300622 | | chrom | 08649145 | stuk | 213,00 | 262 | 1 |
| Baden / douchebakken / stoomcabines | 0395005 | inbouwset voor inbouwbad-/douchethermostaat | | 08080190 | stuk | 343,00 | 262 | 0 |
| | inbouwdeel voor inbouwthermostaat z. omstel z. greep | | | | | | | |
| | 0300644 | 1/2" | | 08040290 | stuk | 317,00 | 262 | 1 |
| | 0300645 | 3/4" | | 08050290 | stuk | 656,00 | 262 | 1 |
| Accessoires en spiegels | | | | | | | | |
| | afbouwdeel voor inbouwbadkraan m. omstel z. greep | | | | | | | |
| | 0300623 | | chrom | 03849140 | stuk | 130,00 | 262 | 1 |
| Douchewanden | 0300597 | gesloten greep chrom | | 43880003 | stuk | 44,00 | 262 | 1 |
| | 0300598 | gesloten greep chrom/matglas | | 43900003 | stuk | 93,00 | 262 | 1 |
| Toebehoren & afvoeren | 0300599 | open greep chrom | | 43890005 | stuk | 51,50 | 262 | 1 |
| | 0300600 | verlengde open greep chrom | | 43880006 | stuk | 89,00 | 262 | 1 |
| | 0394874 | inbouwset voor inbouwbad-/douchekraan | | 02000100 | stuk | 168,00 | 262 | 1 |
| | afbouwdeel voor inbouwdouchekraan z. omstel z. greep | | | | | | | |
| | 0300624 | | chrom | 03869140 | stuk | 64,00 | 262 | 1 |
| Spoel- & installatiesystemen | 0300597 | gesloten greep chrom | | 43880003 | stuk | 44,00 | 262 | 1 |
| | 0300598 | gesloten greep chrom/matglas | | 43900003 | stuk | 93,00 | 262 | 1 |
| Badkamermeubelen en toiletkasten | 0300599 | open greep chrom | | 43890005 | stuk | 51,50 | 262 | 1 |
| | 0300600 | verlengde open greep chrom | | 43880006 | stuk | 89,00 | 262 | 1 |
| | 0394874 | inbouwset voor inbouwbad-/douchekraan | | 02000100 | stuk | 168,00 | 262 | 1 |
| | baduitloop | | | | | | | |
| | 0300625 | sprong 165mm | chrom | 45822102 | stuk | 166,00 | 262 | 1 |
| Gootstenen en wastroggen | | | | | | | | |
| | inbouwdeel voor omstelkraan | | | | | | | |
| | 0300626 | | | 02850100 | stuk | 156,00 | 262 | 1 |
| | afbouwdeel voor omstelkraan | | | | | | | |
| | 0300627 | | chrom | 42879135 | stuk | 177,00 | 262 | 1 |
| | 0300626 | inbouwdeel voor omstelkraan | | 02850100 | stuk | 156,00 | 262 | 1 |
| | afbouwdeel voor stopkraan | | | | | | | |
| | 0300629 | | chrom | 42289135 | stuk | 25,50 | 262 | 1 |
| | 0300628 | inbouwdeel voor stopkraan 18mm | | 02360100 | stuk | 85,00 | 262 | 1 |
| | 0394152 | inbouwdeel voor stopkraan 1/2" | | 02250100 | stuk | 74,00 | 262 | 1 |
| | 0394703 | inbouwdeel voor stopkraan 15mm | | 02350100 | stuk | 74,00 | 262 | 1 |
| | 0394731 | inbouwdeel voor stopkraan 3/4" | | 02260100 | stuk | 85,00 | 262 | 1 |
| | 0394747 | inbouwdeel voor stopkraan 22mm | | 02370100 | stuk | 85,00 | 262 | 1 |

| Art.nr | Specificaties | Kleur | Lev.nr | Ehd | Prijs | Grp | CC | | |
|---------|--|--------|----------|------|--------|-----|----|---|---|
| | | | | | | | | Hansa Hansasublime | |
| 0394175 | 1-gats wastafelkraan m. waste m. gesloten hendel | chroom | 54092203 | stuk | 138,00 | 262 | 1 |  | Sanitair producten |
| 0394176 | 1-gats wastafelkraan m. waste m. open greep | chroom | 54092205 | stuk | 144,00 | 262 | 1 |  | Baden / douchebakken / stoomcabines |
| 0394177 | 1-gats wastafelkraan m. ketting m. gesloten greep | chroom | 54042203 | stuk | 135,00 | 262 | 1 |  | Douchegarnituur |
| 0394178 | 1-gats wastafelkraan m. ketting m. open greep | chroom | 54042205 | stuk | 141,00 | 262 | 1 |  | Accessoires en spiegels |
| 0394179 | 1-gats wastafelkraan z. waste m. gesloten greep | chroom | 54082293 | stuk | 135,00 | 262 | 1 |  | Douchewanden |
| 0394180 | 1-gats wastafelkraan z. waste m. open greep | chroom | 54082295 | stuk | 141,00 | 262 | 1 |  | Toebehoren & afvoeren |
| 0394182 | 1-gats bidetkraan m. waste m. gesloten greep | chroom | 54063203 | stuk | 155,00 | 262 | 1 |  | Spoel- & installatiesystemen |
| 0394183 | 1-gats bidetkraan m. waste m. open greep | chroom | 54063205 | stuk | 161,00 | 262 | 1 |  | Badkamermeubelen en toiletkasten |
| 0394184 | badkraan m. omstel m. gesloten greep | chroom | 54742103 | stuk | 193,00 | 262 | 1 |  | Gootstenen en wastroggen |
| | | | | | | | | | Utiliteit |

| | Art.nr | Specificaties | Kleur | Lev.nr | Ehd | Prijs | Grp | CC |
|---|---|--|--------|----------|------|--------|-----|----|
| | Hansa Hansasublime | | | | | | | |
| Sanitair producten |  | badkraan m. omstel m. open greep 0394185 | chroom | 54742105 | stuk | 199,00 | 262 | 1 |
| Baden / douchebakken / stoomcabines | | | | | | | | |
| Kranen |  | badkraan m. omstel m. ProJet handdouche m. gesloten hendel 0394186 | chroom | 54742113 | stuk | 260,00 | 262 | 1 |
| Douchegarnituur | | | | | | | | |
| Accessoires en spiegels |  | douchekraan z. omstel m. gesloten hendel 0394187 | chroom | 54670103 | stuk | 166,00 | 262 | 1 |
| Douchewanden | | | | | | | | |
| Toebehoren & afvoeren |  | douchekraan z. omstel m. open greep 0394188 | chroom | 54670105 | stuk | 172,00 | 262 | 1 |
| Spoel- & installatiesystemen |  | afbouwset voor inbouwbadkraan m. omstel m. gesloten greep 0394190 | chroom | 54849103 | stuk | 113,00 | 262 | 1 |
| Badkamermeubelen en toiletkasten | | 0394874 inbouwset voor inbouwbad-/douchekraan | | 02000100 | stuk | 168,00 | 262 | 1 |
| Gootstenen en wastroggen |  | afbouwset voor inbouwbadkraan m. omstel m. open greep 0394191 | chroom | 54849105 | stuk | 119,00 | 262 | 1 |
| Utiliteit | | 0394874 inbouwset voor inbouwbad-/douchekraan | | 02000100 | stuk | 168,00 | 262 | 1 |
| |  | afbouwset voor inbouwdouchekraan z. omstel m. gesloten greep 0394192 | chroom | 54859103 | stuk | 61,50 | 262 | 1 |
| | | 0394874 inbouwset voor inbouwbad-/douchekraan | | 02000100 | stuk | 168,00 | 262 | 1 |
| |  | afbouwset voor inbouwdouchekraan z. omstel m. open greep 0394193 | chroom | 54859105 | stuk | 67,50 | 262 | 1 |
| | | 0394874 inbouwset voor inbouwbad-/douchekraan | | 02000100 | stuk | 168,00 | 262 | 1 |
| | Hansa Hansatwist | | | | | | | |
| |  | 1-gats wastafelkraan m. inzinkbare ketting 0394289 | chroom | 09042101 | stuk | 120,00 | 262 | 1 |

| Art.nr | Specificaties | Kleur | Lev.nr | Ehd | Prijs | Grp | CC |
|--------|---------------|-------|--------|-----|-------|-----|----|
|--------|---------------|-------|--------|-----|-------|-----|----|

Hansa Hansatwist

1-gats wastafelkraan m. waste
0394270

chroom 09092101 stuk 135,00 262 1



Sanitair producten

1-gats wastafelkraan m. waste m. ecotop
0394276

chroom 09092161 stuk 146,00 262 1

Baden /
douchebakken /
stoomcabines

Kranen

1-gats bidetkraan m. waste
0394319

chroom 09063201 stuk 166,00 262 1



Douchegarnituur

Accessoires en
spiegels

douchekraan HOH=15cm m. koppelingen z. omstel
0394300

chroom 09670101 stuk 129,00 262 1



Douchewanden

badkraan m. koppelingen m. omstel z. garnituur
0394297

chroom 09742101 stuk 164,00 262 1

Toebehoren &
afvoeren

badkraan m. omstel voor badrandmontage
0394327

chroom 09392102 stuk 209,00 262 1

Spoel- &
installatiesystemenBadkamermeubelen
en toiletkasten

afbouwset voor inbouwdouchekraan
0395137

chroom 09859101 stuk 35,75 262 1

0394874 inbouwset voor inbouwbad-/douchekraan

02000100 stuk 168,00 262 1

Gootstenen en
wastroggen

Utiliteit

afbouwset voor inbouwbadkraan
0395129

chroom 09849101 stuk 88,00 262 1

0394874 inbouwset voor inbouwbad-/douchekraan

02000100 stuk 168,00 262 1



Hansa Hansatwister

douchethermostaat











0395668

chroom 58110101 stuk 479,00 262 1

0395676

matchr/chr 5811010192 stuk 624,00 262 1



| | Art.nr | Specificaties | Kleur | Lev.nr | Ehd | Prijs | Grp | CC |
|---|---|---------------|---------------|------------|------|--------|-----|----|
| | Hansa Hansatwister | | | | | | | |
| | badthermostaat | | | | | | | |
| Sanitair producten |  | 0300679 | chrom | 58122101 | stuk | 539,00 | 262 | 1 |
| | | 0300680 | matchr./chrom | 5812210192 | stuk | 700,00 | 262 | 1 |
| Baden / douchebakken / stoomcabines | | | | | | | | |
| | Hansa Hansavario | | | | | | | |
| | inbouwset voor inbouwbad-/douchethermostaat | | | | | | | |
| Kranen |  | 0395005 | | 08080190 | stuk | 343,00 | 262 | 0 |
| Douchegarnituur | | | | | | | | |
| | inbouwset voor inbouwbad-/douchekraan | | | | | | | |
| |  | 0394874 | | 02000100 | stuk | 168,00 | 262 | 1 |
| Accessoires en spiegels | | | | | | | | |
| Douchewanden | | | | | | | | |
| | Hansa Prado | | | | | | | |
| | 1-gats wastafelkraan z. waste | | | | | | | |
| Toebehoren & afvoeren |  | 0394777 | chrom | 01412191 | stuk | 85,50 | 262 | 1 |
| | 1-gats wastafelkraan m. waste | | | | | | | |
| | | 0394769 | chrom | 01402101 | stuk | 89,00 | 262 | 0 |
| Spoel- & installatiesystemen | | | | | | | | |
| | 1-gats bidetkraan m. waste | | | | | | | |
| Badkamermeubelen en toiletkasten |  | 0394785 | chrom | 01433201 | stuk | 105,00 | 262 | 1 |
| Gootstenen en wastroggen | | | | | | | | |
| | douchekraan m. koppelingen z. omstel | | | | | | | |
| |  | 0394807 | chrom | 01450101 | stuk | 95,00 | 262 | 1 |
| Utiliteit | | | | | | | | |
| | badkraan m. koppelingen m. omstel | | | | | | | |
| |  | 0394793 | chrom | 01442101 | stuk | 120,00 | 262 | 1 |
| | Hansa Star | | | | | | | |
| | beugelgreep | | | | | | | |
| |  | 0394646 | chrom | 55890005 | stuk | 62,50 | 262 | 1 |
| | greep gesloten | | | | | | | |
| |  | 0394655 | chrom | 55880001 | stuk | 51,00 | 262 | 1 |
| | 1-gats wastafelkraan m. waste z. hendel | | | | | | | |
| |  | 0394648 | chrom | 55092100 | stuk | 243,00 | 262 | 1 |

| Art.nr | Specificaties | Kleur | Lev.nr | Ehd | Prijs | Grp | CC |
|--------|---------------|-------|--------|-----|-------|-----|----|
|--------|---------------|-------|--------|-----|-------|-----|----|

Hansa Star

1-gats bidetkraan z. hendel

| | | | | | | | |
|---------|--|--------|----------|------|--------|-----|---|
| 0396052 | | chroom | 55063200 | stuk | 286,00 | 262 | 1 |
|---------|--|--------|----------|------|--------|-----|---|



Sanitair producten

badkraan m. omstel z. hendel

| | | | | | | | |
|---------|--|--------|----------|------|--------|-----|---|
| 0395560 | | chroom | 55742100 | stuk | 326,00 | 262 | 1 |
|---------|--|--------|----------|------|--------|-----|---|

Baden /
douchebakken /
stoomcabines

Kranen

douchekraan z. omstel z. hendel

| | | | | | | | |
|---------|--|--------|----------|------|--------|-----|---|
| 0395579 | | chroom | 55670100 | stuk | 259,00 | 262 | 1 |
|---------|--|--------|----------|------|--------|-----|---|



Douchegarnituur

afbouwset voor inbouwbadthermostaat m. omstel m. stopkraan

| | | | | | | | |
|---------|--|--------|----------|------|--------|-----|---|
| 0395587 | | chroom | 58649105 | stuk | 225,00 | 262 | 1 |
|---------|--|--------|----------|------|--------|-----|---|

| | | | | | | | |
|---------|---|--|----------|------|--------|-----|---|
| 0395005 | inbouwset voor inbouwbad-/douchethermostaat | | 08080190 | stuk | 343,00 | 262 | 0 |
|---------|---|--|----------|------|--------|-----|---|

Accessoires en
spiegels

Douchewanden

afbouwset voor inbouwdouchethermostaat z. omstel m. stopkraan

| | | | | | | | |
|---------|--|--------|----------|------|--------|-----|---|
| 0396028 | | chroom | 58639105 | stuk | 210,00 | 262 | 1 |
|---------|--|--------|----------|------|--------|-----|---|

| | | | | | | | |
|---------|---|--|----------|------|--------|-----|---|
| 0395005 | inbouwset voor inbouwbad-/douchethermostaat | | 08080190 | stuk | 343,00 | 262 | 0 |
|---------|---|--|----------|------|--------|-----|---|

Toebehoren &
afvoerenSpoel- &
installatiesystemen**afbouwset voor inbouwbadkraan z. hendel**

| | | | | | | | |
|---------|--|--------|----------|------|--------|-----|---|
| 0396036 | | chroom | 55849100 | stuk | 130,00 | 262 | 1 |
|---------|--|--------|----------|------|--------|-----|---|

| | | | | | | | |
|---------|---------------------------------------|--|----------|------|--------|-----|---|
| 0394874 | inbouwset voor inbouwbad-/douchekraan | | 02000100 | stuk | 168,00 | 262 | 1 |
|---------|---------------------------------------|--|----------|------|--------|-----|---|

Badkamermeubelen
en toiletkastenGootstenen en
wastroggen**afbouwset voor inbouwdouchekraan z. hendel**

| | | | | | | | |
|---------|--|--------|----------|------|-------|-----|---|
| 0396044 | | chroom | 55869100 | stuk | 58,00 | 262 | 1 |
|---------|--|--------|----------|------|-------|-----|---|

| | | | | | | | |
|---------|---------------------------------------|--|----------|------|--------|-----|---|
| 0394874 | inbouwset voor inbouwbad-/douchekraan | | 02000100 | stuk | 168,00 | 262 | 1 |
|---------|---------------------------------------|--|----------|------|--------|-----|---|



Utiliteit

Hansa Temptra









douchethermostaat m. koppelingen







| | | | | | | | |
|---------|--|--------|----------|------|--------|-----|---|
| 0396060 | | chroom | 08410102 | stuk | 279,00 | 262 | 1 |
|---------|--|--------|----------|------|--------|-----|---|









**badthermostaat m. koppelingen m. omstel**

| | | | | | | | |
|---------|--|--------|----------|------|--------|-----|---|
| 0395006 | | chroom | 08362202 | stuk | 532,00 | 262 | 1 |
|---------|--|--------|----------|------|--------|-----|---|



| | Art.nr | Specificaties | Kleur | Lev.nr | Ehd | Prijs | Grp | CC |
|---|---|---|-------|----------|------|--------|-----|----|
| Sanitair producten | Hansa Tempra | | | | | | | |
| | | badthermostaat m. koppelingen | | | | | | |
| | 0395155 | | chrom | 08442104 | stuk | 321,00 | 262 | 1 |
| Baden / douchebakken / stoomcabines |  | | | | | | | |
| Kranen | Hansa Vantis | | | | | | | |
| | | 1-gats wastafelkraan m. waste | | | | | | |
| | 0395503 | | chrom | 52402203 | stuk | 97,50 | 262 | 0 |
| Douchegarnituur |  | | | | | | | |
| Accessoires en spiegels | | 1-gats wastafelkraan m. ketting | | | | | | |
| | | 0395505 | chrom | 52412203 | stuk | 92,00 | 262 | 1 |
| Douchewanden |  | | | | | | | |
| Toebehoren & afvoeren | | 1-gats bidetkraan | | | | | | |
| | | 0395507 | chrom | 52433203 | stuk | 102,00 | 262 | 1 |
| Douchewanden |  | | | | | | | |
| Spoel- & installatiesystemen | | douchekraan | | | | | | |
| | | 0395509 | chrom | 52450103 | stuk | 102,00 | 262 | 1 |
| Douchewanden |  | | | | | | | |
| Badkamermeubelen en toiletkasten | | badkraan | | | | | | |
| | | 0395511 | chrom | 52442103 | stuk | 142,00 | 262 | 0 |
| Douchewanden |  | | | | | | | |
| Gootstenen en wastroggen | | inbouwbadkraan m. omstel compleet; inbouw + afbouwset | | | | | | |
| | | 0395513 | chrom | 52600103 | stuk | 125,00 | 262 | 1 |
| Utiliteit |  | | | | | | | |
| Utiliteit | | inbouwdouchekraan z. omstel compleet; inbouw + afbouwset | | | | | | |
| | | 0395515 | chrom | 52610103 | stuk | 102,00 | 262 | 1 |
| Utiliteit |  | | | | | | | |
| Utiliteit | | baduitloop 17cm | | | | | | |
| | | 0395519 | chrom | 52502100 | stuk | 87,00 | 262 | 1 |
| Utiliteit |  | | | | | | | |

| Art.nr | Specificaties | Kleur | Lev.nr | Ehd | Prijs | Grp | CC | | |
|---|---------------|-------|----------|------|---------|-----|----|---|----------------------------------|
| | | | | | | | | Hansa Vantis | |
| wandaansluitbocht 1/2" 0395521 | | chrom | 52520100 | stuk | 24,25 | 262 | 1 |  | Sanitair producten |
| | | | | | | | | Hansa Universeel | |
| inbouwset voor 3-gats wandkraan 0395269 | | | 51200100 | stuk | 210,00 | 262 | 1 |  | Kranen |
| inbouwdeel badrand m. oprolsysteem 0395684 | | | 53060200 | stuk | 305,00 | 262 | 1 |  | Douchegarnituur |
| afbouwset badrandcombinatie 0395692 | | chrom | 53249130 | stuk | 186,00 | 262 | 1 |  | Accessoires en spiegels |
| inbouwset voor 4-gats badrandkraan m. uitloop 0395943 | | | 53020200 | stuk | 1383,00 | 262 | 1 |  | Douchewanden |
| inbouwset voor 4-gats badrandkraan m. staande uitloop 0395951 | | | 53040200 | stuk | 629,00 | 262 | 1 |  | Toebehoren & afvoeren |
| inbouwdeel voor stopkraan | | | | | | | | | |
| 0394152 1/2" | | | 02250100 | stuk | 74,00 | 262 | 1 |  | Spoel- & installatiesystemen |
| 0394731 3/4" | | | 02260100 | stuk | 85,00 | 262 | 1 | | Badkamermeubelen en toiletkasten |
| 0300628 18mm | | | 02360100 | stuk | 85,00 | 262 | 1 | | Gootstenen en wastroggen |
| 0394703 15mm | | | 02350100 | stuk | 74,00 | 262 | 1 | | Utiliteit |
| 0394747 22mm | | | 02370100 | stuk | 85,00 | 262 | 1 | | |

| | Art.nr | Specificaties | Kleur | Lev.nr | Ehd | Prijs | Grp | CC | | |
|-------------------------------------|---|---|--|----------|----------|----------|---------|--------|-----|---|
| Sanitair producten |  | Hansgrohe AXOR Allegroh toiletkraan 1-greeps staande montage | | | | | | | | |
| | | 0450952 | | chrom | 13130000 | stuk | 129,00 | 176 | 0 | |
| Baden / douchebakken / stoomcabines |  | baduitloop 3/4" 0452653 | chrom | 13410000 | stuk | 145,00 | 176 | 1 | | |
| Kranen |  | Hansgrohe AXOR Arco toiletkraan 1-greeps staande montage | | | | | | | | |
| Douchegarnituur | | 0450952 | chrom | 13130000 | stuk | 129,00 | 176 | 0 | | |
| Accessoires en spiegels |  | kleurset voor inbouwbadkraan m. beugelgreep | | | | | | | | |
| | | 0606944 | | chrom | 38415000 | stuk | 240,00 | 176 | 1 | |
| | | 0606952 | Exafill | chrom | 38417000 | stuk | 348,00 | 176 | 1 | |
| Douchewanden | | 0457051 | basisgarnituur I-box universeel | | | 01800180 | stuk | 107,00 | 176 | 0 |
| Toebehoren & afvoeren |  | baduitloop 0450163 | chrom | 38410000 | stuk | 160,00 | 176 | 1 | | |
| Spoel- & installatiesystemen | | | | | | | | | | |
| Badkamermeubelen en toiletkasten |  | kleurset voor 4-gats badrandkraan | | | | | | | | |
| | | 0457078 | | chrom | 38444000 | stuk | 840,00 | 176 | 1 | |
| | | 0451495 | basisgarnituur 4-gats badrandkraan | | | 13444180 | stuk | 614,00 | 176 | 0 |
| Gootstenen en wastroggen |  | kleurset voor 4-gats badrandthermostaat | | | | | | | | |
| | | 0457109 | | chrom | 38461000 | stuk | 1053,00 | 176 | 1 | |
| | | 0454893 | basisgarnituur 4-gats thermostaat-badrandkraan | | | 15460180 | stuk | 764,00 | 176 | 1 |
| Utiliteit |  | kleurset voor inbouwthermostaat | | | | | | | | |
| | | 0457116 | | chrom | 38375000 | stuk | 462,00 | 176 | 1 | |
| | | 0457051 | basisgarnituur I-box universeel | | | 01800180 | stuk | 107,00 | 176 | 0 |
| |  | kleurset voor inbouwthermostaat m. stopkraan | | | | | | | | |
| | | 0457124 | | chrom | 38700000 | stuk | 563,00 | 176 | 0 | |
| | | 0457051 | basisgarnituur I-box universeel | | | 01800180 | stuk | 107,00 | 176 | 0 |

| Art.nr | Specificaties | Kleur | Lev.nr | Ehd | Prijs | Grp | CC |
|--------|---------------|-------|--------|-----|-------|-----|----|
|--------|---------------|-------|--------|-----|-------|-----|----|

Hansgrohe AXOR Arco

kleurset voor inbouwthermostaat m. stopkraan m. omstelkraan

| | | | | | | | |
|---------|---------------------------------|-------|----------|------|--------|-----|---|
| 0457132 | | chrom | 38720000 | stuk | 646,00 | 176 | 0 |
| 0457051 | basiscarnituur l-box universeel | | 01800180 | stuk | 107,00 | 176 | 0 |



Sanitair producten

Baden /
douchebakken /
stoomcabines**kleurset inbouw Quattro 4weg omstelkraan / Trio stop- en omstelkraan**

| | | | | | | | |
|---------|---|-------|----------|------|--------|-----|---|
| 0457159 | | chrom | 38933000 | stuk | 112,00 | 176 | 1 |
| 0450403 | basiscarnituur Trio inbouw stop- en omstelkraan | | 15981180 | stuk | 118,00 | 176 | 0 |
| 0457698 | basiscarnituur Quatro inbouw 4wegs omstelkraan | | 15930180 | stuk | 192,00 | 176 | 1 |
| 0457701 | verlengset 25mm | | 96370000 | stuk | 38,75 | 176 | 1 |



Kranen

Douchebarnituur

kleurset stopkraan

| | | | | | | | |
|---------|---|-------|----------|------|-------|-----|---|
| 0457140 | | chrom | 38976000 | stuk | 82,00 | 176 | 0 |
| 0457701 | verlengset 25mm | | 96370000 | stuk | 38,75 | 176 | 1 |
| 0457736 | basiscarnituur stopkraan m. spindel DN15 | | 15973180 | stuk | 61,50 | 176 | 0 |
| 0457744 | basiscarnituur stopkraan m. keramische delen DN15 | | 15974180 | stuk | 64,00 | 176 | 0 |
| 0457752 | basiscarnituur stopkraan m. spindel DN20 | | 15970180 | stuk | 67,00 | 176 | 1 |

Accessoires en
spiegels

Hansgrohe AXOR Carlton

toiletkraan 1-greeps staande montage

| | | | | | | | |
|---------|--|-------|----------|------|--------|-----|---|
| 0450952 | | chrom | 13130000 | stuk | 129,00 | 176 | 0 |
|---------|--|-------|----------|------|--------|-----|---|



Douchewanden

Toebehoren &
afvoeren**1-gats fonteinkraan 1-greeps m. waste**

| | | | | | | | |
|---------|--|-------|----------|------|--------|-----|---|
| 0450238 | | chrom | 17015000 | stuk | 375,00 | 176 | 1 |
|---------|--|-------|----------|------|--------|-----|---|

Spoel- &
installatiesystemenBadkamermeubelen
en toiletkasten**1-gats toiletkraan 2-greeps 156mm**

| | | | | | | | |
|---------|--|------------|----------|------|--------|-----|---|
| 0459876 | | chrom | 17035000 | stuk | 353,00 | 176 | 1 |
| 0450122 | | chrom/goud | 17035090 | stuk | 460,00 | 176 | 1 |

Gootstenen en
wastroggen**1-gats wastafelkraan 1-greeps m. waste**

| | | | | | | | |
|---------|--|-------|----------|------|--------|-----|---|
| 0450239 | | chrom | 17010000 | stuk | 384,00 | 176 | 1 |
|---------|--|-------|----------|------|--------|-----|---|



Utiliteit



1-gats wastafelkraan 2-greeps kruis m. vaste uitloop

| | | | | | | | |
|---------|--|------------|----------|------|--------|-----|---|
| 0454699 | | chrom | 17032000 | stuk | 354,00 | 176 | 1 |
| 0450123 | | chrom/goud | 17032090 | stuk | 445,00 | 176 | 1 |

**1-gats wastafelkraan 2-greeps kruis m. draaibare uitloop**

| | | | | | | | |
|---------|--|------------|----------|------|--------|-----|---|
| 0458765 | | chrom | 17030000 | stuk | 361,00 | 176 | 1 |
| 0450001 | | chrom/goud | 17030090 | stuk | 468,00 | 176 | 1 |

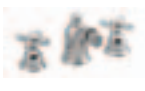

| | Art.nr | Specificaties | Kleur | Lev.nr | Ehd | Prijs | Grp | CC |
|---|--|---------------|------------|----------|------|---------|-----|----|
| | Hansgrohe AXOR Carlton | | | | | | | |
| Sanitair producten | 3-gats wastafelkraan 2-greeps recht | | | | | | | |
| | 0454700 | | chrom | 17135000 | stuk | 555,00 | 176 | 1 |
| | 0459690 | | chrom/goud | 17135090 | stuk | 648,00 | 176 | 1 |
| Baden / douchebakken / stoomcabines | 3-gats wastafelkraan 2-greeps kruis | | | | | | | |
| | 0455432 | | chrom | 17133000 | stuk | 516,00 | 176 | 1 |
| | 0459704 | | chrom/goud | 17133090 | stuk | 636,00 | 176 | 1 |
| Kranen |  | | | | | | | |
| Douchegarnituur | 1-gats bidetkraan 1-greeps m. waste | | | | | | | |
| | 0450240 | | chrom | 17210000 | stuk | 384,00 | 176 | 1 |
| Accessoires en spiegels |  | | | | | | | |
| Douchewanden | 1-gats bidetkraan 2-greeps kruis | | | | | | | |
| | 0454710 | | chrom | 17230000 | stuk | 361,00 | 176 | 1 |
| | 0459712 | | chrom/goud | 17230090 | stuk | 468,00 | 176 | 1 |
| Toebehoren & afvoeren | 3-gats bidetkraan 2-greeps kruis | | | | | | | |
| | 0454729 | | chrom | 17233000 | stuk | 516,00 | 176 | 1 |
| | 0459739 | | chrom/goud | 17233090 | stuk | 636,00 | 176 | 1 |
| Spoel- & installatiesystemen |  | | | | | | | |
| Badkamermeubelen en toiletkasten | 3-gats bidetkraan 2-greeps recht | | | | | | | |
| | 0454737 | | chrom | 17235000 | stuk | 555,00 | 176 | 1 |
| | 0459747 | | chrom/goud | 17235090 | stuk | 657,00 | 176 | 1 |
| Gootstenen en wastroggen | 1-greeps douchekraan z. omstel | | | | | | | |
| | 0450242 | | chrom | 17610000 | stuk | 415,00 | 176 | 1 |
| Utiliteit | douchekraan HOH=15cm | | | | | | | |
| | 0456543 | | chrom | 17630000 | stuk | 297,00 | 176 | 1 |
| | 0453709 | | chrom/goud | 17630090 | stuk | 406,00 | 176 | 1 |
| | badkraan m. omstel | | | | | | | |
| | 0454745 | | chrom | 17430000 | stuk | 475,00 | 176 | 1 |
| | 0450002 | | chrom/goud | 17430090 | stuk | 588,00 | 176 | 1 |
| | badkraan staand m. omstel | | | | | | | |
| | 0454753 | | chrom | 17470000 | stuk | 611,00 | 176 | 1 |
| | 0459755 | | chrom/goud | 17470090 | stuk | 726,00 | 176 | 1 |
| | showerpipe set compleet | | | | | | | |
| | 0458520 | | chrom | 17670000 | stuk | 1721,00 | 250 | 1 |
| | 0458522 | | chrom/goud | 17670090 | stuk | 2064,00 | 250 | 1 |
| | 0458524 | | satinox | 17670810 | stuk | 2236,00 | 250 | 1 |

| Art.nr | Specificaties | Kleur | Lev.nr | Ehd | Prijs | Grp | CC | | |
|---|--|-------------|----------|------|---------|-----|----|--|---|
| Hansgrohe AXOR Carlton | | | | | | | | | |
| kleurset 4-gats badrandkraan m. kruisgreep | | | | | | | | | |
| 0455695 | | chroom | 17444000 | stuk | 1003,00 | 176 | 1 | | Sanitair producten |
| 0455709 | | chroom/goud | 17444090 | stuk | 1111,00 | 176 | 1 | | |
| 0451495 | basisgarnituur 4-gats badrandkraan | | 13444180 | stuk | 614,00 | 176 | 0 | | |
| kleurset 4-gats badrandkraan m. rechte greep | | | | | | | | | |
| 0455717 | | chroom | 17445000 | stuk | 1003,00 | 176 | 1 | | Baden / douchebakken / stoomcabines |
| 0455725 | | chroom/goud | 17445090 | stuk | 1111,00 | 176 | 1 | | |
| 0451495 | basisgarnituur 4-gats badrandkraan | | 13444180 | stuk | 614,00 | 176 | 0 | | |
| kleurset 4-gats tegelrandkraan m. kruisgreep | | | | | | | | | |
| 0455733 | | chroom | 17451000 | stuk | 1207,00 | 176 | 1 | | Kranen |
| 0455741 | | chroom/goud | 17451090 | stuk | 1315,00 | 176 | 1 | | |
| 0454885 | basisgarnituur 4-gats tegelrandkraan | | 14445180 | stuk | 1055,00 | 176 | 1 | | |
| kleurset 4-gats tegelrandkraan m. rechte greep | | | | | | | | | |
| 0455768 | | chroom | 17455000 | stuk | 1207,00 | 176 | 1 | | Douchegarnituur |
| 0455776 | | chroom/goud | 17455090 | stuk | 1315,00 | 176 | 1 | | |
| 0454885 | basisgarnituur 4-gats tegelrandkraan | | 14445180 | stuk | 1055,00 | 176 | 1 | | |
| kleurset 4-gats thermostaat-badrandkraan | | | | | | | | | |
| 0455784 | | chroom | 17461000 | stuk | 1152,00 | 176 | 1 | | Accessoires en spiegels |
| 0455792 | | chroom/goud | 17461090 | stuk | 1260,00 | 176 | 1 | | |
| 0454893 | basisgarnituur 4-gats thermostaat-badrandkraan | | 15460180 | stuk | 764,00 | 176 | 1 | | |
| kleurset 4-gats thermostaat-tegelrandkraan | | | | | | | | | |
| 0455806 | | chroom | 17466000 | stuk | 1356,00 | 176 | 1 | | Toebehoren & afvoeren |
| 0455814 | | chroom/goud | 17466090 | stuk | 1464,00 | 176 | 1 | | |
| 0454907 | basisgarnituur 4-gats thermostaat tegelrandkraan | | 15465180 | stuk | 1204,00 | 176 | 1 | | |
| kleurset voor inbouw badkraan | | | | | | | | | |
| 0458031 | | chroom | 17415000 | stuk | 309,00 | 176 | 1 | | Spoel- & installatiesystemen |
| 0450124 | | chroom/goud | 17415090 | stuk | 387,00 | 176 | 1 | | |
| 0457051 | basisgarnituur l-box universeel | | 01800180 | stuk | 107,00 | 176 | 0 | | |
| afbouwset voor inbouw badkraan m. zekerheidscombinatie | | | | | | | | | |
| 0450243 | | chroom | 17417000 | stuk | 419,00 | 176 | 1 | | Badkamermeubelen en toiletkasten |
| 0457051 | basisgarnituur l-box universeel | | 01800180 | stuk | 107,00 | 176 | 0 | | |
| kleurset voor inbouw thermostaatkraan m. kruisgreep | | | | | | | | | |
| 0458058 | | chroom | 17715000 | stuk | 477,00 | 176 | 1 | | Gootstenen en wastroggen |
| 0450125 | | chroom/goud | 17715090 | stuk | 570,00 | 176 | 1 | | |
| 0457051 | basisgarnituur l-box universeel | | 01800180 | stuk | 107,00 | 176 | 0 | | |
| kleurset voor inbouw thermostaatkraan m. rechte greep | | | | | | | | | |
| 0458066 | | chroom | 17710000 | stuk | 477,00 | 176 | 1 | | Utiliteit |
| 0450126 | | chroom/goud | 17710090 | stuk | 570,00 | 176 | 1 | | |
| 0457051 | basisgarnituur l-box universeel | | 01800180 | stuk | 107,00 | 176 | 0 | | |
| afbouwset voor inbouw thermostaat m. stopkraan m. rechte greep | | | | | | | | | |
| 0450245 | | chroom | 17700000 | stuk | 582,00 | 176 | 1 | | |
| 0457051 | basisgarnituur l-box universeel | | 01800180 | stuk | 107,00 | 176 | 0 | | |

| Art.nr | Specificaties | Kleur | Lev.nr | Ehd | Prijs | Grp | CC |
|--------|---------------|-------|--------|-----|-------|-----|----|
|--------|---------------|-------|--------|-----|-------|-----|----|

Hansgrohe AXOR Carlton

afbouwset voor inbouw thermostaat m. stopkraan m. kruisgreep

| | | | | | | | |
|---------|---------------------------------|-------|----------|------|--------|-----|---|
| 0450244 | | chrom | 17705000 | stuk | 582,00 | 176 | 1 |
| 0457051 | basisgarnituur l-box universeel | | 01800180 | stuk | 107,00 | 176 | 0 |

kleurset voor inbouw thermostaatkraan m. stopkraan m. omstel m. kruisgreep

| | | | | | | | |
|---------|---------------------------------|------------|----------|------|--------|-----|---|
| 0458074 | | chrom | 17725000 | stuk | 668,00 | 176 | 1 |
| 0450127 | | chrom/goud | 17725090 | stuk | 764,00 | 176 | 1 |
| 0457051 | basisgarnituur l-box universeel | | 01800180 | stuk | 107,00 | 176 | 0 |



kleurset voor inbouw thermostaatkraan m. stopkraan m. omstel m. rechte greep

| | | | | | | | |
|---------|---------------------------------|------------|----------|------|--------|-----|---|
| 0458082 | | chrom | 17720000 | stuk | 668,00 | 176 | 1 |
| 0450128 | | chrom/goud | 17720090 | stuk | 764,00 | 176 | 1 |
| 0457051 | basisgarnituur l-box universeel | | 01800180 | stuk | 107,00 | 176 | 0 |



kleurset voor inbouwthermostaat Highflow m. kruisgreep

| | | | | | | | |
|---------|---------------------------------|------------|----------|------|--------|-----|---|
| 0450166 | voor Raindance Royal | chrom | 17716000 | stuk | 530,00 | 176 | 1 |
| 0450181 | voor Raindance Royal | chrom/goud | 17716090 | stuk | 620,00 | 176 | 1 |
| 0450167 | voor Raindance Royal | satijn | 17716810 | stuk | 653,00 | 176 | 1 |
| 0457051 | basisgarnituur l-box universeel | | 01800180 | stuk | 107,00 | 176 | 0 |

kleurset voor inbouwthermostaat Highflow m. rechte greep

| | | | | | | | |
|---------|---------------------------------|------------|----------|------|--------|-----|---|
| 0450183 | voor Raindance Royal | chrom | 17712000 | stuk | 530,00 | 176 | 1 |
| 0450182 | voor Raindance Royal | chrom/goud | 17712090 | stuk | 620,00 | 176 | 1 |
| 0450184 | voor Raindance Royal | satijn | 17712810 | stuk | 653,00 | 176 | 1 |
| 0457051 | basisgarnituur l-box universeel | | 01800180 | stuk | 107,00 | 176 | 0 |

kleurset inbouw 4weg omstelkraan / Trio stop- en omstelkraan m. kruisgreep

| | | | | | | | |
|---------|---|------------|----------|------|--------|-----|---|
| 0458090 | | chrom | 17925000 | stuk | 165,00 | 176 | 1 |
| 0450129 | | chrom/goud | 17925090 | stuk | 200,00 | 176 | 1 |
| 0450403 | basisgarnituur Trio inbouw stop- en omstelkraan | | 15981180 | stuk | 118,00 | 176 | 0 |
| 0457698 | basisgarnituur Quatro inbouw 4wegs omstelkraan | | 15930180 | stuk | 192,00 | 176 | 1 |



kleurset inbouw 4weg omstelkraan / Trio stop- en omstelkraan m. rechte greep

| | | | | | | | |
|---------|---|------------|----------|------|--------|-----|---|
| 0458101 | | chrom | 17920000 | stuk | 165,00 | 176 | 1 |
| 0450130 | | chrom/goud | 17920090 | stuk | 200,00 | 176 | 1 |
| 0450403 | basisgarnituur Trio inbouw stop- en omstelkraan | | 15981180 | stuk | 118,00 | 176 | 0 |
| 0457698 | basisgarnituur Quatro inbouw 4wegs omstelkraan | | 15930180 | stuk | 192,00 | 176 | 1 |



kleurset voor stopkraan m. kruisgreep

| | | | | | | | |
|---------|---|------------|----------|------|--------|-----|---|
| 0458112 | | chrom | 17965000 | stuk | 82,50 | 176 | 1 |
| 0450131 | | chrom/goud | 17965090 | stuk | 117,00 | 176 | 1 |
| 0457736 | basisgarnituur stopkraan m. spindel DN15 | | 15973180 | stuk | 61,50 | 176 | 0 |
| 0457744 | basisgarnituur stopkraan m. keramische delen DN15 | | 15974180 | stuk | 64,00 | 176 | 0 |
| 0457752 | basisgarnituur stopkraan m. spindel DN20 | | 15970180 | stuk | 67,00 | 176 | 1 |



kleurset voor stopkraan m. rechte greep

| | | | | | | | |
|---------|---|------------|----------|------|--------|-----|---|
| 0458120 | | chrom | 17960000 | stuk | 82,50 | 176 | 1 |
| 0450132 | | chrom/goud | 17960090 | stuk | 117,00 | 176 | 1 |
| 0457736 | basisgarnituur stopkraan m. spindel DN15 | | 15973180 | stuk | 61,50 | 176 | 0 |
| 0457744 | basisgarnituur stopkraan m. keramische delen DN15 | | 15974180 | stuk | 64,00 | 176 | 0 |
| 0457752 | basisgarnituur stopkraan m. spindel DN20 | | 15970180 | stuk | 67,00 | 176 | 1 |



















Hansgrohe AXOR Citterio

1-gats fonteinkraan

| | | | | | | | |
|---------|--|-------|----------|------|--------|-----|---|
| 0467290 | | chrom | 39015000 | stuk | 389,00 | 176 | 1 |
|---------|--|-------|----------|------|--------|-----|---|

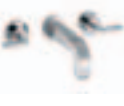

| Art.nr | Specificaties | Kleur | Lev.nr | Ehd | Prijs | Grp | CC | | |
|--|---|-------|----------|------|--------|-----|----|---|---|
| | | | | | | | | Hansgrohe AXOR Citterio | |
| 1-gats wastafelkraan m. waste 0467288 | | chrom | 39010000 | stuk | 469,00 | 176 | 0 |  | Sanitair producten |
| highriser wastafelkraan 0450364 27.3cm | z. waste | chrom | 39018000 | stuk | 469,00 | 176 | 1 |  | Baden / douchebakken / stoomcabines |
| 0450366 27.3cm | m. waste | chrom | 39020000 | stuk | 663,00 | 176 | 1 | | Kranen |
| 3-gats wastafelkraan m. kruisgreep z. plaat 0467292 | | chrom | 39133000 | stuk | 537,00 | 176 | 1 |  | Douchegarnituur |
| 3-gats wastafelkraan m. kruisgreep m. plaat 0467291 | | chrom | 39134000 | stuk | 661,00 | 176 | 1 |  | Accessoires en spiegels |
| 3-gats wastafelkraan m. rechte greep z. plaat 0467294 | | chrom | 39135000 | stuk | 537,00 | 176 | 1 |  | Douchewanden |
| 3-gats wastafelkraan m. rechte greep m. plaat 0467293 | | chrom | 39136000 | stuk | 661,00 | 176 | 1 |  | Toebehoren & afvoeren |
| kleurset voor 2-gats wandkraan m. plaat 0450257 16.5cm | | chrom | 39112000 | stuk | 554,00 | 176 | 1 |  | Spoel- & installatiesystemen |
| 0450034 | basisgarnituur voor inbouwwastafelkraan | | 38111180 | stuk | 206,00 | 176 | 0 | | Badkamermeubelen en toiletkasten |
| kleurset voor 2-gats wandkraan z. plaat 0450308 16.5cm | | chrom | 39113000 | stuk | 446,00 | 176 | 1 |  | Gootstenen en wastroggen |
| 0450034 | basisgarnituur voor inbouwwastafelkraan | | 38111180 | stuk | 206,00 | 176 | 0 | | Utiliteit |
| kleurset voor 2-gats wandkraan m. plaat 0450319 22.5cm | | chrom | 39115000 | stuk | 572,00 | 176 | 1 |  | |
| 0450034 | basisgarnituur voor inbouwwastafelkraan | | 38111180 | stuk | 206,00 | 176 | 0 | | |

| | Art.nr | Specificaties | Kleur | Lev.nr | Ehd | Prijs | Grp | CC |
|---|---|---|--------|----------|------|--------|-----|----|
| | Hansgrohe AXOR Citterio | | | | | | | |
| Sanitair producten | kleurset voor 2-gats wandkraan z. plaat | | | | | | | |
| | 0450263 | 22.5cm | chroom | 39116000 | stuk | 476,00 | 176 | 1 |
| | 0450034 | basisgarnituur voor inbouwwastafelkraan | | 38111180 | stuk | 206,00 | 176 | 0 |
| Baden / douchebakken / stoomcabines |  | | | | | | | |
| Kranen | kleurset voor 3-gats wandkraan m. kruisgreep z. plaat | | | | | | | |
| | 0467296 | 16cm | chroom | 39313000 | stuk | 432,00 | 176 | 1 |
| | 0467298 | 22cm | chroom | 39143000 | stuk | 469,00 | 176 | 1 |
| | 0453450 | basisgarnituur voor 3-gats wandkraan | | 10303180 | stuk | 174,00 | 176 | 0 |
| Douchegarnituur |  | | | | | | | |
| Accessoires en spiegels | kleurset voor 3-gats wandkraan m. kruisgreep m. plaat | | | | | | | |
| | 0467295 | 16cm | chroom | 39314000 | stuk | 556,00 | 176 | 1 |
| | 0467297 | 22cm | chroom | 39144000 | stuk | 593,00 | 176 | 1 |
| | 0453450 | basisgarnituur voor 3-gats wandkraan | | 10303180 | stuk | 174,00 | 176 | 0 |
| Douchewanden |  | | | | | | | |
| Toebehoren & afvoeren | kleurset voor 3-gats wandkraan m. rechte greep z. plaat | | | | | | | |
| | 0467300 | 16cm | chroom | 39315000 | stuk | 432,00 | 176 | 1 |
| | 0467302 | 22cm | chroom | 39147000 | stuk | 469,00 | 176 | 1 |
| | 0453450 | basisgarnituur voor 3-gats wandkraan | | 10303180 | stuk | 174,00 | 176 | 0 |
| Toebehoren & afvoeren |  | | | | | | | |
| Spoel- & installatiesystemen | kleurset voor 3-gats wandkraan m. rechte greep m. plaat | | | | | | | |
| | 0467299 | 16cm | chroom | 39316000 | stuk | 556,00 | 176 | 1 |
| | 0467301 | 22cm | chroom | 39148000 | stuk | 593,00 | 176 | 1 |
| | 0453450 | basisgarnituur voor 3-gats wandkraan | | 10303180 | stuk | 174,00 | 176 | 0 |
| Badkamermeubelen en toiletkasten |  | | | | | | | |
| Gootstenen en wastroggen | 1-greeps bidetkraan m. waste | | | | | | | |
| | 0467303 | | chroom | 39200000 | stuk | 469,00 | 176 | 1 |
| Utiliteit |  | | | | | | | |
| | 1-greeps badkraan m. omstel | | | | | | | |
| | 0467304 | | chroom | 39400000 | stuk | 803,00 | 176 | 1 |
| |  | | | | | | | |
| | kleurset voor badkraan m. kruisgrepen m. plaat | | | | | | | |
| | 0450267 | | chroom | 39423000 | stuk | 566,00 | 176 | 1 |
| | 0454265 | basisgarnituur 3-gats badkraan | | 10422180 | stuk | 171,00 | 176 | 1 |
| | kleurset voor badkraan m. rechte grepen m. plaat | | | | | | | |
| | 0450269 | | chroom | 39424000 | stuk | 566,00 | 176 | 1 |
| | 0454265 | basisgarnituur 3-gats badkraan | | 10422180 | stuk | 171,00 | 176 | 1 |
| | kleurset voor badkraan m. kruisgrepen z. plaat | | | | | | | |
| | 0450271 | | chroom | 39425000 | stuk | 446,00 | 176 | 1 |
| | 0454265 | basisgarnituur 3-gats badkraan | | 10422180 | stuk | 171,00 | 176 | 1 |
| | kleurset voor badkraan m. rechte grepen z. plaat | | | | | | | |
| | 0450273 | | chroom | 39428000 | stuk | 446,00 | 176 | 1 |
| | 0454265 | basisgarnituur 3-gats badkraan | | 10422180 | stuk | 171,00 | 176 | 1 |
| | kleurset voor badkraan m. kruisgrepen m. plaat m. handdouche | | | | | | | |
| | 0450265 | | chroom | 39441000 | stuk | 843,00 | 176 | 1 |
| | 0453450 | basisgarnituur voor 3-gats wandkraan | | 10303180 | stuk | 174,00 | 176 | 0 |

| Art.nr | Specificaties | Kleur | Lev.nr | Ehd | Prijs | Grp | CC |
|--------|---------------|-------|--------|-----|-------|-----|----|
|--------|---------------|-------|--------|-----|-------|-----|----|

Hansgrohe AXOR Citterio

kleurset voor badkraan m. rechte grepen m. plaat m. handdouche

| | | | | | | | |
|---------|-------------------------------------|--------|----------|------|--------|-----|---|
| 0450275 | | chroom | 39442000 | stuk | 843,00 | 176 | 1 |
| 0453450 | basismunituur voor 3-gats wandkraan | | 10303180 | stuk | 174,00 | 176 | 0 |



Sanitair producten

Baden /
douchebakken /
stoomcabines**kleurset voor 2-gats badrandthermostaat m. kruisgrepen**

| | | | | | | | |
|---------|--|--------|----------|------|--------|-----|---|
| 0450277 | | chroom | 39480000 | stuk | 265,00 | 176 | 1 |
| 0458716 | basismunituur voor 2-gats badrandthermostaat | | 13550180 | stuk | 585,00 | 176 | 0 |

kleurset voor 2-gats badrandthermostaat m. rechte grepen

| | | | | | | | |
|---------|--|--------|----------|------|--------|-----|---|
| 0450279 | | chroom | 39482000 | stuk | 265,00 | 176 | 1 |
| 0458716 | basismunituur voor 2-gats badrandthermostaat | | 13550180 | stuk | 585,00 | 176 | 0 |

baduitloop

| | | | | | | | |
|---------|------|--------|----------|------|--------|-----|---|
| 0467307 | 16cm | chroom | 39410000 | stuk | 198,00 | 176 | 1 |
| 0452097 | 22cm | chroom | 39411000 | stuk | 232,00 | 176 | 1 |



Douchegarnituur

Accessoires en
spiegels**kleurset voor 4-gats badrandkraan m. kruisgreep z. plaat**

| | | | | | | | |
|---------|-----------------------------------|--------|----------|------|---------|-----|---|
| 0467308 | | chroom | 39445000 | stuk | 1062,00 | 176 | 1 |
| 0451495 | basismunituur 4-gats badrandkraan | | 13444180 | stuk | 614,00 | 176 | 0 |



Douchewanden

kleurset voor 4-gats badrandkraan m. kruisgreep m. plaat

| | | | | | | | |
|---------|-----------------------------------|--------|----------|------|---------|-----|---|
| 0450111 | | chroom | 39443000 | stuk | 1215,00 | 176 | 1 |
| 0451495 | basismunituur 4-gats badrandkraan | | 13444180 | stuk | 614,00 | 176 | 0 |

kleurset voor 4-gats badrandkraan m. rechte greep z. plaat

| | | | | | | | |
|---------|-----------------------------------|--------|----------|------|---------|-----|---|
| 0467309 | | chroom | 39446000 | stuk | 1062,00 | 176 | 1 |
| 0451495 | basismunituur 4-gats badrandkraan | | 13444180 | stuk | 614,00 | 176 | 0 |

Spoel- &
installatiesystemenBadkamermeubelen
en toiletkasten**kleurset voor 4-gats badrandkraan m. rechte greep m. plaat**

| | | | | | | | |
|---------|-----------------------------------|--------|----------|------|---------|-----|---|
| 0450112 | | chroom | 39444000 | stuk | 1185,00 | 176 | 1 |
| 0451495 | basismunituur 4-gats badrandkraan | | 13444180 | stuk | 614,00 | 176 | 0 |

Gootstenen en
wastroggen**kleurset voor 4-gats tegelrandkraan m. kruisgreep m. plaat**

| | | | | | | | |
|---------|-------------------------------------|--------|----------|------|---------|-----|---|
| 0467310 | | chroom | 39452000 | stuk | 1420,00 | 176 | 1 |
| 0454885 | basismunituur 4-gats tegelrandkraan | | 14445180 | stuk | 1055,00 | 176 | 1 |

**kleurset voor 4-gats tegelrandkraan m. kruisgreep z. plaat**

| | | | | | | | |
|---------|-------------------------------------|--------|----------|------|---------|-----|---|
| 0467311 | | chroom | 39453000 | stuk | 1296,00 | 176 | 1 |
| 0454885 | basismunituur 4-gats tegelrandkraan | | 14445180 | stuk | 1055,00 | 176 | 1 |





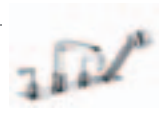

kleurset voor 4-gats tegelrandkraan m. rechte greep m. plaat

| | | | | | | | |
|---------|-------------------------------------|--------|----------|------|---------|-----|---|
| 0467312 | | chroom | 39456000 | stuk | 1420,00 | 176 | 1 |
| 0454885 | basismunituur 4-gats tegelrandkraan | | 14445180 | stuk | 1055,00 | 176 | 1 |

**kleurset voor 4-gats tegelrandkraan m. rechte greep z. plaat**

| | | | | | | | |
|---------|-------------------------------------|--------|----------|------|---------|-----|---|
| 0467313 | | chroom | 39454000 | stuk | 1296,00 | 176 | 1 |
| 0454885 | basismunituur 4-gats tegelrandkraan | | 14445180 | stuk | 1055,00 | 176 | 1 |

| | Art.nr | Specificaties | Kleur | Lev.nr | Ehd | Prijs | Grp | CC |
|---|---|---------------------------------|--------|----------|------|---------|-----|----|
| Sanitair producten | Hansgrohe AXOR Citterio | | | | | | | |
| | kleurset voor inbouwbadkraan | | | | | | | |
| | 0467305 | | chroom | 39455000 | stuk | 334,00 | 176 | 1 |
| | 0467306 | m. zekerheidscombinatie | chroom | 39457000 | stuk | 432,00 | 176 | 1 |
| Baden / douchebakken / stoomcabines | 0457051 | basisgarnituur I-box universeel | | 01800180 | stuk | 107,00 | 176 | 0 |
| | 1-greeps douchekraan HOH=15cm | | | | | | | |
| | 0467314 | | chroom | 39600000 | stuk | 630,00 | 176 | 1 |
| Douchegarnituur | showerpipe compleet | | | | | | | |
| | 0467316 | | chroom | 39620000 | stuk | 1728,00 | 176 | 1 |
| Accessoires en spiegels | kleurset voor inbouwthermostaat m. stopkraan m. rechte greep | | | | | | | |
| | 0467315 | | chroom | 39655000 | stuk | 309,00 | 176 | 1 |
| Douchewanden | 0457051 | basisgarnituur I-box universeel | | 01800180 | stuk | 107,00 | 176 | 0 |
| | kleurset voor inbouwthermostaat m. stopkraan m. kruisgreep | | | | | | | |
| Toebehoren & afvoeren | 0467319 | | chroom | 39705000 | stuk | 593,00 | 176 | 1 |
| | 0457051 | basisgarnituur I-box universeel | | 01800180 | stuk | 107,00 | 176 | 0 |
| Spoel- & installatiesystemen | kleurset voor inbouwthermostaat m. stopkraan m. rechte greep | | | | | | | |
| | 0467320 | | chroom | 39700000 | stuk | 593,00 | 176 | 1 |
| Badkamermeubelen en toiletkasten | 0457051 | basisgarnituur I-box universeel | | 01800180 | stuk | 107,00 | 176 | 0 |
| | kleurset voor inbouwthermostaat m. stopkraan m. kruisgreep | | | | | | | |
| Gootstenen en wastroggen | 0467317 | | chroom | 39715000 | stuk | 494,00 | 176 | 1 |
| | 0457051 | basisgarnituur I-box universeel | | 01800180 | stuk | 107,00 | 176 | 0 |
| Utiliteit | kleurset voor inbouwthermostaat m. stopkraan m. omstel m. rechte greep | | | | | | | |
| | 0467322 | | chroom | 39720000 | stuk | 679,00 | 176 | 1 |
| | 0457051 | basisgarnituur I-box universeel | | 01800180 | stuk | 107,00 | 176 | 0 |

| Art.nr | Specificaties | Kleur | Lev.nr | Ehd | Prijs | Grp | CC | |
|---|---|-------|----------|------|---------|-----|----|---|
| Hansgrohe AXOR Citterio | | | | | | | | |
| kleurset voor inbouwthermostaat m. stopkraan m. omstel m. kruisgreep | | | | | | | | |
| 0467321 | | chrom | 39725000 | stuk | 679,00 | 176 | 1 |  |
| 0457051 | basisgarnituur l-box universeel | | 01800180 | stuk | 107,00 | 176 | 0 | |
| kleurset voor inbouwthermostaat Highflow m. rechte greep | | | | | | | | |
| 0450179 | voor Raindance Royal | chrom | 39711000 | stuk | 533,00 | 176 | 1 | |
| 0457051 | basisgarnituur l-box universeel | | 01800180 | stuk | 107,00 | 176 | 0 | |
| kleurset voor inbouwthermostaat Highflow m. kruisgreep | | | | | | | | |
| 0450177 | voor Raindance Royal | chrom | 39716000 | stuk | 533,00 | 176 | 1 | |
| 0457051 | basisgarnituur l-box universeel | | 01800180 | stuk | 107,00 | 176 | 0 | |
| Fixfit AXOR Citterio muuraansluitbocht 1/2" m. stopkraan m. rechte greep | | | | | | | | |
| 0467328 | | chrom | 39882000 | stuk | 173,00 | 176 | 1 |  |
| Fixfit AXOR Citterio muuraansluitbocht 1/2" m. stopkraan m. kruisgreep | | | | | | | | |
| 0467327 | | chrom | 39883000 | stuk | 173,00 | 176 | 1 |  |
| kleurset voor Quatro 4-weg stop- en omstelkraan m. rechte greep | | | | | | | | |
| 0467326 | | chrom | 39920000 | stuk | 149,00 | 176 | 1 |  |
| 0450403 | basisgarnituur Trio inbouw stop- en omstelkraan | | 15981180 | stuk | 118,00 | 176 | 0 | |
| 0457698 | basisgarnituur Quatro inbouw 4wegs omstelkraan | | 15930180 | stuk | 192,00 | 176 | 1 | |
| 0457701 | verlengset 25mm | | 96370000 | stuk | 38,75 | 176 | 1 | |
| kleurset voor Quatro 4-weg stop- en omstelkraan m. kruisgreep | | | | | | | | |
| 0467325 | | chrom | 39925000 | stuk | 149,00 | 176 | 1 |  |
| 0450403 | basisgarnituur Trio inbouw stop- en omstelkraan | | 15981180 | stuk | 118,00 | 176 | 0 | |
| 0457698 | basisgarnituur Quatro inbouw 4wegs omstelkraan | | 15930180 | stuk | 192,00 | 176 | 1 | |
| 0457701 | verlengset 25mm | | 96370000 | stuk | 38,75 | 176 | 1 | |
| kleurset voor inbouw stopkraan m. rechte greep | | | | | | | | |
| 0467324 | | chrom | 39960000 | stuk | 99,00 | 176 | 1 |  |
| 0457701 | verlengset 25mm | | 96370000 | stuk | 38,75 | 176 | 1 | |
| 0457736 | basisgarnituur stopkraan m. spindel DN15 | | 15973180 | stuk | 61,50 | 176 | 0 | |
| 0457744 | basisgarnituur stopkraan m. keramische delen DN15 | | 15974180 | stuk | 64,00 | 176 | 0 | |
| 0457752 | basisgarnituur stopkraan m. spindel DN20 | | 15970180 | stuk | 67,00 | 176 | 1 | |
| kleurset voor inbouw stopkraan m. kruisgreep | | | | | | | | |
| 0467323 | | chrom | 39965000 | stuk | 99,00 | 176 | 1 |  |
| 0457701 | verlengset 25mm | | 96370000 | stuk | 38,75 | 176 | 1 | |
| 0457736 | basisgarnituur stopkraan m. spindel DN15 | | 15973180 | stuk | 61,50 | 176 | 0 | |
| 0457744 | basisgarnituur stopkraan m. keramische delen DN15 | | 15974180 | stuk | 64,00 | 176 | 0 | |
| 0457752 | basisgarnituur stopkraan m. spindel DN20 | | 15970180 | stuk | 67,00 | 176 | 1 | |
| zuil voor badkraan | | | | | | | | |
| 0450109 | | wit | 39985000 | stuk | 1222,00 | 176 | 1 | |
| 0450110 | | zwart | 39986000 | stuk | 1222,00 | 176 | 1 | |
| onderhoudsset voor het bad | | | | | | | | |
| 0450161 | | | 39990000 | stuk | 46,75 | 176 | 1 | |

Sanitair producten

Baden /
douchebakken /
stoomcabines

Kranen

Douchegarnituur

Accessoires en
spiegels









Douchewanden

Toebehoren &
afvoerenSpoel- &
installatiesystemenBadkamermeubelen
en toiletkastenGootstenen en
wastroggen

Utiliteit

| | Art.nr | Specificaties | Kleur | Lev.nr | Ehd | Prijs | Grp | CC |
|---|---|-------------------|------------|----------|------|---------|-----|----|
| Sanitair producten | Hansgrohe Ecostat-1001SL | | | | | | | |
| | showerpipe set compleet | | | | | | | |
| | 0451262 | | chrom | 27160000 | stuk | 1053,00 | 176 | 1 |
| Baden / douchebakken / stoomcabines | douchethermostaat HOH=12cm z. koppelingen z. rozet | | | | | | | |
| | 0459356 | | chrom | 13266000 | stuk | 206,00 | 218 | 0 |
| Kranen | douchethermostaat HOH=15cm z. koppelingen z. rozet | | | | | | | |
| | 0459364 | | chrom | 13278000 | stuk | 206,00 | 218 | 1 |
| Douchegarnituur | douchethermostaat HOH=15cm m. koppelingen m. rozet | | | | | | | |
| | 0459372 | | chrom | 13261000 | stuk | 216,00 | 218 | 0 |
| | 0510418 | | RVS look | 13261800 | stuk | 320,00 | 218 | 1 |
| Accessoires en spiegels | badthermostaat HOH=15cm m. koppelingen m. omstel | | | | | | | |
| | 0459348 | | chrom | 13241000 | stuk | 269,00 | 218 | 0 |
| Douchewanden | 0450458 | | | | | | | |
| | | | RVS | 13241800 | stuk | 397,00 | 176 | 1 |
| Toebehoren & afvoeren | Renovatieset HOH=15cm m. Unica'S/Croma 2jet | | | | | | | |
| | 0450246 | glijstangset 90cm | chrom | 27063000 | stuk | 276,00 | 176 | 1 |
| | 0459860 | glijstangset 65cm | chrom | 27064000 | stuk | 268,00 | 259 | 0 |
| Spoel- & installatiesystemen | schuifrozet per stuk | | | | | | | |
| | 0607010 | | chrom | 96467000 | stuk | 10,50 | 350 | 1 |
| Badkamermeubelen en toiletkasten | Care badthermostaat HOH=15cm m. koppelingen m. omstel m. hendel | | | | | | | |
| | 0450573 | | chrom | 13284000 | stuk | 365,00 | 176 | 1 |
| Gootstenen en wastroggen | Care douchethermostaat HOH=15cm m. koppelingen z. omstel m. hendel | | | | | | | |
| | 0450574 | | chrom | 13282000 | stuk | 290,00 | 176 | 1 |
| Utiliteit | Hansgrohe Ecostat-2001 | | | | | | | |
| | douchethermostaat HOH=15cm m. koppelingen z. omstel | | | | | | | |
| | 0451983 | | chrom | 13360000 | stuk | 331,00 | 218 | 0 |
| | 0456055 | | satinox | 13360810 | stuk | 435,00 | 218 | 1 |
| | badthermostaat HOH=15cm m. koppelingen m. omstel | | | | | | | |
| | 0451991 | | chrom | 13340000 | stuk | 418,00 | 218 | 1 |
| | 0452010 | | chrom/goud | 13340090 | stuk | 497,00 | 218 | 1 |
| | kleurset voor inbouwthermostaat electronisch | | | | | | | |
| | 0458741 | | chrom | 15740000 | stuk | 535,00 | 373 | 1 |
| | 0458740 | | RVS | 15740800 | stuk | 734,00 | 176 | 1 |
| | Hansgrohe Ecostat-5001 | | | | | | | |
| | douchethermostaat HOH=15cm z. omstel | | | | | | | |
| | 0453676 | | chrom | 15360000 | stuk | 537,00 | 218 | 1 |

| Art.nr | Specificaties | Kleur | Lev.nr | Ehd | Prijs | Grp | CC | | |
|--|---------------|-------|----------|------|--------|-----|----|---|---|
| | | | | | | | | Hansgrohe Ecostat-5001 | |
| badthermostaat HOH=15cm m. koppelingen m. omstel 0453684 | | chrom | 15340000 | stuk | 652,00 | 218 | 1 |  | Sanitair producten |
| | | | | | | | | Hansgrohe Focus-E | |
| wastafelkraan m. waste 0450134 | | chrom | 31700000 | stuk | 80,50 | 176 | 0 |  | Baden / douchebakken / stoomcabines |
| wastafelkraan z. waste 0450148 | | chrom | 31718000 | stuk | 73,50 | 176 | 1 | | Kranen |
| 1-gats bidetkraan m. waste 0450142 | | chrom | 31720000 | stuk | 80,50 | 176 | 1 |  | Douchegarnituur |
| Project 1-gats bidetkraan 0450519 | | chrom | 31722000 | stuk | 75,00 | 176 | 1 | | Accessoires en spiegels |
| badkraan m. omstel 0450135 | | chrom | 31740000 | stuk | 99,00 | 176 | 1 |  | Douchewanden |
| douchekraan z. omstel 0450136 | | chrom | 31760000 | stuk | 83,00 | 176 | 1 |  | Toebehoren & afvoeren |
| kleurset voor inbouwdouchekraan 0450144 | | chrom | 31765000 | stuk | 29,50 | 176 | 1 |  | Spoel- & installatiesystemen |
| 0450147 inbouwdeel voor inbouwdouchekraan | | | 13620180 | stuk | 78,50 | 176 | 1 | | Badkamermeubelen en toiletkasten |
| kleurset voor inbouwbadkraan 0450143 | | chrom | 31745000 | stuk | 32,50 | 176 | 1 |  | Gootstenen en wastroggen |
| 0450146 inbouwdeel voor inbouwbadkraan | | | 31741180 | stuk | 88,00 | 176 | 1 | | Utiliteit |
| inbouwdeel voor inbouwdouchekraan 0450147 | | | 13620180 | stuk | 78,50 | 176 | 1 | | |
| inbouwdeel voor inbouwbadkraan 0450146 | | | 31741180 | stuk | 88,00 | 176 | 1 | | |
| | | | | | | | | Hansgrohe Focus-S | |
| 1-gats fonteinkraan 0450562 | | chrom | 13132000 | stuk | 91,00 | 176 | 1 | | |

| | Art.nr | Specificaties | Kleur | Lev.nr | Ehd | Prijs | Grp | CC |
|---|--|---|-------|----------|------|--------|-----|----|
| | Hansgrohe Focus-S | | | | | | | |
| Sanitair producten | | 1-gats wastafelkraan m. waste 0450511 | chrom | 31701000 | stuk | 103,00 | 176 | 1 |
| |  | | | | | | | |
| Baden / douchebakken / stoomcabines | | Project 1-gats wastafelkraan 0450512 | chrom | 31711000 | stuk | 96,00 | 176 | 1 |
| Kranen | | | | | | | | |
| |  | | | | | | | |
| Douchegarnituur | | 1-gats bidetkraan 0450513 | chrom | 31721000 | stuk | 103,00 | 176 | 1 |
| |  | | | | | | | |
| Accessoires en spiegels | | Project 1-gats bidetkraan 0450514 | chrom | 31723000 | stuk | 96,00 | 176 | 1 |
| Douchewanden | | | | | | | | |
| |  | | | | | | | |
| Toebehoren & afvoeren | | badkraan m. omstel 0450515 | chrom | 31742000 | stuk | 127,00 | 176 | 1 |
| Spoel- & installatiesystemen | | | | | | | | |
| |  | | | | | | | |
| Badkamermeubelen en toiletkasten | | baduitloop 3/4" 0452662 | chrom | 13414000 | stuk | 71,00 | 176 | 1 |
| Gootstenen en wastroggen | | | | | | | | |
| |  | | | | | | | |
| Utiliteit | | douchekraan z. omstel 0450516 | chrom | 31762000 | stuk | 106,00 | 176 | 1 |
| |  | | | | | | | |
| | | afbouwdeel voor inbouwbadkraan 0450517 | chrom | 31743000 | stuk | 127,00 | 176 | 1 |
| |  | 0457051 basisgarnituur I-box universeel | | 01800180 | stuk | 107,00 | 176 | 0 |
| | | afbouwdeel voor inbouwdouchekraan 0450518 | chrom | 31763000 | stuk | 118,00 | 176 | 1 |
| |  | 0457051 basisgarnituur I-box universeel | | 01800180 | stuk | 107,00 | 176 | 0 |

Wie laat het
water ademen?
Hans!



Raindance[®] AIR - 2005



Axor Massaud - 2006

Wie brengt
vernieuwend
design in de
badkamer?
Hans!

Wie biedt
keuze in stijl
en budget?
Hans!



Focus E en S - 2005

Niemand is als Hans: want bijna alle technologische ontwikkelingen op gebied van douchen vinden hun oorsprong bij Hansgrohe. Geheel in de innovatieve geest van oprichter Hans Grohe, die hij heeft overgedragen aan de volgende generatie, die vandaag het bedrijf leidt. Misschien dat u hieraan denkt als u de volgende keer de naam ziet: Wie heeft het uitgevonden? Natuurlijk - Hans! Meer informatie over Hansgrohe vindt u op www.hansgrohe.nl of bel 075-6461400.

hansgrohe

Het origineel sinds 1901.

| | Art.nr | Specificaties | Kleur | Lev.nr | Ehd | Prijs | Grp | CC |
|---|---|--------------------------|--------|----------|------|---------|-----|----|
| | Hansgrohe Massaud | | | | | | | |
| Sanitair producten | 1-gats wastafelkraan | | | | | | | |
| | 0450579 | m. flexibele aansluiting | chroom | 18010000 | stuk | 586,00 | 176 | 1 |
| | 0450580 | m. aansluitpijpen | chroom | 18014000 | stuk | 586,00 | 176 | 1 |
| Baden / douchebakken / stoomcabines | 3-gats wastafelkraan | | | | | | | |
| | 0450581 | | chroom | 18013000 | stuk | 716,00 | 176 | 1 |
| Kranen | wastafelkraan highriser | | | | | | | |
| | 0450585 | | chroom | 18020000 | stuk | 882,00 | 176 | 1 |
| Douchegarnituur | afbouwset voor 3-gats wandkraan | | | | | | | |
| | 0450582 | 16cm | chroom | 18112000 | stuk | 781,00 | 176 | 1 |
| | 0450583 | 22cm | chroom | 18115000 | stuk | 781,00 | 176 | 1 |
| Accessoires en spiegels | 1-gats bidetkraan | | | | | | | |
| | 0450586 | | chroom | 18210000 | stuk | 586,00 | 176 | 1 |
| Spoel- & installatiesystemen | 3-gats bidetkraan | | | | | | | |
| | 0450587 | | chroom | 18213000 | stuk | 716,00 | 176 | 1 |
| Badkamermeubelen en toiletkasten | afbouwset voor 4-gats badrandkraan | | | | | | | |
| | 0450593 | | chroom | 18440000 | stuk | 1301,00 | 176 | 1 |
| Gootstenen en wastroggen | afbouwset voor 4-gats tegelrandkraan | | | | | | | |
| | 0450594 | | chroom | 18453000 | stuk | 1562,00 | 176 | 1 |
| Utiliteit | afbouwset voor staande badkraan | | | | | | | |
| | 0450592 | | chroom | 18450000 | stuk | 2277,00 | 176 | 1 |

| Art.nr | Specificaties | Kleur | Lev.nr | Ehd | Prijs | Grp | CC |
|--------|---------------|-------|--------|-----|-------|-----|----|
|--------|---------------|-------|--------|-----|-------|-----|----|

Hansgrohe Massaud

afbouwset voor inbouwbadkraan
0450588

chromm 18455000 stuk 391,00 176 1



Sanitair producten

Baden /
douchebakken /
stoomcabines

baduitloop
0450589 16cm
0450590 22cm

chromm 18472000 stuk 521,00 176 1

chromm 18473000 stuk 521,00 176 1



Kranen

Douchegarnituur

afbouwset voor inbouwdouchekraan
0450595

chromm 18655000 stuk 361,00 176 1

Accessoires en
spiegels

Douchewanden

afbouwset voor inbouwthermostaat

0450596

chromm 18740000 stuk 586,00 176 1

0450597 High Flow

chromm 18741000 stuk 657,00 176 1

Toebehoren &
afvoeren

afbouwset voor inbouwthermostaat m. stopkraan
0450598

chromm 18745000 stuk 663,00 176 1

Spoel- &
installatiesystemenBadkamermeubelen
en toiletkasten

afbouwset voor inbouwthermostaat m. stopkraan m. omstel
0450599

chromm 18750000 stuk 781,00 176 1

Gootstenen en
wastroggen

Utiliteit

Hansgrohe Metris-E

1-gats wastafelkraan
0450225

chromm 31070000 stuk 156,00 176 0



1-gats fonteinkraan
0450226







chromm 31072000 stuk 148,00 176 1

















1-gats bidetkraan
0450227









chromm 31270000 stuk 156,00 176 1



| | Art.nr | Specificaties | Kleur | Lev.nr | Ehd | Prijs | Grp | CC |
|---|---|----------------------------------|-------|----------|------|--------|-----|----|
| Sanitair producten | Hansgrohe Metris-E | | | | | | | |
| | badkraan m. omstel | | | | | | | |
| | 0450228 | | chrom | 31470000 | stuk | 203,00 | 176 | 1 |
| |  | | | | | | | |
| Baden / douchebakken / stoomcabines | kleurset voor inbouwbadkraan | | | | | | | |
| | 0450229 | | chrom | 31475000 | stuk | 140,00 | 176 | 1 |
| Kranen | 0457051 | basisgarnituur l-box universeel | | 01800180 | stuk | 107,00 | 176 | 0 |
| | 0457647 | verlengset lbox 25mm | | 13595000 | stuk | 33,50 | 176 | 1 |
| | 0606871 | opvulrozet voor l-box 22mm chrom | | 13596000 | stuk | 31,50 | 176 | 1 |
| |  | | | | | | | |
| Douchegarnituur | kleurset voor inbouwbadkraan m. zekerheidscombinatie | | | | | | | |
| | 0454285 | | chrom | 31476000 | stuk | 203,00 | 176 | 1 |
| Accessoires en spiegels | douchekraan | | | | | | | |
| | 0450230 | | chrom | 31670000 | stuk | 156,00 | 176 | 1 |
| |  | | | | | | | |
| Douchewanden | kleurset voor inbouwdouchekraan | | | | | | | |
| | 0450231 | | chrom | 31675000 | stuk | 127,00 | 176 | 1 |
| Toebehoren & afvoeren | 0457051 | basisgarnituur l-box universeel | | 01800180 | stuk | 107,00 | 176 | 0 |
| | 0457647 | verlengset lbox 25mm | | 13595000 | stuk | 33,50 | 176 | 1 |
| | 0606871 | opvulrozet voor l-box 22mm chrom | | 13596000 | stuk | 31,50 | 176 | 1 |
| |  | | | | | | | |
| Spoel- & installatiesystemen | Hansgrohe Metris-S | | | | | | | |
| Badkamermeubelen en toiletkasten | 1-gats fonteinkraan | | | | | | | |
| | 0450562 | | chrom | 13132000 | stuk | 91,00 | 176 | 1 |
| Gootstenen en wastroggen | 1-gats wastafelkraan | | | | | | | |
| | 0450232 | | chrom | 31060000 | stuk | 180,00 | 176 | 0 |
| |  | | | | | | | |
| Utiliteit | electronische wastafelkraan | | | | | | | |
| | 0450571 | | chrom | 31102000 | stuk | 533,00 | 383 | 1 |
| | 0450572 | batterij | chrom | 31100000 | stuk | 503,00 | 383 | 1 |
| | 1-gats bidetkraan | | | | | | | |
| | 0450233 | | chrom | 31261000 | stuk | 180,00 | 176 | 1 |
| |  | | | | | | | |
| | badkraan m. omstel | | | | | | | |
| | 0450234 | | chrom | 31460000 | stuk | 234,00 | 176 | 0 |
| |  | | | | | | | |
| | baduitloop 3/4" | | | | | | | |
| | 0452662 | | chrom | 13414000 | stuk | 71,00 | 176 | 1 |

| Art.nr | Specificaties | Kleur | Lev.nr | Ehd | Prijs | Grp | CC | | |
|---|----------------------------------|------------|----------|------|--------|-----|----|---|---|
| Hansgrohe Metris-S | | | | | | | | | |
| kleurset voor inbouwbadkraan | | | | | | | | | |
| 0450235 | | chrom | 31465000 | stuk | 161,00 | 176 | 1 |  | Sanitair producten |
| 0457051 | basisgarnituur l-box universeel | | 01800180 | stuk | 107,00 | 176 | 0 | | Baden / douchebakken / stoomcabines |
| 0457647 | verlengset lbox 25mm | | 13595000 | stuk | 33,50 | 176 | 1 | | |
| 0606871 | opvulrozet voor l-box 22mm chrom | | 13596000 | stuk | 31,50 | 176 | 1 | | |
| kleurset voor inbouwbadkraan m. zekerheidscombinatie | | | | | | | | | |
| 0454286 | | chrom | 31466000 | stuk | 234,00 | 176 | 1 | | Kranen |
| kleurset voor inbouwthermostaat | | | | | | | | | |
| 0450557 | | chrom | 15711000 | stuk | 414,00 | 176 | 1 | | Douchegarnituur |
| kleurset voor inbouwthermostaat m. stopkraan | | | | | | | | | |
| 0450558 | | chrom | 15701000 | stuk | 503,00 | 176 | 1 | | Accessoires en spiegels |
| kleurset voor inbouwthermostaat m. omstel m. stopkraan | | | | | | | | | |
| 0450559 | | chrom | 15721000 | stuk | 577,00 | 176 | 1 | | Douchewanden |
| douchekraan | | | | | | | | | |
| 0450236 | | chrom | 31660000 | stuk | 180,00 | 176 | 1 |  | Toebehoren & afvoeren |
| kleurset voor inbouwdouchekraan | | | | | | | | | |
| 0450237 | | chrom | 31665000 | stuk | 146,00 | 176 | 1 |  | Spoel- & installatiesystemen |
| 0457051 | basisgarnituur l-box universeel | | 01800180 | stuk | 107,00 | 176 | 0 | | |
| 0457647 | verlengset lbox 25mm | | 13595000 | stuk | 33,50 | 176 | 1 | | |
| 0606871 | opvulrozet voor l-box 22mm chrom | | 13596000 | stuk | 31,50 | 176 | 1 | | |
| Hansgrohe Metropol-E | | | | | | | | | |
| 1-gats wastafelkraan m. waste | | | | | | | | | |
| 0450188 | | chrom | 14070000 | stuk | 180,00 | 176 | 0 |  | Badkamermeubelen en toiletkasten |
| 0450189 | | chrom/goud | 14070090 | stuk | 216,00 | 176 | 1 | | Gootstenen en wastroggen |
| 3-gats wastafelkraan | | | | | | | | | |
| 0454274 | | chrom | 14033000 | stuk | 363,00 | 176 | 1 |  | Utiliteit |
| 0454275 | | chrom/goud | 14033090 | stuk | 435,00 | 176 | 1 | | |
| 1-gats fonteinkraan m. waste | | | | | | | | | |
| 0450190 | | chrom | 14072000 | stuk | 169,00 | 176 | 1 |  | |
| 0450191 | | chrom/goud | 14072090 | stuk | 203,00 | 176 | 1 | | |
| 1-gats bidetkraan | | | | | | | | | |
| 0450192 | | chrom | 14270000 | stuk | 180,00 | 176 | 1 |  | |
| 0450193 | | chrom/goud | 14270090 | stuk | 216,00 | 176 | 1 | | |
| 3-gats bidetkraan | | | | | | | | | |
| 0454276 | | chrom | 14233000 | stuk | 363,00 | 176 | 1 | | |
| 0454277 | | chrom/goud | 14233090 | stuk | 435,00 | 176 | 1 | | |

| | Art.nr | Specificaties | Kleur | Lev.nr | Ehd | Prijs | Grp | CC |
|---|---|-----------------------------------|-------------|----------|------|--------|-----|----|
| Sanitair producten | Hansgrohe Metropol-E | | | | | | | |
| | badkraan m. omstel | | | | | | | |
| | 0450194 | | chroom | 14470000 | stuk | 236,00 | 176 | 1 |
| | 0450195 | | chroom/goud | 14470090 | stuk | 283,00 | 176 | 1 |
| Baden / douchebakken / stoomcabines |  | | | | | | | |
| Kranen | kleurset voor inbouwbadkraan | | | | | | | |
| | 0450196 | | chroom | 14475000 | stuk | 156,00 | 176 | 1 |
| | 0450197 | | chroom/goud | 14475090 | stuk | 187,00 | 176 | 1 |
| | 0457051 | basisgarnituur l-box universeel | | 01800180 | stuk | 107,00 | 176 | 0 |
| | 0457647 | verlengset lbox 25mm | | 13595000 | stuk | 33,50 | 176 | 1 |
| | 0606871 | opvulrozet voor l-box 22mm chroom | | 13596000 | stuk | 31,50 | 176 | 1 |
| Douchegarnituur | kleurset voor inbouwbadkraan m. zekerheidscombinatie | | | | | | | |
| | 0454280 | | chroom | 14477000 | stuk | 219,00 | 176 | 1 |
| | 0454282 | | matchroom | 14477090 | stuk | 262,00 | 176 | 1 |
| Accessoires en spiegels | douchekraan | | | | | | | |
| | 0450199 | | chroom/goud | 14670090 | stuk | 216,00 | 176 | 1 |
| Douchewanden |  | | | | | | | |
| Toebehoren & afvoeren | kleurset voor inbouwdouchekraan | | | | | | | |
| | 0450373 | | chroom | 14675000 | stuk | 141,00 | 176 | 1 |
| | 0450374 | | chroom/goud | 14675090 | stuk | 169,00 | 176 | 1 |
| | 0457051 | basisgarnituur l-box universeel | | 01800180 | stuk | 107,00 | 176 | 0 |
| | 0457647 | verlengset lbox 25mm | | 13595000 | stuk | 33,50 | 176 | 1 |
| | 0606871 | opvulrozet voor l-box 22mm chroom | | 13596000 | stuk | 31,50 | 176 | 1 |
| Spoel- & installatiesystemen | Hansgrohe Metropol-S | | | | | | | |
| | 1-gats wastafelkraan m. waste | | | | | | | |
| | 0450375 | | chroom | 14061000 | stuk | 204,00 | 176 | 0 |
| Badkamermeubelen en toiletkasten | 0450203 | | matchroom | 14061880 | stuk | 265,00 | 176 | 1 |
| |  | | | | | | | |
| Gootstenen en wastroggen | 3-gats wastafelkraan m. waste | | | | | | | |
| | 0450209 | | chroom | 14063000 | stuk | 421,00 | 176 | 1 |
| | 0450210 | | matchroom | 14063880 | stuk | 547,00 | 176 | 1 |
| Utiliteit |  | | | | | | | |
| | 1-gats wastafelkraan m. waste m. koperen aansluitpijpen | | | | | | | |
|  | 0450207 | | chroom | 14066000 | stuk | 204,00 | 176 | 1 |
| | 0450208 | | matchroom | 14066880 | stuk | 254,00 | 176 | 1 |
|  | 1-gats wastafelkraan z. waste | | | | | | | |
| | 0450376 | | chroom | 14068000 | stuk | 196,00 | 176 | 1 |
| | 0450206 | | matchroom | 14068880 | stuk | 254,00 | 176 | 1 |
|  | highriser | | | | | | | |
| | 0450548 | | chroom | 14020000 | stuk | 261,00 | 176 | 1 |
|  | 1-gats bidetkraan | | | | | | | |
| | 0450211 | | chroom | 14262000 | stuk | 204,00 | 176 | 1 |
| | 0450212 | | matchroom | 14262880 | stuk | 265,00 | 176 | 1 |

| Art.nr | Specificaties | Kleur | Lev.nr | Ehd | Prijs | Grp | CC | |
|---|-----------------------------------|-----------------|----------|------|--------|-----|----|---|
| Hansgrohe Metropol-S | | | | | | | | |
| 3-gats bidetkraan m. waste | | | | | | | | |
| 0450213 | | chroom | 14263000 | stuk | 421,00 | 176 | 1 |  |
| 0450214 | | matchroom | 14263880 | stuk | 547,00 | 176 | 1 | |
| baduitloop | | | | | | | | |
| 0450219 | | chroom | 14420000 | stuk | 120,00 | 176 | 1 |  |
| 0450220 | | matchroom | 14420880 | stuk | 155,00 | 176 | 1 | |
| badkraan m. omstel | | | | | | | | |
| 0450215 | | chroom | 14461000 | stuk | 268,00 | 176 | 1 |  |
| 0450216 | | matchroom | 14461880 | stuk | 348,00 | 176 | 1 | |
| kleurset voor inbouwbadkraan | | | | | | | | |
| 0450217 | | chroom | 14465000 | stuk | 177,00 | 176 | 1 |  |
| 0450218 | | matchroom | 14465880 | stuk | 230,00 | 176 | 1 | |
| 0457051 | basigarnituur l-box universeel | | 01800180 | stuk | 107,00 | 176 | 0 | |
| 0457647 | verlengset lbox 25mm | | 13595000 | stuk | 33,50 | 176 | 1 | |
| 0606871 | opvulrozet voor l-box 22mm chroom | | 13596000 | stuk | 31,50 | 176 | 1 | |
| kleurset voor inbouwbadkraan m. zekerheidscombinatie | | | | | | | | |
| 0454278 | | chroom | 14466000 | stuk | 248,00 | 176 | 1 |  |
| 0454279 | | matchroom | 14466880 | stuk | 322,00 | 176 | 1 | |
| douchekraan | | | | | | | | |
| 0450222 | | matchroom | 14661880 | stuk | 265,00 | 176 | 1 |  |
| kleurset voor inbouwdouchekraan | | | | | | | | |
| 0450223 | | chroom | 14665000 | stuk | 160,00 | 176 | 1 |  |
| 0450224 | | matchroom | 14665880 | stuk | 208,00 | 176 | 1 | |
| 0457051 | basigarnituur l-box universeel | | 01800180 | stuk | 107,00 | 176 | 0 | |
| 0457647 | verlengset lbox 25mm | | 13595000 | stuk | 33,50 | 176 | 1 | |
| 0606871 | opvulrozet voor l-box 22mm chroom | | 13596000 | stuk | 31,50 | 176 | 1 | |
| kleurset voor inbouwthermostaat | | | | | | | | |
| 0450557 | | chroom | 15711000 | stuk | 414,00 | 176 | 1 | |
| kleurset voor inbouwthermostaat m. stopkraan | | | | | | | | |
| 0450558 | | chroom | 15701000 | stuk | 503,00 | 176 | 1 | |
| kleurset voor inbouwthermostaat m. omstel m. stopkraan | | | | | | | | |
| 0450559 | | chroom | 15721000 | stuk | 577,00 | 176 | 1 | |
| Hansgrohe Montreux | | | | | | | | |
| 1-gats wastafelkraan m. waste | | | | | | | | |
| 0450611 | | chroom | 16502000 | stuk | 426,00 | 176 | 1 |  |
| 0450612 | | brushed nikkel | 16502820 | stuk | 652,00 | 176 | 1 | |
| 0450613 | | polished nikkel | 16502830 | stuk | 565,00 | 176 | 1 | |
| 1-gats wastafelkraan z. waste | | | | | | | | |
| 0450614 | | chroom | 16506000 | stuk | 426,00 | 176 | 1 | |
| 0450615 | | brushed nikkel | 16506820 | stuk | 652,00 | 176 | 1 | |
| 0450616 | | polished nikkel | 16506830 | stuk | 565,00 | 176 | 1 | |

Sanitair producten

Baden /
douchebakken /
stoomcabines

Kranen









Douchegarnituur

Accessoires en
spiegels

Douchewanden

Toebehoren &
afvoerenSpoel- &
installatiesystemenBadkamermeubelen
en toiletkastenGootstenen en
wastroggen

Utiliteit

| | Art.nr | Specificaties | Kleur | Lev.nr | Ehd | Prijs | Grp | CC |
|---|---|---------------|-----------------|----------|------|---------|-----|----|
| Hansgrohe Montreux | | | | | | | | |
| Sanitair producten | 3-gats wastafelkraan | | | | | | | |
| | 0450620 | | chroom | 16513000 | stuk | 533,00 | 176 | 1 |
| | 0450621 | | brushed nikkel | 16513820 | stuk | 815,00 | 176 | 1 |
| | 0450622 | | polished nikkel | 16513830 | stuk | 706,00 | 176 | 1 |
| Baden / douchebakken / stoomcabines |  | | | | | | | |
| Kranen | 3-gats wastafelkraan brugmodel m. waste | | | | | | | |
| | 0450617 | | chroom | 16510000 | stuk | 710,00 | 176 | 1 |
| | 0450618 | | brushed nikkel | 16510820 | stuk | 1086,00 | 176 | 1 |
| | 0450619 | | polished nikkel | 16510830 | stuk | 941,00 | 176 | 1 |
| Douchegarnituur |  | | | | | | | |
| Accessoires en spiegels | afbouwset voor 3-gats wandkraan | | | | | | | |
| | 0450623 | | chroom | 16532000 | stuk | 450,00 | 176 | 1 |
| | 0450624 | | brushed nikkel | 16532820 | stuk | 688,00 | 176 | 1 |
| | 0450625 | | polished nikkel | 16532830 | stuk | 596,00 | 176 | 1 |
| Douchewanden |  | | | | | | | |
| Toebehoren & afvoeren | 1-gats fonteinkraan | | | | | | | |
| | 0450627 | | chroom | 16530000 | stuk | 217,00 | 176 | 1 |
| | 0450628 | | brushed nikkel | 16530820 | stuk | 332,00 | 176 | 1 |
| | 0450629 | | polished nikkel | 16530830 | stuk | 290,00 | 176 | 1 |
| Douchewanden |  | | | | | | | |
| Spoel- & installatiesystemen | 1-gats fonteinkraan 2-greeps | | | | | | | |
| | 0450630 | | chroom | 16505000 | stuk | 426,00 | 176 | 1 |
| | 0450631 | | brushed nikkel | 16505820 | stuk | 652,00 | 176 | 1 |
| | 0450632 | | polished nikkel | 16505830 | stuk | 565,00 | 176 | 1 |
| Badkamermeubelen en toiletkasten |  | | | | | | | |
| Gootstenen en wastroggen | 1-gats bidetkraan | | | | | | | |
| | 0451237 | | chroom | 16520000 | stuk | 426,00 | 176 | 1 |
| | 0451238 | | brushed nikkel | 16520820 | stuk | 652,00 | 176 | 1 |
| | 0451239 | | polished nikkel | 16520830 | stuk | 565,00 | 176 | 1 |
| Douchewanden |  | | | | | | | |
| Utiliteit | 3-gats bidetkraan | | | | | | | |
| | 0451240 | | chroom | 16523000 | stuk | 533,00 | 176 | 1 |
| | 0451241 | | brushed nikkel | 16523820 | stuk | 815,00 | 176 | 1 |
| | 0451242 | | polished nikkel | 16523830 | stuk | 706,00 | 176 | 1 |
| Douchewanden |  | | | | | | | |
| Douchewanden | douchekraan z. omstel | | | | | | | |
| | 0451170 | | chroom | 16560000 | stuk | 710,00 | 176 | 1 |
| | 0451171 | | brushed nikkel | 16560820 | stuk | 1086,00 | 176 | 1 |
| | 0451172 | | polished nikkel | 16560830 | stuk | 941,00 | 176 | 1 |
| Douchewanden |  | | | | | | | |
| Douchewanden | badkraan m. handdouche | | | | | | | |
| | 0451243 | | chroom | 16540000 | stuk | 834,00 | 176 | 1 |
| | 0451244 | | brushed nikkel | 16540820 | stuk | 1276,00 | 176 | 1 |
| | 0451245 | | polished nikkel | 16540830 | stuk | 1106,00 | 176 | 1 |
| Douchewanden |  | | | | | | | |

| Art.nr | Specificaties | Kleur | Lev.nr | Ehd | Prijs | Grp | CC |
|--------|---------------|-------|--------|-----|-------|-----|----|
|--------|---------------|-------|--------|-----|-------|-----|----|

Hansgrohe Montreux

2-gats badrandkraan m. handdouche

| | | | | | | | |
|---------|--|-----------------|----------|------|---------|-----|---|
| 0451246 | | chrom | 16542000 | stuk | 1001,00 | 176 | 1 |
| 0451247 | | brushed nikkel | 16542820 | stuk | 1531,00 | 176 | 1 |
| 0451248 | | polished nikkel | 16542830 | stuk | 1400,00 | 176 | 1 |



Sanitair producten

Baden /
douchebakken /
stoomcabines**afbouwset voor 4-gats badrandkraan m. handdouche**

| | | | | | | | |
|---------|--|-----------------|----------|------|---------|-----|---|
| 0451249 | | chrom | 16546000 | stuk | 1006,00 | 176 | 1 |
| 0451250 | | brushed nikkel | 16546820 | stuk | 1538,00 | 176 | 1 |
| 0451251 | | polished nikkel | 16546830 | stuk | 1333,00 | 176 | 1 |



Kranen

Douchegarnituur

afbouwset voor 4-gats tegelrandkraan m. handdouche

| | | | | | | | |
|---------|--|-----------------|----------|------|---------|-----|---|
| 0451252 | | chrom | 16544000 | stuk | 1219,00 | 176 | 1 |
| 0451253 | | brushed nikkel | 16544820 | stuk | 1864,00 | 176 | 1 |
| 0451254 | | polished nikkel | 16544830 | stuk | 1615,00 | 176 | 1 |

Accessoires en
spiegels

Douchewanden

baduitloop

| | | | | | | | |
|---------|--|-----------------|----------|------|--------|-----|---|
| 0451255 | | chrom | 16541000 | stuk | 166,00 | 176 | 1 |
| 0451256 | | brushed nikkel | 16541820 | stuk | 254,00 | 176 | 1 |
| 0451257 | | polished nikkel | 16541830 | stuk | 220,00 | 176 | 1 |

Toebehoren &
afvoeren**afbouwset voor badkraan op vloer m. handdouche**

| | | | | | | | |
|---------|--|-----------------|----------|------|---------|-----|---|
| 0451258 | | chrom | 16547000 | stuk | 1893,00 | 176 | 1 |
| 0451259 | | brushed nikkel | 16547820 | stuk | 2895,00 | 176 | 1 |
| 0451260 | | polished nikkel | 16547830 | stuk | 2509,00 | 176 | 1 |

Spoel- &
installatiesystemenBadkamermeubelen
en toiletkasten**basisgarnituur voor badkraan op vloer**

| | | | | | | | |
|---------|--|--|----------|------|--------|-----|---|
| 0451261 | | | 16549180 | stuk | 647,00 | 176 | 1 |
|---------|--|--|----------|------|--------|-----|---|

douchethermostaat z. omstel

| | | | | | | | |
|---------|--|-----------------|----------|------|--------|-----|---|
| 0451176 | | chrom | 16261000 | stuk | 308,00 | 176 | 1 |
| 0451177 | | brushed nikkel | 16261820 | stuk | 471,00 | 176 | 1 |
| 0451178 | | polished nikkel | 16261830 | stuk | 408,00 | 176 | 1 |

Gootstenen en
wastroggen

Utiliteit

badthermostaat m. omstel

| | | | | | | | |
|---------|--|-----------------|----------|------|--------|-----|---|
| 0451173 | | chrom | 16241000 | stuk | 391,00 | 176 | 1 |
| 0451174 | | brushed nikkel | 16241820 | stuk | 597,00 | 176 | 1 |
| 0451175 | | polished nikkel | 16241830 | stuk | 518,00 | 176 | 1 |

**showerpip compleet m. thermostaat**









| | | | | | | | |
|---------|--|-----------------|----------|------|---------|-----|---|
| 0451179 | | chrom | 16570000 | stuk | 1597,00 | 176 | 1 |
| 0451180 | | brushed nikkel | 16570820 | stuk | 2443,00 | 176 | 1 |
| 0451181 | | polished nikkel | 16570830 | stuk | 2117,00 | 176 | 1 |



| | Art.nr | Specificaties | Kleur | Lev.nr | Ehd | Prijs | Grp | CC | |
|---|---|--|-----------------|----------|------|--------|-----|----|--|
| | Hansgrohe Montreux | | | | | | | | |
| | afbouwset voor inbouwthermostaat | | | | | | | | |
| Sanitair producten | 0451182 | | chrom | 16810000 | stuk | 497,00 | 176 | 1 | |
| | 0451183 | | brushed nikkel | 16810820 | stuk | 760,00 | 176 | 1 | |
| | 0451184 | | polished nikkel | 16810830 | stuk | 659,00 | 176 | 1 | |
| Baden / douchebakken / stoomcabines | 0451185 | High Flow | chrom | 16815000 | stuk | 533,00 | 176 | 1 | |
| | 0451186 | High Flow | brushed nikkel | 16815820 | stuk | 815,00 | 176 | 1 | |
| | 0451187 | High Flow | polished nikkel | 16815830 | stuk | 706,00 | 176 | 1 | |
| | afbouwset voor inbouwthermostaat m. stopkraan | | | | | | | | |
| Kranen | 0451188 | | chrom | 16800000 | stuk | 568,00 | 176 | 1 | |
| | 0451189 | | brushed nikkel | 16800820 | stuk | 869,00 | 176 | 1 | |
| | 0451190 | | polished nikkel | 16800830 | stuk | 753,00 | 176 | 1 | |
| Douchegarnituur | | afbouwset voor inbouwthermostaat m. stopkraan m. omstel | | | | | | | |
| Accessoires en spiegels | 0451191 | | chrom | 16820000 | stuk | 627,00 | 176 | 1 | |
| | 0451192 | | brushed nikkel | 16820820 | stuk | 959,00 | 176 | 1 | |
| | 0451193 | | polished nikkel | 16820830 | stuk | 831,00 | 176 | 1 | |
| Douchewanden | | afbouwset voor inbouwstopkraan | | | | | | | |
| Toebehoren & afvoeren | 0451194 | | chrom | 16871000 | stuk | 113,00 | 176 | 1 | |
| | 0451195 | | brushed nikkel | 16871820 | stuk | 173,00 | 176 | 1 | |
| | 0451196 | | polished nikkel | 16871830 | stuk | 150,00 | 176 | 1 | |
| | afbouwset voor inbouwomstelkraan | | | | | | | | |
| Spoel- & installatiesystemen | 0451197 | | chrom | 16830000 | stuk | 178,00 | 176 | 1 | |
| | 0451198 | | brushed nikkel | 16830820 | stuk | 272,00 | 176 | 1 | |
| | 0451199 | | polished nikkel | 16830830 | stuk | 236,00 | 176 | 1 | |
| Badkamermeubelen en toiletkasten | | Fix Fit stopkraan | | | | | | | |
| Gootstenen en wastroggen | 0451200 | | chrom | 16882000 | stuk | 172,00 | 176 | 1 | |
| | 0451201 | | brushed nikkel | 16882820 | stuk | 263,00 | 176 | 1 | |
| | 0451202 | | polished nikkel | 16882830 | stuk | 228,00 | 176 | 1 | |
| Utiliteit | | Hansgrohe AXOR Starck | | | | | | | |
| | Classic 1-gats wastafelkraan 1-greeps m. waste | | | | | | | | |
| | 0452165 | | chrom | 10010000 | stuk | 356,00 | 176 | 0 | |
| | Classic 1-gats fonteinkraan 1-greeps m. waste | | | | | | | | |
| | 0452815 | | chrom | 10015000 | stuk | 336,00 | 176 | 1 | |
| | 1-gats wastafelkraan m. waste | | | | | | | | |
| | 0452070 | | chrom | 10111000 | stuk | 404,00 | 176 | 0 | |

| Art.nr | Specificaties | Kleur | Lev.nr | Ehd | Prijs | Grp | CC | | |
|---|---------------------------|-------|----------|------|--------|-----|----|---|---|
| | | | | | | | | Hansgrohe AXOR Starck | |
| 1-gats wastafelkraan z. waste 0452071 | | chrom | 10117000 | stuk | 404,00 | 176 | 1 |  | Sanitair producten |
| 1-gats wastafelkraan m. waste 0450153 | m. koperen aansluitpijpen | chrom | 10006000 | stuk | 404,00 | 176 | 1 |  | Baden / douchebakken / stoomcabines |
| fonteinkraan 0606855 | | chrom | 38130000 | stuk | 177,00 | 176 | 0 |  | Kranen |
| 1-gats fonteinkraan m. waste 0452074 | | chrom | 10116000 | stuk | 384,00 | 176 | 0 |  | Douchegarnituur |
| Classic 3-gats wastafelkraan m. waste 0452173 | | chrom | 10133000 | stuk | 528,00 | 176 | 1 |  | Accessoires en spiegels |
| Classic 1-gats wastafelkraan 1-greeps m. verhoogde voet 0452823 | m. waste | chrom | 10020000 | stuk | 541,00 | 176 | 1 |  | Douchewanden |
| 0452825 | z. waste | chrom | 10028000 | stuk | 541,00 | 176 | 1 | | Toebehoren & afvoeren |
| 1-gats wastafelkraan verhoogd m. waste 0452083 | | chrom | 10120000 | stuk | 610,00 | 176 | 1 |  | Spoel- & installatiesystemen |
| 1-gats wastafelkraan verhoogd z. waste 0452081 | | chrom | 10129000 | stuk | 610,00 | 176 | 1 |  | Badkamermeubelen en toiletkasten |
| 1-gats wastafelkraan 2-greeps m. waste m. vaste uitloop 0453439 | | chrom | 10030000 | stuk | 458,00 | 176 | 0 |  | Gootstenen en wastroggen |
| | | | | | | | | | Utiliteit |

| | Art.nr | Specificaties | Kleur | Lev.nr | Ehd | Prijs | Grp | CC |
|---|--|--------------------------------------|-------|----------|------|--------|-----|----|
| Sanitair producten | Hansgrohe AXOR Starck | | | | | | | |
| | 1-gats wastafelkraan 2-greeps m. verhoogde voet | | | | | | | |
| | 0454443 | m. waste | chrom | 10050000 | stuk | 622,00 | 176 | 1 |
| | 0454453 | z. waste | chrom | 10058000 | stuk | 622,00 | 176 | 1 |
| Baden / douchebakken / stoomcabines | | | | | | | | |
| Kranen | 3-gats wastafelkraan 2-greeps m. waste | | | | | | | |
| | 0452089 | | chrom | 10135000 | stuk | 599,00 | 176 | 1 |
| Douchegarnituur | | | | | | | | |
| Accessoires en spiegels | kleurset voor 3-gats wandkraan | | | | | | | |
| | 0453460 | | chrom | 10313000 | stuk | 399,00 | 176 | 0 |
| | 0453450 | basisgarnituur voor 3-gats wandkraan | | 10303180 | stuk | 174,00 | 176 | 0 |
| Douchewanden | | | | | | | | |
| Toebehoren & afvoeren | Classic 1-gats bidetkraan 1-greeps m. waste | | | | | | | |
| | 0452831 | | chrom | 10200000 | stuk | 361,00 | 176 | 1 |
| Spoel- & installatiesystemen | 1-gats bidetkraan 2-greeps m. waste | | | | | | | |
| | 0453455 | | chrom | 10230000 | stuk | 458,00 | 176 | 1 |
| Badkamermeubelen en toiletkasten | | | | | | | | |
| Gootstenen en wastroggen | 1-gats bidetkraan m. waste | | | | | | | |
| | 0452075 | | chrom | 10211000 | stuk | 404,00 | 176 | 1 |
| Utiliteit | | | | | | | | |
| Gootstenen en wastroggen | douchekraan HOH=15cm | | | | | | | |
| | 0452079 | | chrom | 10611000 | stuk | 462,00 | 176 | 0 |
| Utiliteit | badkraan HOH=15cm | | | | | | | |
| | 0452077 | | chrom | 10411000 | stuk | 604,00 | 176 | 0 |
| Utiliteit | 2-greeps badkraan | | | | | | | |
| | 0450414 | | chrom | 10430000 | stuk | 652,00 | 176 | 1 |
| Utiliteit | 2-greeps badkraan m. slang m. handdouche | | | | | | | |
| | 0453463 | | chrom | 10450000 | stuk | 917,00 | 176 | 1 |

| Art.nr | Specificaties | Kleur | Lev.nr | Ehd | Prijs | Grp | CC | |
|---|--------------------------------------|--------|----------|------|---------|-----|----|---|
| Hansgrohe AXOR Starck | | | | | | | | |
| kleurset voor badkraan op zuil | | | | | | | | |
| 0452087 | | chroom | 10456000 | stuk | 1216,00 | 176 | 1 |  |
| 0453490 | basisgarnituur voor badkraan op zuil | | 10452180 | stuk | 348,00 | 176 | 1 | |
| verlengset voor baden m. brede rand | | | | | | | | |
| 0450157 | 20mm | chroom | 10983000 | stuk | 167,00 | 176 | 1 | |
| kleurset voor 2-greeps badkraan op zuil | | | | | | | | |
| 0453480 | | chroom | 10458000 | stuk | 1201,00 | 176 | 1 |  |
| 0453490 | basisgarnituur voor badkraan op zuil | | 10452180 | stuk | 348,00 | 176 | 1 | |
| basisgarnituur voor badkraan op zuil | | | | | | | | |
| 0453490 | | | 10452180 | stuk | 348,00 | 176 | 1 | |
| kleurset voor 3-gats badkraan 2-greeps | | | | | | | | |
| 0454508 | | chroom | 10423000 | stuk | 450,00 | 176 | 1 |  |
| 0454265 | basisgarnituur 3-gats badkraan | | 10422180 | stuk | 171,00 | 176 | 1 | |
| Classic kleurset voor inbouwbadkraan | | | | | | | | |
| 0459119 | | chroom | 10415000 | stuk | 228,00 | 176 | 1 |  |
| 0457051 | basisgarnituur I-box universeel | | 01800180 | stuk | 107,00 | 176 | 0 | |
| Classic kleurset voor inbouwbadkraan Exafill | | | | | | | | |
| 0450133 | | chroom | 10417000 | stuk | 337,00 | 176 | 1 |  |
| 0457051 | basisgarnituur I-box universeel | | 01800180 | stuk | 107,00 | 176 | 0 | |
| Puro kleurset voor inbouwbadkraan | | | | | | | | |
| 0450476 | | chroom | 10416000 | stuk | 228,00 | 176 | 1 |  |
| 0457051 | basisgarnituur I-box universeel | | 01800180 | stuk | 107,00 | 176 | 0 | |
| Puro kleurset voor inbouwbadkraan Exafill | | | | | | | | |
| 0450477 | | chroom | 10418000 | stuk | 337,00 | 176 | 1 |  |
| 0457051 | basisgarnituur I-box universeel | | 01800180 | stuk | 107,00 | 176 | 0 | |
| baduitloop 3/4" | | | | | | | | |
| 0462254 | | chroom | 10410000 | stuk | 137,00 | 176 | 1 |  |
| verlengset 50mm | | | | | | | | |
| 0453421 | | chroom | 10495000 | stuk | 70,00 | 176 | 1 | |

Sanitair producten

Baden /
douchebakken /
stoomcabines

Kranen







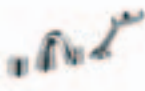

Douchegarnituur

Accessoires en
spiegels

Douchewanden

Toebehoren &
afvoerenSpoel- &
installatiesystemenBadkamermeubelen
en toiletkastenGootstenen en
wastroggen

Utiliteit

| | Art.nr | Specificaties | Kleur | Lev.nr | Ehd | Prijs | Grp | CC |
|---|---|--|-------|----------|------|---------|-----|----|
| | Hansgrohe AXOR Starck | | | | | | | |
| | kleurset 4-gats badrandkraan | | | | | | | |
| Sanitair producten | 0452416 | | chrom | 10444000 | stuk | 711,00 | 176 | 1 |
| | 0451495 | basisgarnituur 4-gats badrandkraan | | 13444180 | stuk | 614,00 | 176 | 0 |
| Baden / douchebakken / stoomcabines |  | | | | | | | |
| | kleurset 4-gats tegelrandkraan | | | | | | | |
| Kranen | 0455180 | | chrom | 10451000 | stuk | 980,00 | 176 | 1 |
| | 0454885 | basisgarnituur 4-gats tegelrandkraan | | 14445180 | stuk | 1055,00 | 176 | 1 |
| |  | | | | | | | |
| | kleurset 4-gats thermostaat-badrandkraan | | | | | | | |
| Douchegarnituur | 0455202 | | chrom | 10461000 | stuk | 861,00 | 176 | 1 |
| | 0454893 | basisgarnituur 4-gats thermostaat-badrandkraan | | 15460180 | stuk | 764,00 | 176 | 1 |
| |  | | | | | | | |
| Accessoires en spiegels | kleurset 4-gats thermostaat-tegelrandkraan | | | | | | | |
| Douchewanden | 0455229 | | chrom | 10466000 | stuk | 1125,00 | 176 | 1 |
| | 0454907 | basisgarnituur 4-gats thermostaat-tegelrandkraan | | 15465180 | stuk | 1204,00 | 176 | 1 |
| |  | | | | | | | |
| Toebehoren & afvoeren | 2-greeps douchekraan | | | | | | | |
| Spoel- & installatiesystemen | 0450420 | | chrom | 10630000 | stuk | 455,00 | 176 | 1 |
| | | | | | | | | |
| |  | | | | | | | |
| | kleurset voor inbouwdouchekraan | | | | | | | |
| Badkamermeubelen en toiletkasten | 0459135 | | chrom | 10615000 | stuk | 202,00 | 176 | 1 |
| | 0457051 | basisgarnituur I-box universeel | | 01800180 | stuk | 107,00 | 176 | 0 |
| |  | | | | | | | |
| Gootstenen en wastroggen | Puro kleurset voor inbouwdouchekraan | | | | | | | |
| Utiliteit | 0450422 | | chrom | 10616000 | stuk | 237,00 | 176 | 1 |
| | 0457051 | basisgarnituur I-box universeel | | 01800180 | stuk | 107,00 | 176 | 0 |
| |  | | | | | | | |
| | kleurset voor douchezuil | | | | | | | |
| | 0605125 | | chrom | 10905000 | stuk | 1963,00 | 176 | 1 |
| | 0606294 | basisgarnituur voor douchezuil | | 10902180 | stuk | 264,00 | 176 | 0 |
| |  | | | | | | | |
| | kleurset voor douchezuil thermostaat | | | | | | | |
| | 0606308 | | chrom | 10910000 | stuk | 2401,00 | 176 | 1 |
| | 0606294 | basisgarnituur voor douchezuil | | 10902180 | stuk | 264,00 | 176 | 0 |
| |  | | | | | | | |
| | planchet rond 39cm | | | | | | | |
| | 0450426 | | chrom | 10915000 | stuk | 70,50 | 176 | 1 |

| Art.nr | Specificaties | Kleur | Lev.nr | Ehd | Prijs | Grp | CC |
|--------|---------------|-------|--------|-----|-------|-----|----|
|--------|---------------|-------|--------|-----|-------|-----|----|

Hansgrohe AXOR Starck

kleurset voor douchezuil m. Raindance hoofddouche

| | | | | | | | |
|---------|--------------------------------|--------|----------|------|---------|-----|---|
| 0450428 | | chroom | 10907000 | stuk | 1963,00 | 176 | 1 |
| 0606294 | basisgarnituur voor douchezuil | | 10902180 | stuk | 264,00 | 176 | 0 |



Sanitair producten

Baden /
douchebakken /
stoomcabines**kleurset voor douchezuil thermostaat m. Raindance hoofddouche**

| | | | | | | | |
|---------|--------------------------------|--------|----------|------|---------|-----|---|
| 0450430 | | chroom | 10912000 | stuk | 2401,00 | 176 | 1 |
| 0606294 | basisgarnituur voor douchezuil | | 10902180 | stuk | 264,00 | 176 | 0 |



Kranen

Douchegarnituur

kleurset voor douchethermostaat 2-greeps

| | | | | | | | |
|---------|--------------------------------|--------|----------|------|--------|-----|---|
| 0459771 | | chroom | 10360000 | stuk | 496,00 | 176 | 1 |
| 0606294 | basisgarnituur voor douchezuil | | 10902180 | stuk | 264,00 | 176 | 0 |

Accessoires en
spiegels**kleurset voor badthermostaat 2-greeps**

| | | | | | | | |
|---------|--------------------------------|--------|----------|------|--------|-----|---|
| 0459763 | | chroom | 10340000 | stuk | 652,00 | 176 | 1 |
| 0606294 | basisgarnituur voor douchezuil | | 10902180 | stuk | 264,00 | 176 | 0 |



Douchewanden

Toebehoren &
afvoeren**kleurset voor inbouw thermostaatkraan m. stopkraan**

| | | | | | | | |
|---------|---------------------------------|--------|----------|------|--------|-----|---|
| 0459186 | | chroom | 10700000 | stuk | 538,00 | 176 | 0 |
| 0457051 | basisgarnituur I-box universeel | | 01800180 | stuk | 107,00 | 176 | 0 |

Spoel- &
installatiesystemenBadkamermeubelen
en toiletkasten**kleurset voor inbouw thermostaatkraan**

| | | | | | | | |
|---------|---------------------------------|--------|----------|------|--------|-----|---|
| 0459151 | | chroom | 10710000 | stuk | 441,00 | 176 | 1 |
| 0457051 | basisgarnituur I-box universeel | | 01800180 | stuk | 107,00 | 176 | 0 |

Gootstenen en
wastroggen**kleurset voor inbouw thermostaatkraan m. stopkraan m. omstel**

| | | | | | | | |
|---------|---------------------------------|--------|----------|------|--------|-----|---|
| 0459208 | | chroom | 10720000 | stuk | 617,00 | 176 | 0 |
| 0457051 | basisgarnituur I-box universeel | | 01800180 | stuk | 107,00 | 176 | 0 |



Utiliteit

kleurset voor inbouwthermostaat Highflow

| | | | | | | | |
|---------|---------------------------------|--------|----------|------|--------|-----|---|
| 0450168 | voor Raindance Royal | chroom | 10715000 | stuk | 508,00 | 176 | 1 |
| 0457051 | basisgarnituur I-box universeel | | 01800180 | stuk | 107,00 | 176 | 0 |

kleurset voor voor inbouw Quattro 4weg omstelkraan / Trio stop- en omstelkraan

| | | | | | | | |
|---------|---|--------|----------|------|--------|-----|---|
| 0459224 | | chroom | 10930000 | stuk | 127,00 | 176 | 1 |
| 0450403 | basisgarnituur Trio inbouw stop- en omstelkraan | | 15981180 | stuk | 118,00 | 176 | 0 |
| 0457698 | basisgarnituur Quattro inbouw 4wegs omstelkraan | | 15930180 | stuk | 192,00 | 176 | 1 |
| 0457701 | verlengset 25mm | | 96370000 | stuk | 38,75 | 176 | 1 |



| | Art.nr | Specificaties | Kleur | Lev.nr | Ehd | Prijs | Grp | CC | |
|---|---|--------------------------------------|---|----------|----------|--------|---------|-----|---|
| Sanitair producten | Hansgrohe AXOR Starck | | | | | | | | |
| | kleurset voor stopkraan | | | | | | | | |
| | | 0459240 | | chrom | 10970000 | stuk | 127,00 | 176 | 1 |
| | | 0457701 | verlengset 25mm | | 96370000 | stuk | 38,75 | 176 | 1 |
| | | 0457736 | basisgarnituur stopkraan m. spindel DN15 | | 15973180 | stuk | 61,50 | 176 | 0 |
| | | 0457744 | basisgarnituur stopkraan m. keramische delen DN15 | | 15974180 | stuk | 64,00 | 176 | 0 |
| Baden / douchebakken / stoomcabines | | 0457752 | basisgarnituur stopkraan m. spindel DN20 | | 15970180 | stuk | 67,00 | 176 | 1 |
| | <hr/> | | | | | | | | |
| Kranen | verlengset 28mm voor kraan op zuil | | | | | | | | |
| | | 0467770 | | 10980000 | stuk | 187,00 | 176 | 1 | |
| <hr/> | | | | | | | | | |
| Douchegarnituur | Hansgrohe AXOR Starck X | | | | | | | | |
| | wastafelkraan m. waste | | | | | | | | |
| | 0450316 | | chrom | 10070000 | stuk | 452,00 | 176 | 1 | |
| <hr/> | | | | | | | | | |
| Accessoires en spiegels | highriser wastafelkraan z. waste | | | | | | | | |
| | | 0450367 | 18.7cm | chrom | 10071000 | stuk | 542,00 | 176 | 0 |
| | | 0450368 | 27.7cm | chrom | 10080000 | stuk | 633,00 | 176 | 1 |
| | | 0450369 | 52.7cm | chrom | 10084000 | stuk | 753,00 | 176 | 1 |
| Douchewanden | <hr/> | | | | | | | | |
| | wandkraan | | | | | | | | |
| | 0450318 | | chrom | 10074000 | stuk | 699,00 | 176 | 1 | |
| <hr/> | | | | | | | | | |
| Toebehoren & afvoeren | bidetkraan m. waste | | | | | | | | |
| | | 0450303 | | chrom | 10205000 | stuk | 452,00 | 176 | 1 |
| <hr/> | | | | | | | | | |
| Badkamermeubelen en toiletkasten | badkraan m. omstel | | | | | | | | |
| | | 0450304 | | chrom | 10402000 | stuk | 844,00 | 176 | 1 |
| <hr/> | | | | | | | | | |
| Gootstenen en wastroggen | badkraan staand voor montage naast het bad | | | | | | | | |
| | | 0450317 | | chrom | 10406000 | stuk | 1686,00 | 176 | 1 |
| | 0453490 | basisgarnituur voor badkraan op zuil | | 10452180 | stuk | 348,00 | 176 | 1 | |
| <hr/> | | | | | | | | | |
| Utiliteit | kleurset voor inbouwbadkraan m. omstel | | | | | | | | |
| | | 0450305 | | chrom | 10445000 | stuk | 301,00 | 176 | 1 |
| | | 0450321 | m. zekerheidscombinatie | chrom | 10447000 | stuk | 392,00 | 176 | 1 |
| | | 0457051 | basisgarnituur I-box universeel | | 01800180 | stuk | 107,00 | 176 | 0 |
| | | 0457647 | verlengset Ibox 25mm | | 13595000 | stuk | 33,50 | 176 | 1 |

| Art.nr | Specificaties | Kleur | Lev.nr | Ehd | Prijs | Grp | CC |
|--------|---------------|-------|--------|-----|-------|-----|----|
|--------|---------------|-------|--------|-----|-------|-----|----|

Hansgrohe AXOR Starck X

baduitloop 3/4"

| | | | | | | | |
|---------|--|-------|----------|------|--------|-----|---|
| 0450302 | | chrom | 10426000 | stuk | 295,00 | 176 | 1 |
|---------|--|-------|----------|------|--------|-----|---|



Sanitair producten

Baden /
douchebakken /
stoomcabines**kleurset voor inbouwdouchekraan**

| | | | | | | | |
|---------|--------------------------------|-------|----------|------|--------|-----|---|
| 0450320 | | chrom | 10645000 | stuk | 271,00 | 176 | 1 |
| 0457051 | basigarnituur l-box universeel | | 01800180 | stuk | 107,00 | 176 | 0 |
| 0457647 | verlengset lbox 25mm | | 13595000 | stuk | 33,50 | 176 | 1 |



Kranen

Douchegarnituur

waterwall douchepaneel compleet

| | | | | | | | |
|---------|--|-------|----------|------|---------|-----|---|
| 0450300 | | chrom | 10920000 | stuk | 2770,00 | 176 | 1 |
|---------|--|-------|----------|------|---------|-----|---|

Accessoires en
spiegels

Douchewanden

kleurset voor inbouwthermostaat

| | | | | | | | |
|---------|--------------------------------|-------|----------|------|--------|-----|---|
| 0450301 | | chrom | 10716000 | stuk | 446,00 | 176 | 1 |
| 0457051 | basigarnituur l-box universeel | | 01800180 | stuk | 107,00 | 176 | 0 |
| 0457647 | verlengset lbox 25mm | | 13595000 | stuk | 33,50 | 176 | 1 |

Toebehoren &
afvoeren**kleurset voor inbouwthermostaat voor hoger waterverbruik**

| | | | | | | | |
|---------|--------------------------------|-------|----------|------|--------|-----|---|
| 0450324 | | chrom | 10717000 | stuk | 518,00 | 176 | 1 |
| 0457051 | basigarnituur l-box universeel | | 01800180 | stuk | 107,00 | 176 | 0 |
| 0457647 | verlengset lbox 25mm | | 13595000 | stuk | 33,50 | 176 | 1 |

Spoel- &
installatiesystemen**kleurset voor inbouwthermostaat m. stopkraan**

| | | | | | | | |
|---------|--------------------------------|-------|----------|------|--------|-----|---|
| 0450322 | | chrom | 10706000 | stuk | 542,00 | 176 | 1 |
| 0457051 | basigarnituur l-box universeel | | 01800180 | stuk | 107,00 | 176 | 0 |
| 0457647 | verlengset lbox 25mm | | 13595000 | stuk | 33,50 | 176 | 1 |

Badkamermeubelen
en toiletkastenGootstenen en
wastroggen**kleurset voor inbouwthermostaat m. stopkraan m. omstel**

| | | | | | | | |
|---------|--------------------------------|-------|----------|------|--------|-----|---|
| 0450323 | | chrom | 10726000 | stuk | 615,00 | 176 | 0 |
| 0457051 | basigarnituur l-box universeel | | 01800180 | stuk | 107,00 | 176 | 0 |
| 0457647 | verlengset lbox 25mm | | 13595000 | stuk | 33,50 | 176 | 1 |



Utiliteit

Hansgrohe AXOR Steel





1-gats wastafelkraan











| | | | | | | | |
|---------|----------|-----|----------|------|--------|-----|---|
| 0466611 | m. waste | RVS | 35002800 | stuk | 417,00 | 176 | 0 |
| 0466646 | z. waste | RVS | 35028800 | stuk | 417,00 | 176 | 0 |
| 0466638 | m. pijp | RVS | 35014800 | stuk | 417,00 | 176 | 1 |









**3-gats wastafelkraan m. waste**





| | | | | | | | |
|---------|--|-----|----------|------|--------|-----|---|
| 0450450 | | RVS | 35033800 | stuk | 642,00 | 176 | 1 |
|---------|--|-----|----------|------|--------|-----|---|











| | Art.nr | Specificaties | Kleur | Lev.nr | Ehd | Prijs | Grp | CC |
|---|---|---|------------|----------------------------------|----------------------|----------------------------|-------------------|-------------|
| | Hansgrohe AXOR Steel | | | | | | | |
| Sanitair producten |  | electronische wastafelkraan z. temperatuur instelling 0452942 | RVS | 15101800 | stuk | 703,00 | 373 | 1 |
| Baden / douchebakken / stoomcabines |  | electronische wastafelkraan m. temperatuur instelling 0452940 | RVS | 15100800 | stuk | 756,00 | 373 | 1 |
| Kranen | | | | | | | | |
| Douchegarnituur |  | kleurset inbouwwastafelkraan m. plaat 0450451 16cm 0450453 22cm 0450034 basisgarnituur voor inbouwwastafelkraan | RVS RVS | 35112800 35115800 38111180 | stuk stuk stuk | 519,00 537,00 206,00 | 176 176 176 | 1 1 0 |
| Accessoires en spiegels | | | | | | | | |
| Douchewanden |  | kleurset inbouwwastafelkraan m. rozet 0450452 16cm 0450454 22cm 0450034 basisgarnituur voor inbouwwastafelkraan | RVS RVS | 35113800 35116800 38111180 | stuk stuk stuk | 432,00 451,00 206,00 | 176 176 176 | 1 1 0 |
| Toebehoren & afvoeren |  | fonteinkraan 0459313 | RVS | 13130800 | stuk | 187,00 | 176 | 0 |
| Spoel- & installatiesystemen | | | | | | | | |
| Badkamermeubelen en toiletkasten |  | bidetkraan 0466654 | RVS | 35202800 | stuk | 417,00 | 176 | 1 |
| Gootstenen en wastroggen | | | | | | | | |
| Utiliteit |  | 1-greeps badkraan 0466662 | RVS | 35402800 | stuk | 561,00 | 176 | 1 |
| |  | kleurset voor inbouwbadkraan 0466670 0466689 Exafill 0457051 basisgarnituur I-box universeel | RVS RVS | 35425800 35427800 01800180 | stuk stuk stuk | 286,00 390,00 107,00 | 176 176 176 | 1 1 0 |
| |  | | | | | | | |







| Art.nr | Specificaties | Kleur | Lev.nr | Ehd | Prijs | Grp | CC | | |
|---|---|-------|----------|------|---------|-----|----|---|---|
| | | | | | | | | Hansgrohe AXOR Steel | |
| baduitloop 3/4" 0466697 | | RVS | 35412800 | stuk | 169,00 | 176 | 1 |  | Sanitair producten |
| 1-greeps douchekraan 0466700 | | RVS | 35602800 | stuk | 443,00 | 176 | 1 |  | Baden / douchebakken / stoomcabines |
| kleurset voor inbouwdouchekraan 0466719 | | RVS | 35625800 | stuk | 240,00 | 176 | 1 |  | Douchegarnituur |
| 0457051 | basisgarnituur I-box universeel | | 01800180 | stuk | 107,00 | 176 | 0 | | |
| kleurset 2-gats badrandthermostaat 0450455 | | RVS | 35480800 | stuk | 260,00 | 176 | 1 |  | Douchewanden |
| 0458716 | basisgarnituur voor 2-gats badrandthermostaat | | 13550180 | stuk | 585,00 | 176 | 0 | | |
| kleurset 4-gats badrandkraan 0450456 | | RVS | 35444800 | stuk | 1037,00 | 176 | 1 |  | Toebehoren & afvoeren |
| 0451495 | basisgarnituur 4-gats badrandkraan | | 13444180 | stuk | 614,00 | 176 | 0 | | |
| kleurset 4-gats tegelrandkraan 0450457 | | RVS | 35454800 | stuk | 1358,00 | 176 | 1 |  | Badkamermeubelen en toiletkasten |
| 0459429 | kleurset voor inbouwthermostaat | RVS | 35710800 | stuk | 440,00 | 176 | 1 | | |
| kleurset voor inbouwthermostaat 0459429 | | RVS | 35710800 | stuk | 440,00 | 176 | 1 |  | Gootstenen en wastroggen |
| 0457051 | basisgarnituur I-box universeel | | 01800180 | stuk | 107,00 | 176 | 0 | | |
| kleurset voor inbouw thermostaatkraan m. stopkraan 0459275 | | RVS | 35700800 | stuk | 537,00 | 176 | 1 |  | Utiliteit |
| 0457051 | basisgarnituur I-box universeel | | 01800180 | stuk | 107,00 | 176 | 0 | | |
| kleurset voor inbouw thermostaatkraan m. stopkraan m. omstel 0459283 | | RVS | 35720800 | stuk | 616,00 | 176 | 0 |  | |
| 0457051 | basisgarnituur I-box universeel | | 01800180 | stuk | 107,00 | 176 | 0 | | |
| kleurset voor inbouwthermostaat Highflow voor Raindance Royal 0450170 | | RVS | 35715800 | stuk | 494,00 | 176 | 1 |  | |
| 0457051 | basisgarnituur I-box universeel | | 01800180 | stuk | 107,00 | 176 | 0 | | |



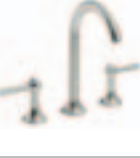



| | Art.nr | Specificaties | Kleur | Lev.nr | Ehd | Prijs | Grp | CC |
|---|---|---------------|---|--------|----------|-------|--------|-------|
| Sanitair producten | Hansgrohe AXOR Steel | | | | | | | |
| | kleurset voor Quattro kraan | | | | | | | |
| | | 0459291 | | RVS | 35930800 | stuk | 150,00 | 176 1 |
| |  | 0450403 | basisgarnituur Trio inbouw stop- en omstelkraan | | 15981180 | stuk | 118,00 | 176 0 |
| | | 0457698 | basisgarnituur Quatro inbouw 4wegs omstelkraan | | 15930180 | stuk | 192,00 | 176 1 |
| Baden / douchebakken / stoomcabines | | 0457701 | verlengset 25mm | | 96370000 | stuk | 38,75 | 176 1 |
| | kleurset voor stopkraan | | | | | | | |
| Kranen | | 0459305 | | RVS | 35970800 | stuk | 81,00 | 176 1 |
| |  | 0457701 | verlengset 25mm | | 96370000 | stuk | 38,75 | 176 1 |
| | | 0457736 | basisgarnituur stopkraan m. spindel DN15 | | 15973180 | stuk | 61,50 | 176 0 |
| | | 0457744 | basisgarnituur stopkraan m. keramische delen DN15 | | 15974180 | stuk | 64,00 | 176 0 |
| | | 0457752 | basisgarnituur stopkraan m. spindel DN20 | | 15970180 | stuk | 67,00 | 176 1 |
| Douchegarnituur | Hansgrohe Talis Elegance | | | | | | | |
| Accessoires en spiegels | wastafelkraan 1-greeps m. waste | | | | | | | |
| |  | 0452920 | | chrom | 33001000 | stuk | 136,00 | 176 0 |
| Douchewanden | wastafelkraan 1-greeps | | | | | | | |
| |  | 0457779 | | chrom | 33014000 | stuk | 170,00 | 176 1 |
| Toebehoren & afvoeren | 1-gats wastafelkraan z. waste | | | | | | | |
| |  | 0452922 | | chrom | 33011000 | stuk | 136,00 | 176 1 |
| Spoel- & installatiesystemen | wastafelkraan m. start/stop knop z. temperatuurregeling | | | | | | | |
| |  | 0452926 | | chrom | 15097000 | stuk | 298,00 | 176 1 |
| Badkamermeubelen en toiletkasten | wastafelkraan m. start/stop knop m. temperatuurregeling | | | | | | | |
| |  | 0452924 | | chrom | 15090000 | stuk | 367,00 | 176 1 |
| Gootstenen en wastroggen | bidetkraan 1-greeps m. waste | | | | | | | |
| |  | 0452939 | | chrom | 33200000 | stuk | 136,00 | 176 1 |
| Utiliteit | douchekraan 1-greeps HOH=15cm m. koppelingen z. omstel | | | | | | | |
| |  | 0452998 | | chrom | 33600000 | stuk | 138,00 | 176 1 |

| Art.nr | Specificaties | Kleur | Lev.nr | Ehd | Prijs | Grp | CC | | |
|---|-------------------------|-------|----------|------|--------|-----|----|---|---|
| | | | | | | | | Hansgrohe Talis Elegance | |
| badkraan 1-greeps m. koppelingen m. omstel 0452947 | | chrom | 33400000 | stuk | 173,00 | 176 | 1 |  | Sanitair producten |
| badkraan m. handdouche 0452944 | | chrom | 33402000 | stuk | 220,00 | 176 | 1 |  | Baden / douchebakken / stoomcabines |
| badkraan staand Monotrou 0450241 | | chrom | 33140000 | stuk | 194,00 | 176 | 1 | | Douchegarnituur |
| kleurset voor inbouw douchekraan 0458953 | | chrom | 33655000 | stuk | 123,00 | 176 | 1 |  | Accessoires en spiegels |
| 0457051 basisgarnituur l-box universeel | | | 01800180 | stuk | 107,00 | 176 | 0 | | |
| kleurset voor inbouw badkraan 0458945 | | chrom | 33455000 | stuk | 133,00 | 176 | 1 |  | Douchewanden |
| 0457051 basisgarnituur l-box universeel | | | 01800180 | stuk | 107,00 | 176 | 0 | | |
| kleurset voor inbouwbadkraan 0450248 | m. zekerheidscombinatie | chrom | 33457000 | stuk | 223,00 | 176 | 1 | | Toebehoren & afvoeren |
| 0457051 basisgarnituur l-box universeel | | | 01800180 | stuk | 107,00 | 176 | 0 | | |
| kleurset voor inbouwbadkraan 0450248 | m. zekerheidscombinatie | chrom | 33457000 | stuk | 223,00 | 176 | 1 | | Spoel- & installatiesystemen |
| 0457051 basisgarnituur l-box universeel | | | 01800180 | stuk | 107,00 | 176 | 0 | | |
| | | | | | | | | Hansgrohe Talis E2 | |
| 1-gats wastafelkraan m. waste 0450520 | | chrom | 31612000 | stuk | 121,00 | 176 | 1 | | Badkamermeubelen en toiletkasten |
| 1-gats wastafelkraan z. waste 0450521 | | chrom | 31614000 | stuk | 121,00 | 176 | 1 | | Gootstenen en wastroggen |
| 1-gats bidetkraan m. waste 0450522 | | chrom | 31622000 | stuk | 121,00 | 176 | 1 | | Utiliteit |
| badkraan m. omstel 0450523 | | chrom | 31642000 | stuk | 154,00 | 176 | 1 | | |
| afbouwset voor inbouwbadkraan 0450524 | | chrom | 31645000 | stuk | 117,00 | 176 | 1 | | |
| 0450525 | m. zekerheidscombinatie | chrom | 31646000 | stuk | 208,00 | 176 | 1 | | |
| douchekraan z. omstel 0450527 | | chrom | 31662000 | stuk | 121,00 | 176 | 1 | | |
| afbouwset voor inbouwdouchekraan 0450528 | | chrom | 31666000 | stuk | 109,00 | 176 | 1 | | |
| | | | | | | | | Hansgrohe Talis S | |
| 1-gats wastafelkraan m. waste 0459459 | m. aansluitslangen 10mm | chrom | 32020000 | stuk | 150,00 | 176 | 0 |  | |
| 0450509 | m. aansluitslangen 3/8" | chrom | 32022000 | stuk | 150,00 | 176 | 1 | | |
| 1-greeps wastafelkraan m. hoge uitloop m. waste 0452105 | | chrom | 32070000 | stuk | 212,00 | 176 | 0 | | |

| | Art.nr | Specificaties | Kleur | Lev.nr | Ehd | Prijs | Grp | CC |
|---|---|--|-------|----------|------|--------|-----|----|
| | Hansgrohe Talis S | | | | | | | |
| Sanitair producten | | 1-gats wastafelkraan z. waste | | | | | | |
| | 0469496 | | chrom | 32031000 | stuk | 150,00 | 176 | 0 |
| |  | | | | | | | |
| Baden / douchebakken / stoomcabines | | 1-gats wastafelkraan care m. waste | | | | | | |
| | 0459518 | | chrom | 32034000 | stuk | 173,00 | 176 | 1 |
| Kranen | | 1-gats bidetkraan m. waste | | | | | | |
| | 0459526 | | chrom | 32220000 | stuk | 187,00 | 176 | 1 |
| |  | | | | | | | |
| Douchegarnituur | | badkraan m. omstel z. garnituur m. S-koppelingen | | | | | | |
| | 0459534 | | chrom | 32420000 | stuk | 190,00 | 176 | 0 |
| |  | | | | | | | |
| Accessoires en spiegels | | badkraan handdouche m. slang m. wandhouder m. S-koppelingen | | | | | | |
| | 0459542 | | chrom | 27044000 | stuk | 242,00 | 176 | 1 |
| |  | | | | | | | |
| Douchewanden | | douchekraan z. omstel m. S-koppelingen | | | | | | |
| | 0459577 | | chrom | 32620000 | stuk | 152,00 | 176 | 0 |
| |  | | | | | | | |
| Toebehoren & afvoeren | | afbouwset voor inbouwbadkraan | | | | | | |
| | 0459550 | | chrom | 32475000 | stuk | 133,00 | 176 | 1 |
| | 0457051 | basisgarnituur I-box universeel | | 01800180 | stuk | 107,00 | 176 | 0 |
| |  | | | | | | | |
| Spoel- & installatiesystemen | | afbouwset voor inbouwbadkraan m. zekerheidscombinatie | | | | | | |
| | 0454287 | | chrom | 32477000 | stuk | 223,00 | 176 | 1 |
| | 0457051 | basisgarnituur I-box universeel | | 01800180 | stuk | 107,00 | 176 | 0 |
| Badkamermeubelen en toiletkasten | | afbouwset voor inbouwdouchekraan | | | | | | |
| | 0459585 | | chrom | 32675000 | stuk | 124,00 | 176 | 1 |
| | 0457051 | basisgarnituur I-box universeel | | 01800180 | stuk | 107,00 | 176 | 0 |
| |  | | | | | | | |
| Gootstenen en wastroggen | | Hansgrohe Talis S2 | | | | | | |
| | | 1-gats fonteinkraan | | | | | | |
| | 0450562 | | chrom | 13132000 | stuk | 91,00 | 176 | 1 |
| |  | | | | | | | |
| | | 1-gats wastafelkraan m. waste | | | | | | |
| | 0450529 | m. aansluitslangen 10mm | chrom | 32040000 | stuk | 151,00 | 176 | 1 |
| | 0450530 | m. aansluitslangen 3/8" | chrom | 32043000 | stuk | 151,00 | 176 | 1 |
| |  | | | | | | | |
| | | 1-gats wastafelkraan z. waste | | | | | | |
| | 0450531 | | chrom | 32041000 | stuk | 144,00 | 176 | 1 |
| |  | | | | | | | |
| | | 1-gats wastafelkraan m. ketting | | | | | | |
| | 0450532 | | chrom | 32048000 | stuk | 141,00 | 176 | 1 |

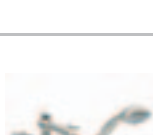
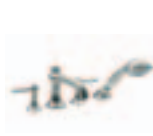
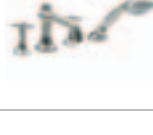
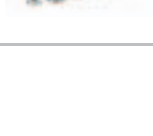
| Art.nr | Specificaties | Kleur | Lev.nr | Ehd | Prijs | Grp | CC | |
|---|---------------|---------|----------|------|--------|-----|----|---|
| Hansgrohe Talis S2 | | | | | | | | |
| 1-gats bidetkraan m. waste 0450533 | | chroom | 32240000 | stuk | 151,00 | 176 | 1 | Sanitair producten |
| badkraan m. omstel z. garnituur m. S-koppelingen 0450534 | | chroom | 32440000 | stuk | 191,00 | 176 | 1 | Baden / douchebakken / stoomcabines |
| douchekraan z. omstel m. S-koppelingen 0450535 | | chroom | 32640000 | stuk | 151,00 | 176 | 1 | |
| baduitloop 3/4" 0452662 | | chroom | 13414000 | stuk | 71,00 | 176 | 1 | Kranen |
| Hansgrohe AXOR Terrano | | | | | | | | |
| fonteinkraan m. waste m. rechte greep 0454206 | | chroom | 37015000 | stuk | 314,00 | 176 | 1 | Douchegarnituur |
| 0455873 | | satinox | 37015810 | stuk | 411,00 | 176 | 1 | |
| fonteinkraan m. waste m. kruisgrepen 0457493 | | chroom | 37035000 | stuk | 360,00 | 176 | 1 | Accessoires en spiegels |
| 0457507 | | satinox | 37035810 | stuk | 468,00 | 176 | 1 | |
| toiletkraan m. kruisgreep 0457566 | | chroom | 37130000 | stuk | 174,00 | 176 | 1 | Douchewanden |
| 0457574 | | satinox | 37130810 | stuk | 226,00 | 176 | 1 | |
| 1-gats wastafelkraan m. waste m. rechte greep 0454176 | | chroom | 37001000 | stuk | 322,00 | 176 | 1 | Toebehoren & afvoeren |
| 0450014 | | satinox | 37001810 | stuk | 419,00 | 176 | 1 | |
| 1-gats wastafelkraan m. waste m. kruisgrepen 0457477 | | chroom | 37030000 | stuk | 360,00 | 176 | 0 | Spoel- & installatiesystemen |
| 0457485 | | satinox | 37030810 | stuk | 468,00 | 176 | 1 | |
| 1-gats wastafelkraan m. verhoogde voet z. waste m. rechte greep 0454102 | | chroom | 37028000 | stuk | 538,00 | 176 | 1 | Badkamermeubelen en toiletkasten |
| 0454104 | | satinox | 37028810 | stuk | 658,00 | 176 | 1 | |
| 3-gats wastafelkraan m. waste m. kruisgrepen 0454184 | | chroom | 37133000 | stuk | 522,00 | 176 | 1 | Gootstenen en wastroggen |
| 0455881 | | satinox | 37133810 | stuk | 680,00 | 176 | 1 | |
| 3-gats wastafelkraan m. waste m. rechte greep 0454192 | | chroom | 37135000 | stuk | 522,00 | 176 | 1 | Utiliteit |
| 0455903 | | satinox | 37135810 | stuk | 680,00 | 176 | 1 | |

| | Art.nr | Specificaties | Kleur | Lev.nr | Ehd | Prijs | Grp | CC |
|---|---|--|---------|----------|------|---------|-----|----|
| Hansgrohe AXOR Terrano | | | | | | | | |
| Sanitair producten | 3-gats wastafelkraan m. waste m. kruisgrepen m. hoge uitloop | | | | | | | |
| | 0457515 | | chroom | 37134000 | stuk | 520,00 | 176 | 1 |
| | 0457523 | | satinox | 37134810 | stuk | 676,00 | 176 | 1 |
| Baden / douchebakken / stoomcabines |  | | | | | | | |
| Kranen | 3-gats wastafelkraan m. waste m. rechte greep m. hoge uitloop | | | | | | | |
| | 0457531 | | chroom | 37136000 | stuk | 520,00 | 176 | 1 |
| | 0457558 | | satinox | 37136810 | stuk | 676,00 | 176 | 1 |
| Douchegarnituur |  | | | | | | | |
| Accessoires en spiegels | 3-gats wandkraan m. kruisgrepen | | | | | | | |
| | 0454214 | | chroom | 37313000 | stuk | 372,00 | 176 | 1 |
| | 0450104 | montageset voor wastafels m. achterwand V&B Soho | | 96142000 | stuk | 212,00 | 176 | 1 |
| | 0453450 | basisgarnituur voor 3-gats wandkraan | | 10303180 | stuk | 174,00 | 176 | 0 |
| Douchewanden | 3-gats wandkraan m. rechte greep | | | | | | | |
| | 0454222 | | chroom | 37315000 | stuk | 372,00 | 176 | 1 |
| | 0455938 | | satinox | 37315810 | stuk | 486,00 | 176 | 1 |
| | 0450104 | montageset voor wastafels m. achterwand V&B Soho | | 96142000 | stuk | 212,00 | 176 | 1 |
| | 0453450 | basisgarnituur voor 3-gats wandkraan | | 10303180 | stuk | 174,00 | 176 | 0 |
| Toebehoren & afvoeren | montageset voor wastafels m. achterwand V&B Soho | | | | | | | |
| | 0450104 | | | 96142000 | stuk | 212,00 | 176 | 1 |
| Spoel- & installatiesystemen | bidetkraan m. waste m. rechte greep | | | | | | | |
| | 0454370 | | chroom | 37200000 | stuk | 322,00 | 176 | 1 |
| | 0455946 | | satinox | 37200810 | stuk | 419,00 | 176 | 1 |
| Badkamermeubelen en toiletkasten |  | | | | | | | |
| Gootstenen en wastroggen | bidetkraan m. waste m. kruisgrepen | | | | | | | |
| | 0457582 | | chroom | 37230000 | stuk | 360,00 | 176 | 1 |
| | 0457590 | | satinox | 37230810 | stuk | 468,00 | 176 | 1 |
| Utiliteit |  | | | | | | | |
| | douchekraan m. koppelingen z. omstel m. rechte greep | | | | | | | |
| | 0454303 | | chroom | 37600000 | stuk | 372,00 | 176 | 1 |
| | 0456020 | | satinox | 37600810 | stuk | 486,00 | 176 | 1 |
| |  | | | | | | | |
| | douchekraan m. koppelingen z. omstel m. kruisgrepen | | | | | | | |
| | 0457620 | | chroom | 37632000 | stuk | 340,00 | 176 | 1 |
| | 0457639 | | satinox | 37632810 | stuk | 442,00 | 176 | 1 |
| |  | | | | | | | |
| | showerpipeset compleet | | | | | | | |
| | 0458526 | | chroom | 37670000 | stuk | 1721,00 | 250 | 1 |
| | 0458530 | | satinox | 37670810 | stuk | 2236,00 | 250 | 1 |
| |  | | | | | | | |

| Art.nr | Specificaties | Kleur | Lev.nr | Ehd | Prijs | Grp | CC | |
|--|--|---------|----------|------|---------|-----|----|---|
| Hansgrohe AXOR Terrano | | | | | | | | |
| badkraan m. koppelingen m. omstel m. rechte greep | | | | | | | | |
| 0454230 | | chroom | 37400000 | stuk | 447,00 | 176 | 1 |  |
| 0455970 | | satinox | 37400810 | stuk | 581,00 | 176 | 1 | |
| badkraan m. koppelingen m. omstel m. kruisgrepen | | | | | | | | |
| 0454257 | | chroom | 37423000 | stuk | 427,00 | 176 | 1 |  |
| 0457612 | | satinox | 37432810 | stuk | 555,00 | 176 | 1 | |
| kleurset voor inbouwbadkraan m. rechte greep | | | | | | | | |
| 0454273 | | chroom. | 37425000 | stuk | 486,00 | 176 | 1 |  |
| 0456004 | | satinox | 37425810 | stuk | 631,00 | 176 | 1 | |
| 0454265 | basisgarnituur 3-gats badkraan | | 10422180 | stuk | 171,00 | 176 | 1 | |
| kleurset voor inbouwbadkraan m. kruisgrepen | | | | | | | | |
| 0454257 | | chroom | 37423000 | stuk | 486,00 | 176 | 1 |  |
| 0455997 | | satinox | 37423810 | stuk | 631,00 | 176 | 1 | |
| 0454265 | basisgarnituur 3-gats badkraan | | 10422180 | stuk | 171,00 | 176 | 1 | |
| kleurset 4-gats badrandkraan kruisgreep | | | | | | | | |
| 0455555 | | chroom | 37445000 | stuk | 1049,00 | 176 | 1 |  |
| 0455563 | | satinox | 37445810 | stuk | 1363,00 | 176 | 1 | |
| 0451495 | basisgarnituur 4-gats badrandkraan | | 13444180 | stuk | 614,00 | 176 | 0 | |
| kleurset 4-gats badrandkraan rechte greep | | | | | | | | |
| 0455571 | | chroom | 37446000 | stuk | 1049,00 | 176 | 1 |  |
| 0455598 | | satinox | 37446810 | stuk | 1363,00 | 176 | 1 | |
| 0451495 | basisgarnituur 4-gats badrandkraan | | 13444180 | stuk | 614,00 | 176 | 0 | |
| kleurset 4-gats tegelrandkraan kruisgreep | | | | | | | | |
| 0455601 | | chroom | 37453000 | stuk | 1255,00 | 176 | 1 |  |
| 0455628 | | satinox | 37453810 | stuk | 1632,00 | 176 | 1 | |
| 0454885 | basisgarnituur 4-gats tegelrandkraan | | 14445180 | stuk | 1055,00 | 176 | 1 | |
| kleurset 4-gats tegelrandkraan rechte greep | | | | | | | | |
| 0455636 | | chroom | 37454000 | stuk | 1255,00 | 176 | 1 |  |
| 0455644 | | satinox | 37454810 | stuk | 1632,00 | 176 | 1 | |
| 0454885 | basisgarnituur 4-gats tegelrandkraan | | 14445180 | stuk | 1055,00 | 176 | 1 | |
| kleurset 4-gats thermostaat-badrandkraan | | | | | | | | |
| 0455652 | | chroom | 37461000 | stuk | 1198,00 | 176 | 1 |  |
| 0455660 | | satinox | 37461810 | stuk | 1556,00 | 176 | 1 | |
| 0454893 | basisgarnituur 4-gats thermostaat-badrandkraan | | 15460180 | stuk | 764,00 | 176 | 1 | |
| 4-gats badrandkraan m. kruisgreep | | | | | | | | |
| 0450249 | | chroom | 37447000 | stuk | 1002,00 | 176 | 1 |  |
| 0450250 | | satinox | 37447810 | stuk | 1329,00 | 176 | 1 | |
| 0451495 | basisgarnituur 4-gats badrandkraan | | 13444180 | stuk | 614,00 | 176 | 0 | |
| 4-gats badrandkraan m. rechte greep | | | | | | | | |
| 0450251 | | chroom | 37448000 | stuk | 1002,00 | 176 | 1 | |
| 0450252 | | satinox | 37448810 | stuk | 1329,00 | 176 | 1 | |
| 0451495 | basisgarnituur 4-gats badrandkraan | | 13444180 | stuk | 614,00 | 176 | 0 | |
| 4-gats tegelrandkraan m. kruisgreep | | | | | | | | |
| 0450253 | | chroom | 37456000 | stuk | 1198,00 | 176 | 1 | |
| 0450254 | | satinox | 37456810 | stuk | 1589,00 | 176 | 1 | |
| 0454885 | basisgarnituur 4-gats tegelrandkraan | | 14445180 | stuk | 1055,00 | 176 | 1 | |

Sanitair producten

Baden /
douchebakken /
stoomcabines

Kranen

Douchegarnituur

Accessoires en
spiegels

Douchewanden

Toebehoren &
afvoerenSpoel- &
installatiesystemenBadkamermeubelen
en toiletkastenGootstenen en
wastroggen

Utiliteit

| | Art.nr | Specificaties | Kleur | Lev.nr | Ehd | Prijs | Grp | CC |
|---|---|--------------------------------------|---------|----------|------|---------|-----|----|
| | Hansgrohe AXOR Terrano | | | | | | | |
| Sanitair producten | 4-gats tegelrandkraan m. rechte greep | | | | | | | |
| | 0450255 | | chrom | 37457000 | stuk | 1198,00 | 176 | 1 |
| | 0450256 | | satinox | 37457810 | stuk | 1589,00 | 176 | 1 |
| | 0454885 | basisgarnituur 4-gats tegelrandkraan | | 14445180 | stuk | 1055,00 | 176 | 1 |
| Baden / douchebakken / stoomcabines | baduitloop 3/4" | | | | | | | |
| | 0454281 | | chrom | 37410000 | stuk | 157,00 | 176 | 1 |
| | 0456012 | | satinox | 37410810 | stuk | 206,00 | 176 | 1 |
| Kranen | kleurset voor inbouw badkraan 1-greeps | | | | | | | |
| | 0457930 | | chrom | 37455000 | stuk | 240,00 | 176 | 1 |
| Douchegarnituur | 0457051 | basisgarnituur I-box universeel | | 01800180 | stuk | 107,00 | 176 | 0 |
| | kleurset voor inbouwthermostaat m. kruisgreep | | | | | | | |
| Accessoires en spiegels | 0457949 | | chrom | 37715000 | stuk | 462,00 | 176 | 1 |
| | 0457051 | basisgarnituur I-box universeel | | 01800180 | stuk | 107,00 | 176 | 0 |
| Douchewanden | kleurset voor inbouwthermostaat m. rechte greep | | | | | | | |
| | 0457957 | | chrom | 37710000 | stuk | 462,00 | 176 | 1 |
| Toebehoren & afvoeren | 0457051 | basisgarnituur I-box universeel | | 01800180 | stuk | 107,00 | 176 | 0 |
| | kleurset voor inbouwthermostaat m. stopkraan m. kruisgreep | | | | | | | |
| Spool- & installatiesystemen | 0459437 | | chrom | 37705000 | stuk | 563,00 | 176 | 1 |
| | 0457051 | basisgarnituur I-box universeel | | 01800180 | stuk | 107,00 | 176 | 0 |
| Badkamermeubelen en toiletkasten | kleurset voor inbouwthermostaat m. stopkraan m. rechte greep | | | | | | | |
| | 0459445 | | chrom | 37700000 | stuk | 563,00 | 176 | 1 |
| Gootstenen en wastroggen | 0457051 | basisgarnituur I-box universeel | | 01800180 | stuk | 107,00 | 176 | 0 |
| | kleurset voor inbouwthermostaat m. stopkraan m. omstel m. kruisgreep | | | | | | | |
| Utiliteit | 0457965 | | chrom | 37725000 | stuk | 646,00 | 176 | 1 |
| | 0457051 | basisgarnituur I-box universeel | | 01800180 | stuk | 107,00 | 176 | 0 |
| kleurset voor inbouwthermostaat m. stopkraan m. omstel m. rechte greep | | | | | | | | |
| | 0457973 | | chrom | 37720000 | stuk | 646,00 | 176 | 1 |
| | 0457051 | basisgarnituur I-box universeel | | 01800180 | stuk | 107,00 | 176 | 0 |
| kleurset voor inbouwthermostaat Highflow m. rechte greep | | | | | | | | |
| | 0450175 | voor Raindance Royal | chrom | 37711000 | stuk | 516,00 | 176 | 1 |
| | 0450176 | voor Raindance Royal | satinox | 37711810 | stuk | 633,00 | 176 | 1 |
| | 0457051 | basisgarnituur I-box universeel | | 01800180 | stuk | 107,00 | 176 | 0 |

| Art.nr | Specificaties | Kleur | Lev.nr | Ehd | Prijs | Grp | CC |
|--------|---------------|-------|--------|-----|-------|-----|----|
|--------|---------------|-------|--------|-----|-------|-----|----|

Hansgrohe AXOR Terrano

kleurset voor inbouwthermostaat Highflow m. kruisgreep

| | | | | | | | |
|---------|---------------------------------|---------|----------|------|--------|-----|---|
| 0450173 | voor Raindance Royal | chroom | 37716000 | stuk | 516,00 | 176 | 1 |
| 0450174 | voor Raindance Royal | satinox | 37716810 | stuk | 633,00 | 176 | 1 |
| 0457051 | basisgarnituur l-box universeel | | 01800180 | stuk | 107,00 | 176 | 0 |

Sanitair producten

kleurset inbouw Quattro 4weg omstel/ Trio stop - en omstelkraan m. kruisgreep

| | | | | | | | |
|---------|---|--------|----------|------|--------|-----|---|
| 0457981 | | chroom | 37925000 | stuk | 112,00 | 176 | 1 |
| 0450403 | basisgarnituur Trio inbouw stop- en omstelkraan | | 15981180 | stuk | 118,00 | 176 | 0 |
| 0457698 | basisgarnituur Quatro inbouw 4wegs omstelkraan | | 15930180 | stuk | 192,00 | 176 | 1 |
| 0457701 | verlengset 25mm | | 96370000 | stuk | 38,75 | 176 | 1 |

Baden /
douchebakken /
stoomcabines

Kranen

kleurset inbouw Quattro 4weg omstel/ Trio stop+omstelkraan m. rechte greep

| | | | | | | | |
|---------|---|--------|----------|------|--------|-----|---|
| 0458007 | | chroom | 37920000 | stuk | 112,00 | 176 | 1 |
| 0450403 | basisgarnituur Trio inbouw stop- en omstelkraan | | 15981180 | stuk | 118,00 | 176 | 0 |
| 0457698 | basisgarnituur Quatro inbouw 4wegs omstelkraan | | 15930180 | stuk | 192,00 | 176 | 1 |
| 0457701 | verlengset 25mm | | 96370000 | stuk | 38,75 | 176 | 1 |



Douchegarnituur

kleurset voor stopkraan kruisgreep

| | | | | | | | |
|---------|---|--------|----------|------|-------|-----|---|
| 0458015 | | chroom | 37965000 | stuk | 82,00 | 176 | 1 |
| 0457701 | verlengset 25mm | | 96370000 | stuk | 38,75 | 176 | 1 |
| 0457736 | basisgarnituur stopkraan m. spindel DN15 | | 15973180 | stuk | 61,50 | 176 | 0 |
| 0457744 | basisgarnituur stopkraan m. keramische delen DN15 | | 15974180 | stuk | 64,00 | 176 | 0 |
| 0457752 | basisgarnituur stopkraan m. spindel DN20 | | 15970180 | stuk | 67,00 | 176 | 1 |

Accessoires en
spiegels

Douchewanden

kleurset voor stopkraan rechte greep

| | | | | | | | |
|---------|---|--------|----------|------|-------|-----|---|
| 0458023 | | chroom | 37960000 | stuk | 82,00 | 176 | 1 |
| 0457701 | verlengset 25mm | | 96370000 | stuk | 38,75 | 176 | 1 |
| 0457736 | basisgarnituur stopkraan m. spindel DN15 | | 15973180 | stuk | 61,50 | 176 | 0 |
| 0457744 | basisgarnituur stopkraan m. keramische delen DN15 | | 15974180 | stuk | 64,00 | 176 | 0 |
| 0457752 | basisgarnituur stopkraan m. spindel DN20 | | 15970180 | stuk | 67,00 | 176 | 1 |

Toebehoren &
afvoerenSpoel- &
installatiesystemen

Hansgrohe AXOR Uno

1-greeps fonteinkraan m. zero greep

| | | | | | | | |
|---------|--|--------|----------|------|--------|-----|---|
| 0450352 | | chroom | 38005000 | stuk | 293,00 | 176 | 1 |
|---------|--|--------|----------|------|--------|-----|---|

Badkamermeubelen
en toiletkasten**fonteinkraan m. beugelgreep**

| | | | | | | | |
|---------|--|--------|----------|------|--------|-----|---|
| 0450259 | | chroom | 38015000 | stuk | 293,00 | 176 | 1 |
|---------|--|--------|----------|------|--------|-----|---|

Gootstenen en
wastroggen

Utiliteit







1-gats wastafelkraan m. zero greep

| | | | | | | | |
|---------|--|--------|----------|------|--------|-----|---|
| 0456861 | | chroom | 38000000 | stuk | 324,00 | 176 | 0 |
|---------|--|--------|----------|------|--------|-----|---|

**1-gats wastafelkraan m. beugelgreep**

| | | | | | | | |
|---------|--|--------|----------|------|--------|-----|---|
| 0456888 | | chroom | 38001000 | stuk | 324,00 | 176 | 0 |
|---------|--|--------|----------|------|--------|-----|---|



| | Art.nr | Specificaties | Kleur | Lev.nr | Ehd | Prijs | Grp | CC |
|---|---|---|-------|----------|------|--------|-----|----|
| Sanitair producten | Hansgrohe AXOR Uno | | | | | | | |
| | | 1-greeps wastafelkraan m. hoge uitloop | | | | | | |
| | 0456866 | | chrom | 38030000 | stuk | 445,00 | 176 | 1 |
| Baden / douchebakken / stoomcabines |  | | | | | | | |
| Kranen | | 3-gats wastafelkraan m. zero greep | | | | | | |
| | 0456896 | | chrom | 38033000 | stuk | 500,00 | 176 | 1 |
| Douchegarnituur |  | | | | | | | |
| Accessoires en spiegels | | 3-gats wastafelkraan | | | | | | |
| | 0456870 | | chrom | 38053000 | stuk | 519,00 | 176 | 1 |
| Douchewanden |  | | | | | | | |
| Toebehoren & afvoeren | | kleurset voor 3-gats muurkraan m. zero greep | | | | | | |
| | 0456918 | | chrom | 38043000 | stuk | 385,00 | 176 | 1 |
| | 0453450 | basisgarnituur voor 3-gats wandkraan | | 10303180 | stuk | 174,00 | 176 | 0 |
| Spoel- & installatiesystemen | | kleurset inbouwwandkraan m. plaat | | | | | | |
| | 0450030 | 17.5cm | chrom | 38112000 | stuk | 450,00 | 176 | 1 |
| | 0450036 | 23.5cm | chrom | 38115000 | stuk | 454,00 | 176 | 1 |
| | 0450034 | basisgarnituur voor inbouwwastafelkraan | | 38111180 | stuk | 206,00 | 176 | 0 |
| Badkamermeubelen en toiletkasten | | kleurset inbouwwandkraan m. rozet | | | | | | |
| | 0450040 | 17.5cm | chrom | 38113000 | stuk | 290,00 | 176 | 1 |
| | 0450044 | 23.5cm | chrom | 38116000 | stuk | 309,00 | 176 | 0 |
| | 0450034 | basisgarnituur voor inbouwwastafelkraan | | 38111180 | stuk | 206,00 | 176 | 0 |
| Gootstenen en wastroggen |  | | | | | | | |
| Utiliteit | | 1-gats bidetkraan m. zero greep | | | | | | |
| | 0456934 | | chrom | 38200000 | stuk | 324,00 | 176 | 1 |
| |  | | | | | | | |
| | | 1-gats bidetkraan m. beugelgreep | | | | | | |
| | 0456942 | | chrom | 38201000 | stuk | 324,00 | 176 | 1 |
| |  | | | | | | | |
| | | badkraan m. zero greep | | | | | | |
| | 0456950 | | chrom | 38400000 | stuk | 433,00 | 176 | 1 |
| |  | | | | | | | |

| Art.nr | Specificaties | Kleur | Lev.nr | Ehd | Prijs | Grp | CC |
|--------|---------------|-------|--------|-----|-------|-----|----|
|--------|---------------|-------|--------|-----|-------|-----|----|

Hansgrohe AXOR Uno

badkraan m. beugelgreep

| | | | | | | | |
|---------|--|-------|----------|------|--------|-----|---|
| 0457043 | | chrom | 38401000 | stuk | 433,00 | 176 | 1 |
|---------|--|-------|----------|------|--------|-----|---|



Sanitair producten

Baden /
douchebakken /
stoomcabines**kleurset voor inbouwbadkraan m. zerogreep**

| | | | | | | | |
|---------|--|-------|----------|------|--------|-----|---|
| 0606928 | | chrom | 38405000 | stuk | 240,00 | 176 | 1 |
|---------|--|-------|----------|------|--------|-----|---|

| | | | | | | | |
|---------|---------|-------|----------|------|--------|-----|---|
| 0606936 | Exafill | chrom | 38407000 | stuk | 348,00 | 176 | 1 |
|---------|---------|-------|----------|------|--------|-----|---|

| | | | | | | | |
|---------|---------------------------------|--|----------|------|--------|-----|---|
| 0457051 | basisgarnituur l-box universeel | | 01800180 | stuk | 107,00 | 176 | 0 |
|---------|---------------------------------|--|----------|------|--------|-----|---|



Kranen

Douchegarnituur

kleurset voor inbouwbadkraan m. beugelgreep

| | | | | | | | |
|---------|--|-------|----------|------|--------|-----|---|
| 0606944 | | chrom | 38415000 | stuk | 240,00 | 176 | 1 |
|---------|--|-------|----------|------|--------|-----|---|

| | | | | | | | |
|---------|---------|-------|----------|------|--------|-----|---|
| 0606952 | Exafill | chrom | 38417000 | stuk | 348,00 | 176 | 1 |
|---------|---------|-------|----------|------|--------|-----|---|

| | | | | | | | |
|---------|---------------------------------|--|----------|------|--------|-----|---|
| 0457051 | basisgarnituur l-box universeel | | 01800180 | stuk | 107,00 | 176 | 0 |
|---------|---------------------------------|--|----------|------|--------|-----|---|

Accessoires en
spiegels**afbouwset voor 2-gats badrandthermostaat**

| | | | | | | | |
|---------|--|-------|----------|------|--------|-----|---|
| 0450261 | | chrom | 38480000 | stuk | 124,00 | 176 | 1 |
|---------|--|-------|----------|------|--------|-----|---|

| | | | | | | | |
|---------|---|--|----------|------|--------|-----|---|
| 0458716 | basisgarnituur voor 2-gats badrandthermostaat | | 13550180 | stuk | 585,00 | 176 | 0 |
|---------|---|--|----------|------|--------|-----|---|



Douchewanden

Toebehoren &
afvoeren**kleurset voor 4-gats badrandkraan**

| | | | | | | | |
|---------|--|-------|----------|------|--------|-----|---|
| 0457078 | | chrom | 38444000 | stuk | 840,00 | 176 | 1 |
|---------|--|-------|----------|------|--------|-----|---|

| | | | | | | | |
|---------|------------------------------------|--|----------|------|--------|-----|---|
| 0451495 | basisgarnituur 4-gats badrandkraan | | 13444180 | stuk | 614,00 | 176 | 0 |
|---------|------------------------------------|--|----------|------|--------|-----|---|

Spoel- &
installatiesystemen**kleurset voor 4-gats tegelrandkraan**

| | | | | | | | |
|---------|--|-------|----------|------|---------|-----|---|
| 0457086 | | chrom | 38454000 | stuk | 1146,00 | 176 | 1 |
|---------|--|-------|----------|------|---------|-----|---|

| | | | | | | | |
|---------|--------------------------------------|--|----------|------|---------|-----|---|
| 0454885 | basisgarnituur 4-gats tegelrandkraan | | 14445180 | stuk | 1055,00 | 176 | 1 |
|---------|--------------------------------------|--|----------|------|---------|-----|---|

Badkamermeubelen
en toiletkastenGootstenen en
wastroggen**kleurset voor 4-gats badrandthermostaat**

| | | | | | | | |
|---------|--|-------|----------|------|---------|-----|---|
| 0457109 | | chrom | 38461000 | stuk | 1053,00 | 176 | 1 |
|---------|--|-------|----------|------|---------|-----|---|

| | | | | | | | |
|---------|--|--|----------|------|--------|-----|---|
| 0454893 | basisgarnituur 4-gats thermostaat-badrandkraan | | 15460180 | stuk | 764,00 | 176 | 1 |
|---------|--|--|----------|------|--------|-----|---|



Utiliteit

douchekraan z. omstel m. zerogreep

| | | | | | | | |
|---------|--|-------|----------|------|--------|-----|---|
| 0457094 | | chrom | 38600000 | stuk | 344,00 | 176 | 1 |
|---------|--|-------|----------|------|--------|-----|---|

| | | | | | | | |
|---------|------------------------------------|--|---------|------|------|-----|---|
| 0770752 | Montagebeugel messing 2x15 mmx1/2" | | 0770752 | stuk | 5,90 | 475 | 0 |
|---------|------------------------------------|--|---------|------|------|-----|---|

**douchekraan z. omstel m. beugelgreep**

| | | | | | | | |
|---------|--|-------|----------|------|--------|-----|---|
| 0457108 | | chrom | 38601000 | stuk | 344,00 | 176 | 1 |
|---------|--|-------|----------|------|--------|-----|---|

| | | | | | | | |
|---------|------------------------------------|--|---------|------|------|-----|---|
| 0770752 | Montagebeugel messing 2x15 mmx1/2" | | 0770752 | stuk | 5,90 | 475 | 0 |
|---------|------------------------------------|--|---------|------|------|-----|---|









**kleurset voor inbouwthermostaat**

| | | | | | | | |
|---------|--|-------|----------|------|--------|-----|---|
| 0457116 | | chrom | 38375000 | stuk | 462,00 | 176 | 1 |
|---------|--|-------|----------|------|--------|-----|---|

| | | | | | | | |
|---------|---------------------------------|--|----------|------|--------|-----|---|
| 0457051 | basisgarnituur l-box universeel | | 01800180 | stuk | 107,00 | 176 | 0 |
|---------|---------------------------------|--|----------|------|--------|-----|---|











| | Art.nr | Specificaties | Kleur | Lev.nr | Ehd | Prijs | Grp | CC |
|---|---|---|--------|----------|------|--------|-----|----|
| Sanitair producten | Hansgrohe AXOR Uno | | | | | | | |
| | kleurset voor inbouwthermostaat m. stopkraan | | | | | | | |
| | 0457124 | | chroom | 38700000 | stuk | 563,00 | 176 | 0 |
| | 0457051 | basisgarnituur I-box universeel | | 01800180 | stuk | 107,00 | 176 | 0 |
| Baden / douchebakken / stoomcabines | | | | | | | | |
| Kranen | kleurset voor inbouwthermostaat m. stopkraan m. omstelkraan | | | | | | | |
| | 0457132 | | chroom | 38720000 | stuk | 646,00 | 176 | 0 |
| | 0457051 | basisgarnituur I-box universeel | | 01800180 | stuk | 107,00 | 176 | 0 |
| Douchegarnituur | | | | | | | | |
| Accessoires en spiegels | kleurset voor inbouwthermostaat Highflow | | | | | | | |
| | 0450171 | voor Raindance Royal | chroom | 38715000 | stuk | 516,00 | 176 | 1 |
| | 0457051 | basisgarnituur I-box universeel | | 01800180 | stuk | 107,00 | 176 | 0 |
| Douchewanden | kleurset inbouw Quattro 4weg omstelkraan / Trio stop- en omstelkraan | | | | | | | |
| | 0457159 | | chroom | 38933000 | stuk | 112,00 | 176 | 1 |
| | 0450403 | basisgarnituur Trio inbouw stop- en omstelkraan | | 15981180 | stuk | 118,00 | 176 | 0 |
| | 0457698 | basisgarnituur Quattro inbouw 4wegs omstelkraan | | 15930180 | stuk | 192,00 | 176 | 1 |
| | 0457701 | verlengset 25mm | | 96370000 | stuk | 38,75 | 176 | 1 |
| Toebehoren & afvoeren | kleurset stopkraan | | | | | | | |
| | 0457140 | | chroom | 38976000 | stuk | 82,00 | 176 | 0 |
| | 0457701 | verlengset 25mm | | 96370000 | stuk | 38,75 | 176 | 1 |
| | 0457736 | basisgarnituur stopkraan m. spindel DN15 | | 15973180 | stuk | 61,50 | 176 | 0 |
| | 0457744 | basisgarnituur stopkraan m. keramische delen DN15 | | 15974180 | stuk | 64,00 | 176 | 0 |
| Spoel- & installatiesystemen | 0457752 | basisgarnituur stopkraan m. spindel DN20 | | 15970180 | stuk | 67,00 | 176 | 1 |
| Badkamermeubelen en toiletkasten | verlengset voor basisgarnituur | | | | | | | |
| | 0450048 | | | 38982000 | stuk | 77,50 | 176 | 1 |
| Gootstenen en wastroggen | Hansgrohe AXOR Uno-2 | | | | | | | |
| | 1-greeps wastafelkraan m. waste | | | | | | | |
| | 0456862 | | chroom | 38020000 | stuk | 321,00 | 176 | 0 |
| | 0450115 | m. koperen aansluitpijpen | chroom | 38024000 | stuk | 321,00 | 176 | 1 |
| Utiliteit | 1-greeps wastafelkraan verhoogd | | | | | | | |
| | 0456864 | | chroom | 38025000 | stuk | 432,00 | 176 | 1 |
| | 2-greeps wastafelkraan | | | | | | | |
| | 0456868 | | chroom | 38040000 | stuk | 395,00 | 176 | 0 |
| | 1-greeps bidetkraan | | | | | | | |
| | 0456872 | | chroom | 38210000 | stuk | 321,00 | 176 | 1 |

| Art.nr | Specificaties | Kleur | Lev.nr | Ehd | Prijs | Grp | CC | | |
|--|---------------|-------|----------|------|--------|-----|----|---|---|
| Hansgrohe AXOR Uno-2 | | | | | | | | | |
| 2-greeps bidetkraan 0456874 | | chrom | 38222000 | stuk | 395,00 | 176 | 1 |  | Sanitair producten |
| badkraan 0456876 | | chrom | 38420000 | stuk | 432,00 | 176 | 1 |  | Baden / douchebakken / stoomcabines |
| douchekraan 0456878 | | chrom | 38620000 | stuk | 346,00 | 176 | 1 |  | Kranen |
| kleurset voor inbouwdochekraan m. beugelgreep 0450140 | | chrom | 38625000 | stuk | 198,00 | 176 | 1 |  | Douchegarnituur |
| 0457051 basisgarnituur I-box universeel | | | 01800180 | stuk | 107,00 | 176 | 0 | | Accessoires en spiegels |
| kleurset voor inbouwbadkraan m. beugelgreep 0450138 | | chrom | 38425000 | stuk | 233,00 | 176 | 1 |  | Douchewanden |
| 0457051 basisgarnituur I-box universeel | | | 01800180 | stuk | 107,00 | 176 | 0 | | Toebehoren & afvoeren |
| Hansgrohe Electronische kranen | | | | | | | | | |
| electronische wastafelkraan m. temperatuur instelling 0452932 | | chrom | 15100000 | stuk | 583,00 | 373 | 1 |  | Badkamermeubelen en toiletkasten |
| electronische wastafelkraan z. temperatuur instelling 0452936 | | chrom | 15101000 | stuk | 539,00 | 373 | 1 |  | Gootstenen en wastroggen |
| electronische wastafelkraan m. netaansluiting m. temperatuurregeling 0450553 | | chrom | 15180000 | stuk | 626,00 | 383 | 1 | | Utiliteit |
| 0450554 | | RVS | 15180800 | stuk | 811,00 | 383 | 1 | | |
| electronische wastafelkraan m. netaansluiting 0450555 | | chrom | 15181000 | stuk | 579,00 | 383 | 1 | | |
| Hansgrohe Universeel | | | | | | | | | |
| toiletkraan 1-greeps staande montage 0450952 | | chrom | 13130000 | stuk | 129,00 | 176 | 0 |  | |
| montageset voor badkraan van wand naar staande montage 0454284 | | chrom | 14920000 | stuk | 59,00 | 176 | 1 | | |
| basisgarnituur 3-gats badkraan 0454265 | | | 10422180 | stuk | 171,00 | 176 | 1 | | |

| | Art.nr | Specificaties | Kleur | Lev.nr | Ehd | Prijs | Grp | CC |
|---|---|---------------|------------|----------|------|---------|-----|----|
| | Hansgrohe Universeel | | | | | | | |
| Sanitair producten | basisgarnituur 3-gats tegelrandkraan | | | | | | | |
| | 0454877 | | | 14435180 | stuk | 1021,00 | 176 | 1 |
| | basisgarnituur 4-gats tegelrandkraan | | | | | | | |
| | 0454885 | | | 14445180 | stuk | 1055,00 | 176 | 1 |
| Baden / douchebakken / stoomcabines | basisgarnituur 3-gats badrandkraan | | | | | | | |
| | 0452661 | | | 13433180 | stuk | 581,00 | 176 | 1 |
| Kranen | basisgarnituur 4-gats badrandkraan | | | | | | | |
| | 0451495 | | | 13444180 | stuk | 614,00 | 176 | 0 |
| | basisgarnituur 4-gats thermostaat tegelrandkraan | | | | | | | |
| Douchegarnituur | 0454907 | | | 15465180 | stuk | 1204,00 | 176 | 1 |
| | basisgarnituur l-box universeel | | | | | | | |
| | 0457051 | | | 01800180 | stuk | 107,00 | 176 | 0 |
| Accessoires en spiegels | basisgarnituur voor douchezuil | | | | | | | |
| | 0606294 | | | 10902180 | stuk | 264,00 | 176 | 0 |
| Douchewanden | kleurset 3-gats badrandkraan | | | | | | | |
| | 0454915 | | chrom | 15633000 | stuk | 358,00 | 176 | 1 |
| | 0454923 | | chrom/goud | 15633090 | stuk | 389,00 | 176 | 1 |
| Toebehoren & afvoeren | kleurset 3-gats tegelrandkraan | | | | | | | |
| | 0454931 | | chrom | 15335000 | stuk | 402,00 | 176 | 1 |
| Spoel- & installatiesystemen | kleurset 4-gats badrandkraan | | | | | | | |
| | 0454966 | | chrom | 15644000 | stuk | 510,00 | 176 | 1 |
| | 0454974 | | chrom/goud | 15644090 | stuk | 609,00 | 176 | 1 |
| Badkamermeubelen en toiletkasten | kleurset 4-gats tegelrandkraan | | | | | | | |
| | 0454982 | | chrom | 15451000 | stuk | 578,00 | 176 | 1 |
| Gootstenen en wastroggen | basisgarnituur voor baduitloop | | | | | | | |
| | 0450591 | | | 18471180 | stuk | 65,50 | 176 | 1 |
| Utiliteit | Secuflex bad-/tegelranddoorvoerset | | | | | | | |
| | 0453714 | | chrom | 28380000 | stuk | 261,00 | 176 | 0 |
| | 0600118 | | RVS | 28380800 | stuk | 352,00 | 176 | 1 |
| | badranddoorvoer | | | | | | | |
| | 0603455 | | chrom | 28307000 | stuk | 88,50 | 259 | 0 |
| | basisgarnituur voor 2-gats badrandthermostaat | | | | | | | |
| | 0458716 | | | 13550180 | stuk | 585,00 | 176 | 0 |
| | basisgarnituur 4-gats thermostaat-badrandkraan | | | | | | | |
| | 0454893 | | | 15460180 | stuk | 764,00 | 176 | 1 |
| | kleurset 4-gats thermostaat-badrandkraan | | | | | | | |
| | 0455008 | | chrom | 15461000 | stuk | 659,00 | 176 | 1 |
| | 0455016 | | chrom/goud | 15461090 | stuk | 778,00 | 176 | 1 |
| | basisgarnituur voor inbouwwastafelkraan | | | | | | | |
| | 0450034 | | | 38111180 | stuk | 206,00 | 176 | 0 |
| | basisgarnituur voor 3-gats wandkraan | | | | | | | |
| | 0453450 | | | 10303180 | stuk | 174,00 | 176 | 0 |
| | 0450584 | | | 18113180 | stuk | 166,00 | 176 | 1 |

| Art.nr | Specificaties | Kleur | Lev.nr | Ehd | Prijs | Grp | CC | |
|--|---|----------|----------|------|--------|-----|----|---|
| | | | | | | | | Hansgrohe Universeel |
| slanggarnituur Secuflex 140cm | | | | | | | | |
| 0451007 | | | 94109000 | stuk | 234,00 | 176 | 1 | Sanitair producten |
| verlengset Ibox 25mm | | | | | | | | |
| 0457647 | | | 13595000 | stuk | 33,50 | 176 | 1 | Baden / douchebakken / stoomcabines |
| kleurset voor inbouw thermostaat | | | | | | | | |
| 0457655 | | chrom | 15710000 | stuk | 372,00 | 176 | 1 |  Kranen |
| kleurset voor inbouw thermostaat m. stopkraan | | | | | | | | |
| 0457663 | | chrom | 15700000 | stuk | 452,00 | 176 | 1 |  Douchegarnituur |
| kleurset voor inbouw thermostaat m. stopkraan m. omstel | | | | | | | | |
| 0457671 | | chrom | 15720000 | stuk | 519,00 | 176 | 0 | Accessoires en spiegels |
| basisgarnituur Trio inbouw stop- en omstelkraan | | | | | | | | |
| 0450403 | | | 15981180 | stuk | 118,00 | 176 | 0 | Douchewanden |
| basisgarnituur Quatro inbouw 4wegs omstelkraan | | | | | | | | |
| 0457698 | | | 15930180 | stuk | 192,00 | 176 | 1 | Toebehoren & afvoeren |
| verlengset 25mm | | | | | | | | |
| 0457701 | | | 96370000 | stuk | 38,75 | 176 | 1 | Spoel- & installatiesystemen |
| kleurset voor 4wegs omstelkraan Quattro | | | | | | | | |
| 0457728 | | chrom | 15931000 | stuk | 46,00 | 176 | 1 | Badkamermeubelen en toiletkasten |
| basisgarnituur stopkraan m. spindel DN15 | | | | | | | | |
| 0457736 | | | 15973180 | stuk | 61,50 | 176 | 0 | Gootstenen en wastroggen |
| basisgarnituur stopkraan m. keramische delen DN15 | | | | | | | | |
| 0457744 | | | 15974180 | stuk | 64,00 | 176 | 0 | Utiliteit |
| basisgarnituur stopkraan m. spindel DN20 | | | | | | | | |
| 0457752 | | | 15970180 | stuk | 67,00 | 176 | 1 | |
| kleurset voor stopkraan | | | | | | | | |
| 0457760 | | chrom | 15971000 | stuk | 31,00 | 176 | 1 | |
| opvulrozet voor I-box 22mm | | | | | | | | |
| 0606871 | | chrom | 13596000 | stuk | 31,50 | 176 | 1 | |
| 0606898 | | inox | 13596810 | stuk | 31,50 | 176 | 1 | |
| serviceset voor kogelmengtechniek | | | | | | | | |
| 0452769 | | | 13952000 | stuk | 16,25 | 176 | 0 | |
| verlengset 25mm voor 13520180 | | | | | | | | |
| 0452800 | | | 32498000 | stuk | 93,50 | 176 | 1 | |
| 0452810 | | | 32698000 | stuk | 72,50 | 176 | 1 | |
| kleurset voor 2-gats badrandthermostaat | | | | | | | | |
| 0458732 | | chrom | 15450000 | stuk | 79,00 | 176 | 1 | |
| 0458716 | basisgarnituur voor 2-gats badrandthermostaat | | 13550180 | stuk | 585,00 | 176 | 0 |  |
| | | | | | | | | Hansgrohe Flowstar hoekstopkranen |
| Flowstar hoekstopkraan m. huls | | | | | | | | |
| 0606278 | | chrom | 13954000 | stuk | 39,75 | 350 | 0 | |
| 0606286 | | RVS-look | 13954800 | stuk | 54,00 | 350 | 0 | |

| | Art.nr | Specificaties | Kleur | Lev.nr | Ehd | Prijs | Grp | CC |
|---|--|--|----------|----------|------|-------|-----|----|
| | Hansgrohe Flowstar hoekstopkranen | | | | | | | |
| | Flowstar huls voor hoekstopkraan | | | | | | | |
| Sanitair producten | 0606227 | | chrom | 13950000 | stuk | 24,75 | 350 | 1 |
| | 0606235 | | RVS-look | 13950800 | stuk | 33,50 | 350 | 1 |
| | 0606243 | | satinox | 13950810 | stuk | 32,00 | 350 | 1 |
| Baden / douchebakken / stoomcabines | | | | | | | | |
| Kranen | | Flowstar afdekrozet voor schroefdraad van wastafelkraan | | | | | | |
| | | 0606251 | | 13959000 | stuk | 17,50 | 350 | 1 |
| Douchegarnituur | | | | | | | | |
| Accessoires en spiegels | | | | | | | | |
| Douchewanden | | | | | | | | |
| Toebehoren & afvoeren | | | | | | | | |
| Spoel- & installatiesystemen | | | | | | | | |
| Badkamermeubelen en toiletkasten | | | | | | | | |
| Gootstenen en wastroggen | | | | | | | | |
| Utiliteit | | | | | | | | |

| Art.nr | Specificaties | Kleur | Lev.nr | Ehd | Prijs | Grp | CC | | |
|--|---------------|--------|---------|------|--------|-----|----|---|---|
| | | | | | | | | Ideal Standard Alfieri | |
| wastafelkraan m. waste 0180052 | | chroom | N9786AA | stuk | 233,00 | 179 | 1 |  | Sanitair producten |
| douchekraan 0180054 | | chroom | N9788AA | stuk | 255,00 | 179 | 1 |  | Baden / douchebakken / stoomcabines |
| badkraan 0180053 | | chroom | N9812AA | stuk | 300,00 | 179 | 1 |  | Douchegarnituur |
| | | | | | | | | Ideal Standard Celia | |
| 1-gats wastafelkraan m. waste 0180047 | | chroom | A3440AA | stuk | 297,00 | 179 | 1 |  | Accessoires en spiegels |
| 1-gats wastafelkraan m. hoge uitloop 0180048 | | chroom | A3447AA | stuk | 320,00 | 179 | 1 |  | Douchewanden |
| 3-gats wastafelkraan 0180050 | | chroom | A3444AA | stuk | 438,00 | 179 | 1 |  | Toebehoren & afvoeren |
| 3-gats wandkraan 0180051 | | chroom | A3477AA | stuk | 290,00 | 179 | 1 |  | Spoel- & installatiesystemen |
| bidetkraan m. waste 0180049 | | chroom | A3442AA | stuk | 388,00 | 179 | 1 |  | Badkamermeubelen en toiletkasten |
| douchethermostaat 0180037 | | chroom | A3435AA | stuk | 337,00 | 179 | 1 |  | Gootstenen en wastroggen |
| | | | | | | | | | Utiliteit |

| | Art.nr | Specificaties | Kleur | Lev.nr | Ehd | Prijs | Grp | CC |
|---|---|--|-------|---------|------|--------|-----|----|
| Sanitair producten | Ideal Standard Celia | | | | | | | |
| | | badthermostaat | | | | | | |
| | 0180042 | | chrom | A3436AA | stuk | 399,00 | 179 | 1 |
| Baden / douchebakken / stoomcabines |  | | | | | | | |
| Kranen | Ideal Standard Ceramix | | | | | | | |
| | | 1-gats wastafelkraan m. uittrekbare uitloop | | | | | | |
| | 0462063 | | chrom | A5014AA | stuk | 320,00 | 179 | 1 |
| Douchegarnituur |  | | | | | | | |
| Accessoires en spiegels | 1-gats wastafelkraan m. waste 130mm | | | | | | | |
| | | 0462047 | | | | | | |
| | 0462047 | | chrom | A5000AA | stuk | 160,00 | 179 | 1 |
| Douchewanden |  | | | | | | | |
| Toebehoren & afvoeren | 1-gats bidetkraan m. waste | | | | | | | |
| | | 0462098 | | | | | | |
| | 0462098 | | chrom | A5016AA | stuk | 179,00 | 179 | 1 |
| Douchewanden |  | | | | | | | |
| Spoel- & installatiesystemen | douchekraan HOH=15cm z. omstel | | | | | | | |
| | | 0462101 | | | | | | |
| | 0462101 | | chrom | A5023AA | stuk | 156,00 | 179 | 1 |
| Badkamermeubelen en toiletkasten |  | | | | | | | |
| Gootstenen en wastroggen | badkraan HOH=15cm m. omstel z. garnituur | | | | | | | |
| | | 0462071 | | | | | | |
| | 0462071 | | chrom | A5018AA | stuk | 213,00 | 179 | 1 |
| Douchewanden |  | | | | | | | |
| Utiliteit | Ideal Standard CeraTherm 100 | | | | | | | |
| | | badthermostaat | | | | | | |
| | 0466239 | | chrom | A3201AA | stuk | 203,00 | 179 | 0 |
| Douchewanden |  | | | | | | | |
| Utiliteit | douchethermostaat HOH=12cm | | | | | | | |
| | | 0466247 | | | | | | |
| | 0466247 | | chrom | A3219AA | stuk | 170,00 | 179 | 1 |
| Douchewanden |  | | | | | | | |
| Utiliteit | douchethermostaat HOH=15cm | | | | | | | |
| | | 0466220 | | | | | | |
| | 0466220 | | chrom | A3202AA | stuk | 170,00 | 179 | 0 |
| Douchewanden |  | | | | | | | |
| Utiliteit | Ideal Standard CeraTherm 200 | | | | | | | |
| | | badthermostaat | | | | | | |
| | 0466263 | | chrom | A3205AA | stuk | 259,00 | 179 | 1 |
| Douchewanden |  | | | | | | | |
| Utiliteit | douchethermostaat | | | | | | | |
| | | 0466255 | | | | | | |
| | 0466255 | | chrom | A3206AA | stuk | 214,00 | 179 | 1 |
| Douchewanden |  | | | | | | | |

| Art.nr | Specificaties | Kleur | Lev.nr | Ehd | Prijs | Grp | CC |
|--------|---------------|-------|--------|-----|-------|-----|----|
|--------|---------------|-------|--------|-----|-------|-----|----|

Ideal Standard CeraTherm 200

opbouwset voor inbouwstopkraan 1/2"

| | | | | | | | |
|---------|--|-------|-----------|------|-------|-----|---|
| 0466336 | | chrom | A3284AA | stuk | 31,75 | 179 | 1 |
| 0466344 | inbouwdeel draadaansluiting 1/2" keramisch | | A2356NU | stuk | 41,75 | 179 | 1 |
| 0466352 | inbouwdeel draadaansluiting 1/2" rubber | | A2355NU | stuk | 42,75 | 179 | 1 |
| 0466360 | inbouwdeel draadaansluiting 3/4" rubber | | A2359NU | stuk | 53,50 | 179 | 1 |
| 0466379 | set voor te diepe inbouw, maximaal 20mm | | A963560NU | stuk | 53,50 | 179 | 1 |



Sanitair producten

Baden /
douchebakken /
stoomcabines**opbouwset voor inbouwthermostaat 1/2" m. stopkraan**

| | | | | | | | |
|---------|---|-------|-----------|------|--------|-----|---|
| 0466328 | | chrom | A3207AA | stuk | 126,00 | 179 | 1 |
| 0460124 | inbouwdeel thermostaat + stopkraan | | A2353NU | stuk | 238,00 | 023 | 1 |
| 0466484 | verlengset voor te vlakke inbouw 20mm | | A963436AA | stuk | 124,00 | 179 | 1 |
| 0466492 | set voor te diepe inbouw, maximaal 20mm | | A963434NU | stuk | 82,00 | 179 | 1 |



Kranen

opbouwset voor inbouwthermostaat 1/2" - 3/4" z. stopkraan

| | | | | | | | |
|---------|---|-------|-----------|------|--------|-----|---|
| 0466271 | | chrom | A3208AA | stuk | 110,00 | 179 | 1 |
| 0466298 | inbouwdeel voor centraal thermostaat 1/2" | | A2354NU | stuk | 180,00 | 179 | 1 |
| 0466301 | inbouwdeel voor centraal thermostaat 3/4" | | A2659NU | stuk | 251,00 | 179 | 1 |
| 0466484 | verlengset voor te vlakke inbouw 20mm | | A963436AA | stuk | 124,00 | 179 | 1 |
| 0466492 | set voor te diepe inbouw, maximaal 20mm | | A963434NU | stuk | 82,00 | 179 | 1 |



Douchegarnituur

Accessoires en
spiegels

Ideal Standard CeraTherm 300

douchethermostaat

| | | | | | | | |
|---------|--|-------|---------|------|--------|-----|---|
| 0466425 | | chrom | A3210AA | stuk | 272,00 | 179 | 1 |
|---------|--|-------|---------|------|--------|-----|---|



Douchewanden

badthermostaat

| | | | | | | | |
|---------|--|-------|---------|------|--------|-----|---|
| 0466433 | | chrom | A3209AA | stuk | 328,00 | 179 | 1 |
|---------|--|-------|---------|------|--------|-----|---|

Toebehoren &
afvoeren**opbouwset voor inbouwthermostaat 1/2" m. stopkraan**

| | | | | | | | |
|---------|---|-------|-----------|------|--------|-----|---|
| 0466506 | | chrom | A3211AA | stuk | 136,00 | 179 | 1 |
| 0460124 | inbouwdeel thermostaat + stopkraan | | A2353NU | stuk | 238,00 | 023 | 1 |
| 0466484 | verlengset voor te vlakke inbouw 20mm | | A963436AA | stuk | 124,00 | 179 | 1 |
| 0466492 | set voor te diepe inbouw, maximaal 20mm | | A963434NU | stuk | 82,00 | 179 | 1 |

Spoel- &
installatiesystemenBadkamermeubelen
en toiletkasten**opbouwset voor inbouwthermostaat 1/2" - 3/4" z. stopkraan**

| | | | | | | | |
|---------|---|-------|-----------|------|--------|-----|---|
| 0466441 | | chrom | A3212AA | stuk | 131,00 | 179 | 1 |
| 0466298 | inbouwdeel voor centraal thermostaat 1/2" | | A2354NU | stuk | 180,00 | 179 | 1 |
| 0466301 | inbouwdeel voor centraal thermostaat 3/4" | | A2659NU | stuk | 251,00 | 179 | 1 |
| 0466484 | verlengset voor te vlakke inbouw 20mm | | A963436AA | stuk | 124,00 | 179 | 1 |
| 0466492 | set voor te diepe inbouw, maximaal 20mm | | A963434NU | stuk | 82,00 | 179 | 1 |

Gootstenen en
wastroggen

Utiliteit

inbouwdeel thermostaat + stopkraan

| | | | | | | | |
|---------|--|--|---------|------|--------|-----|---|
| 0460124 | | | A2353NU | stuk | 238,00 | 023 | 1 |
|---------|--|--|---------|------|--------|-----|---|

Ideal Standard CeraTherm Universeel

inbouwdeel voor centraal thermostaat 1/2"

| | | | | | | | |
|---------|--|--|---------|------|--------|-----|---|
| 0466298 | | | A2354NU | stuk | 180,00 | 179 | 1 |
|---------|--|--|---------|------|--------|-----|---|

inbouwdeel voor centraal thermostaat 3/4"

| | | | | | | | |
|---------|--|--|---------|------|--------|-----|---|
| 0466301 | | | A2659NU | stuk | 251,00 | 179 | 1 |
|---------|--|--|---------|------|--------|-----|---|

inbouwdeel draadaansluiting 1/2" keramisch

| | | | | | | | |
|---------|--|--|---------|------|-------|-----|---|
| 0466344 | | | A2356NU | stuk | 41,75 | 179 | 1 |
|---------|--|--|---------|------|-------|-----|---|

inbouwdeel draadaansluiting 1/2" rubber









| | | | | | | | |
|---------|--|--|---------|------|-------|-----|---|
| 0466352 | | | A2355NU | stuk | 42,75 | 179 | 1 |
|---------|--|--|---------|------|-------|-----|---|

inbouwdeel draadaansluiting 3/4" rubber

| | | | | | | | |
|---------|--|--|---------|------|-------|-----|---|
| 0466360 | | | A2359NU | stuk | 53,50 | 179 | 1 |
|---------|--|--|---------|------|-------|-----|---|

set voor te diepe inbouw, maximaal 20mm

| | | | | | | | |
|---------|--|--|-----------|------|-------|-----|---|
| 0466379 | | | A963560NU | stuk | 53,50 | 179 | 1 |
|---------|--|--|-----------|------|-------|-----|---|

| | Art.nr | Specificaties | Kleur | Lev.nr | Ehd | Prijs | Grp | CC |
|---|---|--|-----------|-----------|--------|--------|-----|----|
| Sanitair producten | Ideal Standard CeraTherm Universeel | | | | | | | |
| | | inbouwdeel 3-wegomstelling | | | | | | |
| | 0466409 | | | A2391NU | stuk | 90,50 | 179 | 1 |
| Baden / douchebakken / stoomcabines | | inbouwdeel 2-wegomstelling | | | | | | |
| | 0466417 | | | A2393NU | stuk | 90,50 | 179 | 1 |
| | | verlengset voor te vlakke inbouw 20mm | | | | | | |
| 0466484 | | | A963436AA | stuk | 124,00 | 179 | 1 | |
| Kranen | | set voor te diepe inbouw, maximaal 20mm | | | | | | |
| | 0466492 | | | A963434NU | stuk | 82,00 | 179 | 1 |
| | 0466395 | | | A963554NU | stuk | 29,50 | 179 | 1 |
| Douchegarnituur | Ideal Standard Dualux | | | | | | | |
| |  | toiletkraan m. straalregelaar koud | | | | | | |
| 0461125 | | chroom | A2983AA | stuk | 92,00 | 179 | 0 | |
| Accessoires en spiegels | Ideal Standard Tonic | | | | | | | |
| Douchewanden |  | wastafelkraan m. waste | | | | | | |
| | 0180056 | | chroom | A5070AA | stuk | 175,00 | 179 | 1 |
| Toebehoren & afvoeren |  | bidetkraan m. waste | | | | | | |
| 0180057 | | chroom | A5072AA | stuk | 178,00 | 179 | 1 | |
| Spoel- & installatiesystemen |  | badkraan m. omstel m. koppelingen | | | | | | |
| 0180059 | | chroom | A5073AA | stuk | 256,00 | 179 | 1 | |
| Badkamermeubelen en toiletkasten |  | douchekraan m. koppelingen | | | | | | |
| 0180058 | | chroom | A5076AA | stuk | 213,00 | 179 | 1 | |
| Gootstenen en wastroggen |  | badthermostaat m. koppelingen | | | | | | |
| 0180043 | | chroom | A5151AA | stuk | 367,00 | 179 | 1 | |
| Utiliteit |  | douchethermostaat m. koppelingen | | | | | | |
| | 0180044 | | chroom | A5152AA | stuk | 301,00 | 179 | 1 |
| | Ideal Standard Venice | | | | | | | |
| |  | wastafelkraan laag model m. waste | | | | | | |
| 0180045 | | chroom | A5350AA | stuk | 381,00 | 179 | 1 | |

| Art.nr | Specificaties | Kleur | Lev.nr | Ehd | Prijs | Grp | CC |
|---------------------------------------|---------------|--------|---------|------|--------|-----|----|
| Ideal Standard Venice | | | | | | | |
| bidetkraan m. waste 0180046 | | chroom | A5355AA | stuk | 438,00 | 179 | 1 |
| badthermostaat 0180032 | | chroom | A5370AA | stuk | 660,00 | 179 | 1 |
| douchethermostaat 0180033 | | chroom | A5371AA | stuk | 610,00 | 179 | 1 |



Sanitair producten

Baden /
douchebakken /
stoomcabines

Kranen





Douchegarnituur

Accessoires en
spiegels

Douchewanden

Toebehoren &
afvoerenSpoel- &
installatiesystemenBadkamermeubelen
en toiletkastenGootstenen en
wastroggen

Utiliteit

| | Art.nr | Specificaties | Kleur | Lev.nr | Ehd | Prijs | Grp | CC |
|---|---|---|------------------------------------|---------|---------|--------|--------|-------|
| Sanitair producten | Jado Geometry | | | | | | | |
| | douchethermostaat HOH=15cm m. koppelingen | | | | | | | |
| | | 0420011 | | chroom | F1245AA | stuk | 309,00 | 219 0 |
| | | 0424471 | | steel | F1578XJ | stuk | 457,00 | 219 1 |
| | | 0424501 | baduitloop 3/4"x1/2" steel | | F1104XJ | stuk | 138,00 | 219 1 |
| | | 0424919 | doucheset steel | | F1652XJ | stuk | 396,00 | 219 1 |
| Baden / douchebakken / stoomcabines | | 0424935 | glijstangset compleet steel | | F1323XJ | stuk | 567,00 | 219 1 |
| | | 0770752 | Montagebeugel messing 2x15 mmx1/2" | | 0770752 | stuk | 5,90 | 475 0 |
| | toiletkraan hoog model | | | | | | | |
| | 0424626 | | chroom | F1252AA | stuk | 164,00 | 219 0 | |
| | 0424669 | | steel | F1598XJ | stuk | 234,00 | 219 1 | |
| Kranen | 1-gats wastafelkraan | | | | | | | |
| |  | 0424420 | m. waste | chroom | F1269AA | stuk | 289,00 | 219 0 |
| | | 0424439 | m. waste | steel | F1296XJ | stuk | 420,00 | 219 1 |
| | | 0425275 | z. waste | chroom | F1271AA | stuk | 263,00 | 219 0 |
| | | 0425273 | z. waste | steel | F1271XJ | stuk | 381,00 | 219 1 |
| 1-gats wastafelkraan m. hoge uitloop | | | | | | | | |
| Accessoires en spiegels | | 0424455 | m. waste | chroom | F1276AA | stuk | 309,00 | 219 0 |
| | | 0424463 | m. waste | steel | F1276XJ | stuk | 449,00 | 219 1 |
| | | 0425230 | z. waste | steel | F1277XJ | stuk | 417,00 | 219 1 |
| | | 0425257 | z. waste | chroom | F1277AA | stuk | 288,00 | 219 0 |
| Douchewanden | 1-gats bidetkraan m. waste | | | | | | | |
| |  | 0425222 | | chroom | F1273AA | stuk | 330,00 | 219 1 |
| 0425214 | | | steel | F1273XJ | stuk | 478,00 | 219 1 | |
| Toebehoren & afvoeren | wandkraan 1/2" m. koppelingen z. onderuitloop | | | | | | | |
| |  | 0425168 | | chroom | F1243AA | stuk | 188,00 | 219 0 |
| 0425133 | | | steel | F1243XJ | stuk | 282,00 | 219 1 | |
| Badkamermeubelen en toiletkasten | wandkraan 1/2" m. koppelingen z. bovenuitloop | | | | | | | |
| |  | 0425184 | | chroom | F1244AA | stuk | 188,00 | 219 1 |
| 0425176 | | | steel | F1638XJ | stuk | 282,00 | 219 1 | |
| Gootstenen en wastroggen | wandthermostaat 1/2" m. onderaansluiting | | | | | | | |
| | | 0424627 | m. koppelingen | chroom | F4063AA | stuk | 339,00 | 219 0 |
| | | 0424628 | m. koppelingen | steel | F4063XJ | stuk | 482,00 | 219 1 |
| | wandthermostaat 1/2" m. bovenaansluiting | | | | | | | |
| | 0424629 | m. koppelingen | chroom | F4064AA | stuk | 339,00 | 219 1 | |
| | 0424630 | m. koppelingen | steel | F4064XJ | stuk | 482,00 | 219 1 | |
| Utiliteit | 1-gats wastafelkraan m. lage uitloop | | | | | | | |
| |  | 0425087 | m. waste | chroom | F1251AA | stuk | 234,00 | 219 1 |
| | | 0425079 | m. waste | steel | F1251XJ | stuk | 338,00 | 219 1 |
| | | 0425060 | z. waste | chroom | F1597AA | stuk | 199,00 | 219 1 |
| | | 0425052 | z. waste | steel | F1597XJ | stuk | 289,00 | 219 1 |
| | | 1-gats wastafelkraan m. hoge uitloop | | | | | | |
| | | 0424528 | m. waste | chroom | F1256AA | stuk | 273,00 | 219 0 |
| | 0424536 | m. waste | steel | F1256XJ | stuk | 396,00 | 219 1 | |
| | 0425044 | z. waste | chroom | F1603AA | stuk | 237,00 | 219 1 | |
| | 0425036 | z. waste | steel | F1603XJ | stuk | 343,00 | 219 1 | |
| 1-gats bidetkraan | | | | | | | | |
| | 0425028 | m. waste | chroom | F1253AA | stuk | 300,00 | 219 1 | |
| | 0424994 | m. waste | steel | F1253XJ | stuk | 435,00 | 219 1 | |

| Art.nr | Specificaties | Kleur | Lev.nr | Ehd | Prijs | Grp | CC |
|--------|---------------|-------|--------|-----|-------|-----|----|
|--------|---------------|-------|--------|-----|-------|-----|----|

Jado Geometry

1-gats wastafelkraan

| | | | | | | | |
|---------|----------|--------|---------|------|--------|-----|---|
| 0420009 | m. waste | chroom | F1283AA | stuk | 305,00 | 219 | 0 |
| 0424951 | z. waste | chroom | F1284AA | stuk | 279,00 | 219 | 0 |
| 0424636 | z. waste | RVS | F1284B4 | stuk | 440,00 | 219 | 1 |



Sanitair producten

Baden /
douchebakken /
stoomcabines

Kranen

verlengstuk voor 7138

| | | | | | | | |
|---------|--|--------|---------|------|--------|-----|---|
| 0420005 | | chroom | F1290AA | stuk | 124,00 | 219 | 1 |
| 0420006 | | RVS | F1290B4 | stuk | 159,00 | 219 | 1 |

1-gats wastafelkraan

| | | | | | | | |
|---------|----------|--------|---------|------|--------|-----|---|
| 0425923 | m. waste | chroom | F1293AA | stuk | 351,00 | 219 | 1 |
| 0425931 | z. waste | chroom | F1295AA | stuk | 320,00 | 219 | 1 |

Accessoires en
spiegels

Douchewanden

wastafelwandkraan m. 24mm uitloop 17cm

| | | | | | | | |
|---------|----------|--------|---------|------|--------|-----|---|
| 0424640 | 1-hendel | chroom | F1335AA | stuk | 471,00 | 219 | 1 |
|---------|----------|--------|---------|------|--------|-----|---|

Toebehoren &
afvoeren**wastafelwandkraan inbouw m. 24mm uitloop 17cm**

| | | | | | | | |
|---------|----------|--------|---------|------|--------|-----|---|
| 0424653 | 2-greeps | chroom | F1347AA | stuk | 703,00 | 219 | 1 |
|---------|----------|--------|---------|------|--------|-----|---|

keukenkraan inbouw m uitloop 24mm lang 20cm

| | | | | | | | |
|---------|--|--------|---------|------|--------|-----|---|
| 0424654 | | chroom | F1353AA | stuk | 705,00 | 219 | 1 |
|---------|--|--------|---------|------|--------|-----|---|

Badkamermeubelen
en toiletkastenGootstenen en
wastroggen**3-gats wastafelkraan**

| | | | | | | | |
|---------|----------|--------|---------|------|--------|-----|---|
| 0424655 | m. waste | chroom | F1261AA | stuk | 645,00 | 219 | 1 |
|---------|----------|--------|---------|------|--------|-----|---|

keukenkraan inbouw m uitloop

| | | | | | | | |
|---------|--|--------|---------|------|--------|-----|---|
| 0425974 | | chroom | F1354AA | stuk | 782,00 | 219 | 1 |
|---------|--|--------|---------|------|--------|-----|---|







Utiliteit

badkraan inbouw m. uitloop m. omstel z. garnituur

| | | | | | | | |
|---------|----------|--------|---------|------|--------|-----|---|
| 0425982 | 2-greeps | chroom | F1348AA | stuk | 793,00 | 219 | 1 |
|---------|----------|--------|---------|------|--------|-----|---|



| | Art.nr | Specificaties | Kleur | Lev.nr | Ehd | Prijs | Grp | CC |
|---|---|--|--------|---------|------|---------|-----|----|
| | Jado Geometry | | | | | | | |
| Sanitair producten |  | badkraan inbouw m. uitloop m. omstel m. garnituur 0425990 2-greeps | chroom | F1351AA | stuk | 993,00 | 219 | 1 |
| Baden / douchebakken / stoomcabines | | | | | | | | |
| Kranen |  | badkraan inbouw m. uitloop m. omstel z. garnituur 0424642 1-hendel | chroom | F1336AA | stuk | 513,00 | 219 | 1 |
| Douchegarnituur | | | | | | | | |
| | | badkraan inbouw m. uitloop m. omstel m. garnituur 0424645 1-hendel | chroom | F1339AA | stuk | 702,00 | 219 | 1 |
| Accessoires en spiegels | | douchekraan inbouw m. hoofddouche m. handdouche 0424650 1-hendel | chroom | F1609AA | stuk | 1296,00 | 219 | 1 |
| Douchewanden | | badkraan inbouw m. uitloop m. hoofddouche 0424651 1-hendel | chroom | F1611AA | stuk | 1106,00 | 219 | 1 |
| | | badkraan inbouw m. uitloop m. omstel m. vaste hoofddouche m. handdouche 0424652 1-hendel | chroom | F1614AA | stuk | 1360,00 | 219 | 1 |
| Toebehoren & afvoeren | | 4-gats badrandcombinatie m. handdouche 0424656 2-greeps | chroom | F1264AA | stuk | 843,00 | 219 | 1 |
| Spoel- & installatiesystemen |  | douchekraan inbouw m. slangaansluiting 0426008 2-greeps | chroom | F1349AA | stuk | 693,00 | 219 | 1 |
| Badkamermeubelen en toiletkasten | | 0424643 1-hendel | chroom | F1337AA | stuk | 475,00 | 219 | 1 |
| Gootstenen en wastroggen |  | | | | | | | |
| Utiliteit |  | douchekraan inbouw m. garnituur 0424644 1-hendel | chroom | F1338AA | stuk | 663,00 | 219 | 1 |
| | | douchekraan inbouw m. hoofddouche 0424649 1-hendel | chroom | F1610AA | stuk | 641,00 | 219 | 1 |
| | | inbouwthermostaat 1/2" z. omstel 0426016 z. garnituur | chroom | F1361AA | stuk | 635,00 | 219 | 1 |
| | | badkraan inbouw aansluiting v. uitloop en douche 0426024 | chroom | F1355AA | stuk | 476,00 | 219 | 1 |

| Art.nr | Specificaties | Kleur | Lev.nr | Ehd | Prijs | Grp | CC |
|--------|---------------|-------|--------|-----|-------|-----|----|
|--------|---------------|-------|--------|-----|-------|-----|----|

Jado Geometry

douчекraan inbouw m. garnituur

| | | | | | | | |
|---------|----------|-------|---------|------|---------|-----|---|
| 0426032 | 2-greeps | chrom | F1350AA | stuk | 1026,00 | 219 | 1 |
|---------|----------|-------|---------|------|---------|-----|---|



Sanitair producten

Baden /
douchebakken /
stoomcabines**thermostaat inbouw z. omstel**

| | | | | | | | |
|---------|--------------|-------|---------|------|---------|-----|---|
| 0426040 | m. garnituur | chrom | F1373AA | stuk | 1085,00 | 219 | 1 |
|---------|--------------|-------|---------|------|---------|-----|---|

| | | | | | | | |
|---------|---------------------|-------|---------|------|--------|-----|---|
| 0426075 | m. slangaansluiting | chrom | F1622AA | stuk | 853,00 | 219 | 1 |
|---------|---------------------|-------|---------|------|--------|-----|---|



Kranen

Douche-garnituur

omstelrichting inbouw

| | | | | | | | |
|---------|--|-------|---------|------|--------|-----|---|
| 0426067 | | chrom | F1344AA | stuk | 249,00 | 219 | 1 |
|---------|--|-------|---------|------|--------|-----|---|

Accessoires en
spiegels

Douchewanden

inbouw omstelrichting 2-weg

| | | | | | | | |
|---------|--|-------|---------|------|--------|-----|---|
| 0420001 | | chrom | F1629AA | stuk | 249,00 | 219 | 1 |
|---------|--|-------|---------|------|--------|-----|---|

Toebehoren &
afvoeren**inbouwstopkraan 1/2"**

| | | | | | | | |
|---------|--|-------|---------|------|--------|-----|---|
| 0420002 | | chrom | F1630AA | stuk | 245,00 | 219 | 1 |
|---------|--|-------|---------|------|--------|-----|---|

inbouw slangaansluitstuk 1/2"

| | | | | | | | |
|---------|--|-------|---------|------|--------|-----|---|
| 0420003 | | chrom | F1631AA | stuk | 197,00 | 219 | 1 |
|---------|--|-------|---------|------|--------|-----|---|

Badkamermeubelen
en toiletkastenGootstenen en
wastroggen**toiletkraan**

| | | | | | | | |
|---------|--|-------|---------|------|--------|-----|---|
| 0424587 | | chrom | F1660AA | stuk | 231,00 | 219 | 1 |
|---------|--|-------|---------|------|--------|-----|---|



Utiliteit









1-gats wastafelkraan lage vaste uitloop





| | | | | | | | |
|---------|----------|-------|---------|------|--------|-----|---|
| 0424595 | m. waste | chrom | F2507AA | stuk | 375,00 | 219 | 1 |
|---------|----------|-------|---------|------|--------|-----|---|

**1-gats wastafelkraan hoge draaibare gebogen uitloop**

| | | | | | | | |
|---------|----------|-------|---------|------|--------|-----|---|
| 0424617 | m. waste | chrom | F2503AA | stuk | 378,00 | 219 | 1 |
|---------|----------|-------|---------|------|--------|-----|---|

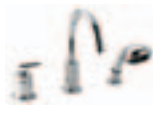

| | Art.nr | Specificaties | Kleur | Lev.nr | Ehd | Prijs | Grp | CC |
|---|---|--|----------|--------|---------|-------|--------|-------|
| | Jado Geometry | | | | | | | |
| Sanitair producten |  | 1-gats wastafelkraan hoge draaibare haakse uitloop 0424609 | m. waste | chroom | F2501AA | stuk | 416,00 | 219 1 |
| Baden / douchebakken / stoomcabines | | | | | | | | |
| Kranen |  | 1-gats wastafelkraan m. lage vaste uitloop 0424665 | z. waste | chroom | F2508AA | stuk | 354,00 | 219 1 |
| Douchegarnituur | | | | | | | | |
| | | 1-gats wastafelkraan m. hoge draaibare gebogen uitloop 0424667 | z. waste | chroom | F2515AA | stuk | 355,00 | 219 1 |
| Accessoires en spiegels |  | 1-gats wastafelkraan m. hoge draaibare haakse uitloop 0424666 | z. waste | chroom | F2504AA | stuk | 394,00 | 219 1 |
| Douchewanden | | | | | | | | |
| Toebehoren & afvoeren |  | 1-gats bidetkraan 0424676 | m. waste | chroom | F1297AA | stuk | 405,00 | 219 1 |
| Spoel- & installatiesystemen | | | | | | | | |
| Badkamermeubelen en toiletkasten |  | badkraan m. omstel m. koppelingen z. garnituur 0424668 | | chroom | F2502AA | stuk | 425,00 | 219 1 |
| Gootstenen en wastroggen |  | douchethermostaat 1/2" m. koppelingen 0424641 | | chroom | F2509AA | stuk | 472,00 | 219 1 |
| Utiliteit | Jado New Haven | | | | | | | |
| |  | 1-gats wastafelkraan 0530018 | m. waste | chroom | H2432AA | stuk | 342,00 | 219 1 |
| |  | 3-gats wastafelkraan 0530111 | | chroom | H2505AA | stuk | 553,00 | 219 1 |
| |  | 1-gats bidetkraan 0530026 | m. waste | chroom | H2441AA | stuk | 409,00 | 219 1 |

| Art.nr | Specificaties | Kleur | Lev.nr | Ehd | Prijs | Grp | CC | | |
|--|---------------|-------|-----------|------|---------|-----|----|--|---|
| | | | | | | | | Jado New Haven | |
| douчекraan z. omstel z. garnituur 0530085 | | chrom | H2514AA | stuk | 542,00 | 219 | 1 |  | Sanitair producten |
| badkraan m. omstel z. garnituur 0530109 | | chrom | H2519AA | stuk | 511,00 | 219 | 1 |  | Baden / douchebakken / stoomcabines |
| afbouwset voor 3-gats badrandcombinatie 0530042 | | chrom | H2457AA | stuk | 1132,00 | 219 | 1 |  | Douchegarnituur |
| afbouwset voor 4-gats badrandcombinatie 0530084 | | chrom | H2453AA | stuk | 1134,00 | 219 | 1 |  | Accessoires en spiegels |
| baduitloop 20cm 0530069 | | chrom | L4506AA | stuk | 295,00 | 219 | 1 |  | Douchewanden |
| | | | | | | | | Jado Universeel | |
| verhogingselement voor wastafelkraan 7001/7101 0424631 | | chrom | F1281AA | stuk | 124,00 | 219 | 1 | | Toebehoren & afvoeren |
| 0424632 | | steel | F1281XJ | stuk | 159,00 | 219 | 1 | | Spoel- & installatiesystemen |
| verhogingselement voor wastafelkraan 7000/7100 0425192 | | chrom | F1282AA | stuk | 124,00 | 219 | 1 | | Badkamermeubelen en toiletkasten |
| onderuitloop voor S1300 0425109 | | chrom | F1368AA | stuk | 83,50 | 219 | 1 | | Gootstenen en wastroggen |
| verhogingselement voor wastafelkraan 7000/7100 0425206 | | steel | F1282XJ | stuk | 159,00 | 219 | 1 | | Utiliteit |
| onderuitloop voor S1300 0425095 | | steel | F1368XJ | stuk | 145,00 | 219 | 1 | | |
| bovenuitloop voor S1350 0425125 | | chrom | F1369AA | stuk | 82,50 | 219 | 1 | | |
| 0425117 | | steel | F1369XJ | stuk | 138,00 | 219 | 1 | | |
| baduitloop 3/4"x1/2" 0424498 | | chrom | F1367AA | stuk | 103,00 | 219 | 0 | | |
| 0424501 | | steel | F1104XJ | stuk | 138,00 | 219 | 1 | | |
| 0420013 verloopnippel | | | F960240AA | stuk | 15,75 | 219 | 0 | | |
| verloopnippel 0420013 | | | F960240AA | stuk | 15,75 | 219 | 0 | | |

| | Art.nr | Specificaties | Kleur | Lev.nr | Ehd | Prijs | Grp | CC |
|---|-------------------|---|-------|-------------|------|--------|-----|----|
| Sanitair producten | Keuco Joly | | | | | | | |
| | | 1-gats wastafelkraan m. waste 0685992 | chrom | 51804010100 | stuk | 237,00 | 229 | 1 |
| Baden / douchebakken / stoomcabines | <hr/> | | | | | | | |
| Kranen | | fonteinkraan 0686018 | chrom | 51808010100 | stuk | 221,00 | 229 | 1 |
| | <hr/> | | | | | | | |
| Douchegarnituur | | | | | | | | |
| Accessoires en spiegels | | | | | | | | |
| Douchewanden | | | | | | | | |
| Toebehoren & afvoeren | | | | | | | | |
| Spoel- & installatiesystemen | | | | | | | | |
| Badkamermeubelen en toiletkasten | | | | | | | | |
| Gootstenen en wastroggen | | | | | | | | |
| Utiliteit | | | | | | | | |



Keuco Plan

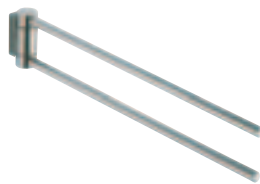

| | Art.nr | Specificaties | Kleur | Lev.nr | Ehd | Prijs | Grp | CC |
|---|---|--|-------|-------------|------|--------|-----|----|
| Sanitair producten | Keuco Plan | | | | | | | |
| |  | 1-gats wastafelkraan m. waste 0686026 | chrom | 54902010000 | stuk | 305,00 | 229 | 1 |
| Baden / douchebakken / stoomcabines |  | 1-gats wastafelkraan z. waste 0686020 | chrom | 54902010100 | stuk | 273,00 | 229 | 1 |
| Kranen |  | 1-gats fonteinkraan 0686034 | chrom | 54908010100 | stuk | 184,00 | 229 | 0 |
| Douchegarnituur |  | infrarood wastafelkraan m. batterij 6V 0686042 | chrom | 54911010100 | stuk | 706,00 | 229 | 1 |
| Accessoires en spiegels |  | infrarood wastafelkraan 230V 0686050 | chrom | 54912010100 | stuk | 787,00 | 229 | 1 |
| Douchewanden |  | infrarood wastafelkraan m. waste 6V 0686069 | chrom | 54911010000 | stuk | 781,00 | 229 | 1 |
| Toebehoren & afvoeren |  | 1-gats bidetkraan m. waste 0686022 | chrom | 54909010000 | stuk | 354,00 | 229 | 1 |
| Spoel- & installatiesystemen |  | badkraan m. omstel 0686024 | chrom | 54920010100 | stuk | 474,00 | 229 | 1 |
| Badkamermeubelen en toiletkasten |  | douchekraan 0686028 | chrom | 54924010100 | stuk | 374,00 | 229 | 1 |
| Gootstenen en wastroggen |  | douchethermostaat 0686030 | chrom | 54926010100 | stuk | 373,00 | 229 | 1 |
| Utiliteit | | | | | | | | |

| Art.nr | Specificaties | Kleur | Lev.nr | Ehd | Prijs | Grp | CC |
|---|----------------------------|-----------|-------------|------|--------|-----|----|
| Keuco Plan | | | | | | | |
| baduitloop | | | | | | | |
| 0686044 | 135mm | chroom | 54945010000 | stuk | 153,00 | 229 | 1 |
| 0686046 | 185mm | chroom | 54945010001 | stuk | 189,00 | 229 | 1 |
| slangaansluiting | | | | | | | |
| 0686062 | | chroom | 54947010000 | stuk | 71,00 | 229 | 1 |
| kleurset voor inbouwdouchekraan z. omstel | | | | | | | |
| 0686032 | | chroom | 54971010100 | stuk | 268,00 | 229 | 1 |
| 0684572 | universele I-box DN15/DN20 | | 54970000100 | stuk | 118,00 | 229 | 1 |
| kleurset voor inbouwbadkraan m. omstel | | | | | | | |
| 0686036 | | chroom | 54972010100 | stuk | 306,00 | 229 | 1 |
| 0684572 | universele I-box DN15/DN20 | | 54970000100 | stuk | 118,00 | 229 | 1 |
| kleurset voor inbouwthermostaat m. stopkraan | | | | | | | |
| 0686038 | | chroom | 54973010100 | stuk | 658,00 | 229 | 1 |
| 0684572 | universele I-box DN15/DN20 | | 54970000100 | stuk | 118,00 | 229 | 1 |
| kleurset voor inbouwthermostaat m. stopkraan m. omstel | | | | | | | |
| 0686040 | | chroom | 54974010100 | stuk | 738,00 | 229 | 1 |
| 0684572 | universele I-box DN15/DN20 | | 54970000100 | stuk | 118,00 | 229 | 1 |
| universele I-box DN15/DN20 | | | | | | | |
| 0684572 | | | 54970000100 | stuk | 118,00 | 229 | 1 |
| verleng rozet voor I-box | | | | | | | |
| 0684573 | | chroom | 54951010000 | stuk | 33,50 | 229 | 1 |
| 0684574 | | aluminium | 54951170000 | stuk | 43,25 | 229 | 1 |
| verlengset voor I-box 25mm | | | | | | | |
| 0684575 | | | 54970000001 | stuk | 36,00 | 229 | 1 |
| montagerailset voor I-box | | | | | | | |
| 0684576 | | | 54970000002 | stuk | 16,25 | 229 | 1 |



Sanitair producten

Baden /
douchebakken /
stoomcabines

Kranen

Douchegarnituur

Accessoires en
spiegels

Douchewanden

Toebehoren &
afvoerenSpoel- &
installatiesystemenBadkamermeubelen
en toiletkastenGootstenen en
wastroggen

Utiliteit

| | Art.nr | Specificaties | Kleur | Lev.nr | Ehd | Prijs | Grp | CC |
|---|---|--|-------|-----------|------|---------|-----|----|
| Sanitair producten | Kludi Adlon | | | | | | | |
| |  | toiletkraan 1/2" koud 0402680 | chrom | 510140520 | stuk | 113,00 | 187 | 1 |
| Baden / douchebakken / stoomcabines |  | 1-gats wastafelkraan 140mm m. waste m. vaste uitloop 0402664 | chrom | 510100520 | stuk | 656,00 | 187 | 1 |
| Kranen |  | 3-gats wastafelkraan m. waste m. vaste uitloop 0405345 | chrom | 510460520 | stuk | 720,00 | 187 | 1 |
| Douchegarnituur |  | 1-gats bidetkraan m. waste 0402796 | chrom | 512110520 | stuk | 526,00 | 187 | 1 |
| Accessoires en spiegels |  | douchekraan HOH=15cm m. koppelingen z. omstel 0402788 | chrom | 516100520 | stuk | 223,00 | 187 | 1 |
| Douchewanden |  | badkraan m. koppelingen m. omstel m. garnituur 0402761 | chrom | 514410520 | stuk | 530,00 | 187 | 1 |
| Toebehoren & afvoeren |  | 4-gats badkraan m. uittrekbare handdouche m. uitloop 0402745 220mm | chrom | 515240520 | stuk | 1625,00 | 187 | 1 |
| Spoel- & installatiesystemen |  | hoekstopkraan 0402702 1/2"x10mm | chrom | 518430520 | stuk | 99,00 | 187 | 1 |
| Badkamermeubelen en toiletkasten | Kludi Almera | | | | | | | |
| Gootstenen en wastroggen |  | 1-gats wastafelkraan m. waste 0407381 | chrom | 333810581 | stuk | 145,00 | 187 | 1 |
| |  | 1-gats bidetkraan m. waste 0407382 | chrom | 332310581 | stuk | 178,00 | 187 | 1 |
| Utiliteit | | | | | | | | |

| Art.nr | Specificaties | Kleur | Lev.nr | Ehd | Prijs | Grp | CC |
|--------|---------------|-------|--------|-----|-------|-----|----|
|--------|---------------|-------|--------|-----|-------|-----|----|

Kludi Almera

douчекraan HOH=15cm m. koppelingen

| | | | | | | | |
|---------|--|-------|-----------|------|--------|-----|---|
| 0407384 | | chrom | 338510581 | stuk | 128,00 | 187 | 1 |
|---------|--|-------|-----------|------|--------|-----|---|



Sanitair producten

Baden /
douchebakken /
stoomcabines**badkraan HOH=15cm m. omstel m. koppelingen**

| | | | | | | | |
|---------|--|-------|-----------|------|--------|-----|---|
| 0407383 | | chrom | 336610581 | stuk | 183,00 | 187 | 1 |
|---------|--|-------|-----------|------|--------|-----|---|



Kranen

Douchegarnituur

douchethermostaat m. koppelingen

| | | | | | | | |
|---------|--|-------|-----------|------|--------|-----|---|
| 0407387 | | chrom | 352000581 | stuk | 171,00 | 187 | 1 |
|---------|--|-------|-----------|------|--------|-----|---|

Accessoires en
spiegels**afbouwset voor inbouwbadkraan m. omstel**

| | | | | | | | |
|---------|--|-------|-----------|------|-------|-----|---|
| 0407385 | | chrom | 335190581 | stuk | 77,50 | 187 | 1 |
|---------|--|-------|-----------|------|-------|-----|---|

| | | | | | | | |
|---------|---------------------------------------|--|-------|------|--------|-----|---|
| 0400069 | inbouwset voor inbouwkraan universeel | | 33434 | stuk | 122,00 | 187 | 1 |
|---------|---------------------------------------|--|-------|------|--------|-----|---|



Douchewanden

Toebehoren &
afvoeren**afbouwset voor inbouwdouчекraan**

| | | | | | | | |
|---------|--|-------|-----------|------|-------|-----|---|
| 0407386 | | chrom | 337220581 | stuk | 60,50 | 187 | 1 |
|---------|--|-------|-----------|------|-------|-----|---|

| | | | | | | | |
|---------|---------------------------------------|--|-------|------|--------|-----|---|
| 0400069 | inbouwset voor inbouwkraan universeel | | 33434 | stuk | 122,00 | 187 | 1 |
|---------|---------------------------------------|--|-------|------|--------|-----|---|

Spoel- &
installatiesystemenBadkamermeubelen
en toiletkasten

Kludi Amphora

1-gats wastafelkraan m. waste

| | | | | | | | |
|---------|--|-------|-----------|------|--------|-----|---|
| 0409722 | | chrom | 540230575 | stuk | 330,00 | 187 | 1 |
|---------|--|-------|-----------|------|--------|-----|---|

Gootstenen en
wastroggen

Utiliteit

1-gats wastafelkraan z. waste

| | | | | | | | |
|---------|--|-------|-----------|------|--------|-----|---|
| 0409726 | | chrom | 540260575 | stuk | 330,00 | 187 | 1 |
|---------|--|-------|-----------|------|--------|-----|---|









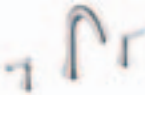
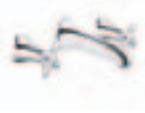

toiletkraan m. greep

| | | | | | | | |
|---------|--|-------|-----------|------|--------|-----|---|
| 0409720 | | chrom | 541160520 | stuk | 193,00 | 187 | 1 |
|---------|--|-------|-----------|------|--------|-----|---|

**1-gats wastafelkraan piccolo**

| | | | | | | | |
|---------|--|-------|-----------|------|--------|-----|---|
| 0409724 | | chrom | 541290575 | stuk | 314,00 | 187 | 1 |
|---------|--|-------|-----------|------|--------|-----|---|



| | Art.nr | Specificaties | Kleur | Lev.nr | Ehd | Prijs | Grp | CC |
|---|---|--|-------|-----------|------|--------|-----|----|
| | Kludi Amphora | | | | | | | |
| Sanitair producten |  | 3-gats wastafelkraan m. kruisgreep m. waste 0409708 | chrom | 541430520 | stuk | 530,00 | 187 | 1 |
| Baden / douchebakken / stoomcabines |  | 3-gats wastafelkraan m. rechte greep m. waste 0409710 | chrom | 541430575 | stuk | 530,00 | 187 | 1 |
| Kranen |  | 3-gats wandkraan voor wastafel met rugwand m. kruisgreep inbouw + afbouwdeel 0409712 | chrom | 541440520 | stuk | 533,00 | 187 | 1 |
| Douchegarnituur |  | 3-gats wandkraan voor wastafel met rugwand m. rechte greep inbouw + afbouwdeel 0409714 | chrom | 541440575 | stuk | 533,00 | 187 | 1 |
| Accessoires en spiegels |  | 3-gats wandkraan m. kruisgreep inbouw + afbouwdeel 0409716 | chrom | 541450520 | stuk | 612,00 | 187 | 1 |
| Douchewanden |  | 0409768 verstelbaar rozet 90mm chrom | chrom | 740090500 | stuk | 33,75 | 250 | 1 |
| Toebehoren & afvoeren |  | 3-gats wandkraan m. rechte greep inbouw + afbouwdeel 0409718 | chrom | 541450575 | stuk | 612,00 | 187 | 1 |
| Spoel- & installatiesystemen |  | 0409768 verstelbaar rozet 90mm chrom | chrom | 740090500 | stuk | 33,75 | 250 | 1 |
| Badkamermeubelen en toiletkasten | | 3-gats thermostatische wastafelkraan m. kruisgrepen 0400074 | chrom | 544120520 | stuk | 689,00 | 187 | 1 |
| Gootstenen en wastroggen |  | bidetkraan m. hendel 0409728 | chrom | 542160575 | stuk | 343,00 | 187 | 1 |
| Utiliteit |  | douchethermostaat 0409736 m. koppelingen | chrom | 544210538 | stuk | 481,00 | 218 | 1 |
| | | 0409738 z. koppelingen | chrom | 544230538 | stuk | 448,00 | 218 | 1 |
| | | 0409740 muurplaat voor 54423 messing | | 740293700 | stuk | 85,00 | 218 | 1 |
| |  | badkraan m. omstel 0409734 | chrom | 544430575 | stuk | 440,00 | 187 | 1 |
| |  | douchekraan z. omstel 0409732 | chrom | 547140575 | stuk | 377,00 | 187 | 1 |

| Art.nr | Specificaties | Kleur | Lev.nr | Ehd | Prijs | Grp | CC |
|--------|---------------|-------|--------|-----|-------|-----|----|
|--------|---------------|-------|--------|-----|-------|-----|----|

Kludi Amphora

4-gats badrandkraan m. kruisgrepen

| | | | | | | | |
|---------|------------------------------------|-------|-----------|------|---------|-----|---|
| 0400075 | | chrom | 544240520 | stuk | 1269,00 | 187 | 1 |
| 0400066 | montageplaat voor 4-gats kraan | | 761484600 | stuk | 175,00 | 187 | 1 |
| 0400067 | euro-montageblok voor 4-gats kraan | | 761500000 | stuk | 457,00 | 187 | 1 |
| 0400082 | zichtbare montageplaat chrom | | 1602105 | stuk | 250,00 | 187 | 1 |

Sanitair producten

Baden /
douchebakken /
stoomcabines**4-gats badrandkraan m. rechte grepen**

| | | | | | | | |
|---------|------------------------------------|-------|-----------|------|---------|-----|---|
| 0400077 | | chrom | 544240575 | stuk | 1269,00 | 187 | 1 |
| 0400066 | montageplaat voor 4-gats kraan | | 761484600 | stuk | 175,00 | 187 | 1 |
| 0400067 | euro-montageblok voor 4-gats kraan | | 761500000 | stuk | 457,00 | 187 | 1 |
| 0400082 | zichtbare montageplaat chrom | | 1602105 | stuk | 250,00 | 187 | 1 |

Kranen

Douchegarnituur

4-gats tegelrandkraan m. kruisgrepen

| | | | | | | | |
|---------|------------------------------------|-------|-----------|------|---------|-----|---|
| 0400078 | | chrom | 544250520 | stuk | 1316,00 | 187 | 1 |
| 0400066 | montageplaat voor 4-gats kraan | | 761484600 | stuk | 175,00 | 187 | 1 |
| 0400067 | euro-montageblok voor 4-gats kraan | | 761500000 | stuk | 457,00 | 187 | 1 |
| 0400082 | zichtbare montageplaat chrom | | 1602105 | stuk | 250,00 | 187 | 1 |

Accessoires en
spiegels**4-gats tegelrandkraan m. rechte grepen**

| | | | | | | | |
|---------|------------------------------------|-------|-----------|------|---------|-----|---|
| 0400079 | | chrom | 544250575 | stuk | 1316,00 | 187 | 1 |
| 0400066 | montageplaat voor 4-gats kraan | | 761484600 | stuk | 175,00 | 187 | 1 |
| 0400067 | euro-montageblok voor 4-gats kraan | | 761500000 | stuk | 457,00 | 187 | 1 |
| 0400082 | zichtbare montageplaat chrom | | 1602105 | stuk | 250,00 | 187 | 1 |

Douchewanden

Toebehoren &
afvoeren**4-gats badrandkraan z. uitloop m. kruisgrepen**

| | | | | | | | |
|---------|------------------------------------|-------|-----------|------|---------|-----|---|
| 0400080 | | chrom | 545260520 | stuk | 1052,00 | 187 | 1 |
| 0400066 | montageplaat voor 4-gats kraan | | 761484600 | stuk | 175,00 | 187 | 1 |
| 0400067 | euro-montageblok voor 4-gats kraan | | 761500000 | stuk | 457,00 | 187 | 1 |
| 0400082 | zichtbare montageplaat chrom | | 1602105 | stuk | 250,00 | 187 | 1 |

Spoel- &
installatiesystemenBadkamermeubelen
en toiletkasten**4-gats badrandkraan z. uitloop m. rechte grepen**

| | | | | | | | |
|---------|------------------------------------|-------|-----------|------|---------|-----|---|
| 0400081 | | chrom | 545260575 | stuk | 1052,00 | 187 | 1 |
| 0400066 | montageplaat voor 4-gats kraan | | 761484600 | stuk | 175,00 | 187 | 1 |
| 0400067 | euro-montageblok voor 4-gats kraan | | 761500000 | stuk | 457,00 | 187 | 1 |
| 0400082 | zichtbare montageplaat chrom | | 1602105 | stuk | 250,00 | 187 | 1 |

Gootstenen en
wastroggen

Utiliteit

variabele baduitloop 3/4









| | | | | | | | |
|---------|--|-------|---------|------|--------|-----|---|
| 0409754 | | chrom | 5450405 | stuk | 206,00 | 187 | 1 |
|---------|--|-------|---------|------|--------|-----|---|

afbouwdeel stopkraan m. kruisgreep

| | | | | | | | |
|---------|-------------------------------|-------|-----------|------|--------|-----|---|
| 0409750 | | chrom | 548150520 | stuk | 100,00 | 187 | 1 |
| 0409746 | inbouwdeel voor stopkraan 1/2 | | 54809 | stuk | 41,75 | 187 | 1 |
| 0409748 | inbouwdeel voor stopkraan 3/4 | | 54811 | stuk | 60,50 | 187 | 1 |
| 0409768 | verstelbaar rozet 90mm chrom | | 740090500 | stuk | 33,75 | 250 | 1 |

afbouwdeel stopkraan m. rechte greep

| | | | | | | | |
|---------|-------------------------------|-------|-----------|------|--------|-----|---|
| 0409752 | | chrom | 548150575 | stuk | 100,00 | 187 | 1 |
| 0409746 | inbouwdeel voor stopkraan 1/2 | | 54809 | stuk | 41,75 | 187 | 1 |
| 0409748 | inbouwdeel voor stopkraan 3/4 | | 54811 | stuk | 60,50 | 187 | 1 |
| 0409768 | verstelbaar rozet 90mm chrom | | 740090500 | stuk | 33,75 | 250 | 1 |

| | Art.nr | Specificaties | Kleur | Lev.nr | Ehd | Prijs | Grp | CC |
|---|---|--|---------|-----------|------|--------|-----|----|
| Sanitair producten | Kludi Amphora | | | | | | | |
| | | hoekstopkraan m. rechte greep | | | | | | |
| | 0409730 | | chrom | 548430520 | stuk | 67,50 | 187 | 1 |
| Baden / douchebakken / stoomcabines |  | | | | | | | |
| Kranen | afbouwdeel 2-weg omstelling | | | | | | | |
| | 0409744 | | | 548450538 | stuk | 115,00 | 218 | 1 |
| | 0409742 | inbouwdeel 2-weg omstelling | | 54751 | stuk | 180,00 | 218 | 1 |
| | 0409768 | verstelbaar rozet 90mm chrom | | 740090500 | stuk | 33,75 | 250 | 1 |
| |  | | | | | | | |
| Douchegarnituur | verstelbaar rozet 90mm | | | | | | | |
| | 0409768 | | chrom | 740090500 | stuk | 33,75 | 250 | 1 |
| |  | | | | | | | |
| Accessoires en spiegels | muurplaat voor 54423 | | | | | | | |
| | 0409740 | | messing | 740293700 | stuk | 85,00 | 218 | 1 |
| |  | | | | | | | |
| Douchewanden | inbouwdeel voor stopkraan 1/2 | | | | | | | |
| | 0409746 | | | 54809 | stuk | 41,75 | 187 | 1 |
| |  | | | | | | | |
| Toebehoren & afvoeren | inbouwdeel voor stopkraan 3/4 | | | | | | | |
| | 0409748 | | | 54811 | stuk | 60,50 | 187 | 1 |
| |  | | | | | | | |
| Spoel- & installatiesystemen | inbouwdeel 2-weg omstelling | | | | | | | |
| | 0409742 | | | 54751 | stuk | 180,00 | 218 | 1 |
| |  | | | | | | | |
| Badkamermeubelen en toiletkasten | Kludi Bingo Star | | | | | | | |
| | | 1-gats wastafelkraan | | | | | | |
| | 0400120 | | chrom | 420230575 | stuk | 190,00 | 187 | 0 |
| |  | | | | | | | |
| Gootstenen en wastroggen | Kludi Evita Design | | | | | | | |
| | | inbouwdeel voor inbouwthermostaat | | | | | | |
| | 0408271 | | | 35424 | stuk | 191,00 | 187 | 1 |
| |  | | | | | | | |
| Utiliteit | | | | | | | | |

| Art.nr | Specificaties | Kleur | Lev.nr | Ehd | Prijs | Grp | CC |
|--------|---------------|-------|--------|-----|-------|-----|----|
|--------|---------------|-------|--------|-----|-------|-----|----|

Kludi Evita Classic

wastafelkraan thermostatisch m. waste

0407194

chrom

357330566

stuk

350,00

187

1



Sanitair producten

wastafelkraan thermostatisch m. uittrekbare uitloop m. waste

0406988

chrom

357830566

stuk

429,00

187

1

Baden /
douchebakken /
stoomcabines

Kranen

bidetkraan thermostatisch m. waste

0406996

chrom

352210566

stuk

437,00

187

1



Douchegarnituur

Accessoires en
spiegels**badthermostaat m. koppelingen**

0407003

chrom

354540566

stuk

455,00

187

1



Douchewanden

douchethermostaat m. koppelingen

0407011

chrom

357140566

stuk

315,00

187

1

Toebehoren &
afvoerenSpoel- &
installatiesystemen**afbouwset voor inbouwthermostaat m. omstel**

0408263

chrom

354150566

stuk

185,00

187

1

0408271 inbouwdeel voor inbouwthermostaat

35424

stuk

191,00

187

1

Badkamermeubelen
en toiletkasten**afbouwset voor inbouwthermostaat z. omstel**

0408328

chrom

356170566

stuk

162,00

187

1

0408271 inbouwdeel voor inbouwthermostaat

35424

stuk

191,00

187

1

Gootstenen en
wastroggen

Utiliteit

Kludi Logomix

1-gats wastafelkraan m. inzinkbare ketting

0404146

chrom

382800575

stuk

73,00

187

0

**1-gats wastafelkraan m. waste**

0404154

chrom

382810575









stuk

85,50

187

0



| | Art.nr | Specificaties | Kleur | Lev.nr | Ehd | Prijs | Grp | CC |
|---|---|--------------------------------------|---------------|-----------|-----------|--------|--------|-----|
| Sanitair producten | Kludi Logomix | | | | | | | |
| |  | 1-gats bidetkraan m. waste | | | | | | |
| 0404160 | | | chrom | 385310575 | stuk | 98,00 | 187 | 1 |
| Baden / douchebakken / stoomcabines | | | | | | | | |
| Kranen | douchekraan m. koppelingen z. omstel | | | | | | | |
| |  | 0404182 | | chrom | 388410575 | stuk | 76,50 | 187 |
| | | | | | | | | |
| Douchegarnituur | | | | | | | | |
| Accessoires en spiegels | badkraan m. omstel m. koppelingen | | | | | | | |
| |  | 0404189 | | chrom | 386810575 | stuk | 99,00 | 187 |
| | | | | | | | | |
| Douchewanden | | | | | | | | |
| Toebehoren & afvoeren | opbouwdeel voor inbouwdouchekraan | | | | | | | |
| |  | 0404071 | | chrom | 388210575 | stuk | 54,50 | 187 |
| 0404101 | | inbouwdeel voor inbouwdouchekraan | | | 38826 | stuk | 70,50 | 187 |
| Spoel- & installatiesystemen | | | | | | | | |
| Badkamermeubelen en toiletkasten | opbouwdeel voor inbouwbadkraan m. omstel | | | | | | | |
| |  | 0404098 | | chrom | 386190575 | stuk | 68,50 | 187 |
| 0404128 | | inbouwdeel voor inbouwbadkraan | | | 38624 | stuk | 106,00 | 187 |
| | | | | | | | | |
| Gootstenen en wastroggen | Kludi Joop | | | | | | | |
| |  | 1-gats wastafelkraan z. waste | | | | | | |
| 0412997 | | | chrom | 550290505 | stuk | 423,00 | 183 | 1 |
| | 0412998 | | chrom/velours | 550298005 | stuk | 423,00 | 183 | 1 |
| | 0412999 | | chrom/glas | 55029H705 | stuk | 483,00 | 183 | 1 |
| Utiliteit | | | | | | | | |
| | | | | | | | | |
| 1-gats wastafelkraan m. waste 1/2" | | | | | | | | |
| | 0409820 | | verchromd | 550230505 | stuk | 423,00 | 183 | 1 |
| | 0409839 | | chrom/velours | 550238005 | stuk | 423,00 | 183 | 1 |
| | 0409847 | | chrom/glas | 55023H705 | stuk | 483,00 | 183 | 1 |
| | | | | | | | | |
| 3-gats wastafelkraan m. waste 1/2" | | | | | | | | |
|  | 0409936 | | verchromd | 551430505 | stuk | 662,00 | 183 | 1 |
| | 0409944 | | chrom/velours | 551438005 | stuk | 662,00 | 183 | 1 |
| | 0409952 | | chrom/glas | 55143H705 | stuk | 782,00 | 183 | 1 |
| | | | | | | | | |
| 3-gats inbouwwandkraan 1/2" inbouw + afbouwdeel | | | | | | | | |
|  | 0409960 | | verchromd | 551460505 | stuk | 654,00 | 183 | 1 |
| | 0409979 | | chrom/velours | 551468005 | stuk | 654,00 | 183 | 1 |
| | 0409987 | | chrom/glas | 55146H705 | stuk | 774,00 | 183 | 1 |
| | | | | | | | | |
| 3-gats inbouwwandkraan voor rugwand inbouw + afbouwdeel | | | | | | | | |
| | 0400065 | | chrom | 551450505 | stuk | 679,00 | 187 | 1 |

| Art.nr | Specificaties | Kleur | Lev.nr | Ehd | Prijs | Grp | CC |
|--------|---------------|-------|--------|-----|-------|-----|----|
|--------|---------------|-------|--------|-----|-------|-----|----|

Kludi Joop

bidetkraan m. waste 1/2"

| | | | | | | | |
|---------|--|---------------|-----------|------|--------|-----|---|
| 0412325 | | verchromd | 552160505 | stuk | 444,00 | 183 | 1 |
| 0412333 | | chrom/velours | 552168005 | stuk | 444,00 | 183 | 1 |
| 0412341 | | chrom/glas | 55216H705 | stuk | 504,00 | 183 | 1 |



Sanitair producten

Baden /
douchebakken /
stoomcabines**douchekraan 1/2"**

| | | | | | | | |
|---------|--|---------------|-----------|------|--------|-----|---|
| 0412368 | | verchromd | 554230575 | stuk | 467,00 | 183 | 1 |
| 0412376 | | chrom/velours | 554238075 | stuk | 467,00 | 183 | 1 |
| 0412384 | | chrom/glas | 55423H775 | stuk | 537,00 | 183 | 1 |



Kranen

afbouwset voor inbouwdouchekraan

| | | | | | | | |
|---------|---------------------------------------|-------|-----------|------|--------|-----|---|
| 0400071 | | chrom | 557180575 | stuk | 234,00 | 187 | 1 |
| 0400069 | inbouwset voor inbouwkraan universeel | | 33434 | stuk | 122,00 | 187 | 1 |

Douchegarnituur

afbouwset voor inbouw bad-/douchekraan

| | | | | | | | |
|---------|---------------------------------------|-------|-----------|------|--------|-----|---|
| 0400070 | | chrom | 555150575 | stuk | 263,00 | 187 | 1 |
| 0400069 | inbouwset voor inbouwkraan universeel | | 33434 | stuk | 122,00 | 187 | 1 |

Accessoires en
spiegels**badkraan 1/2"**

| | | | | | | | |
|---------|--|---------------|-----------|------|--------|-----|---|
| 0412392 | | verchromd | 554430575 | stuk | 579,00 | 183 | 1 |
| 0412406 | | chrom/velours | 554438075 | stuk | 579,00 | 183 | 1 |
| 0412414 | | chrom/glas | 55443H775 | stuk | 639,00 | 183 | 1 |



Douchewanden

4-gats badrandkraan

| | | | | | | | |
|---------|------------------------------------|---------------|-----------|------|---------|-----|---|
| 0413000 | | chrom | 554240505 | stuk | 1722,00 | 183 | 1 |
| 0413001 | | chrom/velours | 554248005 | stuk | 1722,00 | 183 | 1 |
| 0413002 | | chrom/glas | 55424H705 | stuk | 1798,00 | 183 | 1 |
| 0400066 | montageplaat voor 4-gats kraan | | 761484600 | stuk | 175,00 | 187 | 1 |
| 0400067 | euro-montageblok voor 4-gats kraan | | 761500000 | stuk | 457,00 | 187 | 1 |
| 0400082 | zichtbare montageplaat chrom | | 1602105 | stuk | 250,00 | 187 | 1 |

Toebehoren &
afvoerenSpoel- &
installatiesystemen**4-gats tegelrandkraan**

| | | | | | | | |
|---------|------------------------------------|---------------|-----------|------|---------|-----|---|
| 0413003 | | chrom | 554250505 | stuk | 1731,00 | 183 | 1 |
| 0413004 | | chrom/velours | 554258005 | stuk | 1731,00 | 183 | 1 |
| 0413005 | | chrom/glas | 55425H705 | stuk | 1851,00 | 183 | 1 |
| 0400066 | montageplaat voor 4-gats kraan | | 761484600 | stuk | 175,00 | 187 | 1 |
| 0400067 | euro-montageblok voor 4-gats kraan | | 761500000 | stuk | 457,00 | 187 | 1 |
| 0400082 | zichtbare montageplaat chrom | | 1602105 | stuk | 250,00 | 187 | 1 |

Badkamermeubelen
en toiletkasten**4-gats bad-/douchekraan z. uitloop**

| | | | | | | | |
|---------|--|-------|-----------|------|---------|-----|---|
| 0400111 | | chrom | 554260505 | stuk | 1159,00 | 187 | 1 |
|---------|--|-------|-----------|------|---------|-----|---|

Gootstenen en
wastroggen**baduitloop 26cm staande montage voor vrijstaande baden**

| | | | | | | | |
|---------|--|-------|---------|------|---------|-----|---|
| 0400108 | | chrom | 5550605 | stuk | 1035,00 | 187 | 1 |
|---------|--|-------|---------|------|---------|-----|---|

Utiliteit

inbouwset voor bad-/douchekraan

| | | | | | | | |
|---------|--|-------|-----------|------|--------|-----|---|
| 0400107 | | chrom | 742700000 | stuk | 401,00 | 187 | 1 |
|---------|--|-------|-----------|------|--------|-----|---|

afbouwset voor inbouwthermostaat 1/2"

| | | | | | | | |
|---------|----------------------------------|---------------|-----------|------|--------|-----|---|
| 0413007 | | chrom | 557190505 | stuk | 243,00 | 183 | 1 |
| 0413008 | | chrom/velours | 557198005 | stuk | 243,00 | 183 | 1 |
| 0409014 | inbouwdeel thermostaatkraan 3/4" | | 35093 | stuk | 526,00 | 187 | 1 |

**baduitloop 3/4"**

| | | | | | | | |
|---------|------|-------|---------|------|--------|-----|---|
| 0413009 | 17cm | chrom | 5550205 | stuk | 299,00 | 183 | 1 |
| 0413010 | 22cm | chrom | 5550305 | stuk | 318,00 | 183 | 1 |



| | Art.nr | Specificaties | Kleur | Lev.nr | Ehd | Prijs | Grp | CC |
|---|-------------------|---|----------------|-----------|------|--------|-----|----|
| | Kludi Joop | | | | | | | |
| Sanitair producten | | afbouwdeel voor inbouwstopkraan m. greep | | | | | | |
| | | 0413012 | chroom | 558150505 | stuk | 124,00 | 183 | 1 |
| | | 0413013 | chroom/velours | 558158005 | stuk | 124,00 | 183 | 1 |
| | | 0413014 | chroom/glas | 55815H705 | stuk | 184,00 | 183 | 1 |
| Baden / douchebakken / stoomcabines | 0413011 | inbouwdeel voor inbouwstopkraan 3/4" | | 55811 | stuk | 57,00 | 183 | 1 |
| | | afbouwdeel voor afvoer- en overloopgarnituur | | | | | | |
| Kranen | 0409855 | | verchromd | 550560500 | stuk | 47,50 | 183 | 1 |
| | | afvoer- en overloopgarnituur voor Joop | | | | | | |
| Douchegarnituur | 0510362 | | chroom | 213530000 | stuk | 35,25 | 350 | 1 |
| | | inbouwdeel voor inbouwstopkraan 3/4" | | | | | | |
| Accessoires en spiegels | 0413011 | | | 55811 | stuk | 57,00 | 183 | 1 |
| | | hoekstopkraan 1/2" | | | | | | |
| Douchewanden | 0412449 | | verchromd | 558430505 | stuk | 81,50 | 183 | 1 |
| | | slangaansluitbocht | | | | | | |
| Toebehoren & afvoeren | 0412422 | | verchromd | 555410500 | stuk | 126,00 | 183 | 1 |
| | | wastafel afvoerplug 5/4" | | | | | | |
| Spoel- & installatiesystemen | 0409804 | | verchromd | 104230500 | stuk | 105,00 | 183 | 1 |
| | | bekersifon | | | | | | |
| Badkamermeubelen en toiletkasten | 0409812 | | verchromd | 550100500 | stuk | 151,00 | 183 | 1 |
| | | Gootstenen en wastroggen | | | | | | |
| Utiliteit | | Kludi Kido | | | | | | |
| | | wastafelkraan m. waste | | | | | | |
| | 0300767 | | chroom | 391250575 | stuk | 229,00 | 187 | 1 |
| | | wastafelkraan m. waste voor lagedruk boiler | | | | | | |
| | 0300770 | | chroom | 391350575 | stuk | 275,00 | 187 | 1 |
| | | wastafelkraan z. waste | | | | | | |
| | 0300768 | | chroom | 391260575 | stuk | 222,00 | 187 | 1 |

| Art.nr | Specificaties | Kleur | Lev.nr | Ehd | Prijs | Grp | CC | | |
|--|---------------|-------|-----------|------|--------|-----|----|---|---|
| | | | | | | | | Kludi Kido | |
| fonteinkraan m. waste 0300769 | | chrom | 391290575 | stuk | 225,00 | 187 | 1 |  | Sanitair producten |
| bidetkraan m. waste 0300772 | | chrom | 392150575 | stuk | 241,00 | 187 | 1 |  | Baden / douchebakken / stoomcabines |
| badkraan m. omstel 0300774 | | chrom | 394450575 | stuk | 295,00 | 187 | 1 |  | Kranen |
| douchekraan z. omstel 0300779 | | chrom | 397140575 | stuk | 251,00 | 187 | 1 |  | Douchegarnituur |
| douchethermostaat HOH=15cm 0300773 | | chrom | 394210575 | stuk | 460,00 | 187 | 1 |  | Accessoires en spiegels |
| variabele baduitloop 3/4" 0300775 | | chrom | 3950405 | stuk | 180,00 | 187 | 1 |  | Douchewanden |
| inbouwdeel voor inbouwstopkraan 0300784 1/2" | | | 39809 | stuk | 42,50 | 187 | 1 | | Toebehoren & afvoeren |
| 0300785 3/4" | | | 39811 | stuk | 61,50 | 187 | 1 | | Spoel- & installatiesystemen |
| 0300786 afbouwdeel voor inbouwstopkraan chrom | | | 398150575 | stuk | 84,50 | 187 | 1 | | Badkamermeubelen en toiletkasten |
| afbouwdeel voor inbouwstopkraan 0300786 | | chrom | 398150575 | stuk | 84,50 | 187 | 1 |  | Gootstenen en wastroggen |
| afbouwdeel voor inbouw badkraan 0300776 | | chrom | 395350575 | stuk | 145,00 | 187 | 1 | | Utiliteit |
| 0400069 inbouwset voor inbouwkraan universeel | | | 33434 | stuk | 122,00 | 187 | 1 | | |
| 0400112 Flexboxx universeel inbouwdeel DN20 | | | 88077 | stuk | 172,00 | 187 | 1 |  | |

| | Art.nr | Specificaties | Kleur | Lev.nr | Ehd | Prijs | Grp | CC |
|---|--|--|-------|-----------|------|--------|-----|----|
| | Kludi Kido | | | | | | | |
| | afbouwdeel voor inbouw douchekraan | | | | | | | |
| Sanitair producten | 0300781 | | chrom | 397160575 | stuk | 121,00 | 187 | 1 |
| | 0400069 | inbouwset voor inbouwkraan universeel | | 33434 | stuk | 122,00 | 187 | 1 |
| | 0400112 | Flexboxx universeel inbouwdeel DN20 | | 88077 | stuk | 172,00 | 187 | 1 |
| Baden / douchebakken / stoomcabines | | | | | | | | |
| | afbouwdeel voor inbouwthermostaat | | | | | | | |
| Kranen | 0300782 | | chrom | 397190575 | stuk | 168,00 | 187 | 1 |
| | 0400807 | inbouwdeel 1/2" voor thermostaat z. omstel | | 35158 | stuk | 171,00 | 218 | 1 |
| | 0409014 | inbouwdeel thermostaatkraan 3/4" | | 35093 | stuk | 526,00 | 187 | 1 |
| Douchegarnituur | | | | | | | | |
| | Flexboxx universeel inbouwdeel DN20 | | | | | | | |
| | 0400112 | | | 88077 | stuk | 172,00 | 187 | 1 |
| Accessoires en spiegels | 0400113 | Flexboxx verlenging voor 88077 20mm chrom | | 744000500 | stuk | 63,50 | 187 | 1 |
| | 0400131 | Flexboxx spoelset voor 88077 | | 744040000 | stuk | 59,00 | 187 | 1 |
| | Flexboxx verlenging voor 88077 | | | | | | | |
| | 0400113 | 20mm | chrom | 744000500 | stuk | 63,50 | 187 | 1 |
| Douchewanden | | | | | | | | |
| | Flexboxx spoelset voor 88077 | | | | | | | |
| | 0400131 | | | 744040000 | stuk | 59,00 | 187 | 1 |
| | Kludi Medi-Care | | | | | | | |
| | wastafelkraan m. waste m. L-hendel | | | | | | | |
| Toebehoren & afvoeren | 0407410 | | chrom | 332710564 | stuk | 175,00 | 187 | 1 |
| | 1-gats gootsteenkraan m. armhendel | | | | | | | |
| Spoel- & installatiesystemen | 0408409 | | chrom | 349080524 | stuk | 228,00 | 187 | 1 |
| Badkamermeubelen en toiletkasten | | | | | | | | |
| | 1-gats wastafelkraan m. armhendel | | | | | | | |
| | 0408379 | | chrom | 341120524 | stuk | 214,00 | 187 | 1 |
| Gootstenen en wastroggen | | | | | | | | |
| | 1-gats wastafelkraan m. draaibare uitloop | | | | | | | |
| Utiliteit | 0409634 | | chrom | 341130524 | stuk | 225,00 | 187 | 1 |
| | 1-gats wastafelkraan m. waste m. lange hendel | | | | | | | |
| | 0408395 | | chrom | 341150524 | stuk | 230,00 | 187 | 1 |
| | wandkraan m. draaibare uitloop | | | | | | | |
| | 0409642 | | chrom | 349220524 | stuk | 300,00 | 187 | 1 |

| Art.nr | Specificaties | Kleur | Lev.nr | Ehd | Prijs | Grp | CC |
|--------|---------------|-------|--------|-----|-------|-----|----|
|--------|---------------|-------|--------|-----|-------|-----|----|

Kludi Medi-Care

wandkraan m. armhendel 245mm

0409502

chrom

349200524

stuk

311,00

187

1



Sanitair producten

Baden /
douchebakken /
stoomcabines**wandkraan m. L-hendel 245mm m. koppelingen**

0409503

chrom

349210524

stuk

350,00

187

1



Kranen

Douchegarnituur

wandkraan m. draaibare uitloop 340mm

0409650

chrom

349240524

stuk

322,00

187

1

Accessoires en
spiegels**1-gats wastafelkraan m. draaibare uitloop 20cm**

0409669

chrom

349080534

stuk

252,00

187

1



Douchewanden

Toebehoren &
afvoeren**1-gats wastafelkraan m. uitloop 15cm**

0409677

chrom

341120534

stuk

239,00

187

1

Spoel- &
installatiesystemenBadkamermeubelen
en toiletkasten**1-gats wastafelkraan m. draaibare uitloop 15cm**

0409685

chrom

341130534

stuk

250,00

187

1

Gootstenen en
wastroggen**1-gats wastafelkraan m. waste m. uitloop 15cm**

0409693

chrom

341150534

stuk

241,00

187

1



Utiliteit

wandthermostaat 1/2" m.koppelingen m. armbediening

0402575

chrom

350850564

stuk

486,00

218

1

0770752 Montagebeugel messing 2x15 mmx1/2"

0770752

stuk

5,90

475

0



Kludi Medimix

1-gats wastafelkraan m. lange hendel

0408239

chrom

332720564









stuk

158,00

187

1

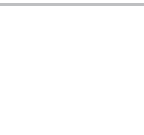

| | Art.nr | Specificaties | Kleur | Lev.nr | Ehd | Prijs | Grp | CC |
|---|--|---|-------|-----------|------|--------|-----|----|
| Sanitair producten |  | Kludi Mix | | | | | | |
| | | wandkraan m. koppelingen m. uitloop 200mm | | | | | | |
| | 0402532 | | chrom | 338130562 | stuk | 222,00 | 187 | 1 |
| | 0770752 | Montagebeugel messing 2x15 mmx1/2" | | 0770752 | stuk | 5,90 | 475 | 0 |
| Baden / douchebakken / stoomcabines |  | afbouwset voor inbouwthermostaat 3/4" | | | | | | |
| | | 0409359 | | | | | | |
| | | | chrom | 356190518 | stuk | 108,00 | 187 | 1 |
| | 0409014 | inbouwdeel thermostaatkraan 3/4" | | 35093 | stuk | 526,00 | 187 | 1 |
| Douchegarnituur |  | afbouwset voor inbouwthermostaat 1/2" | | | | | | |
| | | 0402567 | | | | | | |
| | | | chrom | 357190538 | stuk | 108,00 | 218 | 1 |
| | 0400807 | inbouwdeel 1/2" voor thermostaat z. omstel | | 35158 | stuk | 171,00 | 218 | 1 |
| Douchewanden |  | douchethermostaat m. koppelingen z. omstel | | | | | | |
| | | 0406651 HOH=12cm | | | | | | |
| | | | chrom | 354030518 | stuk | 269,00 | 218 | 1 |
| | 0406643 | HOH=15cm | chrom | 354000518 | stuk | 269,00 | 218 | 1 |
| Badthermostaat m. omstel m. koppelingen |  | badthermostaat m. omstel m. koppelingen | | | | | | |
| | | 0406678 | | | | | | |
| | | | chrom | 354010518 | stuk | 323,00 | 218 | 1 |
| thermo-element |  | thermo-element | | | | | | |
| | | 0408159 | | | | | | |
| | | | | 767290000 | stuk | 73,50 | 187 | 1 |
| 1-gats wastafelkraan m. waste |  | Kludi Mx | | | | | | |
| | | 1-gats wastafelkraan m. waste | | | | | | |
| | 0400136 | | chrom | 331250562 | stuk | 191,00 | 188 | 1 |
| 1-gats wastafelkraan z. waste |  | 1-gats wastafelkraan z. waste | | | | | | |
| | | 0400137 | | | | | | |
| | | | chrom | 331260562 | stuk | 187,00 | 188 | 1 |
| 1-gats wastafelkraan laag m. waste |  | 1-gats wastafelkraan laag m. waste | | | | | | |
| | | 0400138 | | | | | | |
| | | | chrom | 331280562 | stuk | 187,00 | 188 | 1 |

| Art.nr | Specificaties | Kleur | Lev.nr | Ehd | Prijs | Grp | CC |
|--------|---------------|-------|--------|-----|-------|-----|----|
|--------|---------------|-------|--------|-----|-------|-----|----|

Kludi Mx

1-gats bidetkraan m. waste

| | | | | | | | |
|---------|--|-------|-----------|------|--------|-----|---|
| 0400139 | | chrom | 332150562 | stuk | 252,00 | 188 | 1 |
|---------|--|-------|-----------|------|--------|-----|---|



Sanitair producten

Baden /
douchebakken /
stoomcabines**badkraan m. omstel m. koppelingen**

| | | | | | | | |
|---------|--|-------|-----------|------|--------|-----|---|
| 0400140 | | chrom | 334450562 | stuk | 239,00 | 188 | 1 |
|---------|--|-------|-----------|------|--------|-----|---|



Kranen

Douchegarnituur

douchekraan z. omstel m. koppelingen

| | | | | | | | |
|---------|--|-------|-----------|------|--------|-----|---|
| 0400145 | | chrom | 337100562 | stuk | 172,00 | 188 | 1 |
|---------|--|-------|-----------|------|--------|-----|---|

Accessoires en
spiegels

Douchewanden

afbouwset voor inbouwdouchekraan

| | | | | | | | |
|---------|--|-------|-----------|------|-------|-----|---|
| 0400147 | | chrom | 337160562 | stuk | 89,50 | 188 | 1 |
|---------|--|-------|-----------|------|-------|-----|---|

| | | | | | | | |
|---------|---------------------------------------|--|-------|------|--------|-----|---|
| 0400069 | inbouwset voor inbouwkraan universeel | | 33434 | stuk | 122,00 | 187 | 1 |
|---------|---------------------------------------|--|-------|------|--------|-----|---|

| | | | | | | | |
|---------|----------------------------------|--|-----------|------|-------|-----|---|
| 0400072 | verlenging voor 33434 30mm chrom | | 742330500 | stuk | 50,50 | 187 | 1 |
|---------|----------------------------------|--|-----------|------|-------|-----|---|

| | | | | | | | |
|---------|-------------------------------------|--|-------|------|--------|-----|---|
| 0400112 | Flexboxx universeel inbouwdeel DN20 | | 88077 | stuk | 172,00 | 187 | 1 |
|---------|-------------------------------------|--|-------|------|--------|-----|---|

| | | | | | | | |
|---------|---|--|-----------|------|-------|-----|---|
| 0400113 | Flexboxx verlenging voor 88077 20mm chrom | | 744000500 | stuk | 63,50 | 187 | 1 |
|---------|---|--|-----------|------|-------|-----|---|

| | | | | | | | |
|---------|-----------------------------|--|-----------|------|-------|-----|---|
| 0400131 | Flexboxx spelset voor 88077 | | 744040000 | stuk | 59,00 | 187 | 1 |
|---------|-----------------------------|--|-----------|------|-------|-----|---|

Toebehoren &
afvoeren**badthermostaat m. omstel m. koppelingen**

| | | | | | | | |
|---------|--|-------|-----------|------|--------|-----|---|
| 0400141 | | chrom | 354310538 | stuk | 400,00 | 188 | 1 |
|---------|--|-------|-----------|------|--------|-----|---|

Spoel- &
installatiesystemenBadkamermeubelen
en toiletkasten**douchethermostaat z. omstel m. koppelingen**

| | | | | | | | |
|---------|--|-------|-----------|------|--------|-----|---|
| 0400146 | | chrom | 354300538 | stuk | 341,00 | 188 | 1 |
|---------|--|-------|-----------|------|--------|-----|---|

Gootstenen en
wastroggen

Utiliteit

baduitloop 3/4" wandmontage

| | | | | | | | |
|---------|-------|-------|---------|------|-------|-----|---|
| 0400143 | 130mm | chrom | 3350205 | stuk | 91,50 | 188 | 1 |
|---------|-------|-------|---------|------|-------|-----|---|

| | | | | | | | |
|---------|-------|-------|---------|------|--------|-----|---|
| 0400144 | 170mm | chrom | 3350305 | stuk | 101,00 | 188 | 1 |
|---------|-------|-------|---------|------|--------|-----|---|



newwaves



Een besluit voor de toekomst.

Kludi Nederland C.V.
Havenstraat 9A
1948 NP Beverwijk
Telefoon: 0251-26 20 20
Fax: 0251-26 20 25
www.kludi.com
info@kludi.nl

● KLUDI ●

| Art.nr | Specificaties | Kleur | Lev.nr | Ehd | Prijs | Grp | CC |
|--------|---------------|-------|--------|-----|-------|-----|----|
|--------|---------------|-------|--------|-----|-------|-----|----|

Kludi New Waves

1-gats wastafelkraan m. waste 2-greeps

| | | | | | | | |
|---------|-------|--------|-----------|------|--------|-----|---|
| 0400015 | 121mm | chroom | 571180530 | stuk | 332,00 | 187 | 1 |
| 0400014 | 155mm | chroom | 571140530 | stuk | 392,00 | 187 | 1 |



Sanitair producten

1-gats wastafelkraan m. waste 2-greeps thermostatisch

| | | | | | | | |
|---------|--|--------|-----------|------|--------|-----|---|
| 0400016 | | chroom | 574140530 | stuk | 511,00 | 187 | 1 |
|---------|--|--------|-----------|------|--------|-----|---|

Baden /
douchebakken /
stoomcabines

Kranen

1-gats wastafelkraan voor waskom 2-greeps

| | | | | | | | |
|---------|--|--------|-----------|------|--------|-----|---|
| 0400086 | | chroom | 571240530 | stuk | 525,00 | 187 | 1 |
|---------|--|--------|-----------|------|--------|-----|---|



Douchegarnituur

Accessoires en
spiegels**3-gats wastafelkraan m. waste**

| | | | | | | | |
|---------|--|--------|-----------|------|--------|-----|---|
| 0407429 | | chroom | 571430530 | stuk | 539,00 | 187 | 1 |
|---------|--|--------|-----------|------|--------|-----|---|



Douchewanden

Toebehoren &
afvoeren**3-gats inbouwwandkraan voor wastafel m. achterwand inbouw + afbouwdeel**

| | | | | | | | |
|---------|------|--------|-----------|------|--------|-----|---|
| 0407321 | 13cm | chroom | 571440530 | stuk | 518,00 | 187 | 1 |
|---------|------|--------|-----------|------|--------|-----|---|

Spoel- &
installatiesystemen**3-gats inbouwwandkraan inbouw + afbouwdeel**

| | | | | | | | |
|---------|------|--------|-----------|------|--------|-----|---|
| 0407313 | 13cm | chroom | 571450530 | stuk | 532,00 | 187 | 1 |
| 0409010 | 21cm | chroom | 571460530 | stuk | 587,00 | 187 | 1 |

Badkamermeubelen
en toiletkastenGootstenen en
wastroggen**1-gats toiletkraan 1-greeps**

| | | | | | | | |
|---------|--|--------|-----------|------|--------|-----|---|
| 0408816 | | chroom | 571160530 | stuk | 186,00 | 187 | 0 |
|---------|--|--------|-----------|------|--------|-----|---|



Utiliteit

1-gats wastafelkraan m. waste 1-greeps

| | | | | | | | |
|---------|-------|--------|-----------|------|--------|-----|---|
| 0409596 | 98mm | chroom | 571290575 | stuk | 302,00 | 187 | 1 |
| 0407305 | 114mm | chroom | 570230575 | stuk | 331,00 | 187 | 0 |

**1-gats wastafelkraan z.waste 1-greeps**

| | | | | | | | |
|---------|--|--------|-----------|------|--------|-----|---|
| 0409011 | | chroom | 570290575 | stuk | 331,00 | 187 | 0 |
|---------|--|--------|-----------|------|--------|-----|---|



| | Art.nr | Specificaties | Kleur | Lev.nr | Ehd | Prijs | Grp | CC |
|---|---|---|-------|-----------|------|---------|-----|----|
| | Kludi New Waves | | | | | | | |
| Sanitair producten | | 1-gats wastafelkraan voor waskom 1-greeps | | | | | | |
| | 0408824 | | chrom | 570240575 | stuk | 518,00 | 187 | 1 |
| Baden / douchebakken / stoomcabines |  | | | | | | | |
| Kranen | | 1-gats inbouwwandkraan v. wastafel m. achterwand inbouw + afbouwdeel | | | | | | |
| | 0408832 | | chrom | 570250575 | stuk | 554,00 | 187 | 1 |
| Douchegarnituur |  | | | | | | | |
| Accessoires en spiegels | | 1-gats bidetkraan m. waste 2-greeps | | | | | | |
| | 0400018 | | chrom | 573130530 | stuk | 403,00 | 187 | 1 |
| Douchewanden |  | | | | | | | |
| Toebehoren & afvoeren | | 1-gats bidetkraan m. waste 2-greeps thermostatisch | | | | | | |
| | 0400019 | | chrom | 574130530 | stuk | 518,00 | 187 | 1 |
| Spoel- & installatiesystemen |  | | | | | | | |
| Badkamermeubelen en toiletkasten | | 1-gats bidetkraan m. waste 1-greeps | | | | | | |
| | 0409197 | | chrom | 572160575 | stuk | 345,00 | 187 | 1 |
| Gootstenen en wastroggen |  | | | | | | | |
| Utiliteit | | badkraan m. koppelingen m. omstel | | | | | | |
| | 0407542 | | chrom | 575400530 | stuk | 424,00 | 187 | 0 |
| |  | | | | | | | |
| | | 4-gats badrandkraan | | | | | | |
| | 0408875 | | chrom | 574240530 | stuk | 1186,00 | 187 | 1 |
| | 0400066 | montageplaat voor 4-gats kraan | | 761484600 | stuk | 175,00 | 187 | 1 |
| | 0400067 | euro-montageblok voor 4-gats kraan | | 761500000 | stuk | 457,00 | 187 | 1 |
| | 0400082 | zichtbare montageplaat chrom | | 1602105 | stuk | 250,00 | 187 | 1 |
| |  | | | | | | | |
| | | 4-gats tegelrandkraan | | | | | | |
| | 0408883 | | chrom | 574250530 | stuk | 1229,00 | 187 | 1 |
| | 0400066 | montageplaat voor 4-gats kraan | | 761484600 | stuk | 175,00 | 187 | 1 |
| | 0400067 | euro-montageblok voor 4-gats kraan | | 761500000 | stuk | 457,00 | 187 | 1 |
| | 0400082 | zichtbare montageplaat chrom | | 1602105 | stuk | 250,00 | 187 | 1 |
| |  | | | | | | | |
| | | handdouche voor badrandkraan | | | | | | |
| | 0409012 | | chrom | 5705105 | stuk | 228,00 | 187 | 1 |
| |  | | | | | | | |
| | | 2-weg omstelling voor badrandkraan | | | | | | |
| | 0409013 | | chrom | 578480530 | stuk | 292,00 | 187 | 1 |
| |  | | | | | | | |

| Art.nr | Specificaties | Kleur | Lev.nr | Ehd | Prijs | Grp | CC |
|--------|---------------|-------|--------|-----|-------|-----|----|
|--------|---------------|-------|--------|-----|-------|-----|----|

Kludi New Waves

afbouwdeel badkraan op zuil m. planchet

| | | | | | | | |
|---------|-----------------------------|--------|-----------|------|---------|-----|---|
| 0409219 | | chroom | 575900530 | stuk | 1528,00 | 187 | 1 |
| 0409243 | inbouwdeel badkraan op zuil | | 767700000 | stuk | 407,00 | 187 | 1 |



Sanitair producten

Baden /
douchebakken /
stoomcabines**afbouwdeel badkraan op zuil m. wijnkoeler**

| | | | | | | | |
|---------|-----------------------------|--------|-----------|------|---------|-----|---|
| 0409227 | | chroom | 575910530 | stuk | 1528,00 | 187 | 1 |
| 0409243 | inbouwdeel badkraan op zuil | | 767700000 | stuk | 407,00 | 187 | 1 |



Kranen

Douchegarnituur

douchekraan m. koppelingen z. omstel

| | | | | | | | |
|---------|--|--------|-----------|------|--------|-----|---|
| 0407445 | | chroom | 577100530 | stuk | 363,00 | 187 | 1 |
|---------|--|--------|-----------|------|--------|-----|---|

Accessoires en
spiegels**douchekraan m. frontdouche m. koppelingen m. omstel**

| | | | | | | | |
|---------|--|--------|-----------|------|--------|-----|---|
| 0408956 | | chroom | 577110530 | stuk | 517,00 | 187 | 1 |
|---------|--|--------|-----------|------|--------|-----|---|



Douchewanden

Toebehoren &
afvoeren**douchethermostaat recht model HOH=15cm m. koppelingen**

| | | | | | | | |
|---------|--|--------|-----------|------|--------|-----|---|
| 0407453 | | chroom | 574200530 | stuk | 374,00 | 187 | 1 |
|---------|--|--------|-----------|------|--------|-----|---|

Spoel- &
installatiesystemen**douchethermostaat V-model HOH=15cm m. koppelingen**

| | | | | | | | |
|---------|--|--------|-----------|------|--------|-----|---|
| 0408964 | | chroom | 574210530 | stuk | 492,00 | 187 | 0 |
|---------|--|--------|-----------|------|--------|-----|---|

Badkamermeubelen
en toiletkastenGootstenen en
wastroggen**baduitloop G3/4" variabel**

| | | | | | | | |
|---------|--|--------|---------|------|--------|-----|---|
| 0409618 | | chroom | 5750405 | stuk | 206,00 | 187 | 1 |
|---------|--|--------|---------|------|--------|-----|---|



Utiliteit









afbouwdeel inbouwstopkraan

| | | | | | | | |
|---------|---------------------------|--------|-----------|------|--------|-----|---|
| 0408891 | | chroom | 578150530 | stuk | 103,00 | 187 | 1 |
| 0408387 | inbouwdeel stopkraan 3/4" | | 57811 | stuk | 60,50 | 187 | 1 |
| 0408905 | inbouwdeel stopkraan 1/2" | | 57809 | stuk | 41,75 | 187 | 1 |

**afbouwdeel 2-weg omstelling**

| | | | | | | | |
|---------|----------------------------------|--------|-----------|------|--------|-----|---|
| 0409022 | | chroom | 578450530 | stuk | 128,00 | 187 | 1 |
| 0409030 | inbouwdeel 2-weg omstelling 1/2" | | 57751 | stuk | 180,00 | 187 | 1 |



| | Art.nr | Specificaties | Kleur | Lev.nr | Ehd | Prijs | Grp | CC |
|---|---|---------------|----------------------------------|-----------|-------|--------|--------|-----|
| | Kludi New Waves | | | | | | | |
| | afbouwdeel 3-weg omstelling | | | | | | | |
| Sanitair producten |  | 0408980 | chrom | 578460530 | stuk | 128,00 | 187 | 1 |
| | | 0408999 | inbouwdeel 3-weg omstelling 1/2" | | 29752 | stuk | 225,00 | 187 |
| Baden / douchebakken / stoomcabines | | | | | | | | |
| | afbouwdeel inbouwbadkraan m. omstel | | | | | | | |
| Kranen |  | 0408913 | chrom | 575150575 | stuk | 202,00 | 187 | 1 |
| | | 0408921 | inbouwdeel bad-/douchekraan 1/2" | | 57624 | stuk | 144,00 | 187 |
| Douchegarnituur | | | | | | | | |
| | afbouwdeel inbouwdouchekraan | | | | | | | |
| Accessoires en spiegels |  | 0408972 | chrom | 577180575 | stuk | 238,00 | 187 | 1 |
| | | 0408921 | inbouwdeel bad-/douchekraan 1/2" | | 57624 | stuk | 144,00 | 187 |
| Douchewanden | | | | | | | | |
| | afbouwdeel inbouwthermostaat | | | | | | | |
| Toebehoren & afvoeren |  | 0409006 | chrom | 577190530 | stuk | 202,00 | 187 | 1 |
| | | 0409014 | inbouwdeel thermostaatkraan 3/4" | | 35093 | stuk | 526,00 | 187 |
| Spoel- & installatiesystemen | | | | | | | | |
| | slangaansluitbocht 1/2" m. rozet | | | | | | | |
| Badkamermeubelen en toiletkasten |  | 0408948 | chrom | 575410500 | stuk | 49,50 | 187 | 1 |
| | | | | | | | | |
| Gootstenen en wastroggen | | | | | | | | |
| | douche-arm 1/2" | | | | | | | |
| Utiliteit |  | 0409049 | chrom | 573010500 | stuk | 91,00 | 187 | 1 |
| | | | | | | | | |
| | inbouwdeel badkraan op zuil | | | | | | | |
| |  | 0409243 | | 767700000 | stuk | 407,00 | 187 | 1 |
| | | | | | | | | |
| | inbouwdeel stopkraan 1/2" | | | | | | | |
| | | 0408905 | | 57809 | stuk | 41,75 | 187 | 1 |
| | inbouwdeel stopkraan 3/4" | | | | | | | |
| | | 0408387 | | 57811 | stuk | 60,50 | 187 | 1 |
| | inbouwdeel 2-weg omstelling 1/2" | | | | | | | |
| | | 0409030 | | 57751 | stuk | 180,00 | 187 | 1 |
| | inbouwdeel 3-weg omstelling 1/2" | | | | | | | |
| |  | 0408999 | | 29752 | stuk | 225,00 | 187 | 1 |
| | | | | | | | | |

| Art.nr | Specificaties | Kleur | Lev.nr | Ehd | Prijs | Grp | CC |
|--------|---------------|-------|--------|-----|-------|-----|----|
|--------|---------------|-------|--------|-----|-------|-----|----|

Kludi New Waves

inbouwdeel bad-/douchekraan 1/2"

| | | | | | | | |
|---------|--|--|-------|------|--------|-----|---|
| 0408921 | | | 57624 | stuk | 144,00 | 187 | 1 |
|---------|--|--|-------|------|--------|-----|---|



Sanitair producten

Baden /
douchebakken /
stoomcabines**hoekstopkraan**

| | | | | | | | |
|---------|--|--------|-----------|------|-------|-----|---|
| 0407354 | | chroom | 578430530 | stuk | 70,50 | 187 | 1 |
|---------|--|--------|-----------|------|-------|-----|---|



Kranen

Douchegarnituur

Kludi Objekta Mix

badthermostaat m. koppelingen HOH=15cm

| | | | | | | | |
|---------|--|--------|-----------|------|--------|-----|---|
| 0408255 | | chroom | 352600538 | stuk | 220,00 | 218 | 1 |
|---------|--|--------|-----------|------|--------|-----|---|

Accessoires en
spiegels**douchethermostaat z. koppelingen**

| | | | | | | | |
|---------|----------|--------|-----------|------|--------|-----|---|
| 0407119 | HOH=12cm | chroom | 353110538 | stuk | 159,00 | 218 | 0 |
|---------|----------|--------|-----------|------|--------|-----|---|

| | | | | | | | |
|---------|----------|--------|-----------|------|--------|-----|---|
| 0407127 | HOH=15cm | chroom | 353100538 | stuk | 159,00 | 218 | 0 |
|---------|----------|--------|-----------|------|--------|-----|---|



Douchewanden

douchethermostaat m. koppelingen HOH=15cm

| | | | | | | | |
|---------|--|--------|-----------|------|--------|-----|---|
| 0408247 | | chroom | 352000538 | stuk | 169,00 | 218 | 1 |
|---------|--|--------|-----------|------|--------|-----|---|

Toebehoren &
afvoerenSpoel- &
installatiesystemen**uitloop voor douchethermostaat**

| | | | | | | | |
|---------|--|--------|-----------|------|-------|-----|---|
| 0403172 | | chroom | 752480500 | stuk | 54,50 | 218 | 0 |
|---------|--|--------|-----------|------|-------|-----|---|

Badkamermeubelen
en toiletkastenGootstenen en
wastroggen

Kludi Objekta Mix NEW

1-gats wastafelkraan m. ketting

| | | | | | | | |
|---------|--|--------|-----------|------|--------|-----|---|
| 0400148 | | chroom | 332200575 | stuk | 127,00 | 188 | 1 |
|---------|--|--------|-----------|------|--------|-----|---|



Utiliteit









1-gats wastafelkraan m. waste









| | | | | | | | |
|---------|--|--------|-----------|------|--------|-----|---|
| 0400149 | | chroom | 332330575 | stuk | 146,00 | 188 | 1 |
|---------|--|--------|-----------|------|--------|-----|---|





**1-gats bidetkraan m. waste**

| | | | | | | | |
|---------|--|--------|-----------|------|--------|-----|---|
| 0400150 | | chroom | 334160575 | stuk | 192,00 | 188 | 1 |
|---------|--|--------|-----------|------|--------|-----|---|















| | Art.nr | Specificaties | Kleur | Lev.nr | Ehd | Prijs | Grp | CC | | | | | | |
|---|---|---|---|--------|-----------|-------|--------|-----|---|-----------|------|--------|-----|---|
| Sanitair producten | Kludi Objekta Mix NEW | | | | | | | | | | | | | |
| |  | badkraan m. omstel m. koppelingen | | chrom | 336530575 | stuk | 193,00 | 188 | 1 | | | | | |
| 0400151 | | | | | | | | | | | | | | |
| Baden / douchebakken / stoomcabines | | | | | | | | | | | | | | |
| Kranen |  | douchekraan z. omstel m. koppelingen | | chrom | 337640575 | stuk | 132,00 | 188 | 1 | | | | | |
| | | 0400153 | | | | | | | | | | | | |
| Douchegarnituur | | | | | | | | | | | | | | |
| Accessoires en spiegels |  | afbouwset voor inbouwbadkraan | | chrom | 336150575 | stuk | 76,00 | 188 | 1 | | | | | |
| | | 0400152 | | | | | | | | | | | | |
| | | 0400069 | inbouwset voor inbouwkraan universeel | | | | | | | 33434 | stuk | 122,00 | 187 | 1 |
| | | 0400072 | verlenging voor 33434 30mm chrom | | | | | | | 742330500 | stuk | 50,50 | 187 | 1 |
| | | 0400112 | Flexboxx universeel inbouwdeel DN20 | | | | | | | 88077 | stuk | 172,00 | 187 | 1 |
| | | 0400113 | Flexboxx verlenging voor 88077 20mm chrom | | | | | | | 744000500 | stuk | 63,50 | 187 | 1 |
| 0400131 | Flexboxx spoelset voor 88077 | 744040000 | stuk | 59,00 | 187 | 1 | | | | | | | | |
| Douchewanden | | | | | | | | | | | | | | |
| Toebehoren & afvoeren |  | afbouwset voor inbouwdouchekraan | | chrom | 338180575 | stuk | 56,50 | 188 | 1 | | | | | |
| | | 0400154 | | | | | | | | | | | | |
| | | 0400069 | inbouwset voor inbouwkraan universeel | | | | | | | 33434 | stuk | 122,00 | 187 | 1 |
| | | 0400072 | verlenging voor 33434 30mm chrom | | | | | | | 742330500 | stuk | 50,50 | 187 | 1 |
| | | 0400112 | Flexboxx universeel inbouwdeel DN20 | | | | | | | 88077 | stuk | 172,00 | 187 | 1 |
| | | 0400113 | Flexboxx verlenging voor 88077 20mm chrom | | | | | | | 744000500 | stuk | 63,50 | 187 | 1 |
| 0400131 | Flexboxx spoelset voor 88077 | 744040000 | stuk | 59,00 | 187 | 1 | | | | | | | | |
| Spoel- & installatiesystemen | | | | | | | | | | | | | | |
| Badkamermeubelen en toiletkasten |  | Kludi Sensora | | chrom | 3610005 | stuk | 453,00 | 187 | 1 | | | | | |
| | | 1-gats wastafelkraan electronisch m. batterijen m. temp. keuzeknop | | | | | | | | | | | | |
| | 0406910 | | | | | | | | | | | | | |
| Gootstenen en wastroggen |  | 1-gats wastafelkraan electronisch m. batterijen vooraf instelbaar | | chrom | 3610505 | stuk | 420,00 | 187 | 1 | | | | | |
| | | 0406929 | | | | | | | | | | | | |
| Utiliteit | | | | | | | | | | | | | | |
| Kludi Standaard-Optima | | | | | | | | | | | | | | |
| |  | toiletkraan m. straalregelaar | | chrom | 209150508 | stuk | 28,25 | 187 | 1 | | | | | |
| | | 0400886 | | | | | | | | | | | | |
| |  | 1-gats toiletkraan m. hoge uitloop | | chrom | 209060508 | stuk | 50,00 | 187 | 1 | | | | | |
| | | 0407380 | | | | | | | | | | | | |
| |  | 1-gats wastafelkraan m. kettinghouder | | chrom | 219580508 | stuk | 53,00 | 187 | 1 | | | | | |
| | | 0407550 | | | | | | | | | | | | |

| Art.nr | Specificaties | Kleur | Lev.nr | Ehd | Prijs | Grp | CC | | |
|--|--------------------------------|--------|-----------|------|--------|-----|----|---|---|
| | | | | | | | | Kludi Standaard-Optima | |
| 1-gats wastafelkraan m. inzinkbare ketting 0407569 | | chroom | 219600508 | stuk | 56,50 | 187 | 0 |  | Sanitair producten |
| badkraan HOH=15cm m. omstel 0407577 | | chroom | 259250508 | stuk | 67,00 | 187 | 1 |  | Baden / douchebakken / stoomcabines |
| douчекraan | | | | | | | | | |
| 0407585 | HOH=12cm | chroom | 269010508 | stuk | 45,00 | 187 | 1 |  | Douchegarnituur |
| 0407593 | HOH=15cm | chroom | 269020508 | stuk | 43,75 | 187 | 1 | | |
| | | | | | | | | Kludi Tercio | |
| 1-gats wastafelkraan z. waste 0409526 | | chroom | 381800575 | stuk | 72,50 | 187 | 1 |  | Accessoires en spiegels |
| 1-gats wastafelkraan m. waste 0409527 | | chroom | 381810575 | stuk | 84,50 | 187 | 0 |  | Douchewanden |
| 1-gats bidetkraan m. waste 0409528 | | chroom | 385320575 | stuk | 97,00 | 187 | 1 |  | Toebehoren & afvoeren |
| badkraan m. koppelingen 0409530 | | chroom | 386840575 | stuk | 98,00 | 187 | 0 |  | Spoel- & installatiesystemen |
| douчекraan m. koppelingen 0409531 | | chroom | 388420575 | stuk | 75,50 | 187 | 1 |  | Badkamermeubelen en toiletkasten |
| afbouwdeel voor inbouwbadkraan 0409532 | | chroom | 387190575 | stuk | 67,50 | 187 | 1 |  | Gootstenen en wastroggen |
| 0404128 | inbouwdeel voor inbouwbadkraan | | 38624 | stuk | 106,00 | 187 | 1 | | Utiliteit |

| | Art.nr | Specificaties | Kleur | Lev.nr | Ehd | Prijs | Grp | CC |
|---|---|-----------------------------------|-------|-----------|------|-------|-----|----|
| Sanitair producten | Kludi Tercio | | | | | | | |
| | afbouwdeel voor inbouwdouchekraan | | | | | | | |
| | 0409533 | | chrom | 389210575 | stuk | 54,00 | 187 | 1 |
| Baden / douchebakken / stoomcabines | 0404101 | inbouwdeel voor inbouwdouchekraan | | 38826 | stuk | 70,50 | 187 | 1 |
| |  | | | | | | | |
| Kranen | Kludi Terralux-Standaard | | | | | | | |
| | toiletkraan 1/2" m. straalregelaar | | | | | | | |
| Douchegarnituur | 0400858 | | chrom | 200150508 | stuk | 26,75 | 188 | 0 |
| |  | | | | | | | |
| Accessoires en spiegels | toiletkraan 1/2" m. straalregelaar m. draaibare uitloop | | | | | | | |
| | 0400882 | | chrom | 204060508 | stuk | 47,25 | 188 | 0 |
| Douchewanden | 1-gats wastafelkraan m. kettinghouder m. draaibare uitloop | | | | | | | |
| | 0400920 | | chrom | 210580508 | stuk | 50,50 | 188 | 0 |
| Toebehoren & afvoeren | 1-gats wastafelkraan m. inzinkbare ketting m. draaibare uitloop | | | | | | | |
| | 0402303 | | chrom | 210600508 | stuk | 53,50 | 188 | 0 |
| Spoel- & installatiesystemen | 1-gats wastafelkraan m. waste m. draaibare uitloop | | | | | | | |
| | 0402311 | | chrom | 210620508 | stuk | 96,00 | 188 | 1 |
| Badkamermeubelen en toiletkasten | 1-gats wastafelkraan m. waste m. gegoten uitloop | | | | | | | |
| | 0400300 | HOH=12cm | chrom | 263010508 | stuk | 42,75 | 188 | 0 |
| Gootstenen en wastroggen | 0400305 | HOH=15cm | chrom | 263020508 | stuk | 41,50 | 188 | 1 |
| |  | | | | | | | |
| Utiliteit | douchekraan z. koppelingen z. omstel | | | | | | | |
| |  | | | | | | | |

| Art.nr | Specificaties | Kleur | Lev.nr | Ehd | Prijs | Grp | CC | | |
|---|---------------|-------|-----------|------|-------|-----|----|--|---|
| | | | | | | | | Kludi Terralux-Standaard | |
| douчекraan HOH=12cm z. koppelingen m. omstel m. S-uitloop 0400335 | | chrom | 263090508 | stuk | 56,00 | 188 | 0 |  | Sanitair producten |
| badkraan z. koppelingen m. omstel 0400262 | | chrom | 253250508 | stuk | 63,50 | 188 | 0 |  | Baden / douchebakken / stoomcabines |
| badkraan m. koppelingen m. omstel 0400295 | | chrom | 250010508 | stuk | 73,50 | 188 | 1 |  | Kranen |
| tapkraan 1/2" 0400750 | | chrom | 300150508 | stuk | 26,25 | 188 | 0 |  | Douchegarnituur |
| tapkraan 1/2" m. slangwartel 0400769 | | chrom | 300230508 | stuk | 24,25 | 188 | 1 |  | Accessoires en spiegels |
| tapkraan 1/2" m. S-uitloop 0400777 | | chrom | 304050508 | stuk | 38,75 | 188 | 1 |  | Douchewanden |
| tapkraan 1/2" m. U-uitloop 0400785 | | chrom | 304090508 | stuk | 39,25 | 188 | 1 |  | Toebehoren & afvoeren |
| wandkraan z. koppelingen m. S-uitloop 0400378 | | chrom | 313530508 | stuk | 58,50 | 188 | 0 |  | Spoel- & installatiesystemen |
| wandkraan z. koppelingen m. U-uitloop 0400408 | | chrom | 313550508 | stuk | 58,50 | 188 | 0 |  | Badkamermeubelen en toiletkasten |
| | | | | | | | | | Gootstenen en wastroggen |
| | | | | | | | | | Utiliteit |

| | Art.nr | Specificaties | Kleur | Lev.nr | Ehd | Prijs | Grp | CC |
|---|---|---|-------|-----------|------|--------|-----|----|
| Sanitair producten | Kludi Terralux-Standaard | | | | | | | |
| | | wandkraan m. koppelingen m. gegoten uitloop 0400491 | chrom | 320040508 | stuk | 97,50 | 188 | 1 |
| Baden / douchebakken / stoomcabines |  | | | | | | | |
| Kranen | | afbouwset voor inbouwstopkraan 0409324 | chrom | 757600500 | stuk | 50,50 | 187 | 1 |
| | | inbouwdeel stopkraan 3/4" 0409316 | | 29211 | stuk | 20,00 | 187 | 1 |
| Douchegarnituur |  | | | | | | | |
| Accessoires en spiegels | | inbouwdeel stopkraan 22mm 0409308 | | 29511 | stuk | 20,00 | 187 | 1 |
| Douchewanden |  | | | | | | | |
| Toebehoren & afvoeren | Kludi Universeel | | | | | | | |
| | | inbouwdeel 2-weg omstelling 0408190 | | 2975100 | stuk | 182,00 | 187 | 1 |
| Spoel- & installatiesystemen |  | | | | | | | |
| Badkamermeubelen en toiletkasten | | inbouwdeel stopkraan 1/2" 0408212 | | 29809 | stuk | 35,00 | 187 | 1 |
| | | inbouwdeel stopkraan 3/4" 0408220 | | 29909 | stuk | 35,00 | 187 | 1 |
| Gootstenen en wastroggen |  | | | | | | | |
| Utiliteit | | inbouwdeel voor inbouwbad-/douchekraan universeel 0403156 | | 33424 | stuk | 132,00 | 187 | 1 |
| | | inbouwdeel thermostaatkraan 1/2" 0407151 | | 35156 | stuk | 214,00 | 218 | 1 |
| |  | | | | | | | |
| |  | | | | | | | |

| Art.nr | Specificaties | Kleur | Lev.nr | Ehd | Prijs | Grp | CC |
|---|----------------------------|---------|-----------|------|--------|-----|----|
| Kludi Universeel | | | | | | | |
| inbouwdeel thermostaatkraan 3/4" 0409014 | | | 35093 | stuk | 526,00 | 187 | 1 |
|  | | | | | | | |
| inbouwdeel 1/2" 0400807 | voor thermostaat z. omstel | | 35158 | stuk | 171,00 | 218 | 1 |
|  | | | | | | | |
| inbouwdeel voor inbouwdouchekraan 0404101 | | | 38826 | stuk | 70,50 | 187 | 1 |
|  | | | | | | | |
| inbouwdeel voor inbouwbadkraan 0404128 | | | 38624 | stuk | 106,00 | 187 | 1 |
|  | | | | | | | |
| baduitloop 3/4"x15cm 0405760 | m. straalregelaar | | 1350205 | stuk | 43,00 | 187 | 1 |
|  | | | | | | | |
| temperatuurregeleenheid 0408158 | | chrom | 758700000 | stuk | 77,50 | 187 | 1 |
| inbouwset voor inbouwkraan universeel 0400069 | | | 33434 | stuk | 122,00 | 187 | 1 |
| verlenging voor 33434 30mm 0400072 | | chrom | 742330500 | stuk | 50,50 | 187 | 1 |
| montageplaat voor 4-gats kraan 0400066 | | | 761484600 | stuk | 175,00 | 187 | 1 |
|  | | | | | | | |
| zichtbare montageplaat 0400105 | | messing | 1602145 | stuk | 539,00 | 187 | 1 |
| set schroeven voor montageplaat messing 0400106 | | | 761564500 | stuk | 25,50 | 187 | 1 |

Sanitair producten

Baden /
douchebakken /
stoomcabines

Kranen

Douchegarnituur

Accessoires en
spiegels

Douchewanden

Toebehoren &
afvoerenSpoel- &
installatiesystemenBadkamermeubelen
en toiletkastenGootstenen en
wastroggen

Utiliteit

| Art.nr | Specificaties | Kleur | Lev.nr | Ehd | Prijs | Grp | CC |
|--------|---------------|-------|--------|-----|-------|-----|----|
|--------|---------------|-------|--------|-----|-------|-----|----|

Kludi Universeel

euro-montageblok voor 4-gats kraan

| | | | | | | | |
|---------|--|--|-----------|------|--------|-----|---|
| 0400067 | | | 761500000 | stuk | 457,00 | 187 | 1 |
|---------|--|--|-----------|------|--------|-----|---|



zichtbare montageplaat

| | | | | | | | |
|---------|--|--------|---------|------|--------|-----|---|
| 0400082 | | chroom | 1602105 | stuk | 250,00 | 187 | 1 |
|---------|--|--------|---------|------|--------|-----|---|



Kludi Toebehoren

| | | | | | | | |
|---------|---|--------|-----------|------|-------|-----|---|
| 0401374 | S-koppeling m. rozet per paar 1/2"x3/8" | chroom | 762200500 | paar | 10,25 | 187 | 1 |
| 0401358 | S-koppeling m. rozet per paar 3/4"x1/2" | chroom | 762190500 | paar | 11,00 | 187 | 1 |
| 0401366 | S-koppeling afsluitbaar per paar 1/2"x3/4" | chroom | 762140500 | paar | 55,00 | 187 | 1 |
| 0401382 | muurplaatkoppeling per paar 1/2"x12mm | chroom | 762150500 | paar | 12,75 | 187 | 1 |
| 0401390 | muurplaatkoppeling per paar 3/4"x15mm | chroom | 762160500 | paar | 13,25 | 187 | 1 |
| 0405752 | staande koppeling per paar 3/4" | chroom | 759820500 | stuk | 59,00 | 187 | 1 |
| 0401552 | S-uitloop m. straalregelaar 15cm 3/4" bi | chroom | 755670500 | stuk | 17,25 | 187 | 0 |
| 0401560 | S-uitloop m. straalregelaar 20cm 3/4" bu | chroom | 754190500 | stuk | 16,75 | 187 | 1 |
| 0401625 | S-uitloop gegoten m. straalregelaar 20cm | chroom | 752240500 | stuk | 64,00 | 187 | 1 |
| 0401579 | U-uitloop m. straalregelaar 20cm 3/4" bi | chroom | 761910500 | stuk | 19,25 | 187 | 1 |
| 0401617 | U-uitloop hoog m. straalregelaar 20cm 3/4" bi | chroom | 754130500 | stuk | 19,25 | 187 | 0 |
| 0401609 | bovenuitloop m. straalregelaar 13cm 3/4" bi | chroom | 754730500 | stuk | 17,25 | 187 | 0 |
| 0401048 | bovendeel greep koud 1/2" | | 110030508 | stuk | 9,90 | 187 | 0 |
| 0401072 | bovendeel greep warm 1/2" | | 110040508 | stuk | 9,90 | 187 | 0 |
| 0401013 | bovendeel z. greep 3/8" | | 755260000 | stuk | 5,60 | 187 | 1 |
| 0401021 | bovendeel z. greep 1/2" | | 752180000 | stuk | 6,00 | 187 | 0 |
| 0407682 | keramisch bovendeel 90° koud | | 750550000 | stuk | 17,50 | 187 | 1 |
| 0407771 | keramisch bovendeel 90° warm | | 750540000 | stuk | 17,50 | 187 | 1 |
| 0401293 | greep koud | | 754210500 | stuk | 9,10 | 187 | 0 |
| 0401307 | greep warm | | 754220500 | stuk | 9,10 | 187 | 0 |
| 0401277 | greep koud m. stofkap | | 755850500 | stuk | 8,80 | 187 | 1 |
| 0401285 | greep warm m. stofkap | | 755860500 | stuk | 8,80 | 187 | 1 |
| 0401463 | slangwartel M22x1" bi | | 755680500 | stuk | 8,50 | 187 | 1 |

Kludi Onderdelen

| | | | | | | | |
|---------|--|--------|------------|------|--------|-----|---|
| 0408484 | omstel los voor badkraan | chroom | 752290500 | stuk | 16,50 | 187 | 1 |
| 0408492 | greep voor Objekta thermostaat | | 753200500 | stuk | 24,00 | 187 | 1 |
| 0408514 | HU-buisuitloop 20cm 3/4" bi | | 756330500 | stuk | 19,00 | 187 | 1 |
| 0408530 | thermo-element 3/4" voor Vitala | | 758690000 | stuk | 136,00 | 187 | 1 |
| 0408549 | volumegreep voor Objekta thermostaat | | 760070500 | stuk | 24,50 | 187 | 1 |
| 0408557 | Eco-cartouche voor hendelkranen | | 764000000 | stuk | 56,00 | 187 | 1 |
| 0408565 | sokkel voor Logo-Mix gootsteenkraan | | 767600500 | stuk | 17,75 | 187 | 1 |
| 0408417 | hogedrukslang 1/2"x1/2"x100cm | | 611510000 | stuk | 44,50 | 187 | 1 |
| 0401242 | cartouche voor kranen | | 752010000 | stuk | 46,50 | 187 | 1 |
| 0401420 | O-ringen set voor Kludi-mix keukenkranen | | 753120000 | stuk | 10,50 | 187 | 0 |
| 0401633 | PVC vastzetstuk per 10 stuks | | 9300261000 | stuk | 6,50 | 187 | 1 |
| 0401447 | reparatieset voor kraan | | 754900000 | stuk | 21,75 | 187 | 0 |
| 0404659 | verlengset voor inbouwdeel 30mm | | 755290500 | stuk | 48,00 | 187 | 1 |
| 0401218 | handdouche voor keukenkranen | chroom | 750680500 | stuk | 64,50 | 187 | 1 |
| 0401188 | doucheslang voor keukenkranen 150cm | chroom | 754610500 | stuk | 42,75 | 187 | 1 |
| 0400267 | set schroeven voor montageplaat | chroom | 761560500 | stuk | 15,00 | 187 | 1 |

| Art.nr | Specificaties | Kleur | Lev.nr | Ehd | Prijs | Grp | CC |
|--------|---------------|-------|--------|-----|-------|-----|----|
|--------|---------------|-------|--------|-----|-------|-----|----|

KWC Disko

1-gats wastafelkraan

| | | | | | | | |
|---------|--|-----|---------------|------|--------|-----|---|
| 0406473 | | RVS | K12VB52700A10 | stuk | 542,00 | 192 | 1 |
|---------|--|-----|---------------|------|--------|-----|---|



Sanitair producten

wandkraan

| | | | | | | | |
|---------|-------|-----|---------------|------|--------|-----|---|
| 0406503 | 150mm | RVS | K11VB72700A34 | stuk | 638,00 | 192 | 1 |
| 0406538 | 230mm | RVS | K11VB74700A34 | stuk | 638,00 | 192 | 1 |
| 0406550 | 305mm | RVS | K11VB76700A34 | stuk | 638,00 | 192 | 1 |

Baden /
douchebakken /
stoomcabines

Kranen

KWC Universeel

basisgarnituur 1/2" voor inbouwthermostaat

| | | | | | | | |
|---------|--|--|--------------|------|--------|-----|---|
| 0403970 | | | K37900193134 | stuk | 145,00 | 192 | 1 |
|---------|--|--|--------------|------|--------|-----|---|



Douchegarnituur

Accessoires en
spiegels

KWC Zeepdispensers

Suprimo zeepdispenser

| | | | | | | | |
|---------|--|---------|------------|------|--------|-----|---|
| 0408123 | | chrom | Z534171000 | stuk | 225,00 | 192 | 1 |
| 0408131 | | velours | Z534171051 | stuk | 262,00 | 192 | 1 |



Douchewanden

Standaard zeepdispenser

| | | | | | | | |
|---------|--|-------|------------|------|-------|-----|---|
| 0405426 | | chrom | Z504937000 | stuk | 46,50 | 192 | 1 |
|---------|--|-------|------------|------|-------|-----|---|

Toebehoren &
afvoeren**Primo zeepdispenser**

| | | | | | | | |
|---------|--|-------|------------|------|--------|-----|---|
| 0405434 | | chrom | Z504938000 | stuk | 78,50 | 192 | 1 |
| 0406546 | | wit | Z504938102 | stuk | 111,00 | 192 | 1 |
| 0406554 | | nira | Z504938130 | stuk | 85,00 | 192 | 1 |

Spoel- &
installatiesystemenBadkamermeubelen
en toiletkasten

KWC Toebehoren

| | | | | | | | |
|---------|---|-------|---------------|------|-------|-----|---|
| 0404136 | S-koppeling m. rozet per paar 1/2"x3/4" | chrom | K30900100044 | paar | 30,50 | 192 | 1 |
| 0403229 | staande koppeling per paar 1/2"x3/4" | chrom | K30994000044 | paar | 53,00 | 192 | 1 |
| 0405183 | dubbele moer 3/4"x3/4" | chrom | Z500159000 | stuk | 14,50 | 192 | 1 |
| 0404284 | klemkoppeling 3/8"x10mm | | Z500015000 | stuk | 8,60 | 192 | 0 |
| 0404292 | klemkoppeling 10x10mm | | Z500210000 | stuk | 13,75 | 192 | 1 |
| 0404535 | bovendeel m. vlakke dichting | | K324001931 | stuk | 14,50 | 192 | 0 |
| 0404543 | bovendeel neostar z. knop M20 1/2" | | K324000931 | stuk | 14,50 | 192 | 0 |
| 0404551 | bovendeel grootkeuken z. knop M25 3/4" | | K324012000 | stuk | 32,25 | 192 | 1 |
| 0404578 | bovendeel inbouw z. stift 1/2" | | Z501559931 | stuk | 25,75 | 192 | 1 |
| 0404586 | bovendeel inbouw z. stift 3/4" | | Z501560931 | stuk | 32,25 | 192 | 1 |
| 0404616 | kraangreep Corona koud 1/2" | chrom | Z503009000 | stuk | 12,25 | 192 | 0 |
| 0404624 | kraangreep Corona warm 1/2" | chrom | Z503008000 | stuk | 12,25 | 192 | 0 |
| 0404632 | kraangreep Corona koud 3/4" | zwart | Z501692106 | stuk | 23,25 | 192 | 1 |
| 0404640 | kraangreep Corona warm 3/4" | zwart | Z501693106 | stuk | 23,25 | 192 | 1 |
| 0403571 | kraangreep Rondo koud | chrom | Z501928000 | stuk | 12,25 | 192 | 1 |
| 0403598 | kraangreep Rondo warm | chrom | Z501929000 | stuk | 12,25 | 192 | 1 |
| 0403555 | kraangreep Rondo koud | wit | Z501928102 | stuk | 12,25 | 192 | 1 |
| 0403563 | kraangreep Rondo warm | wit | Z501929102 | stuk | 12,25 | 192 | 1 |
| 0404489 | straalregelaar M24x1 buitendraad | | K319001000A31 | stuk | 5,50 | 192 | 1 |
| 0404500 | straalregelaar M28x1 buitendraad | | K319001000D32 | stuk | 8,80 | 192 | 1 |

Gootstenen en
wastroggen

Utiliteit

KWC Onderdelen

| | | | | | | | |
|---------|---------------------------------------|--|---------|------|-------|-----|---|
| 0403709 | cartouche Domo compleet 20 liter | | K326000 | stuk | 41,75 | 192 | 1 |
| 0403717 | cartouche Domo compleet 30 liter | | K326001 | stuk | 54,50 | 192 | 1 |
| 0403660 | cartouche Vita-Uno compleet | | K32U000 | stuk | 70,50 | 192 | 1 |
| 0404470 | cartouche neomat | | Z501969 | stuk | 69,00 | 192 | 1 |
| 0404462 | kraanschijfjes voor normaal bovendeel | | Z600780 | stuk | 1,60 | 192 | 1 |
| 0403725 | O-ringen Domo/Orcino voor keukenkraan | | Z200219 | stuk | 8,80 | 192 | 1 |

| Art.nr | Specificaties | Kleur | Lev.nr | Ehd | Prijs | Grp | CC |
|--------|---------------|-------|--------|-----|-------|-----|----|
|--------|---------------|-------|--------|-----|-------|-----|----|

KWC Onderdelen

| | | | | | | | |
|---------|--|--|------------|------|------|-----|---|
| 0403850 | O-ringenset voor Luna m. draaibare uitloop | | Z504687 | stuk | 3,50 | 192 | 1 |
| 0404594 | stift voor inbouw bovendeel L120 | | Z602363931 | stuk | 5,40 | 192 | 1 |

Sanitair producten

Baden /
douchebakken /
stoomcabines

Kranen

Douchegarnituur

Accessoires en
spiegels

Douchewanden









Toebehoren &
afvoeren









Spoel- &
installatiesystemen

Badkamermeubelen
en toiletkasten

Gootstenen en
wastroggen

Utiliteit

| Art.nr | Specificaties | Kleur | Lev.nr | Ehd | Prijs | Grp | CC | | |
|--|---------------|--------|---------|------|--------|-----|----|---|---|
| | | | | | | | | Nobili Dune | |
| 1-gats wastafelkraan m. waste 0492116 | | chroom | 21118 | stuk | 134,00 | 150 | 1 |  | Sanitair producten |
| douchekraan HOH=15cm m. koppelingen z. omstel 0492124 | | chroom | 21130 | stuk | 108,00 | 150 | 1 |  | Baden / douchebakken / stoomcabines |
| badkraan m. koppelingen m. omstel m. garnituur 0492108 | | chroom | 211101 | stuk | 153,00 | 150 | 1 |  | Douchegarnituur |
| | | | | | | | | Nobili Palladio (Designed by Pininfarina) | |
| bidetkraan m. waste 0492744 | | chroom | 33119 | stuk | 177,00 | 150 | 1 |  | Accessoires en spiegels |
| | | | | | | | | Nobili Wishwash Plus | |
| 1-gats wastafelkraan m. waste 120mm 0492109 | | chroom | S1181CR | stuk | 193,00 | 196 | 1 |  | Toebehoren & afvoeren |
| 1-gats wastafelkraan m. waste 110mm 0492111 | | chroom | S1281CR | stuk | 200,00 | 196 | 1 |  | Spoel- & installatiesystemen |
| 1-gats wastafelkraan m. waste 150mm 0492112 | | chroom | S1381CR | stuk | 193,00 | 196 | 1 |  | Badkamermeubelen en toiletkasten |
| 1-gats wastafelkraan m. waste 185cm 0492113 | | chroom | S1481CR | stuk | 200,00 | 196 | 1 |  | Gootstenen en wastroggen |
| wandkraan 240mm 0492114 | | chroom | S198CR | stuk | 182,00 | 196 | 1 |  | Utiliteit |

| | Art.nr | Specificaties | Kleur | Lev.nr | Ehd | Prijs | Grp | CC |
|---|---|--|--------|----------|------|---------|-----|----|
| | Nobili Wishwash Plus | | | | | | | |
| Sanitair producten | | 1-gats bidetkraan sprong 110mm 0492117 | chroom | S1391CR | stuk | 193,00 | 196 | 1 |
| Baden / douchebakken / stoomcabines |  | | | | | | | |
| Kranen | | opbouw douchekraan m. glijstangset 0492130 | chroom | S13010CR | stuk | 561,00 | 196 | 1 |
| Douchegarnituur |  | | | | | | | |
| Accessoires en spiegels | | opbouw douchekraan m. hoofddouche m. glijstang 0492123 | chroom | S13030CR | stuk | 1057,00 | 196 | 1 |
| Douchewanden |  | | | | | | | |
| Toebehoren & afvoeren | | inbouwdouchekraan m. glijstangset 0492125 | chroom | S14010CR | stuk | 441,00 | 196 | 1 |
| Douchewanden |  | | | | | | | |
| Spoel- & installatiesystemen | | inbouwdouchekraan m. hoofddouche m. glijstang 0492126 | chroom | S14030CR | stuk | 1144,00 | 196 | 1 |
| Badkamermeubelen en toiletkasten |  | | | | | | | |
| Gootstenen en wastroggen | | badkraan m. garnituur 0492127 | chroom | S110CR | stuk | 375,00 | 196 | 1 |
| Utiliteit |  | | | | | | | |
| | | inbouwbadkraan m. garnituur 0492128 | chroom | S150CR | stuk | 345,00 | 196 | 1 |
| |  | | | | | | | |
| | | inbouwthermostaat 5-weg 0492129 | chroom | S42500CR | stuk | 549,00 | 196 | 1 |
| |  | | | | | | | |
| | | afvoerplug 5/4" 0492118 | chroom | S11010CR | stuk | 40,25 | 196 | 1 |
| |  | | | | | | | |

| Art.nr | Specificaties | Kleur | Lev.nr | Ehd | Prijs | Grp | CC | |
|---|---------------|--------|--------|------|---------|-----|----|---|
| Oras Il Bagno Alessi | | | | | | | | |
| 1-gats wastafelkraan m. flexibele aansluiting 0084044 | | chroom | 8500F | stuk | 337,00 | 199 | 1 | |
| 1-gats wandkraan 0084045 | | chroom | 8510 | stuk | 558,00 | 199 | 1 |  |
| 1-gats bidetkraan m. flexibele aansluitingen 0084047 | | chroom | 8518F | stuk | 392,00 | 199 | 1 | |
| 4-gats badrandcombinatie 0084051 | | chroom | 8540 | stuk | 724,00 | 199 | 1 |  |
| douchekraan z. omstel m. garnituur 0084049 | | chroom | 8560 | stuk | 586,00 | 199 | 1 |  |
| badkraan m. omstel m. garnituur 0084048 | | chroom | 8545 | stuk | 696,00 | 199 | 1 |  |
| badkraan vloermontage H=93.5cm 0084052 | | chroom | 8550 | stuk | 1807,00 | 199 | 1 |  |
| inbouwset voor douche-/badkraan 0481036 | | chroom | 8586 | stuk | 187,00 | 199 | 1 | |
| afbouwset voor inbouwbadkraan m. omstel 0481037 | | chroom | 8598 | stuk | 306,00 | 199 | 1 | |
| 0481036 inbouwset voor douche-/badkraan | chroom | | 8586 | stuk | 187,00 | 199 | 1 | |
| afbouwset voor inbouwdouchekraan z. omstel 0481038 | | chroom | 8597 | stuk | 265,00 | 199 | 1 | |
| 0481036 inbouwset voor douche-/badkraan | chroom | | 8586 | stuk | 187,00 | 199 | 1 | |

Sanitair producten

Baden /
douchebakken /
stoomcabines

Kranen









Douchegarnituur

Accessoires en
spiegels

Douchewanden

Toebehoren &
afvoerenSpoel- &
installatiesystemenBadkamermeubelen
en toiletkastenGootstenen en
wastroggen

Utiliteit

| | Art.nr | Specificaties | Kleur | Lev.nr | Ehd | Prijs | Grp | CC | | |
|---|---|--|-----------|-----------|---------|---------|--------|-------|-----|---|
| | Plieger Brussel | | | | | | | | | |
| Sanitair producten |  | toiletkraan m. straalregelaar | | | | | | | | |
| | | 0690546 | | chroom | 0690546 | stuk | 23,00 | 150 | 0 | |
| | | 0690392 | keramisch | chroom | 0690392 | stuk | 28,00 | 150 | 0 | |
| Baden / douchebakken / stoomcabines | | toiletkraan m. straalregelaar m. draaibare uitloop | | | | | | | | |
| Kranen |  | 0690554 | | chroom | 0690554 | stuk | 35,50 | 150 | 0 | |
| | | 0690406 | keramisch | chroom | 0690406 | stuk | 44,50 | 150 | 0 | |
| Douchegarnituur | | 1-gats wastafelkraan m. straalregelaar m. ketting | | | | | | | | |
| Accessoires en spiegels |  | 0690562 | | chroom | 0690562 | stuk | 49,00 | 150 | 0 | |
| | | 0690414 | keramisch | chroom | 0690414 | stuk | 61,50 | 150 | 0 | |
| Douchewanden | | douchekraan brugmodel z. koppelingen z. omstel | | | | | | | | |
| Toebehoren & afvoeren |  | 0690589 | HOH=12cm | chroom | 0690589 | stuk | 33,25 | 150 | 0 | |
| | | 0690430 | HOH=12cm | keramisch | chroom | 0690430 | stuk | 47,25 | 150 | 0 |
| | | 0690487 | HOH=15cm | | chroom | 0690487 | stuk | 33,00 | 150 | 0 |
| | | 0690485 | HOH=15cm | keramisch | chroom | 0690485 | stuk | 49,25 | 150 | 0 |
| | | douchekraan HOH=12cm brugmodel z. koppelingen m. omstel | | | | | | | | |
| Spoel- & installatiesystemen |  | 0690597 | | chroom | 0690597 | stuk | 50,50 | 150 | 0 | |
| | | 0690449 | keramisch | chroom | 0690449 | stuk | 65,50 | 150 | 0 | |
| Badkamermeubelen en toiletkasten | | badkraan z. koppelingen m. omstel | | | | | | | | |
| Gootstenen en wastroggen |  | 0690600 | | chroom | 0690600 | stuk | 67,50 | 150 | 0 | |
| | | 0690457 | keramisch | chroom | 0690457 | stuk | 78,50 | 150 | 0 | |
| Utiliteit | | douchethermostaat z. koppelingen | | | | | | | | |
| |  | 0690856 | HOH=12cm | chroom | 0690856 | stuk | 149,00 | 150 | 0 | |
| | | 0690864 | HOH=15cm | chroom | 0690864 | stuk | 155,00 | 150 | 0 | |
| | | badthermostaat z. koppelingen | | | | | | | | |
| |  | 0690848 | | chroom | 0690848 | stuk | 192,00 | 150 | 0 | |
| | | wandkraan z. koppelingen m. S-uitloop | | | | | | | | |
| |  | 0690619 | | chroom | 0690619 | stuk | 48,00 | 150 | 0 | |
| | | 0690465 | keramisch | chroom | 0690465 | stuk | 58,00 | 150 | 0 | |
| | | afdekopje voor kraanknop | | | | | | | | |
| | | 0690515 | koud | chroom | 0690515 | stuk | 2,06 | 150 | 1 | |
| | | 0690517 | warm | chroom | 0690517 | stuk | 2,06 | 150 | 1 | |

| Art.nr | Specificaties | Kleur | Lev.nr | Ehd | Prijs | Grp | CC |
|--------|---------------|-------|--------|-----|-------|-----|----|
|--------|---------------|-------|--------|-----|-------|-----|----|

Plieger Charleston

fonteinkraan m. kruisknop

| | | | | | | | |
|---------|--|-------------|---------|------|-------|-----|---|
| 0492078 | | chroom | 0492078 | stuk | 34,00 | 150 | 0 |
| 0492092 | | chroom/goud | 0492092 | stuk | 42,75 | 150 | 0 |



Sanitair producten

fonteinkraan hoog model

| | | | | | | | |
|---------|--|-------------|---------|------|-------|-----|---|
| 0492084 | | chroom | 0492084 | stuk | 38,50 | 150 | 0 |
| 0492085 | | chroom/goud | 0492085 | stuk | 42,50 | 150 | 0 |

Baden /
douchebakken /
stoomcabines

Kranen

1-gats wastafelkraan m. kruisknop m. uitloop 13cm

| | | | | | | | |
|---------|----------|-------------|---------|------|--------|-----|---|
| 0492096 | z. waste | chroom | 0492096 | stuk | 94,00 | 150 | 0 |
| 0491985 | m. waste | chroom | 0491985 | stuk | 104,00 | 150 | 0 |
| 0492098 | m. waste | chroom/goud | 0492098 | stuk | 144,00 | 150 | 0 |



Douchegarnituur

Accessoires en
spiegels

3-gats wastafelkraan m. kruisknop m. waste m. uitloop 13cm

| | | | | | | | |
|---------|--|-------------|---------|------|--------|-----|---|
| 0492019 | | chroom | 0492019 | stuk | 147,00 | 150 | 0 |
| 0492100 | | chroom/goud | 0492100 | stuk | 170,00 | 150 | 0 |



Douchewanden

douchekraan m. kruisknop HOH=12cm m. omstel m. koppelingen

| | | | | | | | |
|---------|--|-------------|---------|------|--------|-----|---|
| 0492086 | | chroom | 0492086 | stuk | 89,50 | 150 | 0 |
| 0492104 | | chroom/goud | 0492104 | stuk | 110,00 | 150 | 0 |

Toebehoren &
afvoerenSpoel- &
installatiesystemen

douchekraan m. kruisknop HOH=15cm z. omstel m. koppelingen

| | | | | | | | |
|---------|--|--------|---------|------|-------|-----|---|
| 0492043 | | chroom | 0492043 | stuk | 75,50 | 150 | 0 |
|---------|--|--------|---------|------|-------|-----|---|

Badkamermeubelen
en toiletkasten

badkraan m. kruisknop m. garnituur

| | | | | | | | |
|---------|--|-------------|---------|------|--------|-----|---|
| 0491969 | | chroom | 0491969 | stuk | 176,00 | 150 | 0 |
| 0492106 | | chroom/goud | 0492106 | stuk | 201,00 | 150 | 0 |

Gootstenen en
wastroggen

4-gats badrandcombinatie

| | | | | | | | |
|---------|--|-------------|---------|------|--------|-----|---|
| 0492110 | | chroom | 0492110 | stuk | 365,00 | 150 | 0 |
| 0492115 | | chroom/goud | 0492115 | stuk | 307,25 | 150 | 0 |



Utiliteit

Plieger Liberty

1-gats wastafelkraan m. waste

| | | | | | | | |
|---------|--|--------|---------|------|--------|-----|---|
| 0692646 | | chroom | 0692646 | stuk | 144,00 | 394 | 0 |
|---------|--|--------|---------|------|--------|-----|---|



badkraan m. koppelingen z. garnituur

| | | | | | | | |
|---------|--|--------|---------|------|--------|-----|---|
| 0692611 | | chroom | 0692611 | stuk | 171,00 | 394 | 0 |
|---------|--|--------|---------|------|--------|-----|---|





| | Art.nr | Specificaties | Kleur | Lev.nr | Ehd | Prijs | Grp | CC |
|---|------------------------|--|--------------------------------------|---------|---------|--------|--------|-----|
| Sanitair producten | Plieger Liberty | | | | | | | |
| | | douchekraan m. koppelingen z. omstel | chroom | 0692638 | stuk | 120,00 | 394 | 0 |
| Baden / douchebakken / stoomcabines | | douchethermostaat HOH=15cm m. koppelingen | chroom | 0693385 | stuk | 219,00 | 150 | 0 |
| | Kranen | | badthermostaat m. koppelingen | chroom | 0693380 | stuk | 253,00 | 150 |
| Douchegarnituur | | | | | | | | |
| Accessoires en spiegels | | | | | | | | |
| Douchewanden | | | | | | | | |
| Toebehoren & afvoeren | | | | | | | | |
| Spoel- & installatiesystemen | | | | | | | | |
| Badkamermeubelen en toiletkasten | | | | | | | | |
| Gootstenen en wastroggen | | | | | | | | |
| Utiliteit | | | | | | | | |



Fris, jong en compleet

Met een frisse uitstraling is Spring de serie voor diegenen, voor wie een eigentijdse vormgeving net zo belangrijk is als betaalbare kwaliteit.



| | Art.nr | Specificaties | Kleur | Lev.nr | Ehd | Prijs | Grp | CC |
|---|---|---|-------|---------|------|--------|-----|----|
| Sanitair producten | Plieger Spring New | | | | | | | |
| |  | 1-gats wastafelkraan m. waste 0690504 | chrom | 0690504 | stuk | 102,00 | 150 | 0 |
| Baden / douchebakken / stoomcabines |  | 1-gats wastafelkraan z. waste 0690505 | chrom | 0690505 | stuk | 102,00 | 150 | 0 |
| Kranen | badkraan m. omstel m. koppelingen | | | | | | | |
| Douchegarnituur |  | 0690506 | chrom | 0690506 | stuk | 128,00 | 150 | 0 |
| Accessoires en spiegels | douchekraan z. omstel m. koppelingen keramisch | | | | | | | |
| Douchewanden |  | 0690507 | chrom | 0690507 | stuk | 111,00 | 150 | 0 |
| Toebehoren & afvoeren | Plieger Spring Project | | | | | | | |
| Spoel- & installatiesystemen |  | 0690481 z. waste | chrom | 0690481 | stuk | 69,00 | 150 | 0 |
| | | 0690473 m. waste | chrom | 0690473 | stuk | 76,00 | 150 | 0 |
| Badkamermeubelen en toiletkasten |  | douchekraan keramisch HOH=15cm z. koppelingen z. omstel 0690511 | chrom | 0690511 | stuk | 64,50 | 150 | 0 |
| Gootstenen en wastroggen |  | badkraan keramisch z. koppelingen m. omstel 0690538 | chrom | 0690538 | stuk | 80,50 | 150 | 0 |
| Utiliteit | Plieger Gina | | | | | | | |
| |  | wandfonteinkraan 1/2" 4333056 | chrom | 4333056 | stuk | 52,50 | 150 | 0 |
| | Plieger Kusasi | | | | | | | |
| |  | wastafelkraan verhoogd 4333322 | chrom | 4333322 | stuk | 157,00 | 150 | 0 |
| | | 4333332 | inox | 4333332 | stuk | 236,00 | 150 | 0 |

| Art.nr | Specificaties | Kleur | Lev.nr | Ehd | Prijs | Grp | CC |
|--------|---------------|-------|--------|-----|-------|-----|----|
|--------|---------------|-------|--------|-----|-------|-----|----|

Plieger Kusasi

fonteinkraan

| | | | | | | | |
|---------|--|-------|---------|------|-------|-----|---|
| 4333340 | | chrom | 4333340 | stuk | 60,50 | 150 | 0 |
|---------|--|-------|---------|------|-------|-----|---|



Sanitair producten

Baden /
douchebakken /
stoomcabines

Plieger Lupo

fonteinkraan 1/2"

| | | | | | | | |
|---------|--|-------|---------|------|-------|-----|---|
| 4333050 | | chrom | 4333050 | stuk | 36,00 | 150 | 0 |
|---------|--|-------|---------|------|-------|-----|---|



Kranen

Douchegarnituur

Plieger Pico

fonteinkraan 3/8"

| | | | | | | | |
|---------|--|-------|---------|------|-------|-----|---|
| 4333054 | | chrom | 4333054 | stuk | 60,00 | 150 | 0 |
|---------|--|-------|---------|------|-------|-----|---|

Accessoires en
spiegels

Douchewanden

Plieger Toebehoren

| | | | | | | | |
|---------|--|-------|-----------|------|-------|-----|---|
| 0490792 | S-koppeling m. rozet per paar 1/2"x3/8" | chrom | 0490792 | paar | 3,62 | 150 | 0 |
| 0492310 | S-koppeling m. rozet per paar 3/4"x3/8" | chrom | 0492310 | paar | 8,00 | 150 | 0 |
| 0490784 | S-koppeling m. rozet per paar 3/4"x1/2" | chrom | 0490784 | paar | 4,22 | 150 | 0 |
| 0491918 | S-koppeling m. rozet per paar 1/2"x3/8" | chrom | GS0002010 | paar | 5,30 | 150 | 0 |
| 0491896 | S-koppeling m. rozet per paar 3/4"x1/2" | chrom | GS0002012 | paar | 2,98 | 150 | 0 |
| 0491950 | rozet voor koppeling per paar 1/2"x3/8" | chrom | GS0011024 | paar | 2,73 | 150 | 0 |
| 0491926 | rozet voor koppeling per paar 3/4"x1/2" | chrom | GS0011023 | paar | 3,23 | 150 | 0 |
| 4320007 | S-koppeling afsluitbaar per paar 3/4"x1/2" | chrom | 4320007 | paar | 42,25 | 150 | 0 |
| 0490814 | muurplaatkoppeling m. rozet per paar 1/2"x12mm | chrom | 0490814 | paar | 4,75 | 150 | 0 |
| 0490806 | muurplaatkoppeling m. rozet per paar 3/4"x15mm | chrom | 0490806 | paar | 5,60 | 150 | 0 |
| 0492027 | rozet voor muurplaatkoppeling per paar 3/4"x15mm | chrom | 0492027 | paar | 2,56 | 150 | 0 |
| 0490229 | S-uitloop voor keukenkraan 17cm | | GP0007021 | stuk | 13,25 | 150 | 0 |
| 0490830 | S-uitloop voor douchemengkraan 25cm | | GP0007050 | stuk | 13,75 | 150 | 0 |
| 0490466 | U-uitloop voor douchemengkraan 15cm | chrom | GP0007055 | stuk | 10,25 | 150 | 1 |
| 0490210 | U-uitloop voor keukenkraan 20cm | chrom | GP0007022 | stuk | 13,25 | 150 | 0 |
| 0490776 | U-uitloop voor douchemengkraan 20cm | chrom | GP0007001 | stuk | 12,75 | 150 | 1 |
| 0492477 | gegoten uitloop voor 1-gatsmengkraan sprong 15cm | chrom | GP0007040 | stuk | 34,00 | 150 | 0 |
| 0492485 | gegoten uitloop voor 1-gatsmengkraan sprong 20cm | chrom | GP0007041 | stuk | 39,50 | 150 | 0 |

Toebehoren &
afvoerenSpoel- &
installatiesystemenBadkamermeubelen
en toiletkastenGootstenen en
wastroggen

Plieger Onderdelen

| | | | | | | | |
|---------|--|-------|-----------|------|-------|-----|---|
| 0691275 | Brussel bovendeeel keramisch | | 0691275 | stuk | 6,30 | 150 | 0 |
| 0492584 | bovendeeel universeel transparant koud | | 06732002C | stuk | 8,80 | 150 | 0 |
| 0492586 | bovendeeel universeel transparant warm | | 06732001C | stuk | 8,80 | 150 | 0 |
| 0690971 | kraanhendel Liberty | chrom | 0690971 | stuk | 17,25 | 394 | 1 |
| 0490035 | greep Charleston koud | chrom | GP900K40C | stuk | 11,25 | 150 | 0 |
| 0490037 | greep Charleston warm | chrom | GP900W40C | stuk | 11,25 | 150 | 0 |
| 0690870 | Brussel temperatuurknop | chrom | 0690870 | stuk | 8,00 | 150 | 1 |
| 0690873 | Brussel aan/uit kraanknop | | 0690873 | stuk | 1,55 | 150 | 1 |
| 0690973 | Liberty omstelknop | | 0690973 | stuk | 7,30 | 394 | 1 |
| 0690975 | Liberty kenplaatje | | 0690975 | stuk | 0,61 | 394 | 1 |
| 0690510 | Spring cartouche voor kraan m. temperatuur begrenzer | | 0690510 | stuk | 12,75 | 150 | 0 |
| 0690828 | Spring aan/uit kraanknop | | 0690828 | stuk | 11,50 | 150 | 1 |
| 0690830 | Spring omstelknop | chrom | 0690830 | stuk | 0,42 | 150 | 1 |
| 0690832 | Spring omstelmechanisme z. knop | | 0690832 | stuk | 2,08 | 150 | 1 |
| 0490031 | afdekkap binnenwerk | chrom | GS0011165 | stuk | 3,31 | 150 | 0 |
| 0490049 | knop koud | | GP0002050 | stuk | 2,28 | 921 | 0 |
| 0490047 | knop warm | | GP0002049 | stuk | 2,28 | 921 | 0 |
| 0492000 | omstelknop voor douchemengkraan PVC | | GS0002024 | stuk | 1,78 | 150 | 0 |
| 0490051 | PVC tule voor 2001/3001 | | GS0014197 | stuk | 0,10 | 150 | 0 |
| 0492329 | PVC tule voor knop acryl | | GS0014038 | stuk | 0,17 | 150 | 0 |
| 0690526 | Spring New omstel voor badkraan | | 0690526 | stuk | 47,75 | 150 | 0 |
| 0690525 | Spring New afdekkopje voor kraanhendel | | 0690525 | stuk | 1,33 | 150 | 0 |
| 0690524 | Spring New imbusschroef voor kraanhendel | | 0690524 | stuk | 1,33 | 150 | 0 |
| 0690523 | Spring New kraanhendel los | chrom | 0690523 | stuk | 25,00 | 150 | 0 |
| 0690522 | bevestigingsset voor hendel | | 0690522 | stuk | 0,45 | 262 | 0 |

Utiliteit

| Art.nr | Specificaties | Kleur | Lev.nr | Ehd | Prijs | Grp | CC |
|---------------------------|------------------------------------|-------|---------|------|-------|-----|----|
| Plieger Onderdelen | | | | | | | |
| 0690521 | cartouche | | 0690521 | stuk | 45,25 | 262 | 0 |
| 0690520 | montagesleutel 6-kantig | | 0690520 | stuk | 7,40 | 262 | 0 |
| 0690527 | bevestigingsset voor wastafelkraan | | 0690527 | stuk | 11,25 | 262 | 1 |

Sanitair producten

Baden /
douchebakken /
stoomcabines

Kranen

Douchegarnituur

Accessoires en
spiegels

Douchewanden

Toebehoren &
afvoeren

Spoel- &
installatiesystemen

Badkamermeubelen
en toiletkasten

Gootstenen en
wastroggen

Utiliteit

Zelfsluitende kranen. Van SCHELL.



 SCHELL



PETIT SC

Door een ongecompliceerde opbouw is een minimaal aantal onderdelen vereist. De PETIT SC is de ideale zelfsluitende kraan voor kleine wastafels en voor toepassingen waar lage investeringen belangrijk zijn, maar de gebruiker geen compromissen wenst inzake kwaliteit en design. Art. nr. 02 122 06 99.

Hamers & Kesber
Rokerijweg 2
NL-1271 AH Huizen
Tel. ++ 31 35 6 56 68 88
Fax ++ 31 35 5 25 70 06
info@hamerskesber.nl
www.schell-armaturen.de

| | Art.nr | Specificaties | Kleur | Lev.nr | Ehd | Prijs | Grp | CC |
|---|---|------------------------------------|-------|-----------|------|--------|-----|----|
| Sanitair producten | Schell Petit SC | | | | | | | |
| | | zelfsluitende wastafelkraan | | | | | | |
| | 0440168 | | chrom | 021220699 | stuk | 84,50 | 210 | 1 |
| Baden / douchebakken / stoomcabines | Schell Puris | | | | | | | |
| | | wastafelkraan elektronisch | | | | | | |
| | 0721220 | | chrom | 012010699 | stuk | 408,00 | 369 | 1 |
| Kranen | zelfsluitende wastafelkraan SC-K | | | | | | | |
| | | | | | | | | |
| | 0440166 | | chrom | 021100699 | stuk | 156,00 | 210 | 1 |
| Douchegarnituur | Schell Venus | | | | | | | |
| | | wastafelkraan elektronisch | | | | | | |
| | 0721239 | | chrom | 012060699 | stuk | 435,00 | 369 | 1 |
| Accessoires en spiegels | | | | | | | | |
| Douchewanden | | | | | | | | |
| Toebehoren & afvoeren | | | | | | | | |
| Spoel- & installatiesystemen | | | | | | | | |
| Badkamermeubelen en toiletkasten | | | | | | | | |
| Gootstenen en wastroggen | | | | | | | | |
| Utiliteit | | | | | | | | |

| Art.nr | Specificaties | Kleur | Lev.nr | Ehd | Prijs | Grp | CC | |
|---|---------------|--------|-----------|------|--------|-----|----|---|
| Sphinx 360 | | | | | | | | |
| douchethermostaat 1/2" z. koppelingen 0412228 | | chroom | S8HT80000 | stuk | 243,00 | 213 | 0 | |
| badthermostaat 1/2" z. koppelingen m.omstel 0412236 | | chroom | S8HT81000 | stuk | 335,00 | 213 | 1 | |
| Sphinx 450 | | | | | | | | |
| 1-gats fonteinkraan 0411906 | | chroom | S8HT71000 | stuk | 223,00 | 213 | 0 |  |
| 1-gats wastafelkraan z. waste 0411825 | | chroom | S8HT73000 | stuk | 340,00 | 213 | 0 |  |
| 1-gats wastafelkraan verhoogd z. waste 0411922 | | chroom | S8HT73500 | stuk | 412,00 | 213 | 1 |  |
| 1-gats wastafelkraan m. waste 0411914 | | chroom | S8HT73001 | stuk | 376,00 | 213 | 1 |  |
| wandfonteinkraan 0282650 | | chroom | S8HT72000 | stuk | 266,00 | 213 | 1 |  |
| wastafel wandkraan 0411809 | | chroom | S8HT74000 | stuk | 325,00 | 213 | 1 |  |
| wastafel wandkraan verlengd 0411930 | | chroom | S8HT74500 | stuk | 394,00 | 213 | 1 |  |
| 1-gats bidetkraan m. waste 0411841 | | chroom | S8HT75000 | stuk | 340,00 | 213 | 1 |  |

Sanitair producten

Baden /
douchebakken /
stoomcabines

Kranen











Douchegarnituur

Accessoires en
spiegels

Douchewanden

Toebehoren &
afvoerenSpoel- &
installatiesystemenBadkamermeubelen
en toiletkastenGootstenen en
wastroggen

Utiliteit

| | Art.nr | Specificaties | Kleur | Lev.nr | Ehd | Prijs | Grp | CC |
|---|---|--|--------|-----------|------|--------|-----|----|
| Sanitair producten | Sphinx 450 | | | | | | | |
| |  | douchekraan m. koppelingen z. omstel 0411868 | chroom | S8HT76000 | stuk | 355,00 | 213 | 1 |
| Baden / douchebakken / stoomcabines |  | badkraan m. koppelingen m. omstel 0411876 | chroom | S8HT77000 | stuk | 443,00 | 213 | 1 |
| Kranen | Sphinx 450 | | | | | | | |
| |  | douchethermostaat m. koppelingen z. omstel 0411884 | chroom | S8HT86000 | stuk | 394,00 | 213 | 0 |
| Douchegarnituur |  | badthermostaat m. koppelingen m. omstel 0411892 | chroom | S8HT87000 | stuk | 479,00 | 213 | 1 |
| Accessoires en spiegels | Sphinx Atlantic | | | | | | | |
| Douchewanden | 1-gats fonteinkraan 0412260 | | | | | | | |
| |  | | chroom | S8HT61000 | stuk | 300,00 | 213 | 1 |
| Toebehoren & afvoeren | 1-gats wastafelkraan m. waste 0411148 | | | | | | | |
| |  | | chroom | S8HT62000 | stuk | 521,00 | 213 | 1 |
| Spoel- & installatiesystemen | douchethermostaat m. koppelingen z. omstel 0411884 | | | | | | | |
| Badkamermeubelen en toiletkasten | douchethermostaat m. koppelingen z. omstel 0411884 | | | | | | | |
| |  | | chroom | S8HT86000 | stuk | 394,00 | 213 | 0 |
| Gootstenen en wastroggen |  | badthermostaat m. koppelingen m. omstel 0411892 | chroom | S8HT87000 | stuk | 479,00 | 213 | 1 |
| Utiliteit | Sphinx Eurobase | | | | | | | |
| Utiliteit | kraanhendel kort 0411469 | | | | | | | |
| |  | | chroom | S8EKA206 | stuk | 16,25 | 213 | 0 |
| Utiliteit | 1-gats wastafelkraan m. draaibare uitloop 15cm 0411035 z. hendel | | | | | | | |
| |  | | chroom | S8EK15S | stuk | 150,00 | 213 | 0 |
| | | 0411388 kraanhendel SK 220mm lang | chroom | S8EKA217 | stuk | 31,25 | 213 | 1 |
| | | 0411469 kraanhendel kort | chroom | S8EKA206 | stuk | 16,25 | 213 | 0 |
| | | 0411477 kraanhendel lang | chroom | S8EKA230 | stuk | 31,25 | 213 | 0 |
| Utiliteit | 1-gats wastafelkraan m. kettinghouder m. uitloop 0411043 z. hendel | | | | | | | |
| |  | | chroom | S8EK01S | stuk | 117,00 | 213 | 0 |
| | | 0411388 kraanhendel SK 220mm lang | chroom | S8EKA217 | stuk | 31,25 | 213 | 1 |
| | | 0411469 kraanhendel kort | chroom | S8EKA206 | stuk | 16,25 | 213 | 0 |
| | | 0411477 kraanhendel lang | chroom | S8EKA230 | stuk | 31,25 | 213 | 0 |

| Art.nr | Specificaties | Kleur | Lev.nr | Ehd | Prijs | Grp | CC |
|--------|---------------|-------|--------|-----|-------|-----|----|
|--------|---------------|-------|--------|-----|-------|-----|----|

Sphinx Eurobase

1-gats wastafelkraan m. ketting z. ketting

| | | | | | | | |
|---------|---------------------------|--------|----------|------|--------|-----|---|
| 0412112 | z. hendel | chroom | S8EK03S | stuk | 120,00 | 213 | 1 |
| 0411388 | kraanhendel SK 220mm lang | chroom | S8EKA217 | stuk | 31,25 | 213 | 1 |
| 0411469 | kraanhendel kort | chroom | S8EKA206 | stuk | 16,25 | 213 | 0 |
| 0411477 | kraanhendel lang | chroom | S8EKA230 | stuk | 31,25 | 213 | 0 |

1-gats wastafelkraan m. waste

| | | | | | | | |
|---------|---------------------------|--------|----------|------|--------|-----|---|
| 0411280 | z. hendel | chroom | S8EK02S | stuk | 149,00 | 213 | 1 |
| 0411388 | kraanhendel SK 220mm lang | chroom | S8EKA217 | stuk | 31,25 | 213 | 1 |
| 0411469 | kraanhendel kort | chroom | S8EKA206 | stuk | 16,25 | 213 | 0 |
| 0411477 | kraanhendel lang | chroom | S8EKA230 | stuk | 31,25 | 213 | 0 |



Sanitair producten

Baden /
douchebakken /
stoomcabines

Kranen

douchekraan HOH=12cm z. koppelingen z. omstel

| | | | | | | | |
|---------|---------------------------|--------|----------|------|--------|-----|---|
| 0411094 | z. hendel | chroom | S8EK09S | stuk | 109,00 | 213 | 0 |
| 0411388 | kraanhendel SK 220mm lang | chroom | S8EKA217 | stuk | 31,25 | 213 | 1 |
| 0411469 | kraanhendel kort | chroom | S8EKA206 | stuk | 16,25 | 213 | 0 |
| 0411477 | kraanhendel lang | chroom | S8EKA230 | stuk | 31,25 | 213 | 0 |



Douchegarnituur

douchekraan HOH=15cm z. koppelingen z. omstel

| | | | | | | | |
|---------|---------------------------|--------|----------|------|--------|-----|---|
| 0412139 | z. hendel | chroom | S8EK26S | stuk | 114,00 | 213 | 1 |
| 0411116 | z. hendel | chroom | S8EK10S | stuk | 106,00 | 213 | 1 |
| 0411388 | kraanhendel SK 220mm lang | chroom | S8EKA217 | stuk | 31,25 | 213 | 1 |
| 0411469 | kraanhendel kort | chroom | S8EKA206 | stuk | 16,25 | 213 | 0 |
| 0411477 | kraanhendel lang | chroom | S8EKA230 | stuk | 31,25 | 213 | 0 |

Accessoires en
spiegels

Douchewanden

badkraan m. omstel z. koppelingen

| | | | | | | | |
|---------|---------------------------|--------|----------|------|--------|-----|---|
| 0411124 | z. hendel | chroom | S8EK11S | stuk | 159,00 | 213 | 1 |
| 0411388 | kraanhendel SK 220mm lang | chroom | S8EKA217 | stuk | 31,25 | 213 | 1 |
| 0411469 | kraanhendel kort | chroom | S8EKA206 | stuk | 16,25 | 213 | 0 |
| 0411477 | kraanhendel lang | chroom | S8EKA230 | stuk | 31,25 | 213 | 0 |

Toebehoren &
afvoeren**toiletkraan standaard 1/2"**

| | | | | | | | |
|---------|--|--------|--------|------|-------|-----|---|
| 0411036 | | chroom | S8EK55 | stuk | 38,00 | 213 | 1 |
|---------|--|--------|--------|------|-------|-----|---|

Spoel- &
installatiesystemen

Sphinx Euromed

kraanhendel lang

| | | | | | | | |
|---------|--|--------|----------|------|-------|-----|---|
| 0411477 | | chroom | S8EKA230 | stuk | 31,25 | 213 | 0 |
|---------|--|--------|----------|------|-------|-----|---|

Badkamermeubelen
en toiletkasten**1-gats wastafelkraan m. ketting m. hendel**

| | | | | | | | |
|---------|--|--------|--------|------|--------|-----|---|
| 0411605 | | chroom | S8SK03 | stuk | 151,00 | 213 | 1 |
|---------|--|--------|--------|------|--------|-----|---|

toiletkraan 1/2" m. keramisch bovendeeel m. lange grijze hendel

| | | | | | | | |
|---------|--|--------|--------|------|-------|-----|---|
| 0410977 | | chroom | S8SK55 | stuk | 56,00 | 213 | 0 |
|---------|--|--------|--------|------|-------|-----|---|

Gootstenen en
wastroggen

Utiliteit

toiletkraan 1/2" m. keramisch bovendeeel m. lange chroom hendel

| | | | | | | | |
|---------|--|--------|----------|------|-------|-----|---|
| 0410985 | | chroom | S8SK55MC | stuk | 73,50 | 213 | 0 |
|---------|--|--------|----------|------|-------|-----|---|



Sphinx Forma

wastafelkraan m. waste

| | | | | | | | |
|---------|--|--------|-----------|------|--------|-----|---|
| 0333112 | | chroom | S8HT22000 | stuk | 282,00 | 213 | 0 |
|---------|--|--------|-----------|------|--------|-----|---|

wastafelkraan z. waste

| | | | | | | | |
|---------|--|--------|-----------|------|--------|-----|---|
| 0333111 | | chroom | S8HT23000 | stuk | 253,00 | 213 | 1 |
|---------|--|--------|-----------|------|--------|-----|---|











bidetkraan m. waste

| | | | | | | | |
|---------|--|--------|-----------|------|--------|-----|---|
| 0333113 | | chroom | S8HT24000 | stuk | 282,00 | 213 | 1 |
|---------|--|--------|-----------|------|--------|-----|---|

douchethermostaat z. koppelingen z. omstel

| | | | | | | | |
|---------|--|--------|-----------|------|--------|-----|---|
| 0333114 | | chroom | S8HT84000 | stuk | 310,00 | 213 | 1 |
|---------|--|--------|-----------|------|--------|-----|---|

| | Art.nr | Specificaties | Kleur | Lev.nr | Ehd | Prijs | Grp | CC | |
|---|---|---|--------------------------------|-----------|----------|--------|--------|-----|---|
| Sanitair producten | Sphinx Forma | | | | | | | | |
| | | badthermostaat z. koppelingen m. omstel | | | | | | | |
| | 0333116 | | chroom | S8HT85000 | stuk | 338,00 | 213 | 1 | |
| Baden / douchebakken / stoomcabines | Sphinx Uniq | | | | | | | | |
| | | fonteinkraan | | | | | | | |
| | 0333110 | | chroom | S8HT21000 | stuk | 113,00 | 213 | 1 | |
| Kranen | Sphinx Universeel | | | | | | | | |
| |  | douchethermostaat HOH=15cm z. koppelingen z. omstel | | | | | | | |
| | | 0411485 | | chroom | S8TK30 | stuk | 164,00 | 213 | 1 |
| | | 0410993 | m. keramisch bovendeel | chroom | S8TK35 | stuk | 175,00 | 213 | 0 |
| Douchegarnituur |  | douchethermostaat HOH=15cm z. koppelingen z. omstel m. grijze hendel | | | | | | | |
| | | 0411159 | | chroom | S8TK32 | stuk | 296,00 | 213 | 0 |
| Accessoires en spiegels | badthermostaat HOH=15cm z. koppelingen m. omstel | | | | | | | | |
| |  | 0411493 | | chroom | S8TK31 | stuk | 213,00 | 213 | 1 |
| | 0411140 | m. keramisch bovendeel | chroom | S8TK36 | stuk | 223,00 | 213 | 1 | |
| Douchewanden |  | badthermostaat HOH=15cm z. koppelingen m. omstel m. grijze hendel | | | | | | | |
| | 0411221 | | chroom | S8TK37 | stuk | 347,00 | 213 | 1 | |
| Toebehoren & afvoeren | wandthermostaat HOH=15cm z. koppelingen m. grijze hendel | | | | | | | | |
| |  | 0411264 | m. uitloop 20cm | chroom | S8TK40 | stuk | 333,00 | 213 | 1 |
| | 0412201 | m. uitloop 16cm | chroom | S8TK41 | stuk | 333,00 | 213 | 1 | |
| Spoel- & installatiesystemen | baduitloop m. omstel | | | | | | | | |
| |  | 0411396 | | chroom | S8TKA400 | stuk | 49,00 | 213 | 1 |
| Gootstenen en wastroggen | Sphinx Onderdelen | | | | | | | | |
| Utiliteit | | 0411442 | aanvullingsset grijs kunststof | | S8TKA200 | stuk | 14,50 | 213 | 1 |
| | | 0411434 | cartouche turbo nieuw | | S8EKP602 | stuk | 32,75 | 213 | 1 |
| | | 0411388 | kraanhendel SK 220mm lang | chroom | S8EKA217 | stuk | 31,25 | 213 | 1 |
| | | 0411472 | verhogingsring 50mm | | S8EKA715 | stuk | 33,00 | 213 | 1 |

| Art.nr | Specificaties | Kleur | Lev.nr | Ehd | Prijs | Grp | CC | | |
|---|-------------------------|-------------|----------|------|--------|-----|----|--|---|
| | | | | | | | | Venlo Arax | |
| wastafelkraan m. waste | | | | | | | | | |
| 0425281 | | chroom | H8202A01 | stuk | 136,00 | 210 | 1 |  | Sanitair producten |
| bidetkraan m. waste | | | | | | | | | |
| 0425303 | | chroom | H8231A01 | stuk | 177,00 | 210 | 1 |  | Baden / douchebakken / stoomcabines |
| douchekraan z. omstel m. koppelingen | | | | | | | | | |
| 0425311 | HOH=12cm | chroom | H8218A01 | stuk | 119,00 | 210 | 1 |  | Douchegarnituur |
| 0425338 | HOH=15cm | chroom | H8220A01 | stuk | 119,00 | 210 | 1 | | |
| badkraan m. omstel m. koppelingen | | | | | | | | | |
| 0425346 | HOH=15cm | chroom | H8226A01 | stuk | 155,00 | 210 | 1 |  | Accessoires en spiegels |
| | | | | | | | | Venlo Astro | |
| toiletkraan 1/2" | | | | | | | | | |
| 0422096 | | chroom | H2300A01 | stuk | 82,50 | 210 | 0 |  | Toebehoren & afvoeren |
| 0422231 | | chroom/goud | H2300C01 | stuk | 96,50 | 210 | 1 | | |
| 1-gats wastafelkraan m. waste | | | | | | | | | |
| 0422118 | | chroom | H2310A01 | stuk | 181,00 | 210 | 0 |  | Spoel- & installatiesystemen |
| 0422258 | | chroom/goud | H2310C01 | stuk | 227,00 | 210 | 1 | | |
| 1-gats wastafelkraan 1-hendel m. waste | | | | | | | | | |
| 0422259 | | chroom | H2310A02 | stuk | 242,00 | 210 | 1 |  | Gootstenen en wastroggen |
| 3-gats wastafelkraan m. waste | | | | | | | | | |
| 0422134 | | chroom | H2304A01 | stuk | 311,00 | 210 | 1 |  | Badkamermeubelen en toiletkasten |
| 0422266 | | chroom/goud | H2304C01 | stuk | 359,00 | 210 | 1 | | |
| 0422312 | hoekstopkraan 1/2"x1/2" | chroom/goud | H2338C01 | stuk | 82,50 | 210 | 1 | | |
| 1-gats bidetkraan m. waste | | | | | | | | | |
| 0422142 | | chroom | H2331A01 | stuk | 201,00 | 210 | 1 |  | Gootstenen en wastroggen |
| 0422274 | | chroom/goud | H2331C01 | stuk | 236,00 | 210 | 1 | | |
| hoekstopkraan 1/2"x1/2" | | | | | | | | | |
| 0422223 | | chroom | H2338A01 | stuk | 68,50 | 210 | 1 |  | Utiliteit |
| 0422312 | | chroom/goud | H2338C01 | stuk | 82,50 | 210 | 1 | | |

| | Art.nr | Specificaties | Kleur | Lev.nr | Ehd | Prijs | Grp | CC |
|---|---|---|------------|----------|------|--------|-----|----|
| Sanitair producten | Venlo Astro | | | | | | | |
| | douчекraan z. omstel m. koppelingen | | | | | | | |
| | 0422169 | HOH=15cm | chrom | H2320A01 | stuk | 132,00 | 210 | 0 |
| | 0422282 | HOH=15cm | chrom/goud | H2320C01 | stuk | 155,00 | 210 | 1 |
| Baden / douchebakken / stoomcabines | badkraan m. omstel m. koppelingen m. garnituur | | | | | | | |
| | 0422177 | | chrom | H2324A01 | stuk | 252,00 | 210 | 0 |
| | 0422178 | | chrom/goud | H2324C01 | stuk | 299,00 | 210 | 1 |
| Douchegarnituur | 5-gats badrandcombinatie | | | | | | | |
| | 0422207 | | chrom | H2328A01 | stuk | 585,00 | 210 | 1 |
| | 0422304 | | chrom/goud | H2328C01 | stuk | 704,00 | 210 | 1 |
| | 0424404 | montageplaat voor badrandcombinatie RVS | | H2193A69 | stuk | 216,00 | 210 | 0 |
| Accessoires en spiegels | douchethermostaat z. omstel m. koppelingen | | | | | | | |
| | 0422313 | HOH=15cm | chrom | H2346A01 | stuk | 660,00 | 210 | 1 |
| Douchewanden | inbouwstopkraan 1/2" | | | | | | | |
| | 0422283 | | chrom | H2343A01 | stuk | 88,00 | 210 | 1 |
| Toebehoren & afvoeren | doucheset voor bad | | | | | | | |
| | 0422399 | | chrom | H2360A07 | stuk | 95,50 | 210 | 1 |
| Badkamermeubelen en toiletkasten | Venlo Axxel | | | | | | | |
| | wastafelkraan m. waste | | | | | | | |
| | 0425354 | | chrom | H8302A01 | stuk | 195,00 | 210 | 1 |
| Gootstenen en wastroggen | wastafelkraan m. waste m. uittrekbare uitloop | | | | | | | |
| | 0425362 | | chrom | H8311A01 | stuk | 268,00 | 210 | 1 |
| Utiliteit | bidetkraan m. waste | | | | | | | |
| | 0425370 | | chrom | H8331A01 | stuk | 218,00 | 210 | 1 |
| | douчекraan z. omstel m. koppelingen | | | | | | | |
| | 0425389 | HOH=15cm | chrom | H8320A01 | stuk | 207,00 | 210 | 1 |

| Art.nr | Specificaties | Kleur | Lev.nr | Ehd | Prijs | Grp | CC |
|--------|---------------|-------|--------|-----|-------|-----|----|
|--------|---------------|-------|--------|-----|-------|-----|----|

Venlo Axxel

badkraan m.omstel m. koppelingen

| | | | | | | | |
|---------|----------|-------|----------|------|--------|-----|---|
| 0425419 | HOH=15cm | chrom | H8326A01 | stuk | 273,00 | 210 | 1 |
|---------|----------|-------|----------|------|--------|-----|---|



Sanitair producten

opbouwdeel voor inbouwbadkraan

| | | | | | | | |
|---------|---------------------------------------|-------|----------|------|--------|-----|---|
| 0425427 | | chrom | H8334A01 | stuk | 188,00 | 210 | 1 |
| 0425400 | inbouwdeel voor inbouwdouche-badkraan | chrom | H8134A01 | stuk | 113,00 | 210 | 1 |

Baden /
douchebakken /
stoomcabines**opbouwdeel voor inbouwdouchekraan**

| | | | | | | | |
|---------|---------------------------------------|-------|----------|------|--------|-----|---|
| 0425355 | | chrom | H8333A01 | stuk | 122,00 | 210 | 1 |
| 0425400 | inbouwdeel voor inbouwdouche-badkraan | chrom | H8134A01 | stuk | 113,00 | 210 | 1 |



Douchegarnituur

inbouwdeel voor inbouwdouche-badkraan

| | | | | | | | |
|---------|--|-------|----------|------|--------|-----|---|
| 0425400 | | chrom | H8134A01 | stuk | 113,00 | 210 | 1 |
|---------|--|-------|----------|------|--------|-----|---|

Douchewanden

Venlo Easy

1-gats wastafelthermostaat m. waste

| | | | | | | | |
|---------|--|-------|----------|------|--------|-----|---|
| 0426261 | | chrom | H3846A01 | stuk | 223,00 | 218 | 1 |
|---------|--|-------|----------|------|--------|-----|---|

douchethermostaat z. omstel m. koppelingen

| | | | | | | | |
|---------|---|-------|----------|------|--------|-----|---|
| 0426318 | HOH=15cm | chrom | H3846A05 | stuk | 176,00 | 218 | 1 |
| 0421251 | S-koppeling m. rozet per paar 1/2"x3/4" | chrom | H1040A06 | paar | 12,00 | 215 | 0 |

Toebehoren &
afvoeren

Venlo Neomix

2-gats kraan staand

| | | | | | | | |
|---------|---------------|-------|----------|------|--------|-----|---|
| 0421154 | uitloop 190mm | chrom | H5048A01 | stuk | 378,00 | 210 | 1 |
|---------|---------------|-------|----------|------|--------|-----|---|

Spoel- &
installatiesystemen**wandkraan z. koppelingen**

| | | | | | | | |
|---------|---------------|-------|----------|------|--------|-----|---|
| 0421766 | uitloop 145mm | chrom | H5045A01 | stuk | 280,00 | 210 | 1 |
| 0421790 | uitloop 190mm | chrom | H5045A03 | stuk | 280,00 | 210 | 1 |
| 0421812 | uitloop 250mm | chrom | H5045A04 | stuk | 280,00 | 210 | 1 |

Badkamermeubelen
en toiletkastenGootstenen en
wastroggen

Venlo Nimbus Medical

1-gats wastafelkraan m. lange hendel

| | | | | | | | |
|---------|--|-------|----------|------|--------|-----|---|
| 0425729 | | chrom | H7503A10 | stuk | 133,00 | 215 | 1 |
|---------|--|-------|----------|------|--------|-----|---|



Utiliteit









1-gats wastafelkraan m. draaibare uitloop m. lange hendel









| | | | | | | | |
|---------|--|-------|----------|------|--------|-----|---|
| 0425737 | | chrom | H7809A10 | stuk | 163,00 | 215 | 1 |
|---------|--|-------|----------|------|--------|-----|---|

**wandkraan m. vaste uitloop m. lange hendel z. koppelingen**











| | | | | | | | |
|---------|---|-------|----------|------|--------|-----|---|
| 0425745 | HOH=15cm | chrom | H7726A10 | stuk | 172,00 | 215 | 1 |
| 0421251 | S-koppeling m. rozet per paar 1/2"x3/4" | chrom | H1040A06 | paar | 12,00 | 215 | 0 |























| | Art.nr | Specificaties | Kleur | Lev.nr | Ehd | Prijs | Grp | CC |
|---|---|--|--------|----------|------|--------|-----|----|
| | Venlo Nimbus Medical | | | | | | | |
| Sanitair producten | wandkraan m. draaibare uitloop m. lange hendel z. koppelingen | | | | | | | |
| | 0425753 | HOH=15cm | chroom | H7830A10 | stuk | 160,00 | 215 | 1 |
| | 0421251 | S-koppeling m. rozet per paar 1/2"x3/4" | chroom | H1040A06 | paar | 12,00 | 215 | 0 |
| Baden / douchebakken / stoomcabines |  | | | | | | | |
| | douchekraan z. omstel m. lange hendel z. koppelingen | | | | | | | |
| Kranen | 0425761 | HOH=15cm | chroom | H7620A10 | stuk | 125,00 | 215 | 1 |
| | 0421251 | S-koppeling m. rozet per paar 1/2"x3/4" | chroom | H1040A06 | paar | 12,00 | 215 | 0 |
| Douchegarnituur |  | | | | | | | |
| | Venlo Nimbus Comfort Eco | | | | | | | |
| Accessoires en spiegels | toiletkraan laag model | | | | | | | |
| | 0420972 | | chroom | H1200A01 | stuk | 27,25 | 215 | 0 |
| Douchewanden |  | | | | | | | |
| Toebehoren & afvoeren | toiletkraan hoog model | | | | | | | |
| | 0420980 | | chroom | H1201A01 | stuk | 43,75 | 215 | 0 |
| Spoel- & installatiesystemen |  | | | | | | | |
| Badkamermeubelen en toiletkasten | 1-gats wastafelkraan m. inzinkbare ketting m. draaibare uitloop | | | | | | | |
| Gootstenen en wastroggen | 0421030 | | chroom | H1206A01 | stuk | 56,00 | 215 | 0 |
| | 0424021 | draaibare onderuitloop 1/2"x130mm | chroom | H1020213 | stuk | 11,50 | 210 | 0 |
| Utiliteit | 0424099 | draaibare bovenuitloop 1/2"x200mm | chroom | H1020215 | stuk | 13,00 | 210 | 1 |
| |  | | | | | | | |
| | doucheblokkraan z. omstel | | | | | | | |
| Douchekraan z. omstel z. koppelingen | 0421014 | | chroom | H1216A01 | stuk | 59,00 | 215 | 1 |
| |  | | | | | | | |
| | doucheblokkraan m. omstel z. uitloop | | | | | | | |
| Douchekraan m. omstel m. S-uitloop z. koppelingen | 0421049 | HOH=12cm | chroom | H1218A03 | stuk | 42,00 | 215 | 0 |
| | 0490792 | S-koppeling m. rozet per paar 1/2"x3/8" | chroom | 0490792 | paar | 3,62 | 150 | 0 |
| | 0490814 | muurplaatkoppeling m. rozet per paar 1/2"x12mm | chroom | 0490814 | paar | 4,75 | 150 | 0 |
| |  | | | | | | | |
| | doucheblokkraan m. omstel z. uitloop z. koppelingen | | | | | | | |
| Douchekraan m. omstel z. uitloop z. koppelingen | 0421057 | HOH=12cm | chroom | H1219A01 | stuk | 58,50 | 215 | 0 |
| | 0490792 | S-koppeling m. rozet per paar 1/2"x3/8" | chroom | 0490792 | paar | 3,62 | 150 | 0 |
| | 0490814 | muurplaatkoppeling m. rozet per paar 1/2"x12mm | chroom | 0490814 | paar | 4,75 | 150 | 0 |
| |  | | | | | | | |
| | doucheblokkraan m. omstel z. uitloop z. koppelingen | | | | | | | |
| Douchekraan m. omstel z. uitloop z. koppelingen | 0421065 | HOH=12cm | chroom | H1219A06 | stuk | 48,50 | 215 | 0 |
| | 0490792 | S-koppeling m. rozet per paar 1/2"x3/8" | chroom | 0490792 | paar | 3,62 | 150 | 0 |
| | 0490814 | muurplaatkoppeling m. rozet per paar 1/2"x12mm | chroom | 0490814 | paar | 4,75 | 150 | 0 |
| |  | | | | | | | |

| Art.nr | Specificaties | Kleur | Lev.nr | Ehd | Prijs | Grp | CC | | |
|--|--|-------|----------|------|-------|-----|----|---|----------------------------------|
| Venlo Nimbus Comfort Eco | | | | | | | | | |
| badkraan m. omstel z. beluchter z. koppelingen | | | | | | | | | |
| 0421081 | | chrom | H1224A02 | stuk | 72,50 | 215 | 1 |  | Sanitair producten |
| 0490784 | S-koppeling m. rozet per paar 3/4"x1/2" | chrom | 0490784 | paar | 4,22 | 150 | 0 | | |
| 0490806 | muurplaatkoppeling m. rozet per paar 3/4"x15mm | chrom | 0490806 | paar | 5,60 | 150 | 0 | | |
| tapkraan 1/2" | | | | | | | | | |
| 0421146 | | chrom | H1236A02 | stuk | 23,50 | 215 | 1 | | |
| muurplaatkraan z. onderuitloop | | | | | | | | | |
| 0421170 | | chrom | H1240A03 | stuk | 55,50 | 215 | 1 |  | Douchegarnituur |
| 0424021 | draaibare onderuitloop 1/2"x130mm | chrom | H1020213 | stuk | 11,50 | 210 | 0 | | |
| muurplaatkraan z. bovenuitloop | | | | | | | | | |
| 0421162 | | chrom | H1240A02 | stuk | 55,50 | 215 | 1 |  | Accessoires en spiegels |
| 0424099 | draaibare bovenuitloop 1/2"x200mm | chrom | H1020215 | stuk | 13,00 | 210 | 1 | | |
| Venlo Nimbus Messing Eco | | | | | | | | | |
| toiletkraan laag model | | | | | | | | | |
| 0422614 | | chrom | H3001001 | stuk | 28,25 | 215 | 0 |  | Douchewanden |
| toiletkraan laag model z. straalregelaar | | | | | | | | | |
| 0423297 | | chrom | H3000001 | stuk | 26,50 | 215 | 1 |  | Toebehoren & afvoeren |
| toiletkraan m. hoge uitloop | | | | | | | | | |
| 0422622 | | chrom | H3004001 | stuk | 45,75 | 215 | 0 |  | Spoel- & installatiesystemen |
| toiletkraan m. straalregelaar hoog model | | | | | | | | | |
| 0425540 | | chrom | H3000A01 | stuk | 42,25 | 215 | 1 |  | Badkamermeubelen en toiletkasten |
| toiletkraan m. straalregelaar m. draaibare uitloop | | | | | | | | | |
| 0425559 | | chrom | H3001A01 | stuk | 46,75 | 215 | 1 |  | Gootstenen en wastroggen |
| 1-gats wastafelkraan m. inzinkbare ketting m. draaibare uitloop | | | | | | | | | |
| 0422630 | | chrom | H3010001 | stuk | 58,50 | 215 | 0 |  | Utiliteit |

| | Art.nr | Specificaties | Kleur | Lev.nr | Ehd | Prijs | Grp | CC |
|---|---------------------------------|--|-------|----------|------|-------|-----|----|
| | Venlo Nimbus Messing Eco | | | | | | | |
| Sanitair producten | | 1-gats wastafelkraan m. hoge uitloop 24cm | | | | | | |
| | 0425575 | | chrom | H3006A03 | stuk | 73,00 | 215 | 1 |
| Baden / douchebakken / stoomcabines | | 1-gats wastafelkraan m. hoge uitloop 26cm | | | | | | |
| | 0425583 | | chrom | H3010002 | stuk | 61,50 | 215 | 1 |
| Kranen | | 1-gats wastafelkraan m. hoge uitloop m. waste | | | | | | |
| | 0425591 | | chrom | H3012006 | stuk | 74,00 | 215 | 1 |
| Douchegarnituur | | douchekraan koud | | | | | | |
| | 0423750 | 1/2" | chrom | H3100001 | stuk | 22,50 | 215 | 1 |
| Accessoires en spiegels | | blokkraan z. omstel | | | | | | |
| | 0422665 | | chrom | H3101001 | stuk | 57,00 | 215 | 0 |
| Douchewanden | | blokkraan m. omstel m. onderuitloop | | | | | | |
| | 0422673 | | chrom | H3102001 | stuk | 75,00 | 215 | 0 |
| Toebehoren & afvoeren | | blokkraan m. omstel z. uitloop | | | | | | |
| | 0423769 | | chrom | H3102003 | stuk | 64,00 | 215 | 1 |
| Spoel- & installatiesystemen | | 0424099 draaibare bovenuitloop 1/2"x200mm | chrom | H1020215 | stuk | 13,00 | 210 | 1 |
| Badkamermeubelen en toiletkasten | | douchekraan z. omstel z. koppelingen | | | | | | |
| | 0421820 | HOH=12cm | chrom | H3104004 | stuk | 43,75 | 215 | 0 |
| | 0490792 | S-koppeling m. rozet per paar 1/2"x3/8" | chrom | 0490792 | paar | 3,62 | 150 | 0 |
| | 0490814 | muurplaatkoppeling m. rozet per paar 1/2"x12mm | chrom | 0490814 | paar | 4,75 | 150 | 0 |
| | 0421847 | HOH=12cm | chrom | H3105001 | stuk | 61,00 | 215 | 0 |
| | 0490792 | S-koppeling m. rozet per paar 1/2"x3/8" | chrom | 0490792 | paar | 3,62 | 150 | 0 |
| | 0490814 | muurplaatkoppeling m. rozet per paar 1/2"x12mm | chrom | 0490814 | paar | 4,75 | 150 | 0 |
| | 0421848 | douchekraan HOH=12cm m. omstel m. bovenuitloop z. koppelingen | | | | | | |
| | 0421848 | | chrom | H3105002 | stuk | 62,50 | 215 | 0 |
| Utiliteit | | | | | | | | |

| Art.nr | Specificaties | Kleur | Lev.nr | Ehd | Prijs | Grp | CC | | |
|--|---|--------|----------|------|-------|-----|----|---|---|
| Venlo Nimbus Messing Eco | | | | | | | | | |
| douчекraan HOH=12cm brugmodel z. koppelingen m. omstel | | | | | | | | | |
| 0423777 | | chroom | H3105007 | stuk | 51,00 | 215 | 0 |  | Sanitair producten |
| 0424099 | draaibare bovenuitloop 1/2"x200mm | chroom | H1020215 | stuk | 13,00 | 210 | 1 | | |
| 0490792 | S-koppeling m. rozet per paar 1/2"x3/8" | chroom | 0490792 | paar | 3,62 | 150 | 0 | | |
| 0490814 | muurplaatkoppeling m. rozet per paar 1/2"x12mm | chroom | 0490814 | paar | 4,75 | 150 | 0 | | |
| douчекraan z. omstel z. koppelingen | | | | | | | | | |
| 0425605 | HOH=15cm | chroom | H3020A02 | stuk | 43,00 | 215 | 1 |  | Baden / douchebakken / stoomcabines |
| 0490784 | S-koppeling m. rozet per paar 3/4"x1/2" | chroom | 0490784 | paar | 4,22 | 150 | 0 | | |
| 0490806 | muurplaatkoppeling m. rozet per paar 3/4"x15mm | chroom | 0490806 | paar | 5,60 | 150 | 0 | | |
| douчекraan m. omstel z. uitloop z. koppelingen | | | | | | | | | |
| 0425613 | HOH=15cm | chroom | H3021A01 | stuk | 57,00 | 215 | 1 |  | Kranen |
| 0490784 | S-koppeling m. rozet per paar 3/4"x1/2" | chroom | 0490784 | paar | 4,22 | 150 | 0 | | |
| 0490806 | muurplaatkoppeling m. rozet per paar 3/4"x15mm | chroom | 0490806 | paar | 5,60 | 150 | 0 | | |
| badkraan m. omstel z. garnituur z. koppelingen | | | | | | | | | |
| 0420026 | | chroom | H3217002 | stuk | 75,50 | 215 | 0 |  | Douchegarnituur |
| 0490784 | S-koppeling m. rozet per paar 3/4"x1/2" | chroom | 0490784 | paar | 4,22 | 150 | 0 | | |
| 0490806 | muurplaatkoppeling m. rozet per paar 3/4"x15mm | chroom | 0490806 | paar | 5,60 | 150 | 0 | | |
| badkraan m. omstel z. garnituur m. beluchter z. koppelingen | | | | | | | | | |
| 0420123 | | chroom | H3218001 | stuk | 87,00 | 215 | 0 |  | Accessoires en spiegels |
| 0490784 | S-koppeling m. rozet per paar 3/4"x1/2" | chroom | 0490784 | paar | 4,22 | 150 | 0 | | |
| 0490806 | muurplaatkoppeling m. rozet per paar 3/4"x15mm | chroom | 0490806 | paar | 5,60 | 150 | 0 | | |
| tapkraan | | | | | | | | | |
| 0423300 | 3/8" | chroom | H3301001 | stuk | 23,25 | 215 | 0 |  | Douchewanden |
| 0423580 | 1/2" | chroom | H3303001 | stuk | 24,50 | 215 | 0 | | Toebehoren & afvoeren |
| muurplaatkraan z. bovenuitloop m. koppelingen | | | | | | | | | |
| 0423882 | | chroom | H3334010 | stuk | 58,00 | 215 | 0 |  | Spoel- & installatiesystemen |
| 0424099 | draaibare bovenuitloop 1/2"x200mm | chroom | H1020215 | stuk | 13,00 | 210 | 1 | | |
| muurplaatkraan z. onderuitloop z. koppelingen | | | | | | | | | |
| 0420727 | | chroom | H3338002 | stuk | 58,00 | 215 | 0 |  | Badkamermeubelen en toiletkasten |
| 0424021 | draaibare onderuitloop 1/2"x130mm | chroom | H1020213 | stuk | 11,50 | 210 | 0 | | |
| wandkraan m. onderuitloop z. koppelingen | | | | | | | | | |
| 0425656 | | chroom | H3331001 | stuk | 61,50 | 215 | 0 |  | Gootstenen en wastroggen |
| 0490814 | muurplaatkoppeling m. rozet per paar 1/2"x12mm | chroom | 0490814 | paar | 4,75 | 150 | 0 | | Utiliteit |
| wandkraan m. bovenuitloop z. koppelingen | | | | | | | | | |
| 0425664 | | chroom | H3331002 | stuk | 61,50 | 215 | 1 |  | |
| 0490784 | S-koppeling m. rozet per paar 3/4"x1/2" | chroom | 0490784 | paar | 4,22 | 150 | 0 | | |
| 0490806 | muurplaatkoppeling m. rozet per paar 3/4"x15mm | chroom | 0490806 | paar | 5,60 | 150 | 0 | | |
| gootstentapkraan z. uitloop | | | | | | | | | |
| 0425680 | 1/2" | chroom | H3320003 | stuk | 22,50 | 215 | 1 |  | |
| 0425826 | draaibare U-uitloop m. straalregelaar 3/4"x17cm | chroom | H1770A05 | stuk | 20,75 | 215 | 1 | | |
| 0425842 | draaibare S-uitloop m. straalregelaar 3/4"x17cm | chroom | H1770A06 | stuk | 20,75 | 215 | 1 | | |
| beluchterkraan | | | | | | | | | |
| 0423033 | 1/2"x3/4" | chroom | H3310001 | stuk | 21,75 | 215 | 0 | | |

| | Art.nr | Specificaties | Kleur | Lev.nr | Ehd | Prijs | Grp | CC |
|---|--|--|--------|----------|------|--------|-----|----|
| | Venlo Nimbus Messing Eco | | | | | | | |
| Sanitair producten | | beluchterkraan m. keerklep 0425699 1/2"x3/4" | chroom | H3037A01 | stuk | 26,75 | 215 | 0 |
| | | drukcombinatie m. onderuitloop 0425710 7bar | chroom | H5212001 | stuk | 173,00 | 215 | 1 |
| Baden / douchebakken / stoomcabines |  | 0425702 8bar | chroom | H5212004 | stuk | 173,00 | 215 | 1 |
| | Venlo Nimbus Nostalgisch Eco | | | | | | | |
| Kranen | | toiletkraan 1/2" m. straalregelaar 0422444 | chroom | H1900A01 | stuk | 37,50 | 210 | 1 |
| Douchegarnituur |  | | | | | | | |
| | | toiletkraan 1/2" 0422445 | chroom | H1900A11 | stuk | 35,75 | 210 | 1 |
| Accessoires en spiegels |  | | | | | | | |
| Douchewanden | | | | | | | | |
| | | 1-gats wastafelkraan m. inzinkbare ketting 0422460 | chroom | H1906A01 | stuk | 75,50 | 210 | 1 |
| Toebehoren & afvoeren |  | | | | | | | |
| Spoel- & installatiesystemen | | | | | | | | |
| | | 1-gats wastafelkraan m. waste m. draaibare uitloop 0429999 | chroom | H1907A01 | stuk | 92,00 | 210 | 1 |
| Badkamermeubelen en toiletkasten |  | | | | | | | |
| Gootstenen en wastroggen | | | | | | | | |
| | | douchekraan z. omstel z. koppelingen 0422487 HOH=12cm | chroom | H1918A02 | stuk | 56,50 | 210 | 1 |
| |  | | | | | | | |
| | | 0490792 S-koppeling m. rozet per paar 1/2"x3/8" chroom | chroom | 0490792 | paar | 3,62 | 150 | 0 |
| Utiliteit | | 0490814 muurplaatkoppeling m. rozet per paar 1/2"x12mm chroom | chroom | 0490814 | paar | 4,75 | 150 | 0 |
| | | badkraan m. omstel z. garnituur z. koppelingen 0422517 | chroom | H1924A02 | stuk | 94,00 | 210 | 1 |
| |  | | | | | | | |
| | | 0490784 S-koppeling m. rozet per paar 3/4"x1/2" chroom | chroom | 0490784 | paar | 4,22 | 150 | 0 |
| | | 0490806 muurplaatkoppeling m. rozet per paar 3/4"x15mm chroom | chroom | 0490806 | paar | 5,60 | 150 | 0 |
| | Venlo Nimbus Project Eco | | | | | | | |
| | | toiletkraan laag model 0420581 | chroom | H1700A01 | stuk | 25,00 | 215 | 0 |
| |  | | | | | | | |
| | | toiletkraan m. draaibare uitloop 0420603 | chroom | H1701A01 | stuk | 46,00 | 215 | 0 |
| |  | | | | | | | |

| Art.nr | Specificaties | Kleur | Lev.nr | Ehd | Prijs | Grp | CC | | |
|--|---|-------|----------|------|-------|-----|----|---|---|
| | | | | | | | | Venlo Nimbus Project Eco | |
| 1-gats wastafelkraan m. inzinkbare ketting m. draaibare uitloop | | | | | | | | | |
| 0420611 | | chrom | H1706A01 | stuk | 51,00 | 215 | 0 |  | Sanitair producten |
| blokkraan z. omstel | | | | | | | | | |
| 0420654 | | chrom | H1716A01 | stuk | 55,50 | 215 | 0 |  | Baden / douchebakken / stoomcabines |
| blokkraan m. omstel m. onderuitloop | | | | | | | | | |
| 0420697 | | chrom | H1717A01 | stuk | 73,00 | 215 | 0 |  | Kranen |
| blokkraan m. omstel m. bovenuitloop | | | | | | | | | |
| 0420699 | | chrom | H1717A02 | stuk | 76,50 | 215 | 1 |  | Douchegarnituur |
| douchekraan z. omstel z. koppelingen | | | | | | | | | |
| 0420662 | HOH=12cm | chrom | H1718A01 | stuk | 39,50 | 215 | 0 |  | Accessoires en spiegels |
| 0490792 | S-koppeling m. rozet per paar 1/2"x3/8" | chrom | 0490792 | paar | 3,62 | 150 | 0 | | |
| 0490814 | muurplaatkoppeling m. rozet per paar 1/2"x12mm | chrom | 0490814 | paar | 4,75 | 150 | 0 | | |
| douchekraan m. omstel m. S-uitloop z. koppelingen | | | | | | | | | |
| 0420689 | HOH=12cm | chrom | H1719A01 | stuk | 54,50 | 215 | 0 |  | Douchewanden |
| 0490792 | S-koppeling m. rozet per paar 1/2"x3/8" | chrom | 0490792 | paar | 3,62 | 150 | 0 | | |
| 0490814 | muurplaatkoppeling m. rozet per paar 1/2"x12mm | chrom | 0490814 | paar | 4,75 | 150 | 0 | | |
| douchekraan m. omstel m. U-uitloop z. koppelingen | | | | | | | | | |
| 0422762 | HOH=12cm | chrom | H1719A02 | stuk | 54,50 | 215 | 0 |  | Toebehoren & afvoeren |
| badkraan m. omstel z. garnituur z. koppelingen | | | | | | | | | |
| 0420698 | | chrom | H1724A02 | stuk | 67,50 | 215 | 0 |  | Spoel- & installatiesystemen |
| 0490784 | S-koppeling m. rozet per paar 3/4"x1/2" | chrom | 0490784 | paar | 4,22 | 150 | 0 | | |
| 0490806 | muurplaatkoppeling m. rozet per paar 3/4"x15mm | chrom | 0490806 | paar | 5,60 | 150 | 0 | | |
| badkraan m. omstel m. beluchter z. . koppelingen | | | | | | | | | |
| 0420700 | | chrom | H1725A01 | stuk | 83,00 | 215 | 0 |  | Badkamermeubelen en toiletkasten |
| 0490784 | S-koppeling m. rozet per paar 3/4"x1/2" | chrom | 0490784 | paar | 4,22 | 150 | 0 | | |
| 0490806 | muurplaatkoppeling m. rozet per paar 3/4"x15mm | chrom | 0490806 | paar | 5,60 | 150 | 0 | | |
| tapkraan project koud | | | | | | | | | |
| 0422789 | 3/8" | chrom | H1736A01 | stuk | 22,75 | 215 | 1 |  | Gootstenen en wastroggen |
| 0422797 | 1/2" | chrom | H1736A02 | stuk | 24,25 | 215 | 0 | | |
| wandkraan z. uitloop z. koppelingen | | | | | | | | | |
| 0422770 | HOH=15cm | chrom | H1730A05 | stuk | 41,00 | 215 | 0 |  | Utiliteit |
| 0425826 | draaibare U-uitloop m. straalregelaar 3/4"x17cm | chrom | H1770A05 | stuk | 20,75 | 215 | 1 | | |
| 0425842 | draaibare S-uitloop m. straalregelaar 3/4"x17cm | chrom | H1770A06 | stuk | 20,75 | 215 | 1 | | |
| 0490784 | S-koppeling m. rozet per paar 3/4"x1/2" | chrom | 0490784 | paar | 4,22 | 150 | 0 | | |
| 0490806 | muurplaatkoppeling m. rozet per paar 3/4"x15mm | chrom | 0490806 | paar | 5,60 | 150 | 0 | | |

| | Art.nr | Specificaties | Kleur | Lev.nr | Ehd | Prijs | Grp | CC |
|---|--|---|---------|----------|------|--------|-----|----|
| Sanitair producten | Venlo Nimbus Nostalgisch Keramisch | | | | | | | |
| | | toiletkraan m. straalregelaar koud 12mm 0422456 | chrom | H1900A03 | stuk | 48,50 | 210 | 1 |
| Baden / douchebakken / stoomcabines | | toiletkraan koud 12mm 0422446 | chrom | H1900A12 | stuk | 46,50 | 210 | 1 |
| | Kranen | | | | | | | |
| Douchegarnituur | | 1-gats wastafelkraan m. uitloop m. inzinkbare ketting 0422518 | chrom | H1906A02 | stuk | 97,50 | 210 | 1 |
| | Accessoires en spiegels | | | | | | | |
| Douchewanden | | 1-gats wastafelkraan m. draaibare uitloop 0422447 | chrom | H1907A02 | stuk | 114,00 | 210 | 1 |
| | Toebehoren & afvoeren | | | | | | | |
| Spoel- & installatiesystemen | | douchekraan z. omstel z. koppelingen 0422448 HOH=12cm | chrom | H1918A04 | stuk | 79,00 | 210 | 1 |
| | | 0490792 S-koppeling m. rozet per paar 1/2"x3/8" | chrom | 0490792 | paar | 3,62 | 150 | 0 |
| | | 0490814 muurplaatkoppeling m. rozet per paar 1/2"x12mm | chrom | 0490814 | paar | 4,75 | 150 | 0 |
| | | douchekraan HOH=12cm z. uitloop z. koppelingen 0422443 | chrom | H1919A10 | stuk | 91,00 | 210 | 1 |
| Badkamermeubelen en toiletkasten | | 0424021 draaibare onderuitloop 1/2"x130mm | chrom | H1020213 | stuk | 11,50 | 210 | 0 |
| | | 0424099 draaibare bovenuitloop 1/2"x200mm | chrom | H1020215 | stuk | 13,00 | 210 | 1 |
| | | 0490792 S-koppeling m. rozet per paar 1/2"x3/8" | chrom | 0490792 | paar | 3,62 | 150 | 0 |
| | | 0490814 muurplaatkoppeling m. rozet per paar 1/2"x12mm | chrom | 0490814 | paar | 4,75 | 150 | 0 |
| Gootstenen en wastroggen | | badkraan z. omstel z. garnituur z. koppelingen 0422505 | chrom | H1924A04 | stuk | 117,00 | 210 | 1 |
| | | 0490784 S-koppeling m. rozet per paar 3/4"x1/2" | chrom | 0490784 | paar | 4,22 | 150 | 0 |
| | | 0490806 muurplaatkoppeling m. rozet per paar 3/4"x15mm | chrom | 0490806 | paar | 5,60 | 150 | 0 |
| | Utiliteit | | | | | | | |
| | Venlo Nimbus Comfort Keramisch | | | | | | | |
| | | toiletkraan laag model 0423130 | chrom | H1200A03 | stuk | 38,75 | 215 | 1 |
| | | 1-gats wastafelkraan m. inzinkbare ketting 0423157 | chrom | H1206A03 | stuk | 79,50 | 215 | 1 |
| | | douchekraan z. omstel z. koppelingen 0423246 HOH=12cm | chrom | H1218A04 | stuk | 66,00 | 215 | 1 |
| | 0490792 S-koppeling m. rozet per paar 1/2"x3/8" | chrom | 0490792 | paar | 3,62 | 150 | 0 | |
| | 0490814 muurplaatkoppeling m. rozet per paar 1/2"x12mm | chrom | 0490814 | paar | 4,75 | 150 | 0 | |

| Art.nr | Specificaties | Kleur | Lev.nr | Ehd | Prijs | Grp | CC |
|--------|---------------|-------|--------|-----|-------|-----|----|
|--------|---------------|-------|--------|-----|-------|-----|----|

Venlo Nimbus Comfort Keramisch

douchekraan m. omstel z. uitloop z. koppelingen

| | | | | | | | | | |
|---------|--|-------|----------|------|-------|-----|---|---|--------------------|
| 0423262 | HOH=12cm | chrom | H1219A08 | stuk | 74,00 | 215 | 1 |  | Sanitair producten |
| 0424021 | draaibare onderuitloop 1/2"x130mm | chrom | H1020213 | stuk | 11,50 | 210 | 0 | | |
| 0424099 | draaibare bovenuitloop 1/2"x200mm | chrom | H1020215 | stuk | 13,00 | 210 | 1 | | |
| 0490792 | S-koppeling m. rozet per paar 1/2"x3/8" | chrom | 0490792 | paar | 3,62 | 150 | 0 | | |
| 0490814 | muurplaatkoppeling m. rozet per paar 1/2"x12mm | chrom | 0490814 | paar | 4,75 | 150 | 0 | | |

badkraan m. omstel z. garnituur z. koppelingen

| | | | | | | | | | |
|---------|--|-------|----------|------|-------|-----|---|---|---|
| 0423289 | | chrom | H1224A04 | stuk | 97,50 | 215 | 1 |  | Baden / douchebakken / stoomcabines |
| 0490784 | S-koppeling m. rozet per paar 3/4"x1/2" | chrom | 0490784 | paar | 4,22 | 150 | 0 | | |
| 0490806 | muurplaatkoppeling m. rozet per paar 3/4"x15mm | chrom | 0490806 | paar | 5,60 | 150 | 0 | | |

Venlo Nimbus Messing Keramisch

toiletkraan laag m. perlator

| | | | | | | | | | |
|---------|--|-------|----------|------|-------|-----|---|---|-----------------|
| 0420086 | | chrom | H2900A01 | stuk | 38,00 | 215 | 1 |  | Douchegarnituur |
| <hr/> | | | | | | | | | |

toiletkraan hoog m. perlator

| | | | | | | | | | |
|---------|--|-------|----------|------|-------|-----|---|---|----------------------------|
| 0420087 | | chrom | H2900A02 | stuk | 47,50 | 215 | 1 |  | Accessoires en spiegels |
| <hr/> | | | | | | | | | |

toiletkraan m. hoge uitloop m. perlator

| | | | | | | | | | |
|---------|--|-------|----------|------|-------|-----|---|--|--------------------------|
| 0420088 | | chrom | H2901A01 | stuk | 54,00 | 215 | 1 |  | Toebehoren & afvoeren |
| <hr/> | | | | | | | | | |

toiletkraan m. draaibare uitloop m. perlator

| | | | | | | | | | |
|---------|--|-------|----------|------|-------|-----|---|---|-------------------------------------|
| 0420089 | | chrom | H2901A02 | stuk | 67,50 | 215 | 1 |  | Badkamermeubelen en toiletkasten |
| <hr/> | | | | | | | | | |

1-gats wastafelkraan m. hoge uitloop m. perlator









| | | | | | | | | | |
|---------|--|-------|----------|------|-------|-----|---|---|-----------------------------|
| 0420090 | | chrom | H2906A01 | stuk | 78,50 | 215 | 1 |  | Gootstenen en wastroggen |
| <hr/> | | | | | | | | | |

1-gats wastafelkraan m. hoge uitloop 24cm

| | | | | | | | | | |
|---------|--|-------|----------|------|-------|-----|---|---|-----------|
| 0420091 | | chrom | H2906A02 | stuk | 98,00 | 215 | 1 |  | Utiliteit |
| <hr/> | | | | | | | | | |

douchekraan z. omstel m. koppelingen

| | | | | | | | | | |
|---------|--|-------|----------|------|-------|-----|---|---|--|
| 0420092 | | chrom | H2916A01 | stuk | 79,50 | 215 | 1 |  | |
| <hr/> | | | | | | | | | |

| | Art.nr | Specificaties | Kleur | Lev.nr | Ehd | Prijs | Grp | CC |
|---|---|---|----------|----------|--------|-------|-----|----|
| Sanitair producten | Venlo Nimbus Messing Keramisch | | | | | | | |
| | | douчекraan m. omstel m. koppelingen m. S-uitloop | | | | | | |
| | 0420093 | | chroom | H2917A01 | stuk | 97,50 | 215 | 1 |
| Baden / douchebakken / stoomcabines |  | | | | | | | |
| Kranen | douчекraan HOH=12cm z. omstel z. koppelingen | | | | | | | |
| | 0420094 | | chroom | H2918A01 | stuk | 65,00 | 215 | 1 |
| Douche garnituur |  | | | | | | | |
| Accessoires en spiegels | douчекraan HOH=15cm z. koppelingen | | | | | | | |
| | 0420095 | | chroom | H2920A01 | stuk | 63,50 | 215 | 1 |
| Douchewanden |  | | | | | | | |
| Toebehoren & afvoeren | douчекraan HOH=12cm m. omstel z. koppelingen z. uitloop | | | | | | | |
| | 0420096 | | chroom | H2919A01 | stuk | 73,00 | 215 | 1 |
| Toebehoren & afvoeren |  | | | | | | | |
| Spoel- & installatiesystemen | douчекraan HOH=15cm m. omstel | | | | | | | |
| | 0420097 | | chroom | H2921A01 | stuk | 84,00 | 215 | 1 |
| Badkamermeubelen en toiletkasten |  | | | | | | | |
| Gootstenen en wastroggen | badkraan m. omstel z. koppelingen z. garnituur | | | | | | | |
| | 0420098 | | chroom | H2924A01 | stuk | 96,50 | 215 | 1 |
| Utiliteit |  | | | | | | | |
| Utiliteit | Venlo Project | | | | | | | |
| | | wastafelkraan m. inzinkbare ketting | | | | | | |
| | 0424757 | | chroom | H3003A01 | stuk | 74,50 | 210 | 0 |
| |  | | | | | | | |
| | | wastafelkraan m. waste | | | | | | |
| 0424749 | | chroom | H3002A01 | stuk | 87,50 | 210 | 0 | |
| |  | | | | | | | |
| | | badkraan m. omstel z. koppelingen | | | | | | |
| 0424730 | | chroom | H3026A01 | stuk | 102,00 | 210 | 0 | |
| |  | | | | | | | |

| Art.nr | Specificaties | Kleur | Lev.nr | Ehd | Prijs | Grp | CC | | |
|--|--|--------|----------|------|--------|-----|----|---|---|
| | | | | | | | | Venlo Project | |
| badthermostaat m. omstel z. koppelingen | | | | | | | | | |
| 0424803 | | chroom | H3046A03 | stuk | 202,00 | 218 | 0 |  | Sanitair producten |
| douchekraan z. omstel z. koppelingen | | | | | | | | | |
| 0424765 | HOH=15cm | chroom | H3020A01 | stuk | 78,00 | 210 | 1 |  | Baden / douchebakken / stoomcabines |
| 0490792 | S-koppeling m. rozet per paar 1/2"x3/8" | chroom | 0490792 | paar | 3,62 | 150 | 0 | | |
| 0490806 | muurplaatkoppeling m. rozet per paar 3/4"x15mm | chroom | 0490806 | paar | 5,60 | 150 | 0 | | |
| douchethermostaat z. omstel z. koppelingen | | | | | | | | | |
| 0424781 | HOH=15cm | chroom | H3046A02 | stuk | 150,00 | 218 | 0 |  | Kranen |
| 0424773 | HOH=12cm | chroom | H3046A01 | stuk | 150,00 | 218 | 0 | | |
| 0490792 | S-koppeling m. rozet per paar 1/2"x3/8" | chroom | 0490792 | paar | 3,62 | 150 | 0 | | |
| 0490814 | muurplaatkoppeling m. rozet per paar 1/2"x12mm | chroom | 0490814 | paar | 4,75 | 150 | 0 | | |
| wandkeukethermostaat m. onderuitloop z. koppelingen | | | | | | | | | |
| 0424775 | HOH=15cm | chroom | H3046A05 | stuk | 195,00 | 218 | 1 |  | Douchegarnituur |
| 0490792 | S-koppeling m. rozet per paar 1/2"x3/8" | chroom | 0490792 | paar | 3,62 | 150 | 0 | | |
| 0490806 | muurplaatkoppeling m. rozet per paar 3/4"x15mm | chroom | 0490806 | paar | 5,60 | 150 | 0 | | |
| renovatieset douchethermostaat + glijstang z. koppelingen | | | | | | | | | |
| 0424777 | HOH=15cm | chroom | H3046A06 | stuk | 221,00 | 218 | 1 |  | Accessoires en spiegels |
| 0490792 | S-koppeling m. rozet per paar 1/2"x3/8" | chroom | 0490792 | paar | 3,62 | 150 | 0 | | |
| 0490806 | muurplaatkoppeling m. rozet per paar 3/4"x15mm | chroom | 0490806 | paar | 5,60 | 150 | 0 | | |
| | | | | | | | | Venlo Noxxa | |
| toiletkraan 1/2" | | | | | | | | | |
| 0422541 | | chroom | H2100A10 | stuk | 114,00 | 210 | 0 | <td>Toebehoren & afvoeren</td> | Toebehoren & afvoeren |
| 1-gats wastafelkraan m. waste | | | | | | | | | |
| 0422649 | | chroom | H2107A10 | stuk | 201,00 | 210 | 0 |  | Spoel- & installatiesystemen |
| 1-gats wastafelkraan 1-greeps m. waste | | | | | | | | | |
| 0424811 | | chroom | H2107A03 | stuk | 239,00 | 210 | 0 |  | Badkamermeubelen en toiletkasten |
| 3-gats wastafelkraan m. waste | | | | | | | | | |
| 0422606 | | chroom | H2104A10 | stuk | 355,00 | 210 | 1 |  | Gootstenen en wastroggen |
| douchekraan z. omstel m. koppelingen | | | | | | | | | |
| 0422703 | HOH=15cm | chroom | H2120A10 | stuk | 163,00 | 210 | 0 |  | Utiliteit |
| badkraan m. omstel m. koppelingen | | | | | | | | | |
| 0422711 | | chroom | H2126A10 | stuk | 221,00 | 210 | 0 |  | |
| 4-gats badrandcombinatie | | | | | | | | | |
| 0425401 | | chroom | H2128A11 | stuk | 527,00 | 210 | 1 |  | |
| 0424404 | montageplaat voor badrandcombinatie | RVS | H2193A69 | stuk | 216,00 | 210 | 0 | | |

| | Art.nr | Specificaties | Kleur | Lev.nr | Ehd | Prijs | Grp | CC |
|---|---|---|-------|----------|------|--------|-----|----|
| | Venlo Noxxa | | | | | | | |
| Sanitair producten | 5-gats badrandcombinatie | | | | | | | |
| | 0422746 | | chrom | H2128A10 | stuk | 637,00 | 210 | 0 |
| | 0424404 | montageplaat voor badrandcombinatie RVS | | H2193A69 | stuk | 216,00 | 210 | 0 |
| Baden / douchebakken / stoomcabines | douchethermostaat z. omstel m. koppelingen | | | | | | | |
| | 0424382 | HOH=15cm | chrom | H2146A01 | stuk | 308,00 | 218 | 0 |
| | 0424390 | baduitloop tbv H2146A01 chrom | | H1020A01 | stuk | 107,00 | 210 | 0 |
| Kranen | baduitloop tbv H2146A01 | | | | | | | |
| | 0424390 | | chrom | H1020A01 | stuk | 107,00 | 210 | 0 |
| Douchegarnituur | baduitloop 1/2" m. rozet | | | | | | | |
| | 0424406 | | chrom | H2170A18 | stuk | 77,00 | 210 | 0 |
| Accessoires en spiegels | inbouwstopkraan 1/2" koud/warm | | | | | | | |
| | 0422740 | | chrom | H2143A10 | stuk | 85,50 | 210 | 0 |
| Douchewanden | 3-gats inbouwwandkraan vast | | | | | | | |
| | 0444170 | | chrom | H2105A03 | stuk | 366,00 | 210 | 1 |
| Toebehoren & afvoeren | 1-gats bidetkraan m. waste | | | | | | | |
| | 0444189 | | chrom | H2131A10 | stuk | 191,00 | 210 | 1 |
| Badkamermeubelen en toiletkasten | inbouwthermostaat | | | | | | | |
| | 0444197 | | chrom | H2146A02 | stuk | 288,00 | 210 | 1 |
| Gootstenen en wastroggen | inbouwstopkraan neutraal | | | | | | | |
| | 0444200 | 1/2" | chrom | H2143A11 | stuk | 85,50 | 210 | 1 |
| Utiliteit | doucheset m. slang 125cm, handdouche en wandhouder | | | | | | | |
| | 0444219 | | | H2160A17 | stuk | 98,00 | 210 | 1 |
| | wanduitloop | | | | | | | |
| | 0444227 | 15cm | chrom | H2170A30 | stuk | 77,00 | 210 | 1 |
| | 5-wegomstelling | | | | | | | |
| | 0444235 | 1/2" | chrom | H2134A01 | stuk | 149,00 | 210 | 1 |
| | montageplaat voor badrandcombinatie | | | | | | | |
| | 0424404 | | RVS | H2193A69 | stuk | 216,00 | 210 | 0 |
| | Venlo Tado | | | | | | | |
| | 1-gats wastafelkraan | | | | | | | |
| | 0422002 | m. waste | chrom | H2202A01 | stuk | 106,00 | 210 | 0 |
| | 0422008 | m. inzinkbare ketting | chrom | H2203A01 | stuk | 89,50 | 210 | 0 |

| Art.nr | Specificaties | Kleur | Lev.nr | Ehd | Prijs | Grp | CC |
|--------|---------------|-------|--------|-----|-------|-----|----|
|--------|---------------|-------|--------|-----|-------|-----|----|

Venlo Tado

1-gats bidetkraan

| | | | | | | | |
|---------|----------|-------|----------|------|--------|-----|---|
| 0422029 | m. waste | chrom | H2231A01 | stuk | 128,00 | 210 | 1 |
|---------|----------|-------|----------|------|--------|-----|---|



Sanitair producten

Baden /
douchebakken /
stoomcabines**douchekraan HOH=15cm**

| | | | | | | | |
|---------|--------------------------|-------|----------|------|-------|-----|---|
| 0422037 | m. koppelingen z. omstel | chrom | H2220A01 | stuk | 95,00 | 210 | 1 |
|---------|--------------------------|-------|----------|------|-------|-----|---|



Kranen

Douchegarnituur

badkraan m. koppelingen m. omstel

| | | | | | | | |
|---------|--|-------|----------|------|--------|-----|---|
| 0422045 | | chrom | H2226A01 | stuk | 125,00 | 210 | 1 |
|---------|--|-------|----------|------|--------|-----|---|

| | | | | | | | |
|---------|------------------------------------|--|---------|------|------|-----|---|
| 0770752 | Montagebeugel messing 2x15 mmx1/2" | | 0770752 | stuk | 5,90 | 475 | 0 |
|---------|------------------------------------|--|---------|------|------|-----|---|

Accessoires en
spiegels

VenloTherm Project

douchethermostaat z. omstel z. koppelingen

| | | | | | | | |
|---------|----------|-------|----------|------|--------|-----|---|
| 0424785 | HOH=12cm | chrom | H1846A50 | stuk | 167,00 | 218 | 0 |
|---------|----------|-------|----------|------|--------|-----|---|

douchethermostaat z. omstel m. koppelingen

| | | | | | | | |
|---------|----------|-------|----------|------|--------|-----|---|
| 0424779 | HOH=15cm | chrom | H1846A51 | stuk | 167,00 | 218 | 0 |
|---------|----------|-------|----------|------|--------|-----|---|

badthermostaat m. omstel m. koppelingen

| | | | | | | | |
|---------|----------|-------|----------|------|--------|-----|---|
| 0424780 | HOH=15cm | chrom | H1846A52 | stuk | 203,00 | 218 | 1 |
|---------|----------|-------|----------|------|--------|-----|---|

opbouwthermostaat 1/2"

| | | | | | | | |
|---------|----------|-------|----------|------|--------|-----|---|
| 0421502 | centraal | chrom | H1846A04 | stuk | 132,00 | 218 | 1 |
|---------|----------|-------|----------|------|--------|-----|---|

Spoel- &
installatiesystemenBadkamermeubelen
en toiletkasten**baduitloop**

| | | | | | | | |
|---------|-----------------|-------|----------|------|-------|-----|---|
| 0421529 | tbv H1846A01/02 | chrom | H1870A01 | stuk | 46,00 | 210 | 0 |
|---------|-----------------|-------|----------|------|-------|-----|---|

Gootstenen en
wastroggen

Utiliteit

Venlo Venlomix Medical

douchethermostaat z. omstel m. hendel z. koppelingen

| | | | | | | | |
|---------|----------|-------|----------|------|--------|-----|---|
| 0424708 | HOH=15cm | chrom | H5046A20 | stuk | 239,00 | 218 | 1 |
|---------|----------|-------|----------|------|--------|-----|---|

| | | | | | | | |
|---------|---|-------|---------|------|------|-----|---|
| 0490792 | S-koppeling m. rozet per paar 1/2"x3/8" | chrom | 0490792 | paar | 3,62 | 150 | 0 |
|---------|---|-------|---------|------|------|-----|---|

| | | | | | | | |
|---------|--|-------|---------|------|------|-----|---|
| 0490806 | muurplaatkoppeling m. rozet per paar 3/4"x15mm | chrom | 0490806 | paar | 5,60 | 150 | 0 |
|---------|--|-------|---------|------|------|-----|---|

1-gats wastafelthermostaat m. korte hendel

| | | | | | | | |
|---------|--|-------|----------|------|--------|-----|---|
| 0424710 | | chrom | H5046A21 | stuk | 285,00 | 218 | 1 |
|---------|--|-------|----------|------|--------|-----|---|

1-gats wastafelthermostaat m. lange hendel

| | | | | | | | |
|---------|--|-------|----------|------|--------|-----|---|
| 0424712 | | chrom | H5046A22 | stuk | 291,00 | 218 | 1 |
|---------|--|-------|----------|------|--------|-----|---|

Venlo Toebehoren

| | | | | | | | |
|---------|---|-------|----------|------|-------|-----|---|
| 0421251 | S-koppeling m. rozet per paar 1/2"x3/4" | chrom | H1040A06 | paar | 12,00 | 215 | 0 |
|---------|---|-------|----------|------|-------|-----|---|

| | | | | | | | |
|---------|--------------------------------------|-------|----------|------|--------|-----|---|
| 0422185 | staande koppeling per paar 3/4"x3/4" | chrom | H2350A01 | paar | 113,00 | 210 | 1 |
|---------|--------------------------------------|-------|----------|------|--------|-----|---|

| | | | | | | | |
|---------|---|-------|----------|------|-------|-----|---|
| 0422190 | staande koppeling per paar 3/4"x3/4" bu | chrom | H1040A27 | stuk | 78,00 | 215 | 1 |
|---------|---|-------|----------|------|-------|-----|---|

| | | | | | | | |
|---------|-----------------------------------|-------|----------|------|-------|-----|---|
| 0424021 | draaibare onderuitloop 1/2"x130mm | chrom | H1020213 | stuk | 11,50 | 210 | 0 |
|---------|-----------------------------------|-------|----------|------|-------|-----|---|

| | | | | | | | |
|---------|-----------------------------------|-------|----------|------|-------|-----|---|
| 0424048 | draaibare onderuitloop 1/2"x200mm | chrom | H1020217 | stuk | 13,00 | 210 | 0 |
|---------|-----------------------------------|-------|----------|------|-------|-----|---|







| | | | | | | | |
|---------|-----------------------------------|-------|----------|------|-------|-----|---|
| 0424056 | draaibare onderuitloop 1/2"x250mm | chrom | H1020218 | stuk | 17,00 | 210 | 1 |
|---------|-----------------------------------|-------|----------|------|-------|-----|---|

| | | | | | | | |
|---------|-----------------------------------|-------|----------|------|-------|-----|---|
| 0424064 | draaibare onderuitloop 1/2"x300mm | chrom | H1020219 | stuk | 18,50 | 210 | 1 |
|---------|-----------------------------------|-------|----------|------|-------|-----|---|









| | | | | | | | |
|---------|-----------------------------------|-------|----------|------|-------|-----|---|
| 0424072 | draaibare onderuitloop 1/2"x350mm | chrom | H1020220 | stuk | 19,75 | 210 | 1 |
|---------|-----------------------------------|-------|----------|------|-------|-----|---|

| | | | | | | | |
|---------|---|-------|----------|------|-------|-----|---|
| 0423599 | draaibare onderuitloop m. straalregelaar 1/2"x130mm | chrom | H1020214 | stuk | 13,25 | 210 | 0 |
|---------|---|-------|----------|------|-------|-----|---|











| | Art.nr | Specificaties | Kleur | Lev.nr | Ehd | Prijs | Grp | CC |
|---|-------------------------|---|--------|----------|------|-------|-----|----|
| | Venlo Toebehoren | | | | | | | |
| Sanitair producten | 0424080 | draaibare onderuitloop m. straalregelaar 1/2"x350mm | chroom | H1020222 | stuk | 24,50 | 210 | 1 |
| | 0421340 | draaibare onderuitloop m. straalregelaar M24x170mm | chroom | H1020062 | stuk | 22,75 | 210 | 1 |
| | 0421596 | draaibare onderuitloop m. straalregelaar 3/4"x170mm | chroom | H1020212 | stuk | 20,50 | 210 | 0 |
| Baden / douchebakken / stoomcabines | 0420549 | draaibare onderuitloop m. straalregelaar Antares 16cm | chroom | H1020078 | stuk | 65,50 | 210 | 1 |
| | 0424099 | draaibare bovenuitloop 1/2"x200mm | chroom | H1020215 | stuk | 13,00 | 210 | 1 |
| | 0424161 | draaibare bovenuitloop 1/2"x250mm | chroom | H1020225 | stuk | 17,00 | 210 | 1 |
| | 0424196 | draaibare bovenuitloop 1/2"x300mm | chroom | H1020226 | stuk | 19,50 | 210 | 1 |
| | 0424137 | draaibare bovenuitloop m. straalregelaar 1/2"x200mm | chroom | H1020216 | stuk | 15,00 | 210 | 0 |
| Kranen | 0421588 | draaibare bovenuitloop m. straalregelaar 3/4"x170mm | chroom | H1020211 | stuk | 20,50 | 210 | 0 |
| | 0421332 | draaibare bovenuitloop m. straalregelaar M24x170mm | chroom | H1020063 | stuk | 22,75 | 210 | 0 |
| | 0421243 | draaibare hoge uitloop m. straalregelaar 3/4"x130mm | chroom | H1020209 | stuk | 20,00 | 210 | 0 |
| | 0421294 | draaibare hoge uitloop m. straalregelaar 3/4"x200mm | chroom | H1020210 | stuk | 23,00 | 210 | 0 |
| | 0421324 | draaibare hoge uitloop m. straalregelaar M24x130mm | chroom | H1020051 | stuk | 20,00 | 210 | 0 |
| | 0421383 | draaibare hoge uitloop m. straalregelaar M24x200mm | chroom | H1020052 | stuk | 23,00 | 210 | 0 |
| Douchegarnituur | 0425834 | draaibare U-uitloop m. straalregelaar 3/4"x25cm | chroom | H1020228 | stuk | 24,50 | 215 | 1 |
| | 0425796 | draaibare U-uitloop m. straalregelaar 1/2"x20cm | chroom | H1770A02 | stuk | 15,25 | 215 | 1 |
| | 0425818 | draaibare U-uitloop m. straalregelaar 3/4"x20cm | chroom | H1770A04 | stuk | 23,25 | 215 | 1 |
| Accessoires en spiegels | 0425826 | draaibare U-uitloop m. straalregelaar 3/4"x17cm | chroom | H1770A05 | stuk | 20,75 | 215 | 1 |
| | 0425915 | draaibare U-uitloop m. straalregelaar 3/4"x19cm | chroom | H1970A04 | stuk | 28,50 | 215 | 1 |
| | 0425907 | draaibare U-uitloop m. straalregelaar 3/4"x13,5cm | chroom | H1970A07 | stuk | 24,50 | 215 | 1 |
| | 0425869 | Noxxa draaibare U-uitloop m. straalregelaar 12cm | chroom | H2170A05 | stuk | 50,00 | 215 | 1 |
| Douchewanden | 0425877 | Noxxa draaibare U-uitloop m. straalregelaar 17cm | chroom | H2170A22 | stuk | 55,00 | 215 | 1 |
| | 0425885 | Noxxa draaibare U-uitloop m. straalregelaar 20cm | chroom | H2170A29 | stuk | 61,50 | 215 | 1 |
| | 0425850 | draaibare S-uitloop m. straalregelaar 3/4"x25cm | chroom | H1020229 | stuk | 24,50 | 215 | 1 |
| | 0425842 | draaibare S-uitloop m. straalregelaar 3/4"x17cm | chroom | H1770A06 | stuk | 20,75 | 215 | 1 |
| | 0425788 | draaibare S-uitloop m. straalregelaar 1/2"x35cm | chroom | H1770A07 | stuk | 23,50 | 215 | 1 |
| Toebehoren & afvoeren | 0425893 | Noxxa draaibare U-uitloop m. straalregelaar 20cm | chroom | H2170A07 | stuk | 67,00 | 215 | 1 |
| | 0423394 | straalregelaar M22x1 binnendraad | | H1030084 | stuk | 3,75 | 210 | 0 |
| | 0420565 | straalregelaar M24x1 buitendraad | | H1030085 | stuk | 5,60 | 210 | 1 |
| | 0424250 | straalregelaar M28x1 buitendraad | | H1030086 | stuk | 7,60 | 210 | 1 |
| Spoel- & installatiesystemen | 0420077 | bovendeel m. tulpgreep koud/warm M19 | | H3080A23 | stuk | 17,50 | 210 | 0 |
| | 0421871 | bovendeel z. greep oud | | H1001750 | stuk | 8,10 | 210 | 0 |
| | 0423939 | bovendeel z. greep nieuw geruisarm 1/2" | | H1001650 | stuk | 8,10 | 210 | 0 |
| | 0420082 | bovendeel keramisch z. knop 1/2" | | H2380A01 | stuk | 21,00 | 210 | 1 |
| Badkamermeubelen en toiletkasten | 0421228 | bovendeel z. knop standaard 1/2" | | H1001625 | stuk | 8,10 | 210 | 0 |
| | 0420071 | bovendeel z. knop keramisch 1/2" | | H3080A04 | stuk | 16,75 | 215 | 0 |
| | 0420391 | knop m. rozetkap Astro warm | chroom | H2381A01 | stuk | 28,50 | 210 | 1 |
| | 0420393 | knop m. rozetkrap Astro koud | chroom | H2381A02 | stuk | 28,50 | 210 | 1 |
| | 0421219 | kraangreep tulp groot koud/warm | | H3081A04 | stuk | 9,70 | 210 | 0 |
| Gootstenen en wastroggen | 0421200 | kraangreep Tritalux koud/warm | | H1281A03 | stuk | 8,70 | 210 | 0 |
| | 0421220 | kraangreep Tritalux-Plus warm | | H1281A01 | stuk | 8,70 | 210 | 1 |
| | 0421230 | kraangreep Tritalux-Plus koud | | H1281A02 | stuk | 8,70 | 210 | 1 |
| | 0423947 | kraangreep Nimbus koud | | H3081A02 | stuk | 8,70 | 210 | 0 |
| | 0423955 | kraangreep Nimbus warm | | H3081A01 | stuk | 8,70 | 210 | 0 |
| Utiliteit | 0424234 | kraangreep Nimbus-Ecoplus koud | | H1781A01 | stuk | 9,10 | 210 | 1 |
| | 0424242 | kraangreep Nimbus-Ecoplus warm | | H1781A02 | stuk | 9,10 | 210 | 1 |
| | Venlo Onderdelen | | | | | | | |
| | 0424226 | ombouwset: 2 binnenwerken van bovendeel m. straalregelaar | | H1790A11 | stuk | 17,75 | 210 | 0 |
| | 0423963 | kenplaatje Nimbus koud | | H1080044 | stuk | 0,47 | 210 | 1 |
| | 0423971 | kenplaatje Nimbus warm | | H1080043 | stuk | 0,47 | 210 | 0 |
| | 0421227 | kenplaatje Tritalux koud | | H1080013 | stuk | 0,18 | 210 | 1 |
| | 0421235 | kenplaatje Tritalux warm | | H1080012 | stuk | 0,18 | 210 | 1 |
| | 0420085 | klemnok voor knopmontage | | H1080027 | stuk | 0,33 | 210 | 0 |
| | 0423998 | kraanschijf rubber 13.7x3.5mm | | H1080111 | stuk | 5,50 | 210 | 0 |
| | 0420514 | losse patroon voor hendel | | H1001700 | stuk | 34,75 | 210 | 1 |
| | 0420158 | omstelinrichting voor douchemengkraan compleet | | H3198001 | stuk | 12,75 | 210 | 0 |
| | 0421405 | omstelknop douchemengkraan | | H1080010 | stuk | 2,05 | 210 | 1 |
| | 0424005 | omstelrubber nieuw voor douchemengkraan | | H1080041 | stuk | 1,10 | 210 | 1 |
| | 0420107 | stelschroef voor bovendeel | | H1080049 | stuk | 0,26 | 210 | 1 |
| | 0420182 | verloopset 1-gats mengkraan | | H1060926 | stuk | 5,30 | 210 | 1 |









| Art.nr | Specificaties | Kleur | Lev.nr | Ehd | Prijs | Grp | CC | | |
|---|---------------|--------------|------------|------|---------|-----|----|---|---|
| | | | | | | | | Villeroy & Boch Circle | |
| 1-gats wastafelkraan 0474290 | | chrom/chroom | 3350092044 | stuk | 340,00 | 172 | 0 |  | Sanitair producten |
| 1-gats wastafelkraan verhoogd 0474304 | | chrom/chroom | 3353392044 | stuk | 520,00 | 172 | 1 |  | Baden / douchebakken / stoomcabines |
| 3-gats wastafelkraan 0474312 | | chrom/chroom | 2071092044 | stuk | 595,00 | 172 | 1 |  | Kranen |
| 1-gats bidetkraan 0474339 | | chrom/chroom | 3360092044 | stuk | 453,00 | 172 | 1 |  | Douchegarnituur |
| 4-gats badrandkraan 0474347 | | chrom/chroom | 2751292044 | stuk | 1067,00 | 172 | 1 |  | Accessoires en spiegels |
| 0470155 Perfecto montagesysteem 1/2" voor 4-gats kraan | | | 1261097090 | stuk | 555,00 | 172 | 0 | | |
| 0470163 Perfecto sierrozetten voor montagesysteem | chrom | | 1280197000 | stuk | 27,75 | 172 | 0 | | |
| badkraan m. badgarnituur 0474355 | | chrom/chroom | 2513392044 | stuk | 820,00 | 172 | 1 |  | Douchewanden |
| | | | | | | | | Villeroy & Boch Cult | |
| 1-gats wastafelkraan m. waste 0272625 | sprong=135mm | chrom | 3350096000 | stuk | 275,30 | 172 | 1 |  | Toebehoren & afvoeren |
| 1-gats wastafelkraan z. waste 0272659 | | chrom | 3352196000 | stuk | 246,80 | 172 | 1 | | |
| 0272626 | sprong=105mm | chrom | 3352596000 | stuk | 234,00 | 172 | 1 | | |
| 1-gats wastafelkraan verhoogd 0272627 | | chrom | 3353496000 | stuk | 439,00 | 172 | 1 | | Spoel- & installatiesystemen |
| afbouwdeel 2-gats wandkraan 0272628 | | chrom | 3681296000 | stuk | 353,90 | 172 | 1 | | Badkamermeubelen en toiletkasten |
| 1-gats bidetkraan m. waste 0272629 | | chrom | 3360096000 | stuk | 344,30 | 172 | 1 | | Gootstenen en wastroggen |
| baduitloop wandmontage 0272634 | 1/2"x210mm | chrom | 1380196000 | stuk | 319,00 | 172 | 1 | | Utiliteit |
| badkraan m. omstel z. garnituur 0272630 | | chrom | 3320096000 | stuk | 411,60 | 172 | 1 | | |
| douchekraan z. omstel 0272631 | | chrom | 3330096000 | stuk | 272,60 | 172 | 1 | | |
| X-stream afbouwdeel voor inbouwdouchekraan 0272633 | | chrom | 3601596000 | stuk | 205,50 | 172 | 1 | | |
| X-stream afbouwdeel voor inbouwbadkraan m. omstel 0272632 | | chrom | 3611596000 | stuk | 302,60 | 172 | 1 | | |









| | Art.nr | Specificaties | Kleur | Lev.nr | Ehd | Prijs | Grp | CC |
|----------------------------------|---------------------------------|---|-------|------------|------|--------|-----|----|
| | Villeroy & Boch Hype | | | | | | | |
| Sanitair producten | | 1-gats wastafelkraan m. waste 0475665 | chrom | 3350193000 | stuk | 251,00 | 172 | 1 |
| | | 1-gats bidetkraan m. waste 0475666 | chrom | 3360193000 | stuk | 346,00 | 172 | 1 |
| Kranen | | douchekraan z. garnituur 0475669 | chrom | 3330193000 | stuk | 273,00 | 172 | 1 |
| Douchegarnituur | | badkraan z. garnituur 0475668 | chrom | 3320193000 | stuk | 412,00 | 172 | 1 |
| Accessoires en spiegels | | badkraan m. garnituur 0475667 | chrom | 3323493000 | stuk | 624,00 | 172 | 1 |
| Douchewanden | | 1-gats wastafelkraan m. waste 0475882 | chrom | 3350093000 | stuk | 271,00 | 172 | 1 |
| Toebehoren & afvoeren | | 2-gats wastafelkraan 0475912 | chrom | 3250093000 | stuk | 515,00 | 172 | 1 |
| Badkamermeubelen en toiletkasten | | bidetkraan m. waste 0475890 | chrom | 3360093000 | stuk | 374,00 | 172 | 1 |
| Gootstenen en wastroggen | | badkraan z. garnituur 0475904 | chrom | 3320093000 | stuk | 515,00 | 172 | 1 |
| Utiliteit | | badkraan m. garnituur 0475939 | chrom | 3323393000 | stuk | 713,00 | 172 | 1 |
| | | douchekraan HOH=15cm 0475906 | chrom | 3330093000 | stuk | 341,00 | 172 | 1 |

| Art.nr | Specificaties | Kleur | Lev.nr | Ehd | Prijs | Grp | CC | | |
|---|--|-------|------------|------|--------|-----|----|---|---|
| | | | | | | | | Villeroy & Boch Hype | |
| wanduitloop 205mm | | | | | | | | | |
| 0475920 | | chrom | 1380193000 | stuk | 327,00 | 172 | 1 |  | Sanitair producten |
| xStream afbouwset inbouwbadkraan | | | | | | | | | |
| 0475908 | | chrom | 3611593000 | stuk | 303,00 | 172 | 1 |  | Baden / douchebakken / stoomcabines |
| 0475910 | inbouwdeel voor inbouwbad/douchekraan | | 3511597090 | stuk | 288,00 | 172 | 0 | | |
| xStream afbouwset inbouwdouchekraan | | | | | | | | | |
| 0475914 | | chrom | 3601593000 | stuk | 206,00 | 172 | 1 | | Douchegarnituur |
| 0475910 | inbouwdeel voor inbouwbad/douchekraan | | 3511597090 | stuk | 288,00 | 172 | 0 | | |
| xTool afbouwset inbouwthermostaat z. stopkraan | | | | | | | | | |
| 0475916 | | chrom | 3641293000 | stuk | 369,00 | 172 | 1 | | Accessoires en spiegels |
| 0474630 | X-tool inbouwthermostaat z. stopkraan 1/2" | | 3541297090 | stuk | 542,00 | 172 | 1 | | |
| 0474649 | X-tool inbouwthermostaat z. stopkraan 3/4" | | 3551297090 | stuk | 712,00 | 172 | 1 | | |
| xTool afbouwset inbouwstopkraan | | | | | | | | | |
| 0475918 | | chrom | 3630093000 | stuk | 71,00 | 172 | 1 | | Douchewanden |
| inbouwdeel voor inbouwbad/douchekraan | | | | | | | | | |
| 0475910 | | | 3511597090 | stuk | 288,00 | 172 | 0 |  | Toebehoren & afvoeren |
| | | | | | | | | Villeroy & Boch Look | |
| 1-gats wastafelkraan | | | | | | | | | |
| 0475571 | | chrom | 3350095000 | stuk | 197,00 | 172 | 1 |  | Spoel- & installatiesystemen |
| 1-gats wastafelkraan z. waste | | | | | | | | | |
| 0475520 | | chrom | 3352595000 | stuk | 177,00 | 172 | 1 |  | Badkamermeubelen en toiletkasten |
| 1-gats bidetmengkraan | | | | | | | | | |
| 0475570 | | chrom | 3360095000 | stuk | 245,00 | 172 | 1 |  | Gootstenen en wastroggen |
| baduitloop 1/2" 20,5cm | | | | | | | | | |
| 0475582 | | chrom | 1380195000 | stuk | 139,00 | 172 | 1 |  | Utiliteit |
| badkraan z. garnituur | | | | | | | | | |
| 0475574 | | chrom | 3320095000 | stuk | 245,00 | 172 | 1 |  | |

| | Art.nr | Specificaties | Kleur | Lev.nr | Ehd | Prijs | Grp | CC |
|---|-----------------------------------|--|-------|------------|------|--------|-----|----|
| Sanitair producten | Villeroy & Boch Look | | | | | | | |
| | | badkraan m.garnituur 0475594 | chrom | 3323395000 | stuk | 315,00 | 172 | 1 |
| Baden / douchebakken / stoomcabines | Villeroy & Boch Source | | | | | | | |
| | | douchekraan z. omstel 0475576 | chrom | 3330095000 | stuk | 216,00 | 172 | 1 |
| Kranen | Villeroy & Boch Source | | | | | | | |
| | | douchethermostaat HOH=15cm 0475564 | chrom | 3443095000 | stuk | 275,00 | 172 | 1 |
| Douchegarnituur | Villeroy & Boch Source | | | | | | | |
| | | afbouwset voor inbouwdouchekraan z.omstel 0475588 | chrom | 3601695000 | stuk | 141,00 | 172 | 1 |
| Accessoires en spiegels | Villeroy & Boch Source | | | | | | | |
| | | afbouwset voor inbouwbadkraan m. omstel 0475578 | chrom | 3611695000 | stuk | 211,00 | 172 | 1 |
| Douchewanden | Villeroy & Boch Source | | | | | | | |
| | | 1-gats wastafelkraan m. waste 0475662 | chrom | 3350094500 | stuk | 392,00 | 172 | 1 |
| Toebehoren & afvoeren | Villeroy & Boch Source | | | | | | | |
| | | 1-gats wastafelkraan z. waste 0475663 | chrom | 3352194500 | stuk | 364,00 | 172 | 1 |
| Spoel- & installatiesystemen | Villeroy & Boch Source | | | | | | | |
| | | 1-gats bidetkraan m. waste 0475664 | chrom | 3360094500 | stuk | 475,00 | 172 | 1 |
| Badkamermeubelen en toiletkasten | Villeroy & Boch Source | | | | | | | |
| | | afbouwset v. 2-gats wandkraan m. uitloop 225mm 0475687 | chrom | 3681494500 | stuk | 493,00 | 172 | 1 |
| Gootstenen en wastroggen | Villeroy & Boch Source | | | | | | | |
| | | 1-gats wastafelkraan m. hendel 0475522 | chrom | 3351394000 | stuk | 386,00 | 272 | 1 |
| Utiliteit | Villeroy & Boch Source | | | | | | | |
| | | 1-gats wastafelkraan m. waste 0475662 | chrom | 3350094500 | stuk | 392,00 | 172 | 1 |

| Art.nr | Specificaties | Kleur | Lev.nr | Ehd | Prijs | Grp | CC | | |
|--|--|-------|------------|------|--------|-----|----|---|---|
| | | | | | | | | Villeroy & Boch Source | |
| 1-gats wastafelkraan m. 2 grepen | | | | | | | | | |
| 0475523 | | chrom | 2251394000 | stuk | 386,00 | 272 | 1 |  | Sanitair producten |
| 1-gats wastafelkraan verhoogd | | | | | | | | | |
| 0476103 | | chrom | 3353394000 | stuk | 581,00 | 272 | 1 |  | Baden / douchebakken / stoomcabines |
| 2-gats wastafelkraan | | | | | | | | | |
| 0475524 | | chrom | 3251394000 | stuk | 602,00 | 272 | 1 |  | Kranen |
| afbouwset wandkraan m. rozetten | | | | | | | | | |
| 0475526 | 17cm | chrom | 3681094000 | stuk | 455,00 | 272 | 1 |  | Douchegarnituur |
| 0475528 | 21cm | chrom | 3681294000 | stuk | 485,00 | 272 | 1 | | |
| 0475432 | inbouwdeel wastafelwandkraan rechts | | 3580697090 | stuk | 168,00 | 172 | 0 | | |
| 0475459 | inbouwdeel wastafelwandkraan boven | | 3580897090 | stuk | 168,00 | 172 | 1 | | |
| 0475527 | inbouwdeel wastafelwandkraan links | | 3580797090 | stuk | 168,00 | 172 | 0 | | |
| afbouwset wandkraan m. afdekplaat | | | | | | | | | |
| 0475529 | 17cm | chrom | 3682094000 | stuk | 478,00 | 272 | 1 |  | Douchewanden |
| 0475530 | 21cm | chrom | 3682294000 | stuk | 509,00 | 272 | 1 | | |
| 0475432 | inbouwdeel wastafelwandkraan rechts | | 3580697090 | stuk | 168,00 | 172 | 0 | | |
| 0475459 | inbouwdeel wastafelwandkraan boven | | 3580897090 | stuk | 168,00 | 172 | 1 | | |
| 0475527 | inbouwdeel wastafelwandkraan links | | 3580797090 | stuk | 168,00 | 172 | 0 | | |
| X-Stream afbouwset inbouwbadkraan m. omstel | | | | | | | | | |
| 0475533 | | chrom | 3611594000 | stuk | 377,00 | 272 | 1 |  | Badkamermeubelen en toiletkasten |
| 0475910 | inbouwdeel voor inbouwbad/douchekraan | | 3511597090 | stuk | 288,00 | 172 | 0 | | |
| X-Stream afbouwset inbouwdouchekraan z. omstel | | | | | | | | | |
| 0475534 | | chrom | 3601594000 | stuk | 270,00 | 272 | 1 |  | Gootstenen en wastroggen |
| 0475910 | inbouwdeel voor inbouwbad/douchekraan | | 3511597090 | stuk | 288,00 | 172 | 0 | | |
| afbouwset inbouwdouchekraan m. glijstangset m. rozetten | | | | | | | | | |
| 0475535 | | chrom | 3601094000 | stuk | 817,00 | 272 | 1 |  | Utiliteit |
| 0475467 | inbouwdeel douchekraan rechts | | 3500697090 | stuk | 171,00 | 172 | 1 | | |
| 0475475 | inbouwdeel douchekraan links | | 3500797090 | stuk | 171,00 | 172 | 1 | | |
| afbouwset inbouwdouchekraan m. rozet | | | | | | | | | |
| 0475536 | | chrom | 3600894000 | stuk | 265,00 | 272 | 1 |  | |
| 0475537 | inbouwdeel voor inbouwdouchekraan | | 3500897090 | stuk | 171,00 | 172 | 0 | | |
| X-Tool afbouwset inbouwthermostaat z. stopkraan | | | | | | | | | |
| 0475538 | | chrom | 3641294000 | stuk | 382,00 | 272 | 1 |  | |
| 0474630 | X-tool inbouwthermostaat z. stopkraan 1/2" | | 3541297090 | stuk | 542,00 | 172 | 1 | | |
| 0474649 | X-tool inbouwthermostaat z. stopkraan 3/4" | | 3551297090 | stuk | 712,00 | 172 | 1 | | |
| X-Tool afbouwset inbouwstopkraan | | | | | | | | | |
| 0475539 | | chrom | 3630094000 | stuk | 97,50 | 272 | 1 | | |

| | Art.nr | Specificaties | Kleur | Lev.nr | Ehd | Prijs | Grp | CC | |
|---|---|--|---|------------|------------|---------|-------|-----|---|
| | Villeroy & Boch Source | | | | | | | | |
| | afbouwset inbouwstopkraan | | | | | | | | |
| Sanitair producten |  | 0475540 | chroom | 3631094000 | stuk | 109,00 | 272 | 1 | |
| | | 0472671 inbouwdeel voor stopkraan koud 1/2" | | 3562197090 | stuk | 62,50 | 172 | 0 | |
| | | 0472672 inbouwdeel voor stopkraan warm 1/2" | | 3567197090 | stuk | 62,50 | 172 | 0 | |
| | | 0472673 inbouwdeel voor stopkraan koud 3/4" | | 3562297090 | stuk | 81,00 | 172 | 0 | |
| | Baden / douchebakken / stoomcabines | | 0472674 inbouwdeel voor stopkraan warm 3/4" | | 3567297090 | stuk | 81,00 | 172 | 0 |
| | | | 0472675 inbouwdeel voor stopkraan koud 15mm | | 3563197090 | stuk | 62,50 | 172 | 0 |
| | | | 0472676 inbouwdeel voor stopkraan warm 15mm | | 3568197090 | stuk | 62,50 | 172 | 0 |
| | | | 0472677 inbouwdeel voor stopkraan koud 22mm | | 3563397090 | stuk | 81,00 | 172 | 1 |
| | | | 0472678 inbouwdeel voor stopkraan warm 22mm | | 3568397090 | stuk | 81,00 | 172 | 1 |
| Kranen |  | baduitloop 1/2 0475542 21cm | chroom | 1380194000 | stuk | 387,00 | 272 | 1 | |
| Douchegarnituur | | badkraan m. garnituur m. standpijpen | | | | | | | |
| Accessoires en spiegels |  | 0476104 | chroom | 2595394000 | stuk | 2331,00 | 272 | 1 | |
| | | 0470571 inbouwdeel bodemplaat compleet | | 3594397090 | stuk | 269,00 | 172 | 1 | |
| Douchewanden | | hoekstopkraan 1/2" 0475525 | chroom | 2290094000 | stuk | 106,00 | 172 | 1 | |
|  | | | | | | | | | |
| Toebehoren & afvoeren | | douchethermostaat z. hendel m. hoofddouche m. koppelingen | | | | | | | |
| Spoel- & installatiesystemen |  | 0474451 | chroom | 3445597800 | stuk | 1585,00 | 172 | 1 | |
| | | 0472891 kruisgreep chroom | | 1142047000 | stuk | 141,00 | 172 | 1 | |
| | | 0473871 temperatuurgreep chroom | | 1142075000 | stuk | 135,00 | 172 | 1 | |
| Badkamermeubelen en toiletkasten | | hendel los voor douchethermostaat 0475532 | chroom | 1142094000 | stuk | 153,00 | 272 | 1 | |
| Gootstenen en wastroggen | | Villeroy & Boch Square | | | | | | | |
| Utiliteit |  | 3-gats wastafelkraan m. waste 0475678 | chroom | 2070091500 | stuk | 667,00 | 172 | 1 | |
| |  | 4-gats badkraan m. garnituur 0475682 | chroom | 2751291500 | stuk | 1321,00 | 172 | 1 | |
| |  | bidetuitloop 0475681 | chroom | 1390091500 | stuk | 510,00 | 172 | 1 | |
| | | baduitloop m. omstel 190mm 0475683 | chroom | 1351291500 | stuk | 689,00 | 172 | 1 | |

| Art.nr | Specificaties | Kleur | Lev.nr | Ehd | Prijs | Grp | CC | |
|--------------------------------------|--|-------|------------|------|---------|-----|----|---|
| | | | | | | | | Villeroy & Boch Square |
| wandbaduitloop z. omstel | | | | | | | | |
| 0475684 | | chrom | 1380191500 | stuk | 497,00 | 172 | 1 |  |
| hoekstopkraan 1/2" | | | | | | | | |
| 0475679 | rechts | chrom | 2000091500 | stuk | 150,00 | 172 | 1 | |
| 0475680 | links | chrom | 2000091600 | stuk | 150,00 | 172 | 1 | |
| X-stream afbouwset z. omstel | | | | | | | | |
| 0475686 | | chrom | 3601591500 | stuk | 274,00 | 172 | 1 | |
| 0475910 | inbouwdeel voor inbouwbad/douche kraan | | 3511597090 | stuk | 288,00 | 172 | 0 |  |
| X-stream afbouwset m. omstel | | | | | | | | |
| 0475685 | | chrom | 3611591500 | stuk | 346,00 | 172 | 1 | |
| 0475910 | inbouwdeel voor inbouwbad/douche kraan | | 3511597090 | stuk | 288,00 | 172 | 0 | |
| 1-gats wastafelkraan m. waste | | | | | | | | |
| 0474428 | | chrom | 2251091000 | stuk | 414,00 | 172 | 1 |  |
| 3-gats wastafelkraan m. waste | | | | | | | | |
| 0474436 | | chrom | 2071091000 | stuk | 636,00 | 172 | 1 |  |
| fonteinkraan koud | | | | | | | | |
| 0474452 | | chrom | 1750091000 | stuk | 185,00 | 172 | 1 |  |
| 1-gats bidetkraan m. waste | | | | | | | | |
| 0474460 | | chrom | 2451091000 | stuk | 520,00 | 172 | 1 |  |
| douche kraan z. omstel | | | | | | | | |
| 0474495 | | chrom | 2610091000 | stuk | 509,00 | 172 | 1 |  |
| badkraan m. garnituur | | | | | | | | |
| 0474487 | | chrom | 2513391000 | stuk | 879,00 | 172 | 1 |  |
| 4-gats badkraan m. garnituur | | | | | | | | |
| 0474479 | | chrom | 2751291000 | stuk | 1258,00 | 172 | 1 | |
| 0470155 | Perfecto montagesysteem 1/2" voor 4-gats kraan | | 1261097090 | stuk | 555,00 | 172 | 0 | |
| 0470163 | Perfecto sierrozetten voor montagesysteem | chrom | 1280197000 | stuk | 27,75 | 172 | 0 |  |

Sanitair producten

Baden /
douchebakken /
stoomcabines

Kranen

Douchegarnituur

Accessoires en
spiegels

Douchewanden

Toebehoren &
afvoerenSpoel- &
installatiesystemenBadkamermeubelen
en toiletkastenGootstenen en
wastroggen

Utiliteit

| | Art.nr | Specificaties | Kleur | Lev.nr | Ehd | Prijs | Grp | CC |
|---|---|---|--------|------------|------|--------|-----|----|
| | Villeroy & Boch Square | | | | | | | |
| | hendel los voor douchethermostaat | | | | | | | |
| Sanitair producten | 0474509 | | chroom | 1142091000 | stuk | 141,00 | 172 | 1 |
| | 0472522 | douchethermostaat 1/2" z. hendel m. koppelingen | chroom | 3442097000 | stuk | 468,00 | 172 | 0 |
| Baden / douchebakken / stoomcabines | baduitloop 1/2" 19cm | | | | | | | |
| | 0474533 | | chroom | 1380191000 | stuk | 474,00 | 172 | 1 |
| Kranen | X-tool afbouwset voor inbouwthermostaat z. stopkraan | | | | | | | |
| | 0476382 | | chroom | 3641291000 | stuk | 354,00 | 172 | 1 |
| | 0474630 | X-tool inbouwthermostaat z. stopkraan 1/2" | | 3541297090 | stuk | 542,00 | 172 | 1 |
| | 0474649 | X-tool inbouwthermostaat z. stopkraan 3/4" | | 3551297090 | stuk | 712,00 | 172 | 1 |
| Douchegarnituur | X-tool afbouwdeel voor inbouwstopkraan | | | | | | | |
| | 0476390 | | chroom | 3630091000 | stuk | 120,00 | 172 | 1 |
| Accessoires en spiegels | | | | | | | | |
| Douchewanden | | | | | | | | |
| Toebehoren & afvoeren | | | | | | | | |
| Spoel- & installatiesystemen | | | | | | | | |
| Badkamermeubelen en toiletkasten | | | | | | | | |
| Gootstenen en wastroggen | | | | | | | | |
| Utiliteit | | | | | | | | |

| Art.nr | Specificaties | Kleur | Lev.nr | Ehd | Prijs | Grp | CC |
|--------|---------------|-------|--------|-----|-------|-----|----|
|--------|---------------|-------|--------|-----|-------|-----|----|

Damixa Arc

1-gats keukenkraan m. draaibare uitloop

| | | | | | | | |
|---------|--|--------|------------|------|--------|-----|---|
| 0460185 | | chroom | 2600000B38 | stuk | 264,00 | 159 | 1 |
| 0460186 | | RVS | 2600066B38 | stuk | 322,00 | 159 | 1 |



Sanitair producten

Baden /
douchebakken /
stoomcabines

Damixa Eclipse

1-gats keukenkraan m. draaibare uitloop

| | | | | | | | |
|---------|--|--------|------------|------|-------|-----|---|
| 0460257 | | chroom | 4000000B38 | stuk | 99,50 | 159 | 1 |
|---------|--|--------|------------|------|-------|-----|---|



Kranen

1-gats keukenkraan lage druk

| | | | | | | | |
|---------|--|--------|----------|------|--------|-----|---|
| 0460258 | | chroom | 4000300B | stuk | 167,00 | 159 | 1 |
|---------|--|--------|----------|------|--------|-----|---|



Douchegarnituur

Accessoires en
spiegels**wandkeukenkraan z. uitloop**

| | | | | | | | |
|---------|--|--------|----------|------|--------|-----|---|
| 0460259 | | chroom | 4730000B | stuk | 145,00 | 159 | 1 |
|---------|--|--------|----------|------|--------|-----|---|



Douchewanden

Toebehoren &
afvoeren

Damixa G Type V3.0

keukenkraan

| | | | | | | | |
|---------|--|--------|------------|------|--------|-----|---|
| 0440033 | | chroom | 7200000B38 | stuk | 517,00 | 159 | 1 |
|---------|--|--------|------------|------|--------|-----|---|

Spoel- &
installatiesystemen**1-gats keukenkraan m. draaibare uitloop**

| | | | | | | | |
|---------|--|-----|------------|------|--------|-----|---|
| 0460145 | | RVS | 7200066B38 | stuk | 619,00 | 159 | 1 |
|---------|--|-----|------------|------|--------|-----|---|

Badkamermeubelen
en toiletkasten

Damixa Gala

1-gats keukenkraan m. draaibare uitloop

| | | | | | | | |
|---------|--|--------|------------|------|--------|-----|---|
| 0460170 | | chroom | 7000000B38 | stuk | 296,00 | 159 | 1 |
|---------|--|--------|------------|------|--------|-----|---|

| | | | | | | | |
|---------|--|-----|------------|------|--------|-----|---|
| 0460171 | | RVS | 7000066B38 | stuk | 446,00 | 159 | 1 |
|---------|--|-----|------------|------|--------|-----|---|

Gootstenen en
wastroggen**1-gats keukenkraan lage druk**

| | | | | | | | |
|---------|--|--------|----------|------|--------|-----|---|
| 0460172 | | chroom | 7000300B | stuk | 307,00 | 159 | 1 |
|---------|--|--------|----------|------|--------|-----|---|









Utiliteit









1-gats keukenkraan m. uittrekbare handdouche









| | | | | | | | |
|---------|--|--------|------------|------|--------|-----|---|
| 0460173 | | chroom | 7012000B38 | stuk | 402,00 | 159 | 1 |
|---------|--|--------|------------|------|--------|-----|---|

| | | | | | | | |
|---------|--|-----|------------|------|--------|-----|---|
| 0460174 | | RVS | 7012066B38 | stuk | 542,00 | 159 | 1 |
|---------|--|-----|------------|------|--------|-----|---|



| | Art.nr | Specificaties | Kleur | Lev.nr | Ehd | Prijs | Grp | CC |
|---|---|---|--------|------------|------|--------|-----|----|
| Sanitair producten | Damixa Gala | | | | | | | |
| | | 1-gats keukenkraan m. uittrekbare handdouche lage druk | | | | | | |
| | 0460175 | | chroom | 7012300B | stuk | 499,00 | 159 | 1 |
| Baden / douchebakken / stoomcabines |  | | | | | | | |
| | <hr/> | | | | | | | |
| Kranen | Damixa Jupiter | | | | | | | |
| | | 1-gats keukenkraan m. uittrekbare handdouche | | | | | | |
| | 0460218 | | chroom | 1512000B38 | stuk | 232,00 | 159 | 1 |
| Douchegarnituur |  | | | | | | | |
| | | wandkeukenkraan z. uitloop | | | | | | |
| | 0460219 | | chroom | 1530000B | stuk | 156,00 | 159 | 1 |
| Accessoires en spiegels | Damixa Kafe | | | | | | | |
| | | 1-gats keukenkraan m. draaibare uitloop | | | | | | |
| Douchewanden | | 0460141 | chroom | 1400800A38 | stuk | 219,00 | 159 | 1 |
| | | 0460142 | RVS | 1400866A38 | stuk | 284,00 | 159 | 1 |
| Toebehoren & afvoeren |  | | | | | | | |
| | | 1-gats keukenkraan m. uittrekbare handdouche | | | | | | |
| Spoel- & installatiesystemen | | 0460143 | chroom | 1413800A38 | stuk | 317,00 | 159 | 1 |
| | | 0460144 | RVS | 1413866A38 | stuk | 412,00 | 159 | 1 |
| Badkamermeubelen en toiletkasten | Damixa Luna | | | | | | | |
| | | 1-gats keukenkraan verhoogd | | | | | | |
| Gootstenen en wastroggen | | 0460163 | chroom | 2100000A38 | stuk | 326,00 | 159 | 1 |
| | | 0460164 | RVS | 2100066A38 | stuk | 424,00 | 159 | 1 |
| Utiliteit | Damixa Merkur | | | | | | | |
| | | 1-gats keukenkraan m. draaibare uitloop | | | | | | |
| | | 0440040 | chroom | 1400000C38 | stuk | 287,00 | 159 | 1 |
| | | 0460152 | RVS | 1400066C38 | stuk | 401,00 | 159 | 1 |
| |  | | | | | | | |
| | | 2-gats keukenkraan m. draaibare uitloop | | | | | | |
| | | 0460153 | chroom | 1406500C38 | stuk | 416,00 | 159 | 1 |
| | | 0460154 | RVS | 1406566C38 | stuk | 542,00 | 159 | 1 |
| |  | | | | | | | |
| | | 1-gats keukenkraan m. uittrekbare handdouche | | | | | | |
| | | 0460155 | chroom | 1412000A38 | stuk | 435,00 | 159 | 1 |
| | | 0460156 | RVS | 1412066A38 | stuk | 564,00 | 159 | 1 |
| |  | | | | | | | |

| Art.nr | Specificaties | Kleur | Lev.nr | Ehd | Prijs | Grp | CC | | |
|--|---------------|--------|------------|------|--------|-----|----|---|---|
| | | | | | | | | Damixa Object | |
| 1-gats keukenkraan m. draaibare uitloop 0460265 | | chroom | 3000000L38 | stuk | 54,50 | 159 | 1 |  | Sanitair producten |
| 1-gats keukenkraan lage druk 0460266 | | chroom | 3000300L | stuk | 93,00 | 159 | 1 |  | Baden / douchebakken / stoomcabines |
| 1-gats keukenkraan laag model 0460267 | | chroom | 3000800L38 | stuk | 70,50 | 159 | 1 |  | Kranen |
| 1-gats keukenkraan lage druk 0460268 | | chroom | 3000900L | stuk | 118,00 | 159 | 1 |  | Douchegarnituur |
| wandkeukenkraan z. uitloop 0460269 | | chroom | 3004600L | stuk | 46,00 | 159 | 1 |  | Accessoires en spiegels |
| uitloop voor wandkeukenkraan | | | | | | | | | Douchewanden |
| 0460271 20cm | | chroom | 3009000 | stuk | 18,25 | 159 | 1 | | Toebehoren & afvoeren |
| 0460273 30cm | | chroom | 3009100 | stuk | 15,00 | 159 | 1 | | Spoel- & installatiesystemen |
| 0460272 25cm | | chroom | 3009400 | stuk | 15,00 | 159 | 1 | | Badkamermeubelen en toiletkasten |
| 0460270 18cm | | chroom | 3030200 | stuk | 11,75 | 159 | 1 | | Gootstenen en wastroggen |
| | | | | | | | | Damixa Saturn | |
| 1-gats keukenkraan m. draaibare uitloop 0460199 | | chroom | 2500000A38 | stuk | 154,00 | 159 | 1 |  | Utiliteit |
| 1-gats keukenkraan m. hoge uitloop 0460201 | | chroom | 2507000A38 | stuk | 232,00 | 159 | 1 |  | |
| 1-gats keukenkraan m. uittrekbare handdouche 0460200 | | chroom | 2512000A38 | stuk | 245,00 | 159 | 1 |  | |

| | Art.nr | Specificaties | Kleur | Lev.nr | Ehd | Prijs | Grp | CC |
|---|---|---|-------|------------|------|--------|-----|----|
| Sanitair producten | Damixa Saturn | | | | | | | |
| | | wandkeukenkraan z. uitloop | | | | | | |
| | 0460202 | | chrom | 2530000A | stuk | 171,00 | 159 | 1 |
| Baden / douchebakken / stoomcabines |  | | | | | | | |
| Kranen | Damixa Space | | | | | | | |
| | | 1-gats keukenkraan m. draaibare uitloop | | | | | | |
| | 0460233 | | chrom | 1000000B38 | stuk | 73,00 | 159 | 1 |
| Douchegarnituur |  | | | | | | | |
| Accessoires en spiegels | Damixa Space | | | | | | | |
| | | 1-gats keukenkraan lage druk | | | | | | |
| | 0460234 | | chrom | 1000300B | stuk | 88,00 | 159 | 1 |
| Douchewanden |  | | | | | | | |
| Toebehoren & afvoeren | Damixa Space | | | | | | | |
| | | 1-gats keukenkraan m. uittrekbare handdouche | | | | | | |
| | 0460235 | | chrom | 1012000B38 | stuk | 117,00 | 159 | 1 |
| Douchewanden |  | | | | | | | |
| Spoel- & installatiesystemen | Damixa Superstar | | | | | | | |
| | | 1-gats keukenkraan m. draaibare uitloop | | | | | | |
| | 0460250 | | chrom | 3600000B38 | stuk | 192,00 | 159 | 1 |
| Badkamermeubelen en toiletkasten |  | | | | | | | |
| Gootstenen en wastroggen | Damixa Titan | | | | | | | |
| | | 1-gats keukenkraan m. draaibare uitloop | | | | | | |
| | 0460241 | | chrom | 6200000A38 | stuk | 186,00 | 159 | 1 |
| Utiliteit |  | | | | | | | |
| Utiliteit | Damixa Titan | | | | | | | |
| | | 1-gats keukenkraan lage druk | | | | | | |
| | 0460242 | | chrom | 6200300A | stuk | 173,00 | 159 | 1 |
| Utiliteit |  | | | | | | | |
| Utiliteit | Damixa Tradition | | | | | | | |
| | | 1-gats keukenkraan nostalgisch | | | | | | |
| | 0460281 | | chrom | 240000038 | stuk | 196,00 | 159 | 1 |
| Utiliteit |  | | | | | | | |
| Utiliteit | Damixa Tradition | | | | | | | |
| | | 1-gats keukenkraan m. draaibare uitloop | | | | | | |
| | 0460282 | | chrom | 370050038 | stuk | 117,00 | 159 | 1 |
| Utiliteit |  | | | | | | | |

| Art.nr | Specificaties | Kleur | Lev.nr | Ehd | Prijs | Grp | CC |
|--------|---------------|-------|--------|-----|-------|-----|----|
|--------|---------------|-------|--------|-----|-------|-----|----|

Damixa Tradition

1-gats keukenkraan m. draaibare uitloop zwaar
0460283

chroom 370080038 stuk 125,00 159 1



Sanitair producten

Baden /
douchebakken /
stoomcabines

wandkeukenkraan z. uitloop
0460284

chroom 3704600 stuk 96,00 159 1



Kranen

Douchegarnituur

uitloop voor wandkeukenkraan

| | | | | | | | |
|---------|------|--------|---------|------|-------|-----|---|
| 0460271 | 20cm | chroom | 3009000 | stuk | 18,25 | 159 | 1 |
| 0460273 | 30cm | chroom | 3009100 | stuk | 15,00 | 159 | 1 |
| 0460272 | 25cm | chroom | 3009400 | stuk | 15,00 | 159 | 1 |
| 0460270 | 18cm | chroom | 3030200 | stuk | 11,75 | 159 | 1 |

Accessoires en
spiegels

Damixa Venus

1-gats keukenkraan m. draaibare uitloop

| | | | | | | | |
|---------|--|--------|------------|------|--------|-----|---|
| 0460193 | | chroom | 1600000C38 | stuk | 206,00 | 159 | 1 |
| 0460194 | | RVS | 1600066C38 | stuk | 308,00 | 159 | 1 |



Douchewanden

Toebehoren &
afvoeren

1-gats keukenkraan X-change

| | | | | | | | |
|---------|--|--------|------------|------|--------|-----|---|
| 0460195 | | chroom | 1604700A38 | stuk | 219,00 | 159 | 1 |
| 0460196 | | RVS | 1604766A38 | stuk | 312,00 | 159 | 1 |









Spoel- &
installatiesystemen

Badkamermeubelen
en toiletkasten

Gootstenen en
wastroggen

Utiliteit

| | Art.nr | Specificaties | Kleur | Lev.nr | Ehd | Prijs | Grp | CC |
|---|---|---------------|-------------|------------|------|---------|-----|----|
| | Dornbracht Lot | | | | | | | |
| | 3-gats keukenkraan 23.5cm | | | | | | | |
| Sanitair producten | 0475108 | | chroom | 2081068000 | stuk | 1094,70 | 172 | 1 |
| | 0475109 | | platina mat | 2081068006 | stuk | 1610,20 | 172 | 1 |
| | 3-gats keukenkraan m. afdekplaat | | | | | | | |
| Baden / douchebakken / stoomcabines | 0475115 | | chroom | 2083068000 | stuk | 1137,70 | 172 | 1 |
| | 0475116 | | platina mat | 2083068006 | stuk | 1673,50 | 172 | 1 |
| | Dornbracht Madison | | | | | | | |
| | 1-gats keukenkraan m. draaibare uitloop 20cm | | | | | | | |
| Kranen | 0470189 | | chroom | 2202136000 | stuk | 658,00 | 172 | 1 |
| | 0470302 | | platina-mat | 2202136006 | stuk | 987,00 | 172 | 1 |
| | 2-gats keukenkraan staand m. draaibare uitloop 20cm | | | | | | | |
| Douchegarnituur | 0473367 | | chroom | 1912536000 | stuk | 777,00 | 172 | 1 |
| | 0470176 | | platina-mat | 1912536006 | stuk | 1165,00 | 172 | 1 |
| Accessoires en spiegels |  | | | | | | | |
| | 3-gats keukenkraan m. draaibare uitloop 20cm | | | | | | | |
| Douchewanden | 0473375 | | chroom | 2071236000 | stuk | 895,00 | 172 | 1 |
| | 0470303 | | platina-mat | 2071236006 | stuk | 1342,00 | 172 | 1 |
| Toebehoren & afvoeren |  | | | | | | | |
| | 2-gats wandkraan m. hoge uitloop 26cm | | | | | | | |
| Spoel- & installatiesystemen | 0473308 | | chroom | 3112536000 | stuk | 800,00 | 172 | 1 |
| | 0470304 | | platina-mat | 3112536006 | stuk | 1200,00 | 172 | 1 |
| Badkamermeubelen en toiletkasten |  | | | | | | | |
| | Dornbracht Maro | | | | | | | |
| | 2-gats keukenkraan 23.5cm | | | | | | | |
| Gootstenen en wastroggen | 0475124 | | chroom | 3280079500 | stuk | 602,30 | 172 | 1 |
| | 0475125 | | platina mat | 3280079506 | stuk | 885,90 | 172 | 1 |
| Utiliteit |  | | | | | | | |
| | Dornbracht Meta.02 | | | | | | | |
| | 2-gats keukenkraan m. uitloop 20cm | | | | | | | |
| Utiliteit | 0475572 | | chroom | 3280062500 | stuk | 451,00 | 172 | 1 |
| | 0475637 | | platina-mat | 3280062506 | stuk | 632,00 | 172 | 1 |
| |  | | | | | | | |
| | wandkeukenkraan uitloop 300mm m. rozet | | | | | | | |
| | 0475602 | | chroom | 3683862500 | stuk | 541,00 | 172 | 1 |
| | 0475661 | | platina-mat | 3683862506 | stuk | 757,00 | 172 | 1 |
| |  | | | | | | | |
| | wandkeukenkraan uitloop 495mm m. rozet | | | | | | | |
| | 0475629 | | chroom | 3685162500 | stuk | 551,00 | 172 | 1 |
| | 0475688 | | platina-mat | 3685162506 | stuk | 771,00 | 172 | 1 |
| |  | | | | | | | |

| Art.nr | Specificaties | Kleur | Lev.nr | Ehd | Prijs | Grp | CC |
|--------|---------------|-------|--------|-----|-------|-----|----|
|--------|---------------|-------|--------|-----|-------|-----|----|

Dornbracht Tara

1-gats keukenkraan m. draaibare uitloop 235mm

| | | | | | | | |
|---------|--|-------------|------------|------|--------|-----|---|
| 0471658 | | chroom | 2281589000 | stuk | 304,00 | 172 | 0 |
| 0471700 | | platina-mat | 2281589006 | stuk | 438,00 | 172 | 1 |



Sanitair producten

2-gats keukenkraan staand m. draaibare uitloop 20cm

| | | | | | | | |
|---------|--|-------------|------------|------|--------|-----|---|
| 0470580 | | chroom | 1912589000 | stuk | 545,00 | 172 | 1 |
| 0470590 | | platin | 1912589008 | stuk | 817,00 | 172 | 1 |
| 0472002 | | platina-mat | 1912589006 | stuk | 817,00 | 172 | 1 |

Baden /
douchebakken /
stoomcabines

Kranen

1-gats wandkeukenkraan m. uittrekbare uitloop 315-485mm

| | | | | | | | |
|---------|--|-------------|------------|------|--------|-----|---|
| 0475505 | | chroom | 3015189000 | stuk | 291,00 | 172 | 1 |
| 0475548 | | platina-mat | 3015189006 | stuk | 408,00 | 172 | 1 |



Douchegarnituur

Accessoires en
spiegels**2-gats wandkraan m. uittrekbare uitloop 365-545mm m. koppelingen**

| | | | | | | | |
|---------|--|-------------|------------|------|--------|-----|---|
| 0470004 | | chroom | 3115189000 | stuk | 563,00 | 172 | 1 |
| 0473634 | | platina-mat | 3115189006 | stuk | 789,00 | 172 | 1 |



Douchewanden

Toebehoren &
afvoeren

Dornbracht Tara-Classic

2-gats keukenkraan z. hendel

| | | | | | | | |
|---------|-------------|-------------|------------|------|--------|-----|---|
| 0473189 | | chroom | 1912588000 | stuk | 500,00 | 172 | 1 |
| 0473804 | | platina-mat | 1912588006 | stuk | 750,00 | 172 | 1 |
| 0472384 | kraanhendel | platin | 1117088008 | stuk | 46,75 | 172 | 1 |

Spoel- &
installatiesystemen**1-gats keukenkraan m. hendel rechts**

| | | | | | | | |
|---------|------------------|-------------|------------|------|--------|-----|---|
| 0472360 | m. uitloop 200mm | chroom | 3380088800 | stuk | 443,00 | 172 | 1 |
| 0472368 | m. uitloop 200mm | platina-mat | 3380088806 | stuk | 620,00 | 172 | 1 |
| 0472370 | m. uitloop 235mm | chroom | 3381588800 | stuk | 443,00 | 172 | 0 |
| 0272525 | m. uitloop 235mm | platina-mat | 3381588806 | stuk | 620,00 | 172 | 1 |

Badkamermeubelen
en toiletkastenGootstenen en
wastroggen**1-gats keukenkraan m. hendel links**

| | | | | | | | |
|---------|------------------|-------------|------------|------|--------|-----|---|
| 0474656 | m. uitloop 200mm | chroom | 3380088900 | stuk | 443,00 | 172 | 1 |
| 0474658 | m. uitloop 200mm | platina-mat | 3380088906 | stuk | 620,00 | 172 | 1 |
| 0474661 | m. uitloop 235mm | chroom | 3381588900 | stuk | 443,00 | 172 | 1 |
| 0474662 | m. uitloop 235mm | platina-mat | 3381588906 | stuk | 620,00 | 172 | 1 |





Utiliteit

1-gats keukenkraan m. hendel rechts lagedruk

| | | | | | | | |
|---------|------------------|-------------|------------|------|--------|-----|---|
| 0474666 | m. uitloop 200mm | chroom | 3385588800 | stuk | 502,00 | 172 | 1 |
| 0474667 | m. uitloop 200mm | platina-mat | 3385588806 | stuk | 703,00 | 172 | 1 |
| 0474668 | m. uitloop 235mm | chroom | 3385588800 | stuk | 502,00 | 172 | 1 |
| 0474669 | m. uitloop 235mm | platina-mat | 3385588806 | stuk | 703,00 | 172 | 1 |



| | Art.nr | Specificaties | Kleur | Lev.nr | Ehd | Prijs | Grp | CC |
|---|---|---------------|-------------|------------|------|---------|-----|----|
| Sanitair producten | Dornbracht Tara-Classic | | | | | | | |
| | Profi 1-gats keukenkraan hoogte 665mm | | | | | | | |
| | 0475483 | rechts | chroom | 3388088800 | stuk | 919,00 | 172 | 1 |
| | 0475513 | rechts | platina-mat | 3388088806 | stuk | 1287,00 | 172 | 1 |
| | 0475491 | links | chroom | 3388088900 | stuk | 919,00 | 172 | 1 |
| Baden / douchebakken / stoomcabines | 0475521 | links | platina-mat | 3388088906 | stuk | 1287,00 | 172 | 1 |
| |  | | | | | | | |
| Kranen |  | | | | | | | |
| | <hr/> | | | | | | | |
| Douchegarnituur | Dornbracht Universeel | | | | | | | |
| Accessoires en spiegels | douchegarnituur voor keukenkraan | | | | | | | |
| | 0086231 | | chroom | 2771797000 | stuk | 228,00 | 172 | 1 |
| | 0086258 | | platina | 2771797008 | stuk | 301,00 | 172 | 1 |
| Douchewanden | 0086266 | | platina-mat | 2771797006 | stuk | 301,00 | 172 | 1 |
| | handdouche voor keukenkraan | | | | | | | |
| | 0475110 | | chroom | 2771497000 | stuk | 308,00 | 172 | 1 |
| Toebehoren & afvoeren | 0475111 | | platina mat | 2771497006 | stuk | 453,10 | 172 | 1 |
| | professional handdouche voor keukenkraan | | | | | | | |
| | 0475112 | | chroom | 2778497000 | stuk | 773,10 | 172 | 1 |
| Spoel- & installatiesystemen | 0475113 | | platina mat | 2778497006 | stuk | 1137,10 | 172 | 1 |
| | 0475117 | | chroom | 2778997000 | stuk | 729,80 | 172 | 1 |
| | 0475118 | | platina mat | 2778997006 | stuk | 1073,30 | 172 | 1 |
| Badkamermeubelen en toiletkasten | inbouwzeepdispenser m. rozet | | | | | | | |
| | 0475119 | | chroom | 8243697000 | stuk | 163,40 | 172 | 1 |
| Gootstenen en wastroggen | 0475120 | | platina mat | 8243697006 | stuk | 245,30 | 172 | 1 |
| | inbouwzeepdispenser z. rozet | | | | | | | |
| Utiliteit | 0475121 | | chroom | 8242697000 | stuk | 150,00 | 172 | 1 |
| | 0475123 | | platina mat | 8242697006 | stuk | 225,10 | 172 | 1 |

| Art.nr | Specificaties | Kleur | Lev.nr | Ehd | Prijs | Grp | CC |
|--------|---------------|-------|--------|-----|-------|-----|----|
|--------|---------------|-------|--------|-----|-------|-----|----|

Gessi Energy

1-gats keukenkraan m. draaibare uitloop

| | | | | | | | |
|---------|--|--------|----------|------|--------|-----|---|
| 0460315 | | chroom | 16601031 | stuk | 282,00 | 169 | 1 |
| 0460316 | | inox | 16601142 | stuk | 380,00 | 169 | 1 |



Sanitair producten

Baden /
douchebakken /
stoomcabines**1-gats keukenkraan m. uittrekbare handdouche**

| | | | | | | | |
|---------|--|--------|----------|------|--------|-----|---|
| 0462707 | | chroom | 16607031 | stuk | 338,00 | 169 | 1 |
| 0462744 | | inox | 16607142 | stuk | 456,00 | 169 | 1 |



Kranen

Gessi Mania

keukenkraan

| | | | | | | | |
|---------|--|--------|----------|------|--------|-----|---|
| 0463914 | | chroom | 13121031 | stuk | 311,00 | 169 | 1 |
| 0463922 | | inox | 13121142 | stuk | 404,00 | 169 | 1 |



Douchegarnituur

Accessoires en
spiegels**keukenkraan m. uittrekbare handdouche**

| | | | | | | | |
|---------|--|--------|----------|------|--------|-----|---|
| 0463892 | | chroom | 13127031 | stuk | 348,00 | 169 | 1 |
| 0463906 | | inox | 13127142 | stuk | 453,00 | 169 | 1 |



Douchewanden

Toebehoren &
afvoeren

Gessi Oxygene

1-gats keukenkraan m. lange hendel

| | | | | | | | |
|---------|--|--------|----------|------|--------|-----|---|
| 0462712 | | chroom | 13152031 | stuk | 161,00 | 169 | 1 |
| 0460317 | | inox | 13152142 | stuk | 217,00 | 169 | 1 |

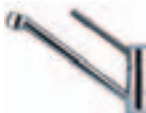
Spoel- &
installatiesystemen**1-gats keukenkraan m. draaibare uitloop 280mm boog**

| | | | | | | | |
|---------|--|--------|----------|------|--------|-----|---|
| 0464635 | | chroom | 13183031 | stuk | 198,00 | 169 | 1 |
| 0464775 | | inox | 13183142 | stuk | 267,00 | 169 | 1 |

Badkamermeubelen
en toiletkastenGootstenen en
wastroggen**1-gats keukenkraan m. draaibare uitloop 225mm hoekig**

| | | | | | | | |
|---------|--|--------|----------|------|--------|-----|---|
| 0464619 | | chroom | 13181031 | stuk | 198,00 | 169 | 1 |
| 0464767 | | inox | 13181142 | stuk | 267,00 | 169 | 1 |



Utiliteit

1-gats keukenkraan m. draaibare uitloop 296mm hoekig

| | | | | | | | |
|---------|--|------|----------|------|--------|-----|---|
| 0462745 | | inox | 13199142 | stuk | 283,00 | 169 | 1 |
|---------|--|------|----------|------|--------|-----|---|

**1-gats keukenkraan m. draaibare uitloop 199mm hoekig**

| | | | | | | | |
|---------|--|--------|----------|------|--------|-----|---|
| 0464600 | | chroom | 13161031 | stuk | 168,00 | 169 | 1 |
| 0464759 | | inox | 13161142 | stuk | 227,00 | 169 | 1 |



| Art.nr | Specificaties | Kleur | Lev.nr | Ehd | Prijs | Grp | CC |
|--------|---------------|-------|--------|-----|-------|-----|----|
|--------|---------------|-------|--------|-----|-------|-----|----|

Gessi Oxygene

1-gats keukenkraan m. draaibare uitloop 197mm boog

| | | | | | | | |
|---------|--|--------|----------|------|--------|-----|---|
| 0464465 | | chroom | 13163031 | stuk | 168,00 | 169 | 1 |
| 0464511 | | inox | 13163142 | stuk | 227,00 | 169 | 1 |



Sanitair producten

Baden /
douchebakken /
stoomcabines

Kranen

keukenkraan m. uittrekbare handdouche (2 standen) m. korte hendel

| | | | | | | | |
|---------|--|--------|----------|------|--------|-----|---|
| 0463185 | | chroom | 13157031 | stuk | 236,00 | 169 | 1 |
| 0460325 | | inox | 13157142 | stuk | 317,00 | 169 | 1 |



Douchegarnituur

Accessoires en
spiegels

keukenkraan m. uittrekbare handdouche (2 standen) m. lange hendel

| | | | | | | | |
|---------|--|--------|----------|------|--------|-----|---|
| 0463186 | | chroom | 13158031 | stuk | 236,00 | 169 | 1 |
| 0460319 | | inox | 13158142 | stuk | 317,00 | 169 | 1 |



Douchewanden

Toebehoren &
afvoeren

losse douchekop voor 13158

| | | | | | | | |
|---------|--|--------|---------|------|-------|-----|---|
| 0460321 | | chroom | 1280031 | stuk | 41,00 | 169 | 1 |
| 0460322 | | inox | 1280142 | stuk | 48,25 | 169 | 1 |

keukenkraan m. uittrekbare handdouche m. korte hendel

| | | | | | | | |
|---------|--|--------|----------|------|--------|-----|---|
| 0463182 | | chroom | 13160031 | stuk | 216,00 | 169 | 1 |
| 0460323 | | inox | 13160142 | stuk | 294,00 | 169 | 1 |



Spoel- &
installatiesystemen

keukenkraan m. uittrekbare handdouche m. lange hendel

| | | | | | | | |
|---------|--|--------|----------|------|--------|-----|---|
| 0463184 | | chroom | 13162031 | stuk | 216,00 | 169 | 1 |
| 0460324 | | inox | 13162142 | stuk | 294,00 | 169 | 1 |



Badkamermeubelen
en toiletkasten

losse douchekop voor 13160-13162

| | | | | | | | |
|---------|--|--------|---------|------|-------|-----|---|
| 0460326 | | chroom | 1290031 | stuk | 23,75 | 169 | 1 |
| 0460327 | | inox | 1290032 | stuk | 29,75 | 169 | 1 |

keukenkraan m. uittrekbare handdouche (2 standen) m. hoge uitloop

| | | | | | | | |
|---------|--|--------|----------|------|--------|-----|---|
| 0463187 | | chroom | 13185031 | stuk | 281,00 | 169 | 1 |
| 0460320 | | inox | 13185142 | stuk | 378,00 | 169 | 1 |



Gootstenen en
wastroggen

Utiliteit

Gessi Oxygene Hi Tech

1-gats keukenkraan m. draaibare uitloop

| | | | | | | | |
|---------|--|--------|----------|------|--------|-----|---|
| 0464449 | | chroom | 13171031 | stuk | 276,00 | 169 | 1 |
| 0464481 | | inox | 13171142 | stuk | 374,00 | 169 | 1 |



1-gats keukenkraan m. draaibare uitloop m. verlengde hendel

| | | | | | | | |
|---------|--|--------|----------|------|--------|-----|---|
| 0464570 | | chroom | 13173031 | stuk | 276,00 | 169 | 0 |
| 0464724 | | inox | 13173142 | stuk | 374,00 | 169 | 0 |



| Art.nr | Specificaties | Kleur | Lev.nr | Ehd | Prijs | Grp | CC |
|--------|---------------|-------|--------|-----|-------|-----|----|
|--------|---------------|-------|--------|-----|-------|-----|----|

Gessi Oxygene Hi Tech

1-gats keukenkraan m. flexibele uitloop

| | | | | | | | |
|---------|--|--------|--------|------|--------|-----|---|
| 0462714 | | chroom | 908031 | stuk | 301,00 | 169 | 1 |
| 0462746 | | inox | 908142 | stuk | 391,00 | 169 | 1 |



Sanitair producten

Baden /
douchebakken /
stoomcabines**1-gats keukenkraan hoog m. flexibele uitloop**

| | | | | | | | |
|---------|--|--------|--------|------|--------|-----|---|
| 0460330 | | chroom | 909031 | stuk | 379,00 | 169 | 1 |
| 0460331 | | inox | 909142 | stuk | 493,00 | 169 | 1 |

1-gats keukenkraan hoogte=949mm m. handdouche

| | | | | | | | |
|---------|--|--------|--------|------|--------|-----|---|
| 0464643 | | chroom | 903031 | stuk | 725,00 | 169 | 1 |
| 0464783 | | inox | 903142 | stuk | 943,00 | 169 | 1 |



Kranen

Douchegarnituur

1-gats keukenkraan m. dubbele uitloop

| | | | | | | | |
|---------|--|--------|--------|------|--------|-----|---|
| 0462715 | | chroom | 902031 | stuk | 355,00 | 169 | 1 |
| 0460328 | | inox | 902142 | stuk | 479,00 | 169 | 1 |

Accessoires en
spiegels

Douchewanden

1-gats keukenkraan m. draaibare uitloop joystick

| | | | | | | | |
|---------|--|--------|----------|------|--------|-----|---|
| 0464457 | | chroom | 12197031 | stuk | 262,00 | 169 | 1 |
| 0464503 | | inox | 12197142 | stuk | 357,00 | 169 | 1 |

Toebehoren &
afvoerenSpoel- &
installatiesystemen**wandkraan m. draaibare uitloop**

| | | | | | | | |
|---------|--|--------|----------|------|--------|-----|---|
| 0462716 | | chroom | 13175031 | stuk | 321,00 | 169 | 1 |
| 0460329 | | inox | 13175142 | stuk | 432,00 | 169 | 1 |

Badkamermeubelen
en toiletkasten**2-gats keukenkraan m. uittrekbare uitloop**

| | | | | | | | |
|---------|--|--------|----------|------|--------|-----|---|
| 0460332 | | chroom | 13196031 | stuk | 308,00 | 169 | 1 |
| 0460333 | | inox | 13196142 | stuk | 400,00 | 169 | 1 |

Gootstenen en
wastroggen

Gessi Ozone

1-gats keukenkraan m. draaibare uitloop

| | | | | | | | |
|---------|--|--------|----------|------|--------|-----|---|
| 0462717 | | chroom | 15251031 | stuk | 279,00 | 169 | 1 |
| 0462749 | | inox | 15251142 | stuk | 363,00 | 169 | 1 |



Utiliteit

1-gats keukenkraan m. uittrekbare handdouche

| | | | | | | | |
|---------|--|--------|----------|------|--------|-----|---|
| 0462706 | | chroom | 15257031 | stuk | 351,00 | 169 | 1 |
| 0462750 | | inox | 15257142 | stuk | 456,00 | 169 | 1 |





Gessi Particolare Soft

1-gats keukenkraan 1-greeps m. hoge draaibare uitloop

| | | | | | | | |
|---------|--|--------|--------|------|--------|-----|---|
| 0461334 | | chroom | 626031 | stuk | 205,00 | 169 | 1 |
|---------|--|--------|--------|------|--------|-----|---|



| | Art.nr | Specificaties | Kleur | Lev.nr | Ehd | Prijs | Grp | CC | |
|--|---|---|--------|----------|----------|--------|--------|-----|---|
| Sanitair producten | Gessi Particolare Soft | | | | | | | | |
| |  | keukenkraan m. hoge gebogen uitloop | | | | | | | |
| 0463189 | | | chroom | 623031 | stuk | 203,00 | 169 | 1 | |
| Baden / douchebakken / stoomcabines | | | | | | | | | |
| Kranen | Gessi Particolare Antica | | | | | | | | |
| |  | 1-gats keukenkraan 1-greeps | | | | | | | |
| | | 0461369 | | chroom | 8744031 | stuk | 275,00 | 169 | 0 |
| 0462777 | | | brons | 8744140 | stuk | 357,00 | 169 | 1 | |
| Douchegarnituur | | | | | | | | | |
| Accessoires en spiegels | 1-gats keukenkraan m. handdouche | | | | | | | | |
| |  | 0464686 | | chroom | 8752031 | stuk | 338,00 | 169 | 1 |
| | | 0464813 | | inox | 8752142 | stuk | 447,00 | 169 | 1 |
| 0462778 | | | brons | 8752140 | stuk | 447,00 | 169 | 1 | |
| Douchewanden | | | | | | | | | |
| Toebehoren & afvoeren | Gessi P.Cingolo | | | | | | | | |
| |  | 1-gats keukenkraan m. vierkante buisuitloop 20cm | | | | | | | |
| | | 0462718 | | chroom | 17245031 | stuk | 365,00 | 169 | 1 |
| 0462771 | | | inox | 17245142 | stuk | 474,00 | 169 | 1 | |
| Spoel- & installatiesystemen | | | | | | | | | |
| Badkamermeubelen en toiletkasten | 1-gats keukenkraan m. vierkante buisuitloop 22.7cm | | | | | | | | |
| |  | 0462719 | | chroom | 17247031 | stuk | 365,00 | 169 | 1 |
| | | 0462773 | | inox | 17247142 | stuk | 474,00 | 169 | 1 |
| | | | | | | | | | |
| Gootstenen en wastroggen | 1-gats wandkraan m. ronde buisuitloop 27.6cm | | | | | | | | |
| |  | 0462720 | | chroom | 17303031 | stuk | 365,00 | 169 | 1 |
| | | 0462774 | | inox | 17303142 | stuk | 474,00 | 169 | 1 |
| | | | | | | | | | |
| Utiliteit | 1-gats wandkraan m. vierkante buisuitloop 28.7cm | | | | | | | | |
| |  | 0462722 | | chroom | 17323031 | stuk | 418,00 | 169 | 1 |
| | | 0462775 | | inox | 17323142 | stuk | 543,00 | 169 | 1 |
| | | | | | | | | | |
| | 1-gats wandkraan m. ronde buisuitloop 31.7cm | | | | | | | | |
| |  | 0462723 | | chroom | 17343031 | stuk | 460,00 | 169 | 1 |
| | | 0462776 | | inox | 17343142 | stuk | 598,00 | 169 | 1 |
| | | | | | | | | | |
| | Gessi P.Godronato | | | | | | | | |
| |  | 1-gats keukenkraan m. ronde buisuitloop 19cm | | | | | | | |
| | | 0462724 | | chroom | 17221031 | stuk | 301,00 | 169 | 1 |
| 0462751 | | | inox | 17221142 | stuk | 391,00 | 169 | 1 | |
| | | | | | | | | | |
| 1-gats keukenkraan m. ronde uitloop | | | | | | | | | |
| | 0460334 | | chroom | 17223031 | stuk | 301,00 | 169 | 1 | |
| | 0460335 | | inox | 17223142 | stuk | 391,00 | 169 | 1 | |

| Art.nr | Specificaties | Kleur | Lev.nr | Ehd | Prijs | Grp | CC |
|--------|---------------|-------|--------|-----|-------|-----|----|
|--------|---------------|-------|--------|-----|-------|-----|----|

Gessi P.Godronato

1-gats keukenkraan m. vierkante buisuitloop 20cm

| | | | | | | | |
|---------|--|--------|----------|------|--------|-----|---|
| 0462725 | | chroom | 17225031 | stuk | 365,00 | 169 | 1 |
| 0462752 | | inox | 17225142 | stuk | 474,00 | 169 | 1 |



Sanitair producten

Baden /
douchebakken /
stoomcabines**1-gats keukenkraan m. vierkante buisuitloop 22.8cm**

| | | | | | | | |
|---------|--|--------|----------|------|--------|-----|---|
| 0462726 | | chroom | 17227031 | stuk | 365,00 | 169 | 1 |
| 0462753 | | inox | 17227142 | stuk | 474,00 | 169 | 1 |



Kranen

Douchegarnituur

1-gats wandkraan m. ronde buisuitloop 27.6cm

| | | | | | | | |
|---------|--|--------|----------|------|--------|-----|---|
| 0462727 | | chroom | 17301031 | stuk | 365,00 | 169 | 1 |
| 0462754 | | inox | 17301142 | stuk | 474,00 | 169 | 1 |

Accessoires en
spiegels**1-gats wandkraan m. ronde uitloop**

| | | | | | | | |
|---------|--|--------|----------|------|--------|-----|---|
| 0460336 | | chroom | 17321031 | stuk | 418,00 | 169 | 1 |
| 0460337 | | inox | 17321142 | stuk | 543,00 | 169 | 1 |

1-gats wandkraan m. vierkante buisuitloop 31.5cm

| | | | | | | | |
|---------|--|--------|----------|------|--------|-----|---|
| 0462728 | | chroom | 17341031 | stuk | 460,00 | 169 | 1 |
| 0462755 | | inox | 17341142 | stuk | 598,00 | 169 | 1 |



Douchewanden

Toebehoren &
afvoeren

Gessi P.Quadro

1-gats keukenkraan m. ronde buisuitloop 20cm

| | | | | | | | |
|---------|--|--------|----------|------|--------|-----|---|
| 0462729 | | chroom | 17201031 | stuk | 352,00 | 169 | 1 |
| 0462757 | | inox | 17201142 | stuk | 457,00 | 169 | 1 |

Spoel- &
installatiesystemenBadkamermeubelen
en toiletkasten**1-gats keukenkraan m. vierkante buisuitloop 20cm**

| | | | | | | | |
|---------|--|--------|----------|------|--------|-----|---|
| 0462730 | | chroom | 17205031 | stuk | 416,00 | 169 | 1 |
| 0462758 | | inox | 17205142 | stuk | 540,00 | 169 | 1 |

Gootstenen en
wastroggen**1-gats wandkraan m. ronde buisuitloop 27.6cm**

| | | | | | | | |
|---------|--|--------|----------|------|--------|-----|---|
| 0462731 | | chroom | 17305031 | stuk | 433,00 | 169 | 1 |
| 0462759 | | inox | 17305142 | stuk | 563,00 | 169 | 1 |



Utiliteit

1-gats wandkraan m. vierkante buisuitloop 28.7cm

| | | | | | | | |
|---------|--|--------|----------|------|--------|-----|---|
| 0462732 | | chroom | 17325031 | stuk | 486,00 | 169 | 1 |
| 0462760 | | inox | 17325142 | stuk | 632,00 | 169 | 1 |

**1-gats keukenkraan m. ronde uitloop**

| | | | | | | | |
|---------|--|--------|----------|------|--------|-----|---|
| 0460338 | | chroom | 17203031 | stuk | 352,00 | 169 | 1 |
| 0460339 | | inox | 17203142 | stuk | 457,00 | 169 | 1 |

1-gats keukenkraan m. gebogen uitloop

| | | | | | | | |
|---------|--|--------|----------|------|--------|-----|---|
| 0460341 | | inox | 17207142 | stuk | 540,00 | 169 | 1 |
| 0460340 | | chroom | 17207031 | stuk | 416,00 | 169 | 1 |

| Art.nr | Specificaties | Kleur | Lev.nr | Ehd | Prijs | Grp | CC |
|--------|---------------|-------|--------|-----|-------|-----|----|
|--------|---------------|-------|--------|-----|-------|-----|----|

Gessi Quadro

1-gats keukenkraan m. ronde buisuitloop

| | | | | | | | |
|---------|--|--------|----------|------|--------|-----|---|
| 0462735 | | chroom | 16753031 | stuk | 327,00 | 169 | 1 |
| 0462763 | | inox | 16753142 | stuk | 425,00 | 169 | 1 |
| 0462739 | | chroom | 16757031 | stuk | 309,00 | 169 | 1 |
| 0462765 | | inox | 16757142 | stuk | 402,00 | 169 | 1 |



1-gats keukenkraan m. ronde U buisuitloop

| | | | | | | | |
|---------|--|--------|----------|------|--------|-----|---|
| 0462736 | | chroom | 16783031 | stuk | 327,00 | 169 | 1 |
| 0462766 | | inox | 16783142 | stuk | 425,00 | 169 | 1 |
| 0462740 | | chroom | 16785031 | stuk | 309,00 | 169 | 1 |
| 0462767 | | inox | 16785142 | stuk | 402,00 | 169 | 1 |



1-gats keukenkraan m. vierkante buisuitloop

| | | | | | | | |
|---------|--|--------|----------|------|--------|-----|---|
| 0462737 | | chroom | 16769031 | stuk | 440,00 | 169 | 1 |
| 0462768 | | inox | 16769142 | stuk | 571,00 | 169 | 1 |
| 0462738 | | chroom | 16787031 | stuk | 440,00 | 169 | 1 |
| 0462769 | | inox | 16787142 | stuk | 571,00 | 169 | 1 |



1-gats keukenkraan m. draaibare uitloop

| | | | | | | | |
|---------|--|--------|----------|------|--------|-----|---|
| 0461304 | | chroom | 16751031 | stuk | 320,00 | 169 | 1 |
| 0461305 | | inox | 16751142 | stuk | 416,00 | 169 | 1 |



1-gats keukenkraan m. hoge draaibare uitloop

| | | | | | | | |
|---------|--|--------|----------|------|--------|-----|---|
| 0460354 | | chroom | 16759031 | stuk | 302,00 | 169 | 1 |
| 0460355 | | inox | 16759142 | stuk | 393,00 | 169 | 1 |
| 0460356 | | chroom | 16773031 | stuk | 422,00 | 169 | 1 |
| 0460357 | | inox | 16773142 | stuk | 549,00 | 169 | 1 |



| Art.nr | Specificaties | Kleur | Lev.nr | Ehd | Prijs | Grp | CC |
|--------|---------------|-------|--------|-----|-------|-----|----|
|--------|---------------|-------|--------|-----|-------|-----|----|

Gessi Quadro

1-gats keukenkraan m. draaibare uitloop

| | | | | | | | |
|---------|--|--------|----------|------|--------|-----|---|
| 0460358 | | chroom | 16789031 | stuk | 422,00 | 169 | 1 |
| 0460359 | | inox | 16789142 | stuk | 549,00 | 169 | 1 |
| 0460360 | | chroom | 16721031 | stuk | 463,00 | 169 | 1 |
| 0460361 | | inox | 16721032 | stuk | 602,00 | 169 | 1 |



Sanitair producten

Baden /
douchebakken /
stoomcabines

Kranen

1-gats keukenkraan m. hendel rechts

| | | | | | | | |
|---------|--|--------|----------|------|--------|-----|---|
| 0460362 | | chroom | 16775031 | stuk | 414,00 | 169 | 1 |
| 0460363 | | inox | 16775142 | stuk | 538,00 | 169 | 1 |



Douchegarnituur

Accessoires en
spiegels

Gessi Quadro HiTech

1-gats keukenkraan staand 120cm

| | | | | | | | |
|---------|--|--------|----------|------|---------|-----|---|
| 0462742 | | chroom | 16781031 | stuk | 906,00 | 169 | 1 |
| 0462761 | | inox | 16781142 | stuk | 1178,00 | 169 | 1 |



Douchewanden

Toebehoren &
afvoeren**1-gats keukenkraan m. uittrekbare handdouche**

| | | | | | | | |
|---------|--|--------|----------|------|--------|-----|---|
| 0462741 | | chroom | 16771031 | stuk | 466,00 | 169 | 1 |
| 0462762 | | inox | 16771142 | stuk | 605,00 | 169 | 1 |

Spoel- &
installatiesystemenBadkamermeubelen
en toiletkasten**2-gats keukenkraan m. vierkante buisuitloop**

| | | | | | | | |
|---------|--|--------|----------|------|--------|-----|---|
| 0462734 | | chroom | 17457031 | stuk | 368,00 | 169 | 1 |
| 0460352 | | inox | 17457142 | stuk | 479,00 | 169 | 1 |

Gootstenen en
wastroggen**2-gats keukenkraan m. flexibele buisuitloop**

| | | | | | | | |
|---------|--|--------|----------|------|--------|-----|---|
| 0462733 | | chroom | 17459031 | stuk | 343,00 | 169 | 1 |
| 0460353 | | inox | 17459142 | stuk | 445,00 | 169 | 1 |



Utiliteit

1-gats keukenkraan geheel draaibaar m. vierkante buisuitloop

| | | | | | | | |
|---------|--|--------|----------|------|--------|-----|---|
| 0461306 | | chroom | 16715031 | stuk | 407,00 | 169 | 1 |
| 0461307 | | inox | 16715142 | stuk | 529,00 | 169 | 1 |

**1-gats keukenkraan m. draaibare uitloop**

| | | | | | | | |
|---------|--|--------|----------|------|--------|-----|---|
| 0460342 | | chroom | 16701031 | stuk | 387,00 | 169 | 1 |
| 0460343 | | inox | 16701142 | stuk | 503,00 | 169 | 1 |



| Art.nr | Specificaties | Kleur | Lev.nr | Ehd | Prijs | Grp | CC |
|--------|---------------|-------|--------|-----|-------|-----|----|
|--------|---------------|-------|--------|-----|-------|-----|----|

Gessi Quadro HiTech

1-gats keukenkraan m. flexibele uitloop

| | | | | | | | |
|---------|--|--------|----------|------|--------|-----|---|
| 0460344 | | chroom | 16763031 | stuk | 399,00 | 169 | 1 |
| 0460345 | | inox | 16763142 | stuk | 520,00 | 169 | 1 |
| 0460346 | | chroom | 16777031 | stuk | 382,00 | 169 | 1 |
| 0460347 | | inox | 16777142 | stuk | 496,00 | 169 | 1 |



1-gats keukenkraan m. flexibele uittrekbare uitloop

| | | | | | | | |
|---------|--|--------|----------|------|--------|-----|---|
| 0460348 | | chroom | 16765031 | stuk | 492,00 | 169 | 1 |
| 0460349 | | inox | 16765142 | stuk | 640,00 | 169 | 1 |



1-gats semi-prof. keukenkraan

| | | | | | | | |
|---------|--|--------|----------|------|---------|-----|---|
| 0460350 | | chroom | 16791031 | stuk | 1003,00 | 169 | 1 |
| 0460351 | | inox | 16791142 | stuk | 1254,00 | 169 | 1 |



Gessi Ritrovata

1-gats keukenkraan 2-greeps

| | | | | | | | |
|---------|--|--------|---------|------|--------|-----|---|
| 0461350 | | chroom | 8201031 | stuk | 254,00 | 169 | 0 |
| 0461352 | | brons | 8201140 | stuk | 314,00 | 169 | 0 |



wandkraan m. draaibare onderuitloop

| | | | | | | | |
|---------|--|--------|---------|------|--------|-----|---|
| 0461881 | | chroom | 4207031 | stuk | 195,00 | 169 | 1 |
| 0461903 | | brons | 4207140 | stuk | 356,00 | 169 | 1 |



1-gats keukenkraan m. draaibare uitloop

| | | | | | | | |
|---------|--|--------|---------|------|--------|-----|---|
| 0461357 | | chroom | 4201031 | stuk | 165,00 | 169 | 1 |
| 0461354 | | brons | 4201140 | stuk | 284,00 | 169 | 1 |



wandkraan m. draaibare bovenuitloop

| | | | | | | | |
|---------|--|--------|---------|------|--------|-----|---|
| 0461865 | | chroom | 8207031 | stuk | 252,00 | 169 | 1 |
| 0461873 | | brons | 8207140 | stuk | 361,00 | 169 | 1 |



1-gats keukenkraan 2-greeps m. draaibare uitloop boog

| | | | | | | | |
|---------|--|--------|--------|------|--------|-----|---|
| 0464627 | | chroom | 584031 | stuk | 166,00 | 169 | 1 |
|---------|--|--------|--------|------|--------|-----|---|



| Art.nr | Specificaties | Kleur | Lev.nr | Ehd | Prijs | Grp | CC |
|---------------------------|---------------|--------|----------|------|--------|-----|-------------------------|
| | | | | | | | Gessi Rettangolo |
| 1-gats keukenkraan | | | | | | | |
| 0462743 | | chroom | 16767031 | stuk | 414,00 | 169 | 0 |
| 0462770 | | inox | 16767142 | stuk | 538,00 | 169 | 1 |



Sanitair producten

Baden /
douchebakken /
stoomcabines**Kranen**







Douchegarnituur

Accessoires en
spiegels

Douchewanden







Toebehoren &
afvoerenSpoel- &
installatiesystemenBadkamermeubelen
en toiletkastenGootstenen en
wastroggen





Utiliteit







| | Art.nr | Specificaties | Kleur | Lev.nr | Ehd | Prijs | Grp | CC |
|---|---|---|-------|----------|------|--------|-----|----|
| Sanitair producten | Grohe Alira | | | | | | | |
| | | 1-gats keukenkraan m. draaibare uitloop 0443646 | RVS | 32997SD0 | stuk | 433,00 | 162 | 0 |
| | | 1-gats keukenkraan m. uittrekbare uitloop 0443654 | RVS | 32998SD0 | stuk | 498,00 | 162 | 1 |
| Baden / douchebakken / stoomcabines | Grohe Atlanta | | | | | | | |
| |  | 1-gats keukenkraan m. hoge uitloop 0435813 | chrom | 31764000 | stuk | 102,00 | 210 | 0 |
| Kranen | | 1-gats keukenkraan m. kettingoog m. hoge uitloop 0435821 | chrom | 31774000 | stuk | 100,00 | 210 | 1 |
| Douchegarnituur |  | | | | | | | |
| Accessoires en spiegels | | 1-gats keukenkraan keramisch m. draaibare uitloop 0435872 | chrom | 31826000 | stuk | 129,00 | 210 | 0 |
| Douchewanden |  | | | | | | | |
| Toebehoren & afvoeren | Grohe Atrio | | | | | | | |
| |  | 1-gats keukenkraan 0464996 | chrom | 31000000 | stuk | 323,00 | 162 | 0 |
| Spoel- & installatiesystemen | | 1-greeps keukenkraan 0450493 | chrom | 32003000 | stuk | 420,00 | 163 | 1 |
| Badkamermeubelen en toiletkasten | | | | | | | | |
| Gootstenen en wastroggen | Grohe Costa | | | | | | | |
| |  | 1-gats keukenkraan m. hoge uitloop 0432652 | chrom | 31831000 | stuk | 56,50 | 163 | 0 |
| Utiliteit | | keukenkraan 1/2" z. koppelingen m. onderuitloop 0432636 | chrom | 31182000 | stuk | 59,50 | 163 | 0 |
| |  | | | | | | | |
| | | keukenkraan 1/2" z. koppelingen m. bovenuitloop 0432644 | chrom | 31186000 | stuk | 59,50 | 163 | 0 |
| |  | | | | | | | |







| Art.nr | Specificaties | Kleur | Lev.nr | Ehd | Prijs | Grp | CC | | |
|--|---------------|--------|----------|------|--------|-----|----|---|---|
| | | | | | | | | Grohe Essence | |
| 1-gats keukenkraan m. draaibare uitloop | | | | | | | | | |
| 0442468 | | chroom | 32105000 | stuk | 314,00 | 162 | 0 |  | Sanitair producten |
| 0442469 | | steel | 32105DC0 | stuk | 502,00 | 162 | 1 | | |
| 1-gats keukenkraan m. uittrekbare uitloop | | | | | | | | | |
| 0442470 | | chroom | 32171000 | stuk | 350,00 | 162 | 0 |  | Baden / douchebakken / stoomcabines |
| 0442471 | | steel | 32171DC0 | stuk | 560,00 | 162 | 1 | | |
| | | | | | | | | Grohe Eurodisc | |
| 1-gats keukenkraan m. draaibare uitloop | | | | | | | | | |
| 0433256 | | chroom | 33770000 | stuk | 165,00 | 163 | 0 |  | Douchegarnituur |
| | | | | | | | | Grohe Euroeco | |
| 1-gats keukenkraan 120mm m. hendel m. draaibare uitloop | | | | | | | | | |
| 0439045 | | chroom | 33912000 | stuk | 179,00 | 215 | 1 |  | Accessoires en spiegels |
| 1-gats keukenkraan m. hoge draaibare uitloop | | | | | | | | | |
| 0438899 | | chroom | 33898000 | stuk | 159,00 | 163 | 1 |  | Douchewanden |
| 1-gats keukenkraan laminaar | | | | | | | | | |
| 0439821 | | chroom | 33989000 | stuk | 175,00 | 210 | 1 |  | Toebehoren & afvoeren |
| | | | | | | | | Grohe Europlus | |
| 1-gats keukenkraan m. draaibare uitloop | | | | | | | | | |
| 0441465 | | chroom | 33930000 | stuk | 316,00 | 162 | 0 |  | Spoel- & installatiesystemen |
| 1-gats keukenkraan m. uittrekbare handdouche | | | | | | | | | |
| 0441503 | | chroom | 33933000 | stuk | 397,00 | 162 | 0 |  | Badkamermeubelen en toiletkasten |
| | | | | | | | | Grohe Eurosmart | |
| 1-gats keukenkraan m. draaibare uitloop | | | | | | | | | |
| 0430960 | | chroom | 33281000 | stuk | 98,50 | 210 | 0 |  | Gootstenen en wastroggen |
| | | | | | | | | Grohe Eurostyle | |
| 1-gats keukenkraan m. lage uitloop | | | | | | | | | |
| 0441635 | | chroom | 32989000 | stuk | 110,00 | 163 | 0 |  | Utiliteit |



| | Art.nr | Specificaties | Kleur | Lev.nr | Ehd | Prijs | Grp | CC | |
|---|---|--|----------|----------|----------|-------|--------|-----|---|
| Sanitair producten | Grohe Eurostyle | | | | | | | | |
| |  | 1-gats keukenkraan m. hoge uitloop | | chrom | 33975000 | stuk | 114,00 | 162 | 0 |
| 0410042 | | | | | | | | | |
| Baden / douchebakken / stoomcabines | | | | | | | | | |
| Kranen | Grohe Minta | | | | | | | | |
| |  | 1-gats keukenkraan | | chrom | 32917000 | stuk | 230,00 | 162 | 0 |
| 0442461 | | | | | | | | | |
| Douchegarnituur |  | 0102509 | | RVS look | 32917DC0 | stuk | 367,00 | 162 | 1 |
| | | | | | | | | | |
| Accessoires en spiegels | 1-gats keukenkraan m. uittrekbare mousseur | | | | | | | | |
| |  | 0442488 | | chrom | 32918000 | stuk | 255,00 | 162 | 0 |
| 0102510 | | RVS look | 32918DC0 | stuk | 407,00 | 162 | 1 | | |
| Douchewanden | keukenkraan m. U-uitloop | | | | | | | | |
| |  | 0410059 | | chrom | 32488000 | stuk | 248,00 | 162 | 0 |
| 0102511 | | RVS look | 32488DC0 | stuk | 397,00 | 162 | 1 | | |
| Toebehoren & afvoeren | | | | | | | | | |
| Spoel- & installatiesystemen | 1-gats keukenkraan m. uittrekbare uitloop m. L-uitloop | | | | | | | | |
| |  | 0442462 | | chrom | 32168000 | stuk | 297,00 | 162 | 0 |
| 0442463 | | steel | 32168DC0 | stuk | 477,00 | 162 | 1 | | |
| Badkamermeubelen en toiletkasten | | | | | | | | | |
| Gootstenen en wastroggen | 1-gats keukenkraan m. uittrekbare uitloop m. ronde uitloop | | | | | | | | |
| |  | 0442464 | | chrom | 32321000 | stuk | 299,00 | 162 | 1 |
| 0442465 | | steel | 32321DC0 | stuk | 477,00 | 162 | 1 | | |
| Utiliteit | 1-gats keukenkraan m. uittrekbare uitloop m. U-uitloop | | | | | | | | |
| |  | 0442466 | | chrom | 32322000 | stuk | 322,00 | 162 | 1 |
| 0442467 | | steel | 32322DC0 | stuk | 516,00 | 162 | 1 | | |
| | | | | | | | | | |
| | Grohe Sentosa | | | | | | | | |
| |  | 1-gats keukenkraan m. draaibare uitloop | | chrom | 31403000 | stuk | 216,00 | 162 | 0 |
| 0438820 | | | | | | | | | |
| | | | | | | | | | |
| | Grohe Supra | | | | | | | | |
| |  | 1-gats keukenkraan m. draaibare gegoten uitloop | | chrom | 31426000 | stuk | 210,00 | 163 | 0 |
| 0442550 | | | | | | | | | |

| Art.nr | Specificaties | Kleur | Lev.nr | Ehd | Prijs | Grp | CC | |
|--|---------------|--------|----------|------|--------|-----|----|---|
| Grohe Supra | | | | | | | | |
| 1-gats keukenkraan m. hoge uitloop 0436569 | | chroom | 31832000 | stuk | 78,00 | 163 | 0 |  |
| Sanitair producten | | | | | | | | |
| Baden / douchebakken / stoomcabines | | | | | | | | |
| 1-gats keukenkraan m. zware draaibare buis uitloop 0438928 | | chroom | 31424000 | stuk | 189,00 | 163 | 0 |  |
| Kranen | | | | | | | | |
| wandkraan z. koppelingen m. onderuitloop 0436577 | | chroom | 31195000 | stuk | 81,00 | 163 | 0 |  |
| Douchegarnituur | | | | | | | | |
| Accessoires en spiegels | | | | | | | | |
| wandkraan m. bovenuitloop m. perlator 0436578 | | chroom | 31197000 | stuk | 81,00 | 163 | 1 | |
| Douchewanden | | | | | | | | |
| Grohe Zedra | | | | | | | | |
| 1-gats keukenkraan m. uittrekbare mousseur 0439215 | | chroom | 33708000 | stuk | 350,00 | 210 | 0 |  |
| 0439216 | | RVS | 33764SD0 | stuk | 473,00 | 210 | 0 | |
| Toebehoren & afvoeren | | | | | | | | |
| Spoel- & installatiesystemen | | | | | | | | |
| Badkamermeubelen en toiletkasten | | | | | | | | |
| 1-gats keukenkraan m. uittrekbare handdouche 0439207 | | chroom | 33707000 | stuk | 389,00 | 210 | 0 |  |
| Gootstenen en wastroggen | | | | | | | | |
| keukenkraan m. uittrekbare handdouche 0106293 | | chroom | 33727000 | stuk | 467,00 | 210 | 1 | |
| Utiliteit | | | | | | | | |
| keukenkraan m. vuistdouche 0102506 | | chroom | 32462000 | stuk | 389,00 | 210 | 1 |  |

| | Art.nr | Specificaties | Kleur | Lev.nr | Ehd | Prijs | Grp | CC |
|---|--|---|-------|----------|------|--------|-----|----|
| Sanitair producten |  | Hansa Hansamix 1-gats keukenkraan 0394394 | chrom | 01142273 | stuk | 231,00 | 262 | 1 |
| Baden / douchebakken / stoomcabines |  | Hansa Hansanova 1-gats keukenkraan 0394564 | chrom | 03052106 | stuk | 155,00 | 262 | 1 |
| Kranen |  | Hansa Hansapolo 1-gats keukenkraan 0395471 | chrom | 51482203 | stuk | 85,50 | 262 | 0 |
| Douchegarnituur |  | Hansa Hansatwist 1-gats keukenkraan 0395517 | chrom | 52482203 | stuk | 164,00 | 262 | 1 |
| Accessoires en spiegels |  | Hansa Prado 1-gats keukenkraan 0394815 | chrom | 01482201 | stuk | 147,00 | 262 | 1 |
| Douchewanden | | | | | | | | |
| Toebehoren & afvoeren | | | | | | | | |
| Spoel- & installatiesystemen | | | | | | | | |
| Badkamermeubelen en toiletkasten | | | | | | | | |
| Gootstenen en wastroggen | | | | | | | | |
| Utiliteit | | | | | | | | |

| Art.nr | Specificaties | Kleur | Lev.nr | Ehd | Prijs | Grp | CC | | |
|--|---------------|----------------|----------|------|---------|-----|----|---|---|
| | | | | | | | | Hansgrohe Elegance | |
| 1-gats keukenkraan 0459003 | | chroom | 33810000 | stuk | 192,00 | 176 | 1 |  | Sanitair producten |
| | | | | | | | | Hansgrohe Focus E | |
| 1-gats keukenkraan m. draaibare uitloop 0450577 | | chroom | 31780000 | stuk | 89,00 | 176 | 1 | | Baden / douchebakken / stoomcabines |
| | | | | | | | | Hansgrohe Focus S | |
| 1-gats keukenkraan m. draaibare uitloop 0450578 | | chroom | 31786000 | stuk | 107,00 | 176 | 1 | | Kranen |
| | | | | | | | | Hansgrohe Metropol | |
| 1-gats keukenkraan 0457809 | | chroom | 14830000 | stuk | 255,00 | 176 | 1 |  | Douchegarnituur |
| | | | | | | | | Hansgrohe Montreux | |
| 1-gats keukenkraan 1-greeps m. stopkraan 0450380 | | chroom | 14835000 | stuk | 335,00 | 176 | 1 | | Accessoires en spiegels |
| 1-gats keukenkraan m. uittrekbare handdouche 0457795 | | chroom | 14837000 | stuk | 319,00 | 176 | 1 |  | Douchewanden |
| 0454283 | | steel optik | 14837800 | stuk | 431,00 | 176 | 1 | | |
| | | | | | | | | Hansgrohe Montreux | |
| 1-gats keukenkraan 0450633 | | chroom | 16802000 | stuk | 444,00 | 176 | 1 |  | Toebehoren & afvoeren |
| 0450635 | | brushed nikkel | 16802820 | stuk | 679,00 | 176 | 1 | | |
| | | | | | | | | Hansgrohe Starck | |
| 2-gats keukenkraan brugmodel 0451235 | | chroom | 16803000 | stuk | 728,00 | 176 | 1 |  | Badkamermeubelen en toiletkasten |
| 0451236 | | brushed nikkel | 16803820 | stuk | 1114,00 | 176 | 1 | | |
| | | | | | | | | Hansgrohe Starck X | |
| 1-gats keukenkraan m. draaibare uitloop 0452807 | | chroom | 10800000 | stuk | 340,00 | 176 | 1 |  | Gootstenen en wastroggen |
| | | | | | | | | Hansgrohe Starck X | |
| Puro keukenkraan 1-greeps 0456764 | | chroom | 10801000 | stuk | 340,00 | 176 | 1 |  | Utiliteit |
| | | | | | | | | Hansgrohe Starck X | |
| keukenkraan 0450298 | | chroom | 10820000 | stuk | 783,00 | 176 | 1 |  | |

| | Art.nr | Specificaties | Kleur | Lev.nr | Ehd | Prijs | Grp | CC |
|---|---|--|-------------|----------|------|--------|-----|----|
| Sanitair producten | Hansgrohe Steel | | | | | | | |
| |  | 1-gats keukenkraan m. uittrekbare handdouche 0453210 | satijn/inox | 35807800 | stuk | 478,00 | 176 | 1 |
| Baden / douchebakken / stoomcabines | Hansgrohe Talis S | | | | | | | |
| | | 1-gats keukenkraan m. draaibare uitloop 0450576 | chroom | 32851000 | stuk | 166,00 | 176 | 1 |
| Kranen | | 1-gats keukenkraan m. uittrekbare handdouche 0450575 | chroom | 32841000 | stuk | 225,00 | 176 | 1 |
| | Douchegarnituur | Hansgrohe Uno | | | | | | |
|  | | 1-gats keukenkraan 0457787 | chroom | 14850000 | stuk | 288,00 | 176 | 0 |
| | | 0458996 | alux | 14850750 | stuk | 376,00 | 176 | 1 |
| Accessoires en spiegels | | 1-gats keukenkraan 1-greeps m. stopkraan 0450297 | chroom | 14855000 | stuk | 376,00 | 176 | 1 |
| Douchewanden |  | | | | | | | |
| Toebehoren & afvoeren | Hansgrohe Variarc | | | | | | | |
| |  | 1-greeps keukenkraan m. uitloop 18cm 0606820 | chroom | 14870000 | stuk | 204,00 | 176 | 0 |
| Spoel- & installatiesystemen | | 0606816 | alux | 14870750 | stuk | 256,00 | 176 | 1 |
| | | 0450105 | RVS | 14870800 | stuk | 309,00 | 176 | 1 |
| Badkamermeubelen en toiletkasten | | 1-greeps keukenkraan m. uittrekbare uitloop 0606806 | chroom | 14872000 | stuk | 284,00 | 176 | 1 |
| |  | 0606808 | alux | 14872750 | stuk | 374,00 | 176 | 1 |
| | | 0450107 | RVS | 14872800 | stuk | 424,00 | 176 | 1 |
| Gootstenen en wastroggen | | | | | | | | |
| Utiliteit |  | 1-greeps keukenkraan m. uittrekbare handdouche 0606810 | chroom | 14877000 | stuk | 335,00 | 176 | 1 |
| | | 0606814 | alux | 14877750 | stuk | 426,00 | 176 | 1 |
| | | 0450108 | RVS | 14877800 | stuk | 501,00 | 176 | 1 |
| | | 1-gats keukenkraan 1-greeps m. stopkraan 0450378 | chroom | 14875000 | stuk | 276,00 | 176 | 1 |
| | | 0450106 | RVS | 14875800 | stuk | 401,00 | 176 | 1 |
| | Hansgrohe Toebehoren | | | | | | | |
| | 0606839 | onderbouwdispenser | chroom | 40418000 | stuk | 81,00 | 176 | 1 |
| | 0450379 | onderbouwstopkraan | chroom | 16822000 | stuk | 105,00 | 176 | 1 |

| Art.nr | Specificaties | Kleur | Lev.nr | Ehd | Prijs | Grp | CC | |
|---|---------------|--------|---------|------|--------|-----|----|---|
| | | | | | | | | Ideal Standard Celia |
| keukenkraan 0180061 | | chroom | A3445AA | stuk | 311,00 | 179 | 1 |  |
| | | | | | | | | Ideal Standard Ceramix |
| 1-gats keukenkraan m. draaibare uitloop 0460990 | | chroom | B7617AA | stuk | 159,00 | 179 | 1 |  |
| | | | | | | | | Ideal Standard Cerasprint |
| 1-gats keukenkraan 0467112 | | chroom | B5344AA | stuk | 147,00 | 179 | 1 | |
| | | | | | | | | Ideal Standard Cleartap |
| keukenkraan m. waterfilteringssysteem m. koolstoffilter 0180060 | | chroom | A5051AA | stuk | 367,00 | 179 | 1 |  |

Sanitair producten

Baden /
douchebakken /
stoomcabines

Kranen

Douchegarnituur

Accessoires en
spiegels

Douchewanden

Toebehoren &
afvoeren

Spoel- &
installatiesystemen

Badkamermeubelen
en toiletkasten

Gootstenen en
wastroggen

Utiliteit

| | Art.nr | Specificaties | Kleur | Lev.nr | Ehd | Prijs | Grp | CC |
|---|--|--|--------|-----------|------|--------|-----|----|
| Sanitair producten | Jado Geometry | | | | | | | |
| | 1-gats keukenkraan m. booguitloop 20cm 1-greep | | | | | | | |
| | 0423390 | | chroom | F1274AA | stuk | 360,00 | 219 | 1 |
| | 0424447 | | steel | F1274XJ | stuk | 476,00 | 219 | 1 |
| Baden / douchebakken / stoomcabines | 1-gats keukenkraan m. haakse uitloop 20cm 1-greep | | | | | | | |
| | 0423964 | | chroom | F1279AA | stuk | 342,00 | 219 | 1 |
| | 0427354 | | steel | F1279XJ | stuk | 447,00 | 219 | 1 |
| Kranen | 1-gats keukenkraan m. booguitloop 2-greeps | | | | | | | |
| | 0424634 | | chroom | F1255AA | stuk | 294,00 | 219 | 1 |
| | 0424635 | | steel | F1255XJ | stuk | 392,00 | 219 | 1 |
| Douchegarnituur | 1-gats keukenkraan m. haakse uitloop 2-greeps | | | | | | | |
| | 0424544 | | chroom | F1258AA | stuk | 252,00 | 219 | 1 |
| | 0424552 | | steel | F1258XJ | stuk | 361,00 | 219 | 1 |
| Accessoires en spiegels | 1-gats keukenkraan m. uittrekbare handdouche 2-greeps | | | | | | | |
| | 0424978 | | chroom | F1259AA | stuk | 393,00 | 219 | 1 |
| | 0424980 | | steel | F1259XJ | stuk | 570,00 | 219 | 1 |
| Douchewanden | 1-gats keukenkraan m. draaibare uitloop | | | | | | | |
| | 0420010 | | chroom | F1287AA | stuk | 383,00 | 219 | 1 |
| | 0424637 | | RVS | F1287B4 | stuk | 468,00 | 219 | 1 |
| Toebehoren & afvoeren | 1-gats keukenkraan m. draaibare haakse uitloop | | | | | | | |
| | 0424625 | | chroom | F2505AA | stuk | 400,00 | 219 | 1 |
| Spoel- & installatiesystemen | 0440175 | Comfort hoekstopkraan m. rozet m. knop 3/8"x10mm | chroom | 050980699 | stuk | 6,50 | 210 | 0 |
| | 1-gats keukenkraan m. draaibare booguitloop | | | | | | | |
| Badkamermeubelen en toiletkasten | 0424633 | | chroom | F2506AA | stuk | 394,00 | 219 | 1 |
| | 0440175 | Comfort hoekstopkraan m. rozet m. knop 3/8"x10mm | chroom | 050980699 | stuk | 6,50 | 210 | 0 |
| Gootstenen en wastroggen | 1-gats keukenkraan | | | | | | | |
| | 0424638 | | chroom | F1291AA | stuk | 368,00 | 219 | 1 |
| Utiliteit | 1-gats keukenkraan m. draaibare haakse uitloop | | | | | | | |
| | 0424625 | | chroom | F2505AA | stuk | 400,00 | 219 | 1 |
| | 0440175 | Comfort hoekstopkraan m. rozet m. knop 3/8"x10mm | chroom | 050980699 | stuk | 6,50 | 210 | 0 |
| Utiliteit | 1-gats keukenkraan m. draaibare booguitloop | | | | | | | |
| | 0424633 | | chroom | F2506AA | stuk | 394,00 | 219 | 1 |
| | 0440175 | Comfort hoekstopkraan m. rozet m. knop 3/8"x10mm | chroom | 050980699 | stuk | 6,50 | 210 | 0 |
| Utiliteit | 1-gats keukenkraan | | | | | | | |
| | 0424638 | | chroom | F1291AA | stuk | 368,00 | 219 | 1 |

| Art.nr | Specificaties | Kleur | Lev.nr | Ehd | Prijs | Grp | CC |
|--|---------------|--------|---------|------|--------|-----|----|
| Jado Geometry | | | | | | | |
| wandkraan 24mm uitloop 23cm 0424647 | | chroom | F1341AA | stuk | 482,00 | 219 | 1 |
| wandkraan m. draaibare uitloop 0424648 | | chroom | F1342AA | stuk | 609,00 | 219 | 1 |
| 3-gats keukenkraan 0424657 | | chroom | F1265AA | stuk | 690,00 | 219 | 1 |
| 1-gats keukenkraan 0424660 | | chroom | F1686AA | stuk | 462,00 | 219 | 1 |

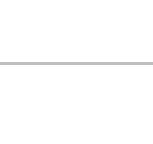

Sanitair producten

Baden /
douchebakken /
stoomcabines

Kranen















Douchegarnituur









Accessoires en
spiegels









Douchewanden

Toebehoren &
afvoerenSpoel- &
installatiesystemenBadkamermeubelen
en toiletkastenGootstenen en
wastroggen

Utiliteit

| | Art.nr | Specificaties | Kleur | Lev.nr | Ehd | Prijs | Grp | CC |
|---|---|---|-----------|-----------|------|--------|-----|----|
| Sanitair producten | Kludi Adlon | | | | | | | |
| | | 1-gats keukenkraan m. draaibare uitloop | | | | | | |
| | | 0402716 | chroom | 516060520 | stuk | 468,00 | 187 | 1 |
| | 0409065 | | chroom | 516080520 | stuk | 185,00 | 187 | 1 |
| Baden / douchebakken / stoomcabines |  | | | | | | | |
| |  | | | | | | | |
| Kranen |  | | | | | | | |
| Douchegarnituur | Kludi Almera | | | | | | | |
| | | 1-gats keukenkraan m. draaibare uitloop | | | | | | |
| | | 0407388 | chroom | 337840581 | stuk | 156,00 | 187 | 1 |
| | 0407389 | voor lage drukboiler | chroom | 337850581 | stuk | 191,00 | 187 | 1 |
| Accessoires en spiegels |  | | | | | | | |
| |  | | | | | | | |
| Douchewanden | | 1-gats keukenkraan m. uittrekbare handdouche | | | | | | |
| | | 0407390 | chroom | 337610581 | stuk | 223,00 | 187 | 1 |
| | | wandkraan m. onderuitloop | | | | | | |
| | 0407391 | | chroom | 337820581 | stuk | 167,00 | 187 | 1 |
| Toebehoren & afvoeren | Kludi Amphora | | | | | | | |
| | | 1-gats keukenkraan | | | | | | |
| | | 0400062 | chroom | 549040575 | stuk | 368,00 | 187 | 1 |
| | 0400110 | | chroom | 549410575 | stuk | 492,00 | 187 | 1 |
| Spoel- & installatiesystemen |  | | | | | | | |
| |  | | | | | | | |
| Badkamermeubelen en toiletkasten | Kludi Bingo-Tec | | | | | | | |
| | | keukenkraan m. draaibare uitloop | | | | | | |
| | | 0406627 | chroom | 425270532 | stuk | 170,00 | 187 | 1 |
| | 0409111 | | matchroom | 425270632 | stuk | 219,00 | 187 | 1 |
| Gootstenen en wastroggen |  | | | | | | | |
| |  | | | | | | | |
| Utiliteit | Kludi Bingo | | | | | | | |
| | | keukenkraan m. draaibare uitloop | | | | | | |
| | | 0406376 | chroom | 426270516 | stuk | 164,00 | 187 | 1 |
| | | Star 1-gats keukenkraan | | | | | | |
| | 0400063 | | chroom | 428030575 | stuk | 188,00 | 187 | 1 |
| |  | | | | | | | |
| |  | | | | | | | |
| |  | | | | | | | |
| |  | | | | | | | |
| | Kludi Komet | | | | | | | |
| | | 1-gats keukenkraan m. draaibare uitloop | | | | | | |
| | | 0409539 | chroom | 337940562 | stuk | 154,00 | 187 | 1 |
| |  | | | | | | | |
| |  | | | | | | | |

| Art.nr | Specificaties | Kleur | Lev.nr | Ehd | Prijs | Grp | CC | | |
|---|---------------|-----------|-----------|------|--------|-----|----|---|---|
| | | | | | | | | Kludi Komet | |
| 1-gats keukenkraan m. uittrekbare handdouche 0409536 | | chrom | 337910562 | stuk | 234,00 | 187 | 1 |  | Sanitair producten |
| 1-gats keukenkraan m. bajonetaansluiting 0409538 | | chrom | 337980562 | stuk | 232,00 | 188 | 1 |  | Baden / douchebakken / stoomcabines |
| | | | | | | | | Kludi Logomix | |
| 1-gats keukenkraan m. draaibare uitloop 0404197 | | chrom | 389130575 | stuk | 90,50 | 187 | 0 |  | Accessoires en spiegels |
| 1-gats keukenkraan voor lage druk boiler m. draaibare uitloop 0404209 | | chrom | 389190575 | stuk | 119,00 | 187 | 1 | | Douchegarnituur |
| wandkeukenkraan m. onderuitloop 0408336 | | chrom | 389240575 | stuk | 111,00 | 187 | 1 |  | Toebehoren & afvoeren |
| | | | | | | | | Kludi Medi-Mix | |
| wandkeukenkraan m. lange hendel 0409170 | | chrom | 331140564 | stuk | 195,00 | 187 | 1 |  | Badkamermeubelen en toiletkasten |
| | | | | | | | | Kludi Mix | |
| 1-gats keukenkraan m. draaibare uitloop 0406414 | | chrom | 339040562 | stuk | 200,00 | 187 | 0 |  | Gootstenen en wastroggen |
| 0409154 | | matchroom | 339040662 | stuk | 275,00 | 187 | 1 | | |
| 1-gats keukenkraan m. uittrekbare handdouche 0406406 | | chrom | 339010562 | stuk | 306,00 | 187 | 1 |  | Utiliteit |
| 1-gats keukenkraan m. draaibare uitloop 0403768 | | chrom | 339340562 | stuk | 292,00 | 187 | 1 |  | |

| | Art.nr | Specificaties | Kleur | Lev.nr | Ehd | Prijs | Grp | CC |
|---|---|---|--|-----------|-----------|--------|-------|-----|
| Sanitair producten | Kludi Newwaves | | | | | | | |
| |  | 1-gats keukenkraan swing & stop 0409189 | chrom | 579040575 | stuk | 375,00 | 187 | 1 |
| Baden / douchebakken / stoomcabines | Kludi Standaard-Optima | | | | | | | |
| Kranen |  | keukenkraan 1/2" m. onderuitloop 0407615 | chrom | 319530508 | stuk | 62,00 | 187 | 1 |
| | Douchegarnituur |  | keukenkraan 1/2" m. bovenuitloop 0407623 | chrom | 319550508 | stuk | 62,00 | 187 |
| Accessoires en spiegels |  | 1-gats keukenkraan 0407631 | chrom | 319760508 | stuk | 62,00 | 187 | 1 |
| Douchewanden | | Kludi Swingline | | | | | | |
| Toebehoren & afvoeren |  | 1-gats keukenkraan m. draaibare uittrekbare handdouche 0402613 | chrom | 318340514 | stuk | 316,00 | 187 | 1 |
| Spoel- & installatiesystemen |  | 1-gats keukenkraan m. gegoten draaibare uitloop 0402605 | chrom | 316270514 | stuk | 182,00 | 187 | 1 |
| Badkamermeubelen en toiletkasten | | Kludi Standaard Terralux | | | | | | |
| Gootstenen en wastroggen |  | 1-gats keukenkraan 200mm z. kettinghouder m. buisuitloop 0400483 | chrom | 316580508 | stuk | 64,00 | 188 | 1 |
| |  | 1-gats keukenkraan m. kettinghouder m. draaibare uitloop 0400459 | chrom | 316760508 | stuk | 58,50 | 188 | 0 |
| |  | 1-gats keukenkraan 185mm m. gegoten uitloop 0400440 | chrom | 316230508 | stuk | 102,00 | 188 | 1 |

| Art.nr | Specificaties | Kleur | Lev.nr | Ehd | Prijs | Grp | CC |
|--------|---------------|-------|--------|-----|-------|-----|----|
|--------|---------------|-------|--------|-----|-------|-----|----|

Kludi Standaard Terralux

1-gats keukenkraan lage drukboiler

| | | | | | | | |
|---------|--|-------|-----------|------|-------|-----|---|
| 0402931 | | chrom | 319210508 | stuk | 73,50 | 188 | 1 |
|---------|--|-------|-----------|------|-------|-----|---|



Sanitair producten

Baden /
douchebakken /
stoomcabines

Kludi Steel

100 1-gats keukenkraan

| | | | | | | | |
|---------|--|-----------------|-----------|------|--------|-----|---|
| 0409770 | | edelst./borstel | 38850F660 | stuk | 299,00 | 187 | 1 |
|---------|--|-----------------|-----------|------|--------|-----|---|

| | | | | | | | |
|---------|--|-----------------|-----------|------|--------|-----|---|
| 0409772 | | edelst./polijst | 38850F760 | stuk | 328,00 | 187 | 1 |
|---------|--|-----------------|-----------|------|--------|-----|---|



Kranen

Douchegarnituur

101 1-gats keukenkraan m. uittrekbare uitloop

| | | | | | | | |
|---------|--|-----------------|-----------|------|--------|-----|---|
| 0409774 | | edelst./borstel | 38851F660 | stuk | 479,00 | 187 | 1 |
|---------|--|-----------------|-----------|------|--------|-----|---|

| | | | | | | | |
|---------|--|-----------------|-----------|------|--------|-----|---|
| 0409776 | | edelst./polijst | 38851F760 | stuk | 527,00 | 187 | 1 |
|---------|--|-----------------|-----------|------|--------|-----|---|

Accessoires en
spiegels**200 1-gats keukenkraan semi-professioneel**

| | | | | | | | |
|---------|--|-----------------|-----------|------|--------|-----|---|
| 0409778 | | edelst./borstel | 38855F660 | stuk | 707,00 | 187 | 1 |
|---------|--|-----------------|-----------|------|--------|-----|---|

| | | | | | | | |
|---------|--|-----------------|-----------|------|--------|-----|---|
| 0409780 | | edelst./polijst | 38855F760 | stuk | 778,00 | 187 | 1 |
|---------|--|-----------------|-----------|------|--------|-----|---|



Douchewanden

Toebehoren &
afvoeren**300 1-gats keukenkraan professioneel**

| | | | | | | | |
|---------|--|-----------------|-----------|------|--------|-----|---|
| 0409782 | | edelst./borstel | 38857F660 | stuk | 900,00 | 187 | 1 |
|---------|--|-----------------|-----------|------|--------|-----|---|

| | | | | | | | |
|---------|--|-----------------|-----------|------|--------|-----|---|
| 0409784 | | edelst./polijst | 38857F760 | stuk | 989,00 | 187 | 1 |
|---------|--|-----------------|-----------|------|--------|-----|---|

Spoel- &
installatiesystemenBadkamermeubelen
en toiletkasten

Kludi Tercio

wandkraan m. draaibare onderuitloop

| | | | | | | | |
|---------|--|-------|-----------|------|--------|-----|---|
| 0409535 | | chrom | 389540575 | stuk | 109,00 | 187 | 1 |
|---------|--|-------|-----------|------|--------|-----|---|

Gootstenen en
wastroggen

Utiliteit

1-gats keukenkraan

| | | | | | | | |
|---------|--|-------|-----------|------|-------|-----|---|
| 0409534 | | chrom | 389630575 | stuk | 86,00 | 187 | 1 |
|---------|--|-------|-----------|------|-------|-----|---|



Kludi Trendo









1-gats keukenkraan m. draaibare uitloop







| | | | | | | | |
|---------|--|-------|-----------|------|--------|-----|---|
| 0400665 | | chrom | 337740562 | stuk | 140,00 | 187 | 1 |
|---------|--|-------|-----------|------|--------|-----|---|







**1-gats keukenkraan m. uittrekbare handdouche**

| | | | | | | | |
|---------|--|-------|-----------|------|--------|-----|---|
| 0406384 | | chrom | 337810562 | stuk | 217,00 | 187 | 1 |
|---------|--|-------|-----------|------|--------|-----|---|



| | Art.nr | Specificaties | Kleur | Lev.nr | Ehd | Prijs | Grp | CC |
|---|---|---|-------|-----------|-----------|--------|--------|-----|
| Sanitair producten |  | Kludi Zenta | | | | | | |
| | | douchethermostaat HOH=15cm | | | | | | |
| | 0400473 | | chrom | 351000538 | stuk | 147,00 | 187 | 1 |
| Baden / douchebakken / stoomcabines |  | badthermostaat | | | | | | |
| | 0400474 | | chrom | 351010538 | stuk | 186,00 | 187 | 1 |
| Kranen |  | douchethermostaat m. glijstangset 2S | | | | | | |
| Douchegarnituur |  | 0400475 60cm | chrom | 605760500 | stuk | 197,00 | 187 | 1 |
| | | 0400476 90cm | chrom | 605770500 | stuk | 201,00 | 187 | 1 |
| Accessoires en spiegels |  | Kludi Zip | | | | | | |
| Douchewanden |  | 1-greeps keukenkraan m. uittrekbare handdouche | | | | | | |
| | | 0409510 | | chrom | 42101Z175 | stuk | 489,00 | 187 |
| Toebehoren & afvoeren |  | 2-greeps keukenkraan m. uittrekbare handdouche | | | | | | |
| | | 0409537 | | chrom | 42100Z129 | stuk | 543,00 | 187 |
| Spoel- & installatiesystemen |  | greepulzen set | | | | | | |
| Badkamermeubelen en toiletkasten | | 0409545 | | 777240000 | stuk | 37,75 | 187 | 1 |
| Gootstenen en wastroggen |  | Kludi Quick-stop | | | | | | |
| | | Quick-stop voor keukenkraan | | | | | | |
| Utiliteit | | 0400064 | chrom | 1212005 | stuk | 204,00 | 187 | 1 |

| Art.nr | Specificaties | Kleur | Lev.nr | Ehd | Prijs | Grp | CC | | |
|--|---------------|--------|---------------|------|--------|-----|----|---|---|
| | | | | | | | | KWC Domo | |
| 1-gats keukenkraan m. uitloop m. vaatdouche 0405965 | | chroom | 10061154000 | stuk | 690,00 | 192 | 1 |  | Sanitair producten |
| 1-gats keukenkraan vrijstaand m. uitloop m. vaatdouche 0405970 | | chroom | 10061144000 | stuk | 669,00 | 192 | 1 | | Baden / douchebakken / stoomcabines |
| | | | | | | | | KWC Eve | |
| 1-gats keukenkraan z. verlichting 0405141 | | chroom | 10111103000 | stuk | 474,00 | 192 | 1 |  | Kranen |
| 1-gats keukenkraan m. verlichting 0405142 | | chroom | 10121103000 | stuk | 647,00 | 192 | 1 | | Doucheapparatuur |
| | | | | | | | | KWC Gastro | |
| 1-greeps keukenkraan staand m. vaatdouche 0405140 | | chroom | 24501066000 | stuk | 529,00 | 192 | 1 |  | Accessoires en spiegels |
| 1-gats keukenkraan m. draaibare uitloop 300mm 0403784 | | chroom | K244104000C07 | stuk | 274,00 | 192 | 1 |  | Douchewanden |
| 0405515 | | chroom | K244124000C02 | stuk | 192,00 | 192 | 1 | | Toebehoren & afvoeren |
| 1-gats keukenkraan staand m. knijpdouche 0403814 | | chroom | K244160000C06 | stuk | 479,00 | 192 | 1 |  | Spoel- & installatiesystemen |
| 2-greeps keukenkraan staand m. uitloop m. knijpdouche 0405159 | | chroom | K244161000C06 | stuk | 572,00 | 192 | 0 |  | Badkamermeubelen en toiletkasten |
| 1-gats keukenkraan m. flexibele hendel 0405205 | | chroom | K246124000B02 | stuk | 285,00 | 192 | 1 |  | Gootstenen en wastroggen |
| | | | | | | | | | Utiliteit |

| | Art.nr | Specificaties | Kleur | Lev.nr | Ehd | Prijs | Grp | CC |
|---|---|--|-------|---------------|------|--------|-----|----|
| Sanitair producten | KWC Gastro | | | | | | | |
| | | 2-gats keukenkraan staand m. uitloop m. knijpdouche | | | | | | |
| | 0403830 | | chrom | K244264000C71 | stuk | 587,00 | 192 | 1 |
| Baden / douchebakken / stoomcabines |  | | | | | | | |
| Kranen | keukenkraan wand m. knijpdouche | | | | | | | |
| | 0403849 | | chrom | K244270000C78 | stuk | 479,00 | 192 | 1 |
| Douchegarnituur |  | | | | | | | |
| Accessoires en spiegels | keukenkraan wand m. uitloop m. knijpdouche | | | | | | | |
| | 0403857 | | chrom | K244274000C78 | stuk | 587,00 | 192 | 0 |
| Douchewanden |  | | | | | | | |
| Toebehoren & afvoeren | gootsteentapkraan staand m. knijpdouche | | | | | | | |
| | 0403792 | | chrom | K244060000C34 | stuk | 402,00 | 192 | 1 |
| Toebehoren & afvoeren |  | | | | | | | |
| Spoel- & installatiesystemen | KWC Gastro Onderdelen | | | | | | | |
| | 0403873 | slang 1/2"x107.5cm chrom | | Z502844 | stuk | 96,50 | 192 | 0 |
| Badkamermeubelen en toiletkasten | 0403881 | slang 1/2"x150cm chrom | | Z502869 | stuk | 127,00 | 192 | 1 |
| | 0404438 | slang voor 1220/220 m. oude nok 1/2"x150cm chrom | | Z501720000 | stuk | 43,25 | 192 | 1 |
| | 0404411 | slang voor 1220/220 1/2"x150cm chrom | | Z501997000 | stuk | 46,50 | 192 | 0 |
| | 0403903 | knijpdouche z. slang | | Z506043145 | stuk | 174,00 | 192 | 0 |
| | 0403938 | sproeiplaat voor knijpdouche | | Z601136 | stuk | 2,25 | 192 | 1 |
| | 0403911 | stootrubber voor knijpdouche | | Z501831931 | stuk | 14,25 | 192 | 1 |
| Gootstenen en wastroggen | 0404373 | handdouche voor kranen 1220/220 wit | | Z504212102 | stuk | 56,00 | 192 | 1 |
| | 0404365 | handdouche voor kranen 1220/220 chrom | | Z504212000 | stuk | 56,00 | 192 | 1 |
| | 0404403 | handdouche voor kranen 1220/220 edelmat | | Z504212051 | stuk | 70,50 | 192 | 1 |
| | 0404381 | handdouche voor kranen 1220/220 zwart | | Z504212106 | stuk | 56,00 | 192 | 1 |
| | 0404357 | handdouche voor kranen 1220/220 bruin | | Z504212104 | stuk | 56,00 | 192 | 1 |
| Utiliteit | 0404330 | handdouche kort voor 1220/180 wit | | Z504228102 | stuk | 56,00 | 192 | 1 |
| | 0404322 | handdouche kort voor 1220/180 chrom | | Z504228000 | stuk | 56,00 | 192 | 1 |
| | 0405477 | druppelstop 3/4" voor uitlopen | | Z530928 | stuk | 32,25 | 192 | 1 |
| | 0403946 | veer knijpdouche grijs | | Z534714700 | stuk | 54,50 | 192 | 1 |
| | 0404004 | omstelinrichting compleet chrom | | Z503577 | stuk | 56,00 | 192 | 1 |
| KWC Konos | keukenkraan m. draaibare booguitloop | | | | | | | |
| | 0407992 | | chrom | K10K112000A02 | stuk | 489,00 | 192 | 1 |
| |  | | | | | | | |
| KWC Konos | keukenkraan m. uittrekbare uitloop | | | | | | | |
| | 0408026 | | chrom | K10K148000A02 | stuk | 537,00 | 192 | 1 |
| |  | | | | | | | |

| Art.nr | Specificaties | Kleur | Lev.nr | Ehd | Prijs | Grp | CC |
|--------|---------------|-------|--------|-----|-------|-----|----|
|--------|---------------|-------|--------|-----|-------|-----|----|

KWC Konos

| | | | | | | | |
|--|--|--------|---------------|------|--------|-----|---|
| keukenkraan m. draaibare uitloop 0408042 | | chroom | K10K123000A02 | stuk | 444,00 | 192 | 1 |
|--|--|--------|---------------|------|--------|-----|---|



Sanitair producten

Baden /
douchebakken /
stoomcabines

| | | | | | | | |
|---|--|--------|---------------|------|--------|-----|---|
| keukenkraan m. uittrekbare handdouche 0408069 | | chroom | K10K133000A02 | stuk | 489,00 | 192 | 1 |
|---|--|--------|---------------|------|--------|-----|---|



Kranen

Douchegarnituur

KWC Luna

| | | | | | | | |
|---|--|--------|---------------|------|--------|-----|---|
| 1-gats keukenkraan m. draaibare uitloop 225mm 0404837 | | chroom | K10A123000A10 | stuk | 161,00 | 192 | 0 |
|---|--|--------|---------------|------|--------|-----|---|

Accessoires en
spiegels

| | | | | | | | |
|--|--|--------|---------------|------|--------|-----|---|
| 1-gats keukenkraan m. uittrekbare handdouche 180mm 0405027 | | chroom | K10A133000A02 | stuk | 238,00 | 192 | 0 |
|--|--|--------|---------------|------|--------|-----|---|



Douchewanden

Toebehoren &
afvoeren

| | | | | | | | |
|---|--|--------|---------------|------|--------|-----|---|
| 1-gats lagedrukmengkraan m. draaibare uitloop 225mm 0405566 | | chroom | K10A523000A01 | stuk | 185,00 | 192 | 1 |
|---|--|--------|---------------|------|--------|-----|---|

Spoel- &
installatiesystemenBadkamermeubelen
en toiletkasten

KWC Orcino

| | | | | | | | |
|---|--|---------|---------------|------|--------|-----|---|
| 1-gats keukenkraan m. draaibare uitloop 0402990 | | chr/chr | K107123000A02 | stuk | 247,00 | 192 | 1 |
|---|--|---------|---------------|------|--------|-----|---|

Gootstenen en
wastroggen

| | | | | | | | |
|---|--|--------|---------------|------|--------|-----|---|
| 1-gats keukenkraan m. draaibare uitloop 225mm m. lange hendel 0405353 | | chroom | K107123000B02 | stuk | 255,00 | 192 | 1 |
|---|--|--------|---------------|------|--------|-----|---|

Utiliteit

| | | | | | | | |
|---|--|--------|---------------|------|--------|-----|---|
| 1-gats keukenkraan m. uittrekbare uitloop 225mm m. lange hendel 0405361 | | chroom | K107133000B02 | stuk | 364,00 | 192 | 1 |
|---|--|--------|---------------|------|--------|-----|---|



| | | | | | | | |
|--|--|---------|---------------|------|--------|-----|---|
| 1-gats keukenkraan m. uittrekbare handdouche 0404950 180mm | | chr/chr | K107132000A02 | stuk | 356,00 | 192 | 1 |
|--|--|---------|---------------|------|--------|-----|---|



| | | | | | | | |
|---------------|--|---------|---------------|------|--------|-----|---|
| 0403008 225mm | | chr/chr | K107133000A02 | stuk | 356,00 | 192 | 1 |
|---------------|--|---------|---------------|------|--------|-----|---|







KWC Star

| | | | | | | | |
|---|--|---------|---------------|------|--------|-----|---|
| 1-gats keukenkraan m. draaibare uitloop 0402141 | | chr/chr | K104123000A02 | stuk | 183,00 | 192 | 1 |
|---|--|---------|---------------|------|--------|-----|---|



| | Art.nr | Specificaties | Kleur | Lev.nr | Ehd | Prijs | Grp | CC |
|---|---|---|-------|---------------|------|--------|-----|----|
| Sanitair producten | KWC Style | | | | | | | |
| |  | keukenkraan m. uittrekbare uitloop 0408085 | chrom | K10C148000A02 | stuk | 444,00 | 192 | 1 |
| Baden / douchebakken / stoomcabines | keukenkraan m. draaibare uitloop | | | | | | | |
| |  | 0408107 | chrom | K10C123000A02 | stuk | 405,00 | 192 | 1 |
| Kranen | KWC Systema | | | | | | | |
| Douchegarnituur | | keukenkraan m. vaatdouche m. uitloop staand 0401018 | chrom | 24501144000 | stuk | 780,00 | 192 | 1 |
| Accessoires en spiegels | | | | | | | | |
| Douchewanden | | | | | | | | |
| Toebehoren & afvoeren | | | | | | | | |
| Spoel- & installatiesystemen | | | | | | | | |
| Badkamermeubelen en toiletkasten | | | | | | | | |
| Gootstenen en wastroggen | | | | | | | | |
| Utiliteit | | | | | | | | |

| Art.nr | Specificaties | Kleur | Lev.nr | Ehd | Prijs | Grp | CC | |
|--|---------------|--------|--------|------|--------|-----|----|---|
| | | | | | | | | Nobili Palladio |
| keukenkraan 0492736 | | chroom | 331132 | stuk | 177,00 | 150 | 0 |  |
| | | | | | | | | Nobili Wishwash Plus |
| 1-gats keukenkraan 185mm 0492119 | | chroom | S113CR | stuk | 168,00 | 196 | 1 |  |
| 1-gats keukenkraan m. handdouche 470mm 0492121 | | chroom | S300CR | stuk | 304,00 | 196 | 1 |  |
| 1-gats keukenkraan m. handdouche 575mm 0492122 | | chroom | S305CR | stuk | 482,00 | 196 | 1 |  |

Sanitair producten

Baden /
douchebakken /
stoomcabines

Kranen

Douchegarnituur

Accessoires en
spiegels

Douchewanden

Toebehoren &
afvoeren

Spoel- &
installatiesystemen

Badkamermeubelen
en toiletkasten

Gootstenen en
wastroggen

Utiliteit

| | Art.nr | Specificaties | Kleur | Lev.nr | Ehd | Prijs | Grp | CC |
|---|-------------------------------|--|-------------|---------|------|--------|-----|----|
| Sanitair producten | Plieger Brussel | | | | | | | |
| | | 1-gats keukenkraan m. straalregelaar | | | | | | |
| | 0690570 | | chroom | 0690570 | stuk | 48,50 | 150 | 0 |
| | 0690422 | keramisch | chroom | 0690422 | stuk | 60,50 | 150 | 0 |
| Baden / douchebakken / stoomcabines | Plieger Charleston | | | | | | | |
| | | 1-gats keukenkraan m. kruisknop m. uitloop 19cm | | | | | | |
| | 0492051 | | chroom | 0492051 | stuk | 99,00 | 150 | 0 |
| Kranen | | | chroom/goud | 0492102 | stuk | 123,00 | 150 | 0 |
| | | | | | | | | |
| Douchegarnituur | Plieger Spring New | | | | | | | |
| | | New 1-gats keukenkraan | | | | | | |
| | 0690508 | | chroom | 0690508 | stuk | 134,00 | 150 | 0 |
| Accessoires en spiegels | Plieger Spring Project | | | | | | | |
| | | 1-gats keukenkraan keramisch m. draaibare uitloop | | | | | | |
| | 0690503 | | chroom | 0690503 | stuk | 112,00 | 150 | 0 |
| Douchewanden | | | | | | | | |
| Toebehoren & afvoeren | | | | | | | | |
| Spoel- & installatiesystemen | | | | | | | | |
| Badkamermeubelen en toiletkasten | | | | | | | | |
| Gootstenen en wastroggen | | | | | | | | |
| Utiliteit | | | | | | | | |

| Art.nr | Specificaties | Kleur | Lev.nr | Ehd | Prijs | Grp | CC |
|--------|---------------|-------|--------|-----|-------|-----|----|
|--------|---------------|-------|--------|-----|-------|-----|----|

Sphinx Eurobase

wandkraan z. koppelingen m. draaibare uitloop 16cm

| | | | | | | | |
|---------|---------------------------|--------|----------|------|--------|-----|---|
| 0411566 | | chroom | EK07 | stuk | 163,25 | 172 | 1 |
| 0411302 | z. hendel | chroom | S8EK07S | stuk | 147,00 | 213 | 1 |
| 0411388 | kraanhendel SK 220mm lang | chroom | S8EKA217 | stuk | 31,25 | 213 | 1 |



Sanitair producten

wandkraan z. koppelingen m. draaibare uitloop 20cm

| | | | | | | | |
|---------|---------------------------|--------|----------|------|--------|-----|---|
| 0411574 | | chroom | EK08 | stuk | 162,25 | 172 | 1 |
| 0411086 | z. hendel | chroom | S8EK08S | stuk | 146,00 | 213 | 0 |
| 0411388 | kraanhendel SK 220mm lang | chroom | S8EKA217 | stuk | 31,25 | 213 | 1 |

Baden /
douchebakken /
stoomcabines**wandkraan m. buisuitloop z. koppelingen 1/2"**

| | | | | | | | |
|---------|--|--------|--------|------|--------|-----|---|
| 0412120 | | chroom | S8EK32 | stuk | 163,00 | 213 | 1 |
|---------|--|--------|--------|------|--------|-----|---|

Kranen

1-gats keukenkraan m. draaibare uitloop 21cm

| | | | | | | | |
|---------|---------------------------|--------|----------|------|--------|-----|---|
| 0411639 | | chroom | EK75 | stuk | 207,25 | 172 | 1 |
| 0411078 | z. hendel | chroom | S8EK75FS | stuk | 191,00 | 213 | 1 |
| 0411388 | kraanhendel SK 220mm lang | chroom | S8EKA217 | stuk | 31,25 | 213 | 1 |



Doucheapparatuur

1-gats keukenkraan m. draaibare uitloop 24cm

| | | | | | | | |
|---------|---------------------------|--------|----------|------|--------|-----|---|
| 0411531 | | chroom | EK05 | stuk | 158,25 | 172 | 1 |
| 0411051 | z. hendel | chroom | S8EK05PS | stuk | 142,00 | 213 | 0 |
| 0411388 | kraanhendel SK 220mm lang | chroom | S8EKA217 | stuk | 31,25 | 213 | 1 |

Accessoires en
spiegels

Douchewanden

1-gats keukenkraan m. wasmachinekraan

| | | | | | | | |
|---------|--|--------|------|------|--------|-----|---|
| 0411558 | | chroom | EK06 | stuk | 207,25 | 172 | 1 |
|---------|--|--------|------|------|--------|-----|---|

Toebehoren &
afvoeren**2-gats keukenkraan m. uittrekbare handdouche**

| | | | | | | | |
|---------|---------------------------|--------|----------|------|--------|-----|---|
| 0411523 | | chroom | EK04P | stuk | 259,25 | 172 | 1 |
| 0411310 | z. hendel | chroom | S8EK04PS | stuk | 243,00 | 213 | 1 |
| 0411388 | kraanhendel SK 220mm lang | chroom | S8EKA217 | stuk | 31,25 | 213 | 1 |

Spoel- &
installatiesystemen

Sphinx Euromed

wandkraan m. uitloop z. koppelingen 1/2"

| | | | | | | | |
|---------|--|--------|--------|------|--------|-----|---|
| 0412155 | | chroom | S8SK32 | stuk | 178,00 | 213 | 1 |
|---------|--|--------|--------|------|--------|-----|---|

Badkamermeubelen
en toiletkasten**1-gats keukenkraan m. draaibare uitloop 21cm**

| | | | | | | | |
|---------|--|--------|------|------|--------|-----|---|
| 0411787 | | chroom | SK75 | stuk | 222,25 | 172 | 1 |
|---------|--|--------|------|------|--------|-----|---|

Gootstenen en
wastroggen

Utiliteit

1-gats keukenkraan m. draaibare uitloop 24cm

| | | | | | | | |
|---------|--|--------|------|------|--------|-----|---|
| 0411671 | | chroom | SK05 | stuk | 173,25 | 172 | 1 |
|---------|--|--------|------|------|--------|-----|---|

**1-gats keukenkraan/wasmachinekraan**

| | | | | | | | |
|---------|--|--------|------|------|--------|-----|---|
| 0411698 | | chroom | SK06 | stuk | 222,25 | 172 | 1 |
|---------|--|--------|------|------|--------|-----|---|

**2-gats keukenkraan m. uittrekbare handdouche**











| | | | | | | | |
|---------|--|--------|------|------|--------|-----|---|
| 0411663 | | chroom | SK04 | stuk | 274,25 | 172 | 1 |
|---------|--|--------|------|------|--------|-----|---|



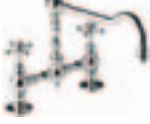



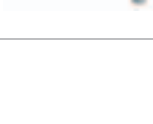



wandkraan z. koppelingen m. draaibare uitloop 16cm









| | | | | | | | |
|---------|--|--------|------|------|--------|-----|---|
| 0411701 | | chroom | SK07 | stuk | 178,25 | 172 | 1 |
|---------|--|--------|------|------|--------|-----|---|





| | Art.nr | Specificaties | Kleur | Lev.nr | Ehd | Prijs | Grp | CC |
|---|-----------------------|--|-------|--------|------|--------|-----|----|
| Sanitair producten | Sphinx Euromed | | | | | | | |
| | | wandkraan z. koppelingen m. draaibare uitloop 20cm 0411728 | chrom | SK08 | stuk | 177,25 | 172 | 1 |
| Baden / douchebakken / stoomcabines | | 1-gats keukenkraan m. uitloop 20cm 0412147 | chrom | S8SK77 | stuk | 267,00 | 213 | 1 |
| Kranen | | | | | | | | |
| Douchegarnituur | | | | | | | | |
| Accessoires en spiegels | | | | | | | | |
| Douchewanden | | | | | | | | |
| Toebehoren & afvoeren | | | | | | | | |
| Spoel- & installatiesystemen | | | | | | | | |
| Badkamermeubelen en toiletkasten | | | | | | | | |
| Gootstenen en wastroggen | | | | | | | | |
| Utiliteit | | | | | | | | |

| Art.nr | Specificaties | Kleur | Lev.nr | Ehd | Prijs | Grp | CC | | |
|--|---|---------|----------|------|--------|-----|----|---|---|
| Venlo Astro | | | | | | | |  | Sanitair producten |
| 1-gats keukenkraan | | | | | | | | | |
| 0424579 | | chroom | H2309A02 | stuk | 229,00 | 215 | 1 | | |
| 0444278 | | chroom | H2309A01 | stuk | 148,00 | 210 | 1 | | |
| Venlo Culinair-1000 | | | | | | | |  | Baden / douchebakken / stoomcabines |
| 1-gats keukenkraan m. draaibare booguitloop m. straalregelaar | | | | | | | | | |
| 0424285 | | chroom | H2409A01 | stuk | 299,00 | 210 | 1 | | |
| 0424293 | | RVS | H2409L01 | stuk | 365,00 | 210 | 1 | | |
| Venlo Culinair-1000 | | | | | | | |  | Kranen |
| 1-gats keukenkraan m. draaibare hoekuitloop m. straalregelaar | | | | | | | | | |
| 0424307 | | chroom | H2409A02 | stuk | 370,00 | 210 | 1 | | |
| 0424315 | | RVS | H2409L02 | stuk | 445,00 | 210 | 1 | | Douchegarnituur |
| Venlo Culinair-1000 | | | | | | | |  | Accessoires en spiegels |
| 1-hendel keukenkraan m. draaibare uitloop m. straalregelaar | | | | | | | | | |
| 0424308 | | chroom | H2409A03 | stuk | 502,00 | 210 | 1 | | |
| Venlo Culinair-1000 | | | | | | | |  | Douchewanden |
| 2-gats keukenkraan m. draaibare uitloop m. straalregelaar | | | | | | | | | |
| 0424331 | | chroom | H2429A01 | stuk | 509,00 | 210 | 1 | | |
| 0424358 | | RVS | H2429L01 | stuk | 579,00 | 210 | 1 | | Toebehoren & afvoeren |
| 0444243 | | brons | H2429K01 | stuk | 559,00 | 210 | 1 | | |
| Venlo Culinair-1000 | | | | | | | |  | Spoel- & installatiesystemen |
| verlengstuk | | | | | | | | | |
| 0444251 | | messing | H2490A14 | stuk | 50,00 | 210 | 1 | | |
| Venlo Culinair-1000 | | | | | | | |  | Badkamermeubelen en toiletkasten |
| 3-gats keukenkraan m. draaibare uitloop m. straalregelaar | | | | | | | | | |
| 0424269 | | chroom | H2405A01 | stuk | 441,00 | 210 | 1 | | |
| 0424277 | | RVS | H2405L01 | stuk | 508,00 | 210 | 1 | | Gootstenen en wastroggen |
| Venlo Culinair-2000 | | | | | | | |  | Utiliteit |
| 1-gats keukenkraan m. hoge uitloop | | | | | | | | | |
| 0426253 | | chroom | H7809A07 | stuk | 114,00 | 210 | 1 | | |
| Venlo Culinair-2000 | | | | | | | |  | |
| 1-gats keukenkraan m. uittrekbare handdouche | | | | | | | | | |
| 0426245 | | chroom | H7811A02 | stuk | 310,00 | 210 | 1 | | |
| Venlo Easy | | | | | | | |  | |
| 1-gats keukenthermostaat | | | | | | | | | |
| 0426288 | | chroom | H3846A02 | stuk | 223,00 | 218 | 1 | | |
| Venlo Easy | | | | | | | |  | |
| wand keukenthermostaat m. onderuitloop z. koppelingen | | | | | | | | | |
| 0426296 | HOH=15cm | chroom | H3846A04 | stuk | 207,00 | 218 | 1 | | |
| 0421251 | S-koppeling m. rozet per paar 1/2"x3/4" | chroom | H1040A06 | paar | 12,00 | 215 | 0 | | |
| Venlo Nimbus Eco Comfort | | | | | | | |  | |
| keukenkraan z. koppelingen m. onderuitloop | | | | | | | | | |
| 0420719 | | chroom | H1730A01 | stuk | 57,00 | 215 | 0 | | |

| | Art.nr | Specificaties | Kleur | Lev.nr | Ehd | Prijs | Grp | CC |
|---|---|--|-------|----------|------|--------|-----|----|
| Sanitair producten | Venlo Nimbus Eco Comfort | | | | | | | |
| | | 1-gats keukenkraan m. hoge uitloop 0421006 | chrom | H1209A01 | stuk | 57,50 | 215 | 0 |
| Baden / douchebakken / stoomcabines |  | | | | | | | |
| Kranen | wandkraan 1/2" z. koppelingen z. uitloop | | | | | | | |
| | | 0421111 | chrom | H1230A06 | stuk | 42,50 | 215 | 0 |
| |  | | | | | | | |
| Douchegarnituur | Venlo Nimbus Eco | | | | | | | |
| | | 1-gats keukenkraan m. hoge uitloop 0423025 | chrom | H3330001 | stuk | 59,50 | 215 | 0 |
| Accessoires en spiegels |  | | | | | | | |
| Douchewanden | 1-gats gootsteenkraan m. hoge uitloop 31cm | | | | | | | |
| | | 0425621 | chrom | H3009A03 | stuk | 73,00 | 215 | 1 |
| |  | | | | | | | |
| Toebehoren & afvoeren | 1-gats keukenkraan | | | | | | | |
| | | 0424560 | chrom | H3009A02 | stuk | 92,00 | 215 | 0 |
| Spoel- & installatiesystemen |  | | | | | | | |
| Badkamermeubelen en toiletkasten | 1-gats gootsteenkraan m. draaibare uitloop | | | | | | | |
| | | 0425648 | chrom | H3009A04 | stuk | 115,00 | 215 | 0 |
| |  | | | | | | | |
| Gootstenen en wastroggen | keukenwandkraan HOH=15cm | | | | | | | |
| | | 0425672 | chrom | H3030A02 | stuk | 118,00 | 215 | 1 |
| |  | | | | | | | |
| Utiliteit | keukenkraan messing z. koppelingen z. uitloop | | | | | | | |
| | | 0423629 | chrom | H3331008 | stuk | 44,25 | 215 | 0 |
| |  | | | | | | | |
| | 1-gats keukenkraan m. perlator m. hoge uitloop | | | | | | | |
| | | 0420099 | chrom | H2909A01 | stuk | 79,50 | 215 | 1 |
| |  | | | | | | | |
| | 1-gats keukenkraan m hoge uitloop 31cm | | | | | | | |
| | | 0420100 | chrom | H2909A02 | stuk | 98,00 | 215 | 1 |
| |  | | | | | | | |

| Art.nr | Specificaties | Kleur | Lev.nr | Ehd | Prijs | Grp | CC | | |
|--|---------------|--------|----------|------|--------|-----|----|---|---|
| Venlo Nimbus Eco | | | | | | | | | |
| 1-gats keukenkraan m. hoge uitloop 0420646 | | chroom | H1709A01 | stuk | 52,50 | 215 | 0 |  | Sanitair producten |
| keukenkraan m. bovenuitloop z. koppelingen 0420720 | | chroom | H1730A02 | stuk | 57,00 | 215 | 1 |  | Baden / douchebakken / stoomcabines |
| Venlo Nimbus Eco Nostalgisch | | | | | | | | | |
| 1-gats keukenkraan m. draaibare uitloop 0422479 | | chroom | H1909A01 | stuk | 76,50 | 210 | 1 |  | Douchegarnituur |
| 1-gats keukenkraan m. draaibare uitloop 0421224 | | chroom | H1909A02 | stuk | 98,50 | 210 | 1 |  | Accessoires en spiegels |
| 0421266 | | chroom | H1909A03 | stuk | 122,00 | 210 | 1 | | Toebehoren & afvoeren |
| Venlo Nimbus Keramisch Nostalgisch | | | | | | | | | |
| 1-gats keukenkraan m. draaibare uitloop 0423173 | | chroom | H1209A02 | stuk | 80,50 | 215 | 1 |  | Douchewanden |
| keukenkraan z. koppelingen z. uitloop 0423335 | | chroom | H1230A09 | stuk | 66,00 | 215 | 1 |  | Spoel- & installatiesystemen |
| Venlo Nimbus Keramisch Comfort | | | | | | | | | |
| 1-gats keukenkraan m. draaibare uitloop 2-greeps 0422657 | | chroom | H2109A10 | stuk | 195,00 | 210 | 1 |  | Badkamermeubelen en toiletkasten |
| 1-gats keukenkraan m. draaibare uitloop 1-greeps 0421826 | | chroom | H2109A06 | stuk | 245,00 | 210 | 0 |  | Gootstenen en wastroggen |
| 1-gats keukenkraan m. draaibare bovenuitloop 0422681 | | chroom | H2109A11 | stuk | 194,00 | 210 | 1 |  | Utiliteit |

| | Art.nr | Specificaties | Kleur | Lev.nr | Ehd | Prijs | Grp | CC |
|---|---|--|---|----------|----------|--------|--------|-----|
| Sanitair producten |  | Venlo Tado | | | | | | |
| | | | 1-gats keukenkraan m. draaibare uitloop 0422053 | chrom | H2209A01 | stuk | 111,00 | 210 |
| Baden / douchebakken / stoomcabines |  | 1-gats keukenkraan m. uittrekbare handdouche 0422088 | chrom | H2211A01 | stuk | 194,00 | 210 | 1 |
| Kranen | | | | | | | | |
| Douchegarnituur | | | | | | | | |
| Accessoires en spiegels | | | | | | | | |
| Douchewanden | | | | | | | | |
| Toebehoren & afvoeren | | | | | | | | |
| Spoel- & installatiesystemen | | | | | | | | |
| Badkamermeubelen en toiletkasten | | | | | | | | |
| Gootstenen en wastroggen | | | | | | | | |
| Utiliteit | | | | | | | | |

| Art.nr | Specificaties | Kleur | Lev.nr | Ehd | Prijs | Grp | CC |
|--|---------------|-------------|------------|------|---------|-----|----|
| Villeroy & Boch Firbo | | | | | | | |
| 1-gats keukenkraan m. sprong 23.5cm | | | | | | | |
| 0475575 | | chroom | 3380090000 | stuk | 375,00 | 172 | 1 |
| 0475577 | | platina mat | 3380090006 | stuk | 525,00 | 172 | 1 |
| 0475579 | voor boiler | chroom | 3385090000 | stuk | 414,00 | 172 | 1 |
| 0475581 | voor boiler | platina mat | 3385090006 | stuk | 580,00 | 172 | 1 |
| Villeroy & Boch Pantro | | | | | | | |
| 1-gats keukenkraan m. sprong 23.5cm m. uittrekbare handdouche | | | | | | | |
| 0475583 | | chroom | 3383090000 | stuk | 558,00 | 172 | 1 |
| 0475585 | | platina mat | 3383090006 | stuk | 781,00 | 172 | 1 |
| Villeroy & Boch Tallo | | | | | | | |
| 1-gats keukenkraan m. sprong 23.5cm m. Prof handdouche | | | | | | | |
| 0475587 | | chroom | 3386090000 | stuk | 831,00 | 172 | 1 |
| 0475589 | | platina mat | 3386090006 | stuk | 1164,00 | 172 | 1 |

Sanitair producten

Baden /
douchebakken /
stoomcabines

Kranen

Douchegarnituur

Accessoires en
spiegels

Douchewanden

Toebehoren &
afvoeren

Spoel- &
installatiesystemen

Badkamermeubelen
en toiletkasten

Gootstenen en
wastroggen

Utiliteit

| | Art.nr | Specificaties | Kleur | Lev.nr | Ehd | Prijs | Grp | CC | |
|---|----------------------------|----------------|-----------------------|---------|---------|-------|-------|-----|---|
| Sanitair producten | Ballofix kranen | | | | | | | | |
| | hoekstopkraan | | | | | | | | |
| | 0440523 | 1/2"x10mm | chrom | 6000786 | stuk | 25,75 | 210 | 0 | |
| Baden / douchebakken / stoomcabines | kogelkraan | | | | | | | | |
| | 0440574 | 3/8"x3/8" | binnen- x buitendraad | chrom | 6000016 | stuk | 17,50 | 210 | 0 |
| Kranen | 0440558 | 1/2" | binnen- x buitendraad | chrom | 6000051 | stuk | 15,25 | 210 | 0 |
| | 0440639 | 3/4" | binnen- x buitendraad | chrom | 6000093 | stuk | 25,00 | 210 | 0 |
| | 0440531 | 1/2" | binnen- x binnendraad | chrom | 6000258 | stuk | 14,25 | 210 | 0 |
| | 0440612 | 10x12mm | 2xklem | chrom | 6000522 | stuk | 21,00 | 210 | 0 |
| | 0440655 | 10x15mm | 2xklem | chrom | 6000544 | stuk | 22,75 | 210 | 0 |
| | 0440582 | 12x12mm | 2xklem | chrom | 6000566 | stuk | 23,50 | 210 | 0 |
| Douchegarnituur | 0440000 | 12x15mm | 2xklem | chrom | 6000588 | stuk | 22,75 | 210 | 1 |
| | 0440590 | 15x15mm | 2xklem | chrom | 6000500 | stuk | 22,00 | 210 | 0 |
| | 0440647 | 22x22mm | 2xklem | chrom | 6000621 | stuk | 46,25 | 210 | 0 |
| Accessoires en spiegels | hendel/inbussleutel | | | | | | | | |
| | 0440426 | voor 1/4"-1/2" | zwart | 6002788 | stuk | 2,79 | 210 | 1 | |
| Douchewanden | | | | | | | | | |
| Toebehoren & afvoeren | | | | | | | | | |
| Spoel- & installatiesystemen | | | | | | | | | |
| Badkamermeubelen en toiletkasten | | | | | | | | | |
| Gootstenen en wastroggen | | | | | | | | | |
| Utiliteit | | | | | | | | | |

| Art.nr | Specificaties | Kleur | Lev.nr | Ehd | Prijs | Grp | CC |
|---------------------|---------------|-------|-----------|------------------------------|-------|-----|----|
| | | | | De Beer straalbrekers | | | |
| straalbreker | | | | | | | |
| 0440086 | M22x1 bi | | 330010010 | stuk | 1,03 | 210 | 0 |
| 0440108 | M24x1 bu | | 330020010 | stuk | 1,10 | 210 | 1 |

Sanitair producten

Baden /
douchebakken /
stoomcabines**Kranen**

Douchegarnituur

Accessoires en
spiegels

Douchewanden

Toebehoren &
afvoerenSpoel- &
installatiesystemenBadkamermeubelen
en toiletkastenGootstenen en
wastroggen

Utiliteit

F-Grohe kraan Toebehoren

| | Art.nr | Specificaties | Kleur | Lev.nr | Ehd | Prijs | Grp | CC |
|---|--------------------------------------|---------------|-------|----------|------|-------|-----|----|
| Sanitair producten | F-Grohe Eggemann | | | | | | | |
| | vaatwasmachinekraan m. T-stuk | | | | | | | |
| | 0439684 | | chrom | 41030000 | stuk | 27,25 | 163 | 1 |
| | 0439685 | m. beluchter | chrom | 41033000 | stuk | 30,50 | 163 | 1 |
| Baden / douchebakken / stoomcabines | CV-wasmachineadapter | | | | | | | |
| | 0439689 | | chrom | 41091000 | stuk | 25,00 | 163 | 1 |
| Kranen | 0439686 | | | | | | | |
| | | m. beluchter | chrom | 41061000 | stuk | 28,25 | 163 | 1 |
| Douchegarnituur | vaatwashoekstopkraan | | | | | | | |
| | 0439687 | | chrom | 41073000 | stuk | 24,25 | 163 | 1 |
| | 0439688 | m. beluchter | chrom | 41082000 | stuk | 27,50 | 163 | 1 |
| Accessoires en spiegels | 0439690 | | | | | | | |
| | | | | | | | | |
| Douchewanden | vorstvrije gevelkraan | | | | | | | |
| | 0439690 | | chrom | 41208000 | stuk | 97,00 | 163 | 1 |
| Toebehoren & afvoeren | beluchter | | | | | | | |
| | 0439691 | | chrom | 41239000 | stuk | 18,50 | 163 | 1 |
| Spoel- & installatiesystemen | hoekstopkraan | | | | | | | |
| | 0439692 | | chrom | 41263000 | stuk | 10,50 | 163 | 1 |
| Badkamermeubelen en toiletkasten | | | | | | | | |
| Gootstenen en wastroggen | | | | | | | | |
| Utiliteit | | | | | | | | |

| Art.nr | Specificaties | Kleur | Lev.nr | Ehd | Prijs | Grp | CC |
|---------|--|-------|----------|------|-------|-----|----|
| 0442631 | straalregelaar M22 bi | | 01960230 | stuk | 0,85 | 150 | 0 |
| 0442720 | straalregelaar waterbesparend M22 bi | | 01055330 | stuk | 3,01 | 210 | 0 |
| 0442666 | straalregelaar cascade M22 bi | | 01010094 | stuk | 2,02 | 210 | 0 |
| 0442690 | straalregelaar long-life antikalk M22 bi | | 01056311 | stuk | 2,05 | 210 | 0 |
| 0440698 | varioperl Cascade M22x1 bi | | 07312750 | stuk | 10,25 | 210 | 1 |
| 0440736 | bruis mondstuk 4 liter/min. M22x1 | | A5914730 | stuk | 7,70 | 210 | 1 |
| 0440701 | waterspaarder 6 liter/min. M22x1 | | 02700094 | stuk | 5,80 | 210 | 1 |
| 0440728 | waterspaarder 8 liter/min. M22x1 | | 02700594 | stuk | 5,80 | 210 | 1 |
| 0442658 | straalregelaar M24 bu | | 01962230 | stuk | 0,89 | 150 | 0 |
| 0442739 | straalregelaar waterbesparend M24 bu | | 01065330 | stuk | 6,10 | 210 | 0 |
| 0442674 | straalregelaar cascade M24 bu | | 01030094 | stuk | 2,09 | 210 | 0 |
| 0442682 | straalregelaar cascade M28 bu | | 01895330 | stuk | 3,96 | 210 | 0 |
| 0442704 | straalregelaar long-life antikalk M24 bu | | 01066311 | stuk | 2,10 | 210 | 0 |
| 0442712 | straalregelaar long-life antikalk M28 bu | | 01071310 | stuk | 4,08 | 210 | 0 |
| 0440744 | doorstroombegrenzer 6liter groen | | 53116150 | zak | 3,82 | 150 | 1 |
| 4320060 | verloopnippel M24bu xM22bu chroom | | 50050394 | stuk | 1,53 | 150 | 0 |

Sanitair producten

Baden /
douchebakken /
stoomcabines

Kranen



Douchegarnituur

Accessoires en
spiegels

Douchewanden

Toebehoren &
afvoerenSpoel- &
installatiesystemenBadkamermeubelen
en toiletkastenGootstenen en
wastroggen

Utiliteit

| | Art.nr | Specificaties | Kleur | Lev.nr | Ehd | Prijs | Grp | CC |
|---|---|---|--------|--------|------|-------|-----|----|
| Sanitair producten | Nil hoekstopkranen | | | | | | | |
| |  | hoekstopkraan m. rozet m. knop m. pijp 30cm 0440116 3/8"x10mm | chroom | 12426 | stuk | 7,80 | 210 | 0 |
| Baden / douchebakken / stoomcabines |  | hoekstopkraan z. rozet m. knop m. pijp 30cm 0440035 3/8"x10mm | chroom | 12226 | stuk | 7,40 | 210 | 0 |
| Kranen | | | | | | | | |
| Douchegarnituur | | | | | | | | |
| Accessoires en spiegels | | | | | | | | |
| Douchewanden | | | | | | | | |
| Toebehoren & afvoeren | | | | | | | | |
| Spoel- & installatiesystemen | | | | | | | | |
| Badkamermeubelen en toiletkasten | | | | | | | | |
| Gootstenen en wastroggen | | | | | | | | |
| Utiliteit | | | | | | | | |

FLEXIBLE PUSH FITTING



**NEW CONNECTORS
EASY TO INSTALL**

JUST A "CLICK"

**NO TOOLS OR
SOLDERING**

**NOUVEAUX FLEXIBLES
FACILES À MONTER**

EN UN SEUL "CLIC"

**SANS OUTIL
NI SOUDURES**

**NUEVOS FLEXIBLES
FÁCILES DE MONTAR**

SÓLO UN "CLIC"

**SIN HERRAMIENTAS
NI SOLDADURAS**

WITH THE GUARANTEE OF: **Tectite**



**INDUSTRIAS
mateu**

CONEXIONES FLEXIBLES PARA CONDUCCIONES DE AGUA Y GAS

www.imateu.com

imateu@imateu.com

INDUSTRIAS MATEU, S.A.
Pol. Ind. "LA FERRERIA" Avda. Ferreria, 11
08110 MONTCADA I REIXAC - Barcelona
Tels. (34) 93 564 37 14 - (34) 93 564 71 11
Fax (34) 93 564 73 00

| | Art.nr | Specificaties | Kleur | Lev.nr | Ehd | Prijs | Grp | CC |
|---|--|---------------|-------------------------|---------|------|-------|-----|----|
| Plieger kraanaansluitingen | | | | | | | | |
| Sanitair producten | messing klemkoppeling | | | | | | | |
| | 8910456 | 10mm | | 82473 | stuk | 3,08 | 850 | 0 |
| <hr/> | | | | | | | | |
| Messing knelkoppeling | | | | | | | | |
| | 8910472 | 12mm | | 82537 | stuk | 3,92 | 850 | 0 |
| <hr/> | | | | | | | | |
| Baden / douchebakken / stoomcabines | messing klemkoppeling verlopend | | | | | | | |
| | 0440434 | 12x10mm | | 0440434 | stuk | 2,85 | 850 | 0 |
| | 8910464 | 15x10mm | | 82466 | stuk | 3,13 | 850 | 0 |
| <hr/> | | | | | | | | |
| Kranen | Messing knel knie verlopend | | | | | | | |
| | 0440442 | 12x10mm | | 0440442 | stuk | 3,13 | 850 | 0 |
| | 8910804 | 15x10mm | | 82461 | stuk | 4,43 | 850 | 0 |
| <hr/> | | | | | | | | |
| Douchegarnituur | nikkelen klemkoppeling | | | | | | | |
| | 0440299 | 10x10mm | | 0440299 | stuk | 3,42 | 850 | 0 |
| | 0440353 | 12x10mm | | 0440353 | stuk | 3,13 | 850 | 0 |
| | 0440396 | 15x10mm | | 0440396 | stuk | 3,54 | 850 | 0 |
| <hr/> | | | | | | | | |
| Accessoires en spiegels | nikkelen klem kniekoppeling | | | | | | | |
| | 0440361 | 12x10mm | | 0440361 | stuk | 3,63 | 850 | 0 |
| | 0440604 | 15x10mm | | 0440604 | stuk | 4,82 | 850 | 0 |
| <hr/> | | | | | | | | |
| Douchewanden | Messing knelring | | | | | | | |
| | 0440507 | 10mm | | 0440507 | stuk | 0,32 | 844 | 0 |
| <hr/> | | | | | | | | |
| Toebehoren & afvoeren | flexibele slang 20cm | | | | | | | |
| | 4329102 | 1/2"x1/2" | bi x bi | 4329102 | stuk | 2,40 | 210 | 0 |
| | 4329098 | 3/8"x3/8" | bi x bi | 4329098 | stuk | 2,11 | 210 | 0 |
| | 4329108 | 10x1/2" | GL x bi | 4329108 | stuk | 2,28 | 210 | 0 |
| Spoel- & installatiesystemen | 4329122 | 10x3/8" | GL x bi | 4329122 | stuk | 2,20 | 210 | 0 |
| | 4329116 | 10x1/2" | knel x bi | 4329116 | stuk | 2,98 | 210 | 0 |
| | 4329120 | 10x10mm | GL x knel | 4329120 | stuk | 2,94 | 210 | 0 |
| | 4329114 | 10x10mm | knel x knel | 4329114 | stuk | 2,92 | 210 | 0 |
| Badkamermeubelen en toiletkasten | 4329054 | 10x12mm | knel x knel | 4329054 | stuk | 3,79 | 210 | 0 |
| | 4329062 | 10x15mm | knel x knel | 4329062 | stuk | 3,37 | 210 | 0 |
| | 4329050 | 1/2"x1/2" | knel x bi | 4329050 | stuk | 3,19 | 210 | 0 |
| | 4329070 | 12x3/8" | knel x bi | 4329070 | stuk | 2,95 | 210 | 0 |
| Gootstenen en wastroggen | 4329078 | 15x1/2" | knel x bi | 4329078 | stuk | 3,72 | 210 | 0 |
| | 4329082 | 12x12mm | knel x knel | 4329082 | stuk | 3,79 | 210 | 0 |
| | 4329090 | 15x15mm | knel x knel | 4329090 | stuk | 5,10 | 210 | 0 |
| <hr/> | | | | | | | | |
| Utiliteit | Flexibele slang 35cm | | | | | | | |
| | 4329007 | 10x12mm | knel/knel | 4329007 | stuk | 4,41 | 210 | 0 |
| | 4329030 | 12x12mm | knel/knel | 4329030 | stuk | 4,41 | 210 | 0 |
| | 4329015 | 10x15mm | knel/knel | 4329015 | stuk | 5,20 | 210 | 0 |
| | 4329032 | 15x15mm | knel/knel | 4329032 | stuk | 5,90 | 210 | 0 |
| | 4329023 | 12mmx3/8" | knel/binnendraad | 4329023 | stuk | 3,52 | 210 | 0 |
| | 4320022 | 12mmx1/2" | knel/binnendraad | 4320022 | stuk | 3,70 | 210 | 0 |
| | 4329029 | 15x1/2" | knel/binnendraad | 4329029 | stuk | 4,41 | 210 | 0 |
| | 4329034 | 3/8"x3/8" | binnendraad/binnendraad | 4329034 | stuk | 2,66 | 210 | 0 |
| | 4329040 | 1/2"x1/2" | binnendraad/binnendraad | 4329040 | stuk | 2,98 | 210 | 0 |
| <hr/> | | | | | | | | |
| Flexibele slang 50cm | | | | | | | | |
| | 0440478 | 10x10mm | knel GL Kiwa | 0440478 | stuk | 3,94 | 210 | 0 |
| | 0440007 | 10x10mm | knelxknel | 0440007 | stuk | 5,10 | 210 | 0 |
| | 4329036 | 12x12mm | knel/knel | 4329036 | stuk | 4,86 | 210 | 0 |
| | 4329038 | 15x15mm | knel/knel | 4329038 | stuk | 6,30 | 210 | 0 |
| | 0440015 | 10x3/8" | glxbinnendraad | 0440015 | stuk | 3,33 | 210 | 0 |
| | 0440013 | 10x1/2" | glxbinnendraad | 0440013 | stuk | 2,60 | 210 | 0 |
| | 1240099 | 10x3/8" | knel/binnendraad | 1240099 | stuk | 3,94 | 210 | 0 |
| | 1240137 | 10x1/2" | knel/binnendraad | 1240137 | stuk | 4,11 | 210 | 0 |
| | 1240080 | 3/8"x1/2" | binnendraad/binnendraad | 1240080 | stuk | 3,24 | 210 | 0 |
| | 1240129 | 1/2"x1/2" | binnendraad/binnendraad | 1240129 | stuk | 3,46 | 210 | 0 |



| Art.nr | Specificaties | Kleur | Lev.nr | Ehd | Prijs | Grp | CC |
|-------------------------------|---------------------|--------|---------|------|-------|-----|----|
| Plieger hoekstopkranen | | | | | | | |
| Design hoekstopkraan | | | | | | | |
| 4058016 | 1/2"x10mm. rond | chroom | 4058016 | stuk | 13,00 | 350 | 0 |
| 4058018 | 1/2"x10mm. rond | inox | 4058018 | stuk | 14,75 | 350 | 0 |
| 4058020 | 1/2"x10mm. vierkant | chroom | 4058020 | stuk | 13,00 | 350 | 0 |
| 4058022 | 1/2"x10mm. vierkant | inox | 4058022 | stuk | 14,75 | 350 | 0 |



Sanitair producten

Baden /
douchebakken /
stoomcabines

Kranen

Doucheapparatuur

Accessoires en
spiegels

Douchewanden

Toebehoren &
afvoeren





Spoel- &
installatiesystemen







Badkamermeubelen
en toiletkasten

Gootstenen en
wastroggen

Utiliteit

| | Art.nr | Specificaties | Kleur | Lev.nr | Ehd | Prijs | Grp | CC |
|---|--|---------------|-------|-----------|------|--------|-----|----|
| Sanitair producten | Schell hoekstopkranen | | | | | | | |
| | Rondo hoekstopkraan m. rozet | | | | | | | |
| | 0440205 | 3/8"x10mm | chrom | 051530699 | stuk | 26,00 | 210 | 0 |
| | 0440206 | 1/2"x10mm | chrom | 051520699 | stuk | 26,00 | 210 | 1 |
| Baden / douchebakken / stoomcabines | Comfort hoekstopkraan m. rozet m. knop | | | | | | | |
| | 0440310 | 1/2"x10mm | chrom | 049170699 | stuk | 6,30 | 210 | 0 |
| Kranen | 0440175 | 3/8"x10mm | chrom | 050980699 | stuk | 6,50 | 210 | 0 |
| | Comfort hoekstopkraan m. rozet m. knop Kiwa | | | | | | | |
| Douchegarnituur | 0440315 | 3/8"x10mm | chrom | 050950699 | stuk | 5,70 | 210 | 0 |
| Accessoires en spiegels | Comfort hoekstopkraan z. rozet m. knop | | | | | | | |
| | 0440671 | 3/8"x10mm | chrom | 050940699 | stuk | 5,80 | 210 | 0 |
| Douchewanden | Comfort hoekstopkraan m. rozet m. filter | | | | | | | |
| | 0440193 | 3/8"x10mm | chrom | 050630699 | stuk | 34,25 | 210 | 1 |
| Toebehoren & afvoeren | Zoom design hoekstopkraan | | | | | | | |
| | 0440160 | | chrom | 053320699 | stuk | 34,75 | 210 | 1 |
| Spoel- & installatiesystemen | Zoom design hoekstopkraan set | | | | | | | |
| | 0440162 | | chrom | 053330699 | stuk | 163,00 | 210 | 1 |
| Badkamermeubelen en toiletkasten | Zoom design hoekstopkraan ensemble | | | | | | | |
| | 0440164 | | chrom | 053340699 | stuk | 239,00 | 210 | 1 |
| Gootstenen en wastroggen | hoekstopkraan m. rozet m. knop verdekt | | | | | | | |
| | 0440191 | 3/8"x10mm | chrom | 051000699 | stuk | 20,50 | 210 | 0 |
| Utiliteit | 0440159 | 1/2"x10mm | chrom | 049450699 | stuk | 21,00 | 210 | 0 |
| | hoekstopkraan m. knop | | | | | | | |
| | 0440256 | 10x12mm | chrom | 050390699 | stuk | 8,70 | 210 | 0 |
| | klemkoppeling | | | | | | | |
| | 0440302 | 3/8"x10mm | chrom | 265000699 | stuk | 1,55 | 210 | 0 |
| | 0440306 | 1/2"x10cm | chrom | 265090699 | stuk | 2,18 | 210 | 0 |
| | 0443638 | 1/2"x12mm | chrom | 265110699 | stuk | 3,78 | 210 | 0 |
| | klemmoer z. dichting | | | | | | | |
| | 0440304 | 1/2"x10mm | chrom | 747120699 | stuk | 1,95 | 210 | 0 |
| | Comfort pakket sterkteam 2xhoekstopkraan | | | | | | | |
| | 0443320 | | | 108660699 | stuk | 46,75 | 210 | 0 |
| | Comfort hoekstopkraan m. RV m. ASAG | | | | | | | |
| | 0440093 | 1/2" | chrom | 035450699 | stuk | 48,25 | 210 | 1 |

| Art.nr | Specificaties | Kleur | Lev.nr | Ehd | Prijs | Grp | CC | | |
|---|----------------|-------|-----------|------|--------|-----|----|---|---|
| | | | | | | | | Schell hoekstopkranen | |
| Comfort hoekstopkraan m. koppeling | | | | | | | | | |
| 1510004 | 3/8"x3/8"kleem | chrom | 050330699 | stuk | 15,25 | 409 | 0 |  | Sanitair producten |
| 1510006 | 1/2"x3/8"kleem | chrom | 050340699 | stuk | 15,00 | 409 | 0 | | Baden / douchebakken / stoomcabines |
| Comfort hoekstopkraan | | | | | | | | | |
| 1510002 | 1/2"x3/8"kleem | chrom | 049120699 | stuk | 12,00 | 409 | 0 |  | Kranen |
| Comfort hoekstopkraan m. koppeling verstelbaar | | | | | | | | | |
| 1510008 | 1/2"x3/8"kleem | chrom | 050450699 | stuk | 18,50 | 409 | 0 | | Douchegarnituur |
| Comfort hoekstopkraan m. filter m. rozet | | | | | | | | | |
| 1510016 | 1/2"x10mm | chrom | 049490699 | stuk | 33,00 | 409 | 1 |  | Accessoires en spiegels |
| Puris hoekstopkraan | | | | | | | | | |
| 0443301 | 1/2"x10mm | chrom | 053110699 | stuk | 122,00 | 210 | 0 |  | Toebehoren & afvoeren |
| Cross hoekstopkraan | | | | | | | | | |
| 0443328 | 1/2"x10mm | chrom | 053100699 | stuk | 112,00 | 210 | 0 |  | Spoel- & installatiesystemen |
| Edition designsifon | | | | | | | | | |
| 0440210 | | chrom | 014290699 | stuk | 177,00 | 210 | 1 | | Badkamermeubelen en toiletkasten |
| Edition designhoekstopkraan 1/2" | | | | | | | | | |
| 0440209 | | chrom | 053200699 | stuk | 47,00 | 210 | 0 | | Gootstenen en wastroggen |
| Edition designset: sifon + 2x hoekstopkraan | | | | | | | | | |
| 0440211 | | chrom | 053210699 | stuk | 184,00 | 210 | 0 | | Utiliteit |
| Edition designset + montageraam | | | | | | | | | |
| 0440212 | | chrom | 053250699 | stuk | 267,00 | 210 | 0 | | |
| muurbuis 32mm lengte=40cm | | | | | | | | | |
| 0440214 | | chrom | 014480699 | stuk | 45,50 | 210 | 1 | | |
| Classic hoekstopkraan 1/2"x10mm m. rozet | | | | | | | | | |
| 0440204 | | chrom | 051720699 | stuk | 23,75 | 210 | 0 | | |
| Quick adapter m. ASAG | | | | | | | | | |
| 0440095 | 1/2"x35mm | chrom | 007000699 | stuk | 8,60 | 210 | 1 | | |
| 0440096 | 1/2"x55mm | chrom | 007010699 | stuk | 9,80 | 210 | 1 | | |
| 0440097 | 1/2"x70mm | chrom | 007020699 | stuk | 12,25 | 210 | 1 | | |
| Quick spoeladapter messing | | | | | | | | | |
| 0440099 | 3/4" | | 007030099 | stuk | 22,00 | 210 | 1 | | |
| Quick verlenging voor hoekstopkraan 20mm | | | | | | | | | |
| 0440098 | | chrom | 007040699 | stuk | 7,10 | 210 | 1 | | |

| | Art.nr | Specificaties | Kleur | Lev.nr | Ehd | Prijs | Grp | CC | |
|---|---|---|--|-----------|-----------|-----------|-------|------|-----|
| | Schell hoekstopkranen | | | | | | | | |
| Sanitair producten |  | flexibele slang 30cm 0440471 3/8"x3/8" | klemkopp./klemmoer | 090490630 | stuk | 8,20 | 210 | 1 | |
| | | 0440475 1/2"x10mm | | 090160699 | stuk | 7,90 | 210 | 0 | |
| Baden / douchebakken / stoomcabines |  | flexibele slang 40cm 0440486 3/8"x3/8" | | 090500699 | stuk | 10,50 | 210 | 0 | |
| | | flexibele slang 50cm 0440479 3/8"x1/2" | | 090340699 | stuk | 10,50 | 210 | 1 | |
| Kranen |  | wandaansluitbocht 1/2" 0440203 | | 064630699 | stuk | 13,75 | 210 | 1 | |
| | Douchegarnituur |  | aansluitpijp m. kraag 3/8" 0440002 1/2"x30cm | chrom | 500000699 | stuk | 2,80 | 210 | 0 |
| | | 0440280 1/2"x50cm | chrom | 500020699 | stuk | 4,00 | 210 | 0 | |
| | | 0440285 1/2"x100cm | chrom | 500070699 | stuk | 8,90 | 210 | 0 | |
| Douchewanden |  | aansluitpijp 0440663 10mmx1mt | chrom | 487150699 | stuk | 17,75 | 210 | 0 | |
| | Toebehoren & afvoeren |  | flexibele slang 50cm 0440477 3/8"x10mm | chrom | 090020699 | stuk | 5,70 | 210 | 1 |
| Spoel- & installatiesystemen | |  | flexibele slang 30cm 0440481 3/8"x3/8" | klem/klem | chrom | 090490699 | stuk | 9,00 | 210 |
| | Badkamermeubelen en toiletkasten | | roodkoperen buis op rol 0440101 10x5000mm | chrom | 487410699 | stuk | 68,00 | 210 | 1 |
| Gootstenen en wastroggen | | | bevestigingsset voor stopkraan 0440100 | | 614260099 | stuk | 8,40 | 210 | 0 |
| | Utiliteit | | | | | | | | |

| Art.nr | Specificaties | Kleur | Lev.nr | Ehd | Prijs | Grp | CC |
|--|---------------|-------|---------|------|-------|-----|----|
| VSH kraanaansluitingen | | | | | | | |
| messing klemkoppeling | | | | | | | |
| 8921911 | 10x10mm | | 0860090 | stuk | 7,30 | 847 | 0 |
| 8922489 | 12x10mm | | 0873103 | stuk | 6,70 | 847 | 0 |
| 8922195 | 15x10mm | | 0873136 | stuk | 8,60 | 847 | 0 |
| messing klempuntstuk buitendraad | | | | | | | |
| 8922497 | 3/8"x10mm | | 0861201 | stuk | 7,70 | 847 | 0 |
| 8920003 | 1/2"x10mm | | 0861267 | stuk | 9,00 | 847 | 0 |
| messing klem schroefbus lange binnendraad | | | | | | | |
| 8920005 | 1/2"x10mm | | 0862389 | stuk | 9,00 | 847 | 0 |
| messing klem kniekoppeling | | | | | | | |
| 8922233 | 10x10mm | | 0863192 | stuk | 11,25 | 847 | 0 |
| 8922500 | 12x10mm | | 0863456 | stuk | 9,80 | 847 | 0 |
| 8922187 | 15x10mm | | 0863379 | stuk | 13,00 | 847 | 0 |
| nikkelen klemkoppeling | | | | | | | |
| 8922527 | 10x10mm | | 0860411 | stuk | 8,50 | 847 | 0 |
| 8922276 | 12x10mm | | 0873631 | stuk | 7,70 | 847 | 0 |
| 8922535 | 15x10mm | | 0873642 | stuk | 10,00 | 847 | 0 |
| nikkelen klempuntstuk buitendraad | | | | | | | |
| 8922284 | 3/8"x10mm | | 0874104 | stuk | 8,20 | 847 | 0 |
| nikkelen klem kniekoppeling | | | | | | | |
| 8922306 | 10x10mm | | 0863115 | stuk | 13,00 | 847 | 0 |
| 8922543 | 12x10mm | | 0874049 | stuk | 11,50 | 847 | 0 |
| 8922551 | 15x10mm | | 0863381 | stuk | 15,25 | 847 | 0 |
| messing klem ring | | | | | | | |
| 8922721 | 10mm | | 0877327 | stuk | 1,05 | 847 | 0 |
| S-koppeling afsluitbaar | | | | | | | |
| 0491889 | 1/2"x3/4" | | 6000711 | stuk | 29,75 | 210 | 0 |
| 0491935 | 3/8"x1/2" | | 6000687 | stuk | 23,25 | 210 | 0 |

Sanitair producten

Baden /
douchebakken /
stoomcabines

Kranen

Douchegarnituur

Accessoires en
spiegels

Douchewanden

Toebehoren &
afvoerenSpoel- &
installatiesystemenBadkamermeubelen
en toiletkastenGootstenen en
wastroggen

Utiliteit

Sanitair producten

Baden /
douchebakken /
stoomcabines

Kranen

Douchegarnituur

Accessoires en
spiegels

Douchewanden

Toebehoren &
afvoeren

Spoel- &
installatiesystemen

Badkamermeubelen
en toiletkasten

Gootstenen en
wastroggen

Utiliteit

Doucheapparatuur

| | |
|----------------------------------|-----|
| Doucheapparatuur Best Saver | 714 |
| Doucheapparatuur Dornbracht | 716 |
| Doucheapparatuur Geesa | 725 |
| Doucheapparatuur Gessi | 726 |
| Doucheapparatuur Grohe | 736 |
| Doucheapparatuur Haceka | 746 |
| Doucheapparatuur Hansa | 747 |
| Doucheapparatuur Hansgrohe | 756 |
| Doucheapparatuur Ideal Standard | 772 |
| Doucheapparatuur Jado | 774 |
| Doucheapparatuur Kludi | 776 |
| Doucheapparatuur KWC | 786 |
| Doucheapparatuur Oras | 787 |
| Doucheapparatuur Plieger | 788 |
| Doucheapparatuur Pharo | 790 |
| Doucheapparatuur Seppelfricke | 791 |
| Doucheapparatuur Sphinx | 792 |
| Doucheapparatuur Venlo | 793 |
| Doucheapparatuur Villeroy & Boch | 795 |
| Douchepanelen Grohe | 797 |
| Douchepanelen Hansa | 798 |
| Douchepanelen Kludi | 799 |
| Douchepanelen Pharo | 800 |

Doucheapparatuur

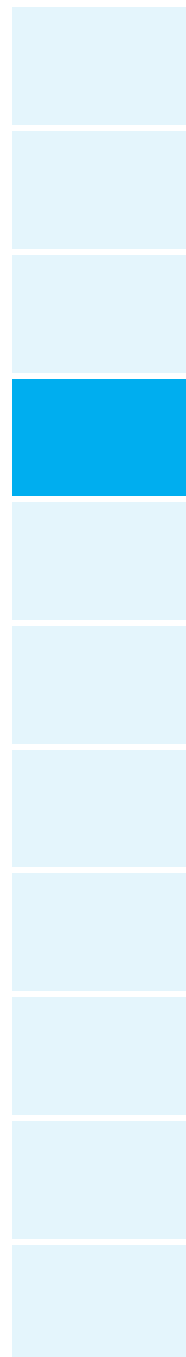

| | Art.nr | Specificaties | Kleur | Lev.nr | Ehd | Prijs | Grp | CC |
|---|------------------------------|----------------------------------|-------|--------|------|-------|-----|----|
| Sanitair producten | Best Saver handdouche | | | | | | | |
| | 0602418 | handdouche waterbesparend | wit | E2010 | stuk | 13,75 | 250 | 0 |
| Baden / douchebakken / stoomcabines | | | | | | | | |
| Kranen | | | | | | | | |
| Douchegarnituur | | | | | | | | |
| Accessoires en spiegels | | | | | | | | |
| Douchewanden | | | | | | | | |
| Toebehoren & afvoeren | | | | | | | | |
| Spoel- & installatiesystemen | | | | | | | | |
| Badkamermeubelen en toiletkasten | | | | | | | | |
| Gootstenen en wastroggen | | | | | | | | |
| Utiliteit | | | | | | | | |

De Remeha Aquanta:

Maximaal comfort, eindeloos veel warm water

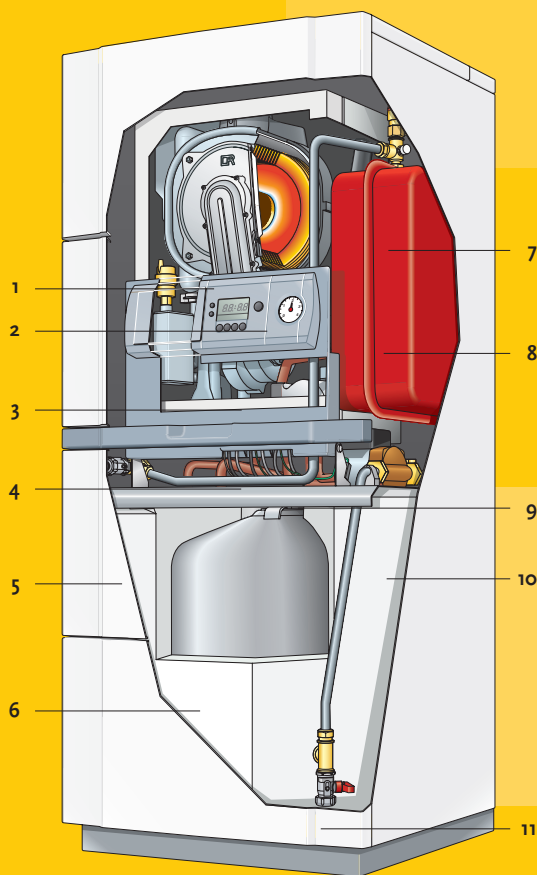

De Aquanta in het kort

- | | | | |
|---|-----------------------|----|--|
| 1 | Warmtewisselaar | 7 | Overstortventiel |
| 2 | Brander | 8 | Expansievat |
| 3 | Bedieningspaneel | 9 | CV-pomp |
| 4 | Ventilator | 10 | Tapwaterpomp |
| 5 | Vul- en aftapkraan CV | 11 | Circulatieleiding 'gelaagd' boilerwater |
| 6 | Boilervat | | |











De nieuwe Remeha Aquanta: In één zeer compacte en fraaie behuizing is zowel een HR-combiketel, een moderne gelaagde boiler én een expansievat ondergebracht. Het toestel voldoet ruimschoots aan de Gaskeur CW6 classificatie en munt uit in het probleemloos gelijktijdig warmwater tappen op meerdere punten. Natuurlijk zorgt de Aquanta ook voor de juiste hoeveelheid water voor luxe massage- of stortdouches. Dus voor al uw klanten die de hoogste eisen stellen aan warmwater comfort is de Aquanta van Remeha dé slimme en compacte oplossing.

Meer weten over de Remeha Aquanta? Bel (055) 549 69 69 of kijk op nl.remeha.com en vraag de speciale documentatie aan.

Remeha B.V.

Postbus 32, 7300 AA Apeldoorn
E-mail remeha@remeha.com
Telefoon (055) 549 69 69
Fax (055) 549 64 96
Internet nl.remeha.com

remeha

| | Art.nr | Specificaties | Kleur | Lev.nr | Ehd | Prijs | Grp | CC | |
|---|---|--|-------------|------------|------|--------|-----|----|--|
| Sanitair producten | Dornbracht Belle de Jour | | | | | | | | |
| | Leverbaar tot 01-07-2007 | | | | | | | | |
| Baden / douchebakken / stoomcabines |  | glijstangset compleet | | | | | | | |
| | | 0470101 | chrom | 2640333000 | stuk | 444,00 | 172 | 1 | |
| Kranen |  | Dornbracht Dreamscape | | | | | | | |
| | | Leverbaar tot 01-07-2007 | | | | | | | |
| Douchegarnituur |  | glijstangset 90cm compleet | | | | | | | |
| | | 0473014 | chrom | 2640348000 | stuk | 446,00 | 172 | 1 | |
| Accessoires en spiegels |  | glijstangset 90cm compleet | | | | | | | |
| | | 0470273 | platina-mat | 2640348006 | stuk | 668,00 | 172 | 1 | |
| Douchewanden |  | handdouche m. wandhouder m. slang | | | | | | | |
| | | 0470274 | platina-mat | 2780348006 | stuk | 548,00 | 172 | 1 | |
| Toebehoren & afvoeren |  | handdouche m. wandhouder m. slang | | | | | | | |
| | | 0473022 | chrom | 2780348006 | stuk | 365,00 | 172 | 1 | |
| Spoel- & installatiesystemen |  | Dornbracht Giorgio | | | | | | | |
| | | Leverbaar tot 01-07-2007 | | | | | | | |
| Badkamermeubelen en toiletkasten |  | douchegarnituur | | | | | | | |
| | | 0473960 | chrom | 2780375000 | stuk | 301,00 | 172 | 1 | |
| Gootstenen en wastroggen |  | glijstangset 90cm compleet | | | | | | | |
| | | 0473952 | chrom | 2640375000 | stuk | 447,00 | 172 | 1 | |
| Utiliteit |  | Dornbracht Lulu | | | | | | | |
| | | handdouche m. slang m. wandhouder | | | | | | | |
| | | 0272552 | chrom | 2780871000 | stuk | 343,00 | 172 | 1 | |
| | | glijstang | | | | | | | |
| | | 0272551 85.5cm | chrom | 2670171000 | stuk | 280,00 | 172 | 1 | |
| | | glijstangset compleet | | | | | | | |
| | | 0272550 85.5cm | chrom | 2640271000 | stuk | 466,00 | 172 | 1 | |

| Art.nr | Specificaties | Kleur | Lev.nr | Ehd | Prijs | Grp | CC | | |
|---|---|-------|------------|------|--------|-----|----|---|---|
| | | | | | | | | Dornbracht Lulu | |
| wandaansluitbocht 1/2" | | | | | | | | | |
| 0272553 | | chrom | 2845071000 | stuk | 84,50 | 172 | 1 |  | Sanitair producten |
| 0272542 | adapter voor doucheuitlaat 3/8" | chrom | 1220297900 | stuk | 25,00 | 172 | 1 | | Baden / douchebakken / stoomcabines |
| handdouchehouder | | | | | | | | | |
| 0272554 | | chrom | 2805071000 | stuk | 113,00 | 172 | 1 |  | Kranen |
| doucheapparatuur voor badrandmontage | | | | | | | | | |
| 0272624 | | chrom | 2770271000 | stuk | 292,00 | 172 | 1 |  | Doucheapparatuur |
| doucheaccessoire voor badrandmontage | | | | | | | | | |
| 0272624 | | chrom | 2770271000 | stuk | 292,00 | 172 | 1 |  | Accessoires en spiegels |
| zijdouche verstelbaar antikalk | | | | | | | | | |
| 0272555 | | chrom | 2851871000 | stuk | 176,00 | 172 | 1 |  | Douchewanden |
| zijdouche m. stopkraan verstelbaar | | | | | | | | | |
| 0272556 | | chrom | 2851971000 | stuk | 236,00 | 172 | 1 |  | Toebehoren & afvoeren |
| hoofddouche m. stopkraan verstelbaar | | | | | | | | | |
| 0272556 | | chrom | 2851971000 | stuk | 236,00 | 172 | 1 |  | Spoel- & installatiesystemen |
| hoofddouche instelbaar | | | | | | | | | |
| 0272557 | | chrom | 2850671000 | stuk | 329,00 | 172 | 1 |  | Badkamermeubelen en toiletkasten |
| hoofddouche instelbaar | | | | | | | | | |
| 0272557 | | chrom | 2850671000 | stuk | 329,00 | 172 | 1 |  | Gootstenen en wastroggen |
| regendouche wandmodel 45cm | | | | | | | | | |
| 0272558 | | chrom | 2854871000 | stuk | 468,00 | 172 | 1 |  | Utiliteit |
| 0472529 | plafondbevestiging voor hoofddouche 200mm | chrom | 1255697000 | stuk | 171,00 | 172 | 1 | | |
| regendouche wandmodel 60cm | | | | | | | | | |
| 0272559 | | chrom | 2855871000 | stuk | 482,00 | 172 | 1 | | |
| 0472529 | plafondbevestiging voor hoofddouche 200mm | chrom | 1255697000 | stuk | 171,00 | 172 | 1 | | |
| regendouche plafond 20cm | | | | | | | | | |
| 0272560 | | chrom | 2856871000 | stuk | 355,00 | 172 | 1 | | |

| | Art.nr | Specificaties | Kleur | Lev.nr | Ehd | Prijs | Grp | CC |
|---|---|---|----------------|------------|------|--------|-----|----|
| Sanitair producten | Dornbracht Madison | | | | | | | |
| | | handdouche m. porselein greep | | | | | | |
| | 0470148 | | wit/chroom | 2800297000 | stuk | 153,00 | 172 | 1 |
| | 0470219 | | wit/platin mat | 2800297006 | stuk | 201,00 | 172 | 1 |
| Baden / douchebakken / stoomcabines | wanddouchehouder | | | | | | | |
| | | | | | | | | |
| | 0473294 | | chroom | 2805041000 | stuk | 100,00 | 172 | 1 |
| | 0472582 | | platina-mat | 2805041006 | stuk | 150,00 | 172 | 1 |
| Kranen | hoofddouche verstelbaar | | | | | | | |
| | | | | | | | | |
| | 0470149 | | chroom | 2850597000 | stuk | 330,00 | 172 | 1 |
| | 0470221 | | platina-mat | 2850597006 | stuk | 495,00 | 172 | 1 |
| Douchegarnituur | douchegarnituur | | | | | | | |
| | | | | | | | | |
| | 0473286 | | chroom | 2780336000 | stuk | 340,00 | 172 | 1 |
| | 0470218 | | platina-mat | 2780336006 | stuk | 512,00 | 172 | 1 |
| Accessoires en spiegels | glijstangset 90cm compleet | | | | | | | |
| | | | | | | | | |
| | 0470147 | | chroom | 2640336000 | stuk | 452,00 | 172 | 1 |
| | 0470217 | | platina-mat | 2640336006 | stuk | 689,00 | 172 | 1 |
| | 0470740 | | messing | 2640336009 | stuk | 689,00 | 172 | 1 |
| Douchewanden | wandaansluitbocht 1/2" | | | | | | | |
| | | | | | | | | |
| | 0470586 | | chroom | 2845041000 | stuk | 52,50 | 172 | 1 |
| | 0470220 | | platina-mat | 2845041006 | stuk | 85,50 | 172 | 1 |
| Toebehoren & afvoeren | Dornbracht Mem | | | | | | | |
| | | | | | | | | |
| | 0474559 | handdouche m. slang, aansluitbocht en wandhouder | chroom | 2780878000 | stuk | 354,00 | 172 | 1 |
| Spoel- & installatiesystemen | handdouche m. wandhouder m. afdekplaat | | | | | | | |
| | | | | | | | | |
| | 0474560 | | chroom | 2781878000 | stuk | 424,00 | 172 | 1 |
| Badkamermeubelen en toiletkasten | glijstangset 85cm compleet | | | | | | | |
| | | | | | | | | |
| | 0474558 | | chroom | 2640278000 | stuk | 492,00 | 172 | 1 |
| Gootstenen en wastroggen | | | | | | | | |
| Utiliteit | | | | | | | | |
| | | | | | | | | |

| Art.nr | Specificaties | Kleur | Lev.nr | Ehd | Prijs | Grp | CC | |
|---|---------------|-------------|------------|------|--------|-----|----|---|
| Dornbracht Mem | | | | | | | | |
| inbouwdouchegarnituur H=16cm | | | | | | | | |
| 0474552 | | chroom | 2770978000 | stuk | 319,00 | 172 | 1 |  |
| douchehouder | | | | | | | | |
| 0474562 | | chroom | 2805078000 | stuk | 116,00 | 172 | 1 |  |
| wandaansluitbocht 1/2" | | | | | | | | |
| 0474561 | | chroom | 2845078000 | stuk | 87,00 | 172 | 1 |  |
| 0433124 | | platina | 2845078008 | stuk | 131,00 | 172 | 1 | |
| 0433125 | | platina-mat | 2845078006 | stuk | 131,00 | 172 | 1 | |
| zijdouche 1/2" m. rozet | | | | | | | | |
| 0474704 | | chroom | 2851878000 | stuk | 191,00 | 172 | 1 |  |
| zijdouche 1/2" m. rozet m. stopkraan | | | | | | | | |
| 0474705 | | chroom | 2851978000 | stuk | 250,00 | 172 | 1 |  |
| regendouche m. wandbevestiging 45cm | | | | | | | | |
| 0474567 | | chroom | 2854878000 | stuk | 482,00 | 172 | 1 |  |
| regendouche m. wandbevestiging 60cm | | | | | | | | |
| 0474569 | | chroom | 2855878000 | stuk | 497,00 | 172 | 1 | |
| regendouche plafondbevestiging | | | | | | | | |
| 0474570 | | chroom | 2856878000 | stuk | 366,00 | 172 | 1 |  |
| Dornbracht Meta | | | | | | | | |
| wandaansluitbocht 1/2" | | | | | | | | |
| 0471653 | | chroom | 2845061000 | stuk | 40,50 | 172 | 1 |  |
| 0470166 | | platina-mat | 2845061006 | stuk | 61,00 | 172 | 1 | |
| glijstangset 90cm compleet | | | | | | | | |
| 0472468 | | chroom | 2640361000 | stuk | 337,00 | 172 | 1 |  |
| 0470164 | | platina-mat | 2640361006 | stuk | 505,00 | 172 | 1 | |

Sanitair producten

Baden /
douchebakken /
stoomcabines

Kranen

Douchegarnituur









Accessoires en
spiegels

Douchewanden

Toebehoren &
afvoerenSpoel- &
installatiesystemenBadkamermeubelen
en toiletkastenGootstenen en
wastroggen

Utiliteit

| | Art.nr | Specificaties | Kleur | Lev.nr | Ehd | Prijs | Grp | CC |
|---|--|---|----------------|------------|------|---------|-----|----|
| Sanitair producten | Dornbracht Meta.02 | | | | | | | |
| | douchegarnituur compleet | | | | | | | |
| | 0471654 | | chrom | 2640362500 | stuk | 431,00 | 172 | 1 |
| | 0470135 | | platina-mat | 2640362506 | stuk | 625,00 | 172 | 1 |
| Baden / douchebakken / stoomcabines | Dornbracht RainSky | | | | | | | |
| Kranen | plafonddouche | | | | | | | |
| | 0433138 | 102x82cm | RVS-gepolijst | 4110097985 | stuk | 6441,00 | 172 | 1 |
| | 0433139 | 102x82cm | RVS-geborsteld | 4110097986 | stuk | 6441,00 | 172 | 1 |
| | 0433051 | Xtool inbouwmoduul 3-stopkranen | | 3553697090 | stuk | 1002,00 | 172 | 0 |
| | 0472671 | inbouwdeel voor stopkraan koud 1/2" | | 3562197090 | stuk | 62,50 | 172 | 0 |
| Douchegarnituur | 0472672 | inbouwdeel voor stopkraan warm 1/2" | | 3567197090 | stuk | 62,50 | 172 | 0 |
| | 0474606 | X-tool inbouwmoduul thermostatisch 3-uitlaten | | 3553597090 | stuk | 981,00 | 172 | 1 |
| | 0474649 | X-tool inbouwthermostaat z. stopkraan 3/4" | | 3551297090 | stuk | 712,00 | 172 | 1 |
| | 0474651 | Xtool inbouwdeel voor inbouwthermostaat z. stopkraan 3/4" | | 3551697090 | stuk | 712,00 | 172 | 0 |
| | Accessoires en spiegels | Bigrain regenpaneel plafondbevestiging | | | | | | |
| 0272595 | | | RVS gepolijst | 4140097985 | stuk | 2874,00 | 172 | 1 |
| 0272596 | | | RVS geborsteld | 4140097986 | stuk | 2874,00 | 172 | 1 |
| Douchewanden | Bigrain afdekplaat | | | | | | | |
| | 0272597 | 125x50mm | RVS gepolijst | 1294097985 | stuk | 242,00 | 172 | 1 |
| | 0272598 | 125x50mm | RVS geborsteld | 1294097986 | stuk | 242,00 | 172 | 1 |
| Toebehoren & afvoeren | Justrain regendouche plafondbevestiging | | | | | | | |
| | 0272599 | | RVS gepolijst | 4150097985 | stuk | 1701,00 | 172 | 1 |
| | 0272600 | | RVS geborsteld | 4150097986 | stuk | 1701,00 | 172 | 1 |
| Spool- & installatiesystemen | Justrain afdekplaat | | | | | | | |
| | 0272601 | 125x50mm | RVS gepolijst | 1295097985 | stuk | 196,00 | 172 | 1 |
| | 0272602 | 125x50mm | RVS geborsteld | 1295097986 | stuk | 196,00 | 172 | 1 |
| Badkamermeubelen en toiletkasten | Dornbracht Tara | | | | | | | |
| | handdouche waterbesparend | | | | | | | |
| | 0471631 | | chrom | 2800222000 | stuk | 118,00 | 172 | 0 |
| | 0470099 | | platina-mat | 2800222006 | stuk | 201,00 | 172 | 1 |
| Gootstenen en wastroggen | 0471635 | | platina-mat | 2800222008 | stuk | 201,00 | 172 | 1 |
| | wanddouchehouder | | | | | | | |
| | 0470611 | | chrom | 2805089000 | stuk | 95,00 | 172 | 0 |
| Utiliteit | 0476293 | | platina-mat | 2805089006 | stuk | 152,00 | 172 | 1 |
| | handdouche m. slang m. wandhouder | | | | | | | |
| | 0471644 | | chrom | 2780389000 | stuk | 299,00 | 172 | 0 |
| | 0471647 | | platina-mat | 2780389006 | stuk | 448,00 | 172 | 1 |
| hoofddouche 3-standen | | | | | | | | |
| | 0472528 | | chrom | 2850697000 | stuk | 330,00 | 172 | 0 |
| glijstang 90cm z. garnituur | | | | | | | | |
| | 0290051 | | chrom | 2670189000 | stuk | 267,00 | 172 | 1 |
| | 0471646 | | platina-mat | 2670189006 | stuk | 400,00 | 172 | 1 |

| Art.nr | Specificaties | Kleur | Lev.nr | Ehd | Prijs | Grp | CC | | |
|--|---------------|-------------|------------|------|---------|-----|----|---|---|
| | | | | | | | | Dornbracht Tara Classic | |
| glijstangset 90cm compleet | | | | | | | | | |
| 0471633 | | chroom | 2640389000 | stuk | 444,00 | 172 | 0 |  | Sanitair producten |
| 0470032 | | platina-mat | 2640389006 | stuk | 666,00 | 172 | 1 | | |
| | | | | | | | | Dornbracht Universeel | |
| handdouche verstelbaar | | | | | | | | | |
| 0472761 | | chroom | 2800597000 | stuk | 118,00 | 172 | 1 |  | Baden / douchebakken / stoomcabines |
| handdouche m. slang m. wanddouchehouder | | | | | | | | | |
| 0470043 | | chroom | 2780561000 | stuk | 209,00 | 172 | 1 |  | Kranen |
| 0470165 | | platina-mat | 2780561006 | stuk | 313,00 | 172 | 1 | | |
| handdouche staafmodel | | | | | | | | | |
| 0474406 | | chroom | 2801097900 | stuk | 124,00 | 172 | 1 |  | Accessoires en spiegels |
| 0474407 | | platina-mat | 2801097906 | stuk | 211,00 | 172 | 1 | | |
| wandhouder voor handdouche | | | | | | | | | |
| 0470065 | | chroom | 2805061000 | stuk | 73,00 | 172 | 1 |  | Douchewanden |
| 0470167 | | platina-mat | 2805061006 | stuk | 110,00 | 172 | 1 | | |
| douchegarnituur compleet | | | | | | | | | |
| 0474404 | | chroom | 2780289000 | stuk | 305,00 | 172 | 0 |  | Toebehoren & afvoeren |
| 0474405 | | platina-mat | 2780289006 | stuk | 458,00 | 172 | 1 | | |
| douchegarnituur voor badrandmontage | | | | | | | | | |
| 0474402 | | chroom | 2770297900 | stuk | 290,00 | 172 | 1 |  | Spoel- & installatiesystemen |
| 0474403 | | platina-mat | 2770297906 | stuk | 400,00 | 172 | 1 | | |
| glijstang m. regendouche | | | | | | | | | |
| 0473345 | | chroom | 2760389000 | stuk | 1102,00 | 172 | 1 |  | Badkamermeubelen en toiletkasten |
| 0471648 | | platina-mat | 2760389006 | stuk | 1653,00 | 172 | 1 | | |
| glijstang m. regendouche hoek | | | | | | | | | |
| 0471649 | | chroom | 2761389000 | stuk | 1102,00 | 172 | 1 |  | Gootstenen en wastroggen |
| 0471650 | | platina-mat | 2761389006 | stuk | 1653,00 | 172 | 1 | | |

Sanitair producten

Baden /
douchebakken /
stoomcabines

Kranen

Douchegarnituur











Accessoires en
spiegels

Douchewanden

Toebehoren &
afvoerenSpoel- &
installatiesystemenBadkamermeubelen
en toiletkastenGootstenen en
wastroggen

Utiliteit

| | Art.nr | Specificaties | Kleur | Lev.nr | Ehd | Prijs | Grp | CC | |
|---|---|---------------|-------------|------------|------------|--------|-------|-----|---|
| Sanitair producten | Dornbracht Universeel | | | | | | | | |
| | glijstangset compleet | | | | | | | | |
| | 0474422 | | chroom | 2640289000 | stuk | 450,00 | 172 | 1 | |
| Baden / douchebakken / stoomcabines | 0474423 | | platina-mat | 2640289006 | stuk | 675,00 | 172 | 1 | |
| | <hr/> | | | | | | | | |
| Kranen | wandaansluitbocht 1/2" m. rozet | | | | | | | | |
| | 0472603 | | chroom | 2845089000 | stuk | 44,50 | 172 | 0 | |
| Douchegarnituur | 0470030 | | platina-mat | 2845089006 | stuk | 67,00 | 172 | 1 | |
| | <hr/> | | | | | | | | |
| Accessoires en spiegels | kneipp-wandaansluitbocht | | | | | | | | |
| | 0433130 | | chroom | 2848597900 | stuk | 178,00 | 172 | 1 | |
| | 0433131 | | platina-mat | 2848597906 | stuk | 267,00 | 172 | 1 | |
| Douchewanden | 0433132 | | platina | 2848597908 | stuk | 267,00 | 172 | 1 | |
| | <hr/> | | | | | | | | |
| | kneipp-wandaansluitbocht m. wandhouder m. rozet | | | | | | | | |
| Toebehoren & afvoeren | 0433133 | | chroom | 2782097900 | stuk | 234,00 | 172 | 1 | |
| | 0433134 | | platina-mat | 2782097906 | stuk | 351,00 | 172 | 1 | |
| | 0433135 | | platina | 2782097908 | stuk | 351,00 | 172 | 1 | |
| <hr/> | | | | | | | | | |
| Spoel- & installatiesystemen | kneipp-wandaansluitbocht m. wandhouder m. afdekplaat | | | | | | | | |
| | 0433143 | | chroom | 2782597900 | stuk | 304,40 | 172 | 1 | |
| Badkamermeubelen en toiletkasten | 0433144 | | platina-mat | 2782597906 | stuk | 456,50 | 172 | 1 | |
| | <hr/> | | | | | | | | |
| | kneipp slang | | | | | | | | |
| | 0433145 | 200cm | | wit | 2828597912 | stuk | 49,30 | 172 | 1 |
| | 0433146 | 200cm | | zwart | 2828597913 | stuk | 49,30 | 172 | 1 |
| 0433147 | 112cm | | wit | 2828097912 | stuk | 38,70 | 172 | 1 | |
| 0433148 | 112cm | | zwart | 2828097913 | stuk | 38,70 | 172 | 1 | |
| <hr/> | | | | | | | | | |
| Gootstenen en wastroggen | zijdouche met kogelgewricht | | | | | | | | |
| | 0472763 | | chroom | 2851697000 | stuk | 174,00 | 172 | 1 | |
| Utiliteit | 0472730 | | platina-mat | 2851697006 | stuk | 261,00 | 172 | 1 | |
| | <hr/> | | | | | | | | |
| | zijdouche m. debietregeling | | | | | | | | |
| | 0472700 | | chroom | 2851797000 | stuk | 237,00 | 172 | 1 | |
| | 0470275 | | platina-mat | 2851797006 | stuk | 355,00 | 172 | 1 | |
| <hr/> | | | | | | | | | |
| | zijdouche z. stopkraan | | | | | | | | |
| | 0433114 | | chroom | 2851897900 | stuk | 184,00 | 172 | 1 | |
| | 0433115 | | platina-mat | 2851897906 | stuk | 276,00 | 172 | 1 | |
| | 0433116 | | platina | 2851897908 | stuk | 276,00 | 172 | 1 | |
| <hr/> | | | | | | | | | |
| | zijdouche m. stopkraan | | | | | | | | |
| | 0433117 | | chroom | 2851997900 | stuk | 243,00 | 172 | 1 | |
| | 0433118 | | platina-mat | 2851997906 | stuk | 364,00 | 172 | 1 | |
| | 0433119 | | platina | 2851997908 | stuk | 364,00 | 172 | 1 | |

| Art.nr | Specificaties | Kleur | Lev.nr | Ehd | Prijs | Grp | CC | |
|---|-------------------------|-------------|---------------|------|--------|-----|----|---|
| | | | | | | | | Dornbracht Universeel |
| douchewandhouder glijstang | | | | | | | | |
| 0476000 | | chroom | 0530125000000 | stuk | 70,00 | 172 | 1 | |
| hoofddouche verstelbaar | | | | | | | | |
| 0470006 | | chroom | 2850797000 | stuk | 330,00 | 172 | 1 |  |
| 0470276 | | platina-mat | 2850797006 | stuk | 495,00 | 172 | 1 | |
| 0470039 | | platina-mat | 2850697006 | stuk | 495,00 | 172 | 1 | |
| regendouche m. wandbevestiging | | | | | | | | |
| 0433021 | sprong 450mm | chroom | 2854897000 | stuk | 476,00 | 172 | 0 |  |
| 0472706 | sprong 450mm | platina-mat | 2854897006 | stuk | 715,00 | 172 | 1 | |
| regendouche plafondbevestiging | | | | | | | | |
| 0470578 | | chroom | 2856897000 | stuk | 360,00 | 172 | 0 |  |
| 0470031 | | platina-mat | 2856897006 | stuk | 540,00 | 172 | 1 | |
| plafondbevestiging voor hoofddouche 200mm | | | | | | | | |
| 0472529 | | chroom | 1255697000 | stuk | 171,00 | 172 | 1 |  |
| 0472707 | | platina-mat | 1255697006 | stuk | 248,00 | 172 | 1 | |
| regendouche m. wandbevestiging | | | | | | | | |
| 0472708 | 600mm | chroom | 2855897000 | stuk | 491,00 | 172 | 1 |  |
| 0472710 | 600mm | platina-mat | 2855897006 | stuk | 737,00 | 172 | 1 | |
| regendouche | | | | | | | | |
| 0474445 | sprong 450mm | chroom | 2854597700 | stuk | 614,00 | 172 | 1 |  |
| 0474446 | sprong 450mm | platina-mat | 2854597706 | stuk | 921,00 | 172 | 1 | |
| 0474447 | sprong 600mm | chroom | 2855597700 | stuk | 633,00 | 172 | 1 | |
| 0474448 | sprong 600mm | platina-mat | 2855597706 | stuk | 949,00 | 172 | 1 | |
| regendouche plafondbevestiging | | | | | | | | |
| 0474449 | | chroom | 2856597700 | stuk | 464,00 | 172 | 1 |  |
| 0474450 | | platina-mat | 2856597706 | stuk | 696,00 | 172 | 1 | |
| douchethermostaat 1/2" z. hendel m. koppelingen | | | | | | | | |
| 0472522 | | chroom | 3442097000 | stuk | 468,00 | 172 | 0 |  |
| 0470049 | | messaging | 3442097009 | stuk | 703,00 | 172 | 1 | |
| 0471637 | | platina-mat | 3442097006 | stuk | 703,00 | 172 | 1 | |
| 0471620 | schaalgreep platina-mat | | 1142089006 | stuk | 211,00 | 172 | 1 |  |
| 0472719 | temperatuurgreep chroom | | 1142022000 | stuk | 141,00 | 172 | 1 | |
| kleurset voor badafvoer-, overloop- en vulcombinatie | | | | | | | | |
| 0470610 | | chroom | 3622697000 | stuk | 153,00 | 172 | 1 |  |
| 0471622 | | platina-mat | 3622697006 | stuk | 244,00 | 172 | 1 | |
| 0470334 | | messaging | 3622697009 | stuk | 244,00 | 172 | 1 | |

Sanitair producten

Baden /
douchebakken /
stoomcabines

Kranen

Douchegarnituur

Accessoires en
spiegels

Douchewanden





Toebehoren &
afvoeren



Spoel- &
installatiesystemen

Badkamermeubelen
en toiletkasten

Gootstenen en
wastroggen

Utiliteit

| | Art.nr | Specificaties | Kleur | Lev.nr | Ehd | Prijs | Grp | CC |
|---|---|---------------|-------------|------------|------|--------|-----|----|
| Sanitair producten | Dornbracht Universeel | | | | | | | |
| | gordijnring voor regendouche | | | | | | | |
| | 0475054 | | chrom | 1255097900 | stuk | 642,30 | 172 | 1 |
| | 0475055 | | platina mat | 1255097906 | stuk | 963,60 | 172 | 1 |
| Baden / douchebakken / stoomcabines |  | | | | | | | |
| Kranen | glijstangset compleet | | | | | | | |
| | 0475058 | 85.5cm | chrom | 2640262500 | stuk | 436,50 | 172 | 1 |
| | 0475059 | 85.5cm | platina mat | 2640262506 | stuk | 633,00 | 172 | 1 |
| |  | | | | | | | |
| Douchegarnituur | glijstang m. houder | | | | | | | |
| | 0475060 | 85.5cm | chrom | 2670162500 | stuk | 261,80 | 172 | 1 |
| | 0475061 | 85.5cm | platina mat | 2670162506 | stuk | 379,70 | 172 | 1 |
| Accessoires en spiegels | handdouche m. slang m. wandhouder | | | | | | | |
| | 0475062 | | chrom | 2780562500 | stuk | 202,40 | 172 | 1 |
| | 0475063 | | platina mat | 2780562506 | stuk | 303,60 | 172 | 1 |
| |  | | | | | | | |
| Douchewanden | staafhouder m. slang m. wandhouder | | | | | | | |
| | 0475064 | | chrom | 2780662500 | stuk | 208,50 | 172 | 1 |
| | 0475065 | | platina mat | 2780662506 | stuk | 312,90 | 172 | 1 |
| |  | | | | | | | |
| Toebehoren & afvoeren | douchehouder m. rozet | | | | | | | |
| | 0475066 | | chrom | 2805062500 | stuk | 82,50 | 172 | 1 |
| | 0475067 | | platina mat | 2805062506 | stuk | 123,80 | 172 | 1 |
| |  | | | | | | | |
| Badkamermeubelen en toiletkasten | | | | | | | | |
| Gootstenen en wastroggen | | | | | | | | |
| Utiliteit | | | | | | | | |

| Art.nr | Specificaties | Kleur | Lev.nr | Ehd | Prijs | Grp | CC | |
|---|----------------------|-----------|--------|------|--------|-----|----|---|
| Geesa 5000 | | | | | | | |  |
| handdouche m. verstelbare straal chroom 0651079 | | chroom | 5221 | stuk | 29,50 | 241 | 1 | |
| Geesa Argos | | | | | | | |  |
| glijstang 60cm z. garnituur 0650471 | | chroom | 522560 | stuk | 55,00 | 241 | 1 | |
| Geesa Argos | | | | | | | | |
| glijstangset 0650095 | m. clips matchr+goud | chroom | 802502 | stuk | 74,50 | 241 | 1 | |
| 0650096 | m. clips chr. + goud | matchroom | 802505 | stuk | 74,50 | 241 | 1 | |
| Geesa Circles | | | | | | | | |
| glijstangset 0650086 | | chroom | 602502 | stuk | 149,00 | 241 | 1 | |
| handdouchehouder 0650094 | | chroom | 2125 | stuk | 8,00 | 241 | 1 | |

Sanitair producten

Baden /
douchebakken /
stoomcabines

Kranen

Douchegarnituur

Accessoires en
spiegels

Douchewanden

Toebehoren &
afvoeren

Spoel- &
installatiesystemen

Badkamermeubelen
en toiletkasten

Gootstenen en
wastroggen

Utiliteit

| | Art.nr | Specificaties | Kleur | Lev.nr | Ehd | Prijs | Grp | CC |
|---|--|---------------|------------|----------|------|---------|-----|----|
| Sanitair producten | Gessi Universeel | | | | | | | |
| | glijstangset 60cm compleet m. muuraansluiting | | | | | | | |
| | 0463620 | | chrom | 14303031 | stuk | 293,00 | 169 | 1 |
| | 0460522 | | inox | 14303142 | stuk | 396,00 | 169 | 1 |
| Baden / douchebakken / stoomcabines | glijstangset 60cm compleet z. muuraansluiting | | | | | | | |
| | 0462284 | | chrom | 14309031 | stuk | 274,00 | 169 | 0 |
| | 0460523 | | inox | 14309142 | stuk | 369,00 | 169 | 1 |
| Kranen | handdouche staafmodel m. antikalk | | | | | | | |
| | 0464376 | | chrom | 14372031 | stuk | 53,50 | 169 | 0 |
| | 0464384 | | inox | 14372142 | stuk | 98,00 | 169 | 1 |
| Douchegarnituur | hoofddouche m. antikalk 1/2" | | | | | | | |
| | 0466921 | | chrom | 3805031 | stuk | 135,00 | 169 | 1 |
| | 0463104 | | chrom/goud | 3805081 | stuk | 143,00 | 169 | 1 |
| Accessoires en spiegels | hoofddouche m. antikalk 1/2" verstelbaar, 4 straalsoorten | | | | | | | |
| | 0466948 | | chrom | 3807031 | stuk | 155,00 | 169 | 1 |
| Douchewanden | hoofddouche 1/2" rond | | | | | | | |
| | 0462659 | | chrom | 14333031 | stuk | 763,00 | 169 | 1 |
| | 0463077 | | inox | 14333142 | stuk | 1037,00 | 169 | 1 |
| Toebehoren & afvoeren | hoofddouche 1/2" vierkant | | | | | | | |
| | 0464325 | | chrom | 14336031 | stuk | 802,00 | 169 | 1 |
| Spoel- & installatiesystemen | wanddouchehouder vast | | | | | | | |
| | 0462810 | | chrom | 14321031 | stuk | 20,00 | 169 | 0 |
| | 0463082 | | inox | 14321142 | stuk | 27,25 | 169 | 1 |
| Badkamermeubelen en toiletkasten | wanddouchehouder verstelbaar | | | | | | | |
| | 0463566 | | chrom | 14327031 | stuk | 26,00 | 169 | 1 |
| Badkamermeubelen en toiletkasten | handdouche antikalk | | | | | | | |
| | 0463621 | | chrom | 14370031 | stuk | 52,00 | 169 | 0 |
| | 0463622 | | inox | 14370142 | stuk | 107,00 | 169 | 1 |

| Art.nr | Specificaties | Kleur | Lev.nr | Ehd | Prijs | Grp | CC | | |
|--|---------------|---------------------|----------|----------|---------|--------|-----|---|---|
| | | | | | | | | Gessi Universeel | |
| handdouche antikalk verstelbaar | | | | | | | | | |
| 0463623 | | chroom | 14376031 | stuk | 112,00 | 169 | 0 |  | Sanitair producten |
| handdouche gebogen antikalk | | | | | | | | | |
| 0463625 | | chroom | 12318031 | stuk | 52,00 | 169 | 1 |  | Baden / douchebakken / stoomcabines |
| handdouche gebogen antikalk verstelbaar | | | | | | | | | |
| 0463627 | | chroom | 12324031 | stuk | 112,00 | 169 | 1 |  | Kranen |
| 0463628 | | chroom/satijnchroom | | 12324045 | stuk | 146,00 | 169 | | |
| 1 | | | | | | | | | |
| handdouche m. wandhouder m. aansluiting | | | | | | | | | |
| 0463135 | | chroom | 7755031 | stuk | 97,50 | 169 | 1 |  | Douchegarnituur |
| doucheslang 1/2" | | | | | | | | | |
| 0461301 | 150cm | chroom | 1090031 | stuk | 17,50 | 169 | 0 |  | Accessoires en spiegels |
| 0461302 | 150cm | inox | 1090142 | stuk | 68,50 | 169 | 1 | | |
| 0464821 | 200cm | chroom | 1096031 | stuk | 20,50 | 169 | 1 | | |
| 0461303 | 200cm | inox | 1096142 | stuk | 79,00 | 169 | 1 | | |
| doucheslang 150cm | | | | | | | | | |
| 0461540 | | chroom | 1637031 | stuk | 36,00 | 169 | 1 |  | Douchewanden |
| 0461541 | | inox | 1637142 | stuk | 42,00 | 169 | 1 | | |
| wanddouchehouder verstelbaar | | | | | | | | | |
| 0463083 | | inox | 14327142 | stuk | 29,75 | 169 | 1 |  | Toebehoren & afvoeren |
| handdouchehouder voor badrand | | | | | | | | | |
| 0464260 | | chroom | 14348031 | stuk | 53,00 | 169 | 1 |  | Spoel- & installatiesystemen |
| 0464279 | | inox | 14348142 | stuk | 66,00 | 169 | 1 | | |
| hoofddouche 1/2" vierkant | | | | | | | | | |
| 0464333 | | inox | 14336142 | stuk | 1079,00 | 169 | 1 |  | Badkamermeubelen en toiletkasten |

Douchegarnituur

Accessoires en spiegels

Douchewanden

Toebehoren & afvoeren









Spoel- & installatiesystemen

Badkamermeubelen en toiletkasten

Gootstenen en wastroggen

Utiliteit

Doucheprogramma Gessi

| | Art.nr | Specificaties | Kleur | Lev.nr | Ehd | Prijs | Grp | CC |
|---|---|---|-----------|----------|------|--------|-----|----|
| Sanitair producten |  | Gessi la Dolce Vito Mito | | | | | | |
| | | handdouche | | | | | | |
| | | 0463134 | chrom | 7915031 | stuk | 71,00 | 169 | 1 |
| Baden / douchebakken / stoomcabines |  | glijstangset compleet z. muuraansluiting | | | | | | |
| | | 0463094 | chrom | 7818031 | stuk | 298,00 | 169 | 1 |
| Kranen |  | glijstangset compleet m. muuraansluiting | | | | | | |
| | | 0463133 | chrom | 7891031 | stuk | 335,00 | 169 | 1 |
| Douchegarnituur |  | Gessi Eclix | | | | | | |
| | | 0467545 | chrom | 14305031 | stuk | 299,00 | 169 | 1 |
| Accessoires en spiegels | | 0460459 | inox | 14305142 | stuk | 402,00 | 169 | 1 |
| Douchewanden |  | glijstangset 60cm compleet z. muuraansluiting | | | | | | |
| | | 0467553 | chrom | 14310031 | stuk | 280,00 | 169 | 1 |
| Toebehoren & afvoeren | | 0460460 | inox | 14310142 | stuk | 375,00 | 169 | 1 |
| Spoel- & installatiesystemen |  | glijstangset compleet m. muuraansluiting kunststof | | | | | | |
| | | 0467561 | verchromd | 13382031 | stuk | 164,00 | 169 | 1 |
| Badkamermeubelen en toiletkasten |  | glijstangset compleet z. muuraansluiting kunststof | | | | | | |
| | | 0467588 | verchromd | 13388031 | stuk | 145,00 | 169 | 1 |
| Gootstenen en wastroggen |  | Gessi Font | | | | | | |
| | | 0460528 | chrom | 14483031 | stuk | 304,00 | 169 | 1 |
| Utiliteit | | 0460529 | inox | 14483142 | stuk | 410,00 | 169 | 1 |
| |  | glijstangset 60cm compleet m. muuraansluiting m. handdouche 3 jets | | | | | | |
| | | 0460532 | chrom | 14487031 | stuk | 355,00 | 169 | 1 |
| | | 0460533 | inox | 14487142 | stuk | 454,00 | 169 | 1 |

| Art.nr | Specificaties | Kleur | Lev.nr | Ehd | Prijs | Grp | CC |
|--------|---------------|-------|--------|-----|-------|-----|----|
|--------|---------------|-------|--------|-----|-------|-----|----|

Gessi Font

glijstangset 60cm compleet z. muuraansluiting

| | | | | | | | |
|---------|--|--------|----------|------|--------|-----|---|
| 0460530 | | chroom | 14489031 | stuk | 285,00 | 169 | 1 |
| 0460531 | | inox | 14489142 | stuk | 383,00 | 169 | 1 |

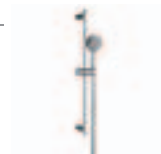

Sanitair producten

Baden /
douchebakken /
stoomcabines

Kranen

Douchegarnituur

Accessoires en
spiegels

Douchewanden

Toebehoren &
afvoeren

Spoel- &
installatiesystemen

Badkamermeubelen
en toiletkasten

Gootstenen en
wastroggen

Utiliteit

glijstangset 60cm compleet z. muuraansluiting m. handdouche 3 jets

| | | | | | | | |
|---------|--|--------|----------|------|--------|-----|---|
| 0460534 | | chroom | 14488031 | stuk | 336,00 | 169 | 1 |
| 0460535 | | inox | 14488142 | stuk | 427,00 | 169 | 1 |



hoofddouche m. douche-arm 38cm

| | | | | | | | |
|---------|--|--------|----------|------|--------|-----|---|
| 0460465 | | chroom | 13348031 | stuk | 702,00 | 169 | 1 |
| 0460466 | | inox | 13348142 | stuk | 912,00 | 169 | 1 |



plafond hoofddouche m. pijp 26cm

| | | | | | | | |
|---------|--|--------|----------|------|--------|-----|---|
| 0460467 | | chroom | 13351031 | stuk | 659,00 | 169 | 1 |
| 0460468 | | inox | 13351142 | stuk | 857,00 | 169 | 1 |



plafond hoofddouche m. pijp 77cm

| | | | | | | | |
|---------|--|--------|----------|------|--------|-----|---|
| 0460469 | | chroom | 13352031 | stuk | 719,00 | 169 | 1 |
| 0460470 | | inox | 13352142 | stuk | 934,00 | 169 | 1 |



Gessi Mamilla

glijstangset 60cm compleet m. muuraansluiting

| | | | | | | | |
|---------|--|-------------|---------|------|--------|-----|---|
| 0463102 | | chroom | 4070031 | stuk | 234,00 | 169 | 1 |
| 0463103 | | chroom/goud | 4070081 | stuk | 258,00 | 169 | 1 |



glijstangset compleet z. muuraansluiting

| | | | | | | | |
|---------|--|-------------|---------|------|--------|-----|---|
| 0461482 | | chroom | 3947031 | stuk | 209,00 | 169 | 0 |
| 0461490 | | chroom/goud | 3947081 | stuk | 228,00 | 169 | 1 |



handdouche

| | | | | | | | |
|---------|--|-------------|---------|------|-------|-----|---|
| 0466964 | | chroom | 4112031 | stuk | 54,50 | 169 | 1 |
| 0460639 | | chroom/goud | 4112081 | stuk | 62,50 | 169 | 1 |













handdouche m. wandhouder m. wandaansluiting









| | | | | | | | |
|---------|--|-------------|---------|------|--------|-----|---|
| 0466972 | | chroom | 3779031 | stuk | 97,50 | 169 | 1 |
| 0460641 | | chroom/goud | 3779081 | stuk | 150,00 | 169 | 1 |



| | Art.nr | Specificaties | Kleur | Lev.nr | Ehd | Prijs | Grp | CC |
|---|-------------------------------|--|-------------|----------|------|--------|-----|----|
| Sanitair producten | Gessi Mamilla | | | | | | | |
| | | handdouche verstelbaar | | | | | | |
| | 0460640 | | chroom | 4114031 | stuk | 104,00 | 169 | 1 |
| Baden / douchebakken / stoomcabines | wandhouder verstelbaar | | | | | | | |
| | 0466956 | | chroom | 4103031 | stuk | 47,75 | 169 | 1 |
| Kranen | 0460638 | | chroom/goud | 4103081 | stuk | 53,00 | 169 | 1 |
| | Gessi Ovale | | | | | | | |
| Accessoires en spiegels | | handdouche staafmodel | | | | | | |
| | 0463059 | | chroom | 23154031 | stuk | 113,00 | 169 | 0 |
| Douchewanden | | glijtangset compleet m. muuraansluiting | | | | | | |
| | 0463026 | | chroom | 23142031 | stuk | 462,00 | 169 | 1 |
| Toebehoren & afvoeren | | glijtangset 60cm compleet m. muuraansluiting m. handdouche 3 jets | | | | | | |
| | 0460642 | | chroom | 23143031 | stuk | 462,00 | 169 | 1 |
| Spoel- & installatiesystemen | | glijtangset compleet z. muuraansluiting | | | | | | |
| | 0463028 | | chroom | 23145031 | stuk | 402,00 | 169 | 0 |
| Badkamermeubelen en toiletkasten | | glijtangset 60cm compleet m. handdouche 3 jets | | | | | | |
| | 0460643 | | chroom | 23146031 | stuk | 402,00 | 169 | 1 |
| Gootstenen en wastroggen | | hoofddouche wandmontage | | | | | | |
| | 0463029 | | chroom | 23148031 | stuk | 702,00 | 169 | 1 |
| Utiliteit | | hoofddouche plafondmontage 20cm | | | | | | |
| | 0463030 | | chroom | 23151031 | stuk | 659,00 | 169 | 1 |

| Art.nr | Specificaties | Kleur | Lev.nr | Ehd | Prijs | Grp | CC | | |
|---|---------------|--------|----------|------|--------|-----|----|---|---|
| | | | | | | | | Gessi Ovale | |
| hoofddouche plafondmontage 70cm 0463031 | | chroom | 23152031 | stuk | 719,00 | 169 | 1 |  | Sanitair producten |
| zijdouche verstelbaar 1/2" 0460646 | | chroom | 23175031 | stuk | 129,00 | 169 | 1 |  | Baden / douchebakken / stoomcabines |
| slangdoorvoer v. badrandmontage 0460110 | | inox | 23172142 | stuk | 66,00 | 169 | 1 |  | Kranen |
| wanddouchehouder 0463057 | | chroom | 23157031 | stuk | 48,00 | 169 | 0 |  | Doucheapparatuur |
| wanddouchehouder verstelbaar 0463058 | | chroom | 23160031 | stuk | 86,00 | 169 | 1 |  | Accessoires en spiegels |
| wandaansluitbocht 1/2" 0463056 | | chroom | 23169031 | stuk | 94,50 | 169 | 1 |  | Douchewanden |
| glijstangset 60cm compleet m. muuraansluiting 0463115 | | chroom | 13381031 | stuk | 151,00 | 169 | 1 |  | Toebehoren & afvoeren |
| glijstangset 60cm compleet z. muuraansluiting 0463117 | | chroom | 13387031 | stuk | 132,00 | 169 | 1 |  | Spoel- & installatiesystemen |
| zijdouche verstelbaar 0460548 | | chroom | 13375031 | stuk | 116,00 | 169 | 1 |  | Badkamermeubelen en toiletkasten |
| 0460549 | | inox | 13375142 | stuk | 151,00 | 169 | 1 | | Gootstenen en wastroggen |
| | | | | | | | | Gessi Ozone | |
| zijdouche verstelbaar 0460548 | | chroom | 13375031 | stuk | 116,00 | 169 | 1 |  | Utiliteit |
| 0460549 | | inox | 13375142 | stuk | 151,00 | 169 | 1 | | |

Doucheprogramma Gessi

| | Art.nr | Specificaties | Kleur | Lev.nr | Ehd | Prijs | Grp | CC |
|---|---|---------------|--------|----------|------|---------|-----|----|
| Sanitair producten | Gessi Ozone | | | | | | | |
| | wandaansluitbocht | | | | | | | |
| | 0460556 | | chroom | 10051031 | stuk | 38,50 | 169 | 1 |
| | 0460557 | | inox | 10051142 | stuk | 58,00 | 169 | 1 |
| Baden / douchebakken / stoomcabines |  | | | | | | | |
| Kranen | Gessi Quadro | | | | | | | |
| | douchekraan m. regendouche | | | | | | | |
| | 0464341 | | chroom | 15149031 | stuk | 1593,00 | 169 | 1 |
| | 0464368 | | inox | 15149142 | stuk | 2150,00 | 169 | 1 |
| Douche­garnituur |  | | | | | | | |
| Accessoires en spiegels | glijstangset compleet m. muuraansluiting | | | | | | | |
| | 0463515 | | chroom | 15112031 | stuk | 326,00 | 169 | 1 |
| | 0463868 | | inox | 15112142 | stuk | 437,00 | 169 | 1 |
| Douchewanden |  | | | | | | | |
| Toebehoren & afvoeren | glijstangset compleet z. muuraansluiting | | | | | | | |
| | 0462640 | | chroom | 15115031 | stuk | 306,00 | 169 | 0 |
| | 0463744 | | inox | 15115142 | stuk | 411,00 | 169 | 1 |
| Douchewanden |  | | | | | | | |
| Spoel- & installatiesystemen | glijstangset 60cm compleet m. muuraansluiting m. handdouche 3 jets | | | | | | | |
| | 0460724 | | chroom | 15117031 | stuk | 346,00 | 169 | 1 |
| | 0460725 | | inox | 15117142 | stuk | 439,00 | 169 | 1 |
| Badkamermeubelen en toiletkasten |  | | | | | | | |
| Gootstenen en wastroggen | glijstangset 60cm compleet z. muuraansluiting m. handdouche 3 jets | | | | | | | |
| | 0460722 | | chroom | 15113031 | stuk | 366,00 | 169 | 1 |
| | 0460723 | | inox | 15113142 | stuk | 466,00 | 169 | 1 |
| Douchewanden |  | | | | | | | |
| Utiliteit | hoofddouche m. douche-arm 38cm | | | | | | | |
| | 0460726 | | chroom | 15188031 | stuk | 702,00 | 169 | 1 |
| | 0460727 | | inox | 15188142 | stuk | 912,00 | 169 | 1 |
| Utiliteit |  | | | | | | | |
| Utiliteit | plafond hoofddouche m. pijp 27cm | | | | | | | |
| | 0460728 | | chroom | 15191031 | stuk | 659,00 | 169 | 1 |
| | 0460754 | | inox | 15191142 | stuk | 857,00 | 169 | 1 |
| Utiliteit |  | | | | | | | |
| Utiliteit | plafond hoofddouche m. pijp 77cm | | | | | | | |
| | 0460755 | | chroom | 15192031 | stuk | 719,00 | 169 | 1 |
| | 0460756 | | inox | 15192142 | stuk | 934,00 | 169 | 1 |
| Utiliteit |  | | | | | | | |

| Art.nr | Specificaties | Kleur | Lev.nr | Ehd | Prijs | Grp | CC |
|--------|---------------|-------|--------|-----|-------|-----|----|
|--------|---------------|-------|--------|-----|-------|-----|----|

Gessi Quadro

plafond hoofddouche m. verstelbare pijp

| | | | | | | | |
|---------|--|--------|----------|------|---------|-----|---|
| 0460757 | | chroom | 15190031 | stuk | 934,00 | 169 | 1 |
| 0460758 | | inox | 15190142 | stuk | 1215,00 | 169 | 1 |



Sanitair producten

Baden /
douchebakken /
stoomcabines

Gessi Rettangolo

handdouche m. antikalk

| | | | | | | | |
|---------|--|--------|----------|------|--------|-----|---|
| 0463312 | | chroom | 20154031 | stuk | 113,00 | 169 | 0 |
| 0463412 | | inox | 20154142 | stuk | 146,00 | 169 | 1 |



Kranen

Doucheapparatuur

plafond hoofddouche 20cm

| | | | | | | | |
|---------|--|--------|----------|------|--------|-----|---|
| 0463224 | | chroom | 20151031 | stuk | 659,00 | 169 | 1 |
| 0463339 | | inox | 20151142 | stuk | 857,00 | 169 | 1 |

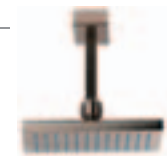

Accessoires en
spiegels

Douchewanden

wanddouchehouder vast

| | | | | | | | |
|---------|--|--------|----------|------|-------|-----|---|
| 0463309 | | chroom | 20157031 | stuk | 48,00 | 169 | 0 |
| 0463410 | | inox | 20157142 | stuk | 62,50 | 169 | 1 |



Toebehoren &
afvoeren

wanddouchehouder verstelbaar

| | | | | | | | |
|---------|--|--------|----------|------|--------|-----|---|
| 0463311 | | chroom | 20160031 | stuk | 86,00 | 169 | 1 |
| 0463411 | | inox | 20160142 | stuk | 112,00 | 169 | 1 |



Spoel- &
installatiesystemen

Badkamermeubelen
en toiletkasten

wandaansluitbocht 1/2"

| | | | | | | | |
|---------|--|--------|----------|------|--------|-----|---|
| 0463308 | | chroom | 20169031 | stuk | 94,50 | 169 | 0 |
| 0463409 | | inox | 20169142 | stuk | 123,00 | 169 | 1 |



Gootstenen en
wastroggen

glijstuk

| | | | | | | | |
|---------|--|--------|----------|------|--------|-----|---|
| 0463414 | | chroom | 20149031 | stuk | 112,00 | 169 | 1 |
| 0463415 | | inox | 20149142 | stuk | 145,00 | 169 | 1 |



Utiliteit

wandhoofddouche

| | | | | | | | |
|---------|--|--------|----------|------|--------|-----|---|
| 0463416 | | chroom | 20148031 | stuk | 702,00 | 169 | 0 |
| 0463417 | | inox | 20148142 | stuk | 912,00 | 169 | 1 |



plafond hoofddouche 70cm

| | | | | | | | |
|---------|--|--------|----------|------|--------|-----|---|
| 0463419 | | chroom | 20152031 | stuk | 719,00 | 169 | 1 |
| 0463420 | | inox | 20152142 | stuk | 934,00 | 169 | 1 |



| | Art.nr | Specificaties | Kleur | Lev.nr | Ehd | Prijs | Grp | CC |
|---|---|---------------|----------|----------|--------|--------|-----|----|
| Sanitair producten | Gessi Rettangolo | | | | | | | |
| | zijdouche verstelbaar | | | | | | | |
| | 0463305 | | chroom | 20172031 | stuk | 129,00 | 169 | 0 |
| | 0463407 | | inox | 20172142 | stuk | 167,00 | 169 | 1 |
| Baden / douchebakken / stoomcabines | | | | | | | | |
| Kranen | glijstangset 60cm compleet m. muuraansluiting | | | | | | | |
| | 0463334 | | inox | 20142142 | stuk | 690,00 | 169 | 1 |
| | 0463219 | | chroom | 20142031 | stuk | 531,00 | 169 | 1 |
| Douchegarnituur | | | | | | | | |
| Accessoires en spiegels | glijstangset 180cm compleet m. muuraansluiting | | | | | | | |
| | 0463220 | | chroom | 20143031 | stuk | 650,00 | 169 | 1 |
| | 0463335 | | inox | 20143142 | stuk | 845,00 | 169 | 1 |
| Douchewanden | | | | | | | | |
| Toebehoren & afvoeren | glijstangset 60cm compleet z. muuraansluiting | | | | | | | |
| | 0463222 | | chroom | 20145031 | stuk | 471,00 | 169 | 0 |
| | 0463336 | | inox | 20145142 | stuk | 612,00 | 169 | 1 |
| Spoel- & installatiesystemen | | | | | | | | |
| Badkamermeubelen en toiletkasten | glijstangset 180cm compleet z. muuraansluiting | | | | | | | |
| | 0463223 | | chroom | 20146031 | stuk | 591,00 | 169 | 1 |
| | 0463338 | | inox | 20146142 | stuk | 768,00 | 169 | 1 |
| Gootstenen en wastroggen | | | | | | | | |
| Utiliteit | glijstangset 61.5cm compleet m. muuraansluiting m. handdouche 3 jets | | | | | | | |
| | 0461006 | | chroom | 20442031 | stuk | 531,00 | 169 | 1 |
| | 0461007 | | inox | 20442142 | stuk | 690,00 | 169 | 1 |
| | | | | | | | | |
| glijstangset 180cm compleet m. muuraansluiting m. handdouche 3 jets | | | | | | | | |
| 0461008 | | chroom | 20443031 | stuk | 650,00 | 169 | 1 | |
| 0461009 | | inox | 20443142 | stuk | 845,00 | 169 | 1 | |
| | | | | | | | | |
| glijstangset 61.5cm compleet z. muuraansluiting m. handdouche 3 jets | | | | | | | | |
| 0461010 | | chroom | 20445031 | stuk | 471,00 | 169 | 1 | |
| 0461011 | | inox | 20445142 | stuk | 612,00 | 169 | 1 | |
| | | | | | | | | |
| glijstangset 180cm compleet z. muuraansluiting m. handdouche 3 jets | | | | | | | | |
| 0461012 | | chroom | 20446031 | stuk | 591,00 | 169 | 1 | |
| 0461013 | | inox | 20446142 | stuk | 768,00 | 169 | 1 | |

| Art.nr | Specificaties | Kleur | Lev.nr | Ehd | Prijs | Grp | CC |
|--|---------------|--------|----------|------|---------|-----|----|
| Gessi Rettangolo | | | | | | | |
| plafond hoofddouche m. verstelbare pijp | | | | | | | |
| 0461004 | | chroom | 20150031 | stuk | 934,00 | 169 | 1 |
| 0461005 | | inox | 20150142 | stuk | 1215,00 | 169 | 1 |



Sanitair producten

Baden /
douchebakken /
stoomcabines

Kranen

Douchegarnituur

Accessoires en
spiegels

Douchewanden











Toebehoren &
afvoeren









Spoel- &
installatiesystemen

Badkamermeubelen
en toiletkasten

Gootstenen en
wastroggen

Utiliteit

| | Art.nr | Specificaties | Kleur | Lev.nr | Ehd | Prijs | Grp | CC | |
|---|---|---------------|-----------------|--------|----------|-------|--------|-----|---|
| Sanitair producten | Grohe Relaxaflex | | | | | | | | |
| | doucheslang | | | | | | | | |
| |  | 0434701 | 1/2"x125cm | chroom | 28150000 | stuk | 12,50 | 255 | 0 |
| | | 0434728 | 1/2"x150cm | chroom | 28151000 | stuk | 15,00 | 255 | 0 |
| | | 0432369 | 1/2"x150cm | wit | 28151L00 | stuk | 24,75 | 255 | 1 |
| | | 0434736 | 1/2"x175cm | chroom | 28154000 | stuk | 19,25 | 255 | 0 |
| Baden / douchebakken / stoomcabines | | 0434744 | 1/2"x200cm | chroom | 28155000 | stuk | 21,75 | 255 | 0 |
| | | 0434726 | 1/2"x3/8" 200cm | chroom | 28158000 | stuk | 35,00 | 162 | 1 |
| | Grohe Relaxa | | | | | | | | |
| Kranen | handdouche 1/2" | | | | | | | | |
| |  | 0436309 | | chroom | 28537000 | stuk | 46,25 | 210 | 1 |
| Douchegarnituur | glijstang 60cm z. garnituur | | | | | | | | |
| |  | 0438472 | | chroom | 28666000 | stuk | 52,00 | 255 | 0 |
| | | 0436763 | | chroom | 28620000 | stuk | 69,00 | 255 | 0 |
| Accessoires en spiegels |  | | | | | | | | |
| Douchewanden |  | | | | | | | | |
| Toebehoren & afvoeren | glijstang 100cm z. garnituur | | | | | | | | |
| | | 0436771 | | chroom | 28621000 | stuk | 59,00 | 255 | 0 |
| Spoel- & installatiesystemen | glijstang m. greep | | | | | | | | |
| | | 0410056 | 90cm | chroom | 28587000 | stuk | 133,00 | 255 | 1 |
| Badkamermeubelen en toiletkasten | wanddouchehouder | | | | | | | | |
| |  | 0436895 | | chroom | 28622000 | stuk | 12,50 | 255 | 0 |
| Gootstenen en wastroggen | wanddouchehouder verstelbaar | | | | | | | | |
| |  | 0436941 | | chroom | 28623000 | stuk | 26,75 | 255 | 0 |
| Utiliteit | wandaansluitbocht 1/2" | | | | | | | | |
| |  | 0438391 | | chroom | 28671000 | stuk | 20,50 | 255 | 0 |
| | zeepschaal transparant voor glijstang 28620 | | | | | | | | |
| |  | 0436984 | | chroom | 28631000 | stuk | 27,75 | 255 | 0 |
| | zeepschaal transparant | | | | | | | | |
| |  | 0432202 | | chroom | 28856000 | stuk | 21,50 | 255 | 0 |
| | ophanghaak voor wandmengkraan moer montage | | | | | | | | |
| |  | 0435031 | | chroom | 28788000 | stuk | 30,50 | 255 | 0 |

| Art.nr | Specificaties | Kleur | Lev.nr | Ehd | Prijs | Grp | CC | |
|--|---------------|--------|----------|------|--------|-----|----|---|
| | | | | | | | | Grohe Relaxa |
| adapter 1/2"x3/4" voor slang 0433942 | | chroom | 28817000 | stuk | 9,30 | 255 | 1 |  |
| opvulplaatje 0432008 | | | 45459000 | stuk | 6,40 | 255 | 0 |  |
| koppelstuk 0437050 | | grijs | 28635XX0 | stuk | 4,80 | 255 | 0 |  |
| geleidestuk 1/2" 0435025 | | wit | 28785L00 | stuk | 4,03 | 255 | 1 | |
| glijstuk metaal 0410043 | | | 12435000 | stuk | 38,25 | 255 | 1 | |
| | | | | | | | | Grohe Relaxa2 |
| Trio handdouche 0437231 | | chroom | 28793000 | stuk | 65,50 | 163 | 0 |  |
| Champagne handdouche 0437230 | | chroom | 28794000 | stuk | 82,50 | 163 | 0 |  |
| Massage handdouche 0437229 | | chroom | 28795000 | stuk | 82,50 | 163 | 0 |  |
| Five handdouche 0437228 | | chroom | 28796000 | stuk | 101,00 | 163 | 0 |  |
| glijstang z. garnituur 0437196 90cm | | chroom | 28819000 | stuk | 104,00 | 163 | 0 |  |
| 0437197 60cm | | chroom | 28797000 | stuk | 88,00 | 163 | 0 | |

Sanitair producten

Baden /
douchebakken /
stoomcabines

Kranen

Douchegarnituur

Accessoires en
spiegels

Douchewanden









Toebehoren &
afvoeren



Spoel- &
installatiesystemen

Badkamermeubelen
en toiletkasten

Gootstenen en
wastroggen

Utiliteit

| | Art.nr | Specificaties | Kleur | Lev.nr | Ehd | Prijs | Grp | CC |
|---|---|---------------|--------|----------|------|--------|-----|----|
| Sanitair producten | Grohe Relaxa2 | | | | | | | |
| | Champagne badset | | | | | | | |
| | 0437198 | | chroom | 28843000 | stuk | 119,00 | 163 | 0 |
| Baden / douchebakken / stoomcabines |  | | | | | | | |
| Kranen | glijstangset m. Trio handdouche | | | | | | | |
| | 0437227 | 60cm | chroom | 28942000 | stuk | 151,00 | 163 | 0 |
| | 0437223 | 90cm | chroom | 28831000 | stuk | 166,00 | 163 | 0 |
| Douchegarnituur |  | | | | | | | |
| Accessoires en spiegels | glijstangset m. Champagne handdouche | | | | | | | |
| | 0437226 | 60cm | chroom | 28944000 | stuk | 168,00 | 163 | 0 |
| | 0437222 | 90cm | chroom | 28932000 | stuk | 183,00 | 163 | 0 |
| Douchewanden |  | | | | | | | |
| Toebehoren & afvoeren | glijstangset m. Massage handdouche | | | | | | | |
| | 0437225 | 60cm | chroom | 28945000 | stuk | 168,00 | 163 | 0 |
| | 0437221 | 90cm | chroom | 28933000 | stuk | 183,00 | 163 | 0 |
| Toebehoren & afvoeren |  | | | | | | | |
| Spoel- & installatiesystemen | glijstangset m. Five handdouche | | | | | | | |
| | 0437224 | 60cm | chroom | 28964000 | stuk | 185,00 | 163 | 0 |
| | 0437199 | 90cm | chroom | 28941000 | stuk | 200,00 | 163 | 0 |
| Badkamermeubelen en toiletkasten |  | | | | | | | |
| Gootstenen en wastroggen | zijdouche | | | | | | | |
| | 0434040 | Massage | chroom | 27067000 | stuk | 105,00 | 255 | 1 |
| | 0434041 | Dual | chroom | 27066000 | stuk | 105,00 | 255 | 0 |
| Utiliteit |  | | | | | | | |
| |  | | | | | | | |
| Utiliteit | hoofddouche | | | | | | | |
| | 0434042 | Five Flex | chroom | 27068000 | stuk | 157,00 | 255 | 1 |
| | 0434043 | Five | chroom | 27062000 | stuk | 207,00 | 255 | 0 |
| | 0434044 | Champagne | chroom | 27063000 | stuk | 161,00 | 255 | 0 |
| | 0434045 | Massage | chroom | 27064000 | stuk | 161,00 | 255 | 1 |
| | 0434046 | Trio | chroom | 27065000 | stuk | 138,00 | 255 | 1 |
| |  | | | | | | | |
| |  | | | | | | | |

| Art.nr | Specificaties | Kleur | Lev.nr | Ehd | Prijs | Grp | CC | |
|--|---------------|-------|----------|------|--------|-----|----|---|
| Grohe Relaxa-Plus | | | | | | | | |
| Solo glijstangset 60 cm met handdouche en doucheslang 150cm | | | | | | | | |
| 0438500 | | | 28892000 | stuk | 57,50 | 255 | 0 | |
| glijstangset 60cm m. Exquisit handdouche 28215 | | | | | | | | |
| 0439312 | slang 150cm | chrom | 28668000 | stuk | 69,00 | 255 | 0 |  |
| Exquisit hoofddouche | | | | | | | | |
| 0430583 | | chrom | 28270000 | stuk | 73,50 | 255 | 1 |  |
| sportdouche 1/2" | | | | | | | | |
| 0443662 | | chrom | 28949000 | stuk | 150,00 | 255 | 1 | |
| Grohe Relaxa Cosmopolitan | | | | | | | | |
| zeepschaal voor glijstang | | | | | | | | |
| 0441708 | | chrom | 28186000 | stuk | 35,25 | 255 | 1 |  |
| wandaansluitbocht 1/2" m. douchehouder | | | | | | | | |
| 0441724 | | chrom | 28226000 | stuk | 37,25 | 255 | 0 |  |
| wandaansluitbocht 1/2" | | | | | | | | |
| 0441732 | | chrom | 28230000 | stuk | 33,50 | 255 | 0 |  |
| Grohe Freehander | | | | | | | | |
| douchekop dubbel verstelbaar | | | | | | | | |
| 0442879 | opbouw | chrom | 27004000 | stuk | 399,00 | 255 | 0 | |
| 0442887 | inbouw | chrom | 27005000 | stuk | 399,00 | 255 | 0 | |
| afdekplaat voor 27005000 | | | | | | | | |
| 0442895 | | | 27008000 | stuk | 94,00 | 255 | 1 | |
| snelkoppeling voor hoofddouche 27004 | | | | | | | | |
| 0430083 | | | 45899000 | stuk | 19,00 | 210 | 1 | |
| aansluitnippel handdouche voor 27004 | | | | | | | | |
| 0430082 | | | 45900000 | stuk | 22,50 | 210 | 1 | |
| Grohe Movario | | | | | | | | |
| handdouche Trio | | | | | | | | |
| 0445529 | | chrom | 28390000 | stuk | 76,50 | 255 | 0 |  |
| handdouche Five | | | | | | | | |
| 0445535 | | chrom | 28393000 | stuk | 130,00 | 255 | 0 |  |

Sanitair producten

Baden /
douchebakken /
stoomcabines

Kranen

Douchegarnituur

Accessoires en
spiegels

Douchewanden







Toebehoren &
afvoeren







Spoel- &
installatiesystemen

Badkamermeubelen
en toiletkasten

Gootstenen en
wastroggen

Utiliteit

| | Art.nr | Specificaties | Kleur | Lev.nr | Ehd | Prijs | Grp | CC |
|---|---|--|--------------------------------------|--|------------------------------|----------------------------------|--------------------------|------------------|
| | Grohe Movario | | | | | | | |
| Sanitair producten | | glijstang vlak model 0445555 90cm | chroom | 28398000 | stuk | 112,00 | 255 | 0 |
| Baden / douchebakken / stoomcabines |  | | | | | | | |
| Kranen | | glijstang hoekmodel 0445557 90cm | chroom | 28399000 | stuk | 112,00 | 255 | 0 |
| Douchegarnituur |  | | | | | | | |
| Accessoires en spiegels | | glijstangset m. Five handdouches 0445519 60cm 0445525 90cm | chroom chroom | 28009000 28571000 | stuk stuk | 247,00 263,00 | 255 255 | 0 0 |
| Douchewanden |  | | | | | | | |
| Toebehoren & afvoeren | | glijstangset m. Trio handdouches 0445502 60cm 0445527 90cm | chroom chroom | 28000000 28575000 | stuk stuk | 216,00 232,00 | 255 255 | 0 0 |
| Spoel- & installatiesystemen |  | | | | | | | |
| Badkamermeubelen en toiletkasten | | wandhouder verstelbaar voor handdouches 0445565 | chroom | 28401000 | stuk | 29,75 | 255 | 0 |
| Gootstenen en wastroggen |  | | | | | | | |
| Utiliteit | | wandhouder vast voor handdouches 0445567 | chroom | 28403000 | stuk | 15,00 | 255 | 0 |
| |  | | | | | | | |
| | | wandaansluitbocht 0445569 | chroom | 28405000 | stuk | 33,25 | 255 | 0 |
| |  | | | | | | | |
| | | wandaansluitbocht met houder 0445571 | chroom | 28406000 | stuk | 38,25 | 255 | 0 |
| |  | | | | | | | |
| | | opvulplaatje 0445563 | chroom | 28407000 | stuk | 4,81 | 255 | 0 |
| | | doucheslang 0445547 150cm 0445553 150cm 0445549 175cm 0445551 200cm | chroom metaal chroom chroom | 28409000 28417000 28410000 28413000 | stuk stuk stuk stuk | 18,75 35,00 22,00 25,00 | 255 255 255 255 | 0 0 0 0 |
| |  | | | | | | | |

| Art.nr | Specificaties | Kleur | Lev.nr | Ehd | Prijs | Grp | CC | |
|---|---------------------|-------|----------|------|---------|-----|----|---|
| Grohe Movario | | | | | | | | |
| douchearm 1/2 0445545 | | chrom | 28529000 | stuk | 97,50 | 255 | 0 |  |
| zeepschaal vlak 0445559 | | chrom | 28549000 | stuk | 31,00 | 255 | 0 |  |
| zeepschaal hoek 0445561 | | chrom | 28566000 | stuk | 31,00 | 255 | 0 |  |
| Grohe Rainshower | | | | | | | | |
| hoofddouche modern 21cm 0430022 | | chrom | 28368000 | stuk | 333,00 | 255 | 0 | |
| hoofddouche retro 21.2cm 0430045 | | chrom | 28369000 | stuk | 350,00 | 255 | 0 | |
| douchearm voor hoofddouche modern 0430062 | | chrom | 28576000 | stuk | 66,50 | 255 | 0 | |
| douchearm voor hoofddouche retro 0430063 | | chrom | 28384000 | stuk | 134,00 | 255 | 0 | |
| douchearm voor hoofddouche plafondbevestiging 0430076 | | chrom | 28497000 | stuk | 50,00 | 255 | 0 | |
| glijstangset opbouw m. handdouche 0102476 60cm | | chrom | 27038000 | stuk | 729,00 | 255 | 0 |  |
| glijstangset m. handdouche m. thermostaat 0102471 | | chrom | 27032000 | stuk | 1323,00 | 255 | 0 |  |
| Classic handdouche 0437192 130mm | | chrom | 28764000 | stuk | 86,00 | 163 | 0 |  |
| 0437193 160mm | | chrom | 28765000 | stuk | 98,50 | 163 | 0 | |
| Classic glijstangcombinatie 0437194 90cm | m. 130mm handdouche | chrom | 28769000 | stuk | 191,00 | 163 | 0 |  |
| 0437195 90cm | m. 160mm handdouche | chrom | 28770000 | stuk | 203,00 | 163 | 0 | |

Sanitair producten

Baden /
douchebakken /
stoomcabines

Kranen

Doucheapparatuur

Accessoires en
spiegels

Douchewanden

Toebehoren &
afvoeren



Spoel- &
installatiesystemen

Badkamermeubelen
en toiletkasten

Gootstenen en
wastroggen

Utiliteit

| | Art.nr | Specificaties | Kleur | Lev.nr | Ehd | Prijs | Grp | CC |
|---|----------------------------------|---------------------|-------|----------|------|--------|-----|----|
| Sanitair producten | Grohe Rainshower | | | | | | | |
| | Cosmopolitan handdouche | | | | | | | |
| | 0437215 | 130mm | chrom | 28755000 | stuk | 114,00 | 163 | 0 |
| | 0437216 | 160mm | chrom | 28756000 | stuk | 126,00 | 163 | 0 |
| Baden / douchebakken / stoomcabines | | | | | | | | |
| Kranen | Cosmopolitan glijstangset | | | | | | | |
| | 0437217 | m. 130mm handdouche | chrom | 28762000 | stuk | 212,00 | 163 | 1 |
| | 0437218 | m. 160mm handdouche | chrom | 28763000 | stuk | 225,00 | 163 | 1 |
| Douchegarnituur | | | | | | | | |
| | glijstang verlengstuk | | | | | | | |
| | 0442477 | | chrom | 07247000 | stuk | 61,50 | 162 | 0 |
| Accessoires en spiegels | | | | | | | | |
| Douchewanden | Grohe Sena | | | | | | | |
| | handdouche | | | | | | | |
| | 0445503 | | chrom | 28034000 | stuk | 114,00 | 255 | 0 |
| Toebehoren & afvoeren | | | | | | | | |
| | hoofddouche | | | | | | | |
| | 0445501 | | chrom | 28308000 | stuk | 147,00 | 255 | 0 |
| Spoel- & installatiesystemen | | | | | | | | |
| | glijstang | | | | | | | |
| | 0445511 | 90cm | chrom | 28346000 | stuk | 284,00 | 255 | 1 |
| Badkamermeubelen en toiletkasten | | | | | | | | |
| | glijstangset compleet | | | | | | | |
| | 0445513 | 90cm | chrom | 28347000 | stuk | 391,00 | 255 | 1 |
| Gootstenen en wastroggen | | | | | | | | |
| Utiliteit | | | | | | | | |
| | douchegarnituur | | | | | | | |
| | 0445507 | | chrom | 28348000 | stuk | 198,00 | 255 | 0 |
| | adapter voor handdouche | | | | | | | |
| | 0445505 | | chrom | 28389000 | stuk | 28,50 | 255 | 1 |
| | wandhouder | | | | | | | |
| | 0445509 | | chrom | 28690000 | stuk | 76,50 | 255 | 1 |

| Art.nr | Specificaties | Kleur | Lev.nr | Ehd | Prijs | Grp | CC | |
|-------------------------------------|----------------|--------|----------|------|--------|-----|----|---|
| Grohe Silverflex | | | | | | | | |
| doucheslang | | | | | | | | |
| 0434745 | 1/2"x125cm | chroom | 28362000 | stuk | 24,75 | 255 | 1 | |
| 0434746 | 1/2"x150cm | chroom | 28364000 | stuk | 26,00 | 255 | 1 | |
| 0434747 | 1/2"x175cm | chroom | 28388000 | stuk | 28,25 | 255 | 1 | |
| Grohe Sinfonia | | | | | | | |  |
| handdouche | | | | | | | | |
| 0441988 | | chroom | 28952000 | stuk | 104,00 | 255 | 1 | |
| glijstangset compleet | | | | | | | | |
| 0441937 | | chroom | 28975000 | stuk | 320,00 | 255 | 1 |  |
| doucheapparatuur verstelbaar | | | | | | | | |
| 0441929 | | chroom | 28976000 | stuk | 202,00 | 255 | 1 |  |
| zijdouche | | | | | | | | |
| 0441953 | | chroom | 28972000 | stuk | 111,00 | 255 | 1 |  |
| doucheapparatuur | | | | | | | | |
| 0441961 | | chroom | 27001000 | stuk | 196,00 | 255 | 1 |  |
| wandaansluitbocht | | | | | | | | |
| 0441996 | | chroom | 28973000 | stuk | 32,00 | 255 | 1 |  |
| Grohe Tempesta | | | | | | | | |
| Duo handdouche | | | | | | | | |
| 0438503 | | chroom | 28261000 | stuk | 30,75 | 255 | 0 |  |
| 0438505 | waterbesparend | chroom | 28419000 | stuk | 34,75 | 255 | 1 | |
| Trio handdouche | | | | | | | | |
| 0438507 | | chroom | 28578000 | stuk | 38,25 | 255 | 0 |  |
| 0438513 | waterbesparend | chroom | 28421000 | stuk | 41,75 | 255 | 0 | |
| Duo glijstangset 60cm | | | | | | | | |
| 0438514 | waterbesparend | chroom | 28434000 | stuk | 70,00 | 255 | 0 |  |
| 0438516 | | chroom | 28591000 | stuk | 65,00 | 255 | 0 | |
| 0438517 | m. slang 175cm | chroom | 28440000 | stuk | 67,00 | 255 | 1 | |
| Duo glijstangset | | | | | | | | |
| 0442478 | 90cm | chroom | 28789000 | stuk | 81,00 | 162 | 1 | |

Sanitair producten

Baden /
douchebakken /
stoomcabines

Kranen

Doucheapparatuur

Accessoires en
spiegels

Douchewanden









Toebehoren &
afvoeren

Spoel- &
installatiesystemen

Badkamermeubelen
en toiletkasten

Gootstenen en
wastroggen

Utiliteit

| | Art.nr | Specificaties | Kleur | Lev.nr | Ehd | Prijs | Grp | CC |
|---|---|------------------------|-------------------|----------|----------|-------|-------|-------|
| Sanitair producten | Grohe Tempesta | | | | | | | |
| | Trio glijstangset 60cm | | | | | | | |
| | | 0438519 | waterbesparend | chrom | 28435000 | stuk | 78,00 | 255 0 |
| | | 0438520 | | chrom | 28592000 | stuk | 74,50 | 255 0 |
| | 0438521 | m. slang 175cm | chrom | 28449000 | stuk | 78,00 | 255 0 | |
| Baden / douchebakken / stoomcabines |  | | | | | | | |
| Kranen | Trio glijstangset 60cm m. zeepschaal | | | | | | | |
| | | 0438522 | waterbesparend | chrom | 28436000 | stuk | 84,50 | 255 1 |
| | 0438523 | | chrom | 28593000 | stuk | 81,00 | 255 0 | |
| Douchegarnituur |  | | | | | | | |
| Accessoires en spiegels | Duo badset | | | | | | | |
| | | 0438524 | | chrom | 28469000 | stuk | 48,50 | 255 0 |
| Douchewanden |  | | | | | | | |
| Toebehoren & afvoeren | Duo badset instelbaar | | | | | | | |
| | | 0438525 | | chrom | 28473000 | stuk | 57,50 | 255 0 |
|  | | | | | | | | |
| Spoel- & installatiesystemen | Trio badset instelbaar | | | | | | | |
| | | 0438526 | | chrom | 28479000 | stuk | 67,00 | 255 1 |
| Badkamermeubelen en toiletkasten | Grohe Twin | | | | | | | |
| | wanddouchehouder | | | | | | | |
| | 0438529 | | chrom | 28605000 | stuk | 13,75 | 255 0 | |
|  | | | | | | | | |
| Gootstenen en wastroggen | Grohe Universeel | | | | | | | |
| | opvulplaat | | | | | | | |
| | 0432222 | voor montage glijstang | | 45406000 | stuk | 8,70 | 255 0 | |
| Utiliteit | douchearm 1/2" m. rozet | | | | | | | |
| | | 0435015 | | chrom | 28429000 | stuk | 24,25 | 255 1 |
|  | | | | | | | | |
| | hoofddouche 1/2" | | | | | | | |
| | | 0431370 | | chrom | 28094000 | stuk | 36,25 | 255 1 |
|  | | | | | | | | |
| | T-stuk | | | | | | | |
| | | 0442607 | 1/2"x1/2" bi x bu | chrom | 28874000 | stuk | 40,00 | 255 0 |
| | 0442615 | 3/4"x1/2" bi x bu | chrom | 28875000 | stuk | 37,50 | 255 1 | |
|  | | | | | | | | |

| Art.nr | Specificaties | Kleur | Lev.nr | Ehd | Prijs | Grp | CC |
|--------|---------------|-------|--------|-----|-------|-----|----|
|--------|---------------|-------|--------|-----|-------|-----|----|

Grohe Universeel

leegloopautomaat instelbaar
0442593

chrom 28988000 stuk 50,50 255 0



Sanitair producten

Baden /
douchebakken /
stoomcabines

Grohe Onderdelen

| | | | | | | | |
|---------|--|--|----------|------|-------|-----|---|
| 0434006 | glijstuk voor Dual glijstang chrom/matchr. | | 456501P0 | stuk | 39,00 | 255 | 0 |
| 0434002 | glijstuk Relaxa-Equisite chrom | | 07659000 | stuk | 36,00 | 255 | 0 |
| 0434003 | glijstuk Relaxa-Equisite wit | | 07659L00 | stuk | 46,00 | 210 | 1 |
| 0436217 | kapje voor glijstang Relaxa chrom | | 00479000 | stuk | 3,45 | 255 | 1 |
| 0432000 | houder voor glijstang 28675 | | 45362000 | stuk | 8,50 | 255 | 0 |
| 0432004 | houder voor glijstang 28644 | | 456511P0 | stuk | 16,75 | 255 | 1 |
| 0432010 | doucheplaat voor Dual handdouche | | 45655000 | stuk | 54,00 | 255 | 1 |

Kranen

Douchegarnituur

Accessoires en
spiegels

Douchewanden





Toebehoren &
afvoeren











Spoel- &
installatiesystemen

Badkamermeubelen
en toiletkasten









Gootstenen en
wastroggen











Utiliteit





| | Art.nr | Specificaties | Kleur | Lev.nr | Ehd | Prijs | Grp | CC |
|---|---|--|--------------------|------------------|--------------|----------------|------------|--------|
| Sanitair producten | Haceka Standaard | | | | | | | |
| |  | handdouche m. witte greep 0601144 | chrom | 110100 | stuk | 7,50 | 241 | 0 |
| Baden / douchebakken / stoomcabines | | douchekop 0600458 1/4" x65mm | chrom | 130100 | stuk | 3,24 | 250 | 0 |
| Kranen |  | handdouche waterbesparend 0641898 | wit | 450100 | stuk | 6,30 | 250 | 0 |
| Douchegarnituur |  | wandsteen m. scharnierstuk 0601152 | chrom | 530100 | stuk | 6,10 | 241 | 0 |
| Accessoires en spiegels | | doucheslang verhoogde druk transparant 0640999 1/2"x150cm | | 630300 | stuk | 4,37 | 250 | 0 |
| Douchewanden |  | glijstang 60cm z. garnituur konisch 0641030 | chrom | 650100 | stuk | 24,00 | 250 | 0 |
| Toebehoren & afvoeren | | glijstang 60cm z. garnituur m. glijstuk 0641871 0641138 | chrom chrom/wit | 650200 660100 | stuk stuk | 24,00 21,00 | 250 250 | 0 0 |
| Spoel- & installatiesystemen |  | glijstuk konisch 0600063 | chrom | 650190 | stuk | 8,20 | 250 | 1 |
| Badkamermeubelen en toiletkasten | | glijstuk m. pen 0600094 | chrom | 650290 | stuk | 7,20 | 250 | 1 |
| Gootstenen en wastroggen | | kappershanddouche m. zwarte douche kop 0640018 | | 790100 | stuk | 97,50 | 250 | 1 |
| Utiliteit | | | | | | | | |

| Art.nr | Specificaties | Kleur | Lev.nr | Ehd | Prijs | Grp | CC | | |
|--|---------------|--------|----------|------|--------|-----|----|---|---|
| | | | | | | | | Hansa Hansajet programma | |
| Hansatrijet handdouche m. clean 0394637 | | chroom | 04330100 | stuk | 120,00 | 262 | 1 |  | Sanitair producten |
| Hansadynajet handdouche m. clean 0394645 | | chroom | 04340100 | stuk | 87,50 | 262 | 1 |  | Baden / douchebakken / stoomcabines |
| Hansaduojet handdouche m. clean 0394629 | | chroom | 04320100 | stuk | 87,50 | 262 | 1 |  | Kranen |
| Hansamonojet handdouche waterbesparend m. clean 0394610 | | chroom | 04310100 | stuk | 53,00 | 262 | 1 |  | Douchegarnituur |
| Hansaprojet handdouche waterbesparend m. clean 0394602 | | chroom | 04300100 | stuk | 31,75 | 262 | 1 |  | Accessoires en spiegels |
| Hansapremio glijstang 90cm z. garnituur 0394688 | | chroom | 04570100 | stuk | 157,00 | 262 | 1 |  | Douchewanden |
| Hansamedio glijstang 90cm z. garnituur 0394661 | | chroom | 04550100 | stuk | 56,00 | 262 | 1 |  | Toebehoren & afvoeren |
| Hansapremio glijstangset 90cm m. Trijet handdouche 0394920 | | chroom | 04580140 | stuk | 295,00 | 262 | 1 |  | Spoel- & installatiesystemen |
| Hansamedio glijstangset m. Monojet handdouche | | | | | | | | | |
| 0394893 | 60cm | chroom | 04040120 | stuk | 132,00 | 262 | 1 |  | Badkamermeubelen en toiletkasten |
| 0394912 | 90cm | chroom | 04560120 | stuk | 132,00 | 262 | 1 | | |
| Hansamedio glijstangset m. Projjet handdouche | | | | | | | | | |
| 0394891 | 60cm | chroom | 04040110 | stuk | 106,00 | 262 | 1 |  | Gootstenen en wastroggen |
| 0394696 | 90cm | chroom | 04560110 | stuk | 107,00 | 262 | 1 | | |

Douchegarnituur

| | Art.nr | Specificaties | Kleur | Lev.nr | Ehd | Prijs | Grp | CC |
|---|---|--|--------|------------|------|--------|-----|----|
| | Hansa Hansajet programma | | | | | | | |
| Sanitair producten | Hansamedio glijstangset m. Trijet handdouche | | | | | | | |
| | 0394887 | 60cm | chrom | 04040140 | stuk | 198,00 | 262 | 1 |
| | 0390700 | 90cm | chrom | 04560140 | stuk | 198,00 | 262 | 1 |
| Baden / douchebakken / stoomcabines |  | | | | | | | |
| Kranen |  | Premio hoekmontageset 0394939 | Premio | 0452010098 | stuk | 35,00 | 262 | 1 |
| Douchegarnituur |  | Medio hoekmontageset 0394947 | Medio | 0453010098 | stuk | 32,25 | 262 | 1 |
| Accessoires en spiegels | | | | | | | | |
| Douchewanden |  | wandaansluitbocht 0394998 | chrom | 04420100 | stuk | 42,00 | 262 | 1 |
| Toebehoren & afvoeren | | | | | | | | |
| Spoel- & installatiesystemen |  | wanddouchehouder vast 0394653 | chrom | 04430100 | stuk | 10,75 | 262 | 1 |
| Badkamermeubelen en toiletkasten | | | | | | | | |
| Gootstenen en wastroggen |  | wanddouchehouder verstelbaar 0394154 | chrom | 04440100 | stuk | 44,75 | 262 | 1 |
| Utiliteit |  | wanddouchehouder m. Monojet handdouche 0394890 | chrom | 04010420 | stuk | 80,00 | 262 | 1 |
| |  | wanddouchehouder m. Projet handdouche 0394882 | chrom | 04010410 | stuk | 57,50 | 262 | 1 |
| |  | doucheslang 0394963 1/2"x125cm | chrom | 04120400 | stuk | 16,50 | 262 | 1 |
| | | 0394971 1/2"x160cm | chrom | 04120500 | stuk | 19,50 | 262 | 1 |

| Art.nr | Specificaties | Kleur | Lev.nr | Ehd | Prijs | Grp | CC | | |
|--|---------------|--------|----------|------|--------|-----|----|---|---|
| Hansa Hansajet XL | | | | | | | | | |
| hoofddouche 18cm voor plafond 0390703 | | chroom | 51970100 | stuk | 299,00 | 262 | 1 |  | Sanitair producten |
| hoofddouche 18cm voor wand 0390704 | | chroom | 51960100 | stuk | 320,00 | 262 | 1 |  | Baden / douchebakken / stoomcabines |
| handdouche 18cm 0390708 | | chroom | 51950100 | stuk | 94,00 | 262 | 0 |  | Kranen |
| Hansa HansaNovaJet programma | | | | | | | | | |
| handdouche Novajet-1 m. 1 straal 0395706 | | chroom | 04610200 | stuk | 13,50 | 262 | 0 |  | Douchegarnituur |
| handdouche Novajet-2 m. 2 stralen 0395714 | | chroom | 04620200 | stuk | 33,75 | 262 | 1 |  | Accessoires en spiegels |
| handdouche Novajet-3 m. 3 stralen 0395722 | | chroom | 04630200 | stuk | 44,00 | 262 | 1 |  | Douchewanden |
| hoofddouche Novajet-1 m. 1 straal 0395730 | | chroom | 04640200 | stuk | 39,00 | 262 | 1 |  | Toebehoren & afvoeren |
| hoofddouche Novajet-2 m. 2 stralen 0395749 | | chroom | 04650200 | stuk | 56,00 | 262 | 1 |  | Spoel- & installatiesystemen |
| hoofddouche Novajet-3 m. 3 stralen 0395757 | | chroom | 04660200 | stuk | 75,00 | 262 | 1 |  | Badkamermeubelen en toiletkasten |
| zijdouche 0395765 | | chroom | 04410200 | stuk | 78,00 | 262 | 1 |  | Gootstenen en wastroggen |

| | Art.nr | Specificaties | Kleur | Lev.nr | Ehd | Prijs | Grp | CC |
|---|---|---------------|--------|----------|------|-------|-----|----|
| Hansa HansaNovaJet programma | | | | | | | | |
| Sanitair producten | glijstangset m. handdouche Novajet-1 | | | | | | | |
| | 0395846 | 60cm | chroom | 04780260 | stuk | 59,00 | 262 | 1 |
| | 0395773 | 90cm | chroom | 04670260 | stuk | 61,50 | 262 | 1 |
| Baden / douchebakken / stoomcabines |  | | | | | | | |
| Kranen | glijstangset m. handdouche Novajet-2 | | | | | | | |
| | 0395854 | 60cm | chroom | 04780270 | stuk | 78,50 | 262 | 0 |
| | 0395781 | 90cm | chroom | 04670270 | stuk | 81,00 | 262 | 0 |
| Douchegarnituur |  | | | | | | | |
| Accessoires en spiegels | glijstangset m. handdouche Novajet-3 | | | | | | | |
| | 0395862 | 60cm | chroom | 04780280 | stuk | 88,50 | 262 | 1 |
| | 0395803 | 90cm | chroom | 04670280 | stuk | 91,00 | 262 | 1 |
| Douchewanden |  | | | | | | | |
| Toebehoren & afvoeren | glijstang z. handdouche | | | | | | | |
| | 0395838 | 60cm | chroom | 04710200 | stuk | 47,25 | 262 | 1 |
| | 0395811 | 90cm | chroom | 04700200 | stuk | 49,50 | 262 | 1 |
| Spoel- & installatiesystemen |  | | | | | | | |
| Badkamermeubelen en toiletkasten | badgarnituur z. handdouche | | | | | | | |
| | 0395870 | | chroom | 04680200 | stuk | 18,75 | 262 | 1 |
| Gootstenen en wastroggen | handdouche m. wandhouder m. slang Novajet-1 | | | | | | | |
| | 0395889 | | chroom | 04680260 | stuk | 30,25 | 262 | 0 |
| Utiliteit | handdouche m. wandhouder m. slang Novajet-2 | | | | | | | |
| | 0395897 | | chroom | 04680270 | stuk | 49,50 | 262 | 1 |
| | handdouche m. wandhouder m. slang Novajet-3 | | | | | | | |
| | 0395900 | | chroom | 04680280 | stuk | 60,00 | 262 | 1 |
| Hansa HansaBasicJet programma | | | | | | | | |
| | handdouche-1 naaldstraal | | | | | | | |
| | 0300690 | | chroom | 44610100 | stuk | 18,00 | 262 | 1 |
| |  | | | | | | | |

| Art.nr | Specificaties | Kleur | Lev.nr | Ehd | Prijs | Grp | CC |
|--------|---------------|-------|--------|-----|-------|-----|----|
|--------|---------------|-------|--------|-----|-------|-----|----|

Hansa HansaBasicJet programma

handdouche-2 naald/massage straal

| | | | | | | | |
|---------|--|--------|----------|------|-------|-----|---|
| 0300691 | | chroom | 44620100 | stuk | 23,25 | 262 | 1 |
|---------|--|--------|----------|------|-------|-----|---|



Sanitair producten

Baden /
douchebakken /
stoomcabines

handdouche-3 naald/massage/soft straal

| | | | | | | | |
|---------|--|--------|----------|------|-------|-----|---|
| 0300692 | | chroom | 44630100 | stuk | 27,25 | 262 | 1 |
|---------|--|--------|----------|------|-------|-----|---|



Kranen

Douchegarnituur

glijstangset compleet m. handdouche-1 m. zeepschaal

| | | | | | | | |
|--------------|--|--------|----------|------|-------|-----|---|
| 0300696 60cm | | chroom | 44780110 | stuk | 41,50 | 262 | 1 |
|--------------|--|--------|----------|------|-------|-----|---|

| | | | | | | | |
|--------------|--|--------|----------|------|-------|-----|---|
| 0300693 90cm | | chroom | 44670110 | stuk | 45,00 | 262 | 1 |
|--------------|--|--------|----------|------|-------|-----|---|



Accessoires en
spiegels

glijstangset compleet m. handdouche-2 m. zeepschaal

| | | | | | | | |
|--------------|--|--------|----------|------|-------|-----|---|
| 0300697 60cm | | chroom | 44780120 | stuk | 45,00 | 262 | 1 |
|--------------|--|--------|----------|------|-------|-----|---|

| | | | | | | | |
|--------------|--|--------|----------|------|-------|-----|---|
| 0300694 90cm | | chroom | 44670120 | stuk | 48,75 | 262 | 1 |
|--------------|--|--------|----------|------|-------|-----|---|



Douchewanden

Toebehoren &
afvoeren

glijstangset compleet m. handdouche-3 m. zeepschaal

| | | | | | | | |
|--------------|--|--------|----------|------|-------|-----|---|
| 0300698 60cm | | chroom | 44780130 | stuk | 49,00 | 262 | 1 |
|--------------|--|--------|----------|------|-------|-----|---|

| | | | | | | | |
|--------------|--|--------|----------|------|-------|-----|---|
| 0300695 90cm | | chroom | 44670130 | stuk | 52,50 | 262 | 1 |
|--------------|--|--------|----------|------|-------|-----|---|



Spoel- &
installatiesystemen

Badkamermeubelen
en toiletkasten

glijstangset compleet m. handdouche-1

| | | | | | | | |
|--------------|--|--------|----------|------|-------|-----|---|
| 0300699 60cm | | chroom | 44780210 | stuk | 33,00 | 262 | 1 |
|--------------|--|--------|----------|------|-------|-----|---|



Gootstenen en
wastroggen

Utiliteit

glijstangset compleet m. handdouche-2

| | | | | | | | |
|--------------|--|--------|----------|------|-------|-----|---|
| 0300700 60cm | | chroom | 44780220 | stuk | 36,50 | 262 | 1 |
|--------------|--|--------|----------|------|-------|-----|---|



glijstangset compleet m. handdouche-3









| | | | | | | | |
|--------------|--|--------|----------|------|-------|-----|---|
| 0300701 60cm | | chroom | 44780230 | stuk | 39,75 | 262 | 0 |
|--------------|--|--------|----------|------|-------|-----|---|











badset m. wandhouder m. slang



| | | | | | | | |
|---------------|--|--------|----------|------|-------|-----|---|
| 0300702 160cm | | chroom | 44680100 | stuk | 10,75 | 262 | 1 |
|---------------|--|--------|----------|------|-------|-----|---|



| | Art.nr | Specificaties | Kleur | Lev.nr | Ehd | Prijs | Grp | CC |
|---|---|--|-------|----------|------|--------|-----|----|
| | Hansa HansaBasicJet programma | | | | | | | |
| Sanitair producten | | badset m. handdouche-1 m. wandhouder m. slang 0300703 | chrom | 44680110 | stuk | 26,50 | 262 | 1 |
| Baden / douchebakken / stoomcabines |  | | | | | | | |
| Kranen | | badset m. handdouche-2 m. wandhouder m. slang 0300704 | chrom | 44680120 | stuk | 31,50 | 262 | 0 |
| Douchegarnituur |  | | | | | | | |
| Accessoires en spiegels | | renovatieset glijstangset m. douchethermostaat 0300705 | chrom | 48150191 | stuk | 174,00 | 262 | 1 |
| Douchewanden |  | | | | | | | |
| | Hansa HansaEcoJet programma | | | | | | | |
| Toebehoren & afvoeren | | handdouche EcoJet1 0394158 | chrom | 54610100 | stuk | 21,75 | 262 | 1 |
| Spoel- & installatiesystemen |  | | | | | | | |
| Badkamermeubelen en toiletkasten | | handdouche EcoJet2 0394159 | chrom | 54620100 | stuk | 28,50 | 262 | 1 |
| Gootstenen en wastroggen |  | | | | | | | |
| Utiliteit | | handdouche EcoJet3 0394162 | chrom | 54630100 | stuk | 33,50 | 262 | 1 |
| |  | | | | | | | |
| | | glijstangset EcoJet1 m. zeepschaal 0394164 | chrom | 54780110 | stuk | 50,50 | 262 | 1 |
| |  | | | | | | | |
| | | glijstangset EcoJet2 m. zeepschaal 0394168 | chrom | 54780120 | stuk | 55,50 | 262 | 1 |
| |  | | | | | | | |
| | | glijstangset EcoJet3 m. zeepschaal 0394169 | chrom | 54780130 | stuk | 60,00 | 262 | 1 |
| |  | | | | | | | |

| Art.nr | Specificaties | Kleur | Lev.nr | Ehd | Prijs | Grp | CC | | |
|--|---------------|-------|----------|------|--------|-----|----|---|---|
| Hansa HansaEcoJet programma | | | | | | | | | |
| glijstangset EcoJet1 | | | | | | | | | |
| 0394171 | | chrom | 54780210 | stuk | 47,50 | 262 | 0 |  | Sanitair producten |
| glijstangset EcoJet2 | | | | | | | | | |
| 0394172 | | chrom | 54780220 | stuk | 52,50 | 262 | 0 |  | Baden / douchebakken / stoomcabines |
| glijstangset EcoJet3 | | | | | | | | | |
| 0394174 | | chrom | 54780230 | stuk | 57,00 | 262 | 0 |  | Kranen |
| Hansa 2Day | | | | | | | | | |
| handdouche naald/soft straal | | | | | | | | | |
| 0300681 | | chrom | 54000100 | stuk | 103,00 | 262 | 1 |  | Douchegarnituur |
| glijstangset compleet | | | | | | | | | |
| 0300684 | 90cm | chrom | 54020300 | stuk | 241,00 | 262 | 1 | | Accessoires en spiegels |
| badset m. handdouche m. wandhouder m. slang | | | | | | | | | |
| 0300682 | 125cm | chrom | 54010400 | stuk | 193,00 | 262 | 1 | | Douchewanden |
| 0300683 | 175cm | chrom | 54010300 | stuk | 194,00 | 262 | 1 |  | Toebehoren & afvoeren |
| wandhouder | | | | | | | | | |
| 0300685 | | chrom | 54030100 | stuk | 83,00 | 262 | 1 |  | Spoel- & installatiesystemen |
| doucheslang | | | | | | | | | |
| 0300686 | 125cm | chrom | 54120400 | stuk | 20,75 | 262 | 1 | | Badkamermeubelen en toiletkasten |
| 0300687 | 160cm | chrom | 54120500 | stuk | 22,00 | 262 | 1 | | Gootstenen en wastroggen |
| 0300688 | 175cm | chrom | 54120300 | stuk | 22,75 | 262 | 1 | | Utiliteit |
| 0300689 | 200cm | chrom | 54120200 | stuk | 23,75 | 262 | 1 |  | |
| Hansa Designo | | | | | | | | | |
| handdouche | | | | | | | | | |
| 0390709 | | chrom | 51170200 | stuk | 126,00 | 262 | 1 |  | |
| handdouche tubeshower | | | | | | | | | |
| 0300665 | | chrom | 59912779 | stuk | 137,00 | 262 | 1 | | |

| | Art.nr | Specificaties | Kleur | Lev.nr | Ehd | Prijs | Grp | CC |
|---|---|-----------------------------------|-------------|----------|--------|---------|-----|----|
| Sanitair producten | Hansa Designo | | | | | | | |
| | | glijstangset | | | | | | |
| | | 0395315 60cm | chrom | 51370190 | stuk | 392,00 | 262 | 1 |
| | 0395307 90cm | chrom | 51190190 | stuk | 422,00 | 262 | 1 | |
| Baden / douchebakken / stoomcabines | | | | | | | | |
| Kranen | wandaansluitbocht | | | | | | | |
| | | 0395994 | chrom | 51180100 | stuk | 56,50 | 262 | 0 |
| Douchegarnituur | | | | | | | | |
| Accessoires en spiegels | tubeshower m. kraan m. handdouche | | | | | | | |
| | | 0300595 | chrom | 51940100 | stuk | 1680,00 | 262 | 1 |
| Douchewanden | | | | | | | | |
| Toebehoren & afvoeren | Rainshower m. handdouche m. omstel | | | | | | | |
| | | 0300596 | chrom | 51840100 | stuk | 934,00 | 262 | 1 |
| Spoel- & installatiesystemen | | | | | | | | |
| Badkamermeubelen en toiletkasten | Hansa Murano | | | | | | | |
| | | glijstangset 90cm compleet | | | | | | |
| | 0395697 | chrom | 56190190 | stuk | 543,00 | 262 | 1 | |
| Gootstenen en wastroggen | | | | | | | | |
| Utiliteit | Hansa Plan | | | | | | | |
| | | handdouche m. 3 standen | | | | | | |
| | 0686054 | chrom | 54980010300 | stuk | 118,00 | 229 | 1 | |
| | glijstang 80cm | | | | | | | |
| | 0686052 | chrom | 54985010800 | stuk | 157,00 | 229 | 1 | |
| | wandhouder | | | | | | | |
| | 0686048 | chrom | 54991010000 | stuk | 50,50 | 229 | 1 | |
| | doucheslang | | | | | | | |
| | 0686056 125cm | chrom | 54995011200 | stuk | 22,25 | 229 | 1 | |
| | 0686058 160cm | chrom | 54995011600 | stuk | 23,75 | 229 | 1 | |
| | 0686060 200cm | chrom | 54995012000 | stuk | 25,25 | 229 | 1 | |

| Art.nr | Specificaties | Kleur | Lev.nr | Ehd | Prijs | Grp | CC | |
|---------------------------------------|---------------|--------|----------|------|--------|-----|----|---|
| | | | | | | | | Hansa Rain |
| wand hoofddouche 0396168 | | chroom | 04180100 | stuk | 608,00 | 262 | 1 |  |
| plafond hoofddouche 0396176 | | chroom | 04190100 | stuk | 592,00 | 262 | 1 |  |

Sanitair producten

Baden /
douchebakken /
stoomcabines

Kranen

Douchegarnituur

Accessoires en
spiegels

Douchewanden













Toebehoren &
afvoeren

Spoel- &
installatiesystemen

Badkamermeubelen
en toiletkasten

Gootstenen en
wastroggen

Utiliteit

| | Art.nr | Specificaties | Kleur | Lev.nr | Ehd | Prijs | Grp | CC |
|---|---|---------------|--------------------------|-------------|----------|-------|--------|-------|
| | Hansgrohe Premium handdouches | | | | | | | |
| Sanitair producten | Aktiva A8 handdouche | | | | | | | |
| |  | 0605247 | | chroom | 28547000 | stuk | 163,00 | 259 0 |
| | | 0458163 | | satinox | 28547810 | stuk | 213,00 | 259 1 |
| | | 0450385 | | chroom/goud | 28547090 | stuk | 256,00 | 176 1 |
| | | 0450386 | | matchroom | 28547880 | stuk | 212,00 | 176 1 |
| Baden / douchebakken / stoomcabines | Aktiva A6 handdouche | | | | | | | |
| |  | 0605255 | | chroom | 28546000 | stuk | 122,00 | 259 0 |
| | | 0458171 | | satinox | 28546810 | stuk | 164,00 | 259 1 |
| | | 0450387 | | chroom/goud | 28546090 | stuk | 206,00 | 176 1 |
| | | 0450388 | | matchroom | 28546880 | stuk | 158,00 | 176 1 |
| Kranen | Aktiva A4 handdouche | | | | | | | |
| |  | 0458198 | | chroom | 28543000 | stuk | 99,50 | 259 0 |
| | | 0450389 | | chroom/goud | 28543090 | stuk | 206,00 | 176 1 |
| | | 0450390 | | matchroom | 28543880 | stuk | 149,00 | 176 1 |
| Douchegarnituur | Hansgrohe Medium handdouches | | | | | | | |
| Accessoires en spiegels | Mistral 3 handdouche verstelbaar | | | | | | | |
| |  | 0605601 | | chroom | 28524000 | stuk | 70,50 | 259 1 |
| | | 0605605 | | chroom/goud | 28524090 | stuk | 134,00 | 259 1 |
| | | 0605607 | | matchroom | 28524880 | stuk | 108,00 | 259 1 |
| Douchewanden | Mistral handdouche | | | | | | | |
| |  | 0605301 | | chroom | 28590000 | stuk | 71,00 | 259 0 |
| Toebehoren & afvoeren | Selecta handdouche verstelbaar | | | | | | | |
| |  | 0605328 | | chroom | 28520000 | stuk | 59,00 | 259 0 |
| | | 0605613 | | chroom/goud | 28520090 | stuk | 85,50 | 259 1 |
| | | 0605615 | | matchroom | 28520880 | stuk | 89,00 | 259 1 |
| Spoel- & installatiesystemen | Selecta-Classic handdouche | | | | | | | |
| |  | 0600873 | | chroom | 28315000 | stuk | 52,50 | 259 0 |
| Badkamermeubelen en toiletkasten | Hansgrohe Comfort handdouches | | | | | | | |
| Gootstenen en wastroggen | Croma 100 Vario handdouche | | | | | | | |
| | | 0450541 | | chroom | 28535000 | stuk | 24,50 | 176 1 |
| | | 0450542 | doorstroombegr. 9.4l/min | chroom | 28537000 | stuk | 27,50 | 176 1 |
| Utiliteit | Croma 100 Multi handdouche | | | | | | | |
| |  | 0450543 | | chroom | 28536000 | stuk | 43,25 | 176 1 |
| | | 0450544 | doorstroombegr. 9.4l/min | chroom | 28538000 | stuk | 46,50 | 176 1 |
| | Croma 3jet handdouche | | | | | | | |
|  | 0605379 | | chroom | 28573000 | stuk | 49,25 | 259 0 | |
| | Croma 2jet handdouche | | | | | | | |
|  | 0605387 | | chroom | 28570000 | stuk | 35,00 | 259 0 | |
| | Variojet handdouche | | | | | | | |
|  | 0605034 | | chroom | 28513000 | stuk | 27,75 | 259 0 | |
| | Croma 1jet handdouche | | | | | | | |
|  | 0602363 | | chroom | 28511000 | stuk | 20,25 | 259 0 | |

| Art.nr | Specificaties | Kleur | Lev.nr | Ehd | Prijs | Grp | CC |
|--------|---------------|-------|--------|-----|-------|-----|----|
|--------|---------------|-------|--------|-----|-------|-----|----|

Hansgrohe Comfort handdouches

Tastica handdouches

| | | | | | | | |
|---------|--------------|--------|----------|------|-------|-----|---|
| 0605395 | m. begrenzer | chroom | 28517000 | stuk | 14,75 | 259 | 0 |
| 0603309 | m. begrenzer | wit | 28517450 | stuk | 14,75 | 259 | 0 |



Sanitair producten

Baden /
douchebakken /
stoomcabines

Hansgrohe Joco handdouches

Joco handdouches regelbaar m. quiclean waterbesparend

| | | | | | | | |
|---------|--|------------|----------|------|-------|-----|---|
| 0602000 | | multikleur | 28560000 | stuk | 48,25 | 259 | 1 |
|---------|--|------------|----------|------|-------|-----|---|



Kranen

Hansgrohe Premium hoofddouches

Aktiva hoofddouches m. douchearm

| | | | | | | | |
|---------|------------------|-------------|----------|------|--------|-----|---|
| 0602094 | 1/2" m. quiclean | chroom | 27470000 | stuk | 520,00 | 259 | 1 |
| 0602108 | 1/2" m. quiclean | chroom/goud | 27470090 | stuk | 596,00 | 259 | 1 |



Douchegarnituur

Accessoires en
spiegels

Clubmaster hoofddouches z. douchearm

| | | | | | | | |
|---------|------------------|-------------|----------|------|--------|-----|---|
| 0602027 | 1/2" m. quiclean | chroom | 28496000 | stuk | 160,00 | 259 | 1 |
| 0602035 | 1/2" m. quiclean | chroom/goud | 28496090 | stuk | 243,00 | 259 | 1 |
| 0453161 | 1/2" m. quiclean | inox | 28496800 | stuk | 246,00 | 259 | 1 |
| 0450538 | 1/2" m. quiclean | matchroom | 28496880 | stuk | 207,00 | 176 | 1 |



Douchewanden

Toebehoren &
afvoeren

Clubmaster hoofddouches m. arm

| | | | | | | | |
|---------|------------------|--------|----------|------|--------|-----|---|
| 0602110 | 1/2" m. quiclean | chroom | 27475000 | stuk | 206,00 | 259 | 1 |
|---------|------------------|--------|----------|------|--------|-----|---|



Spoel- &
installatiesystemen

Aktiva A8 hoofddouches

| | | | | | | | |
|---------|--|---------|----------|------|--------|-----|---|
| 0457434 | | chroom | 28442000 | stuk | 184,00 | 259 | 1 |
| 0457442 | | satinox | 28442810 | stuk | 240,00 | 259 | 1 |
| 0606375 | | RVS | 28442800 | stuk | 278,00 | 259 | 1 |



Badkamermeubelen
en toiletkasten

Gootstenen en
wastroggen

Hansgrohe Medium hoofddouches

Mistral hoofddouches

| | | | | | | | |
|---------|--|-----------|----------|------|--------|-----|---|
| 0458627 | | chroom | 28444000 | stuk | 107,00 | 259 | 1 |
| 0450536 | | matchroom | 28444880 | stuk | 139,00 | 176 | 1 |



Utiliteit

Selecta hoofddouches

| | | | | | | | |
|---------|--|-----------|----------|------|--------|-----|---|
| 0458635 | | chroom | 28447000 | stuk | 80,00 | 259 | 1 |
| 0450537 | | matchroom | 28447880 | stuk | 104,00 | 176 | 1 |



Hansgrohe Comfort hoofddouches

Croma 3jet hoofddouches

| | | | | | | | |
|---------|--|--------|----------|------|-------|-----|---|
| 0458643 | | chroom | 28443000 | stuk | 61,50 | 259 | 1 |
|---------|--|--------|----------|------|-------|-----|---|



Crometta hoofddouches z. arm

| | | | | | | | |
|---------|--|--------|----------|------|-------|-----|---|
| 0601011 | | chroom | 28492000 | stuk | 27,50 | 259 | 1 |
|---------|--|--------|----------|------|-------|-----|---|

| | Art.nr | Specificaties | Kleur | Lev.nr | Ehd | Prijs | Grp | CC |
|---|--|----------------|-------------|----------|------|--------|-----|----|
| | Hansgrohe Comfort hoofddouches | | | | | | | |
| Sanitair producten | Croma 2jet hoofddouche | | | | | | | |
| | 0450381 | | chroom | 28448000 | stuk | 46,75 | 176 | 1 |
| | Croma100 Vario hoofddouche | | | | | | | |
| Baden / douchebakken / stoomcabines | 0450539 | | chroom | 27441000 | stuk | 34,75 | 176 | 1 |
| | Croma100 Multi hoofddouche | | | | | | | |
| Kranen | 0450540 | | chroom | 27443000 | stuk | 54,00 | 176 | 1 |
| | Hansgrohe Universeel regendouches | | | | | | | |
| | AXOR regendouche z. arm 24cm Air | | | | | | | |
| | 0450117 | | chroom | 28494000 | stuk | 477,00 | 176 | 1 |
| Douchegarnituur | 0450119 | | RVS | 28494800 | stuk | 680,00 | 176 | 1 |
| | AXOR Carlton regendouche z. arm 24cm m. kogelgewricht | | | | | | | |
| Accessoires en spiegels | 0450120 | | chroom | 28474000 | stuk | 577,00 | 176 | 1 |
| | 0450121 | | satinox | 28474810 | stuk | 750,00 | 176 | 1 |
| Douchewanden | | | | | | | | |
| | Hansgrohe douche-armen | | | | | | | |
| | douchearm | | | | | | | |
| Toebehoren & afvoeren | 0602043 | 1/2"x100mm | chroom | 27438000 | stuk | 57,00 | 259 | 1 |
| | 0602045 | 1/2"x100mm | inox | 27438800 | stuk | 95,50 | 259 | 1 |
| | douchearm 1/2"x178mm | | | | | | | |
| Spoel- & installatiesystemen | 0606618 | | chroom | 27433000 | stuk | 155,00 | 259 | 1 |
| | douchearm voor Aktiva hoofddouche | | | | | | | |
| Badkamermeubelen en toiletkasten | 0457450 | | chroom | 27431000 | stuk | 94,50 | 259 | 1 |
| | 0457469 | | satinox | 27431810 | stuk | 128,00 | 259 | 1 |
| | Fixfit slangaansluiting 1/2" | | | | | | | |
| Gootstenen en wastroggen | 0450021 | | chroom | 27451000 | stuk | 25,75 | 176 | 0 |
| Utiliteit | | | | | | | | |
| | douchearm 26cm z. kogelgewricht | | | | | | | |
| | 0450438 | | satinox | 27412810 | stuk | 64,50 | 176 | 1 |
| | 0450461 | | RVS look | 27412800 | stuk | 69,50 | 176 | 1 |
| | 0467330 | | chroom | 27412000 | stuk | 27,25 | 176 | 1 |
| | douchearm 41cm z. kogelgewricht | | | | | | | |
| | 0467331 | | chroom | 27413000 | stuk | 68,50 | 176 | 0 |
| | 0450439 | | satinox | 27413810 | stuk | 90,00 | 176 | 1 |
| | 0450462 | | RVS look | 27413800 | stuk | 97,00 | 176 | 1 |
| | Hansgrohe zijdouches | | | | | | | |
| | Aktiva zijdouche | | | | | | | |
| | 0602132 | 1/2" regelbaar | chroom | 28451000 | stuk | 118,00 | 259 | 0 |
| | 0602140 | 1/2" regelbaar | chroom/goud | 28451090 | stuk | 175,00 | 259 | 1 |
| | Bodyvette zijdouche | | | | | | | |
| | 0603503 | 1/2" m. rub-it | chroom | 28466000 | stuk | 88,50 | 259 | 0 |
| | 0603511 | 1/2" m. rub-it | chroom/goud | 28466090 | stuk | 134,00 | 259 | 1 |
| | 0453188 | 1/2" m. rub-it | inox | 28466810 | stuk | 135,00 | 259 | 1 |
| | 0453201 | 1/2" m. rub-it | RVS | 28466800 | stuk | 135,00 | 259 | 1 |

| Art.nr | Specificaties | Kleur | Lev.nr | Ehd | Prijs | Grp | CC | | |
|---|------------------------|-------------|----------|------|--------|-----|----|---|---|
| | | | | | | | | Hansgrohe zijdouches | |
| Bodyvette zijdouche afsluitbaar 0450019 | | chroom | 28467000 | stuk | 96,00 | 176 | 0 |  | Sanitair producten |
| | | | | | | | | Hansgrohe sauna/fitness programma | |
| Team Steel hoofddouche 0605972 | m. rub-it | RVS | 27489800 | stuk | 223,00 | 259 | 1 |  | Baden / douchebakken / stoomcabines |
| Team sportdouche anti-legionella 0606626 | | chroom | 27487000 | stuk | 226,00 | 259 | 1 |  | Kranen |
| Team Compact sportdouche 0603570 | Compact antilegionella | chroom | 27482000 | stuk | 137,00 | 259 | 1 |  | Douchegarnituur |
| Schwall hoofddouche watervalmodel 0603465 | 1/2" | chroom | 28441000 | stuk | 305,00 | 259 | 1 |  | Accessoires en spiegels |
| 0603457 | 3/4" | chroom | 28440000 | stuk | 507,00 | 259 | 1 | | Douchewanden |
| Clic snelkoppeling 1/2" 0601979 | | grijs | 28346000 | stuk | 23,00 | 259 | 1 | | Toebehoren & afvoeren |
| | | | | | | | | Hansgrohe Medium glijstangen | |
| Unica'D glijstang m. Isiflexslang 160cm 0452327 | 90cm | chroom | 27930000 | stuk | 115,00 | 259 | 0 |  | Badkamermeubelen en toiletkasten |
| 0605336 | 65cm | chroom | 27933000 | stuk | 93,50 | 259 | 0 | | Gootstenen en wastroggen |
| Unica'D hoekmontageset 0603589 | | chroom | 28683000 | stuk | 24,50 | 259 | 1 | | Utiliteit |
| Cassetta'D zeepschaal 0603057 | | transparant | 28689000 | stuk | 25,75 | 259 | 1 |  | |
| | | | | | | | | Hansgrohe Comfort glijstangen | |
| Unica'S glijstang m. Metaflex'C slang 160cm 0605417 | 65cm | chroom | 27725000 | stuk | 56,50 | 259 | 0 |  | |
| 0605409 | 90cm | chroom | 27727000 | stuk | 63,50 | 259 | 0 | | |
| Unica'S glijstang 0600970 | 65cm | chroom | 27712000 | stuk | 44,50 | 259 | 0 |  | |
| 0607777 | 90cm | chroom | 27713000 | stuk | 53,50 | 259 | 1 | | |

| | Art.nr | Specificaties | Kleur | Lev.nr | Ehd | Prijs | Grp | CC | |
|---|---|---------------|----------|----------|----------|--------|-------|-----|---|
| Sanitair producten | Hansgrohe Premium glijstangsets | | | | | | | | |
| | Unica'A glijstangset m. handdouche Aktiva A8 | | | | | | | | |
| | 0605433 | 65cm | chroom | 27861000 | stuk | 255,00 | 259 | 1 | |
| | 0605425 | 90cm | chroom | 27860000 | stuk | 341,00 | 259 | 1 | |
| Baden / douchebakken / stoomcabines | Unica'A glijstangset m. handdouche Aktiva A6 | | | | | | | | |
| | 0605441 | 65cm | chroom | 27863000 | stuk | 225,00 | 259 | 1 | |
| Kranen | Unica'A glijstangset m. handdouche Aktiva A6 | | | | | | | | |
| | 0458252 | 90cm | chroom | 27862000 | stuk | 251,00 | 259 | 1 | |
| Douchegarnituur | Unica'C glijstangset 65cm m. Crometta Vario handdouche | | | | | | | | |
| | 0450137 | | chroom | 27744000 | stuk | 58,00 | 176 | 0 | |
| Accessoires en spiegels | Hansgrohe Medium glijstangsets | | | | | | | | |
| Douchewanden | Unica'D glijstangset m. handdouche Mistral | | | | | | | | |
| | 0605468 | 90cm | chroom | 27990000 | stuk | 204,00 | 259 | 0 | |
| | 0605476 | 65cm | chroom | 27936000 | stuk | 180,00 | 259 | 0 | |
| Toebehoren & afvoeren | Unica'D glijstangset m. handdouche Mistral 3 | | | | | | | | |
| | 0605504 | 60cm | chroom | 27788000 | stuk | 188,00 | 259 | 1 | |
| Spoel- & installatiesystemen | Unica'D glijstangset m. handdouche Mistral 3 | | | | | | | | |
| | 0605502 | 90cm | chroom | 27789000 | stuk | 215,00 | 259 | 1 | |
| Badkamermeubelen en toiletkasten | Unica'B glijstangset m. handdouche Selecta | | | | | | | | |
| | 0605484 | 90cm | chroom | 27780000 | stuk | 161,00 | 259 | 1 | |
| Gootstenen en wastroggen | Unica'B glijstangset m. handdouche Selecta | | | | | | | | |
| | 0605492 | 65cm | chroom | 27781000 | stuk | 154,00 | 259 | 0 | |
| Utiliteit | Unica'S glijstangset m. handdouche Selecta | | | | | | | | |
| | 0457388 | 65cm | chroom | 27785000 | stuk | 122,00 | 259 | 1 | |
| Hansgrohe Comfort glijstangsets | | | | | | | | | |
| Unica'C glijstangset m. handdouche Croma 100 Vario | | | | | | | | | |
| | 0450649 | 90cm | chroom | 27771000 | stuk | 73,50 | 176 | 1 | |
| | 0450650 | 65cm | chroom | 27772000 | stuk | 68,00 | 176 | 1 | |
| | 0450651 | 65cm | 9.4l/min | chroom | 27776000 | stuk | 71,50 | 176 | 1 |
| Unica'C glijstangset m. handdouche Multi 100 | | | | | | | | | |
| | 0450652 | 90cm | chroom | 27774000 | stuk | 92,00 | 176 | 1 | |
| | 0450653 | 65cm | chroom | 27775000 | stuk | 86,50 | 176 | 1 | |
| | 0450654 | 65cm | 9.4l/min | chroom | 27777000 | stuk | 90,00 | 176 | 1 |

| Art.nr | Specificaties | Kleur | Lev.nr | Ehd | Prijs | Grp | CC |
|--------|---------------|-------|--------|-----|-------|-----|----|
|--------|---------------|-------|--------|-----|-------|-----|----|

Hansgrohe Comfort glijstangsets

Unica'S glijstangset m. handdouche Croma 3jet

| | | | | | | | |
|---------|------|--------|----------|------|--------|-----|---|
| 0605514 | 65cm | chroom | 27751000 | stuk | 99,00 | 259 | 0 |
| 0605506 | 90cm | chroom | 27773000 | stuk | 106,00 | 259 | 0 |



Sanitair producten

Baden /
douchebakken /
stoomcabines

Kranen

Douchegarnituur

Accessoires en
spiegels

Douchewanden

Toebehoren &
afvoeren

Spoel- &
installatiesystemen

Badkamermeubelen
en toiletkasten

Gootstenen en
wastroggen

Utiliteit

Unica'S glijstangset m. handdouche Croma 2jet

| | | | | | | | |
|---------|------|--------|----------|------|-------|-----|---|
| 0605530 | 65cm | chroom | 27753000 | stuk | 85,00 | 259 | 0 |
| 0605522 | 90cm | chroom | 27770000 | stuk | 92,00 | 259 | 0 |



Unica'S glijstangset m. handdouche Croma Variojet

| | | | | | | | |
|---------|------|--------|----------|------|-------|-----|---|
| 0605557 | 65cm | chroom | 27755000 | stuk | 77,50 | 259 | 1 |
| 0605549 | 90cm | chroom | 27754000 | stuk | 84,00 | 259 | 1 |



Unica'S glijstangset m. handdouche Croma 1jet

| | | | | | | | |
|---------|------|--------|----------|------|-------|-----|---|
| 0605573 | 65cm | chroom | 27757000 | stuk | 70,00 | 259 | 0 |
| 0605565 | 90cm | chroom | 27756000 | stuk | 77,00 | 259 | 1 |



Hansgrohe wandhouders

Porter'A wandhouder

| | | | | | | | |
|---------|--|---------|----------|------|-------|-----|---|
| 0605271 | | chroom | 27520000 | stuk | 62,50 | 259 | 1 |
| 0458244 | | satinox | 27520810 | stuk | 83,50 | 259 | 1 |



Porter'E wandhouder z. slang

| | | | | | | | |
|---------|--|-----------|----------|------|-------|-----|---|
| 0605629 | | chroom | 27504000 | stuk | 48,50 | 259 | 1 |
| 0605633 | | matchroom | 27504880 | stuk | 63,00 | 259 | 1 |



Porter'E wandhouder m. slang

| | | | | | | | |
|---------|--|-------------|----------|------|--------|-----|---|
| 0605621 | | chroom | 27507000 | stuk | 53,00 | 259 | 1 |
| 0605623 | | chroom/goud | 27507090 | stuk | 128,00 | 259 | 1 |
| 0605625 | | satinox | 27507810 | stuk | 116,00 | 259 | 1 |
| 0605627 | | matchroom | 27507880 | stuk | 116,00 | 259 | 1 |

Porter'D wandhouder









| | | | | | | | |
|---------|--|--------|----------|------|-------|-----|---|
| 0452335 | | chroom | 27526000 | stuk | 27,25 | 259 | 0 |
|---------|--|--------|----------|------|-------|-----|---|



Porter'C wandhouder

| | | | | | | | |
|---------|--|---------|----------|------|-------|-----|---|
| 0603546 | | chroom | 27521000 | stuk | 15,50 | 259 | 0 |
| 0603700 | | satinox | 27521810 | stuk | 19,75 | 259 | 1 |



| | Art.nr | Specificaties | Kleur | Lev.nr | Ehd | Prijs | Grp | CC |
|---|---|----------------|---------|----------|------|-------|-----|----|
| Hansgrohe wandhouders | | | | | | | | |
| Sanitair producten | Universeel wandhouder | | | | | | | |
| | 0601764 | | chrom | 28321000 | stuk | 15,75 | 259 | 0 |
| Baden / douchebakken / stoomcabines |  | | | | | | | |
| Hansgrohe badsets | | | | | | | | |
| Kranen | Porter'S wandhouder m. handdouche Cromo 100 Vario | | | | | | | |
| | 0450643 | m. slang 125cm | chrom | 27592000 | stuk | 43,00 | 176 | 1 |
| | 0450644 | m. slang 160cm | chrom | 27594000 | stuk | 44,75 | 176 | 1 |
| Douchegarnituur | Porter'S wandhouder m. handdouche Cromo 100 Multi | | | | | | | |
| | 0450645 | m. slang 125cm | chrom | 27593000 | stuk | 60,00 | 176 | 1 |
| | 0450646 | m. slang 160cm | chrom | 27595000 | stuk | 64,00 | 176 | 1 |
| Accessoires en spiegels | Porter'C wandhouder m. handdouche Cromo 3jet | | | | | | | |
| | 0605646 | m. slang 125cm | chrom | 27549000 | stuk | 73,50 | 259 | 0 |
| | 0450647 | m. slang 160cm | chrom | 27584000 | stuk | 37,00 | 176 | 1 |
| Douchewanden |  | | | | | | | |
| Toebehoren & afvoeren | Porter'C wandhouder m. handdouche Cromo 2jet | | | | | | | |
| | 0605654 | m. slang 125cm | chrom | 27535000 | stuk | 59,00 | 259 | 0 |
| | 0450648 | m. slang 160cm | chrom | 27534000 | stuk | 60,00 | 176 | 1 |
| Spoel- & installatiesystemen |  | | | | | | | |
| Badkamermeubelen en toiletkasten | Porter'C wandhouder m. handdouche Cromo Variojet | | | | | | | |
| | 0604976 | | chrom | 27547000 | stuk | 51,00 | 259 | 0 |
| Badkamermeubelen en toiletkasten |  | | | | | | | |
| Gootstenen en wastroggen | Porter'C wandhouder m. handdouche Cromo 1jet | | | | | | | |
| | 0603198 | | chrom | 27539000 | stuk | 42,50 | 259 | 0 |
| Gootstenen en wastroggen |  | | | | | | | |
| Utiliteit | Fixfit muuraansluitbocht 1/2" | | | | | | | |
| | 0601845 | | chrom | 27454000 | stuk | 21,25 | 259 | 0 |
| | 0601850 | | satinox | 27454810 | stuk | 29,50 | 259 | 1 |
| Utiliteit |  | | | | | | | |
| Utiliteit | Fixfit muuraansluitbocht 1/2" m. terugslagklep | | | | | | | |
| | 0603422 | | chrom | 27458000 | stuk | 57,00 | 259 | 0 |
| | 0451040 | | satinox | 27458810 | stuk | 58,00 | 259 | 1 |
| Utiliteit |  | | | | | | | |
| Utiliteit | Fixfit muuraansluitbocht 1/2" m. stopkraan | | | | | | | |
| | 0601840 | | chrom | 27452000 | stuk | 70,00 | 259 | 1 |
| Utiliteit |  | | | | | | | |

| Art.nr | Specificaties | Kleur | Lev.nr | Ehd | Prijs | Grp | CC |
|--------|---------------|-------|--------|-----|-------|-----|----|
|--------|---------------|-------|--------|-----|-------|-----|----|

Hansgrohe badsets

Fixfit AXOR Steel muuraansluitbocht 1/2"
0450464

| | | | | | |
|-----|----------|------|-------|-----|---|
| RVS | 35884800 | stuk | 68,00 | 176 | 0 |
|-----|----------|------|-------|-----|---|

Fixfit AXOR Starck muuraansluitbocht 1/2" m. stopkraan
0450478

| | | | | | |
|-------|----------|------|--------|-----|---|
| chrom | 10882000 | stuk | 144,00 | 176 | 1 |
|-------|----------|------|--------|-----|---|



Sanitair producten

Baden /
douchebakken /
stoomcabines

Kranen

Hansgrohe Premium doucheslangen

Novaflex'A doucheslang

| | | | | | | | |
|---------|------------|------------|----------|------|-------|-----|---|
| 0602183 | 1/2"x125cm | chrom | 28292000 | stuk | 40,25 | 259 | 0 |
| 0602191 | 1/2"x125cm | chrom/goud | 28292090 | stuk | 69,00 | 259 | 1 |
| 0606553 | 1/2"x125cm | RVS | 28292800 | stuk | 57,50 | 259 | 1 |
| 0450446 | 1/2"x125cm | satin | 28292810 | stuk | 53,50 | 176 | 1 |
| 0602221 | 1/2"x160cm | chrom | 28296000 | stuk | 42,75 | 259 | 1 |
| 0602248 | 1/2"x160cm | chrom/goud | 28296090 | stuk | 70,50 | 259 | 1 |
| 0606561 | 1/2"x160cm | RVS | 28296800 | stuk | 60,50 | 259 | 1 |
| 0450447 | 1/2"x160cm | satin | 28296810 | stuk | 56,00 | 176 | 1 |
| 0603414 | 1/2"x200cm | chrom | 28294000 | stuk | 52,00 | 259 | 1 |
| 0606588 | 1/2"x200cm | RVS | 28294800 | stuk | 73,50 | 259 | 1 |
| 0450449 | 1/2"x200cm | satin | 28294810 | stuk | 68,50 | 176 | 1 |



Douchegarnituur

Accessoires en
spiegels

Douchewanden

Hansgrohe Medium doucheslangen

Isiflex'B doucheslang

| | | | | | | | |
|---------|------------|----------|----------|------|-------|-----|---|
| 0603236 | 1/2"x125cm | chrom | 28272000 | stuk | 20,75 | 259 | 0 |
| 0443859 | 1/2"x125cm | RVS-look | 28272800 | stuk | 29,00 | 259 | 1 |
| 0443867 | 1/2"x125cm | satin | 28272810 | stuk | 27,00 | 259 | 1 |
| 0603244 | 1/2"x160cm | chrom | 28276000 | stuk | 22,50 | 259 | 0 |
| 0443883 | 1/2"x160cm | RVS-look | 28276800 | stuk | 31,00 | 259 | 1 |
| 0443891 | 1/2"x160cm | satin | 28276810 | stuk | 28,75 | 259 | 1 |
| 0603287 | 1/2"x200cm | chrom | 28274000 | stuk | 24,00 | 259 | 0 |



Toebehoren &
afvoeren

Spoel- &
installatiesystemen

Isiflex Starck doucheslang

| | | | | | | | |
|---------|------------|-------|----------|------|-------|-----|---|
| 0605085 | 1/2"x125cm | chrom | 28282000 | stuk | 36,75 | 259 | 0 |
| 0605093 | 1/2"x160cm | chrom | 28286000 | stuk | 43,25 | 259 | 0 |
| 0605107 | 1/2"x200cm | chrom | 28284000 | stuk | 44,00 | 259 | 1 |

Badkamermeubelen
en toiletkasten

Hansgrohe Comfort doucheslangen

Metaflex'C doucheslang

| | | | | | | | |
|---------|------------|-------|----------|------|-------|-----|---|
| 0602302 | 1/2"x125cm | chrom | 28262000 | stuk | 10,75 | 259 | 0 |
| 0606316 | 1/2"x150cm | chrom | 28263000 | stuk | 11,75 | 259 | 0 |
| 0603406 | 1/2"x160cm | chrom | 28266000 | stuk | 11,75 | 259 | 0 |
| 0606324 | 1/2"x175cm | chrom | 28265000 | stuk | 13,50 | 259 | 0 |
| 0602337 | 1/2"x200cm | chrom | 28264000 | stuk | 15,50 | 259 | 0 |



Gootstenen en
wastroggen

Utiliteit

Hansgrohe Raindance

handdouche 15cm

| | | | | | | | |
|---------|--|-------|----------|------|-------|-----|---|
| 0443913 | | chrom | 28500000 | stuk | 93,50 | 259 | 0 |
| 0450362 | | wit | 28500450 | stuk | 92,50 | 176 | 1 |



handdouche softgreep 15cm

| | | | | | | | |
|---------|--|-------|----------|------|--------|-----|---|
| 0443921 | | chrom | 28501000 | stuk | 104,00 | 259 | 0 |
|---------|--|-------|----------|------|--------|-----|---|









E150 Air 3jet handdouche

| | | | | | | | |
|---------|----------------------------|-------|----------|------|-------|-----|---|
| 0450325 | | chrom | 28518000 | stuk | 93,50 | 176 | 1 |
| 0450567 | doorstroombeogr. 9,5 l/min | chrom | 28551000 | stuk | 93,50 | 259 | 1 |



| | Art.nr | Specificaties | Kleur | Lev.nr | Ehd | Prijs | Grp | CC |
|---|---|---------------------------|-----------|----------|------|--------|-----|----|
| | Hansgrohe Raindance | | | | | | | |
| Sanitair producten | S150 Air 3jet handdouche | | | | | | | |
| | 0450326 | | chroom | 28519000 | stuk | 117,00 | 176 | 0 |
| | 0450327 | | matchroom | 28519880 | stuk | 152,00 | 176 | 1 |
| | 0450568 | doorstroombegr. 9,5 l/min | chroom | 28550000 | stuk | 117,00 | 259 | 1 |
| Baden / douchebakken / stoomcabines | | | | | | | | |
| Kranen | E120 Air 3jet handdouche | | | | | | | |
| | 0450328 | | chroom | 28507000 | stuk | 82,00 | 176 | 1 |
| Douche­garnituur | | | | | | | | |
| Accessoires en spiegels | S120 Air 3jet handdouche | | | | | | | |
| | 0450329 | | chroom | 28514000 | stuk | 106,00 | 176 | 0 |
| | 0450330 | | matchroom | 28514880 | stuk | 137,00 | 176 | 1 |
| Douchewanden | | | | | | | | |
| Toebehoren & afvoeren | E100 Air 3jet handdouche | | | | | | | |
| | 0450331 | | chroom | 28502000 | stuk | 70,50 | 176 | 1 |
| | 0450569 | doorstroombegr. 9,5 l/min | chroom | 28553000 | stuk | 70,50 | 259 | 1 |
| Spoel- & installatiesystemen | | | | | | | | |
| Badkamermeubelen en toiletkasten | E100 Air 1jet handdouche | | | | | | | |
| | 0450334 | | chroom | 28508000 | stuk | 46,75 | 176 | 1 |
| Gootstenen en wastroggen | | | | | | | | |
| Utiliteit | S100 Air 3jet handdouche | | | | | | | |
| | 0450332 | | chroom | 28504000 | stuk | 93,50 | 176 | 0 |
| | 0450333 | | matchroom | 28504880 | stuk | 122,00 | 176 | 1 |
| | 0450570 | doorstroombegr. 9,5 l/min | chroom | 28552000 | stuk | 93,50 | 259 | 1 |
| | S100 Air 1jet handdouche | | | | | | | |
| | 0450335 | | chroom | 28509000 | stuk | 70,50 | 176 | 0 |
| | 0450337 | | RVS | 28509800 | stuk | 98,50 | 176 | 1 |
| | 0450338 | | satinox | 28509810 | stuk | 91,50 | 176 | 1 |
| | 0450339 | | matchroom | 28509880 | stuk | 91,50 | 176 | 1 |
| | Allrounder doucheset draaibaar m. handdouche | | | | | | | |
| | 0444014 | | chroom | 28100000 | stuk | 345,00 | 259 | 0 |
| | Allrounder E150 Air 3-jet | | | | | | | |
| | 0450546 | | chroom | 28110000 | stuk | 345,00 | 259 | 0 |
| | inbouwadapter voor Raindance Allrounder | | | | | | | |
| | 0444022 | | chroom | 28108000 | stuk | 45,75 | 259 | 1 |

| Art.nr | Specificaties | Kleur | Lev.nr | Ehd | Prijs | Grp | CC | |
|--|---------------|-----------|----------|------|--------|-----|----|---|
| | | | | | | | | Hansgrohe Raindance |
| hoekmontageset voor Raindance Allrounder 0444030 | | chrom | 28105000 | stuk | 26,50 | 259 | 1 | |
| Unica glijstang 90cm m. doucheslang 0443948 | | chrom | 27590000 | stuk | 215,00 | 259 | 0 |  |
| Unica glijstangset 90cm 0443972 | | chrom | 27870000 | stuk | 293,00 | 259 | 0 |  |
| Unica'S Puro glijstang m. doucheslang 160cm 0450312 90cm | | chrom | 28631000 | stuk | 88,00 | 176 | 0 | |
| 0450313 90cm | | matchroom | 28631880 | stuk | 115,00 | 176 | 1 | |
| 0450314 65cm | | chrom | 28632000 | stuk | 82,00 | 176 | 0 | |
| 0450315 65cm | | matchroom | 28632880 | stuk | 107,00 | 176 | 1 | |
| Unica'S Puro opvulstukje glijstang 0450309 | | chrom | 97450000 | stuk | 7,40 | 176 | 1 | |
| 0450311 | | matchroom | 97459880 | stuk | 8,00 | 176 | 1 | |
| Unica glijstangset m. E150 Air 3jet handdouche 0450350 90cm | | chrom | 27874000 | stuk | 293,00 | 176 | 0 | |
| Unica glijstangset m. E150 Air 3jet handdouche m. zeepschaal 0450351 150cm | | chrom | 27888000 | stuk | 345,00 | 176 | 1 | |
| Unica glijstangset 150cm m. zeepschaal 0443999 | | chrom | 27875000 | stuk | 345,00 | 259 | 0 |  |
| Unica'D glijstangset m. E120 Air 3jet handdouche 0450346 90cm | | chrom | 27885000 | stuk | 170,00 | 176 | 1 | |
| 0450347 65cm | | chrom | 27887000 | stuk | 164,00 | 176 | 1 |  |
| Unica'S glijstangset m. E120 Air 3jet handdouche 0450348 90cm | | chrom | 27884000 | stuk | 182,00 | 176 | 0 | |
| 0450349 65cm | | chrom | 27886000 | stuk | 176,00 | 176 | 1 |  |
| Unica'D glijstangset m. E100 Air 3jet handdouche 0450342 90cm | | chrom | 27881000 | stuk | 158,00 | 176 | 1 | |
| 0450343 65cm | | chrom | 27883000 | stuk | 152,00 | 176 | 1 |  |

Sanitair producten

Baden /
douchebakken /
stoomcabines

Kranen

Douchegarnituur

Accessoires en
spiegels

Douchewanden

Toebehoren &
afvoeren





Spoel- &
installatiesystemen

Badkamermeubelen
en toiletkasten

Gootstenen en
wastroggen

Utiliteit

| | Art.nr | Specificaties | Kleur | Lev.nr | Ehd | Prijs | Grp | CC |
|---|---|---------------------------|--------|----------|------|--------|-----|----|
| Sanitair producten | Hansgrohe Raindance | | | | | | | |
| | Unica'S glijstangset m. S100 Air 3jet | | | | | | | |
| | 0450344 | 90cm | chroom | 27880000 | stuk | 170,00 | 176 | 1 |
| | 0450345 | 65cm | chroom | 27882000 | stuk | 164,00 | 176 | 1 |
| Baden / douchebakken / stoomcabines | | | | | | | | |
| Kranen | Porter'D doucheset m. E100 Air 1jet handdouche | | | | | | | |
| | 0450353 | m. doucheslang 125cm | chroom | 27572000 | stuk | 76,00 | 176 | 0 |
| | 0450354 | m. doucheslang 160cm | chroom | 27573000 | stuk | 79,50 | 176 | 1 |
| Douchegarnituur | | | | | | | | |
| Accessoires en spiegels | Porter'S doucheset m. S100 Air 1jet handdouche | | | | | | | |
| | 0450355 | m. doucheslang 125cm | chroom | 27580000 | stuk | 88,00 | 176 | 0 |
| | 0450356 | m. doucheslang 160cm | chroom | 27581000 | stuk | 91,50 | 176 | 0 |
| Douchewanden | | | | | | | | |
| Toebehoren & afvoeren | hoekmontageset voor glijstang 90cm Raindance Unica | | | | | | | |
| | 0443964 | (3 wandsteunen) | | 28696000 | stuk | 26,25 | 259 | 0 |
| | zeepschaal voor glijstang Raindance Unica | | | | | | | |
| | 0444006 | | | 28698000 | stuk | 60,00 | 259 | 1 |
| Spoel- & installatiesystemen | | | | | | | | |
| Badkamermeubelen en toiletkasten | opvulschijf voor glijstang Raindance Unica | | | | | | | |
| | 0443956 | 7mm | chroom | 28697000 | stuk | 6,30 | 259 | 1 |
| Gootstenen en wastroggen | hoofddouche 18cm m. douchearm 23cm | | | | | | | |
| | 0458260 | | chroom | 27471000 | stuk | 297,00 | 259 | 0 |
| Utiliteit | hoofddouche 18cm m. plafondbevestiging | | | | | | | |
| | 0459852 | | chroom | 27472000 | stuk | 266,00 | 259 | 0 |
| | 0444065 | | satin | 27472810 | stuk | 345,00 | 259 | 1 |
| | hoofddouche m. air 18cm m. douchearm 23cm | | | | | | | |
| | 0444103 | | chroom | 27476000 | stuk | 357,00 | 259 | 0 |
| | 0450565 | doorstroombegr. 9,5 l/min | chroom | 27462000 | stuk | 357,00 | 259 | 1 |
| | hoofddouche m. air 18cm m. plafondbevestiging | | | | | | | |
| | 0444138 | | chroom | 27478000 | stuk | 332,00 | 259 | 0 |
| | 0450566 | doorstroombegr. 9,5 l/min | chroom | 27464000 | stuk | 332,00 | 259 | 1 |
| | hoofddouche m. air 24cm m. douchearm 38cm | | | | | | | |
| | 0444111 | | chroom | 27474000 | stuk | 468,00 | 259 | 0 |
| | 0450563 | doorstroombegr. 9,5 l/min | chroom | 27461000 | stuk | 468,00 | 259 | 1 |

| Art.nr | Specificaties | Kleur | Lev.nr | Ehd | Prijs | Grp | CC | |
|--|---|--------------|----------|------|---------|-----|----|---|
| Hansgrohe Raindance | | | | | | | | |
| hoofddouche m. air 24cm m. plafondbevestiging | | | | | | | |  |
| 0444146 | | chrom | 27477000 | stuk | 431,00 | 259 | 0 | |
| 0450564 | doorstroombegr. 9,5 l/min | chrom | 27463000 | stuk | 431,00 | 259 | 1 | |
| plafondaansluiting voor hoofddouche | | | | | | | | |
| 0450549 | | chrom | 27469000 | stuk | 47,00 | 259 | 1 | |
| 0450551 | | RVS | 27469800 | stuk | 66,00 | 259 | 1 | |
| 0450552 | | satin | 27469810 | stuk | 70,50 | 259 | 1 | |
| fixatie voor douchearm van hoofddouche | | | | | | | | |
| 0450293 | | RVS | 27423800 | stuk | 80,50 | 176 | 1 | |
| 0450294 | | satinox | 27423810 | stuk | 74,50 | 176 | 1 | |
| verlengset voor hoofddouche met plafondbevestiging | | | | | | | | |
| 0444073 | 10cm | chrom | 27479000 | stuk | 42,50 | 259 | 0 | |
| 0444081 | 10cm | satin | 27479810 | stuk | 55,50 | 259 | 1 | |
| Royal Air hoofddouche 35cm m. kogelscharnier | | | | | | | |  |
| 0452096 | 3/4" | chrom | 28420000 | stuk | 1285,00 | 259 | 1 | |
| douchearm 3/4" 47 cm voor hoofddouche Raindance Royal | | | | | | | | |
| 0456883 | | chrom | 27410000 | stuk | 235,00 | 259 | 1 | |
| Royal Air hoofddouche + kleurset Highflow inbouwthermostaat | | | | | | | | |
| 0450156 | Ecostat | chrom | 27070000 | stuk | 1523,00 | 176 | 1 | |
| 0456883 | douchearm 3/4" 47 cm voor hoofddouche Raindance Royal | chrom | 27410000 | stuk | 235,00 | 259 | 1 | |
| 0456884 | plafondaansluiting 10 cm m. bevestiging m. rozet 3/4" | chrom | 27418000 | stuk | 170,00 | 259 | 1 | |
| 0457051 | basisgarnituur I-box universeel | | 01800180 | stuk | 107,00 | 176 | 0 | |
| plafondaansluiting 10 cm m. bevestiging m. rozet | | | | | | | | |
| 0456884 | 3/4" | chrom | 27418000 | stuk | 170,00 | 259 | 1 | |
| kleurset Highflow voor inbouwthermostaat | | | | | | | | |
| 0450281 | | chrom | 15715000 | stuk | 422,00 | 176 | 1 | |
| kleurset voor stopkraan 1/2" | | | | | | | | |
| 0450282 | | chrom | 15972000 | stuk | 64,00 | 176 | 1 | |
| kleurset voor omstelkraan Quattro | | | | | | | | |
| 0450283 | | chrom | 15932000 | stuk | 85,00 | 176 | 1 | |
| Rainmaker hoofddouche 60cm | | | | | | | |  |
| 0450371 | z. verlichting | chrom | 28403000 | stuk | 3330,00 | 176 | 1 | |
| 0450372 | m. verlichting | chrom | 28404000 | stuk | 3914,00 | 176 | 1 | |
| I-module | | | | | | | | |
| 0450370 | | | 13615180 | stuk | 1040,00 | 176 | 1 | |
| Rainmaker basisgarnituur | | | | | | | | |
| 0450547 | | | 28412180 | stuk | 88,00 | 259 | 1 | |
| inbouw douchepaneel | | | | | | | |  |
| 0452091 | | satin/chroom | 27100000 | stuk | 1542,00 | 259 | 1 | |
| 0457051 | basisgarnituur I-box universeel | | 01800180 | stuk | 107,00 | 176 | 0 | |

Sanitair producten

Baden /
douchebakken /
stoomcabines

Kranen





Douchegarnituur









Accessoires en
spiegels

Douchewanden

Toebehoren &
afvoerenSpoel- &
installatiesystemenBadkamermeubelen
en toiletkastenGootstenen en
wastroggen

Utiliteit

| | Art.nr | Specificaties | Kleur | Lev.nr | Ehd | Prijs | Grp | CC |
|---|---|---------------|-----------------|----------|------|--------|-----|----|
| | Hansgrohe Raindance | | | | | | | |
| | zijdouche voor paneel | | | | | | | |
| Sanitair producten | 0452093 | Normaal | chrom | 28406000 | stuk | 10,75 | 259 | 1 |
| | 0452094 | Massage | chrom | 28408000 | stuk | 10,75 | 259 | 1 |
| | 0452095 | Nevel | chrom | 28409000 | stuk | 10,75 | 259 | 1 |
| | Porter'S wandhouder | | | | | | | |
| Baden / douchebakken / stoomcabines | 0450357 | | chrom | 28331000 | stuk | 17,25 | 176 | 0 |
| | 0450359 | | RVS | 28331800 | stuk | 23,50 | 176 | 1 |
| | 0450360 | | satinox | 28331810 | stuk | 22,25 | 176 | 1 |
| | 0450361 | | matchroom | 28331880 | stuk | 22,25 | 176 | 1 |
| | Casseta'D Puro zeepschaal | | | | | | | |
| Kranen | 0450306 | | chrom | 28679000 | stuk | 25,75 | 176 | 1 |
| | Hansgrohe Citterio | | | | | | | |
| | hoofdouche | | | | | | | |
| Douchegarnituur | 0467329 | | chrom | 28489000 | stuk | 432,00 | 176 | 1 |
| | rozet voor douchearm | | | | | | | |
| | 0467332 | | chrom | 27419000 | stuk | 99,00 | 176 | 1 |
| Accessoires en spiegels | glijstangset compleet 90cm | | | | | | | |
| | 0467333 | | chrom | 27981000 | stuk | 408,00 | 176 | 1 |
| Douchewanden |  | | | | | | | |
| | wandhouder konisch | | | | | | | |
| Toebehoren & afvoeren | 0467334 | | chrom | 27544000 | stuk | 25,25 | 176 | 1 |
| | Hansgrohe Montreux | | | | | | | |
| | handdouche | | | | | | | |
| Spoel- & installatiesystemen | 0451203 | | chrom | 16320000 | stuk | 142,00 | 259 | 1 |
| | 0451204 | | brushed nikkel | 16320820 | stuk | 218,00 | 259 | 1 |
| | 0451205 | | polished nikkel | 16320830 | stuk | 189,00 | 259 | 1 |
| Badkamermeubelen en toiletkasten | glijstangset m. handdouche compleet | | | | | | | |
| | 0451206 | | chrom | 27982000 | stuk | 426,00 | 259 | 1 |
| | 0451207 | | brushed nikkel | 27982820 | stuk | 652,00 | 259 | 1 |
| | 0451208 | | polished nikkel | 27982830 | stuk | 565,00 | 259 | 1 |
| Gootstenen en wastroggen |  | | | | | | | |
| | Fix Fit muuraansluitbocht | | | | | | | |
| Utiliteit | 0451209 | | chrom | 16884000 | stuk | 29,75 | 176 | 1 |
| | 0451210 | | brushed nikkel | 16884820 | stuk | 46,00 | 176 | 1 |
| | 0451211 | | polished nikkel | 16884830 | stuk | 40,00 | 176 | 1 |
| |  | | | | | | | |
| | wandhouder | | | | | | | |
| | 0451212 | | chrom | 16325000 | stuk | 71,00 | 176 | 1 |
| | 0451213 | | brushed nikkel | 16325820 | stuk | 109,00 | 176 | 1 |
| | 0451214 | | polished nikkel | 16325830 | stuk | 94,50 | 176 | 1 |
| |  | | | | | | | |
| | Hansgrohe Philippe Starck | | | | | | | |
| | handdouche regelbaar m. quiclean | | | | | | | |
| | 0452319 | | chrom | 28530000 | stuk | 86,00 | 259 | 1 |

| Art.nr | Specificaties | Kleur | Lev.nr | Ehd | Prijs | Grp | CC | |
|---|-------------------------|----------|----------|------|--------|-----|----|---|
| Hansgrohe Philippe Starck | | | | | | | | |
| handdouche staafmodel m. normale straal m. quiclean 0453420 | | chroom | 28531000 | stuk | 120,00 | 259 | 0 |  |
| hoofddouche staafmodel 0605077 | | chroom | 27490000 | stuk | 132,00 | 259 | 1 |  |
| regendouche z. douchearm 0450436 | | chroom | 28484000 | stuk | 322,00 | 176 | 0 |  |
| glijstangset 90cm compleet 0450025 | | chroom | 27980000 | stuk | 360,00 | 259 | 0 |  |
| Porter wandhouder 0450023 | | chroom | 27515000 | stuk | 29,00 | 176 | 0 |  |
| Hansgrohe AXOR Starck X | | | | | | | | |
| handdouche m. normale + softstraal 0450299 | | chroom | 28532000 | stuk | 121,00 | 176 | 0 |  |
| Hansgrohe Steel | | | | | | | | |
| handdouche m. quiclean 0606367 | | RVS | 35852800 | stuk | 170,00 | 259 | 0 |  |
| handdouche staafmodel m. normale straal m. quiclean 0450459 | | RVS look | 28531800 | stuk | 169,00 | 176 | 0 |  |
| hoofddouche 18cm 0450460 | m. kogelgewricht z. arm | RVS look | 28484800 | stuk | 445,00 | 176 | 1 |  |

Sanitair producten

Baden /
douchebakken /
stoomcabines

Kranen

Douchegarnituur

Accessoires en
spiegels

Douchewanden

Toebehoren &
afvoeren

Spoel- &
installatiesystemen



Badkamermeubelen
en toiletkasten

Gootstenen en
wastroggen

Utiliteit

Doucheprogramma Hansgrohe

| | Art.nr | Specificaties | Kleur | Lev.nr | Ehd | Prijs | Grp | CC |
|---|---|---|---------|----------|------|--------|-----|----|
| Sanitair producten | Hansgrohe Steel | | | | | | | |
| | | glijstang m. doucheslang z. handdouche | | | | | | |
| | 0450165 | | RVS | 27941800 | stuk | 240,00 | 176 | 0 |
| Baden / douchebakken / stoomcabines |  | | | | | | | |
| Kranen | wandhouder voor handdouche | | | | | | | |
| | 0466735 | | RVS | 35512800 | stuk | 90,00 | 176 | 0 |
| Douchegarnituur |  | | | | | | | |
| Accessoires en spiegels | Hansgrohe Carlton | | | | | | | |
| | | handdouche verstelbaar | | | | | | |
| | 0452731 | | chrom | 17850000 | stuk | 133,00 | 218 | 1 |
| Douchewanden |  | | | | | | | |
| Toebehoren & afvoeren | hoofddouche 18cm | | | | | | | |
| | 0450113 | m. kogelgewricht z. arm | chrom | 28487000 | stuk | 391,00 | 176 | 1 |
| | 0450114 | m. kogelgewricht z. arm | satinox | 28487810 | stuk | 509,00 | 176 | 1 |
| |  | | | | | | | |
| Spoel- & installatiesystemen | Hansgrohe Terrano | | | | | | | |
| | | handdouche m. quiclean | | | | | | |
| | 0452881 | | chrom | 36850000 | stuk | 115,00 | 259 | 0 |
| | 0456225 | | satinox | 36850810 | stuk | 160,00 | 259 | 1 |
| |  | | | | | | | |
| Badkamermeubelen en toiletkasten | hoofddouche Ø179mm voor douchearm | | | | | | | |
| | 0456233 | | chrom | 28485000 | stuk | 305,00 | 259 | 1 |
| | 0456241 | | satinox | 28485810 | stuk | 399,00 | 259 | 1 |
| |  | | | | | | | |
| Gootstenen en wastroggen | glijstangset 90cm | | | | | | | |
| | 0606901 | | chrom | 27976000 | stuk | 428,00 | 259 | 1 |
| Utiliteit |  | | | | | | | |
| | Hansgrohe Uno | | | | | | | |
| | | handdouche m. quiclean | | | | | | |
| | 0457175 | | chrom | 38850000 | stuk | 125,00 | 259 | 0 |
| |  | | | | | | | |
| | glijstangset compleet 90cm | | | | | | | |
| | 0457183 | | chrom | 27985000 | stuk | 387,00 | 259 | 0 |
| |  | | | | | | | |

| Art.nr | Specificaties | Kleur | Lev.nr | Ehd | Prijs | Grp | CC | |
|--|-------------------------------|-------|----------|------|--------|-----|----|---|
| Hansgrohe Uno | | | | | | | | |
| Fixit AXOR Uno muuraansluitbocht 1/2" m. stopkraan 0457167 | | chrom | 38882000 | stuk | 140,00 | 259 | 1 |  |
| Raindance Puro Air handdouche | | | | | | | | |
| 0456885 | | chrom | 28505000 | stuk | 92,50 | 259 | 0 |  |
| 0456886 | | satin | 28505810 | stuk | 120,00 | 259 | 1 | |
| 0450150 | | RVS | 28505800 | stuk | 144,00 | 176 | 0 | |
| Rainbow glijstangset compleet | | | | | | | | |
| 0456887 | | chrom | 27876000 | stuk | 328,00 | 259 | 0 |  |
| opvulschijfje voor Rainbow | | | | | | | | |
| 0456889 | | | 28699000 | stuk | 6,20 | 259 | 1 | |
| Hansgrohe Onderdelen | | | | | | | | |
| 0603538 | Unica Standaard scharnierstuk | chrom | 28650000 | stuk | 13,00 | 259 | 0 | |
| 0601691 | Unica'88/Unica'S schuifstuk | chrom | 28672000 | stuk | 20,75 | 259 | 0 | |
| 0601713 | Unica'E schuifstuk | chrom | 96170000 | stuk | 40,75 | 259 | 1 | |
| 0603600 | Unica'D opvulstuk | chrom | 96186000 | stuk | 6,20 | 259 | 1 | |
| 0601806 | Unica'B opvulschijfjes | grijs | 96222000 | stuk | 6,20 | 259 | 1 | |
| 0601808 | Unica'S opvulschijfjes | grijs | 96184000 | stuk | 5,70 | 259 | 1 | |

Sanitair producten

Baden /
douchebakken /
stoomcabines

Kranen

Douchegarnituur

Accessoires en
spiegels

Douchewanden

Toebehoren &
afvoeren









Spoel- &
installatiesystemen







Badkamermeubelen
en toiletkasten

Gootstenen en
wastroggen







Utiliteit

Doucheprogramma Ideal Standard

| | Art.nr | Specificaties | Kleur | Lev.nr | Ehd | Prijs | Grp | CC |
|---|---|--|---------|---------|--------|--------|-----|----|
| Sanitair producten |  | Ideal Standard Alfieri | | | | | | |
| | | glijstangcombinatie 0180064 | chrom | A4942AA | stuk | 250,00 | 179 | 1 |
| Baden / douchebakken / stoomcabines |  | doucheset 0180065 | | | | | | |
| Kranen | | chrom | A4943AA | stuk | 156,00 | 179 | 1 | |
| Douchegarnituur |  | Ideal Standard Celia | | | | | | |
| Accessoires en spiegels | | glijstangcombinatie 0180062 | chrom | A3483AA | stuk | 266,00 | 179 | 1 |
| Douchewanden |  | doucheset 0180063 | | | | | | |
| Toebehoren & afvoeren | | chrom | A3484AA | stuk | 168,00 | 179 | 1 | |
| Spoel- & installatiesystemen |  | Ideal Standard Cerawell 100 | | | | | | |
| Badkamermeubelen en toiletkasten | | glijstangcombinatie 70cm 0180070 | chrom | B2693AA | stuk | 63,50 | 179 | 1 |
| Gootstenen en wastroggen |  | badset 0180071 | | | | | | |
| | | chrom | B2695AA | stuk | 39,50 | 179 | 1 | |
| Utiliteit |  | Ideal Standard Cerawell 200 | | | | | | |
| | | glijstangcombinatie 60cm 0180072 | chrom | A3309AA | stuk | 121,00 | 179 | 1 |
| |  | badset 0180073 | | | | | | |
| | | chrom | A3315AA | stuk | 60,00 | 179 | 1 | |
| |  | Ideal Standard Cerawell 200S | | | | | | |
| | | glijstangset 60cm 3F 0180074 | chrom | A3321AA | stuk | 132,00 | 179 | 1 |
| | | badset 3F 0180075 | | | | | | |
| | | chrom | A3324AA | stuk | 69,00 | 179 | 1 | |
| | | Ideal Standard Cerawell 300 | | | | | | |
| | | glijstangcombinatie 62cm 0180077 | chrom | A3325AA | stuk | 179,00 | 179 | 1 |

| Art.nr | Specificaties | Kleur | Lev.nr | Ehd | Prijs | Grp | CC | | |
|---|---------------|--------|---------|------|--------|-----|----|---|---|
| Ideal Standard Cerawell 300 | | | | | | | | | |
| glijstangcombinatie 92cm 0180080 | | chroom | A3326AA | stuk | 191,00 | 179 | 1 |  | Sanitair producten |
| badset 3F 0180082 | | chroom | A3331AA | stuk | 138,00 | 179 | 1 | | Baden / douchebakken / stoomcabines |
| Ideal Standard Cerawell 300S | | | | | | | | | |
| glijstangcombinatie 3F 62cm 0180084 | | chroom | A3336AA | stuk | 263,00 | 179 | 1 |  | Kranen |
| glijstangcombinatie 3F 92cm 0180092 | | chroom | A3337AA | stuk | 278,00 | 179 | 1 | | Accessoires en spiegels |
| badset 3F 0180093 | | chroom | A3341AA | stuk | 162,00 | 179 | 1 | | Douchewanden |
| Ideal Standard Marc Newson | | | | | | | | | |
| glijstangcombinatie 0180066 | | chroom | A4939AA | stuk | 244,00 | 179 | 1 |  | Toebehoren & afvoeren |
| doucheset 0180067 | | chroom | A4940AA | stuk | 168,00 | 179 | 1 |  | Spoel- & installatiesystemen |
| glijstangcombinatie 0180068 | | chroom | A5223AA | stuk | 138,00 | 179 | 1 |  | Badkamermeubelen en toiletkasten |
| Ideal Standard Tonic | | | | | | | | | |
| doucheset 0180069 | | chroom | A5224AA | stuk | 115,00 | 179 | 1 |  | Gootstenen en wastroggen |
| | | | | | | | | | Utiliteit |

Doucheprogramma Jado

| | Art.nr | Specificaties | Kleur | Lev.nr | Ehd | Prijs | Grp | CC |
|---|---|--|-------|-----------|------|--------|-----|----|
| Sanitair producten | Jado Geometry | | | | | | | |
| |  | vaste hoofddouche 0426059 | chrom | F1372AA | stuk | 209,00 | 219 | 1 |
| Baden / douchebakken / stoomcabines | | doucheslang 0424706 150cm | chrom | F1657AA | stuk | 37,50 | 219 | 1 |
| Kranen |  | handdouche 0424714 | chrom | F1319AA | stuk | 144,00 | 219 | 0 |
| Douchegarnituur | | wanddouchehouder 0424684 | chrom | F1300AA | stuk | 86,00 | 219 | 1 |
| Accessoires en spiegels |  | | | | | | | |
| Douchewanden |  | glijstangset compleet 0424692 90cm | chrom | F1324AA | stuk | 414,00 | 219 | 1 |
| Toebehoren & afvoeren | | handdouche m. grijze slang 0424605 | chrom | F1320AA | stuk | 181,00 | 219 | 1 |
| Spoel- & installatiesystemen | | 0424606 | steel | F1651XJ | stuk | 267,00 | 219 | 1 |
| | | verstelbare handdouchehouder 0424607 | chrom | F1318AA | stuk | 143,00 | 219 | 1 |
| Badkamermeubelen en toiletkasten |  | | | | | | | |
| Gootstenen en wastroggen | | doucheslang 0424608 | RVS | F1658XJ | stuk | 68,00 | 219 | 1 |
| Utiliteit | | glijstang 60cm 0424603 | chrom | F960087AA | stuk | 214,00 | 219 | 1 |
| | | 0424604 | steel | F1688XJ | stuk | 308,00 | 219 | 1 |
| |  | magneetzeephouder 0424602 | chrom | F1306AA | stuk | 56,00 | 219 | 1 |
| |  | hoekstopkraan 0424601 | chrom | F1316AA | stuk | 83,00 | 219 | 1 |
| | Jado Universeel | | | | | | | |
| | | doucheslang 0424889 | chrom | F1658AA | stuk | 45,25 | 219 | 1 |
| | | handdouche 0424862 | steel | F1319XJ | stuk | 221,00 | 219 | 1 |

| Art.nr | Specificaties | Kleur | Lev.nr | Ehd | Prijs | Grp | CC |
|--------|---------------|-------|--------|-----|-------|-----|----|
|--------|---------------|-------|--------|-----|-------|-----|----|

Jado Universeel

wanddouchehouder

| | | | | | | | |
|---------|--|--------|---------|------|--------|-----|---|
| 0424900 | | chroom | F1301AA | stuk | 78,00 | 219 | 1 |
| 0424897 | | steel | F1301XJ | stuk | 120,00 | 219 | 1 |



Sanitair producten

Baden /
douchebakken /
stoomcabines

Kranen

Douchegarnituur

Accessoires en
spiegels

Douchewanden

Toebehoren &
afvoeren

Spoel- &
installatiesystemen

Badkamermeubelen
en toiletkasten

Gootstenen en
wastroggen

Utiliteit

doucheset









| | | | | | | | |
|---------|--|--------|---------|------|--------|-----|---|
| 0424927 | | chroom | F1652AA | stuk | 258,00 | 219 | 0 |
| 0424919 | | steel | F1652XJ | stuk | 396,00 | 219 | 1 |









glijstangset compleet









| | | | | | | | |
|---------|--|--------|---------|------|--------|-----|---|
| 0424943 | | chroom | F1323AA | stuk | 399,00 | 219 | 0 |
| 0424935 | | steel | F1323XJ | stuk | 567,00 | 219 | 1 |



Doucheprogramma Kludi

| | Art.nr | Specificaties | Kleur | Lev.nr | Ehd | Prijs | Grp | CC |
|---|---|--|--------|-----------|------|--------|-----|----|
| Sanitair producten | Kludi Top programma | | | | | | | |
| |  | 4S handdouche 1/2" verstelbaar 0407054 | chroom | 624000500 | stuk | 98,50 | 250 | 1 |
| Baden / douchebakken / stoomcabines |  | glijstang m. slang 160cm 0404057 60cm | chroom | 615000500 | stuk | 116,00 | 250 | 1 |
| | | 0408573 90cm | chroom | 615010500 | stuk | 137,00 | 250 | 1 |
| Kranen | hoekmontageset voor 61500+61501 | | | | | | | |
| Douchegarnituur |  | 0408581 | chroom | 614070500 | stuk | 21,50 | 250 | 1 |
| | | Kludi Medium programma | | | | | | |
| Accessoires en spiegels |  | 3S handdouche 1/2" Eco-systeem 0400261 | chroom | 623000500 | stuk | 78,00 | 250 | 1 |
| Douchewanden | 2S handdouche 1/2" verstelbaar | | | | | | | |
| Toebehoren & afvoeren |  | 0407062 | chroom | 622000500 | stuk | 48,25 | 250 | 1 |
| | | 1S handdouche 1/2" verstelbaar | | | | | | |
| Spoel- & installatiesystemen | 0610107 | | | | | | | |
| Badkamermeubelen en toiletkasten |  | glijstang m. slang 160cm 0408441 60cm | chroom | 621100500 | stuk | 53,50 | 250 | 1 |
| | | 0408654 90cm | chroom | 621200500 | stuk | 62,00 | 250 | 1 |
| Gootstenen en wastroggen | 3S glijstangset | | | | | | | |
| Utiliteit |  | 0408603 60cm | chroom | 623310500 | stuk | 145,00 | 250 | 1 |
| | | 0408611 90cm | chroom | 623410500 | stuk | 174,00 | 250 | 1 |
| 2S glijstangset compleet | | | | | | | | |
| 0400135 60cm | | | chroom | 622310500 | stuk | 115,00 | 250 | 1 |
| 0408638 90cm | | | chroom | 622410500 | stuk | 123,00 | 250 | 1 |
| 1S glijstangset compleet m. zeepschaal | | | | | | | | |
| 0407283 60cm | | | chroom | 621310500 | stuk | 95,50 | 250 | 1 |
| 0408646 90cm | | | chroom | 621410500 | stuk | 104,00 | 250 | 1 |
| Utiliteit |  | hoekmontageset voor glijstang | | | | | | |
| | | 0408662 | chroom | 621190500 | stuk | 18,25 | 250 | 1 |

| Art.nr | Specificaties | Kleur | Lev.nr | Ehd | Prijs | Grp | CC | | |
|--|---------------|-------|-----------|------|--------|-----|----|---|---|
| Kludi Medium programma | | | | | | | | | |
| 1S handdouche m. slang m. wandhouder 0408468 | | chrom | 621500500 | stuk | 56,00 | 250 | 1 |  | Sanitair producten |
| 2S zijdouche 1/2" 0408670 | | chrom | 610930500 | stuk | 78,00 | 250 | 1 |  | Baden / douchebakken / stoomcabines |
| zijdouche 1/2" verstelbaar 0408671 | | chrom | 610830500 | stuk | 57,00 | 250 | 1 | | Kranen |
| 3S/2S douchearm voor hoofddouche 0407259 | | chrom | 623010500 | stuk | 65,00 | 250 | 1 |  | Douchegarnituur |
| 2S hoofddouche 1/2" z. douchearm 0408689 | | chrom | 610960500 | stuk | 81,00 | 250 | 1 |  | Accessoires en spiegels |
| 3S hoofddouche 1/2" z. douchearm 0407232 | | chrom | 623020500 | stuk | 104,00 | 250 | 1 |  | Douchewanden |
| Kludi Basis programma | | | | | | | | | |
| 3S handdouche 1/2" verstelbaar 0407666 | | chrom | 600260500 | stuk | 46,25 | 250 | 1 |  | Toebehoren & afvoeren |
| 2S handdouche 1/2" verstelbaar 0407763 | | chrom | 600250500 | stuk | 31,75 | 250 | 1 |  | Spoel- & installatiesystemen |
| 1S handdouche 1/2" 0407658 | | chrom | 600240500 | stuk | 18,25 | 250 | 1 |  | Badkamermeubelen en toiletkasten |
| glijstang m. slang 160cm 0408719 60cm | | chrom | 605820500 | stuk | 29,00 | 250 | 1 |  | Gootstenen en wastroggen |
| 0408727 90cm | | chrom | 605830500 | stuk | 32,75 | 250 | 1 | | Utiliteit |

| | Art.nr | Specificaties | Kleur | Lev.nr | Ehd | Prijs | Grp | CC |
|---|---|--------------------|--------|------------|------|--------|-----|----|
| Kludi Basis programma | | | | | | | | |
| Sanitair producten | 3S glijstangset compleet | | | | | | | |
| | | 0408697 60cm | chroom | 614750500 | stuk | 72,50 | 187 | 1 |
| | | 0408700 90cm | chroom | 614790500 | stuk | 74,00 | 187 | 1 |
| Baden / douchebakken / stoomcabines |  | | | | | | | |
| 2S glijstangset compleet | | | | | | | | |
| Kranen | | 0408425 60cm | chroom | 614690500 | stuk | 57,50 | 187 | 0 |
| | | | | | | | | |
| Douchegarnituur |  | | | | | | | |
| 1S glijstangset compleet | | | | | | | | |
| Accessoires en spiegels | | 0605980 60cm | chroom | 614650500 | stuk | 44,00 | 250 | 0 |
| | | 0605999 90cm | chroom | 614670500 | stuk | 47,75 | 250 | 0 |
| |  | | | | | | | |
| Douchewanden | 3S badset compleet | | | | | | | |
| | | 0408735 | chroom | 614710500 | stuk | 64,00 | 187 | 1 |
| Toebehoren & afvoeren |  | | | | | | | |
| 1S badset compleet | | | | | | | | |
| Spoel- & installatiesystemen | | 0395595 | chroom | 614660500 | stuk | 35,75 | 250 | 1 |
| |  | | | | | | | |
| Badkamermeubelen en toiletkasten | doucheslang | | | | | | | |
| | | 0407747 1/2"x175cm | chroom | 610560500 | stuk | 13,25 | 187 | 1 |
| | | 0408751 1/2"x200cm | chroom | 610570500 | stuk | 16,75 | 187 | 1 |
| Gootstenen en wastroggen |  | | | | | | | |
| Utiliteit | schuifstuk voor glijstang | | | | | | | |
| | | 0408476 | chroom | 713370500 | stuk | 14,00 | 187 | 1 |
| |  | | | | | | | |
| 2S/Eco douchethermostaat m. glijstangset | | | | | | | | |
| | | 0408808 HOH=12cm | chroom | 615680500 | stuk | 204,00 | 218 | 1 |
| | | 0408794 HOH=15cm | chroom | 615660500 | stuk | 204,00 | 218 | 0 |
| |  | | | | | | | |
| Kludi Freshline programma | | | | | | | | |
| | 100 handdouche doucheregen m. antikalk | | | | | | | |
| | | 0409514 | chroom | 6510005N00 | stuk | 19,75 | 250 | 1 |
| |  | | | | | | | |

| Art.nr | Specificaties | Kleur | Lev.nr | Ehd | Prijs | Grp | CC |
|--------|---------------|-------|--------|-----|-------|-----|----|
|--------|---------------|-------|--------|-----|-------|-----|----|

Kludi Freshline programma

Silver 100 handdouche doucheregen m. zilverkleurig doucheplaat m. antikalk

| | | | | | | | |
|---------|--|-------|------------|------|-------|-----|---|
| 0409513 | | chrom | 6550005N00 | stuk | 22,50 | 250 | 1 |
|---------|--|-------|------------|------|-------|-----|---|



Sanitair producten

Baden /
douchebakken /
stoomcabines

200 handdouche m. antikalk m. 2 straalsoorten

| | | | | | | | |
|---------|--|-------|------------|------|-------|-----|---|
| 0409512 | | chrom | 6520005N00 | stuk | 34,00 | 250 | 1 |
|---------|--|-------|------------|------|-------|-----|---|



Kranen

Douchegarnituur

300 handdouche m. antikalk m. 3 straalsoorten

| | | | | | | | |
|---------|--|-------|------------|------|-------|-----|---|
| 0409511 | | chrom | 6530005N00 | stuk | 49,75 | 250 | 1 |
|---------|--|-------|------------|------|-------|-----|---|



Accessoires en
spiegels

glijstangset m. Freshline 100 handdouche m. slang m. zeepschaal

| | | | | | | | |
|---------|------|-------|------------|------|-------|-----|---|
| 0409521 | 60cm | chrom | 6513105N00 | stuk | 81,50 | 250 | 1 |
|---------|------|-------|------------|------|-------|-----|---|

| | | | | | | | |
|---------|------|-------|------------|------|-------|-----|---|
| 0409522 | 90cm | chrom | 6514105N00 | stuk | 90,00 | 250 | 1 |
|---------|------|-------|------------|------|-------|-----|---|



Douchewanden

Toebehoren &
afvoeren

glijstangset m. Freshline 200 handdouche m. slang 160cm m. zeepschaal

| | | | | | | | |
|---------|------|-------|------------|------|--------|-----|---|
| 0409517 | 60cm | chrom | 6523105N00 | stuk | 101,00 | 250 | 1 |
|---------|------|-------|------------|------|--------|-----|---|

| | | | | | | | |
|---------|------|-------|------------|------|--------|-----|---|
| 0409518 | 90cm | chrom | 6524105N00 | stuk | 109,00 | 250 | 1 |
|---------|------|-------|------------|------|--------|-----|---|



Spoel- &
installatiesystemen

Badkamermeubelen
en toiletkasten

glijstangset m. Freshline 300 handdouche m. slang 160cm m. zeepschaal

| | | | | | | | |
|---------|------|-------|------------|------|--------|-----|---|
| 0409515 | 60cm | chrom | 6533105N00 | stuk | 116,00 | 250 | 0 |
|---------|------|-------|------------|------|--------|-----|---|

| | | | | | | | |
|---------|------|-------|------------|------|--------|-----|---|
| 0409516 | 90cm | chrom | 6534105N00 | stuk | 125,00 | 250 | 1 |
|---------|------|-------|------------|------|--------|-----|---|



Gootstenen en
wastroggen

Utiliteit

glijstangset m. Freshline Silver 100 handdouche m. slang 160cm

| | | | | | | | |
|---------|------|-------|------------|------|-------|-----|---|
| 0409519 | 60cm | chrom | 6553105N00 | stuk | 84,50 | 250 | 1 |
|---------|------|-------|------------|------|-------|-----|---|

| | | | | | | | |
|---------|------|-------|------------|------|-------|-----|---|
| 0409520 | 90cm | chrom | 6554105N00 | stuk | 93,00 | 250 | 1 |
|---------|------|-------|------------|------|-------|-----|---|



badset m. handdouche 100 m. Sirenaflex slang 125cm m. wandhouder

| | | | | | | | |
|---------|--|-------|------------|------|-------|-----|---|
| 0409525 | | chrom | 6515005N00 | stuk | 39,50 | 250 | 1 |
|---------|--|-------|------------|------|-------|-----|---|











badset m. handdouche Silver 100 m. Sirenaflex slang 125cm m. wandhouder





| | | | | | | | |
|---------|--|-------|------------|------|-------|-----|---|
| 0409524 | | chrom | 6555005N00 | stuk | 42,25 | 250 | 0 |
|---------|--|-------|------------|------|-------|-----|---|



Doucheprogramma Kludi

| | Art.nr | Specificaties | Kleur | Lev.nr | Ehd | Prijs | Grp | CC |
|---|---|---|-------|------------|------|--------|-----|----|
| Sanitair producten | Kludi Freshline programma | | | | | | | |
| | | badset m. handdouche 200 m. Sirenaflex slang 125cm m. wandhouder | | | | | | |
| | 0409523 | | chrom | 6525005N00 | stuk | 54,00 | 250 | 1 |
| Baden / douchebakken / stoomcabines | hoofddouche 1/2" | | | | | | | |
| | | 0300792 | chrom | 621910500 | stuk | 40,75 | 250 | 1 |
| Kranen | | 0300793 | chrom | 623910500 | stuk | 64,00 | 250 | 1 |
| | Douchegarnituur | | | | | | | |
| Accessoires en spiegels | Kludi Refixa programma | | | | | | | |
| | | glijstang 110cm m. houder m. slang | | | | | | |
| | 0407674 | | chrom | 620900500 | stuk | 87,50 | 250 | 1 |
| Douchewanden | glijstangset 110cm m. Sirena 2S handdouche | | | | | | | |
| | | 0408743 | chrom | 620920500 | stuk | 136,00 | 250 | 1 |
| Toebehoren & afvoeren | Eco douchethermostaat m. glijstangset | | | | | | | |
| | | 0408786 | chrom | 620930500 | stuk | 264,00 | 218 | 1 |
| Spoel- & installatiesystemen | Impulsa douchethermostaat m. glijstangset | | | | | | | |
| | | 0408778 | chrom | 620940500 | stuk | 338,00 | 218 | 1 |
| Badkamermeubelen en toiletkasten | Sirena Color wanddouchehouder | | | | | | | |
| | | 0407348 | chrom | 605510500 | stuk | 9,60 | 187 | 1 |
| Gootstenen en wastroggen | Kludi Standaard programma | | | | | | | |
| | | Regula handdouche | | | | | | |
| | 0602396 | | chrom | 600110500 | stuk | 16,00 | 250 | 0 |
| Utiliteit | doucheaansluiting 3/4"x 1/2" | | | | | | | |
| | | 0401412 | chrom | 605370500 | stuk | 12,75 | 188 | 1 |

| Art.nr | Specificaties | Kleur | Lev.nr | Ehd | Prijs | Grp | CC | | |
|--|---------------|--------|-----------|------|--------|-----|----|---|---|
| Kludi Standaard programma | | | | | | | | | |
| glijstang | | | | | | | | | |
| 0600857 | 60cm | chroom | 604810500 | stuk | 21,00 | 250 | 0 |  | Sanitair producten |
| 0602914 | 90cm | chroom | 604860500 | stuk | 24,75 | 250 | 0 | | Baden / douchebakken / stoomcabines |
| Kludi Sirene Care | | | | | | | | | |
| veiligheidslijstang m. greep 90° | | | | | | | | | |
| 0610071 | | chroom | 615030500 | stuk | 166,00 | 250 | 1 |  | Kranen |
| veiligheidslijstang m. greep 135° | | | | | | | | | |
| 0407267 | | chroom | 615040500 | stuk | 166,00 | 250 | 1 |  | Douchegarnituur |
| veiligheidsbadgreep 45° | | | | | | | | | |
| 0404062 | | chroom | 615050500 | stuk | 87,00 | 250 | 1 |  | Accessoires en spiegels |
| veiligheidsbadgreep | | | | | | | | | |
| 0407275 | | chroom | 615060500 | stuk | 46,00 | 250 | 1 |  | Douchewanden |
| Kludi Amphora | | | | | | | | | |
| handdouche verstelbaar 1/2" | | | | | | | | | |
| 0409756 | | chroom | 543000500 | stuk | 114,00 | 250 | 1 |  | Toebehoren & afvoeren |
| glijstangset compleet 90cm | | | | | | | | | |
| 0409758 | | chroom | 543400500 | stuk | 355,00 | 250 | 1 |  | Spoel- & installatiesystemen |
| slangaansluitbocht 1/2" | | | | | | | | | |
| 0409762 | | chroom | 545410500 | stuk | 39,25 | 250 | 1 |  | Badkamermeubelen en toiletkasten |
| wanddouchehouder | | | | | | | | | |
| 0409760 | | chroom | 545510500 | stuk | 57,00 | 250 | 1 |  | Gootstenen en wastroggen |
| Utiliteit | | | | | | | | | |

| | Art.nr | Specificaties | Kleur | Lev.nr | Ehd | Prijs | Grp | CC |
|---|---|--|-----------|-----------|------|---------|-----|----|
| Sanitair producten | Kludi Amphora | | | | | | | |
| | | douchezuil compleet m. kruisgrepen 0400083 | chrom | 547690520 | stuk | 2282,00 | 187 | 1 |
| Baden / douchebakken / stoomcabines |  | douchezuil compleet m. rechte grepen 0400085 | chrom | 547690575 | stuk | 2282,00 | 187 | 1 |
| | | | | | | | | |
| Kranen | | hoofddouche 1/2" 151mm 0300794 | chrom | 548690510 | stuk | 127,00 | 187 | 1 |
| Douchegarnituur | Kludi Joop | | | | | | | |
| | | doucheslang 0409863 125cm | verchromd | 550580500 | stuk | 31,75 | 183 | 1 |
| | | 0409871 160cm | verchromd | 550640500 | stuk | 35,50 | 183 | 1 |
| Accessoires en spiegels |  | handdouchehouder 0412430 | verchromd | 555510500 | stuk | 133,00 | 183 | 1 |
| Douchewanden | | | | | | | | |
| Toebehoren & afvoeren |  | doucheset 0409901 | verchromd | 551300500 | stuk | 408,00 | 183 | 1 |
| Spoel- & installatiesystemen | | | | | | | | |
| Badkamermeubelen en toiletkasten | | handdouche m. slang 0400089 125mm | chrom | 551250500 | stuk | 162,00 | 187 | 1 |
| | | 0400090 160mm | chrom | 551600500 | stuk | 166,00 | 187 | 1 |
| | | hoofddouche wandmontage 1/2" 0400109 | chrom | 557790500 | stuk | 544,00 | 187 | 1 |
| Gootstenen en wastroggen | | douchezuil compleet 0400073 | chrom | 557690505 | stuk | 2732,00 | 187 | 1 |
| Utiliteit | Kludi Kido | | | | | | | |
| |  | handdouche 0300766 1/2" | chrom | 391000500 | stuk | 85,00 | 187 | 1 |
| | | | | | | | | |
| | | glijstangset 90cm 0300771 | chrom | 391400500 | stuk | 246,00 | 187 | 1 |
| |  | glijstang 90cm m. slang 0300765 | chrom | 390900500 | stuk | 186,00 | 187 | 1 |
| | | | | | | | | |

| Art.nr | Specificaties | Kleur | Lev.nr | Ehd | Prijs | Grp | CC | |
|--|------------------|--------|-----------|------|---------|-----|----|---|
| Kludi Kido | | | | | | | | |
| wanddouchehouder 0300778 | | chroom | 395510500 | stuk | 43,00 | 187 | 1 |  |
| slangaansluitbocht 1/2" 0300777 | | chroom | 395410500 | stuk | 41,50 | 187 | 1 |  |
| Kludi Newwaves | | | | | | | | |
| doucheslang conisch 0407526 125cm | | chroom | 570580500 | stuk | 25,75 | 187 | 0 |  |
| 0407518 160cm | | chroom | 570640500 | stuk | 27,75 | 187 | 1 | |
| handdoucheset m. antikalk 0407488 | | chroom | 571000500 | stuk | 104,00 | 187 | 0 |  |
| wandhouder conisch 0407496 | | chroom | 575510500 | stuk | 52,00 | 187 | 0 |  |
| hoofddouche 1/2" verstelbaar 0409057 | | chroom | 574020500 | stuk | 158,00 | 187 | 1 |  |
| glijstang 90cm m. slang 0409588 | | chroom | 571200500 | stuk | 221,00 | 187 | 1 |  |
| glijstangset 90cm compleet 0407461 | | chroom | 571400500 | stuk | 308,00 | 187 | 0 |  |
| douchezuil 0409015 | voor wandmontage | chroom | 577600530 | stuk | 2102,00 | 187 | 1 |  |
| douchezuil compleet 0400087 | m. inbouwkransen | chroom | 577690530 | stuk | 2164,00 | 187 | 1 | |

Sanitair producten

Baden /
douchebakken /
stoomcabines

Kranen

Douchegarnituur









Accessoires en
spiegels

Douchewanden

Toebehoren &
afvoerenSpoel- &
installatiesystemenBadkamermeubelen
en toiletkastenGootstenen en
wastroggen

Utiliteit

Doucheprogramma Kludi

| | Art.nr | Specificaties | Kleur | Lev.nr | Ehd | Prijs | Grp | CC |
|---|---|---|------------------|------------------------|--------------|----------------|------------|--------|
| Sanitair producten |  | Kludi Zenta | | | | | | |
| | | handdouche 1S 0400460 | chroom | 606000500 | stuk | 18,75 | 187 | 1 |
| Baden / douchebakken / stoomcabines |  | handdouche 2S 0400466 | chroom | 607000500 | stuk | 31,25 | 187 | 1 |
| | | handdouche 3S 0400470 | chroom | 608000500 | stuk | 44,25 | 187 | 1 |
| Kranen |  | handdouche 3S 0400470 | chroom | 608000500 | stuk | 44,25 | 187 | 1 |
| Douche­garnituur |  | glijstang m. slang 0400461 60cm 0400462 90cm | chroom chroom | 606100500 606200500 | stuk stuk | 35,00 39,50 | 187 187 | 1 1 |
| Accessoires en spiegels |  | glijstangset 1S 0400463 60cm 0400464 90cm | chroom chroom | 606300500 606400500 | stuk stuk | 54,00 58,50 | 187 187 | 1 1 |
| Douchewanden |  | glijstangset 2S 0400467 60cm 0400468 90cm | chroom chroom | 607300500 607400500 | stuk stuk | 66,00 71,00 | 187 187 | 1 1 |
| Toebehoren & afvoeren |  | glijstangset 3S 0400471 60cm 0400472 90cm | chroom chroom | 608300500 608400500 | stuk stuk | 79,50 84,00 | 187 187 | 1 1 |
| Spoel- & installatiesystemen |  | badset 1S 0400465 | chroom | 606500500 | stuk | 39,50 | 187 | 1 |
| Badkamermeubelen en toiletkasten |  | badset 2S 0400469 | chroom | 607500500 | stuk | 52,00 | 187 | 1 |
| Gootstenen en wastroggen | | | | | | | | |
| Utiliteit | | | | | | | | |

| Art.nr | Specificaties | Kleur | Lev.nr | Ehd | Prijs | Grp | CC |
|--------|---------------|-------|--------|-----|-------|-----|----|
|--------|---------------|-------|--------|-----|-------|-----|----|

Kludi Medi-Care

Sirena Care glijstang 90cm m. slang m. greep
0404059

| | | | | | |
|--------|-----------|------|--------|-----|---|
| chroom | 615020500 | stuk | 212,00 | 250 | 1 |
|--------|-----------|------|--------|-----|---|



Sanitair producten

Baden /
douchebakken /
stoomcabines

Kludi Universeel

douchearm 1/2"

0300787 250mm

| | | | | | |
|--------|-----------|------|--------|-----|---|
| chroom | 623130500 | stuk | 128,00 | 187 | 1 |
|--------|-----------|------|--------|-----|---|

0300788 400mm

| | | | | | |
|--------|-----------|------|--------|-----|---|
| chroom | 623140500 | stuk | 149,00 | 187 | 1 |
|--------|-----------|------|--------|-----|---|



Kranen

schoteldouchekop

0300789 200mm

| | | | | | |
|--------|-----------|------|--------|-----|---|
| chroom | 610940500 | stuk | 303,00 | 187 | 1 |
|--------|-----------|------|--------|-----|---|



Douchegarnituur

Accessoires en
spiegels

douchearm buis

0300790 110mm

| | | | | | |
|--------|-----------|------|-------|-----|---|
| chroom | 623530500 | stuk | 20,75 | 187 | 1 |
|--------|-----------|------|-------|-----|---|

0300791 250mm

| | | | | | |
|--------|-----------|------|-------|-----|---|
| chroom | 623540500 | stuk | 29,75 | 187 | 1 |
|--------|-----------|------|-------|-----|---|



Douchewanden

Toebehoren &
afvoeren





Spoel- &
installatiesystemen



Badkamermeubelen
en toiletkasten

Gootstenen en
wastroggen

Utiliteit

Doucheprogramma KWC

| | Art.nr | Specificaties | Kleur | Lev.nr | Ehd | Prijs | Grp | CC |
|---|--|---|-------|--------------|------|--------|-----|----|
| Sanitair producten |  | KWC Fit | | | | | | |
| | | handdouche 1/2" 0403318 | chrom | Z200109000 | stuk | 27,25 | 192 | 1 |
| Baden / douchebakken / stoomcabines |  | handdouche 1/2" waterbesparend 0403806 | wit | Z504020102 | stuk | 27,25 | 192 | 1 |
| | | 0403776 | chrom | Z504020000 | stuk | 27,25 | 192 | 1 |
| Kranen |  | handdouche 0403342 | wit | Z504197102 | stuk | 145,00 | 192 | 1 |
| Douchegarnituur | | handdouche verstelbaar 0406619 | chrom | Z504204000 | stuk | 140,00 | 192 | 1 |
| Accessoires en spiegels | | wandaansluitbocht 1/2" m. rozet 0403415 | chrom | K26914000034 | stuk | 27,25 | 192 | 1 |
| Douchewanden |  | | | | | | | |
| Toebehoren & afvoeren |  | wandhouder compleet 0402109 | chrom | K269921000 | stuk | 12,25 | 192 | 1 |
| Spoel- & installatiesystemen | | | | | | | | |
| Badkamermeubelen en toiletkasten | | | | | | | | |
| Gootstenen en wastroggen | | | | | | | | |
| Utiliteit | | | | | | | | |

| Art.nr | Specificaties | Kleur | Lev.nr | Ehd | Prijs | Grp | CC | |
|--|---------------|--------|--------|------|--------|-----|----|---|
| | | | | | | | | Oras II Bagno Alessi |
| handdouche 0084055 | | chroom | 248080 | stuk | 120,00 | 199 | 1 |  |
| glijstang 65cm 0084056 | | chroom | 258080 | stuk | 240,00 | 199 | 1 | |
| glijstangset 65cm compleet 0084054 | | chroom | 8590 | stuk | 392,00 | 199 | 1 |  |

Sanitair producten

Baden /
douchebakken /
stoomcabines

Kranen

Douchegarnituur

Accessoires en
spiegels

Douchewanden





Toebehoren &
afvoeren



Spoel- &
installatiesystemen

Badkamermeubelen
en toiletkasten

Gootstenen en
wastroggen

Utiliteit

| | Art.nr | Specificaties | Kleur | Lev.nr | Ehd | Prijs | Grp | CC |
|---|---|--|-------|---------|---------|-------|-------|-----|
| Sanitair producten | Plieger Brussel New | | | | | | | |
| | | badset handdouche m. wandsteun m. slang | | | | | | |
| | 0674680 | | chrom | 0674680 | stuk | 5,90 | 250 | 0 |
| Baden / douchebakken / stoomcabines | glijstangset compleet 60cm | | | | | | | |
| | 0674690 | | chrom | 0674690 | stuk | 19,25 | 250 | 0 |
| | wandhouder | | | | | | | |
| | 0674693 | | chrom | 0674693 | stuk | 3,96 | 250 | 0 |
| Kranen | glijstuk | | | | | | | |
| | 0674695 | | chrom | 0674695 | stuk | 5,50 | 250 | 0 |
| Douchegarnituur | Plieger Charleston | | | | | | | |
| |  | handdouche | | | | | | |
| | 4357546 | | chrom | 4357546 | stuk | 18,75 | 250 | 0 |
| Accessoires en spiegels | glijstangset compleet | | | | | | | |
| |  | 4359028 | | chrom | 4359028 | stuk | 58,50 | 250 |
| Douchewanden | Plieger Liberty | | | | | | | |
| Toebehoren & afvoeren | | doucheslang 150cm | | | | | | |
| | 0694177 | | chrom | 0694177 | stuk | 8,20 | 250 | 0 |
| Spoel- & installatiesystemen | handdouche 3-standen | | | | | | | |
| | 0694150 | | chrom | 0694150 | stuk | 27,00 | 250 | 0 |
| Badkamermeubelen en toiletkasten | wandhouder 3 standen | | | | | | | |
| |  | 4357456 | | chrom | 4357456 | stuk | 1,66 | 250 |
| Gootstenen en wastroggen | glijstang | | | | | | | |
| | 0694169 | | chrom | 0694169 | stuk | 39,50 | 250 | 0 |
| Utiliteit | glijstangset 60cm compleet | | | | | | | |
| |  | 0691364 | | chrom | 0691364 | stuk | 74,50 | 250 |
| Plieger Spring | | | | | | | | |
| doucheslang spiroflex | | | | | | | | |
| | 0670004 | | 150cm | 0670004 | stuk | 7,00 | 250 | 0 |
| handdouche 2-standen | | | | | | | | |
| | 0670008 | | chrom | 0670008 | stuk | 19,00 | 250 | 0 |
| handdouche m. wandhouder m. slang | | | | | | | | |
| | 0670005 | | chrom | 0670005 | stuk | 32,55 | 250 | 0 |
| glijstangset 60cm compleet | | | | | | | | |
|  | 0674585 | | chrom | 0674585 | stuk | 54,00 | 250 | 0 |

| Art.nr | Specificaties | Kleur | Lev.nr | Ehd | Prijs | Grp | CC | |
|--|---------------|-------|---------|------|-------|-----|----|---|
| Plieger Spring | | | | | | | | |
| wandhouder 0670010 | | chrom | 0670010 | stuk | 7,00 | 250 | 0 | |
| handdouche 0670019 | | chrom | 0670019 | stuk | 23,00 | 250 | 0 | |
| glijstang 60cm 0670021 | | chrom | 0670021 | stuk | 29,75 | 250 | 1 | |
| glijstangset 60cm compleet m. slang 150cm 0670015 | | chrom | 0670015 | stuk | 69,00 | 250 | 0 |  |
| badset compleet m. slang 125cm 0670017 | | chrom | 0670017 | stuk | 45,25 | 250 | 0 |  |
| wandhouder voor badset 0670025 | | chrom | 0670025 | stuk | 12,75 | 250 | 0 | |
| glijstuk los voor glijstang 0670027 | | chrom | 0670027 | stuk | 12,75 | 250 | 1 | |
| bevestigingsset voor glijstangset 0670029 | | | 0670029 | stuk | 0,81 | 250 | 1 | |
| doucheslang 125cm 0670031 | | chrom | 0670031 | stuk | 12,75 | 250 | 0 | |
| Plieger universeel | | | | | | | | |
| doucheslang kunststof 0600210 1/2"x125cm | | wit | 0600210 | stuk | 2,41 | 266 | 0 | |
| 0600229 1/2"x150cm | | wit | 0600229 | stuk | 2,61 | 266 | 0 | |
| 0600237 1/2"x175cm | | wit | 0600237 | stuk | 2,74 | 266 | 0 | |
| 0600245 1/2"x200cm | | wit | 0600245 | stuk | 2,91 | 266 | 0 | |
| doucheslang 0600334 1/2"x125cm | | chrom | 0600334 | stuk | 2,96 | 266 | 0 | |
| 0600342 1/2"x150cm | | chrom | 0600342 | stuk | 3,43 | 266 | 0 | |
| 0600350 1/2"x175cm | | chrom | 0600350 | stuk | 4,15 | 266 | 0 | |
| 0600369 1/2"x200cm | | chrom | 0600369 | stuk | 4,55 | 266 | 0 | |
| Star handdouche kunststof 0600083 | | wit | 0600083 | stuk | 1,90 | 266 | 0 | |
| wandpen verstelbaar m. bevestiging 0600040 | | chrom | 0600040 | stuk | 3,63 | 250 | 0 | |
| glijstang 60cm z. garnituur m. verstelbare rozet 0670294 | | chrom | 0670294 | stuk | 9,80 | 250 | 0 | |
| stijgbuisje z. haakje 0601047 | | chrom | 0601047 | stuk | 5,30 | 266 | 0 |  |

Sanitair producten

Baden /
douchebakken /
stoomcabines

Kranen

Douchegarnituur

Accessoires en
spiegels

Douchewanden

Toebehoren &
afvoerenSpoel- &
installatiesystemenBadkamermeubelen
en toiletkastenGootstenen en
wastroggen

Utiliteit

| | Art.nr | Specificaties | Kleur | Lev.nr | Ehd | Prijs | Grp | CC |
|---|-------------------------------------|---|----------------|----------|------|---------|-----|----|
| Sanitair producten | Pharo douchezuil | | | | | | | |
| | 0452182 | douchezuil vrijstaand m. hoofddouche z. verlichting | satinchr./chr. | 29802000 | stuk | 2400,00 | 136 | 1 |
| Baden / douchebakken / stoomcabines | basisgarnituur v. douchezuil | | | | | | | |
| | 0456624 | | | 29805180 | stuk | 366,00 | 136 | 1 |
| Kranen | | | | | | | | |
| Douchegarnituur | | | | | | | | |
| Accessoires en spiegels | | | | | | | | |
| Douchewanden | | | | | | | | |
| Toebehoren & afvoeren | | | | | | | | |
| Spoel- & installatiesystemen | | | | | | | | |
| Badkamermeubelen en toiletkasten | | | | | | | | |
| Gootstenen en wastroggen | | | | | | | | |
| Utiliteit | | | | | | | | |

| Art.nr | Specificaties | Kleur | Lev.nr | Ehd | Prijs | Grp | CC |
|-------------------------------------|---------------|--------|---------|------|-------|-----|----|
| Seppelfricke doucheprogramma | | | | | | | |
| valstroombeluchter | | | | | | | |
| 0560537 | 1/2" bi x bu | chroom | 0488367 | stuk | 20,75 | 250 | 0 |
| doorstroombeluchter | | | | | | | |
| 0560545 | 1/2" bi x bu | chroom | 0488213 | stuk | 25,25 | 250 | 0 |
| tee-beluchter | | | | | | | |
| 0560626 | 1/2" bi x bu | chroom | 0488281 | stuk | 23,25 | 250 | 0 |

Sanitair producten

Baden /
douchebakken /
stoomcabines

Kranen

Douchegarnituur

Accessoires en
spiegels

Douchewanden

Toebehoren &
afvoeren

Spoel- &
installatiesystemen









Badkamermeubelen
en toiletkasten

Gootstenen en
wastroggen

Utiliteit







Doucheprogramma Sphinx

| | Art.nr | Specificaties | Kleur | Lev.nr | Ehd | Prijs | Grp | CC |
|---|----------------------------|--|---------------|-----------|------|--------|-----|----|
| Sanitair producten | Sphinx 340 / 360 | | | | | | | |
| | | glijstangset compleet 0240038 | chrom/matchr. | S8HT50000 | stuk | 115,00 | 213 | 0 |
| | | badgarnituur m. handdouche m. wandhouder 0240040 | chrom | S8HT51000 | stuk | 79,00 | 213 | 0 |
| Baden / douchebakken / stoomcabines | Sphinx 450/Atlantic | | | | | | | |
| | | handdouche 0333103 | chrom | S8HTP590 | stuk | 61,00 | 213 | 1 |
| Kranen | | doucheslang 150cm 0333104 | chrom | S8HTP591 | stuk | 13,50 | 213 | 1 |
| | | wandhouder 0333105 | chrom | S8HTP592 | stuk | 52,00 | 213 | 1 |
| Douchegarnituur | | badgarnituur m. slang 140 0333101 | chrom | S8HT56001 | stuk | 122,00 | 213 | 1 |
| Accessoires en spiegels | | badgarnituur z. wandhouder 0333102 | chrom | S8HT57001 | stuk | 74,50 | 213 | 1 |
| Douchewanden | | glijstangset 60cm 0333100 | chrom | S8HT55001 | stuk | 276,00 | 213 | 0 |
| | Sphinx Forma | | | | | | | |
| Toebehoren & afvoeren | | douchegarnituur 0333117 | chrom | S8HT52000 | stuk | 248,00 | 213 | 1 |
| | | badgarnituur 0333118 | chrom | S8HT53000 | stuk | 83,00 | 213 | 1 |
| Spoel- & installatiesystemen | | | | | | | | |
| Badkamermeubelen en toiletkasten | | | | | | | | |
| Gootstenen en wastroggen | | | | | | | | |
| Utiliteit | | | | | | | | |

| Art.nr | Specificaties | Kleur | Lev.nr | Ehd | Prijs | Grp | CC | | |
|------------------------------------|---------------|-------------|----------|------|--------|-----|----|---|---|
| | | | | | | | | Venlo Astro | |
| doucheslang chroom | | | | | | | | | |
| 0422401 | 1/2"x125cm | chroom | H2360A01 | stuk | 28,00 | 210 | 1 |  | Sanitair producten |
| handdouche | | | | | | | | | |
| 0422428 | | chroom | H2360A02 | stuk | 50,50 | 210 | 1 |  | Baden / douchebakken / stoomcabines |
| 0422436 | | chroom/goud | H2360C02 | stuk | 53,00 | 210 | 1 | | Kranen |
| wanddouchehouder | | | | | | | | | |
| 0422371 | | chroom | H2360A03 | stuk | 25,25 | 210 | 1 |  | Doucheapparatuur |
| 0422398 | | chroom/goud | H2360C03 | stuk | 29,50 | 210 | 1 | | Accessoires en spiegels |
| glijstang 65cm z. garnituur | | | | | | | | | |
| 0422339 | | chroom | H2360A04 | stuk | 126,00 | 210 | 1 |  | Douchewanden |
| 0422363 | | chroom/goud | H2360C04 | stuk | 133,00 | 210 | 1 | | Toebehoren & afvoeren |
| glijstangset 60cm compleet | | | | | | | | | |
| 0422341 | | chroom | H2360A06 | stuk | 192,00 | 210 | 1 | | |
| | | | | | | | | Venlo Maas | |
| doucheslang | | | | | | | | | |
| 0423556 | 1/2"x125cm | chroom | H8060A14 | stuk | 20,75 | 210 | 0 | | Spoel- & installatiesystemen |
| wanddouchehouder | | | | | | | | | |
| 0423572 | | chroom | H1060990 | stuk | 5,50 | 210 | 1 |  | Badkamermeubelen en toiletkasten |
| glijstangset 60cm compleet | | | | | | | | | |
| 0423505 | | chroom | H7560A01 | stuk | 139,00 | 210 | 1 |  | Gootstenen en wastroggen |
| | | | | | | | | Venlo Noxxa | |
| handdouche regelbaar | | | | | | | | | |
| 0424366 | | chroom | H2160A15 | stuk | 45,00 | 210 | 0 |  | |
| wanddouchehouder | | | | | | | | | |
| 0421232 | | chroom | H2160A05 | stuk | 32,75 | 210 | 0 |  | |

| | Art.nr | Specificaties | Kleur | Lev.nr | Ehd | Prijs | Grp | CC |
|---|---|--|-------|----------|------|--------|-----|----|
| Sanitair producten | Venlo Noxxa | | | | | | | |
| | | glijstang 60cm m. glijstuk 0424374 | chrom | H2160A13 | stuk | 65,00 | 210 | 1 |
| Baden / douchebakken / stoomcabines | | | | | | | | |
| Kranen | glijstangset 60cm compleet | | | | | | | |
| | | 0424371 | chrom | H2160A10 | stuk | 155,00 | 210 | 0 |
| Douchegarnituur | | | | | | | | |
| Accessoires en spiegels | inbouw douchekop 1/2" | | | | | | | |
| | | 0424385 | chrom | H2160A16 | stuk | 106,00 | 210 | 1 |
| Douchewanden | | | | | | | | |
| Toebehoren & afvoeren | Venlo Project | | | | | | | |
| | | handdouche antikalk 0424854 | chrom | H1760A04 | stuk | 23,25 | 210 | 1 |
| Spoel- & installatiesystemen | glijstangcombinatie 90cm m. handdouche | | | | | | | |
| | | 0424846 | chrom | H1760A01 | stuk | 86,00 | 210 | 0 |
| Badkamermeubelen en toiletkasten | | | | | | | | |
| Gootstenen en wastroggen | glijstangcombinatie 60cm m. handdouche | | | | | | | |
| | | 0424838 | chrom | H1760A02 | stuk | 71,00 | 210 | 0 |
| Utiliteit | | | | | | | | |

| Art.nr | Specificaties | Kleur | Lev.nr | Ehd | Prijs | Grp | CC | | |
|---|---------------|-----------------|------------|------|--------|-----|----|---|---|
| | | | | | | | | Villeroy & Boch Circle | |
| douchegarnituur m. muuraansluitbocht 0474401 | | chr./geborsteld | 2780392004 | stuk | 374,00 | 172 | 1 |  | Sanitair producten |
| | | | | | | | | Villeroy & Boch Cult | |
| glijstangset compleet 0474398 100cm | | chr./geborsteld | 2640392044 | stuk | 447,00 | 172 | 1 |  | Baden / douchebakken / stoomcabines |
| | | | | | | | | Villeroy & Boch Cult | |
| badset m. handdouche m. slang 125cm m. wandhouder 0272637 | | chrom | 2780596000 | stuk | 214,10 | 172 | 1 | | Kranen |
| wandhouder m. rozet 0272639 | | chrom | 2805096000 | stuk | 78,70 | 172 | 1 | | Douchegarnituur |
| wandaansluitbocht 1/2" 0272638 | | chrom | 2845096000 | stuk | 46,50 | 172 | 1 | | Accessoires en spiegels |
| glijstangset 86.3cm compleet 0272635 | | chrom | 2640396000 | stuk | 359,50 | 172 | 1 | | Douchewanden |
| glijstang 86.3cm 0272636 | | chrom | 2670196000 | stuk | 224,70 | 172 | 1 | | Toebehoren & afvoeren |
| | | | | | | | | Villeroy & Boch Hype | |
| douchegarnituur compleet m. montageprofiel 0476072 90cm | | chrom | 2641093000 | stuk | 557,00 | 172 | 1 |  | Spoel- & installatiesystemen |
| wandaansluitbocht 0475955 | | chrom | 2845093000 | stuk | 43,75 | 172 | 1 |  | Badkamermeubelen en toiletkasten |
| douchehouder 0475963 | | chrom | 2805093000 | stuk | 93,50 | 172 | 1 |  | Gootstenen en wastroggen |
| badset m. aansluitbocht 0475947 | | chrom | 2780393000 | stuk | 300,00 | 172 | 1 |  | Utiliteit |
| | | | | | | | | Villeroy & Boch Look | |
| badgarnituur compleet 0475586 | | chrom | 2780595000 | stuk | 116,00 | 172 | 1 | | |

| | Art.nr | Specificaties | Kleur | Lev.nr | Ehd | Prijs | Grp | CC |
|---|---|--|--------|------------|------|--------|-----|----|
| Sanitair producten | Villeroy & Boch Look | | | | | | | |
| | | glijstangset compleet 0475584 66cm | chroom | 2640395000 | stuk | 256,00 | 172 | 1 |
| Baden / douchebakken / stoomcabines |  | | | | | | | |
| Kranen | Villeroy & Boch Source | | | | | | | |
| | | glijstangset compleet 0475543 91cm | chroom | 2640394000 | stuk | 494,00 | 272 | 1 |
| Douchegarnituur |  | | | | | | | |
| Accessoires en spiegels | douchegarnituur met muuraansluiting | | | | | | | |
| | | 0475544 | chroom | 2780394000 | stuk | 350,00 | 272 | 1 |
| Douchewanden |  | | | | | | | |
| Toebehoren & afvoeren | Villeroy & Boch Square | | | | | | | |
| | | douchegarnituur m. muuraansluitbocht 0474568 | chroom | 2780391000 | stuk | 349,00 | 172 | 1 |
| Toebehoren & afvoeren |  | | | | | | | |
| Spoel- & installatiesystemen | glijstangset compleet | | | | | | | |
| | | 0474576 91cm | chroom | 2640391000 | stuk | 480,00 | 172 | 1 |
| Badkamermeubelen en toiletkasten |  | | | | | | | |
| Gootstenen en wastroggen | wandaansluitbocht 1/2" | | | | | | | |
| | | 0474584 | chroom | 2845091000 | stuk | 111,00 | 172 | 1 |
| Utiliteit |  | | | | | | | |

| Art.nr | Specificaties | Kleur | Lev.nr | Ehd | Prijs | Grp | CC |
|---|---------------|-------------|----------|------|---------|-----|----|
| Grohe Amera | | | | | | | |
| douchepaneel thermostatisch 0464923 | | | 27013000 | stuk | 2650,00 | 218 | 1 |
| Grohe Aquatimer | | | | | | | |
| douchepaneel 0464965 | | glas safier | 33630128 | stuk | 1479,00 | 218 | 1 |
| Grohe Aquatower 3000 | | | | | | | |
| douchepaneel thermostatisch wandmodel 0443603 | | chroom | 27202000 | stuk | 2469,00 | 162 | 1 |
| douchepaneel thermostatisch hoekmodel 0443611 | | chroom | 27203000 | stuk | 2849,00 | 162 | 1 |

Sanitair producten

Baden /
douchebakken /
stoomcabines

Kranen

Douchegarnituur

Accessoires en
spiegels

Douchewanden

Toebehoren &
afvoeren

Spoel- &
installatiesystemen

Badkamermeubelen
en toiletkasten

Gootstenen en
wastroggen

Utiliteit



| Art.nr | Specificaties | Kleur | Lev.nr | Ehd | Prijs | Grp | CC |
|--|---------------|------------|------------|------|---------|-----|----|
| Hansa Smartshower | | | | | | | |
| douchepaneel z. Twister douchethermostaat | | | | | | | |
| 0395633 | | chrom | 58200100 | stuk | 987,00 | 262 | 1 |
| 0395641 | | matchr/chr | 5820010092 | stuk | 1282,00 | 262 | 1 |
| douchepaneel m. Twister douchethermostaat | | | | | | | |
| 0395617 | | chrom | 58210900 | stuk | 1392,00 | 262 | 0 |
| 0395625 | | matchr/chr | 5821090092 | stuk | 1810,00 | 262 | 1 |

Sanitair producten

Baden /
douchebakken /
stoomcabines

Kranen

Douchegarnituur

Accessoires en
spiegels

Douchewanden







Toebehoren &
afvoeren

Spoel- &
installatiesystemen

Badkamermeubelen
en toiletkasten

Gootstenen en
wastroggen

Utiliteit

| Art.nr | Specificaties | Kleur | Lev.nr | Ehd | Prijs | Grp | CC | | |
|--|---------------|----------------|-----------|------|---------|-----|----|---|--|
| | | | | | | | | Kludi douchepanelen | |
| 222MX douchepaneel m. handdouche Logo 1S 0409786 | | geeloxeerd | 6182499 | stuk | 747,00 | 250 | 1 |  | Sanitair producten |
| 222MX accessoireset 0409792 | | geeloxeerd | 766379900 | stuk | 84,00 | 250 | 1 |  | Baden / douchebakken / stoomcabines Kranen |
| 222MX afbouwdeel wandaansluitbocht 0409788 | | geeloxeerd | 777909900 | stuk | 59,00 | 250 | 1 |  | Douchegarnituur |
| 222MX hoekmontageset 0409790 | | | 778040000 | stuk | 86,00 | 250 | 1 |  | Accessoires en spiegels Douchewanden |
| 223MX douchepaneel m. handdouche Freshline 100 0400088 | | geeloxeerd | 6182599 | stuk | 750,00 | 250 | 1 |  | Toebehoren & afvoeren Spoel- & installatiesystemen |
| 332TH douchepaneel thermostatisch wandmodel 0409794 | | zilvermettalic | 6183097 | stuk | 1024,00 | 250 | 1 |  | Badkamermeubelen en toiletkasten Gootstenen en wastroggen |
| 332TH douchepaneel thermostatisch hoekmodel 0409796 | | zilvermettalic | 6183197 | stuk | 1190,00 | 250 | 1 | | Utiliteit |
| 434TH douchepaneel thermostatisch wandmodel 0409798 | | azur | 61850H6 | stuk | 2400,00 | 250 | 1 |  | |

Douchepanelen Pharo











| | Art.nr | Specificaties | Kleur | Lev.nr | Ehd | Prijs | Grp | CC |
|---|--|----------------|------------------|----------|------|---------|-----|----|
| | Pharo Comfort | | | | | | | |
| | douchepaneel wand/hoekversie m. thermostaat | | | | | | | |
| Sanitair producten | 0459828 | z. verlichting | satinchr./chr. | 26343000 | stuk | 1174,00 | 136 | 1 |
| | 0450382 | z. verlichting | wit/chroom | 26344000 | stuk | 1174,00 | 136 | 1 |
| | Pharo Helis | | | | | | | |
| | douchepaneel wandversie m. thermostaat | | | | | | | |
| Baden / douchebakken / stoomcabines | 0467243 | m. verlichting | wit/chroom | 26302000 | stuk | 2915,00 | 136 | 1 |
| | 0467251 | m. verlichting | groen/matchr. | 26301880 | stuk | 2915,00 | 136 | 1 |
| | 0467278 | m. verlichting | beige/satinox | 26303810 | stuk | 3287,00 | 136 | 1 |
| | hoekmontageset | | | | | | | |
| Kranen | 0467286 | | | 26212000 | stuk | 256,00 | 136 | 1 |
| | Pharo Lift II | | | | | | | |
| | douchepaneel wandversie m. thermostaat | | | | | | | |
| Douchegarnituur | 0450031 | z. verlichting | satinchr./chr. | 26871000 | stuk | 1717,00 | 136 | 0 |
| | 0450383 | z. verlichting | wit/chroom | 26870000 | stuk | 1717,00 | 136 | 1 |
| | hoekmontageset v. douchepaneel | | | | | | | |
| Accessoires en spiegels | 0450035 | | satinchroom | 26215000 | stuk | 132,00 | 136 | 1 |
| | Pharo Moonlight | | | | | | | |
| | douchepaneel wandversie m. thermostaat | | | | | | | |
| Douchewanden | 0458570 | z. verlichting | wit/chroom | 26502000 | stuk | 2495,00 | 136 | 1 |
| | 0450006 | z. verlichting | grijs-groen/chr. | 26500000 | stuk | 2495,00 | 136 | 1 |
| | 0458562 | m. verlichting | wit/chroom | 26512000 | stuk | 3045,00 | 136 | 1 |
| | 0450017 | m. verlichting | grijs-groen/chr. | 26510000 | stuk | 3045,00 | 136 | 1 |
| | hoekmontageset | | | | | | | |
| Toebehoren & afvoeren | 0457200 | | | 26211000 | stuk | 194,87 | 136 | 1 |
| | Pharo Prestige | | | | | | | |
| | douchepaneel wand/hoekversie m. thermostaat | | | | | | | |
| Spoel- & installatiesystemen | 0458538 | z. verlichting | satinchr./chr. | 26101000 | stuk | 2042,00 | 136 | 1 |
| | 0458546 | z. verlichting | satinchr/mat | 26101880 | stuk | 2042,00 | 136 | 1 |
| Badkamermeubelen en toiletkasten | 0458554 | z. verlichting | satinchr./rvs | 26101800 | stuk | 2426,00 | 136 | 1 |
| | 0458422 | z. verlichting | wit/chroom | 26102000 | stuk | 2042,00 | 136 | 1 |
| | 0458430 | z. verlichting | wit/matchr. | 26102880 | stuk | 2042,00 | 136 | 1 |
| | 0458449 | z. verlichting | wit/rvs | 26102800 | stuk | 2426,00 | 136 | 1 |
| | 0458457 | z. verlichting | pergamon/chr. | 26103000 | stuk | 2042,00 | 136 | 1 |
| | 0458465 | z. verlichting | perg/matchr. | 26103880 | stuk | 2042,00 | 136 | 1 |
| Gootstenen en wastroggen | 0458473 | z. verlichting | pergamon/rvs | 26103800 | stuk | 2426,00 | 136 | 1 |
| | 0458392 | m. verlichting | satinchr./chr. | 26111000 | stuk | 2361,00 | 136 | 1 |
| | 0458406 | m. verlichting | satinchr/mat | 26111880 | stuk | 2361,00 | 136 | 1 |
| | 0458414 | m. verlichting | satinchr./rvs | 26111800 | stuk | 2745,00 | 136 | 1 |
| Utiliteit | 0458589 | m. verlichting | wit/chroom | 26112000 | stuk | 2361,00 | 136 | 1 |
| | 0458597 | m. verlichting | wit/matchr. | 26112880 | stuk | 2361,00 | 136 | 1 |
| | 0458600 | m. verlichting | wit/rvs | 26112800 | stuk | 2745,00 | 136 | 1 |
| | 0458619 | m. verlichting | pergamon/chr. | 26113000 | stuk | 2361,00 | 136 | 1 |
| | 0458333 | m. verlichting | perg/matchr. | 26113880 | stuk | 2361,00 | 136 | 1 |
| | 0458341 | m. verlichting | pergamon/rvs | 26113800 | stuk | 2745,00 | 136 | 1 |
| | 0466565 | m. verlichting | satinchr./chr. | 26131000 | stuk | 2942,00 | 136 | 1 |







Accessoires en spiegels

| | |
|------------------------------------|------|
| Accessoires Colombo | 802 |
| Accessoires Dornbracht | 834 |
| Accessoires Duravit | 846 |
| Accessoires D-Line | 848 |
| Accessoires Emco | 851 |
| Accessoires Othello | 889 |
| Accessoires Grohe | 890 |
| Accessoires Geesa | 897 |
| Accessoires Gessi | 922 |
| Accessoires Haceka | 939 |
| Accessoires Hansa | 951 |
| Accessoires Hansgrohe | 956 |
| Accessoires Hewi | 971 |
| Inda Accessoires | 973 |
| Accessoires Jado | 976 |
| Accessoires Keuco | 979 |
| Accessoires Kludi | 1007 |
| Accessoires Plieger | 1009 |
| Accessoires Sphinx | 1016 |
| Accessoires Villeroy & Boch | 1019 |
| Vloerwisser | 1028 |
| Spiegels | 1029 |
| Planchets | 1033 |
| Toebehoren accessoires en spiegels | 1034 |

Accessoires en spiegels

| | Art.nr | Specificaties | Kleur | Lev.nr | Ehd | Prijs | Grp | CC |
|---|--|---|------------------------------------|---------|---------|--------|--------|-----|
| Sanitair producten | Colombo Bart | | | | | | | |
| | | zeephouder m. glaszet 0692654 | chrom | B2201CR | stuk | 46,25 | 242 | 0 |
| Baden / douchebakken / stoomcabines | | zeepdispenser m. glas 0692662 | chrom | B9308CR | stuk | 90,00 | 242 | 0 |
| | Kranen | | | | | | | |
| Douchegarnituur | | glashouder m. glas 0692670 | chrom | B2202CR | stuk | 48,25 | 242 | 0 |
| | Accessoires en spiegels | | | | | | | |
| Douchewanden | | planchet m. glasplaat 60cm 0692689 | chrom | B2216CR | stuk | 139,00 | 242 | 0 |
| | Toebehoren & afvoeren | | badgreep 30cm 0692727 | chrom | B2209CR | stuk | 52,00 | 242 |
| Spoel- & installatiesystemen | | | sponshouder 45cm 0694657 | chrom | B2203CR | stuk | 153,00 | 242 |
| Badkamermeubelen en toiletkasten | | handdoekhouder 64cm 0692735 | chrom | B2211CR | stuk | 61,00 | 242 | 1 |
| Gootstenen en wastroggen | | handdoekhouder 45cm 0694665 | chrom | B2210CR | stuk | 57,00 | 242 | 1 |
| Utiliteit | | handdoekhouder dubbel 45cm 0694681 | chrom | B2288CR | stuk | 122,00 | 242 | 1 |
| | | 2-lids handdoekhouder draaibaar 0692743 | chrom | B2212CR | stuk | 66,50 | 242 | 0 |
| | 1-lids handdoekhouder vast 0694673 | chrom | B2213CR | stuk | 37,50 | 242 | 1 | |

| Art.nr | Specificaties | Kleur | Lev.nr | Ehd | Prijs | Grp | CC | | |
|--|---------------|--------|---------|------|--------|-----|----|---|---|
| | | | | | | | | Colombo Bart | |
| handdoekring 0694185 | | chroom | B2231CR | stuk | 48,25 | 242 | 0 |  | Sanitair producten |
| closetrolhouder m. klep 0692700 | | chroom | B2291CR | stuk | 77,50 | 242 | 0 |  | Baden / douchebakken / stoomcabines |
| closetrolhouder z. klep 0692719 | | chroom | B2208CR | stuk | 39,25 | 242 | 0 |  | Kranen |
| reserverolhouder 0692697 | | chroom | B2290CR | stuk | 50,50 | 242 | 0 |  | Douchegarnituur |
| closetborstelgarnituur m. glas 0692778 | | chroom | B2207CR | stuk | 63,00 | 242 | 0 |  | Accessoires en spiegels |
| closetborstelgarnituur staand 0694843 | | chroom | B2206CR | stuk | 67,50 | 242 | 1 |  | Douchewanden |
| haak klein 0692786 | | chroom | CB57CR | stuk | 25,50 | 242 | 0 |  | Toebehoren & afvoeren |
| haak groot 0692794 | | chroom | CB67CR | stuk | 32,50 | 242 | 0 |  | Spoel- & installatiesystemen |
| wandscheerspiegel 0694908 | | chroom | B0125CR | stuk | 153,00 | 242 | 1 |  | Badkamermeubelen en toiletkasten |
| halogeenspot enkel m. glas 0692816 | | chroom | B1303CR | stuk | 144,00 | 242 | 1 |  | Gootstenen en wastroggen |
| | | | | | | | | | Utiliteit |

| | Art.nr | Specificaties | Kleur | Lev.nr | Ehd | Prijs | Grp | CC |
|---|---|---|--------|------------|------|--------|-----|----|
| | Colombo Bart | | | | | | | |
| Sanitair producten |  | wandscheerspiegel m. licht 0694916 | chroom | B9966CR | stuk | 135,00 | 242 | 0 |
| Baden / douchebakken / stoomcabines | | | | | | | | |
| Kranen |  | wandspiegel verstelbaar 0694924 | chroom | B9967CR | stuk | 124,00 | 242 | 1 |
| Douchegarnituur | | | | | | | | |
| Accessoires en spiegels |  | tissuedispenser m. slot 0694851 | chroom | B9960CR | stuk | 170,00 | 242 | 1 |
| Douchewanden |  | tissuebox 0694878 | chroom | B9961CR | stuk | 22,00 | 242 | 1 |
| Toebehoren & afvoeren |  | pedaalemmer 0694886 | chroom | B9962CR | stuk | 34,50 | 242 | 1 |
| Spoel- & installatiesystemen | | | | | | | | |
| Badkamermeubelen en toiletkasten |  | papierbak 0694894 | staal | B9964CR | stuk | 67,00 | 242 | 1 |
| Gootstenen en wastroggen | | | | | | | | |
| Utiliteit |  | flessenopener 0694703 | chroom | B2295CR | stuk | 22,75 | 242 | 1 |
| | Colombo Bart onderdelen | | | | | | | |
| | 0692724 | zeepschaal los voor B2201 | | B2251 | stuk | 20,25 | 242 | 1 |
| | 0692725 | zeepdispenser z. pomp B9307-9308 | | B9354 | stuk | 28,50 | 242 | 1 |
| | 0692726 | glas los voor B2202 | | B2252 | stuk | 20,25 | 242 | 1 |
| | 0692728 | planchet los voor B2216 | | B2261 | stuk | 109,00 | 242 | 1 |
| | 0692729 | glas los voor closetborstelhouder B2207 | | B2250 | stuk | 16,50 | 242 | 1 |
| | 0692730 | closetborstel los m. afdekplaat voor B2206-2207 | | B2258 | stuk | 27,75 | 242 | 1 |
| | 0692685 | closetborstel los | | B0157 | stuk | 12,25 | 242 | 1 |
| | 0692709 | zeepdispenser z. pomp | | B93560-CBO | stuk | 30,50 | 242 | 1 |

| Art.nr | Specificaties | Kleur | Lev.nr | Ehd | Prijs | Grp | CC |
|--------|---------------|-------|--------|-----|-------|-----|----|
|--------|---------------|-------|--------|-----|-------|-----|----|

Colombo Gallery

wandlamp halogeen

| | | | | | | | |
|---------|--|--------|-------|------|--------|-----|---|
| 0694488 | | chroom | B1320 | stuk | 133,00 | 242 | 0 |
| 0694490 | | chroom | B1321 | stuk | 133,00 | 242 | 1 |
| 0694492 | | chroom | B1322 | stuk | 133,00 | 242 | 0 |



Sanitair producten

Baden /
douchebakken /
stoomcabines

Kranen

Douchegarnituur

Accessoires en
spiegels

spiegellamp halogeen klembevestiging

| | | | | | | | |
|---------|--|--------|-------|------|--------|-----|---|
| 0694494 | | chroom | B1330 | stuk | 128,00 | 242 | 1 |
| 0694496 | | chroom | B1331 | stuk | 128,00 | 242 | 1 |
| 0694498 | | chroom | B1332 | stuk | 128,00 | 242 | 0 |



Douchewanden

Toebehoren &
afvoeren

Spoel- &
installatiesystemen

Badkamermeubelen
en toiletkasten









spiegellamp halogeen framebevestiging







| | | | | | | | |
|---------|--|--------|-------|------|--------|-----|---|
| 0694500 | | chroom | B1310 | stuk | 114,00 | 242 | 1 |
| 0694502 | | chroom | B1311 | stuk | 114,00 | 242 | 0 |
| 0694504 | | chroom | B1312 | stuk | 114,00 | 242 | 0 |
| 0694514 | | chroom | B1380 | stuk | 154,00 | 242 | 0 |













Gootstenen en
wastroggen







Utiliteit

| | Art.nr | Specificaties | Kleur | Lev.nr | Ehd | Prijs | Grp | CC |
|---|------------------------|--|-------|---------|------|--------|-----|----|
| | Colombo Gallery | | | | | | | |
| Sanitair producten | | wandlamp halogeen | | | | | | |
|  | 0694516 | | chrom | B1381 | stuk | 167,00 | 242 | 0 |
| Baden / douchebakken / stoomcabines | | spiegellamp halogeen framebevestiging | | | | | | |
|  | 0694518 | | chrom | B1382 | stuk | 124,00 | 242 | 0 |
| Kranen | 0694520 | | chrom | B1390 | stuk | 160,00 | 242 | 0 |
| Douchegarnituur | | wand-/plafondlamp halogeen | | | | | | |
|  | 0694522 | | chrom | B1391 | stuk | 176,00 | 242 | 0 |
| Accessoires en spiegels | 0694524 | 175x160x45mm | chrom | B1392 | stuk | 158,00 | 242 | 0 |
| Douchewanden | | wandlamp halogeen | | | | | | |
|  | 0692731 | 255x140x40mm | chrom | B1393 | stuk | 213,00 | 242 | 0 |
| Toebehoren & afvoeren | 0694526 | | chrom | B1420 | stuk | 157,00 | 242 | 0 |
| Spoel- & installatiesystemen | | wand-/plafondlamp | | | | | | |
|  | 0694528 | | chrom | B1421 | stuk | 142,00 | 242 | 0 |
| Badkamermeubelen en toiletkasten | | plafondlamp bol | | | | | | |
|  | 0694532 | | chrom | B1441 | stuk | 149,00 | 242 | 0 |
| Gootstenen en wastroggen | | plafondlamp 3 stuks | | | | | | |
|  | 0694534 | | chrom | B1442 | stuk | 375,00 | 242 | 1 |
| Utiliteit | | halogeenverlichting compleet | | | | | | |
|  | 0693790 | | chrom | B1304CR | stuk | 262,00 | 242 | 1 |

| Art.nr | Specificaties | Kleur | Lev.nr | Ehd | Prijs | Grp | CC | | |
|---|---------------|--------|---------|------|--------|-----|----|---|---|
| | | | | | | | | Colombo Gallery | |
| lamp 220V m. glas | | | | | | | | | |
| 0693138 | | chroom | B1301CH | stuk | 135,00 | 242 | 1 |  | Sanitair producten |
| plafondlamp E27 fitting | | | | | | | | | |
| 0692732 | 310mm | chroom | B1401 | stuk | 189,00 | 242 | 1 |  | Baden / douchebakken / stoomcabines |
| 0692733 | 310mm | chroom | B1402 | stuk | 225,00 | 242 | 1 | | |
| 0692734 | 310mm | chroom | B1403 | stuk | 164,00 | 242 | 1 | | |
| 0692736 | 190mm | chroom | B1404 | stuk | 155,00 | 242 | 1 | | |
| spiegel m. frame m. lichtschakelaar m. stopcontact | | | | | | | | | |
| 0694536 | 40x100cm | | B2006 | stuk | 179,00 | 242 | 0 |  | Kranen |
| 0694538 | 60x90cm | | B2008 | stuk | 179,00 | 242 | 0 | | |
| 0694540 | 50x110cm | | B2009 | stuk | 192,00 | 242 | 1 | | |
| 0694542 | 70x70cm | | B2010 | stuk | 188,00 | 242 | 0 | | |
| 0694544 | 50x90cm | | B2011 | stuk | 183,00 | 242 | 0 | | |
| 0694546 | 60x80cm | | B2012 | stuk | 185,00 | 242 | 0 | | |
| 0694548 | 60x100cm | | B2013 | stuk | 197,00 | 242 | 0 | | |
| 0694550 | 60x120cm | | B2014 | stuk | 215,00 | 242 | 0 | | |
| 0694552 | 80x120cm | | B2015 | stuk | 237,00 | 242 | 1 | | |
| spiegel ovaal m. schakelaar | | | | | | | | | |
| 0692824 | 90x52cm | | B2007 | stuk | 207,00 | 242 | 1 |  | Douchegarnituur |
| spiegel m. halogeenverlichting m. lichtschakelaar | | | | | | | | | |
| 0692972 | 60x116cm | | B2000CR | stuk | 428,00 | 242 | 1 |  | Accessoires en spiegels |
| spiegelkast uitschuifbaar m. verlichting | | | | | | | | | |
| 0692980 | 96.5cm | | B2001CR | stuk | 836,00 | 242 | 1 |  | Douchewanden |

- Sanitair producten
- Baden /
douchebakken /
stoomcabines
- Kranen
- Douchegarnituur
- Accessoires en
spiegels
- Douchewanden
- Toebehoren &
afvoeren
- Spoel- &
installatiesystemen
- Badkamermeubelen
en toiletkasten
- Gootstenen en
wastroggen
- Utiliteit

| | Art.nr | Specificaties | Kleur | Lev.nr | Ehd | Prijs | Grp | CC |
|---|---|---|-------------|---------|------|--------|-----|----|
| | Colombo Gallery | | | | | | | |
| Sanitair producten |  | spiegel rechthoekig m. lichtschakelaar m. stekker 0694517 | chroom | B0127 | stuk | 202,00 | 242 | 1 |
| Baden / douchebakken / stoomcabines | | | | | | | | |
| Kranen |  | spiegel rond m. lichtschakelaar m. stekker 0694525 | chroom | B0128 | stuk | 230,00 | 242 | 1 |
| Douchegarnituur | | | | | | | | |
| Accessoires en spiegels |  | spiegel toogmodel m. lichtschakelaar m. stekker 0694584 | chroom | B1228 | stuk | 224,00 | 242 | 1 |
| Douchewanden | Colombo Khala | | | | | | | |
| Toebehoren & afvoeren |  | zeephouder 0692832 | chroom | B1801CR | stuk | 79,00 | 242 | 1 |
| Spoel- & installatiesystemen |  | zeepdispenser m. glas 0692840 | chroom | B9303CR | stuk | 107,00 | 242 | 1 |
| Badkamermeubelen en toiletkasten |  | glashouder m. glas 0692859 | chroom | B1802CR | stuk | 89,00 | 242 | 1 |
| Gootstenen en wastroggen | | | | | | | | |
| Utiliteit |  | zeepbakje/glashouder 0694606 | glas/chroom | B1804CR | stuk | 149,00 | 242 | 1 |
| |  | zeepbakje voor bad 0694592 | glas/chroom | B1803CR | stuk | 133,00 | 242 | 1 |
| |  | planchet m. glasplaat 68cm 0692867 | chroom | B1816CR | stuk | 188,00 | 242 | 1 |
| |  | verstelbare planchethouders 4-10mm 0694614 | chroom | B18PZCR | stuk | 36,50 | 242 | 1 |

| Art.nr | Specificaties | Kleur | Lev.nr | Ehd | Prijs | Grp | CC | | |
|--|--|-------|---------|------|--------|-----|----|---|---|
| | | | | | | | | Colombo Khala | |
| zeepschaal staand 0692875 | | chrom | B1840CR | stuk | 50,50 | 242 | 1 |  | Sanitair producten |
| glashouder staand m. glas 0692883 | | chrom | B1841CR | stuk | 69,50 | 242 | 1 |  | Baden / douchebakken / stoomcabines |
| badgreep 40cm 0692905 | | chrom | B1809CR | stuk | 79,00 | 242 | 1 |  | Kranen |
| handdoekhouder 65cm 0692913 | | chrom | B1811CR | stuk | 91,00 | 242 | 1 |  | Douchegarnituur |
| 2-lids handdoekhouder 0692921 | | chrom | B1813CH | stuk | 109,00 | 242 | 1 |  | Accessoires en spiegels |
| handdoekring 0692948 | | chrom | B1831CR | stuk | 56,50 | 242 | 1 |  | Douchewanden |
| closetrolhouder z. klep 0692891 | | chrom | B1808CR | stuk | 53,50 | 242 | 1 |  | Toebehoren & afvoeren |
| closetborstelgarnituur m. glas 0692956 | | chrom | B1807CR | stuk | 116,00 | 242 | 1 |  | Spoel- & installatiesystemen |
| closetborstelgarnituur staand 0694622 | | chrom | B9405CR | stuk | 115,00 | 242 | 1 |  | Badkamermeubelen en toiletkasten |
| haak 0692964 | | chrom | MH17CR | stuk | 35,25 | 242 | 1 |  | Gootstenen en wastroggen |
| | | | | | | | | Colombo Khala onderdelen | |
| 0692691 | glas los voor B1802-1802C-1804 | | B1852 | stuk | 21,00 | 242 | 1 | | |
| 0692692 | zeepschaal los voor B1803 | | B1853 | stuk | 85,00 | 242 | 1 | | |
| 0692693 | zeep-/glashouder los voor B1804 | | B1854 | stuk | 96,50 | 242 | 1 | | |
| 0692694 | planchet los z. bevestiging voor B1816 | | B1859 | stuk | 110,00 | 242 | 1 | | |
| 0692695 | zeepdispenser z. pomp voor B9303-9304 | | B9351 | stuk | 28,00 | 242 | 1 | | |

| Art.nr | Specificaties | Kleur | Lev.nr | Ehd | Prijs | Grp | CC |
|--------|---------------|-------|--------|-----|-------|-----|----|
|--------|---------------|-------|--------|-----|-------|-----|----|

Colombo Khala onderdelen

| | | | | | | | |
|---------|--|--|-------|------|-------|-----|---|
| 0692696 | glas voor closetborstelhouder B1807-1807C | | B1856 | stuk | 47,25 | 242 | 1 |
| 0692698 | closetborstel los m. afdekplaat voor B1807 | | B1858 | stuk | 41,50 | 242 | 1 |
| 0692699 | closetborstel los m. afdekplaat voor B9405 | | B9468 | stuk | 45,75 | 242 | 1 |
| 0692686 | closetborstel los voor B0506-B1235 | | B0557 | stuk | 12,50 | 242 | 1 |
| 0692688 | pomp voor zeepdispenser | | B9353 | stuk | 31,50 | 242 | 1 |

Colombo Isole

staande set 74.5cm m. closetrolhouder m. closetborstelgarnituur

| | | | | | | | |
|---------|--|-------|-------|------|--------|-----|---|
| 0693204 | | chrom | B9407 | stuk | 303,00 | 242 | 1 |
|---------|--|-------|-------|------|--------|-----|---|



staande set 90cm m. closetrolhouder m. closetborstelgarnituur m. planchet

| | | | | | | | |
|---------|--|-------|-------|------|--------|-----|---|
| 0693205 | | chrom | B9408 | stuk | 418,00 | 242 | 1 |
|---------|--|-------|-------|------|--------|-----|---|



staande set 89cm m. 3 handdoekhouders

| | | | | | | | |
|---------|--|-------|-------|------|--------|-----|---|
| 0693206 | | chrom | B9403 | stuk | 270,00 | 242 | 1 |
|---------|--|-------|-------|------|--------|-----|---|



staande set 178cm m. haken m. handdoekhouder

| | | | | | | | |
|---------|--|-------|-------|------|--------|-----|---|
| 0693207 | | chrom | B9404 | stuk | 382,00 | 242 | 1 |
|---------|--|-------|-------|------|--------|-----|---|



staande set 178cm m. haken m. 2-lids handdoekhouder

| | | | | | | | |
|---------|--|-------|-------|------|--------|-----|---|
| 0693208 | | chrom | B9412 | stuk | 382,00 | 242 | 1 |
|---------|--|-------|-------|------|--------|-----|---|



staande set 89cm m. 2-lids handdoekhouder + zeephouder

| | | | | | | | |
|---------|--|-------|---------|------|--------|-----|---|
| 0693104 | | chrom | B9414CR | stuk | 262,00 | 242 | 1 |
|---------|--|-------|---------|------|--------|-----|---|



staande set 89cm m. 3 handdoekhouders

| | | | | | | | |
|---------|--|-------|-------|------|--------|-----|---|
| 0693209 | | chrom | B9415 | stuk | 270,00 | 242 | 1 |
|---------|--|-------|-------|------|--------|-----|---|





















staande set 75cm m. closetrolhouder m. closetborstelgarnituur











| | | | | | | | |
|---------|--|-------|-------|------|--------|-----|---|
| 0693210 | | chrom | B9416 | stuk | 288,00 | 242 | 1 |
|---------|--|-------|-------|------|--------|-----|---|













| Art.nr | Specificaties | Kleur | Lev.nr | Ehd | Prijs | Grp | CC | | |
|---------|--|-------|---------|------|--------|-----|----|---|---|
| | | | | | | | | Colombo Isole | |
| 0693105 | wandset 93cm m. planchet m. handdoekhouder m. spiegel | chrom | B9421CR | stuk | 473,00 | 242 | 1 |  | Sanitair producten |
| 0693106 | wandset 93cm m. glashouder m. zeepouder m. handdoekhouder m. spiegel | chrom | B9420CR | stuk | 408,00 | 242 | 1 |  | Baden / douchebakken / stoomcabines |
| 0693211 | wandset 73cm m. closetrolhouder m. closetborstelgarnituur | chrom | B9423 | stuk | 246,00 | 242 | 1 |  | Kranen |
| 0693212 | wandset 37cm m. zeepouder m. 2-lids handdoekhouder | chrom | B9424 | stuk | 205,00 | 242 | 1 |  | Douchegarnituur |
| | | | | | | | | Colombo Land | |
| 0692762 | glashouder m. gesatineerd glas | chrom | B2802 | stuk | 80,50 | 242 | 1 |  | Accessoires en spiegels |
| 0692765 | glashouder staand m. gesatineerd glas | chrom | B2841 | stuk | 44,75 | 242 | 1 |  | Douchewanden |
| 0692760 | zeepouder | chrom | B2801 | stuk | 72,00 | 242 | 1 |  | Toebehoren & afvoeren |
| 0692763 | zeepouder staand | chrom | B2840 | stuk | 62,00 | 242 | 1 |  | Spoel- & installatiesystemen |
| 0692766 | zeepouder staand gesatineerd | | B2842 | stuk | 49,25 | 242 | 1 |  | Badkamermeubelen en toiletkasten |
| | | | | | | | | | Gootstenen en wastroggen |
| | | | | | | | | | Utiliteit |

| | Art.nr | Specificaties | Kleur | Lev.nr | Ehd | Prijs | Grp | CC |
|---|---|---|--|---|--------------------------------------|--|---------------------------------|-----------------------|
| | Colombo Land | | | | | | | |
| Sanitair producten |  | zeepdispenser m. gesatineerd glas 0692761 | chroom | B9318 | stuk | 101,00 | 242 | 1 |
| Baden / douchebakken / stoomcabines | | | | | | | | |
| Kranen |  | zeepdispenser staand gesatineerd 0692764 | chroom | B9319 | stuk | 67,00 | 242 | 1 |
| Douchegarnituur | | | | | | | | |
| Accessoires en spiegels |  | handdoekring 0692752 | chroom | B2831 | stuk | 54,00 | 242 | 1 |
| Douchewanden | | | | | | | | |
| Toebehoren & afvoeren |  | handdoekhouder m. zeepdispenser 0692753 rechts 0692754 links | chroom chroom | B2874DX B2874SX | stuk stuk | 108,00 108,00 | 242 242 | 1 1 |
| Spoel- & installatiesystemen |  | | | | | | | |
| Badkamermeubelen en toiletkasten | | | | | | | | |
| Gootstenen en wastroggen |  | handdoekhouder 0692755 41cm 0692756 51cm 0692757 61cm 0692758 62cm 0692759 82cm | chroom chroom chroom chroom chroom | B2809 B2810 B2811 B2871 B2872 | stuk stuk stuk stuk stuk | 75,00 82,00 87,50 94,50 107,00 | 242 242 242 242 242 | 1 1 1 1 1 |
| Utiliteit |  | | | | | | | |
| |  | handdoekhouder dubbel 0692773 47.5cm | chroom | B2888 | stuk | 111,00 | 242 | 1 |
| |  | handdoekrek wand 0692780 | chroom | B2889 | stuk | 250,00 | 242 | 1 |

| Art.nr | Specificaties | Kleur | Lev.nr | Ehd | Prijs | Grp | CC | |
|---|---------------|--------|--------|------|--------|-----|----|---|
| Colombo Land | | | | | | | | |
| 2-lids handdoekhouder 0692772 | | chroom | B2813 | stuk | 105,00 | 242 | 1 |  |
| | | | | | | | | Sanitair producten |
| | | | | | | | | Baden / douchebakken / stoomcabines |
| handdoekrek 0692774 47.5cm | | chroom | B2887 | stuk | 199,00 | 242 | 1 |  |
| | | | | | | | | Kranen |
| | | | | | | | | Douchegarnituur |
| handdoekhouder staand draaibaar 0692781 | | chroom | B2838 | stuk | 265,00 | 242 | 1 |  |
| | | | | | | | | Accessoires en spiegels |
| sponshouder gesatineerd 0692767 | | | B2843 | stuk | 54,50 | 242 | 1 |  |
| | | | | | | | | Douchewanden |
| | | | | | | | | Toebehoren & afvoeren |
| planchet gesatineerd glas 0692768 60x14cm | | chroom | B2816 | stuk | 186,00 | 242 | 1 |  |
| | | | | | | | | Spoel- & installatiesystemen |
| | | | | | | | | Badkamermeubelen en toiletkasten |
| planchet m. glas- en zeephouder 0692769 75x14cm | | chroom | B2815 | stuk | 279,00 | 242 | 1 |  |
| | | | | | | | | Gootstenen en wastroggen |
| closetrolhouder z. klep 0692770 | | chroom | B2808 | stuk | 54,50 | 242 | 1 |  |
| | | | | | | | | Utiliteit |
| closetrolhouder m. klep 0692771 | | chroom | B2891 | stuk | 94,50 | 242 | 1 |  |
| | | | | | | | | |
| closetborstelgarnituur staand 0692775 | | chroom | B2806 | stuk | 105,00 | 242 | 1 |  |

| | Art.nr | Specificaties | Kleur | Lev.nr | Ehd | Prijs | Grp | CC |
|---|---|--|-------|-----------|------|--------|-----|----|
| Sanitair producten | Colombo Land | | | | | | | |
| | | closetborstelgarnituur 0692776 | chrom | B2807 | stuk | 113,00 | 242 | 1 |
| Baden / douchebakken / stoomcabines |  | | | | | | | |
| Kranen | handdoekhaak dubbel | | | | | | | |
| | | 0692777 | chrom | CD67 | stuk | 49,25 | 242 | 1 |
| Douchegarnituur |  | | | | | | | |
| Accessoires en spiegels | handdoekhaak enkel | | | | | | | |
| | | 0692779 | chrom | CD77 | stuk | 36,50 | 242 | 1 |
| Douchewanden |  | | | | | | | |
| Toebehoren & afvoeren | Colombo Link | | | | | | | |
| | | zeephouder rechts 0693537 | chrom | B2401DXCR | stuk | 73,00 | 242 | 1 |
| Spoel- & installatiesystemen |  | | | | | | | |
| | | zeephouder links 0693561 | chrom | B2401SXCR | stuk | 73,00 | 242 | 1 |
| Badkamermeubelen en toiletkasten |  | | | | | | | |
| | | zeephouder staand 0693707 | chrom | B2440CR | stuk | 73,00 | 242 | 1 |
| Gootstenen en wastroggen |  | | | | | | | |
| | | zeepdispenser rechts m. glas 0693545 | chrom | B9310DXCR | stuk | 101,00 | 242 | 1 |
| Utiliteit |  | | | | | | | |
| | | zeepdispenser links m. glas 0693588 | chrom | B9310SXCR | stuk | 101,00 | 242 | 1 |
| |  | | | | | | | |
| | | zeepdispenser staand m. glas 0693715 | chrom | B9311CR | stuk | 63,00 | 242 | 1 |
| |  | | | | | | | |
| | | glashouder rechts m. glas 0693553 | chrom | B2402DXCR | stuk | 79,00 | 242 | 1 |
| |  | | | | | | | |











| Art.nr | Specificaties | Kleur | Lev.nr | Ehd | Prijs | Grp | CC | | |
|--|---------------|--------|-----------|------|--------|-----|----|---|---|
| | | | | | | | | Colombo Link | |
| glashouder links m. glas 0693596 | | chroom | B2402SXCR | stuk | 79,00 | 242 | 1 |  | Sanitair producten |
| glashouder staand m. glas 0693723 | | chroom | B2441CR | stuk | 39,00 | 242 | 1 |  | Baden / douchebakken / stoomcabines |
| planchet m. glasplaat 64.5cm 0693618 | | chroom | B2416CR | stuk | 191,00 | 242 | 1 |  | Kranen |
| handdoekhouder 38cm 0694630 | | chroom | B2409CR | stuk | 78,00 | 242 | 1 |  | Douchegarnituur |
| handdoekhouder 58cm 0693650 | | chroom | B2411CR | stuk | 90,00 | 242 | 1 |  | Accessoires en spiegels |
| handdoekkring 0693669 | | chroom | B2431CR | stuk | 59,00 | 242 | 1 |  | Douchewanden |
| 2-lids handdoekhouder 0693758 | | chroom | B2413CR | stuk | 116,00 | 242 | 1 |  | Toebehoren & afvoeren |
| handdoekhouder 31cm 0694649 | | chroom | B2412CR | stuk | 67,00 | 242 | 1 |  | Spoel- & installatiesystemen |
| sponshouder 56.5cm 0693203 | | chroom | B2475 | stuk | 178,00 | 242 | 1 |  | Badkamermeubelen en toiletkasten |
| closetrolhouder m. klep 0693634 | | chroom | B2491CR | stuk | 102,00 | 242 | 1 |  | Gootstenen en wastroggen |
| closetrolhouder z. klep 0693642 | | chroom | B2408CR | stuk | 57,00 | 242 | 1 |  | Utiliteit |









| | Art.nr | Specificaties | Kleur | Lev.nr | Ehd | Prijs | Grp | CC |
|---|---|---|---------------|------------|------|--------|-----|----|
| | Colombo Link | | | | | | | |
| Sanitair producten |  | closetborstelgarnituur rechts 0693677 | chrom | B2407DXCR | stuk | 113,00 | 242 | 1 |
| Baden / douchebakken / stoomcabines | | | | | | | | |
| Kranen |  | closetborstelgarnituur links 0693766 | chrom | B2407SXCR | stuk | 113,00 | 242 | 1 |
| Douchegarnituur | | | | | | | | |
| Accessoires en spiegels |  | closetborstelgarnituur staand 0693685 | chrom | B2406CR | stuk | 115,00 | 242 | 1 |
| Douchewanden |  | haak 0693693 | chrom | AR27CR | stuk | 39,25 | 242 | 1 |
| Toebehoren & afvoeren | | | | | | | | |
| Spoel- & installatiesystemen |  | kast 31.5x110cm links 0693774 | aluminium/wit | BB3010SXBI | stuk | 677,00 | 242 | 1 |
| Badkamermeubelen en toiletkasten | | | | | | | | |
| Gootstenen en wastroggen |  | kast 31.5x110cm rechts 0693782 | aluminium/wit | BB3010DXBI | stuk | 677,00 | 242 | 1 |
| Utiliteit | | | | | | | | |
| | Colombo Link onderdelen | | | | | | | |
| | 0692737 | zeepschaal los voor B2401DX-SX | | B2451 | stuk | 30,50 | 242 | 1 |
| | 0692678 | zeepdispenser z. pomp voor B9309-9310DX-SX | | B9355 | stuk | 29,00 | 242 | 1 |
| | 0692701 | glas los voor B2402DX-SX | | B2452 | stuk | 22,00 | 242 | 1 |
| | 0692702 | zeep-/glashouder los voor B2404 | | B2454 | stuk | 96,00 | 242 | 1 |
| | 0692703 | planchet los z. bevestiging voor B2416 | | B2461 | stuk | 115,00 | 242 | 1 |
| | 0692704 | glas los voor B2407DX-SX | | B2450 | stuk | 45,50 | 242 | 1 |
| | 0692705 | glas los voor B2406 | | B2456 | stuk | 72,50 | 242 | 1 |
| | 0692706 | closetborstel los m. afdekplaat voor B2407SX-DX-B2406 | | B2458 | stuk | 36,00 | 242 | 1 |
| | 0692685 | closetborstel los | | B0157 | stuk | 12,25 | 242 | 1 |
| | 0692688 | pomp voor zeepdispenser | | B9353 | stuk | 31,50 | 242 | 1 |











LOOK







Design: Luca Colombo













| | Art.nr | Specificaties | Kleur | Lev.nr | Ehd | Prijs | Grp | CC |
|---|---|--|-------|--------|------|--------|-----|----|
| Sanitair producten | Colombo Look | | | | | | | |
| |  | glashouder wand m. matglas 0692623 | chrom | B1602 | stuk | 68,50 | 242 | 0 |
| Baden / douchebakken / stoomcabines |  | glashouder staand m. matglas 0692626 | chrom | B1641 | stuk | 59,50 | 242 | 1 |
| Kranen | | | | | | | | |
| Douchegarnituur |  | zeephouder wand m. matglas 0692621 | chrom | B1601 | stuk | 80,50 | 242 | 1 |
| Accessoires en spiegels |  | zeepschaal m. matglas 0692624 | chrom | B1640 | stuk | 62,00 | 242 | 1 |
| Douchewanden |  | zeepdispenser m. handdoekhouder 0692631 | chrom | B1674 | stuk | 120,00 | 242 | 1 |
| Toebehoren & afvoeren |  | zeepdispenser wandmodel m. matglas 0692622 | chrom | B9316 | stuk | 97,00 | 242 | 0 |
| Badkamermeubelen en toiletkasten |  | zeepdispenser staand m. matglas 0692625 | chrom | B9317 | stuk | 83,00 | 242 | 1 |
| Gootstenen en wastroggen |  | planchet 60cm m. matglas 0692627 | chrom | B1616 | stuk | 116,00 | 242 | 1 |
| Utiliteit |  | handdoekhouder 42cm 0692632 | chrom | B1609 | stuk | 79,00 | 242 | 1 |
| |  | handdoekhouder 57cm 0692633 | chrom | B1610 | stuk | 84,00 | 242 | 1 |
| |  | handdoekhouder 72cm 0692634 | chrom | B1611 | stuk | 92,00 | 242 | 1 |









| Art.nr | Specificaties | Kleur | Lev.nr | Ehd | Prijs | Grp | CC | | |
|---|---------------|-------|--------|------|--------|-----|----|---|---|
| | | | | | | | | Colombo Look | |
| handdoekhouder 2-delig 0692635 | | chrom | B1612 | stuk | 104,00 | 242 | 0 |  | Sanitair producten |
| handdoekring 0692630 | | chrom | B1631 | stuk | 67,00 | 242 | 0 |  | Baden / douchebakken / stoomcabines |
| handdoekrek 0692636 | | chrom | B1687 | stuk | 167,00 | 242 | 1 |  | Kranen |
| closetrolhouder z. klep 0692628 | | chrom | B1608 | stuk | 57,50 | 242 | 0 |  | Douchegarnituur |
| closetrolhouder m. klep 0692629 | | chrom | B1691 | stuk | 83,00 | 242 | 0 |  | Accessoires en spiegels |
| closetborstelgarnituur staand 0692640 | | chrom | B1606 | stuk | 128,00 | 242 | 1 |  | Douchewanden |
| closetborstelgarnituur wand 0692641 | | chrom | B1607 | stuk | 146,00 | 242 | 0 |  | Toebehoren & afvoeren |
| kledinghaak 0692637 | | chrom | LC27 | stuk | 25,25 | 242 | 0 |  | Spoel- & installatiesystemen |
| kapstok m. 3 haakjes 0692639 | | chrom | LC37 | stuk | 39,75 | 242 | 1 |  | Badkamermeubelen en toiletkasten |
| | | | | | | | | Colombo Look onderdelen | |
| 0692716 zeepschaal los voor B1601 | | | B1651 | stuk | 29,00 | 242 | 1 | | Gootstenen en wastroggen |
| 0692717 glas los voor B1602 | | | B1652 | stuk | 24,25 | 242 | 1 | | |
| 0692718 zeepdispenser z. pomp B9316-1674 | | | B9359 | stuk | 32,00 | 242 | 1 | | |
| 0692720 planchet los z. bevestiging voor B1616 | | | B1661 | stuk | 82,50 | 242 | 1 | | |
| 0692721 glas los voor closetborstelhouder B1606-1607 | | | B1659 | stuk | 9,10 | 242 | 1 | | |
| 0692722 closetborstel los m. afdekplaat voor B1606-1607 | | | B1658 | stuk | 103,00 | 242 | 1 | | |
| 0692685 closetborstel los | | | B0157 | stuk | 12,25 | 242 | 1 | | |
| 0692723 pomp voor zeepdispenser | | | B9358 | stuk | 38,25 | 242 | 1 | | Utiliteit |



| | Art.nr | Specificaties | Kleur | Lev.nr | Ehd | Prijs | Grp | CC |
|---|---|--|-------|---------|------|--------|-----|----|
| Sanitair producten | Colombo Luna | | | | | | | |
| |  | closetrolhouder z. klep 0693251 | chrom | B0108CR | stuk | 63,00 | 242 | 1 |
| Baden / douchebakken / stoomcabines |  | zeepdispenser m. glaszet 0693200 | chrom | B0101CR | stuk | 72,50 | 242 | 1 |
| Kranen |  | zeepdispenser m. glaszet 0693202 | chrom | B0140 | stuk | 61,00 | 242 | 1 |
| Douchegarnituur |  | zeepdispenser m. glas 0693219 | chrom | B9309CR | stuk | 90,50 | 242 | 1 |
| Accessoires en spiegels |  | glashouder m. glas 0693235 | chrom | B0102CR | stuk | 72,50 | 242 | 1 |
| Douchewanden |  | glashouder m. glas staand 0694509 | chrom | B0141CR | stuk | 65,00 | 242 | 1 |
| Toebehoren & afvoeren |  | planchet m. glasplaat 71cm 0693243 | chrom | B0130CR | stuk | 126,00 | 242 | 1 |
| Spoel- & installatiesystemen |  | planchet glas 41cm 0694495 | chrom | B0115CR | stuk | 96,50 | 242 | 1 |
| Badkamermeubelen en toiletkasten |  | sponshouder glas 0694487 | chrom | B0103CR | stuk | 96,00 | 242 | 1 |
| Gootstenen en wastroggen |  | handdoekhouder 33cm 0693278 | chrom | B0131CR | stuk | 72,00 | 242 | 1 |
| Utiliteit |  | handdoekhouder 63cm 0693286 | chrom | B0110CR | stuk | 80,50 | 242 | 1 |











| Art.nr | Specificaties | Kleur | Lev.nr | Ehd | Prijs | Grp | CC | | |
|--|---------------|-------|---------|------|--------|-----|----|---|---|
| Colombo Luna | | | | | | | | | |
| 2-lids handdoekhouder 0693294 | | chrom | B0112CR | stuk | 86,50 | 242 | 1 |  | Sanitair producten |
| handdoekring 0693308 | | chrom | B0111CR | stuk | 70,50 | 242 | 1 |  | Baden / douchebakken / stoomcabines |
| closetborstelgarnituur m. glas 0693316 | | chrom | B0107CR | stuk | 102,00 | 242 | 1 |  | Kranen |
| closetborstelgarnituur staand 0693324 | | chrom | B0506CR | stuk | 75,00 | 242 | 1 |  | Douchegarnituur |
| haak enkel 0693332 | | chrom | CB37CR | stuk | 36,00 | 242 | 1 |  | Accessoires en spiegels |
| haak 3-delig 0693340 | | chrom | CB17CR | stuk | 79,00 | 242 | 1 |  | Douchewanden |
| Colombo Luna onderdelen | | | | | | | | | |
| 0692674 zeepschaal los voor B0101-B0140 | | | B0151 | stuk | 19,00 | 242 | 1 | | Toebehoren & afvoeren |
| 0692678 zeepdispenser z. pomp voor B9309-9310DX-SX | | | B9355 | stuk | 29,00 | 242 | 1 | | Spoel- & installatiesystemen |
| 0692679 glas los voor B0102-B0141 | | | B0152 | stuk | 21,00 | 242 | 1 | | Badkamermeubelen en toiletkasten |
| 0692680 sponshouder los voor B0103 | | | B0153 | stuk | 42,50 | 242 | 1 | | Gootstenen en wastroggen |
| 0692681 glas voor closetborstelhouder B0106-0107-1207 | | | B0156 | stuk | 48,50 | 242 | 1 | | Utiliteit |
| 0692682 planchet los z. bevestiging voor B0130 | | | B0167 | stuk | 88,00 | 242 | 1 | | |
| 0692683 closetborstel los m. afdekplaat voor B0106-0107-1207 | | | B0158 | stuk | 34,75 | 242 | 1 | | |
| 0692684 closetborstel los m. afdekplaat voor B0506-B1235 | | | B0558 | stuk | 47,25 | 242 | 1 | | |
| 0692685 closetborstel los | | | B0157 | stuk | 12,25 | 242 | 1 | | |
| 0692686 closetborstel los voor B0506-B1235 | | | B0557 | stuk | 12,50 | 242 | 1 | | |
| 0692687 RVS houder los voor B0506 | | | B0559 | stuk | 9,10 | 242 | 1 | | |
| 0692688 pomp voor zeepdispenser | | | B9353 | stuk | 31,50 | 242 | 1 | | |
| Colombo Melo | | | | | | | | | |
| zeephouder m. glas 0692999 | | chrom | B1201CR | stuk | 82,00 | 242 | 1 |  | |









| | Art.nr | Specificaties | Kleur | Lev.nr | Ehd | Prijs | Grp | CC |
|---|---|---|-------------|---------|------|--------|-----|----|
| | Colombo Melo | | | | | | | |
| Sanitair producten |  | zeepdispenser m. glas 0693006 | chroom | B9306CR | stuk | 100,00 | 242 | 1 |
| Baden / douchebakken / stoomcabines | | | | | | | | |
| Kranen |  | glashouder m. glas 0693014 | chroom | B1202CR | stuk | 82,00 | 242 | 1 |
| Douchegarnituur | | | | | | | | |
| Accessoires en spiegels |  | planchet 70cm m. glas 0693022 | chroom | B1216CR | stuk | 157,00 | 242 | 1 |
| Douchewanden |  | planchet 0694541 | glas/chroom | 1203CR | stuk | 97,00 | 242 | 1 |
| Toebehoren & afvoeren |  | zeep-/glashouder staand m. glas 0693030 | chroom | B1240CR | stuk | 116,00 | 242 | 1 |
| Spoel- & installatiesystemen |  | closetrolhouder z. klep 0693049 | chroom | B1208CR | stuk | 59,00 | 242 | 1 |
| Badkamermeubelen en toiletkasten | | | | | | | | |
| Gootstenen en wastroggen |  | handdoekhouder 60cm 0693057 | chroom | B1210CR | stuk | 85,50 | 242 | 1 |
| Utiliteit |  | 2-lids handdoekhouder 0693065 | chroom | B1212CR | stuk | 97,00 | 242 | 1 |
| |  | handdoekhouder 45cm 0694568 | chroom | 1209CR | stuk | 78,00 | 242 | 1 |
| |  | handdoekhouder 85cm 0694576 | chroom | 1279CR | stuk | 96,00 | 242 | 1 |
| |  | handdoekkring 0693081 | chroom | B1231CR | stuk | 74,50 | 242 | 1 |











| Art.nr | Specificaties | Kleur | Lev.nr | Ehd | Prijs | Grp | CC | | |
|---|--|--------|---------|------|--------|-----|----|---|---|
| Colombo Melo | | | | | | | | | |
| closetborstelgarnituur m. glas 0693103 | | chroom | B1207CR | stuk | 104,00 | 242 | 1 |  | Sanitair producten Baden / douchebakken / stoomcabines |
| haak 0693111 | | chroom | RA17CR | stuk | 26,75 | 242 | 1 |  | Kranen Douchegarnituur |
| handdoekrek 0693731 | | chroom | B1287CR | stuk | 241,00 | 242 | 1 |  | Accessoires en spiegels |
| Colombo Melo onderdelen | | | | | | | | | |
| 0692681 | glas voor closetborstelhouder B0106-0107-1207 | | B0156 | stuk | 48,50 | 242 | 1 | | Douchewanden Toebehoren & afvoeren |
| 0692690 | planchet los z. bevestiging voor B1216-1286 | | B1261 | stuk | 72,50 | 242 | 1 | | |
| 0692683 | closetborstel los m. afdekplaat voor B0106-0107-1207 | | B0158 | stuk | 34,75 | 242 | 1 | | |
| 0692684 | closetborstel los m. afdekplaat voor B0506-B1235 | | B0558 | stuk | 47,25 | 242 | 1 | | |
| 0692685 | closetborstel los | | B0157 | stuk | 12,25 | 242 | 1 | | |
| 0692686 | closetborstel los voor B0506-B1235 | | B0557 | stuk | 12,50 | 242 | 1 | | |
| 0692688 | pomp voor zeepdispenser | | B9353 | stuk | 31,50 | 242 | 1 | | |
| Colombo Viva | | | | | | | | | |
| zeephouder 0693383 | | chroom | B2601CR | stuk | 66,00 | 242 | 1 |  | Spoel- & installatiesystemen |
| zeephouder staand 0693502 | | chroom | B2640CR | stuk | 22,75 | 242 | 1 |  | Badkamermeubelen en toiletkasten |
| zeepdispenser m. glas 0693391 | | chroom | B9312CR | stuk | 96,50 | 242 | 1 |  | Gootstenen en wastroggen Utiliteit |
| zeepdispenser staand 0693510 | | chroom | B9313CR | stuk | 68,00 | 242 | 1 |  | |
| zeepdispenser m. handdoekhouder 0692601 | | chroom | B2674 | stuk | 124,00 | 242 | 1 |  | |

| | Art.nr | Specificaties | Kleur | Lev.nr | Ehd | Prijs | Grp | CC |
|---|---|---|-------|---------|------|--------|-----|----|
| | Colombo Viva | | | | | | | |
| Sanitair producten | | glashouder m. glas 0693405 | chrom | B2602CR | stuk | 66,00 | 242 | 1 |
| |  | | | | | | | |
| Baden / douchebakken / stoomcabines | | glashouder staand 0693529 | chrom | B2641CR | stuk | 51,00 | 242 | 1 |
| |  | | | | | | | |
| Kranen | | reserverolhouder 0693413 | chrom | B2690CR | stuk | 71,50 | 242 | 1 |
| |  | | | | | | | |
| Douchegarnituur | | closetrolhouder m. klep 0693421 | chrom | B2691CR | stuk | 103,00 | 242 | 1 |
| |  | | | | | | | |
| Accessoires en spiegels | | closetrolhouder z. klep 0693448 | chrom | B2608CR | stuk | 53,50 | 242 | 1 |
| |  | | | | | | | |
| Douchewanden | | handdoekhouder 62.5cm 0693456 | chrom | B2611CR | stuk | 89,50 | 242 | 1 |
| |  | | | | | | | |
| Toebehoren & afvoeren | | handdoekring 0693464 | chrom | B2631CR | stuk | 67,00 | 242 | 1 |
| |  | | | | | | | |
| Spoel- & installatiesystemen | | closetborstelgarnituur 0693472 | chrom | B2607CR | stuk | 92,00 | 242 | 1 |
| |  | | | | | | | |
| Badkamermeubelen en toiletkasten | | closetborstelgarnituur staand 0693480 | chrom | B2606CR | stuk | 87,00 | 242 | 1 |
| |  | | | | | | | |
| Gootstenen en wastroggen | | | | | | | | |
| Utiliteit | | | | | | | | |







| Art.nr | Specificaties | Kleur | Lev.nr | Ehd | Prijs | Grp | CC | | |
|--|---|--------|------------|------|-------|-----|----|---|----------------------------------|
| | | | | | | | | Colombo Viva | |
| haak 0693499 | | chroom | CB77CR | stuk | 41,00 | 242 | 1 |  | Sanitair producten |
| | | | | | | | | Colombo Viva onderdelen | |
| 0692707 | zeepschaal los voor B2601-2640 | | B2651 | stuk | 22,50 | 242 | 1 | | Kranen |
| 0692708 | glas los voor B2602 | | B2652 | stuk | 22,50 | 242 | 1 | | |
| 0692709 | zeepdispenser z. pomp | | B93560-CB0 | stuk | 30,50 | 242 | 1 | | Douchegarnituur |
| 0692710 | glas los voor closetborstelhouder B2607 | | B2650 | stuk | 35,75 | 242 | 1 | | |
| 0692711 | glas los voor closetborstelhouder B2606 | | B2656 | stuk | 60,50 | 242 | 1 | | |
| 0692712 | closetborstel m. afdekplaat los voor B2606-2607 | | B2658 | stuk | 53,50 | 242 | 1 | | |
| 0692685 | closetborstel los | | B0157 | stuk | 12,25 | 242 | 1 | | |
| 0692738 | pomp los voor zeepdispenser chroom | | B9356CR | stuk | 23,00 | 242 | 1 | | |
| | | | | | | | | Colombo Wishwash Plus | |
| glashouder 0692655 | | chroom | W4902 | stuk | 65,50 | 242 | 1 |  | Accessoires en spiegels |
| zeephouder 0692609 | | chroom | W4901 | stuk | 54,00 | 242 | 1 |  | Douchewanden |
| zeepdispenser staand 0692610 | | chroom | W4980 | stuk | 54,00 | 242 | 1 |  | Toebehoren & afvoeren |
| zeepdispenser wandmodel 0692606 | | chroom | W4981 | stuk | 80,50 | 242 | 0 |  | Spoel- & installatiesystemen |
| planchet 60cm m. helder glas 0692612 | | chroom | W4916 | stuk | 76,50 | 242 | 1 |  | Badkamermeubelen en toiletkasten |
| handdoekhouder 0692615 35cm | | chroom | W4909 | stuk | 54,00 | 242 | 1 |  | Gootstenen en wastroggen |
| 0692656 48.5cm | | chroom | W4910 | stuk | 57,00 | 242 | 1 | | |
| 0692657 63.5cm | | chroom | W4911 | stuk | 65,50 | 242 | 1 | | |
| 0692616 85cm | | chroom | W4912 | stuk | 72,50 | 242 | 1 | | |
| 2-lids handdoekhouder 0692617 | | chroom | W4913 | stuk | 66,50 | 242 | 0 |  | Utiliteit |

| | Art.nr | Specificaties | Kleur | Lev.nr | Ehd | Prijs | Grp | CC |
|---|---|--|-------|---------|------|--------|-----|----|
| | Colombo Wishwash Plus | | | | | | | |
| Sanitair producten | | 2-lids handdoekhouder uittrekbaar 0692658 | chrom | W4914 | stuk | 94,50 | 242 | 1 |
| |  | | | | | | | |
| Baden / douchebakken / stoomcabines | | handdoekhouder enkel uittrekbaar 0692659 | chrom | W4915 | stuk | 50,00 | 242 | 1 |
| |  | | | | | | | |
| Kranen | | handdoekhaak 0692607 | chrom | W4917 | stuk | 27,25 | 242 | 0 |
| |  | | | | | | | |
| Douchegarnituur | | badlakenrek 0692619 | chrom | W4987 | stuk | 161,00 | 242 | 1 |
| |  | | | | | | | |
| Accessoires en spiegels | | handdoekring 0692618 | chrom | W4931 | stuk | 67,50 | 242 | 0 |
| |  | | | | | | | |
| Douchewanden | | kledinghanger voor muurbevestiging 0692660 | chrom | W4995 | stuk | 86,50 | 242 | 1 |
| |  | | | | | | | |
| Toebehoren & afvoeren | | 2-lids handdoekhouder staand 0692602 | chrom | W4936 | stuk | 188,00 | 242 | 1 |
| |  | | | | | | | |
| Spoel- & installatiesystemen | | closetrolhouder z. klep rechts 0692613 | chrom | W4908DX | stuk | 41,25 | 242 | 1 |
| |  | | | | | | | |
| Badkamermeubelen en toiletkasten | | closetrolhouder z. klep links 0692614 | chrom | W4908SX | stuk | 40,25 | 242 | 1 |
| |  | | | | | | | |
| Gootstenen en wastroggen | | closetrolhouder dubbel z. klep 0692604 | chrom | W4990 | stuk | 48,50 | 242 | 0 |
| |  | | | | | | | |
| Utiliteit | | | | | | | | |

| Art.nr | Specificaties | Kleur | Lev.nr | Ehd | Prijs | Grp | CC | | |
|--|---------------|-----------|----------------|------|--------|-----|----|---|---|
| | | | | | | | | Colombo Wishwash Plus | |
| closetborstelgarnituur staand 0692620 | | chrom | W4961 | stuk | 67,50 | 242 | 1 |  | Sanitair producten |
| closetborstelgarnituur wandmodel 0692605 | | chrom | W4962 | stuk | 78,50 | 242 | 0 |  | Baden / douchebakken / stoomcabines |
| spiegel m. kledinghaken 0692608 | | chrom | W4925 | stuk | 135,00 | 242 | 1 |  | Kranen |
| sleutelkastje 0692661 | | wit | B9956WHITE | stuk | 59,50 | 242 | 1 |  | Douchegarnituur |
| 0692663 | | blauw | B9956BLUE | stuk | 59,50 | 242 | 1 | | Accessoires en spiegels |
| 0692664 | | zwart | B9956BLACK | stuk | 59,50 | 242 | 1 | | Douchewanden |
| sleutelkastje m. spiegel 0692666 | | wit | B9957WHITE | stuk | 59,50 | 242 | 1 |  | Toebehoren & afvoeren |
| 0692667 | | blauw | B9957BLUE | stuk | 59,50 | 242 | 1 | | Spael- & installatiesystemen |
| 0692669 | | matchroom | B9957MATNICKEL | stuk | 59,50 | 242 | 1 | | Badkamermeubelen en toiletkasten |
| toiletset compleet voor wandmontage 0692671 | | chrom | W4923 | stuk | 160,00 | 242 | 1 |  | Gootstenen en wastroggen |
| badkamerset compleet voor wandmontage 0692672 | | chrom | W4924 | stuk | 339,00 | 242 | 1 |  | Utiliteit |
| toiletset compleet voor staand model 0692673 | | chrom | W4935 | stuk | 237,00 | 242 | 1 |  | |
| handdoekhouder m. zeepdispenser staand model 0692675 | | chrom | W4937 | stuk | 237,00 | 242 | 1 |  | |

| | Art.nr | Specificaties | Kleur | Lev.nr | Ehd | Prijs | Grp | CC |
|---|---|--|------------|---------|------|--------|-----|----|
| Sanitair producten | Colombo Wishwash Plus | | | | | | | |
| | | 2-lids handdoekhouder vast staand model | | | | | | |
| | 0692676 | | chrom | W4938 | stuk | 402,00 | 242 | 1 |
| Baden / douchebakken / stoomcabines |  | | | | | | | |
| Kranen | handdoekhouder m. plateau m. spiegel staand model | | | | | | | |
| | 0692677 | | chrom | W4939 | stuk | 525,00 | 242 | 1 |
| Douchegarnituur |  | | | | | | | |
| Accessoires en spiegels | Colombo Wishwash Time | | | | | | | |
| | | glashouder m. glas | | | | | | |
| | 0694207 | | chrom | W4202CR | stuk | 51,50 | 242 | 0 |
| Douchewanden |  | | | | | | | |
| Toebehoren & afvoeren | zeephouder m. glas | | | | | | | |
| | 0694193 | | chrom | W4201CR | stuk | 51,50 | 242 | 0 |
| |  | | | | | | | |
| Spoel- & installatiesystemen | zeepdispenser | | | | | | | |
| | 0694215 | | chrom | W4280CR | stuk | 72,50 | 242 | 0 |
| |  | | | | | | | |
| Badkamermeubelen en toiletkasten | planchet 60cm | | | | | | | |
| | 0694223 | | chrom/inox | W4216CR | stuk | 131,00 | 242 | 0 |
| |  | | | | | | | |
| Gootstenen en wastroggen | handdoekkring | | | | | | | |
| | 0694266 | | chrom | W4212CR | stuk | 36,00 | 242 | 0 |
| |  | | | | | | | |
| Utiliteit | badgreep 30cm | | | | | | | |
| | 0694274 | | chrom | W4209CR | stuk | 40,25 | 242 | 1 |
| |  | | | | | | | |
| | handdoekhouder 60cm | | | | | | | |
| | 0694282 | | chrom | W4211CR | stuk | 55,00 | 242 | 1 |
| |  | | | | | | | |
| | closetrolhouder z. klep | | | | | | | |
| | 0694231 | | chrom | W4208CR | stuk | 29,00 | 242 | 0 |
| |  | | | | | | | |
| | closetrolhouder m. klep | | | | | | | |
| | 0694258 | | chrom | W4291CR | stuk | 58,00 | 242 | 0 |
| |  | | | | | | | |











| Art.nr | Specificaties | Kleur | Lev.nr | Ehd | Prijs | Grp | CC | | |
|---|---------------|-------|---------|------|--------|-----|----|---|---|
| Colombo Wishwash Time | | | | | | | | | |
| closetborstelgarnituur wandmodel | | | | | | | | | |
| 0694320 | | chrom | W4207CR | stuk | 109,00 | 242 | 0 |  | Sanitair producten |
| closetborstelhouder | | | | | | | | | |
| 0694827 | | chrom | W4206CR | stuk | 109,00 | 242 | 1 |  | Baden / douchebakken / stoomcabines |
| haak | | | | | | | | | |
| 0694290 | | chrom | W4217CR | stuk | 33,00 | 242 | 0 |  | Kranen |
| 0694304 | | chrom | W4247CR | stuk | 8,60 | 242 | 0 | | |
| haak 3-stuks | | | | | | | | | |
| 0694312 | | chrom | W4257CR | stuk | 38,25 | 242 | 1 |  | Douchegarnituur |
| haakje | | | | | | | | | |
| 0694800 | | chrom | W4227CR | stuk | 45,75 | 242 | 1 |  | Toebehoren & afvoeren |
| 0694819 | | chrom | W4237CR | stuk | 79,00 | 242 | 1 | | |
| Colombo Yoga | | | | | | | | | |
| glashouder | | | | | | | | | |
| 0694355 | | chrom | B2341CR | stuk | 68,50 | 242 | 0 |  | Accessoires en spiegels |
| zeepouder | | | | | | | | | |
| 0694339 | | chrom | B2301CR | stuk | 63,00 | 242 | 0 |  | Douchewanden |
| zeepouder staand | | | | | | | | | |
| 0694398 | | chrom | B2340CR | stuk | 45,75 | 242 | 1 |  | Spoel- & installatiesystemen |
| zeepdispenser wand | | | | | | | | | |
| 0694363 | | chrom | B9314CR | stuk | 102,00 | 242 | 0 |  | Badkamermeubelen en toiletkasten |
| Utiliteit | | | | | | | | | |











| | Art.nr | Specificaties | Kleur | Lev.nr | Ehd | Prijs | Grp | CC |
|---|---|--|-------|-----------|------|--------|-----|----|
| Sanitair producten | Colombo Yoga | | | | | | | |
| |  | zeepdispenser staand 0694371 | chrom | B9315CR | stuk | 85,50 | 242 | 1 |
| Baden / douchebakken / stoomcabines | | | | | | | | |
| Kranen | tandenborstelhouder | | | | | | | |
| |  | 0694347 | chrom | B2304CR | stuk | 66,00 | 242 | 1 |
| Douchegarnituur | | | | | | | | |
| Accessoires en spiegels | handdoekring rechts | | | | | | | |
| |  | 0694436 | chrom | B2312DXCR | stuk | 57,00 | 242 | 1 |
| Douchewanden | handdoekring links | | | | | | | |
| |  | 0694444 | chrom | B2312SXCR | stuk | 57,00 | 242 | 0 |
| Toebehoren & afvoeren | handdoekhouder 53.5cm | | | | | | | |
| |  | 0694452 | chrom | B2310CR | stuk | 77,00 | 242 | 1 |
| Spoel- & installatiesystemen | closetrolhouder rechts | | | | | | | |
| |  | 0694401 | chrom | B2308DXCR | stuk | 41,75 | 242 | 0 |
| Badkamermeubelen en toiletkasten | closetrolhouder links | | | | | | | |
| |  | 0694428 | chrom | B2308SXCR | stuk | 41,75 | 242 | 1 |
| Gootstenen en wastroggen | closetborstelgarnituur | | | | | | | |
| |  | 0694479 | chrom | B2306CR | stuk | 132,00 | 242 | 0 |
| Utiliteit | haak | | | | | | | |
| |  | 0694460 | chrom | FL17CR | stuk | 27,50 | 242 | 0 |
| Colombo Yoga onderdelen | | | | | | | | |
| | 0692713 | zeepdispenser z. pomp B9314 | | B9357 | stuk | 62,50 | 242 | 1 |
| | 0692714 | glas los voor closetborstelhouder B2306 | | B2356 | stuk | 91,00 | 242 | 1 |
| | 0692715 | closetborstel los m. afdekplaat voor B2306 | | B2358 | stuk | 51,00 | 242 | 1 |
| | 0692688 | pomp voor zeepdispenser | | B9353 | stuk | 31,50 | 242 | 1 |
| Utiliteit | Colombo Gipsy | | | | | | | |
| |  | krukje 0694770 | wit | B9955BI | stuk | 74,50 | 242 | 1 |

| Art.nr | Specificaties | Kleur | Lev.nr | Ehd | Prijs | Grp | CC | | |
|---|----------------|--------|--------|------|--------|-----|----|---|---|
| | | | | | | | | Colombo Universeel | |
| hoekkorf dubbel m. planchet m. haak 0694739 | 18x18x30cm | chroom | B9601 | stuk | 132,00 | 242 | 1 |  | Sanitair producten |
| hoekkorf enkel m. haak 0694740 | 18x18x8cm | chroom | B9602 | stuk | 69,00 | 242 | 1 |  | Baden / douchebakken / stoomcabines |
| hoekkorf dubbel m. haak 0694741 | 18x18x29.5cm | chroom | B9604 | stuk | 131,00 | 242 | 1 |  | Kranen |
| hoekkorf dubbel 0694742 | 29x24.5x29cm | chroom | B9607 | stuk | 147,00 | 242 | 1 |  | Douchegarnituur |
| hoekkorf enkel 0694743 | 29x12.5x8cm | chroom | B9608 | stuk | 85,00 | 242 | 1 |  | Accessoires en spiegels |
| hoekkorf dubbel 0694744 | 24.5x24.5x29cm | chroom | B9609 | stuk | 143,00 | 242 | 1 |  | Douchewanden |
| hoekkorf enkel 0694745 | 24.5x15x8cm | chroom | B9610 | stuk | 72,50 | 242 | 1 |  | Toebehoren & afvoeren |
| 0694747 | 26x26x8cm | chroom | B9611 | stuk | 99,50 | 242 | 1 | |  |
| hoekkorf dubbel 0694748 | 24.5x15x29cm | chroom | B9612 | stuk | 143,00 | 242 | 1 |  | Badkamermeubelen en toiletkasten |
| | | | | | | | |  | Gootstenen en wastroggen |
| | | | | | | | | | Utiliteit |

| | Art.nr | Specificaties | Kleur | Lev.nr | Ehd | Prijs | Grp | CC |
|---|---|---|-------|--------|------|--------|-----|----|
| | Colombo Universeel | | | | | | | |
| Sanitair producten | | hoekkorf enkel 0694749 31x18.5x8cm | chrom | B9613 | stuk | 72,50 | 242 | 1 |
| |  | | | | | | | |
| Baden / douchebakken / stoomcabines | | hoekkorf 0693213 | chrom | B9614 | stuk | 121,00 | 242 | 0 |
| |  | | | | | | | |
| Kranen | | hoekkorf enkel 0694750 28x28x8cm | chrom | B9615 | stuk | 112,00 | 242 | 1 |
| |  | | | | | | | |
| Douchegarnituur | | hoekkorf enkel m. haak 0694751 18x18x10.5cm | chrom | B9616 | stuk | 72,50 | 242 | 1 |
| |  | | | | | | | |
| Accessoires en spiegels | | hoekkorf dubbel 0694752 18x18x36.5cm | chrom | B9617 | stuk | 146,00 | 242 | 1 |
| |  | | | | | | | |
| Douchewanden | | duo planchet voor douchewand 0693214 | chrom | B9710 | stuk | 176,00 | 242 | 1 |
| |  | | | | | | | |
| Toebehoren & afvoeren | | Castiglia haak 0693154 | chrom | CA37CR | stuk | 30,25 | 242 | 1 |
| |  | | | | | | | |
| Spoel- & installatiesystemen | | Alberto Meda haak 0693170 | chrom | AM17CR | stuk | 19,50 | 242 | 1 |
| |  | | | | | | | |
| Badkamermeubelen en toiletkasten | | 0693189 | chrom | AM27CR | stuk | 34,75 | 242 | 1 |
| |  | | | | | | | |
| Gootstenen en wastroggen | | | | | | | | |
| Utiliteit | | | | | | | | |

| Art.nr | Specificaties | Kleur | Lev.nr | Ehd | Prijs | Grp | CC | | |
|--|---------------|--------|---------|------|--------|-----|----|---|---|
| | | | | | | | | Colombo Universeel | |
| Luca Colombo haak 0693197 | | chroom | LC17CR | stuk | 33,25 | 242 | 1 |  | Sanitair producten |
| handdoekrek 55.5x28.5cm 0693936 | | chroom | B2287CR | stuk | 159,00 | 242 | 1 |  | Baden / douchebakken / stoomcabines |
| badgreep 30.5cm 0693944 | | chroom | B9720CR | stuk | 79,00 | 242 | 1 |  | Kranen |
| greep 55.5cm 0693952 | | chroom | B9721CR | stuk | 92,00 | 242 | 1 |  | Douchegarnituur |
| greep m. zeepbakje 46cm 0693960 | | chroom | B9722CR | stuk | 134,00 | 242 | 1 |  | Accessoires en spiegels |
| Porta houder voor zeppompje 0694711 | | chroom | B9630CR | stuk | 38,25 | 242 | 1 |  | Douchewanden |
| Porta bakje voor bad/douche 0694738 | | chroom | B9631CR | stuk | 67,00 | 242 | 1 |  | Toebehoren & afvoeren |
| Porta bakje voor bad/douche 27cm m. inox plaat 0694746 | | chroom | B9632CR | stuk | 95,50 | 242 | 1 |  | Spoel- & installatiesystemen |
| Porta bakje voor bad/douche 44cm m. inox plaat 0694754 | | chroom | B9633CR | stuk | 139,00 | 242 | 1 |  | Badkamermeubelen en toiletkasten |
| | | | | | | | | | Gootstenen en wastroggen |
| | | | | | | | | | Utiliteit |

| | Art.nr | Specificaties | Kleur | Lev.nr | Ehd | Prijs | Grp | CC |
|---|---|---|-------------|------------|------|--------|-----|----|
| Sanitair producten |  | Dornbracht 480 | | | | | | |
| | | glashouder enkel m. kristal glas | | | | | | |
| | 0473081 | | chroom | 8340048000 | stuk | 163,00 | 172 | 1 |
| | 0470282 | | platina-mat | 8340048006 | stuk | 277,00 | 172 | 1 |
| Baden / douchebakken / stoomcabines |  | zeephouder m. kristal inzet | | | | | | |
| | | 0473103 | | | | | | |
| | 0470283 | | chroom | 8341048000 | stuk | 178,00 | 172 | 1 |
| | | | platina-mat | 8341048006 | stuk | 301,00 | 172 | 1 |
| Kranen |  | zeepdispenser m. opaalglas | | | | | | |
| | | 0473111 | | | | | | |
| | 0470284 | | chroom | 8343048000 | stuk | 217,00 | 172 | 1 |
| | | | platina-mat | 8343048006 | stuk | 342,00 | 172 | 1 |
| Douchegarnituur |  | wandlamp m. opaalglas | | | | | | |
| | | 0473170 | | | | | | |
| | 0470289 | | chroom | 8330048000 | stuk | 280,00 | 172 | 1 |
| | | | platina-mat | 8330048006 | stuk | 476,00 | 172 | 1 |
| Douchewanden |  | handdoekring | | | | | | |
| | | 0473065 | | | | | | |
| | 0470280 | | chroom | 8320048000 | stuk | 109,00 | 172 | 1 |
| | | | platina-mat | 8320048006 | stuk | 185,00 | 172 | 1 |
| Toebehoren & afvoeren |  | handdoekhouder | | | | | | |
| | | 0473049 60cm | | | | | | |
| | 0470278 | 60cm | chroom | 8306048000 | stuk | 146,00 | 172 | 1 |
| | 0473057 | 80cm | platina-mat | 8306048006 | stuk | 247,00 | 172 | 1 |
| Spool- & installatiesystemen |  | handdoekhouder | | | | | | |
| | | 0473057 80cm | | | | | | |
| | 0470279 | 80cm | chroom | 8308048000 | stuk | 159,00 | 172 | 1 |
| | | | platina-mat | 8308048006 | stuk | 270,00 | 172 | 1 |
| Badkamermeubelen en toiletkasten |  | badgreep 30cm | | | | | | |
| | | 0473030 | | | | | | |
| | 0470277 | | chroom | 8303048000 | stuk | 132,00 | 172 | 1 |
| | | | platina-mat | 8303048006 | stuk | 225,00 | 172 | 1 |
| Gootstenen en wastroggen |  | closetrolhouder z. klep | | | | | | |
| | | 0473146 | | | | | | |
| | 0470286 | | chroom | 8350048000 | stuk | 120,00 | 172 | 1 |
| | | | platina-mat | 8350048006 | stuk | 204,00 | 172 | 1 |
| Utiliteit |  | closetrolhouder m. klep | | | | | | |
| | | 0473138 | | | | | | |
| | 0470285 | | chroom | 8351048000 | stuk | 136,00 | 172 | 1 |
| | | | platina-mat | 8351048006 | stuk | 231,00 | 172 | 1 |
| |  | reserverolhouder | | | | | | |
| | | 0473154 | | | | | | |
| | 0470287 | | chroom | 8359048000 | stuk | 120,00 | 172 | 1 |
| | | | platina-mat | 8359048006 | stuk | 204,00 | 172 | 1 |

| Art.nr | Specificaties | Kleur | Lev.nr | Ehd | Prijs | Grp | CC | |
|---|---------------|-------------|------------|------|--------|-----|----|---|
| Dornbracht 480 | | | | | | | | |
| closetborstelgarnituur m. kristal glas | | | | | | | | |
| 0473162 | | chroom | 8390048000 | stuk | 239,00 | 172 | 1 |  |
| 0470288 | | platina-mat | 8390048006 | stuk | 407,00 | 172 | 1 | |
| kledinghaak | | | | | | | | |
| 0473073 | | chroom | 8325148000 | stuk | 26,50 | 172 | 1 |  |
| 0470281 | | platina-mat | 8325148006 | stuk | 45,00 | 172 | 1 | |
| Dornbracht Giorno | | | | | | | | |
| glashouder m. glas | | | | | | | | |
| 0473987 | | chroom | 8340075000 | stuk | 169,00 | 172 | 1 |  |
| zeepouder m. inzet | | | | | | | | |
| 0473995 | | chroom | 8341075000 | stuk | 176,00 | 172 | 1 |  |
| handdoekring | | | | | | | | |
| 0474053 | | chroom | 8320075000 | stuk | 115,00 | 172 | 1 |  |
| 2-lids handdoekhouder | | | | | | | | |
| 0473979 | | chroom | 8321075000 | stuk | 181,00 | 172 | 1 |  |
| closetrolhouder z. klep | | | | | | | | |
| 0473820 | | chroom | 8350075000 | stuk | 127,00 | 172 | 1 |  |
| closetrolhouder m. klep | | | | | | | | |
| 0474002 | | chroom | 8351075000 | stuk | 147,00 | 172 | 1 |  |
| reserverolhouder | | | | | | | | |
| 0473839 | | chroom | 8359075000 | stuk | 127,00 | 172 | 1 |  |
| closetborstelgarnituur | | | | | | | | |
| 0473847 | | chroom | 8390075000 | stuk | 260,00 | 172 | 1 |  |

Sanitair producten

Baden /
douchebakken /
stoomcabines

Kranen

Douchegarnituur

Accessoires en
spiegels

Douchewanden

Toebehoren &
afvoeren

Spoel- &
installatiesystemen

Badkamermeubelen
en toiletkasten

Gootstenen en
wastroggen

Utiliteit

| | Art.nr | Specificaties | Kleur | Lev.nr | Ehd | Prijs | Grp | CC |
|---|--------------------------------|-----------------|------------------|-------------|------------|--------|--------|-------|
| Sanitair producten | Dornbracht 360 | | | | | | | |
| | glashouder | | | | | | | |
| | | 0470880 | m. kristal glas | chroom | 8340036000 | stuk | 147,00 | 172 1 |
| | | 0470235 | m. kristal glas | platina-mat | 8340036006 | stuk | 241,00 | 172 1 |
| | 0470899 | m. kristal glas | messaging | 8340036009 | stuk | 241,00 | 172 1 | |
| Baden / douchebakken / stoomcabines | zeephouder | | | | | | | |
| | | 0470902 | m. kristal inzet | chroom | 8341036000 | stuk | 162,00 | 172 1 |
| | | 0470237 | m. kristal inzet | platina-mat | 8341036006 | stuk | 275,00 | 172 1 |
| | | 0470910 | m. kristal inzet | messaging | 8341036009 | stuk | 275,00 | 172 1 |
| Kranen | zeepdispenser compleet | | | | | | | |
| | | 0473332 | | chroom | 8343036000 | stuk | 235,00 | 172 1 |
| | | 0470911 | | platina-mat | 8343036006 | stuk | 415,00 | 172 1 |
| | | 0473340 | | messaging | 8343036009 | stuk | 415,00 | 172 1 |
| Douchegarnituur | planchet | | | | | | | |
| | | 0470929 45cm | m. kristal plaat | chroom | 8344536000 | stuk | 236,00 | 172 1 |
| | | 0470238 45cm | m. kristal plaat | platina-mat | 8344536006 | stuk | 361,00 | 172 1 |
| | | 0470937 45cm | m. kristal plaat | messaging | 8344536009 | stuk | 361,00 | 172 1 |
| Douchewanden | | 0470945 60cm | m. kristal plaat | chroom | 8346036000 | stuk | 249,00 | 172 1 |
| | | 0470239 60cm | m. kristal plaat | platina-mat | 8346036006 | stuk | 381,00 | 172 1 |
| | | 0470953 60cm | m. kristal plaat | messaging | 8346036009 | stuk | 381,00 | 172 1 |
| | Toebehoren & afvoeren | wandlamp | | | | | | |
| | | 0471062 | m. opaal glas | chroom | 8330036000 | stuk | 316,00 | 172 1 |
| | | 0470245 | m. opaalglas | platina-mat | 8330036006 | stuk | 524,00 | 172 1 |
| | | 0471070 | m. opaal glas | messaging | 8330036009 | stuk | 524,00 | 172 1 |
| Spoel- & installatiesystemen | 2-lids handdoekhouder | | | | | | | |
| | | 0470848 | draaibaar | chroom | 8321036000 | stuk | 186,00 | 172 1 |
| | | 0470226 | draaibaar | platina-mat | 8321036006 | stuk | 352,00 | 172 1 |
| | | 0470856 | draaibaar | messaging | 8321036009 | stuk | 352,00 | 172 1 |
| Badkamermeubelen en toiletkasten | handdoekkring | | | | | | | |
| | | 0470813 | | chroom | 8320036000 | stuk | 116,00 | 172 1 |
| | | 0470225 | | platina-mat | 8320036006 | stuk | 220,00 | 172 1 |
| | | 0470821 | | messaging | 8320036009 | stuk | 220,00 | 172 1 |
| Gootstenen en wastroggen | handdoekhouder | | | | | | | |
| | | 0470775 66cm | | chroom | 8306036000 | stuk | 190,00 | 172 1 |
| | | 0470223 66cm | | platina-mat | 8306036006 | stuk | 360,00 | 172 1 |
| | | 0470783 66cm | | messaging | 8306036009 | stuk | 360,00 | 172 1 |
| Utiliteit | | 0470791 86cm | | chroom | 8308036000 | stuk | 202,00 | 172 1 |
| | | 0470224 86cm | | platina-mat | 8308036006 | stuk | 384,00 | 172 1 |
| | | 0470805 86cm | | messaging | 8308036009 | stuk | 384,00 | 172 1 |
| | badgreep 36cm | | | | | | | |
| | 0470759 | | chroom | 8303036000 | stuk | 174,00 | 172 1 | |
| | 0470222 | | platina-mat | 8303036006 | stuk | 330,00 | 172 1 | |
| | 0470767 | | messaging | 8303036009 | stuk | 330,00 | 172 1 | |
| | closetrolhouder z. klep | | | | | | | |
| | | 0470996 | | chroom | 8350036000 | stuk | 117,00 | 172 1 |
| | | 0471003 | | messaging | 8350036009 | stuk | 221,00 | 172 1 |
| | | 0471005 | | platina-mat | 8350036006 | stuk | 221,00 | 172 1 |

Art.nr Specificaties Kleur Lev.nr Ehd Prijs Grp CC

Dornbracht 360

closetrolhouder m. klep

| | | | | | | | |
|---------|--|-------------|------------|------|--------|-----|---|
| 0470180 | | chrom | 8351036000 | stuk | 146,00 | 172 | 1 |
| 0470240 | | platina-mat | 8351036006 | stuk | 277,00 | 172 | 1 |
| 0470988 | | messing | 8351036009 | stuk | 277,00 | 172 | 1 |



Sanitair producten

Baden /
douchebakken /
stoomcabines

reserverolhouder

| | | | | | | | |
|---------|--|-------------|------------|------|--------|-----|---|
| 0471011 | | chrom | 8359036000 | stuk | 116,00 | 172 | 1 |
| 0471040 | | platina-mat | 8359036006 | stuk | 220,00 | 172 | 1 |
| 0471038 | | messing | 8359036009 | stuk | 220,00 | 172 | 1 |



Kranen

Douchegarnituur

closetborstelgarnituur

| | | | | | | | |
|---------|-----------------|-------------|------------|------|--------|-----|---|
| 0471046 | m. kristal glas | chrom | 8390036000 | stuk | 277,00 | 172 | 1 |
| 0471054 | m. kristal glas | messing | 8390036009 | stuk | 470,00 | 172 | 1 |
| 0471056 | m. kristal glas | platina-mat | 8390036006 | stuk | 470,00 | 172 | 1 |



Accessoires en
spiegels

handdoekhaak

| | | | | | | | |
|---------|----------------------|-------------|------------|------|-------|-----|---|
| 0470864 | sprong 35mm per paar | chrom | 8325097000 | paar | 19,00 | 172 | 1 |
| 0470227 | sprong 35mm per/paar | platina-mat | 8325097006 | stuk | 35,75 | 172 | 1 |
| 0470872 | sprong 35mm per paar | messing | 8325097009 | paar | 35,75 | 172 | 1 |



Douchewanden

Toebehoren &
afvoeren

haakje groot

| | | | | | | | |
|---------|--|-------------|------------|------|-------|-----|---|
| 0471104 | | chrom | 8325197000 | stuk | 18,25 | 172 | 1 |
| 0470867 | | platina-mat | 8325197006 | stuk | 34,00 | 172 | 1 |
| 0470865 | | messing | 8325197009 | stuk | 34,00 | 172 | 1 |



Spoel- &
installatiesystemen

Dornbracht 890

glashouder

| | | | | | | | |
|---------|-----------------|-------------|------------|------|--------|-----|---|
| 0471143 | m. kristal glas | chrom | 8340089000 | stuk | 182,00 | 172 | 0 |
| 0476188 | m. kristal glas | platina-mat | 8340089006 | stuk | 273,00 | 172 | 1 |



Badkamermeubelen
en toiletkasten

Gootstenen en
wastroggen

glashouder/zeepouder staand

| | | | | | | | |
|---------|--|-------------|------------|------|-------|-----|---|
| 0473324 | | chrom | 8342097000 | stuk | 61,00 | 172 | 1 |
| 0476222 | | platina-mat | 8342097006 | stuk | 97,00 | 172 | 1 |



Utiliteit

zeepouder

| | | | | | | | |
|---------|------------------|-------------|------------|------|--------|-----|---|
| 0471151 | m. kristal inzet | chrom | 8341089000 | stuk | 185,00 | 172 | 0 |
| 0476196 | m. kristal inzet | platina-mat | 8341089006 | stuk | 278,00 | 172 | 1 |



zeepouder draadmodel

| | | | | | | | |
|---------|--|-------------|------------|------|--------|-----|---|
| 0470935 | | chrom | 8328053000 | stuk | 101,00 | 172 | 1 |
| 0471102 | | platina-mat | 8328053006 | stuk | 161,00 | 172 | 1 |



hoekzeepouder draadmodel

| | | | | | | | |
|---------|--|-------------|------------|------|--------|-----|---|
| 0471103 | | platina-mat | 8328153006 | stuk | 182,00 | 172 | 1 |
|---------|--|-------------|------------|------|--------|-----|---|



| | Art.nr | Specificaties | Kleur | Lev.nr | Ehd | Prijs | Grp | CC |
|---|--------------------------------|-----------------------|-------------|------------|------|--------|-----|----|
| | Dornbracht 890 | | | | | | | |
| Sanitair producten | zeepdispenser | | | | | | | |
| | 0470931 | wandmodel | chroom | 8343089000 | stuk | 244,00 | 172 | 1 |
| | 0476269 | wandmodel | platina-mat | 8343089006 | stuk | 379,00 | 172 | 1 |
| Baden / douchebakken / stoomcabines | | | | | | | | |
| Kranen | zeepdispenser compleet | | | | | | | |
| | 0474540 | | chroom | 8343097000 | stuk | 229,00 | 172 | 1 |
| | 0471101 | | platina-mat | 8343097006 | stuk | 343,00 | 172 | 1 |
| Douchegarnituur | | | | | | | | |
| Accessoires en spiegels | planchet | | | | | | | |
| | 0471178 | 45cm m. kristal plaat | chroom | 8344589000 | stuk | 210,00 | 172 | 1 |
| | 0476226 | 45cm m. kristal plaat | platina-mat | 8344589006 | stuk | 315,00 | 172 | 1 |
| | 0471186 | 60cm m. kristal plaat | chroom | 8346089000 | stuk | 219,00 | 172 | 1 |
| | 0476234 | 60cm m. kristal plaat | platina-mat | 8346089006 | stuk | 328,00 | 172 | 1 |
| Douchewanden | wandlamp 195mm | | | | | | | |
| | 0471232 | m. opaalglas | chroom | 8330089000 | stuk | 275,00 | 172 | 1 |
| | 0476323 | m. opaalglas | platina-mat | 8330089006 | stuk | 413,00 | 172 | 1 |
| Toebehoren & afvoeren | | | | | | | | |
| Spoel- & installatiesystemen | 2-lids handdoekhouder | | | | | | | |
| | 0471127 | draaibaar | chroom | 8321089000 | stuk | 193,00 | 172 | 1 |
| | 0476218 | draaibaar | platina-mat | 8321089006 | stuk | 289,00 | 172 | 1 |
| Badkamermeubelen en toiletkasten | handdoekring | | | | | | | |
| | 0471119 | | chroom | 8320089000 | stuk | 121,00 | 172 | 1 |
| | 0476242 | | platina-mat | 8320089006 | stuk | 181,00 | 172 | 1 |
| Gootstenen en wastroggen | handdoekhouder | | | | | | | |
| | 0471097 | 65.5cm | chroom | 8306089000 | stuk | 205,00 | 172 | 1 |
| | 0476277 | 65.5cm | platina-mat | 8306089006 | stuk | 308,00 | 172 | 1 |
| | 0471100 | 85.5cm | chroom | 8308089000 | stuk | 217,00 | 172 | 1 |
| Utiliteit | | | | | | | | |
| | 0476285 | 85.5cm | platina-mat | 8308089006 | stuk | 325,00 | 172 | 1 |
| | badgreep 35.5cm | | | | | | | |
| | 0471089 | | chroom | 8303089000 | stuk | 191,00 | 172 | 1 |
| | 0476250 | | platina-mat | 8303089006 | stuk | 286,00 | 172 | 1 |
| | closetrolhouder z. klep | | | | | | | |
| | 0471208 | | chroom | 8350089000 | stuk | 121,00 | 172 | 0 |
| | 0476220 | | platina-mat | 8350089006 | stuk | 181,00 | 172 | 1 |
| | closetrolhouder m. klep | | | | | | | |
| | 0471194 | | chroom | 8351089000 | stuk | 148,00 | 172 | 0 |
| | 0476307 | | platina-mat | 8351089006 | stuk | 222,00 | 172 | 1 |

| Art.nr | Specificaties | Kleur | Lev.nr | Ehd | Prijs | Grp | CC |
|--------|---------------|-------|--------|-----|-------|-----|----|
|--------|---------------|-------|--------|-----|-------|-----|----|

Dornbracht 890

reserverolhouder

| | | | | | | | |
|---------|--|-------------|------------|------|--------|-----|---|
| 0471216 | | chroom | 8359089000 | stuk | 121,00 | 172 | 0 |
| 0476315 | | platina-mat | 8359089006 | stuk | 181,00 | 172 | 1 |



Sanitair producten

Baden /
douchebakken /
stoomcabines

closetborstelgarnituur

| | | | | | | | |
|---------|-----------------|-------------|------------|------|--------|-----|---|
| 0471224 | m. kristal glas | chroom | 8390089000 | stuk | 265,00 | 172 | 0 |
| 0476331 | m. kristal glas | platina-mat | 8390089006 | stuk | 398,00 | 172 | 1 |



Kranen

Douche-garnituur

toiletset

| | | | | | | | |
|---------|--------------|-------------|------------|------|--------|-----|---|
| 0472835 | hoogte 840mm | chroom | 8415097000 | stuk | 582,00 | 172 | 1 |
| 0476221 | hoogte 840mm | platina-mat | 8415097006 | stuk | 873,00 | 172 | 1 |



Accessoires en
spiegels

wastafel/badset

| | | | | | | | |
|---------|--------------|--------|------------|------|--------|-----|---|
| 0471085 | hoogte 840mm | chroom | 8412097000 | stuk | 529,00 | 172 | 1 |
|---------|--------------|--------|------------|------|--------|-----|---|



Douchewanden

Toebehoren &
afvoeren

garderobehaak

| | | | | | | | |
|---------|-------------|-------------|------------|------|-------|-----|---|
| 0471135 | sprong 55mm | chroom | 8325122000 | stuk | 22,50 | 172 | 0 |
| 0471136 | sprong 55mm | platina-mat | 8325122006 | stuk | 33,50 | 172 | 1 |



Spoel- &
installatiesystemen

Badkamermeubelen
en toiletkasten

Dornbracht Lulu

drinkglas los bergkristal

| | | | | | | | |
|---------|--|--|------------|------|-------|-----|---|
| 0272566 | | | 8440071084 | stuk | 52,50 | 172 | 1 |
|---------|--|--|------------|------|-------|-----|---|



Gootstenen en
wastroggen

porselein beker klein staand

| | | | | | | | |
|---------|--|-------------|------------|------|-------|-----|---|
| 0272570 | | wit | 8442071060 | stuk | 50,00 | 172 | 1 |
| 0272571 | | wit/magenta | 8442071064 | stuk | 62,50 | 172 | 1 |



Utiliteit

porselein beker groot staand

| | | | | | | | |
|---------|--|-------------|------------|------|-------|-----|---|
| 0272572 | | wit | 8442571060 | stuk | 54,50 | 172 | 1 |
| 0272573 | | wit/magenta | 8442571064 | stuk | 68,50 | 172 | 1 |











porselein zeepschaal staand

| | | | | | | | |
|---------|--|-----|------------|------|-------|-----|---|
| 0272567 | | wit | 8441071060 | stuk | 45,25 | 172 | 1 |
|---------|--|-----|------------|------|-------|-----|---|



| | Art.nr | Specificaties | Kleur | Lev.nr | Ehd | Prijs | Grp | CC |
|---|---|---------------|-------------|------------|------|--------|-----|----|
| Sanitair producten | Dornbracht Lulu | | | | | | | |
| | planchet | | | | | | | |
| | 0272578 | 47x10cm | chrom/wit | 8345071025 | stuk | 235,00 | 172 | 1 |
| | 0272576 | 70x10cm | chrom/wit | 8347071025 | stuk | 263,00 | 172 | 1 |
| Baden / douchebakken / stoomcabines | | | | | | | | |
| Kranen | porselein schaal/deksel staand | | | | | | | |
| | 0272568 | 96x96cm | wit | 8441171060 | stuk | 44,00 | 172 | 1 |
| | 0272569 | 96x96cm | wit/magenta | 8441171064 | stuk | 55,00 | 172 | 1 |
| Douchegarnituur | | | | | | | | |
| Accessoires en spiegels | badgreep 30cm | | | | | | | |
| | 0272561 | | chrom | 8303071000 | stuk | 192,00 | 172 | 1 |
| Douchewanden | | | | | | | | |
| Toebehoren & afvoeren | wandhanddoekrek | | | | | | | |
| | 0272562 | 70cm | chrom | 8307071000 | stuk | 219,00 | 172 | 1 |
| Spoel- & installatiesystemen | | | | | | | | |
| Badkamermeubelen en toiletkasten | handdoekring | | | | | | | |
| | 0272563 | | chrom | 8320071000 | stuk | 155,00 | 172 | 1 |
| Gootstenen en wastroggen | | | | | | | | |
| Utiliteit | 2-lids handdoekhouder | | | | | | | |
| | 0272564 | | chrom | 8321071000 | stuk | 194,00 | 172 | 1 |
| | handdoekhouder m. planchet | | | | | | | |
| | 0272577 | 70cm | chrom/wit | 8347571025 | stuk | 273,00 | 172 | 1 |
| | 0272579 | 47cm | chrom/wit | 8345571025 | stuk | 245,00 | 172 | 1 |
| | | | | | | | | |
| | closetrolhouder z. klep | | | | | | | |
| | 0272580 | | chrom | 8350071000 | stuk | 140,00 | 172 | 1 |
| | | | | | | | | |
| | closetborstelgarnituur wandmodel | | | | | | | |
| | 0475104 | | chrom | 8390071000 | stuk | 216,10 | 172 | 1 |

| Art.nr | Specificaties | Kleur | Lev.nr | Ehd | Prijs | Grp | CC | |
|---|---------------|-------------|-------------|------|--------|-----|----|---|
| Dornbracht Lulu | | | | | | | | |
| reserverolhouder 0272581 | | chrom | 8359071000 | stuk | 140,00 | 172 | 1 |  |
| haakje 0272565 | | chrom | 8325171000 | stuk | 52,00 | 172 | 1 |  |
| Dornbracht Mem | | | | | | | | |
| glashouder m. glas voor wandmontage 0433081 | | chrom | 8340078000 | stuk | 179,00 | 172 | 1 |  |
| wandzeepschaal 12x4.5x12cm 0433032 | | chrom | 8341078000 | stuk | 183,00 | 172 | 1 |  |
| zeepschaal staand 12x12cm 0433033 | | chrom | 8441078000 | stuk | 168,00 | 172 | 1 |  |
| fles voor zeepdispenser 0433035 | | bergkristal | 08900400182 | stuk | 70,00 | 172 | 1 | |
| planchet 0272587 60x14.5cm | | chrom | 8346078000 | stuk | 271,00 | 172 | 1 | |
| badgreep 30cm 0433076 | | chrom | 8303078000 | stuk | 202,00 | 172 | 1 |  |
| handdoekhouder 60cm 0433077 | | chrom | 8306078000 | stuk | 230,00 | 172 | 1 |  |
| handdoekhouder m. planchet 0272586 60cm | | chrom | 8306578000 | stuk | 451,00 | 172 | 1 | |
| 2-lids handdoekhouder vast 0433079 | | chrom | 8321078000 | stuk | 205,00 | 172 | 1 |  |

Sanitair producten

Baden /
douchebakken /
stoomcabines

Kranen

Douchegarnituur

Accessoires en
spiegels

Douchewanden







Toebehoren &
afvoeren









Spoel- &
installatiesystemen

Badkamermeubelen
en toiletkasten

Gootstenen en
wastroggen

Utiliteit

| | Art.nr | Specificaties | Kleur | Lev.nr | Ehd | Prijs | Grp | CC | |
|---|---|---|-------------|-------------|------------|--------|--------|-----|---|
| Sanitair producten | Dornbracht Mem | | | | | | | | |
| |  | handdoekring | | | | | | | |
| 0433078 | | | chrom | 8320078000 | stuk | 163,00 | 172 | 1 | |
| Baden / douchebakken / stoomcabines | | | | | | | | | |
| Kranen |  | closetrolhouder z. klep | | | | | | | |
| | | 0433037 | | chrom | 8350078000 | stuk | 147,00 | 172 | 1 |
| Douchegarnituur | | | | | | | | | |
| Accessoires en spiegels |  | reserverolhouder | | | | | | | |
| | | 0433038 | | chrom | 8359078000 | stuk | 147,00 | 172 | 1 |
| Douchewanden | | | | | | | | | |
| Toebehoren & afvoeren |  | closetborstelgarnituur wandmodel | | | | | | | |
| | | 0433039 | | chrom | 8391097900 | stuk | 259,00 | 172 | 1 |
| | | 0475093 | | platina mat | 8391097906 | stuk | 387,40 | 172 | 1 |
| Spoel- & installatiesystemen |  | 0475107 | | chrom | 8390078000 | stuk | 226,90 | 172 | 1 |
| | | | | | | | | | |
| Badkamermeubelen en toiletkasten |  | closetborstelgarnituur stand model | | | | | | | |
| 0433042 | | | chrom | 8491097900 | stuk | 234,00 | 172 | 1 | |
| 0475094 | | | platina mat | 8491097906 | stuk | 350,40 | 172 | 1 | |
| Gootstenen en wastroggen | | | | | | | | | |
| Utiliteit | closetborstelgarnituur luxe | | | | | | | | |
| | 0475095 | | chrom | 8390097900 | stuk | 205,10 | 172 | 1 | |
| | 0475096 | | platina mat | 8390097906 | stuk | 307,70 | 172 | 1 | |
| borstel z. steel voor garnituur | | | | | | | | | |
| | 0433041 | | chrom | 08185060190 | stuk | 17,00 | 172 | 1 | |
| | haakje | | | | | | | | |
| | 0433080 | | chrom | 8325178000 | stuk | 55,00 | 172 | 1 | |
| | Dornbracht Meta.02 | | | | | | | | |
|  | glashouder m. kristalglas | | | | | | | | |
| | 0433067 | | chrom | 8340097900 | stuk | 141,00 | 172 | 1 | |
| | 0475082 | | platina mat | 8340097906 | stuk | 211,20 | 172 | 1 | |

| Art.nr | Specificaties | Kleur | Lev.nr | Ehd | Prijs | Grp | CC | |
|--|---------------|-------------|------------|------|--------|-----|----|---|
| Dornbracht Meta.02 | | | | | | | | |
| zeepschaaltje voor buismontage compleet | | | | | | | | |
| 0433070 | | chroom | 8241097900 | stuk | 147,00 | 172 | 1 |  |
| 0475086 | | platina mat | 8241097906 | stuk | 219,90 | 172 | 1 | |
| zeepschaal compleet | | | | | | | | |
| 0433068 | | chroom | 8341097900 | stuk | 146,00 | 172 | 1 |  |
| 0475083 | | platina mat | 8341097906 | stuk | 219,00 | 172 | 1 | |
| zeepschaal voor douche compleet | | | | | | | | |
| 0433069 | | chroom | 8341197900 | stuk | 147,00 | 172 | 1 |  |
| 0475085 | | platina mat | 8341197906 | stuk | 219,90 | 172 | 1 | |
| hoekzeepschaal voor douche compleet | | | | | | | | |
| 0433071 | | chroom | 8328597900 | stuk | 147,00 | 172 | 1 |  |
| 0475087 | | platina mat | 8328597906 | stuk | 219,90 | 172 | 1 | |
| planchet m. glasplaat | | | | | | | | |
| 0433072 | 60cm | chroom | 8346097900 | stuk | 191,00 | 172 | 1 |  |
| 0475088 | 60cm | platina mat | 8346097906 | stuk | 286,60 | 172 | 1 | |
| badgreep | | | | | | | | |
| 0433034 | 20cm | chroom | 8302097900 | stuk | 146,00 | 172 | 1 |  |
| 0475069 | 20cm | platina mat | 8302097906 | stuk | 219,00 | 172 | 1 | |
| badhanddoekhouder | | | | | | | | |
| 0433036 | 60cm | chroom | 8306097900 | stuk | 150,00 | 172 | 1 |  |
| 0475070 | 60cm | platina mat | 8306097906 | stuk | 224,50 | 172 | 1 | |
| 0433053 | 80cm | chroom | 8308097900 | stuk | 156,00 | 172 | 1 | |
| 0475071 | 80cm | platina mat | 8308097906 | stuk | 234,10 | 172 | 1 | |
| handdoekhouder m. planchet | | | | | | | | |
| 0433054 | | chroom | 8306597900 | stuk | 316,00 | 172 | 1 |  |
| 0475072 | | platina mat | 8306597906 | stuk | 473,80 | 172 | 1 | |
| handdoekring | | | | | | | | |
| 0433056 | 185mm | chroom | 8320097900 | stuk | 94,00 | 172 | 1 |  |
| 0475073 | | platina mat | 8320097906 | stuk | 140,50 | 172 | 1 | |

Sanitair producten

Baden /
douchebakken /
stoomcabines

Kranen

Douchegarnituur

Accessoires en
spiegels

Douchewanden









Toebehoren &
afvoeren







Spoel- &
installatiesystemen











Badkamermeubelen
en toiletkasten











Gootstenen en
wastroggen

Utiliteit

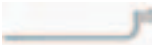



| | Art.nr | Specificaties | Kleur | Lev.nr | Ehd | Prijs | Grp | CC |
|---|---|---------------|-------------|------------|------|--------|-----|----|
| | Dornbracht Meta.02 | | | | | | | |
| Sanitair producten | handdoekring hoekig | | | | | | | |
| | 0433057 | | chroom | 8320597900 | stuk | 125,00 | 172 | 1 |
| | 0475074 | | platina mat | 8320597906 | stuk | 187,40 | 172 | 1 |
| Baden / douchebakken / stoomcabines |  | | | | | | | |
| Kranen | handdoekhouder 2-delig vast | | | | | | | |
| | 0433061 | 33.5cm | chroom | 8321497900 | stuk | 149,00 | 172 | 1 |
| | 0475077 | 33.5cm | platina mat | 8321497906 | stuk | 222,30 | 172 | 1 |
| | 0433065 | 50cm | chroom | 8321097900 | stuk | 164,00 | 172 | 1 |
| | 0475075 | 50cm | platina mat | 8321097906 | stuk | 245,30 | 172 | 1 |
| Douchegarnituur |  | | | | | | | |
| Accessoires en spiegels | handdoekhouder 1-delig vast | | | | | | | |
| | 0433063 | 36cm | chroom | 8321597900 | stuk | 79,00 | 172 | 1 |
| | 0475079 | 36cm | platina mat | 8321597906 | stuk | 117,70 | 172 | 1 |
| | 0433062 | 52cm | chroom | 8321197900 | stuk | 86,00 | 172 | 1 |
| | 0475078 | 52cm | platina mat | 8321197906 | stuk | 128,30 | 172 | 1 |
| Douchewanden |  | | | | | | | |
| Toebehoren & afvoeren | haak 5cm | | | | | | | |
| | 0433064 | | chroom | 8325197900 | stuk | 39,00 | 172 | 1 |
| | 0475080 | | platina mat | 8325197906 | stuk | 58,40 | 172 | 1 |
| Douchewanden |  | | | | | | | |
| Spoel- & installatiesystemen | haak 2-delig 5.5cm | | | | | | | |
| | 0433066 | | chroom | 8325697900 | stuk | 69,00 | 172 | 1 |
| | 0475081 | | platina mat | 8325697906 | stuk | 103,20 | 172 | 1 |
| Badkamermeubelen en toiletkasten |  | | | | | | | |
| Gootstenen en wastroggen | closetrolhouder z. klep | | | | | | | |
| | 0433074 | | chroom | 8350097900 | stuk | 133,00 | 172 | 1 |
| | 0475090 | | platina mat | 8350097906 | stuk | 198,80 | 172 | 1 |
| Gootstenen en wastroggen |  | | | | | | | |
| Utiliteit | closetrolhouder m. klep | | | | | | | |
| | 0433073 | | chroom | 8351097900 | stuk | 171,00 | 172 | 1 |
| | 0475089 | | platina mat | 8351097906 | stuk | 255,10 | 172 | 1 |
| Utiliteit |  | | | | | | | |
| Utiliteit | reserverolhouder | | | | | | | |
| | 0433075 | | chroom | 8359097900 | stuk | 91,50 | 172 | 1 |
| | 0475091 | | platina mat | 8359097906 | stuk | 137,40 | 172 | 1 |
| Utiliteit |  | | | | | | | |
| | Dornbracht Licht in badkamer | | | | | | | |
| | wandlamp 29x65x500mm | | | | | | | |
| | 0475734 | | chroom | 8600197085 | stuk | 287,00 | 172 | 1 |
| | 0475742 | | matchroom | 8600197086 | stuk | 247,00 | 172 | 1 |
| |  | | | | | | | |

| Art.nr | Specificaties | Kleur | Lev.nr | Ehd | Prijs | Grp | CC | | |
|---|---------------|-------------|------------|------|--------|-----|----|---|---|
| Dornbracht Licht in badkamer | | | | | | | | | |
| wandlamp 110x70x600mm 0475750 | | chrom | 8600297085 | stuk | 411,00 | 172 | 1 |  | Sanitair producten |
| wandlamp 110x55x600mm 0475807 | | matchroom | 8606197004 | stuk | 768,00 | 172 | 1 |  | Baden / douchebakken / stoomcabines |
| wandlamp 40x90x600mm 0475769 | | chrom | 8601297085 | stuk | 244,00 | 172 | 1 |  | Kranen |
| wandlamp 40x90x800mm 0475777 | | chrom | 8601397085 | stuk | 256,00 | 172 | 1 | | Douchegarnituur |
| wandlamp 55x95x600mm 0475785 | | matchroom | 8602297085 | stuk | 371,00 | 172 | 1 |  | Accessoires en spiegels |
| wandlamp 55x95x800mm 0475793 | | matchroom | 8602397085 | stuk | 390,00 | 172 | 1 | | Douchewanden |
| plafondlamp rond 30cm 0475815 | | matchroom | 8646297004 | stuk | 652,00 | 172 | 1 |  | Toebehoren & afvoeren |
| plafondlamp vierkant 30cm 0475823 | | matchroom | 8646397004 | stuk | 652,00 | 172 | 1 |  | Spoel- & installatiesystemen |
| Dornbracht Universeel | | | | | | | | | |
| zeepdispenser staand 0474539 | | chrom | 8443097000 | stuk | 211,00 | 172 | 1 |  | Badkamermeubelen en toiletkasten |
| 0474409 | | platina-mat | 8443097006 | stuk | 316,00 | 172 | 1 | | Gootstenen en wastroggen |
| | | | | | | | | | Utiliteit |

| | Art.nr | Specificaties | Kleur | Lev.nr | Ehd | Prijs | Grp | CC |
|---|---|-----------------|--------------|------------|------|--------|-----|----|
| Duravit 1930 | | | | | | | | |
| Sanitair producten | zeepdispenser m. raster | | | | | | | |
| | 0315796 | | chroom | 0097001000 | stuk | 115,00 | 223 | 1 |
| Baden / douchebakken / stoomcabines | glashouder | | | | | | | |
| | 0299560 | m. glas | chroom/wit | 0093510000 | stuk | 140,00 | 223 | 1 |
| | 0299875 | m. glas | chroom/perg. | 0093514700 | stuk | 140,00 | 223 | 1 |
| |  | | | | | | | |
| Kranen | zeephouder | | | | | | | |
| | 0299561 | m. glazen inzet | chroom/wit | 0093610000 | stuk | 133,00 | 223 | 1 |
| | 0299876 | m. glazen inzet | chroom/perg. | 0093614700 | stuk | 133,00 | 223 | 1 |
| |  | | | | | | | |
| Douchegarnituur | spiegel m. facetrand | | | | | | | |
| | 0296139 | 59x40cm | | 0084900000 | stuk | 217,00 | 223 | 1 |
| | 0296119 | 68x47cm | | 0084920000 | stuk | 260,00 | 223 | 1 |
| | 0296120 | 80x55cm | | 0084910000 | stuk | 270,00 | 223 | 1 |
| |  | | | | | | | |
| Accessoires en spiegels | wandlamp | | | | | | | |
| | 0299568 | m. opaalglas | chroom/wit | 0093710000 | stuk | 188,00 | 223 | 1 |
| Douchewanden | 0299883 | m. opaalglas | chroom/perg. | 0093714700 | stuk | 188,00 | 223 | 1 |
| |  | | | | | | | |
| Toebehoren & afvoeren | 2-lids handdoekhouder | | | | | | | |
| | 0299563 | | chroom/wit | 0093210000 | stuk | 218,00 | 223 | 1 |
| Spoel- & installatiesystemen | 0299878 | | chroom/perg. | 0093214700 | stuk | 218,00 | 223 | 1 |
| |  | | | | | | | |
| Badkamermeubelen en toiletkasten | handdoekring | | | | | | | |
| | 0299562 | | chroom/wit | 0093910000 | stuk | 116,00 | 223 | 1 |
| | 0299877 | | chroom/perg. | 0093914700 | stuk | 116,00 | 223 | 1 |
| |  | | | | | | | |
| Gootstenen en wastroggen | handdoekhouder 89.5cm | | | | | | | |
| | 0299564 | | chroom/wit | 0093310000 | stuk | 178,00 | 223 | 1 |
| | 0299879 | | chroom/perg. | 0093314700 | stuk | 178,00 | 223 | 1 |
| |  | | | | | | | |
| Utiliteit | badgreep 39.5cm | | | | | | | |
| | 0299565 | | chroom/wit | 0093410000 | stuk | 157,00 | 223 | 1 |
| | 0299880 | | chroom/perg. | 0093414700 | stuk | 157,00 | 223 | 1 |
| |  | | | | | | | |
| | handdoekhouder | | | | | | | |
| | 0299569 | staand | chroom/wit | 0093810000 | stuk | 412,00 | 223 | 1 |
| | 0299884 | staand | chroom/perg. | 0093814700 | stuk | 412,00 | 223 | 1 |
| |  | | | | | | | |
| | closetrolhouder | | | | | | | |
| | 0299566 | z. klep | wit | 0093000000 | stuk | 102,00 | 223 | 1 |
| | 0299881 | z. klep | pergamon | 0093004700 | stuk | 102,00 | 223 | 1 |
| |  | | | | | | | |
| | closetborstelgarnituur | | | | | | | |
| | 0299567 | | chroom/wit | 0093110000 | stuk | 126,00 | 223 | 1 |
| | 0299882 | | chroom/perg. | 0093114700 | stuk | 126,00 | 223 | 1 |
| |  | | | | | | | |

| Art.nr | Specificaties | Kleur | Lev.nr | Ehd | Prijs | Grp | CC | | |
|---|---------------|--------|------------|------|--------|-----|----|---|---|
| | | | | | | | | Duravit Foster | |
| glashouder 0305138 | | chroom | 0098151000 | stuk | 104,00 | 223 | 1 |  | Sanitair producten |
| zeephouder 0305146 | | chroom | 0098161000 | stuk | 102,00 | 223 | 1 |  | Baden / douchebakken / stoomcabines |
| zeepdispenser 0305154 | | chroom | 0098171000 | stuk | 200,00 | 223 | 1 |  | Kranen |
| planchet 60cm 0305189 | | chroom | 0098201000 | stuk | 165,00 | 223 | 1 |  | Douchegarnituur |
| handdoekhouder 80cm 0305065 | | chroom | 0098101000 | stuk | 159,00 | 223 | 1 |  | Accessoires en spiegels |
| 1-lids handdoekhouder 0305073 | | chroom | 0098111000 | stuk | 118,00 | 223 | 1 |  | Douchewanden |
| 2-lids handdoekhouder 0305081 | | chroom | 0098121000 | stuk | 143,00 | 223 | 1 |  | Toebehoren & afvoeren |
| handdoekring 0305103 | | chroom | 0098131000 | stuk | 125,00 | 223 | 1 |  | Spoel- & installatiesystemen |
| badgreep 30cm 0305197 | | chroom | 0098211000 | stuk | 132,00 | 223 | 1 |  | Badkamermeubelen en toiletkasten |
| closetrolhouder z. klep 0305170 | | chroom | 0098191000 | stuk | 102,00 | 223 | 1 |  | Gootstenen en wastroggen |
| closetborstelgarnituur 0305162 | | chroom | 0098181000 | stuk | 164,00 | 223 | 1 |  | Utiliteit |
| handdoekhaak 0305111 | | chroom | 0098141000 | stuk | 31,00 | 223 | 1 |  | |

| | Art.nr | Specificaties | Kleur | Lev.nr | Ehd | Prijs | Grp | CC |
|---|-------------------------------------|--|--|-----------------|-------------|--------|--------|-----|
| Sanitair producten | D-Line RVS | | | | | | | |
| | | glashouder z. beker 0091804 | RVS-borstel | 14704202009 | stuk | 104,00 | 383 | 1 |
| Baden / douchebakken / stoomcabines | | kunststof glas transparant 0091812 | RVS-borstel | 14704200103 | stuk | 12,25 | 383 | 1 |
| | Kranen | | zeepschaal 0090011 | wit/RVS-borstel | 14703402128 | stuk | 94,00 | 383 |
| | | 0090006 | grijs/RVS-borstel | 14703602127 | stuk | 104,00 | 383 | 1 |
| Douchegarnituur | | magneet zeephouder 0090019 | RVS-borstel | 14704402008 | stuk | 43,75 | 383 | 1 |
| Accessoires en spiegels | | zeepdispenser 0090014 | RVS-borstel | 14704502004 | stuk | 320,00 | 383 | 1 |
| Douchewanden | | tandenborstelhouder 0091871 | wit/RVS-borstel | 14704302054 | stuk | 42,25 | 383 | 1 |
| Toebehoren & afvoeren | | 0091898 | grijs/RVS-borstel | 14704302103 | stuk | 42,25 | 383 | 1 |
| | Badkamermeubelen en toiletkasten | | planchethouders per paar 0091766 | RVS-borstel | 14700002129 | stuk | 124,00 | 383 |
| Gootstenen en wastroggen | | | glasplaat 63x12cm 0091774 | RVS-borstel | 14700500056 | stuk | 74,00 | 383 |
| Utiliteit | | spiegelhouder per stuk 0090001 | RVS-borstel | 14701002009 | stuk | 20,50 | 383 | 1 |
| | | badgreep recht 30cm 0090010 | RVS-borstel | 14461402306 | stuk | 131,00 | 383 | 1 |
| | | klikrozetten 75mm voor badgreep 32mm 0090016 | | 14496302321 | stuk | 62,50 | 383 | 1 |
| | | handdoekhouder 50cm 0091782 | RVS-borstel | 14702602506 | stuk | 262,00 | 383 | 1 |
| | | shampoorek 0091790 | RVS-borstel | 14703102302 | stuk | 141,00 | 383 | 1 |
| | | handdoekhouder 65cm 0090033 | RVS-borstel | 14705002658 | stuk | 91,50 | 383 | 1 |

| Art.nr | Specificaties | Kleur | Lev.nr | Ehd | Prijs | Grp | CC | |
|---|---------------|-------------------|-------------|------|---------|-----|----|---|
| | | | | | | | | D-Line RVS |
| handdoekhouder draaibaar | | | | | | | | |
| 0091839 | | wit/RVS-borstel | 14705302460 | stuk | 76,00 | 383 | 1 |  |
| 0091847 | | grijs/RVS-borstel | 14705402460 | stuk | 76,00 | 383 | 1 | |
| closetrolhouder | | | | | | | | |
| 0090008 | | wit/RVS-borstel | 14705502140 | stuk | 73,50 | 383 | 1 |  |
| 0091820 | | grijs/RVS-borstel | 14705602141 | stuk | 73,50 | 383 | 1 | |
| closetborstelgarnituur | | | | | | | | |
| 0090005 | m. PVC-steel | RVS-borstel | 14706002007 | stuk | 155,00 | 383 | 1 |  |
| 0090078 | m. RVS-steel | RVS-borstel | 14706102000 | stuk | 166,00 | 383 | 1 | |
| reserverolhouder 16cm | | | | | | | | |
| 0090003 | | RVS-borstel | 14706202016 | stuk | 48,25 | 383 | 1 |  |
| reserverolhouder 30cm | | | | | | | | |
| 0091855 | | RVS-borstel | 9470620010 | stuk | 106,00 | 383 | 1 | |
| tissuedispenser | | | | | | | | |
| 0091863 | | RVS-borstel | 14709102000 | stuk | 296,00 | 383 | 1 |  |
| toiletsteun opklapbaar | | | | | | | | |
| 0090015 | | RVS-borstel | 14750002680 | stuk | 1346,00 | 383 | 1 |  |
| 0091823 | 80x85cm | RVS-borstel | 14750002850 | stuk | 1346,00 | 383 | 1 | |
| closetrolhouder voor toiletsteun | | | | | | | | |
| 0090013 | | RVS-borstel | 14750102001 | stuk | 80,50 | 383 | 1 | |
| jashaak groot | | | | | | | | |
| 0090004 | | RVS-borstel | 14560502002 | stuk | 25,00 | 383 | 1 |  |
| haak 23mm | | | | | | | | |
| 0091758 | | RVS-borstel | 14561002003 | stuk | 17,25 | 383 | 1 |  |

Sanitair producten

Baden /
douchebakken /
stoomcabines

Kranen

Douchegarnituur

Accessoires en
spiegels

Douchewanden

Toebehoren &
afvoeren













Spoel- &
installatiesystemen











Badkamermeubelen
en toiletkasten

Gootstenen en
wastroggen







Utiliteit

| | Art.nr | Specificaties | Kleur | Lev.nr | Ehd | Prijs | Grp | CC |
|---|---|--|-------------|-------------|------|--------|-----|----|
| Sanitair producten | D-Line RVS | | | | | | | |
| | | garderobehaak rond 80mm | | | | | | |
| | 0090007 | | RVS-borstel | 14562502000 | stuk | 116,00 | 383 | 1 |
| Baden / douchebakken / stoomcabines |  | | | | | | | |
| Kranen | | steel los voor closetborstelgarnituur | | | | | | |
| | | 0091821 | PVC | 14706130019 | stuk | 16,25 | 383 | 1 |
| Douchegarnituur | | borsteldeel los | | | | | | |
| | | 0091822 | wit | 14706130035 | stuk | 16,50 | 383 | 1 |
| Accessoires en spiegels | | | | | | | | |
| Douchewanden | | | | | | | | |
| Toebehoren & afvoeren | | | | | | | | |
| Spoel- & installatiesystemen | | | | | | | | |
| Badkamermeubelen en toiletkasten | | | | | | | | |
| Gootstenen en wastroggen | | | | | | | | |
| Utiliteit | | | | | | | | |











| Art.nr | Specificaties | Kleur | Lev.nr | Ehd | Prijs | Grp | CC | | |
|--|---------------|-------|-----------|------|--------|-----|----|---|---|
| | | | | | | | | Emco Amphora | |
| glashouder met glas 0633950 | | chrom | 192000100 | stuk | 89,00 | 232 | 1 |  | Sanitair producten |
| zeepouder met inzet 0633954 | | chrom | 193000100 | stuk | 117,00 | 232 | 1 |  | Baden / douchebakken / stoomcabines |
| zeepdispenser met inzet 0633952 | | chrom | 192100100 | stuk | 184,00 | 232 | 1 |  | Kranen |
| planchet rond met glasplaat 0633946 | | chrom | 191000118 | stuk | 278,00 | 232 | 1 |  | Accessoires en spiegels |
| 2-lids handdoekhouder draaibaar 0633956 | | chrom | 195000148 | stuk | 183,00 | 232 | 1 |  | Douchewanden |
| handdoekring draaibaar 0633958 | | chrom | 195500100 | stuk | 95,50 | 232 | 1 |  | Toebehoren & afvoeren |
| badlakenrek 0633962 60cm | | chrom | 196000160 | stuk | 123,00 | 232 | 1 |  | Badkamermeubelen en toiletkasten |
| 0633960 80cm | | chrom | 196000180 | stuk | 135,00 | 232 | 1 | | |
| badgreep 0633964 30cm | | chrom | 197000130 | stuk | 107,00 | 232 | 1 |  | Gootstenen en wastroggen |
| closetrolhouder met klep 0633942 | | chrom | 190000100 | stuk | 128,00 | 232 | 0 |  | Utiliteit |
| reserverolhouder 0633944 | | chrom | 190500100 | stuk | 73,50 | 232 | 1 |  | |
| closetborstelgarnituur wandmodel 0633948 | | chrom | 191500100 | stuk | 163,00 | 232 | 0 |  | |
| handdoekhaak met 2 haken 0633966 | | chrom | 197500102 | stuk | 87,00 | 232 | 1 |  | |

| | Art.nr | Specificaties | Kleur | Lev.nr | Ehd | Prijs | Grp | CC | |
|---|---|--|-------------------|-----------|-----------|--------|--------|-----|---|
| Sanitair producten | Emco Amphora | | | | | | | | |
| | | wandlamp met glas | | | | | | | |
| | 0633970 | | chrom | 199000100 | stuk | 288,00 | 232 | 1 | |
| Baden / douchebakken / stoomcabines |  | | | | | | | | |
| Kranen | Emco Barolo | | | | | | | | |
| | | 2220 glashouder m. helder drinkglas | | | | | | | |
| | 0630888 | z. sierrozet | chrom | 222000101 | stuk | 105,00 | 232 | 1 | |
| Douchegarnituur |  | | | | | | | | |
| Accessoires en spiegels | | 2230 zeephouder m. helder inzet | | | | | | | |
| | | 0630918 | z. sierrozet | chrom | 223000101 | stuk | 93,50 | 232 | 1 |
| Douchewanden |  | | | | | | | | |
| Douchewanden | | 2234 zeephouder hoekdraadmodel | | | | | | | |
| | | 0630926 | z. sierrozet | chrom | 223400100 | stuk | 102,00 | 232 | 1 |
| |  | | | | | | | | |
| Toebehoren & afvoeren | | 2221 zeepdispenser | | | | | | | |
| | | 0630934 | z. sierrozet | chrom | 222100101 | stuk | 106,00 | 232 | 1 |
| |  | | | | | | | | |
| Spool- & installatiesystemen | | glasdeel opaal v. zeepdispenser | | | | | | | |
| | | 0630052 | | 222100090 | stuk | 40,75 | 232 | 1 | |
| Badkamermeubelen en toiletkasten | | 2210 planchet kristalglas | | | | | | | |
| | 0630713 | 50cm z. sierrozet | chrom | 221000150 | stuk | 148,00 | 232 | 1 | |
| | 0630705 | 70cm z. sierrozet | chrom | 221000170 | stuk | 166,00 | 232 | 1 | |
| |  | | | | | | | | |
| Gootstenen en wastroggen | | 2250 2-lids handdoekhouder | | | | | | | |
| | | 0630802 | 31cm z. sierrozet | chrom | 225000131 | stuk | 93,00 | 232 | 1 |
| | | 0630799 | 41cm z. sierrozet | chrom | 225000141 | stuk | 97,00 | 232 | 1 |
| |  | | | | | | | | |
| Utiliteit | | 2255 handdoekring | | | | | | | |
| | | 0630780 | z. sierrozet | chrom | 225500100 | stuk | 73,00 | 232 | 1 |
| |  | | | | | | | | |
| | | 2261 handdoekhouder 60cm dubbel | | | | | | | |
| | | 0630756 | z. sierrozet | chrom | 226100160 | stuk | 105,00 | 232 | 1 |
| |  | | | | | | | | |
| | | 2260 handdoekhouder | | | | | | | |
| | | 0630024 | 60cm z. sierrozet | chrom | 226000160 | stuk | 116,00 | 232 | 1 |
| | 0630764 | 80cm z. sierrozet | chrom | 226000180 | stuk | 126,00 | 232 | 1 | |
| |  | | | | | | | | |
| | | 2270 badgreep 30cm | | | | | | | |
| | | 0630853 | z. sierrozet | chrom | 227000125 | stuk | 97,00 | 232 | 1 |
| |  | | | | | | | | |

| Art.nr | Specificaties | Kleur | Lev.nr | Ehd | Prijs | Grp | CC | | |
|---|---------------|--------|-----------|------|--------|-----|----|---|---|
| | | | | | | | | Emco Barolo | |
| 2200 closetrolhouder z. klep 0630837 | z. sierrozet | chroom | 220000100 | stuk | 98,00 | 232 | 1 |  | Sanitair producten |
| 2200 closetrolhouder m. klep 0630829 | z. sierrozet | chroom | 220000101 | stuk | 118,00 | 232 | 1 |  | Baden / douchebakken / stoomcabines |
| 2205 reserverolhouder 0630810 | z. sierrozet | chroom | 220500100 | stuk | 45,00 | 232 | 1 |  | Kranen |
| 2215 closetborstelgarnituur 0630845 | z. sierrozet | chroom | 221500100 | stuk | 138,00 | 232 | 1 |  | Douchegarnituur |
| borstelkop m. zijborstels v. closetborstelgarnituur 0630707 | | | 221513990 | stuk | 9,10 | 232 | 0 | | Accessoires en spiegels |
| 2265 gastendoekkorf 0630772 | z. sierrozet | chroom | 226500100 | stuk | 229,00 | 232 | 1 |  | Douchewanden |
| 2275 garderobehaak 0630969 | z. sierrozet | chroom | 227500102 | stuk | 48,00 | 232 | 1 |  | Toebehoren & afvoeren |
| 2266 hoeketagere m. glasplaat 0630846 | | chroom | 226600102 | stuk | 352,00 | 232 | 1 |  | Spoel- & installatiesystemen |
| 2266 etagere z. kap z. sierring 0630848 | | chroom | 226600100 | stuk | 280,00 | 232 | 1 |  | Badkamermeubelen en toiletkasten |
| 2240 sierrozet 0633461 | Classico | chroom | 224000103 | stuk | 15,75 | 232 | 1 | | Gootstenen en wastroggen |
| | | | | | | | | | Utiliteit |

| | Art.nr | Specificaties | Kleur | Lev.nr | Ehd | Prijs | Grp | CC |
|---|---|---|-------------|-----------|------|--------|-----|----|
| Emco Barolo | | | | | | | | |
| 2243 sierrozet | | | | | | | | |
| Sanitair producten | 0630994 | F-Grohe Europlus | chrom/goud | 224320701 | stuk | 62,00 | 232 | 1 |
| | 0630019 | F-Grohe Sentosa | chr/matchr | 224321434 | stuk | 43,00 | 232 | 1 |
| | 0630069 | F-Grohe Chiara | chrom/goud | 224320730 | stuk | 26,75 | 232 | 1 |
| | 0630100 | F-Grohe Chiara | chr/matchr | 224321430 | stuk | 22,50 | 232 | 1 |
| Baden / douchebakken / stoomcabines | 0630400 | F-Grohe Taron | matchr/chr | 224301037 | stuk | 19,25 | 232 | 1 |
| | 0632775 | F-Grohe Taron | chrom | 224300137 | stuk | 19,25 | 232 | 1 |
| | 0632046 | HansGrohe Mondaro | chrom/goud | 224320736 | stuk | 48,50 | 232 | 1 |
| Emco Classic | | | | | | | | |
| Kranen |  | zeepdispenser m. pomp m. rozet z. kap 0630224 | chrom | 292100121 | stuk | 158,00 | 232 | 1 |
| Douchegarnituur | | | | | | | | |
| |  | 2990 wandlamp m. satijnglas 0630678 | edelmessing | 299000601 | stuk | 333,00 | 232 | 1 |
| Accessoires en spiegels | | | | | | | | |
| Douchewanden |  | closetrolhouder m. klep z. kap m. rozet 0630215 | chrom | 290000102 | stuk | 109,00 | 232 | 1 |
| Toebehoren & afvoeren | | | | | | | | |
| Spoel- & installatiesystemen |  | closetborstelgarnituur z. kap m. rozet 0630220 | chrom | 291500101 | stuk | 171,00 | 232 | 1 |
| Badkamermeubelen en toiletkasten | | | | | | | | |
| Gootstenen en wastroggen |  | 2-lids handdoekhouder draaibaar z. kap m. rozet 0630226 | chrom | 295000143 | stuk | 151,00 | 232 | 1 |
| Utiliteit |  | handdoekring z. kap m. rozet 0630227 | chrom | 295500101 | stuk | 87,50 | 232 | 1 |
| |  | badlakenrek 80cm m. rozet z. kap 0630228 | chrom | 296000181 | stuk | 140,00 | 232 | 1 |

| Art.nr | Specificaties | Kleur | Lev.nr | Ehd | Prijs | Grp | CC | | |
|--|---------------|--------|-----------|------|-------|-----|----|---|---|
| | | | | | | | | Emco Classic | |
| handdoekhaak klein m. rozet 0630231 | | chroom | 297500100 | stuk | 20,25 | 232 | 1 |  | Sanitair producten |
| handdoekhaak groot m. rozet 0630232 | | chroom | 297500101 | stuk | 36,50 | 232 | 1 | | Baden / douchebakken / stoomcabines |
| | | | | | | | | Emco Contour | |
| 2820 glashouder enkel m. kristalglas 0630314 | | chroom | 282000100 | stuk | 47,00 | 232 | 0 |  | Kranen |
| 2830 zeephouder m. kristal inzet 0630322 | | chroom | 283000100 | stuk | 58,00 | 232 | 0 |  | Douchegarnituur |
| 5745 zeephouder draadmodel 0630675 | | chroom | 574500101 | stuk | 28,25 | 232 | 1 |  | Accessoires en spiegels |
| 2821 zeepdispenser wandmodel 0630306 | | chroom | 282100102 | stuk | 61,00 | 232 | 1 |  | Douchewanden |
| 0630309 | m. opaalglas | chroom | 282100101 | stuk | 77,00 | 232 | 1 | | Toebehoren & afvoeren |
| 5745 sponskorf draadmodel 0634247 | | chroom | 574500104 | stuk | 52,50 | 232 | 0 |  | Spoel- & installatiesystemen |
| 5745 hoeksponskorf draadmodel 0634255 | | chroom | 574500105 | stuk | 53,50 | 232 | 0 |  | Badkamermeubelen en toiletkasten |
| 2810 planchet kristalglas 0630284 50x12cm | | chroom | 281000150 | stuk | 85,00 | 232 | 1 |  | Gootstenen en wastroggen |
| 0630276 70x12cm | | chroom | 281000170 | stuk | 95,50 | 232 | 1 | | Utiliteit |
| planchethouders 2810 per paar 0980637 | | chroom | 281000190 | stuk | 43,25 | 232 | 1 | | |
| 2850 2-lids handdoekhouder draaibaar 0630357 | | chroom | 285000143 | stuk | 66,50 | 232 | 0 |  | |
| 2855 handdoekkring 0630365 | | chroom | 285500100 | stuk | 49,50 | 232 | 1 |  | |
| 2860 handdoekhouder 60cm 0630373 | | chroom | 286000160 | stuk | 83,00 | 232 | 1 |  | |

| | Art.nr | Specificaties | Kleur | Lev.nr | Ehd | Prijs | Grp | CC |
|---|---|---|--------------|-----------|------|--------|-----|----|
| | Emco Contour | | | | | | | |
| Sanitair producten | | 2860 handdoekhouder 80cm 0630381 | chroom | 286000180 | stuk | 95,50 | 232 | 1 |
| Baden / douchebakken / stoomcabines |  | 2870 badgreep 25cm 0630403 | chroom | 287000125 | stuk | 56,50 | 232 | 1 |
| Kranen |  | 5772 badgreep m. zeepschaal 0630305 | chroom/acryl | 577200138 | stuk | 118,00 | 232 | 1 |
| Douchegarnituur |  | 5745 sponshouder draadmodel 0630683 | chroom | 574500103 | stuk | 39,75 | 232 | 1 |
| Accessoires en spiegels |  | 2800 closetrolhouder z. klep 0630241 | chroom | 280000101 | stuk | 41,75 | 232 | 1 |
| Douchewanden |  | 2800 closetrolhouder m. klep 0630233 | chroom | 280000102 | stuk | 63,50 | 232 | 0 |
| Toebehoren & afvoeren |  | 2805 reserverolhouder 0630268 | chroom | 280500100 | stuk | 26,75 | 232 | 0 |
| Badkamermeubelen en toiletkasten |  | 2815 closetborstelgarnituur wandmodel 0630292 | chroom | 281500101 | stuk | 111,00 | 232 | 0 |
| Gootstenen en wastroggen |  | 2874 handdoekhaak 2-delig 0630411 | chroom | 287400102 | stuk | 31,50 | 232 | 1 |
| Utiliteit |  | 2874 handdoekhaak 4-delig 0630438 | chroom | 287400104 | stuk | 51,00 | 232 | 1 |
| |  | 2875 handdoekhaak klein 0630446 | chroom | 287500100 | stuk | 9,40 | 232 | 0 |
| |  | 2875 handdoekhaak groot 0630454 | chroom | 287500101 | stuk | 12,25 | 232 | 0 |

| Art.nr | Specificaties | Kleur | Lev.nr | Ehd | Prijs | Grp | CC | |
|--|---------------|-------|-----------|------|--------|-----|----|---|
| Emco Contour | | | | | | | | |
| toiletset compleet | | | | | | | | |
| 0630166 | | chrom | 289800101 | stuk | 154,00 | 232 | 1 | |
| wandlamp m. opaalglas | | | | | | | | |
| 0691268 | | | 289200000 | stuk | 107,00 | 232 | 1 |  |
| Emco Dogma | | | | | | | | |
| glashouder m. kristalglas | | | | | | | | |
| 0630034 | | chrom | 342000100 | stuk | 48,50 | 232 | 0 |  |
| zeephouder kristalglas | | | | | | | | |
| 0630036 | | | 343000100 | stuk | 59,50 | 232 | 0 |  |
| glasdeel voor zeepschaal | | | | | | | | |
| 0630075 | | | 343000090 | stuk | 30,00 | 232 | 1 | |
| zeepdispenser m. kristalglas | | | | | | | | |
| 0630035 | | chrom | 342100101 | stuk | 79,50 | 232 | 0 |  |
| glasdeel voor zeepdispenser | | | | | | | | |
| 0630062 | | | 122100090 | stuk | 36,00 | 232 | 0 | |
| kunststof doseerpomp voor zeepdispenser | | | | | | | | |
| 0630074 | | chrom | 222100191 | stuk | 11,25 | 232 | 0 | |
| planchet kristalglas | | | | | | | | |
| 0630003 | 45cm | chrom | 341000145 | stuk | 132,00 | 232 | 1 |  |
| 0630032 | 60cm | chrom | 341000160 | stuk | 138,00 | 232 | 1 | |
| glasdeel voor planchet | | | | | | | | |
| 0630054 | 45cm | | 341000090 | stuk | 82,50 | 232 | 1 | |
| 0630056 | 60cm | | 341000091 | stuk | 98,50 | 232 | 1 | |
| handdoekhouder 2-delig | | | | | | | | |
| 0630219 | 34cm | chrom | 345000134 | stuk | 68,00 | 232 | 0 |  |
| 0630218 | 44cm | chrom | 345000144 | stuk | 86,00 | 232 | 0 | |
| handdoekring vast | | | | | | | | |
| 0630040 | | chrom | 345500100 | stuk | 50,00 | 232 | 0 |  |
| handdoekhouder | | | | | | | | |
| 0630042 | 60cm | chrom | 346000160 | stuk | 85,00 | 232 | 1 |  |
| 0630044 | 80cm | chrom | 346000180 | stuk | 93,00 | 232 | 1 | |

Sanitair producten

Baden /
douchebakken /
stoomcabines

Kranen

Douchegarnituur

Accessoires en
spiegels

Douchewanden







Toebehoren &
afvoeren









Spoel- &
installatiesystemen









Badkamermeubelen
en toiletkasten









Gootstenen en
wastroggen







Utiliteit









| | Art.nr | Specificaties | Kleur | Lev.nr | Ehd | Prijs | Grp | CC |
|---|---|--|--|------------|-----------|--------|-------|-----|
| Sanitair producten | Emco Dogma | | | | | | | |
| |  | badgreep 30cm 0630045 | chrom | 347000130 | stuk | 59,50 | 232 | 0 |
| Baden / douchebakken / stoomcabines |  | closetrolhouder m. klep 0630001 | chrom | 340000100 | stuk | 65,00 | 232 | 0 |
| | | closetrolhouder z. klep 0630279 | chrom | 340500100 | stuk | 42,00 | 232 | 1 |
| Kranen |  | reserverolhouder 0630002 | chrom | 340500101 | stuk | 26,25 | 232 | 0 |
| Douchegarnituur | | wandlamp helderglas 0630048 | matchroom | 109000122 | stuk | 341,00 | 232 | 1 |
| Accessoires en spiegels |  | 0630051 | matnikkel | 109001405 | stuk | 341,00 | 232 | 1 |
| | | Douchewanden | borstelgarnituur wandmodel 0630033 | opaal/chr. | 341500100 | stuk | 93,00 | 232 |
| Toebehoren & afvoeren |  | glasdeel voor borstelgarnituur 0630057 | | 121500090 | stuk | 50,00 | 232 | 0 |
| Spoel- & installatiesystemen | | haak dubbel 0630046 | chrom | 347500102 | stuk | 33,50 | 232 | 0 |
| Badkamermeubelen en toiletkasten |  | toiletset compleet 0630167 | chrom | 349800100 | stuk | 167,00 | 232 | 1 |
| | | Gootstenen en wastroggen | Emco Emotion | | | | | |
| Utiliteit |  | | 0920 glashouder m. glas 0632848 | chrom | 092000100 | stuk | 90,50 | 232 |
| | | glas voor S0920 0633399 | | 092000090 | stuk | 35,50 | 232 | 1 |



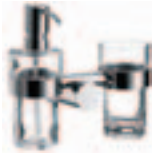

| Art.nr | Specificaties | Kleur | Lev.nr | Ehd | Prijs | Grp | CC | | |
|---|----------------|-------|-----------|------|--------|-----|----|---|---|
| | | | | | | | | Emco Emotion | |
| 0930 zeephouder 0632864 | z. rozet | chrom | 093000100 | stuk | 101,00 | 232 | 1 |  | Sanitair producten |
| beker opaalglas voor S0924 0633402 | | | 092100093 | stuk | 49,00 | 232 | 1 |  | Baden / douchebakken / stoomcabines |
| zeepdispenser m. helder glas z. rozet 0630158 | | chrom | 092100120 | stuk | 167,00 | 232 | 1 |  | Kranen |
| doseerpomp voor S0924 0633410 | | chrom | 222100190 | stuk | 59,50 | 232 | 0 |  | Douchegarnituur |
| 0910 planchet 45cm 0632813 | z. rozet | chrom | 091000145 | stuk | 197,00 | 232 | 1 |  | Accessoires en spiegels |
| planchet voor S0912 0633364 | | | 091000090 | stuk | 93,00 | 232 | 1 | | Douchewanden |
| 0910 planchet 65cm 0632805 | z. rozet | | 091000165 | stuk | 220,00 | 232 | 1 |  | Toebehoren & afvoeren |
| planchet voor S0910 0633356 | | | 091000091 | stuk | 113,00 | 232 | 1 | | Spoel- & installatiesystemen |
| 0990 lamp 0633003 | z. rozet | chrom | 099000100 | stuk | 351,00 | 232 | 1 |  | Badkamermeubelen en toiletkasten |
| glasdeel voor S0990 0633011 | buiten | | 099000090 | stuk | 57,50 | 232 | 1 | | Gootstenen en wastroggen |
| 0633038 | binnen | | 099000091 | stuk | 54,50 | 232 | 1 | | Utiliteit |
| 0950 2-lids handdoekhouder 0632880 | 365mm z. rozet | chrom | 095000136 | stuk | 134,00 | 232 | 1 |  | |
| 0632872 | 465mm z. rozet | chrom | 095000146 | stuk | 136,00 | 232 | 1 | | |
| 0955 handdoekring 0632899 | z. rozet | chrom | 095500100 | stuk | 83,00 | 232 | 1 |  | |









| | Art.nr | Specificaties | Kleur | Lev.nr | Ehd | Prijs | Grp | CC |
|---|---|---|-------|-----------|------|--------|-----|----|
| | Emco Emotion | | | | | | | |
| Sanitair producten |  | 0960 handdoekhouder 60cm 0632902 z. rozet | chrom | 096000160 | stuk | 111,00 | 232 | 1 |
| Baden / douchebakken / stoomcabines |  | 0970 badgreep 27cm 0632929 z. rozet | chrom | 097000130 | stuk | 93,00 | 232 | 1 |
| Kranen |  | 0900 closetrolhouder z. klep 0632791 | chrom | 090000101 | stuk | 51,00 | 232 | 1 |
| Douchegarnituur |  | 0900 closetrolhouder m. klep 0632783 | chrom | 090000100 | stuk | 98,50 | 232 | 1 |
| Accessoires en spiegels | | | | | | | | |
| Douchewanden |  | 0915 closetborstelgarnituur 0632821 | chrom | 091500100 | stuk | 188,00 | 232 | 1 |
| Toebehoren & afvoeren | | | | | | | | |
| Spoel- & installatiesystemen |  | 0975 haak z. rozet 0632937 | chrom | 097500100 | stuk | 15,75 | 232 | 1 |
| Badkamermeubelen en toiletkasten |  | 0965 handdoekkorf z. rozet 0632910 | chrom | 096500100 | stuk | 228,00 | 232 | 1 |
| Gootstenen en wastroggen | | | | | | | | |
| Utiliteit |  | 2295 spiegel m. decorrand 82cm 0633046 | | 229509900 | stuk | 309,00 | 232 | 1 |
| | Emco Eposa | | | | | | | |
| |  | glashouder m. kristalglas 0630189 | chrom | 082000100 | stuk | 100,00 | 232 | 0 |
| | | drinkglas helder kristal 0630190 | | 082000090 | stuk | 35,50 | 232 | 1 |
| | | zeephouder m. inzet kristalglas 0630194 | chrom | 083000100 | stuk | 106,00 | 232 | 0 |
| | | 0630196 | | 083000090 | stuk | 35,50 | 232 | 1 |











| Art.nr | Specificaties | Kleur | Lev.nr | Ehd | Prijs | Grp | CC | | |
|--|---------------|--------|-----------|------|--------|-----|----|---|---|
| | | | | | | | | Emco Eposa | |
| zeepdispenser helder glas m. pomp=metaal 0630153 | | | 082100093 | stuk | 46,75 | 232 | 1 |  | Sanitair producten |
| zeepdispenser opaal m. pomp=metaal 0630191 | | | 082100100 | stuk | 158,00 | 232 | 0 | | Baden / douchebakken / stoomcabines |
| 0894 klemlamp 0633291 | | chroom | 089400100 | stuk | 105,00 | 232 | 0 |  | Kranen |
| lamp voor 0894 0633305 | | | 089400090 | stuk | 18,00 | 232 | 1 | | Douchegarnituur |
| 0894 wandlamp 0633313 | | chroom | 089400101 | stuk | 82,50 | 232 | 0 |  | Accessoires en spiegels |
| handdoekrek 2-delig 0630198 36.3cm | | chroom | 085000136 | stuk | 141,00 | 232 | 1 |  | Douchewanden |
| 0630197 46.5cm | | chroom | 085000146 | stuk | 145,00 | 232 | 1 | | |
| handdoekring 0630199 | | chroom | 085500100 | stuk | 83,00 | 232 | 1 |  | Toebehoren & afvoeren |
| badlakenrek 60cm 0630201 | | chroom | 086000160 | stuk | 111,00 | 232 | 1 |  | Spoel- & installatiesystemen |
| handdoekkorf 0630203 | | chroom | 086500100 | stuk | 228,00 | 232 | 1 |  | Badkamermeubelen en toiletkasten |
| droogrek uitklapbaar 0630214 60x9x6cm | | | 086100160 | stuk | 270,00 | 232 | 1 |  | Gootstenen en wastroggen |
| | | | | | | | | | Utiliteit |



| | Art.nr | Specificaties | Kleur | Lev.nr | Ehd | Prijs | Grp | CC |
|---|---|-----------------------------------|--------|-----------|------|--------|-----|----|
| Sanitair producten | Emco Eposa | | | | | | | |
| | | badgreep 0630205 26.3cm | chroom | 087000125 | stuk | 93,00 | 232 | 0 |
| Baden / douchebakken / stoomcabines |  | | | | | | | |
| Kranen | closetrolhouder z. klep | | | | | | | |
| | | 0630180 | chroom | 080000102 | stuk | 57,00 | 232 | 0 |
| Douchegarnituur |  | | | | | | | |
| Accessoires en spiegels | closetrolhouder m. klep | | | | | | | |
| | | 0630159 | chroom | 080000100 | stuk | 98,50 | 232 | 0 |
| Douchewanden |  | | | | | | | |
| Toebehoren & afvoeren | reserverolhouder | | | | | | | |
| | | 0630213 | chroom | 080500100 | stuk | 61,00 | 232 | 0 |
| Toebehoren & afvoeren |  | | | | | | | |
| Spoel- & installatiesystemen | planchet kristalglas | | | | | | | |
| | | 0630182 50x12cm | chroom | 081000150 | stuk | 197,00 | 232 | 1 |
| | | 0630181 70x12cm | chroom | 081000170 | stuk | 220,00 | 232 | 1 |
| Badkamermeubelen en toiletkasten |  | | | | | | | |
| Gootstenen en wastroggen | glasplaat los voor planchet | | | | | | | |
| | | 0630183 50x12cm | | 081000090 | stuk | 79,00 | 232 | 1 |
| | | 0630184 70x12cm | | 081000092 | stuk | 97,00 | 232 | 1 |
| Utiliteit | closetborstelgarnituur opaalglas | | | | | | | |
| | | 0630185 | chroom | 081500100 | stuk | 188,00 | 232 | 0 |
| |  | | | | | | | |
| glasdeel opaal voor closetborstelgarnituur | | | | | | | | |
| | 0630186 | | | 081500090 | stuk | 29,50 | 232 | 0 |
| Utiliteit | handdoekhaak | | | | | | | |
| | | 0630207 | chroom | 087500100 | stuk | 14,00 | 232 | 0 |
| Utiliteit |  | | | | | | | |
| toiletset compleet | | | | | | | | |
| | 0630172 | | chroom | 089800100 | stuk | 291,00 | 232 | 1 |

| Art.nr | Specificaties | Kleur | Lev.nr | Ehd | Prijs | Grp | CC | | |
|--|---------------|--------|-----------|------|--------|-----|----|---|---|
| | | | | | | | | Emco Eposa | |
| wandlamp m. opaal glas 0630210 | | chroom | 089000100 | stuk | 256,00 | 232 | 1 |  | Sanitair producten |
| opaalglas los voor wandlamp 0630211 | | | 089000090 | stuk | 53,50 | 232 | 1 | | Baden / douchebakken / stoomcabines |
| lampje los voor wandlamp 0630212 | | | 089000091 | stuk | 20,75 | 232 | 1 | | Kranen |
| | | | | | | | | Emco Inspira | |
| 1520 glashouder m. glas 0633755 | | chroom | 152000100 | stuk | 102,00 | 232 | 1 |  | Douchegarnituur |
| 1525 glashouder dubbel m. glazen 0633798 | | chroom | 152500100 | stuk | 156,00 | 232 | 1 |  | Douchewanden |
| 1531 glashouder m. zeepdispenser m. glas 0633828 | | chroom | 153100101 | stuk | 237,00 | 232 | 1 |  | Toebehoren & afvoeren |
| 1530 zeephouder m. glazen inzet 0633771 | | chroom | 153000100 | stuk | 120,00 | 232 | 1 |  | Spoel- & installatiesystemen |
| 1531 zeephouder + glashouder m. glas 0633801 | | chroom | 153100100 | stuk | 175,00 | 232 | 1 |  | Badkamermeubelen en toiletkasten |
| 1531 zeepdispenser + cosmeticabox 0633836 | | chroom | 153100102 | stuk | 323,00 | 232 | 1 |  | Gootstenen en wastroggen |
| 1521 zeepdispenser m. helderglas 0633763 | | chroom | 152100100 | stuk | 182,00 | 232 | 1 |  | Utiliteit |
| 1550 2-lids handdoekhouder draaibaar 0633852 | | chroom | 155000145 | stuk | 164,00 | 232 | 1 |  | |

| | Art.nr | Specificaties | Kleur | Lev.nr | Ehd | Prijs | Grp | CC |
|---|---|---|-------|-----------|------|--------|-----|----|
| | Emco Inspira | | | | | | | |
| Sanitair producten |  | 1555 handdoekring 0633860 | chrom | 155500100 | stuk | 107,00 | 232 | 1 |
| Baden / douchebakken / stoomcabines |  | 1560 handdoekhouder 60cm 0633895 | chrom | 156000160 | stuk | 115,00 | 232 | 1 |
| Kranen |  | 1560 handdoekhouder 80cm 0633887 | chrom | 156000180 | stuk | 125,00 | 232 | 1 |
| Douchegarnituur |  | 1556 handdoekstang + zeepdispenser 0633879 | chrom | 155600101 | stuk | 188,00 | 232 | 1 |
| Accessoires en spiegels |  | 1570 badgreep 0633909 | chrom | 157000125 | stuk | 97,50 | 232 | 1 |
| Douchewanden |  | 1500 closetrolhouder z. klep 0633690 | chrom | 150000100 | stuk | 83,00 | 232 | 0 |
| Toebehoren & afvoeren |  | 1500 closetrolhouder z. klep m. cosmeticabox 0633704 | chrom | 150000101 | stuk | 229,00 | 232 | 1 |
| Spoel- & installatiesystemen |  | 1505 reserverolhouder 0633712 | chrom | 150500100 | stuk | 56,00 | 232 | 1 |
| Badkamermeubelen en toiletkasten |  | 1515 closetborstelgarnituur wandmodel 0633739 | chrom | 151500100 | stuk | 136,00 | 232 | 0 |
| Gootstenen en wastroggen |  | 1515 closetborstelgarnituur m. reserverolhouder 0633747 | chrom | 151500101 | stuk | 139,00 | 232 | 0 |
| Utiliteit |  | 1510 planchet rond m. glasplaat 0633720 | chrom | 151000120 | stuk | 260,00 | 232 | 1 |
| |  | 1539 cosmeticabox m. kristalglas 0633844 | chrom | 153900100 | stuk | 195,00 | 232 | 1 |

| Art.nr | Specificaties | Kleur | Lev.nr | Ehd | Prijs | Grp | CC | | |
|---|---------------|--------|-----------|------|--------|-----|----|---|---|
| | | | | | | | | Emco Inspira | |
| 1575 handdoekhaak m. 2 haken 0633917 | | chroom | 157500102 | stuk | 88,00 | 232 | 1 |  | Sanitair producten |
| 1590 wandlamp m. kristalglas 0633925 | | chroom | 159000100 | stuk | 231,00 | 232 | 1 |  | Baden / douchebakken / stoomcabines |
| 1590 wandlamp dubbel m. kristalglas 0633933 | | chroom | 159000101 | stuk | 369,00 | 232 | 1 |  | Kranen |
| toiletset compleet 0630169 | | chroom | 159800100 | stuk | 226,00 | 232 | 1 | | Douchegarnituur |
| | | | | | | | | Emco Kido | |
| glashouder m. kristalglas 0630137 | | chroom | 312000100 | stuk | 99,50 | 232 | 1 |  | Accessoires en spiegels |
| zeephouder m. kristalglas 0630150 | | chroom | 313000100 | stuk | 83,00 | 232 | 1 |  | Douchewanden |
| zeepdispenser m. kristalglas 0630138 | | chroom | 312100100 | stuk | 127,00 | 232 | 1 |  | Toebehoren & afvoeren |
| planchet rond 18cm m. kristalglas 0630151 | | chroom | 311000118 | stuk | 214,00 | 232 | 1 |  | Spoel- & installatiesystemen |
| dubbele haak 0630146 | | chroom | 317500102 | stuk | 60,50 | 232 | 1 |  | Badkamermeubelen en toiletkasten |
| handdoekring 0630139 | | chroom | 315500100 | stuk | 66,50 | 232 | 1 |  | Gootstenen en wastroggen |
| | | | | | | | | | Utiliteit |

| | Art.nr | Specificaties | Kleur | Lev.nr | Ehd | Prijs | Grp | CC |
|---|---|---|--------|-----------|------|--------|-----|----|
| | Emco Kido | | | | | | | |
| Sanitair producten | | handdoekhouder enkel 0630140 | chroom | 315000145 | stuk | 69,00 | 232 | 1 |
| |  | | | | | | | |
| Baden / douchebakken / stoomcabines | | handdoekhouder dubbel 0630141 | chroom | 315000148 | stuk | 141,00 | 232 | 1 |
| |  | | | | | | | |
| Kranen | | handdoekhouder 0630142 80cm | chroom | 316000180 | stuk | 146,00 | 232 | 1 |
| |  | | | | | | | |
| Douchegarnituur | | 0630143 60cm | chroom | 316000160 | stuk | 124,00 | 232 | 1 |
| |  | | | | | | | |
| Accessoires en spiegels | | badgreep 30cm 0630145 | chroom | 317000130 | stuk | 121,00 | 232 | 1 |
| |  | | | | | | | |
| Douchewanden | | reserverolhouder 0630149 | chroom | 310500100 | stuk | 56,50 | 232 | 1 |
| |  | | | | | | | |
| Toebehoren & afvoeren | | closetrolhouder z. klep m. beugel 0630148 | chroom | 310000100 | stuk | 83,50 | 232 | 1 |
| |  | | | | | | | |
| Spoel- & installatiesystemen | | closetborstelgarnituur 0630147 | chroom | 311500100 | stuk | 131,00 | 232 | 1 |
| |  | | | | | | | |
| Badkamermeubelen en toiletkasten | | Emco Liaison | | | | | | |
| |  | glashouder met glas 0633986 | chroom | 172000100 | stuk | 86,50 | 232 | 0 |
| |  | | | | | | | |
| Gootstenen en wastroggen | | glashouder Galerie met glas 0633988 | chroom | 172000110 | stuk | 86,50 | 232 | 0 |
| |  | | | | | | | |
| Utiliteit | | | | | | | | |

| Art.nr | Specificaties | Kleur | Lev.nr | Ehd | Prijs | Grp | CC | | |
|--|---------------|-------|-----------|------|--------|-----|----|---|---|
| | | | | | | | | Emco Liaison | |
| zeepdispenser met inzet 0633990 | | chrom | 172100100 | stuk | 149,00 | 232 | 0 |  | Sanitair producten |
| zeepdispenser Galerie met inzet 0633994 | | chrom | 172100110 | stuk | 149,00 | 232 | 1 |  | Baden / douchebakken / stoomcabines |
| zeephouder met inzet 0633996 | | chrom | 173000100 | stuk | 86,50 | 232 | 0 |  | Kranen |
| zeephouder Galerie met inzet 0633998 | | chrom | 173000110 | stuk | 86,50 | 232 | 1 |  | Douchegarnituur |
| planchet met glasplaat 0633978 24cm | | chrom | 171000100 | stuk | 339,00 | 232 | 1 |  | Accessoires en spiegels |
| planchet Galerie met glasplaat 0633980 24cm | | chrom | 171000110 | stuk | 339,00 | 232 | 1 |  | Douchewanden |
| badgreep 0633880 30cm | | chrom | 177000130 | stuk | 125,00 | 232 | 1 |  | Toebehoren & afvoeren |
| badlakenrek 0633885 60cm 0633889 80cm | | chrom | 176000160 | stuk | 161,00 | 232 | 1 |  | Spoel- & installatiesystemen |
| | | chrom | 176000180 | stuk | 176,00 | 232 | 1 | | |
| 2-lids handdoekhouder draaibaar 0633893 28cm 0633891 43cm | | chrom | 175000128 | stuk | 117,00 | 232 | 1 |  | Gootstenen en wastroggen |
| | | chrom | 175000143 | stuk | 134,00 | 232 | 0 | | |
| handdoekring 0633890 | | chrom | 175500100 | stuk | 119,00 | 232 | 1 |  | |
| droogrek Galerie 0633883 97,6cm 0633881 120,7cm | | chrom | 176100143 | stuk | 209,00 | 232 | 1 |  | |
| | | chrom | 176100166 | stuk | 239,00 | 232 | 1 | | |
| closetrolhouder met klep 0633972 | | chrom | 170000100 | stuk | 148,00 | 232 | 0 |  | |

| | Art.nr | Specificaties | Kleur | Lev.nr | Ehd | Prijs | Grp | CC | |
|---|---|---------------|------------|------------|-----------|--------|---------|-----|---|
| Sanitair producten | Emco Liaison | | | | | | | | |
| | reserverolhouder | | | | | | | | |
| | 0633974 | | chrom | 170500100 | stuk | 78,50 | 232 | 0 | |
| Baden / douchebakken / stoomcabines | closetborstelgarnituur wandmodel | | | | | | | | |
| | 0633982 | | chrom | 171500100 | stuk | 134,00 | 232 | 0 | |
| Kranen | | | | | | | | | |
| Douchegarnituur | handdoekhaak met 2 haken | | | | | | | | |
| | 0633878 | | chrom | 177400102 | stuk | 92,00 | 232 | 0 | |
| Accessoires en spiegels | wandlamp | | | | | | | | |
| | 0633876 | 1009mm | chrom | 179000100 | stuk | 673,00 | 232 | 1 | |
| | 0633874 | 678mm | chrom | 179000101 | stuk | 518,00 | 232 | 1 | |
| Douchewanden | | | | | | | | | |
| Toebehoren & afvoeren | toiletset compleet | | | | | | | | |
| | 0630171 | | chrom | 179800100 | stuk | 287,00 | 232 | 1 | |
| Spoel- & installatiesystemen | wandhouder | | | | | | | | |
| | 0633999 | 36.6cm | m. glasset | chrom | 176600137 | stuk | 323,00 | 232 | 1 |
| | 0634000 | 36.6cm | m. glasset | platin mat | 176601537 | stuk | 700,00 | 232 | 1 |
| | 0634001 | 46.6cm | m. glasset | chrom | 176600147 | stuk | 388,00 | 232 | 1 |
| | 0634002 | 46.6cm | m. glasset | platin mat | 176601547 | stuk | 814,00 | 232 | 1 |
| | 0634003 | 67.8cm | m. glasset | chrom | 176600168 | stuk | 428,00 | 232 | 1 |
| | 0634004 | 67.8cm | m. glasset | platin mat | 176601568 | stuk | 943,00 | 232 | 1 |
| | 0634005 | 101cm | m. glasset | chrom | 176600110 | stuk | 615,00 | 232 | 1 |
| Badkamermeubelen en toiletkasten | 0634006 | 101cm | m. glasset | platin mat | 176601510 | stuk | 1308,00 | 232 | 1 |
| | | | | | | | | | |
| Gootstenen en wastroggen | | | | | | | | | |
| Utiliteit | | | | | | | | | |

Art.nr Specificaties Kleur Lev.nr Ehd Prijs Grp CC

Emco Liaison

glasschaaltje

| | | | | | | | |
|---------|------------|--|-----------|------|--------|-----|---|
| 0634007 | vierkant | | 176600090 | stuk | 42,75 | 232 | 1 |
| 0634008 | langwerpig | | 176600091 | stuk | 109,00 | 232 | 1 |
| 0634009 | diep | | 176600092 | stuk | 45,50 | 232 | 1 |



Sanitair producten

Baden /
douchebakken /
stoomcabines

Kranen

Douchegarnituur

Accessoires en
spiegels

Emco Linea Arte

glashouder m. kristal inzet

| | | | | | | | |
|---------|--------|--------|-----------|------|-------|-----|---|
| 0630499 | z. kap | chroom | 472000101 | stuk | 98,50 | 232 | 1 |
|---------|--------|--------|-----------|------|-------|-----|---|



Douchewanden

Toebehoren &
afvoeren

zeephouder m. kristal inzet

| | | | | | | | |
|---------|--------|--------|-----------|------|--------|-----|---|
| 0632201 | z. kap | chroom | 473000101 | stuk | 113,00 | 232 | 1 |
|---------|--------|--------|-----------|------|--------|-----|---|



Spoel- &
installatiesystemen

closetrolhouder m. klep

| | | | | | | | |
|---------|--------|--------|-----------|------|--------|-----|---|
| 0630461 | z. kap | chroom | 470000101 | stuk | 111,00 | 232 | 1 |
|---------|--------|--------|-----------|------|--------|-----|---|



Badkamermeubelen
en toiletkasten

Gootstenen en
wastroggen

zeepdispenser m. opaalglas

| | | | | | | | |
|---------|--------|--------|-----------|------|--------|-----|---|
| 0630469 | z. kap | chroom | 472100101 | stuk | 141,00 | 232 | 1 |
|---------|--------|--------|-----------|------|--------|-----|---|



Utiliteit

closetborstelgarnituur











| | | | | | | | |
|---------|--------|--------|-----------|------|--------|-----|---|
| 0630460 | z. kap | chroom | 471500101 | stuk | 138,00 | 232 | 1 |
|---------|--------|--------|-----------|------|--------|-----|---|























planchet







| | | | | | | | | |
|---------|---------|--------|--------|-----------|------|--------|-----|---|
| 0632171 | 50x12cm | z. kap | chroom | 471000150 | stuk | 175,00 | 232 | 1 |
|---------|---------|--------|--------|-----------|------|--------|-----|---|



| | Art.nr | Specificaties | Kleur | Lev.nr | Ehd | Prijs | Grp | CC |
|---|---|---------------|---------|--------|-----------|-----------|--------|--------------|
| | Emco Linea Arte | | | | | | | |
| | spiegel m. decorrand | | | | | | | |
| Sanitair producten |  | 0632627 | 45x70cm | | 479509900 | stuk | 196,00 | 232 1 |
| | | 0632635 | 60x80cm | | 479509901 | stuk | 228,00 | 232 1 |
| | | 0632643 | 70x90cm | | 479509902 | stuk | 289,00 | 232 1 |
| Baden / douchebakken / stoomcabines | | | | | | | | |
| | wandlamp m. opaalglas | | | | | | | |
| Kranen |  | 0632589 | | chroom | 229400101 | stuk | 166,00 | 232 1 |
| | | 0632570 | | chroom | 479200101 | stuk | 180,00 | 232 1 |
| | | 0630476 | | chroom | 479200100 | stuk | 163,00 | 232 1 |
| | | 0632554 | | chroom | 229400100 | stuk | 167,00 | 232 1 |
| Douchegarnituur | | | | | | | | |
| |  | | | | | | | |
| Accessoires en spiegels | | | | | | | | |
| Douchewanden | | | | | | | | |
| |  | | | | | | | |
| Toebehoren & afvoeren | | | | | | | | |
| |  | | | | | | | |
| Spoel- & installatiesystemen | | | | | | | | |
| |  | | | | | | | |
| Badkamermeubelen en toiletkasten | | | | | | | | |
| | handdoekhouder | | | | | | | |
| |  | 0632228 | 60cm | z. kap | chroom | 476000160 | stuk | 110,00 232 1 |
| | | 0630066 | 80cm | z. kap | chroom | 476000180 | stuk | 120,00 232 1 |
| Gootstenen en wastroggen | | | | | | | | |
| | 2-lids handdoekhouder draaibaar | | | | | | | |
| |  | 0630445 | | z. kap | chroom | 475000143 | stuk | 93,50 232 1 |
| | | | | | | | | |
| Utiliteit | | | | | | | | |
| | badgreep 34cm | | | | | | | |
| |  | 0630466 | | z. kap | chroom | 477000125 | stuk | 93,50 232 1 |
| | | | | | | | | |
| | jashaak groot | | | | | | | |
| |  | 0630064 | | z. kap | chroom | 477500100 | stuk | 16,25 232 0 |
| | | | | | | | | |
| | sierkap | | | | | | | |
| |  | 0630464 | | vlak | chroom | 474000100 | stuk | 15,50 232 0 |
| | | | | | | | | |

| Art.nr | Specificaties | Kleur | Lev.nr | Ehd | Prijs | Grp | CC | | |
|--|---------------|-------------|-----------|------|--------|-----|----|---|---|
| | | | | | | | | Emco Linea Arte | |
| rozet 0630463 | | chroom | 474100100 | stuk | 26,75 | 232 | 0 |  | Sanitair producten |
| beautyset 0632473 | z. kap | chroom | 478200108 | stuk | 717,00 | 232 | 1 |  | Baden / douchebakken / stoomcabines |
| toiletset 0630065 | z. kap | chroom | 478000101 | stuk | 499,00 | 232 | 1 |  | Kranen |
| gastenwasset 0632503 | z. kap | chroom | 478200111 | stuk | 696,00 | 232 | 1 |  | Douchegarnituur |
| wattenbox opaalglas 0632198 | z. kap | chroom | 471900101 | stuk | 138,00 | 232 | 1 |  | Douchewanden |
| zeepdispenser, zeephouder, glashouder z. inzet 0633577 | | chroom | 142000100 | stuk | 15,50 | 232 | 0 |  | Toebehoren & afvoeren |
| zeepschaal z. houder 0633593 | | kristalglas | 143000000 | stuk | 20,25 | 232 | 1 |  | Spoel- & installatiesystemen |
| drinkglas z. houder 0633607 | | kristalglas | 142000000 | stuk | 14,00 | 232 | 0 |  | Badkamermeubelen en toiletkasten |
| zeepdispenser z. houder 0633585 | | chroom | 142100101 | stuk | 49,75 | 232 | 0 |  | Gootstenen en wastroggen |
| planchet m. houders 0633542 | | chroom | 141000170 | stuk | 83,50 | 232 | 1 |  | Utiliteit |

| | Art.nr | Specificaties | Kleur | Lev.nr | Ehd | Prijs | Grp | CC |
|---|---|--|-------|-----------|------|-------|-----|----|
| | Emco Logo | | | | | | | |
| Sanitair producten |  | closetrolhouder m. klep 0633518 | chrom | 140000100 | stuk | 26,75 | 232 | 0 |
| Baden / douchebakken / stoomcabines | | | | | | | | |
| Kranen |  | closetrolhouder z. klep 0633526 | chrom | 140000101 | stuk | 20,25 | 232 | 0 |
| Douchegarnituur | | | | | | | | |
| Accessoires en spiegels |  | reserverolhouder 0633534 | chrom | 140500100 | stuk | 18,50 | 232 | 1 |
| Douchewanden |  | closetborstelhouder z. garnituur 0633550 | chrom | 141500100 | stuk | 18,75 | 232 | 0 |
| Toebehoren & afvoeren |  | closetborstelgarnituur z. houder 0633569 | chrom | 141500101 | stuk | 43,50 | 232 | 0 |
| Spoel- & installatiesystemen | | | | | | | | |
| Badkamermeubelen en toiletkasten |  | handdoekhouder 60cm 0633631 | chrom | 146000160 | stuk | 37,25 | 232 | 1 |
| Gootstenen en wastroggen |  | handdoekhouder 80cm 0633658 | chrom | 146000180 | stuk | 42,25 | 232 | 1 |
| Utiliteit |  | 2-lids handdoekhouder draaibaar 0633615 | chrom | 145000138 | stuk | 38,50 | 232 | 0 |
| |  | handdoekring 0633623 | chrom | 145500100 | stuk | 28,50 | 232 | 1 |
| |  | badgreep 30cm 0633666 | chrom | 147000130 | stuk | 32,75 | 232 | 1 |
| | | handdoekhaak chrom 0633674 | chrom | 147500100 | stuk | 7,60 | 232 | 0 |

| Art.nr | Specificaties | Kleur | Lev.nr | Ehd | Prijs | Grp | CC | |
|---|---------------|----------------|------------------------|--------------|------------------|------------|--------|---|
| Emco Logo | | | | | | | | |
| toiletset compleet 0630164 | | chrom | 149800100 | stuk | 97,00 | 232 | 1 |  |
| Emco New waves | | | | | | | | |
| glashouder m. kristalglas 0407739 | | chrom | 122000100 | stuk | 104,00 | 232 | 0 |  |
| zeephouder m. kristal inzet 0407933 | | chrom | 123000100 | stuk | 106,00 | 232 | 1 |  |
| zeepdispenser compleet 0407925 | | chrom | 122100100 | stuk | 165,00 | 232 | 1 |  |
| planchet m. kristalglas 0407712 | | chrom | 121000118 | stuk | 220,00 | 232 | 1 |  |
| 2-lids handdoekhouder draaibaar 0407941 | | chrom | 125000147 | stuk | 192,00 | 232 | 1 |  |
| handdoekhouder draaibaar rechts/links 0407968 | | chrom | 125500100 | stuk | 108,00 | 232 | 1 |  |
| handdoekhouder 0407798 60cm 0407976 80cm | | chrom chrom | 126000160 126000180 | stuk stuk | 137,00 145,00 | 232 232 | 1 1 |  |
| badgreep 30cm 0407801 | | chrom | 127000130 | stuk | 126,00 | 232 | 1 |  |
| closetrolhouder m. beugel 0407690 | | chrom | 120000100 | stuk | 101,00 | 232 | 0 |  |
| closetborstelgarnituur 0407720 | | chrom | 121500100 | stuk | 146,00 | 232 | 0 |  |

Sanitair producten

Baden /
douchebakken /
stoomcabines

Kranen

Doucheapparatuur

Accessoires en
spiegels

Douchewanden











Toebehoren &
afvoeren

Spoel- &
installatiesystemen

Badkamermeubelen
en toiletkasten

Gootstenen en
wastroggen

Utiliteit

| | Art.nr | Specificaties | Kleur | Lev.nr | Ehd | Prijs | Grp | CC | |
|---|---|--|---------------------|-------------|-----------|--------|--------|-----|---|
| Sanitair producten | Emco New waves | | | | | | | | |
| |  | reserverolhouder | | | | | | | |
| 0407704 | | | chrom | 120500100 | stuk | 58,00 | 232 | 1 | |
| Baden / douchebakken / stoomcabines | | | | | | | | | |
| Kranen | haak dubbel | | | | | | | | |
| |  | 0407828 | | chrom | 127500102 | stuk | 79,00 | 232 | 1 |
| Douchegarnituur | | | | | | | | | |
| Accessoires en spiegels | spiegel 40x110cm | | | | | | | | |
| |  | 0407836 | | | 129509980 | stuk | 233,00 | 232 | 1 |
| Douchewanden | | | | | | | | | |
| Toebehoren & afvoeren | toiletset compleet | | | | | | | | |
| |  | 0630170 | | chrom | 129800100 | stuk | 253,00 | 232 | 1 |
| Spoel- & installatiesystemen | | Emco Rondo | | | | | | | |
| |  | glashouder/zeepdispenser houder | | | | | | | |
| 0630543 | | z. inzet | chrom | 502000100 | stuk | 24,50 | 232 | 1 | |
| Badkamermeubelen en toiletkasten | glashouder dubbel z. glas | | | | | | | | |
| |  | 0630546 | | chrom | 502500100 | stuk | 28,50 | 232 | 1 |
| Gootstenen en wastroggen | | zeepdispenser | | | | | | | |
| |  | 0630608 | opaalglas z. houder | chrom | 502100101 | stuk | 53,50 | 232 | 1 |
| | | 0630579 | kunststof z. houder | chrom | 502100102 | stuk | 31,25 | 232 | 1 |
| Utiliteit | | drinkglas | | | | | | | |
| |  | 0630594 | | acrylglas | 502000001 | stuk | 7,70 | 232 | 1 |
| | | 0630586 | | kristalglas | 502000000 | stuk | 9,40 | 232 | 1 |
| | | inzet voor zeepdispenser | | | | | | | |
|  | | 0630578 | | acrylglas | 503000001 | stuk | 10,50 | 232 | 1 |
| | 0630551 | | kristalglas | 503000000 | stuk | 21,00 | 232 | 1 | |
| planchet kristalglas | | | | | | | | | |
|  | 0630527 | 50x12cm | chrom | 501000150 | stuk | 97,00 | 232 | 1 | |
| | 0630519 | 70x12cm | chrom | 501000170 | stuk | 106,00 | 232 | 1 | |

| Art.nr | Specificaties | Kleur | Lev.nr | Ehd | Prijs | Grp | CC | |
|---|---------------|-------|-----------|------|-------|-----|----|---|
| Emco Rondo | | | | | | | | |
| 2-lids handdoekhouder draaibaar 0630616 | | chrom | 505000144 | stuk | 43,25 | 232 | 1 |  |
| handdoekkring 0630624 | | chrom | 505500100 | stuk | 29,25 | 232 | 1 |  |
| handdoekhouder 0630632 60cm | | chrom | 506000160 | stuk | 57,50 | 232 | 1 |  |
| 0630640 80cm | | chrom | 506000180 | stuk | 60,50 | 232 | 1 | |
| badgreep 0630659 | | chrom | 507000125 | stuk | 40,50 | 232 | 1 |  |
| closetrolhouder z. klep 0630497 | | chrom | 500000101 | stuk | 22,50 | 232 | 1 |  |
| closetrolhouder m. klep 0630489 | | chrom | 500000100 | stuk | 38,25 | 232 | 1 |  |
| reserverolhouder 0630500 | | chrom | 500500100 | stuk | 21,00 | 232 | 1 |  |
| closetborstelgarnituur 0630535 | greep=wit | chrom | 501500100 | stuk | 51,50 | 232 | 1 |  |
| 0630538 | greep=chrom | chrom | 501500101 | stuk | 67,50 | 232 | 1 | |
| handdoekhaak 2-delig 0630667 | | chrom | 507500102 | stuk | 26,25 | 232 | 1 |  |
| handdoekhaak groot 0630657 | | chrom | 507500101 | stuk | 8,80 | 232 | 0 |  |

Sanitair producten

Baden /
douchebakken /
stoomcabines

Kranen

Douchegarnituur

Accessoires en
spiegels

Douchewanden

Toebehoren &
afvoeren







Spoel- &
installatiesystemen

Badkamermeubelen
en toiletkasten

Gootstenen en
wastroggen

Utiliteit

| | Art.nr | Specificaties | Kleur | Lev.nr | Ehd | Prijs | Grp | CC |
|---|--|---------------|-------|-----------|------|--------|-----|----|
| Sanitair producten | Emco Rondo | | | | | | | |
| | toiletset compleet | | | | | | | |
| | 0630165 | | | 509800100 | stuk | 109,00 | 232 | 1 |
| Baden / douchebakken / stoomcabines | Emco Rondo 2 | | | | | | | |
| | glashouder m. glas kristal helder | | | | | | | |
| | 0630516 | | chrom | 452000100 | stuk | 47,50 | 232 | 1 |
| Kranen | zeephouder m. zeepschaal kristal helder | | | | | | | |
| | 0630508 | | chrom | 453000100 | stuk | 52,50 | 232 | 1 |
| Douchegarnituur | zeepdispenser m. kristal helder | | | | | | | |
| | 0630517 | | chrom | 452100100 | stuk | 78,50 | 232 | 1 |
| Accessoires en spiegels | 2-lids handdoekhouder draaibaar | | | | | | | |
| | 0630510 | 36cm | chrom | 455000136 | stuk | 46,00 | 232 | 1 |
| Douchewanden | | 0630509 | 46cm | 455000146 | stuk | 51,50 | 232 | 0 |
| | handdoekring | | | | | | | |
| Toebehoren & afvoeren | | 0630511 | | 455500100 | stuk | 43,50 | 232 | 1 |
| Spoel- & installatiesystemen | badhanddoekhouder | | | | | | | |
| | | 0630512 | 60cm | 456000160 | stuk | 67,00 | 232 | 1 |
| Badkamermeubelen en toiletkasten | | 0630513 | 80cm | 456000180 | stuk | 78,00 | 232 | 1 |
| | handdoekhaak dubbel | | | | | | | |
| Gootstenen en wastroggen | | 0630515 | | 457500102 | stuk | 25,00 | 232 | 1 |
| Utiliteit | badgreep | | | | | | | |
| | | 0630514 | 30cm | 457000130 | stuk | 55,50 | 232 | 1 |

| Art.nr | Specificaties | Kleur | Lev.nr | Ehd | Prijs | Grp | CC | |
|--|--------------------------|--------|-----------|------|--------|-----|----|---|
| Emco Rondo 2 | | | | | | | | |
| planchet m. glasplaat kristal helder 0630505 | 60x12cm | chroom | 451000160 | stuk | 107,00 | 232 | 1 |  |
| klosetrolhouder z. klep 0630502 | | chroom | 450000101 | stuk | 34,25 | 232 | 0 |  |
| klosetrolhouder m. klep 0630501 | | chroom | 450000100 | stuk | 43,50 | 232 | 0 |  |
| klosetborstelgarnituur wandmodel | | | | | | | | |
| 0630506 | steel m. deksel | chroom | 451500100 | stuk | 103,00 | 232 | 0 |  |
| 0630507 | m. kristal heldere inzet | chroom | 451500101 | stuk | 72,50 | 232 | 0 | |
| toiletset 0630504 | | chroom | 459800100 | stuk | 120,00 | 232 | 1 |  |
| Emco Singles | | | | | | | | |
| glashouder staand model 0631803 | | chroom | 102000100 | stuk | 36,50 | 232 | 1 |  |
| zeepouder staand model 0631805 | | chroom | 103000100 | stuk | 30,00 | 232 | 1 |  |
| zeepdispenser pomp=metaal 0633496 | | chroom | 102100100 | stuk | 122,00 | 232 | 1 |  |
| zeepdispenser pomp=kunststof 0631807 | | chroom | 102100101 | stuk | 82,00 | 232 | 1 | |

Sanitair producten

Baden /
douchebakken /
stoomcabines

Kranen

Douchegarnituur

Accessoires en
spiegels

Douchewanden

Toebehoren &
afvoeren







Spoel- &
installatiesystemen



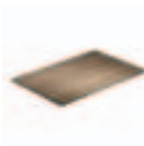







Badkamermeubelen
en toiletkasten











Gootstenen en
wastroggen











Utiliteit









| | Art.nr | Specificaties | Kleur | Lev.nr | Ehd | Prijs | Grp | CC |
|---|---------------------|---|---|------------|-----------|---------|-------|-----|
| Sanitair producten | Emco Singles | | | | | | | |
| | | sierradenschaaltje 0633488 | chroom | 101900100 | stuk | 65,00 | 232 | 1 |
| Baden / douchebakken / stoomcabines | | closetborstelgarnituur wandmodel 0631804 | chroom | 101500100 | stuk | 85,50 | 232 | 0 |
| Kranen | | closetborstelgarnituur staand model 0630327 | chroom | 101500101 | stuk | 77,00 | 232 | 1 |
| Douchegarnituur | | klemspot m. flexarm 0634220 | chroom | 089400102 | stuk | 105,00 | 232 | 0 |
| Accessoires en spiegels | | 0634239 | chroom | 449400100 | stuk | 105,00 | 232 | 0 |
| | Douchewanden | | wandspot halogeen 50W 0630706 | chroom | 449300101 | stuk | 82,50 | 232 |
| Toebehoren & afvoeren | | klemspot halogeen 50W 0630015 | chroom | 449200101 | stuk | 105,00 | 232 | 0 |
| Spoel- & installatiesystemen | | teakhouten hocker 50x45cm 0634205 | | 107950600A | stuk | 634,00 | 232 | 1 |
| Badkamermeubelen en toiletkasten | | teakhouten bank 100x45cm 0634206 | | 107950601A | stuk | 1080,00 | 232 | 1 |
| Gootstenen en wastroggen | | | | | | | | |
| Utiliteit | | | | | | | | |









| Art.nr | Specificaties | Kleur | Lev.nr | Ehd | Prijs | Grp | CC | | |
|--|----------------|--------|------------|------|--------|-----|----|---|---|
| | | | | | | | | Emco Singles | |
| teakhouten dresboy 50x90cm 0634207 | | | 107950602A | stuk | 425,00 | 232 | 1 |  | Sanitair producten |
| teakhouten badmat 60x60cm 0634208 | | | 107950604A | stuk | 283,00 | 232 | 1 |  | Baden / douchebakken / stoomcabines |
| teakhouten badmat 90x60cm 0634209 | | | 107950605A | stuk | 417,00 | 232 | 1 | | Kranen |
| deuretagere m. 2 korven m. wiss 0630154 | | chroom | 106600106 | stuk | 194,00 | 232 | 1 |  | Douchegarnituur |
| deuretagere m. 2 korven m. zeepdispenser 0630155 | | chroom | 106600107 | stuk | 249,00 | 232 | 1 |  | Accessoires en spiegels |
| wandtagere m. 2 korven m. wiss 0630156 | | chroom | 106600108 | stuk | 181,00 | 232 | 1 |  | Douchewanden |
| glashouder met glas 0630372 | | chroom | 572000100 | stuk | 56,50 | 232 | 0 |  | Toebehoren & afvoeren |
| zeepdispenser m.kristalglas 0630374 | kunststof pomp | chroom | 572100101 | stuk | 92,50 | 232 | 1 |  | Spoel- & installatiesystemen |
| zeepdispenser m.kunststof glas 0630375 | kunststof pomp | chroom | 572100102 | stuk | 71,00 | 232 | 1 | | Badkamermeubelen en toiletkasten |
| zeephouder m. glas 0630376 | | chroom | 573000100 | stuk | 80,00 | 232 | 1 |  | Gootstenen en wastroggen |







| | Art.nr | Specificaties | Kleur | Lev.nr | Ehd | Prijs | Grp | CC |
|---|---|---|-------------------------|-------------------------------------|----------------------|----------------------------|-------------------|-------------|
| | Emco System 01 | | | | | | | |
| Sanitair producten |  | zeepdispenser m.kristalglas 0630424 metaal pomp | chrom | 572100100 | stuk | 135,00 | 232 | 1 |
| Baden / douchebakken / stoomcabines | | | | | | | | |
| Kranen |  | badlakenrek enkel 0630379 80cm 0630380 60cm | chrom chrom | 576000180 576000160 | stuk stuk | 59,50 54,50 | 232 232 | 1 1 |
| Douchegarnituur |  | badlakenrek dubbel 0630382 80cm 0630428 60cm | chrom chrom | 576100182 576100162 | stuk stuk | 246,00 193,00 | 232 232 | 1 1 |
| Accessoires en spiegels | | | | | | | | |
| Douchewanden |  | droogrek draaibaar 0630383 | chrom | 576100161 | stuk | 228,00 | 232 | 1 |
| Toebehoren & afvoeren |  | closetrolhouder m.klep 0630366 | chrom | 570000100 | stuk | 86,50 | 232 | 0 |
| Spoel- & installatiesystemen | | | | | | | | |
| Badkamermeubelen en toiletkasten |  | reserverolhouder 0630367 | chrom | 570500100 | stuk | 46,25 | 232 | 1 |
| Gootstenen en wastroggen |  | handdoekhaak draaibaar 0630377 49cm | chrom | 575000149 | stuk | 131,00 | 232 | 1 |
| Utiliteit |  | handdoekring vast 0630378 | chrom | 575500100 | stuk | 56,00 | 232 | 1 |
| |  | planchet m.glasplaat 0630368 24cm 0630369 50cm 0630370 70cm | chrom chrom chrom | 571000124 571000150 571000170 | stuk stuk stuk | 243,00 122,00 141,00 | 232 232 232 | 1 1 1 |
| |  | closetborstelgarnituur wandmodel 0630371 | chrom | 571500100 | stuk | 99,50 | 232 | 0 |

| Art.nr | Specificaties | Kleur | Lev.nr | Ehd | Prijs | Grp | CC | | |
|--|---------------|--------------|-----------|------|--------|-----|----|---|---|
| | | | | | | | | Emco System 01 | |
| inbouwclosetrolhouder 0630390 | | edelstaal | 570000001 | stuk | 38,75 | 232 | 1 |  | Sanitair producten |
| inbouwclosetrolhouder dubbel horizontaal 0630391 | | edelstaal | 570000002 | stuk | 77,50 | 232 | 1 |  | Baden / douchebakken / stoomcabines |
| inbouwclosetrolhouder dubbel verticaal 0630392 | | edelstaal | 570000003 | stuk | 79,00 | 232 | 1 |  | Kranen |
| handdoekhaak enkel 0630386 | | chroom | 577500100 | stuk | 14,25 | 232 | 0 |  | Douchegarnituur |
| handdoekhaak dubbel 0630385 | | chroom | 577500102 | stuk | 68,00 | 232 | 1 |  | Accessoires en spiegels |
| badgreep 0630384 25cm | | chroom | 577000125 | stuk | 37,50 | 232 | 1 |  | Douchewanden |
| badgreep met zeepkorf 0630405 | | chroom | 577100100 | stuk | 71,00 | 232 | 1 |  | Toebehoren & afvoeren |
| douchehandgreep links 0630415 | | chr./transp. | 576426231 | stuk | 366,00 | 232 | 1 |  | Spoel- & installatiesystemen |
| douchehandgreep rechts 0630414 | | chr./transp. | 576426230 | stuk | 366,00 | 232 | 1 |  | Badkamermeubelen en toiletkasten |
| gebogen handgreep links 90° 0630409 | | chr./transp. | 577026260 | stuk | 215,00 | 232 | 1 |  | Gootstenen en wastroggen |
| | | | | | | | | | Utiliteit |

| | Art.nr | Specificaties | Kleur | Lev.nr | Ehd | Prijs | Grp | CC |
|---|---|---|------------------------------|------------------------|--------------|------------------|------------|--------|
| | Emco System 01 | | | | | | | |
| Sanitair producten |  | gebogen handgreep links 45° 0630407 | chr./transp. | 577026270 | stuk | 200,00 | 232 | 1 |
| Baden / douchebakken / stoomcabines |  | gebogen handgreep rechts 0630408 | chr./transp. | 577026271 | stuk | 200,00 | 232 | 1 |
| Kranen |  | haakset tweedelig 0630387 | chrom | 577400102 | stuk | 34,50 | 232 | 1 |
| Douchegarnituur |  | handgreep 0630412 62,5cm 0630413 82,5cm | chr./transp. chr./transp. | 577026262 577026280 | stuk stuk | 200,00 206,00 | 232 232 | 1 1 |
| Accessoires en spiegels |  | hoekhandgreep 0630406 | chr./transp. | 577026250 | stuk | 200,00 | 232 | 1 |
| Douchewanden |  | houder voor haardroger 0630401 | chrom | 575900100 | stuk | 45,75 | 232 | 1 |
| Toebehoren & afvoeren |  | hygienebox 0630394 | chrom | 575300101 | stuk | 36,00 | 232 | 1 |
| Spoel- & installatiesystemen |  | inbouw tissuebox 0630396 | chrom | 575700100 | stuk | 45,25 | 232 | 1 |
| Badkamermeubelen en toiletkasten |  | lamp recht model m.opaalglas 0630389 54cm | | 579000100 | stuk | 329,00 | 232 | 1 |
| Gootstenen en wastroggen |  | lamp rond model m.opaalglas 0630388 | | 579000000 | stuk | 110,00 | 232 | 1 |
| Utiliteit |  | opklapbare steun 0630417 60cm 0630416 82cm | chr./transp. chr./transp. | 578526260 578526282 | stuk stuk | 534,00 558,00 | 232 232 | 1 1 |

| Art.nr | Specificaties | Kleur | Lev.nr | Ehd | Prijs | Grp | CC | | |
|--|---------------|------------------------------|------------------------|--------------|------------------|------------|--------|---|---|
| | | | | | | | | Emco System 01 | |
| papierhouder voor 5785262 0630420 | | chrom | 570000103 | stuk | 231,00 | 232 | 1 |  | Sanitair producten |
| asbakhouder m. helder glas 0630423 | | chrom | 573500100 | stuk | 82,50 | 232 | 1 |  | Baden / douchebakken / stoomcabines |
| steungreep 0630419 60cm 0630422 85cm | | chr./transp. chr./transp. | 578526261 575921200 | stuk stuk | 494,00 118,00 | 232 232 | 1 1 |  | Kranen |
| tissuebox 0630395 | | chrom | 575700101 | stuk | 69,50 | 232 | 1 |  | Douchegarnituur |
| vloer/wandgreep 0630421 | | chr./transp. | 578526286 | stuk | 544,00 | 232 | 1 |  | Accessoires en spiegels |
| vochtigpapierhouder 0630393 | | chrom | 573900100 | stuk | 49,50 | 232 | 1 |  | Douchewanden |
| haardroger m.schakelaar 0630399 | | wit | 575913900 | stuk | 178,00 | 232 | 1 |  | Toebehoren & afvoeren |
| haardroger m.wandhouder 0630398 | | wit | 575913901 | stuk | 97,00 | 232 | 1 |  | Spoel- & installatiesystemen |
| afvallemmer m. deksel staand 0630397 3-liter wandmodel | | chrom | 575300100 | stuk | 53,50 | 232 | 1 |  | Badkamermeubelen en toiletkasten |
| | | | | | | | | | Gootstenen en wastroggen |
| | | | | | | | | | Utiliteit |

| | Art.nr | Specificaties | Kleur | Lev.nr | Ehd | Prijs | Grp | CC |
|---|---|----------------------|-------|-----------|------|--------|-----|----|
| Sanitair producten | Emco System 01 | | | | | | | |
| | afvallemmer m. deksel | | | | | | | |
| | 0631122 | 5-liter staand | chrom | 575300000 | stuk | 53,50 | 232 | 1 |
| Baden / douchebakken / stoomcabines | 0630342 | 5-liter ovaal staand | chrom | 575300004 | stuk | 46,25 | 323 | 1 |
| |  | | | | | | | |
| Kranen | afvallemmer z. deksel 7-liter | | | | | | | |
| | 0630429 | 7-liter staand | chrom | 575300001 | stuk | 53,50 | 323 | 1 |
| Douchegarnituur | afvallemmer z. deksel | | | | | | | |
| | 0630430 | 15-liter staand | chrom | 575300002 | stuk | 53,50 | 323 | 1 |
| Accessoires en spiegels | handdoekhouder dubbel | | | | | | | |
| | 0630432 | 80cm | chrom | 576100180 | stuk | 72,50 | 323 | 1 |
| | 0630433 | 60cm | chrom | 576800160 | stuk | 149,00 | 323 | 1 |
| Douchewanden |  | | | | | | | |
| |  | | | | | | | |
| Toebehoren & afvoeren | handdoekhouder enkel | | | | | | | |
| | 0630434 | 60cm | chrom | 576800161 | stuk | 86,50 | 323 | 1 |
| Spool- & installatiesystemen |  | | | | | | | |
| |  | | | | | | | |
| Badkamermeubelen en toiletkasten | handdoektagere 32.5cm | | | | | | | |
| | 0630435 | | chrom | 576900100 | stuk | 216,00 | 323 | 1 |
| Gootstenen en wastroggen |  | | | | | | | |
| |  | | | | | | | |
| Utiliteit | handdoeklegger m. houder | | | | | | | |
| | 0630436 | 60cm | chrom | 576800162 | stuk | 110,00 | 323 | 1 |
| Utiliteit |  | | | | | | | |
| | waslijn uittrekbaar | | | | | | | |
| | 0630437 | 2500cm | chrom | 575400125 | stuk | 56,50 | 323 | 1 |
| |  | | | | | | | |

| Art.nr | Specificaties | Kleur | Lev.nr | Ehd | Prijs | Grp | CC | |
|--|---------------|-----------|-----------|------|---------|-----|----|---|
| Emco System 01 | | | | | | | | |
| klapzitje m. leuning wandmodel 0630439 | | chrom/wit | 575121500 | stuk | 456,00 | 323 | 1 |  |
| douchereeling voor zitje links 0630443 | | chrom | 575100100 | stuk | 600,00 | 323 | 1 |  |
| douchereeling voor zitje rechts 0630444 | | chrom | 575100101 | stuk | 600,00 | 323 | 1 | |
| reling voor zitje m. leuning 0630447 | | chrom | 575100102 | stuk | 223,00 | 323 | 1 |  |
| badkamerstoel 0630448 | | chrom/wit | 575126200 | stuk | 1278,00 | 323 | 1 |  |
| toiletset compleet 0630168 | | chrom | 579800100 | stuk | 196,00 | 232 | 1 | |
| Emco spiegels | | | | | | | | |
| scheerspiegel 1-armig 0630050 20cm diam. | | chrom | 109500101 | stuk | 182,00 | 232 | 1 |  |
| scheerspiegel 2-armig 0631810 20cm diam. | | chrom | 109500102 | stuk | 150,00 | 232 | 0 |  |
| scheerspiegel 3-armig 0631801 20cm diam. | | chrom | 109500103 | stuk | 227,00 | 232 | 1 |  |
| scheerspiegel in hoogte verstelbaar 0630328 20cm diam. | | chrom | 109500105 | stuk | 146,00 | 232 | 1 | |
| scheerspiegel staand 0630329 20cm diam. | | chrom | 109500104 | stuk | 146,00 | 232 | 1 | |

Sanitair producten

Baden /
douchebakken /
stoomcabines

Kranen

Douchegarnituur

Accessoires en
spiegels

Douchewanden







Toebehoren &
afvoeren





Spoel- &
installatiesystemen



Badkamermeubelen
en toiletkasten

Gootstenen en
wastroggen

Utiliteit

| | Art.nr | Specificaties | Kleur | Lev.nr | Ehd | Prijs | Grp | CC |
|---|---|---|--------|--|--|---|--|----------------------------|
| Emco spiegels | | | | | | | | |
| Sanitair producten |  | scheerspiegel 2-armig 0631814 20cm diam. m. verlichting | chroom | 109600102 | stuk | 276,00 | 232 | 0 |
| Baden / douchebakken / stoomcabines | | | | | | | | |
| Kranen |  | scheerspiegel in hoogte verstelbaar 0631812 20cm diam. m. verlichting | chroom | 109600101 | stuk | 323,00 | 232 | 1 |
| Douchegarnituur | | | | | | | | |
| Accessoires en spiegels |  | thermospiegel met verlichting 0631816 160x61cm warmteafgifte 950W | | 449605070A | stuk | 1751,00 | 232 | 1 |
| Douchewanden |  | handdoekhouder draaibaar voor thermospiegel 0631821 | chroom | 445000158 | stuk | 135,00 | 232 | 1 |
| Toebehoren & afvoeren | | | | | | | | |
| Spoel- & installatiesystemen | | spiegel bovenrand gebogen 0630332 60x70cm 0630331 80x70cm | | 199509981 199509980 | stuk stuk | 339,00 383,00 | 232 232 | 1 1 |
| Badkamermeubelen en toiletkasten | | spiegel m. decorrand ovaal 87.5x53cm 0630847 | | 229509986 | stuk | 311,00 | 232 | 1 |
| Gootstenen en wastroggen | | spiegel 8-hoekig met facet 0630335 70x90cm 0630333 45x70cm 0630334 60x80cm | | 299509982 299509980 299509981 | stuk stuk stuk | 292,00 211,00 252,00 | 232 232 232 | 1 1 1 |
| Utiliteit |  | spiegel m. gepolijste groefdecor 0630336 45x70cm 0630067 60x80cm 0630337 70x90cm | | 289509900 289509901 509509902 | stuk stuk stuk | 318,00 371,00 368,00 | 232 232 232 | 1 1 1 |
| |  | spiegel m. TL verlichting links en rechts 0631850 80x45cm 0631851 80x60cm 0631852 80x70cm 0630338 80x100cm 0630339 80x120cm 0630340 100x80cm | | 449613981 449613982 449613983 449613986 449613987 449613988 | stuk stuk stuk stuk stuk stuk | 769,00 793,00 817,00 1023,00 1228,00 1023,00 | 232 232 232 232 232 232 | 1 1 1 1 1 1 |
| | | spiegel m. TL verlichting boven 0631853 80x70cm | | 449613984 | stuk | 745,00 | 232 | 1 |
| |  | spiegel m. TL verlichting rondom 0631854 80x80cm 0630341 100x100cm | | 449613985 449613916 | stuk stuk | 1002,00 1372,00 | 232 232 | 1 1 |

| Art.nr | Specificaties | Kleur | Lev.nr | Ehd | Prijs | Grp | CC | |
|--|---------------|------------------|---------------------|------|--------|-----|----|---|
| Emco spiegels | | | | | | | | |
| spiegel m. decorrand 93x50cm ovaal 0631843 | | | 449509923 | stuk | 285,00 | 232 | 1 |  |
| Sanitair producten | | | | | | | | |
| Baden / douchebakken / stoomcabines | | | | | | | | |
| spiegel m. decorrand 80x60cm 0631845 | | | 449509925 | stuk | 291,00 | 232 | 1 |  |
| Kranen | | | | | | | | |
| Douchegarnituur | | | | | | | | |
| rechthoekige spiegel 0630330 67.5x100cm | | | 179509980 | stuk | 244,00 | 232 | 1 | |
| spiegel m. groefdecor | | | | | | | | |
| 0630070 45x70cm | | | 509509900 | stuk | 272,00 | 232 | 1 | |
| 0630029 60x80cm | | | 509509901 | stuk | 316,00 | 232 | 1 | |
| spiegel m. verlichting m. lampglas 70x50cm 0631857 | | | | | | | | |
| | | | 449600149+449613990 | stuk | 616,00 | 232 | 1 | |
| Emco verlichting | | | | | | | | |
| wandlamp | | | | | | | | |
| 0630077 60cm | | matglas/RVS | 109001302 | stuk | 493,00 | 232 | 1 |  |
| 0630078 80cm | | matglas/RVS | 109001303 | stuk | 567,00 | 232 | 1 | |
| 0630079 100cm | | matglas/RVS | 109001304 | stuk | 617,00 | 232 | 1 | |
| 0630080 120cm | | matglas/RVS | 109001305 | stuk | 641,00 | 232 | 1 | |
| 0630085 75cm | | matglas/chroom | 109000118 | stuk | 590,00 | 232 | 1 | |
| 0630086 75cm | | matglas/mat nik. | 109001403 | stuk | 590,00 | 232 | 1 | |
| Toebehoren & afvoeren | | | | | | | | |
| Spoel- & installatiesystemen | | | | | | | | |
| Badkamermeubelen en toiletkasten | | | | | | | | |
| klemlamp voor spot m. transformator 0630087 | | matglas/chroom | 109000125 | stuk | 219,00 | 232 | 0 |  |
| Gootstenen en wastroggen | | | | | | | | |
| wandlamp | | | | | | | | |
| 0630088 55cm | | opaalglas/chr. | 109000121 | stuk | 295,00 | 232 | 1 |  |
| 0630089 55cm | | matglas/mat nik. | 109001404 | stuk | 295,00 | 232 | 1 | |
| 0630092 29.5cm | | opaalglas/chr. | 109000123 | stuk | 364,00 | 232 | 1 | |
| 0630093 29.5cm | | matglas/mat nik. | 109001406 | stuk | 364,00 | 232 | 1 | |
| 0630094 48.5cm | | opaalglas/chr. | 109000124 | stuk | 543,00 | 232 | 1 | |
| 0630095 48.5cm | | matglas/mat nik. | 109001407 | stuk | 543,00 | 232 | 1 | |
| Utiliteit | | | | | | | | |
| montageplaat voor verlichting rond 110mm 0630326 | | chroom | 0192403 | stuk | 22,25 | 232 | 1 | |

| | Art.nr | Specificaties | Kleur | Lev.nr | Ehd | Prijs | Grp | CC |
|---|---|---|--------|-----------|------|--------|-----|----|
| Sanitair producten | Emco Universeel | | | | | | | |
| |  | 2845 hoekzeepkorf draadmodel 0630495 | chroom | 574500100 | stuk | 32,75 | 232 | 1 |
| Baden / douchebakken / stoomcabines |  | 2847 hoekspoonskorf draadmodel 0630676 | chroom | 574500102 | stuk | 43,00 | 232 | 1 |
| | Kranen | borstelkop los universeel 0630221 | | 101513990 | stuk | 8,80 | 232 | 0 |
| Douchegarnituur |  | wandlamp m. satijnglas m. rozet 0630234 | chroom | 299000102 | stuk | 251,00 | 232 | 1 |
| Accessoires en spiegels | | | | | | | | |
| Douchewanden | | | | | | | | |
| Toebehoren & afvoeren | | | | | | | | |
| Spoel- & installatiesystemen | | | | | | | | |
| Badkamermeubelen en toiletkasten | | | | | | | | |
| Gootstenen en wastroggen | | | | | | | | |
| Utiliteit | | | | | | | | |

| Art.nr | Specificaties | Kleur | Lev.nr | Ehd | Prijs | Grp | CC |
|---|---------------|--------|--------|------|-------|-----|----|
| Othello glaswissers | | | | | | | |
| glaswisser m.wandhouder-B 0656000 | | chroom | ST101B | stuk | 84,00 | 247 | 1 |
| glaswisser los 0656001 | | chroom | ST101 | stuk | 47,00 | 247 | 1 |

Sanitair producten

Baden /
douchebakken /
stoomcabines

Kranen

Douchegarnituur

Accessoires en
spiegels

Douchewanden

Toebehoren &
afvoeren









Spoel- &
installatiesystemen

Badkamermeubelen
en toiletkasten

Gootstenen en
wastroggen

Utiliteit

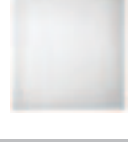
| | Art.nr | Specificaties | Kleur | Lev.nr | Ehd | Prijs | Grp | CC |
|---|--------|--|-------|----------|------|--------|-----|----|
| Sanitair producten | | Grohe Allure glas-/zeephouder 0434058 | chrom | 40278000 | stuk | 96,00 | 162 | 1 |
| Baden / douchebakken / stoomcabines | | zeepdispenser 0434065 | chrom | 40363000 | stuk | 208,00 | 162 | 1 |
| Kranen | | | | | | | | |
| Douchegarnituur | | closetrolhouder z. klep 0434059 | chrom | 40279000 | stuk | 128,00 | 162 | 1 |
| Accessoires en spiegels | | | | | | | | |
| Douchewanden | | closetborstelgarnituur 0434062 | chrom | 40340000 | stuk | 208,00 | 162 | 1 |
| Toebehoren & afvoeren | | | | | | | | |
| Spoel- & installatiesystemen | | handdoekring 0434061 | chrom | 40339000 | stuk | 128,00 | 162 | 1 |
| Badkamermeubelen en toiletkasten | | handdoekhouder 60cm 0434063 | chrom | 40341000 | stuk | 192,00 | 162 | 1 |
| Gootstenen en wastroggen | | | | | | | | |
| Utiliteit | | 1-lids handdoekhouder 0434064 | chrom | 40342000 | stuk | 192,00 | 162 | 1 |
| | | haak enkel 0434060 | chrom | 40284000 | stuk | 48,25 | 162 | 1 |
| | | Grohe Atrio glashouder z. glas 0443700 | chrom | 40304000 | stuk | 92,00 | 162 | 1 |
| | | zeephouder z. schaal 0443719 | chrom | 40305000 | stuk | 92,00 | 162 | 1 |

| Art.nr | Specificaties | Kleur | Lev.nr | Ehd | Prijs | Grp | CC | |
|---|---------------|-------|----------|------|--------|-----|----|---|
| Grohe Atrio | | | | | | | | |
| zeepdispenser 0443727 | | chrom | 40306000 | stuk | 182,00 | 162 | 1 |  |
| handdoekring 0443735 | | chrom | 40307000 | stuk | 111,00 | 162 | 1 |  |
| 2-lids handdoekhouder draaibaar 0443743 | | chrom | 40308000 | stuk | 130,00 | 162 | 1 |  |
| handdoekhouder 0443751 60cm | | chrom | 40309000 | stuk | 198,00 | 162 | 1 |  |
| closetrolhouder z. klep 0443808 | | chrom | 40313000 | stuk | 152,00 | 162 | 1 |  |
| closetborstelgarnituur 0443816 | | chrom | 40314000 | stuk | 261,00 | 162 | 1 |  |
| haak 0443794 | | chrom | 40312000 | stuk | 81,00 | 162 | 1 |  |
| wandlamp compleet 0443840 | | chrom | 40317000 | stuk | 297,00 | 162 | 1 |  |
| spiegel 67x87cm 0443824 | | | 40315000 | stuk | 341,00 | 162 | 1 |  |
| Grohe Chiara | | | | | | | | |
| glashouder z. glas enkel 0439543 | | chrom | 40323000 | stuk | 78,50 | 241 | 1 |  |

Sanitair producten

Baden /
douchebakken /
stoomcabines

Kranen

Douchegarnituur

Accessoires en
spiegels

Douchewanden









Toebehoren &
afvoeren











Spoel- &
installatiesystemen

Badkamermeubelen
en toiletkasten

Gootstenen en
wastroggen

Utiliteit

| | Art.nr | Specificaties | Kleur | Lev.nr | Ehd | Prijs | Grp | CC |
|---|---|--|-------|----------|------|--------|-----|----|
| | Grohe Chiara | | | | | | | |
| Sanitair producten | | drinkglas voor 40323 kristal 0439510 | | 40324000 | stuk | 29,25 | 241 | 1 |
| Baden / douchebakken / stoomcabines |  | zeephouder z. schaal 0439578 | chrom | 40325000 | stuk | 78,50 | 241 | 1 |
| Kranen |  | zeepdispenser wandmodel 0439675 | chrom | 40326000 | stuk | 159,00 | 241 | 1 |
| Douchegarnituur | | | | | | | | |
| Accessoires en spiegels |  | handdoekring 0439594 | chrom | 40327000 | stuk | 96,00 | 241 | 1 |
| Douchewanden | | | | | | | | |
| Toebehoren & afvoeren |  | 2-lids handdoekhouder 0439608 | chrom | 40328000 | stuk | 115,00 | 241 | 1 |
| Spoel- & installatiesystemen |  | handdoekhouder 60cm 0439616 | chrom | 40329000 | stuk | 160,00 | 241 | 1 |
| Badkamermeubelen en toiletkasten |  | handdoekhaak 2-delig 0439651 | chrom | 40332000 | stuk | 71,50 | 241 | 1 |
| Gootstenen en wastroggen | | | | | | | | |
| Utiliteit |  | closetrolhouder m. klep 0439659 | chrom | 40333000 | stuk | 133,00 | 241 | 1 |
| |  | closetborstelgarnituur wandmodel 0439667 | chrom | 40335000 | stuk | 213,00 | 241 | 1 |
| | Grohe Ectos | | | | | | | |
| |  | glashouder z. glas 0439840 | chrom | 40253000 | stuk | 89,00 | 241 | 1 |
| | | drinkglas voor 40253 0439839 | | 40254000 | stuk | 31,25 | 241 | 1 |

| Art.nr | Specificaties | Kleur | Lev.nr | Ehd | Prijs | Grp | CC | |
|--|---------------|--------|----------|------|--------|-----|----|---|
| Grohe Ectos | | | | | | | | |
| zeepschaal 0439837 | | | 40256000 | stuk | 39,75 | 241 | 1 |  |
| zeepdispenser wandmodel 0439824 | | chroom | 40266000 | stuk | 176,00 | 241 | 1 |  |
| glasplaat 0439842 60cm | | | 40252000 | stuk | 87,00 | 241 | 1 |  |
| badgreep 30cm 0439830 | | chroom | 40261000 | stuk | 178,00 | 241 | 1 |  |
| closetrolhouder z. klep 0439828 | | chroom | 40263000 | stuk | 147,00 | 241 | 1 |  |
| closetborstelgarnituur wandmodel 0439825 | | chroom | 40264000 | stuk | 253,00 | 241 | 1 |  |
| haak 0439829 | | chroom | 40262000 | stuk | 78,50 | 241 | 1 |  |
| Grohe Essentials | | | | | | | | |
| glas-/zeephouder 0464968 | | chroom | 40369000 | stuk | 29,25 | 241 | 1 |  |
| drinkglas los 0464970 | | | 40372000 | stuk | 16,25 | 241 | 1 |  |
| zeepschaal los 0464969 | | | 40368000 | stuk | 16,25 | 241 | 1 |  |

Sanitair producten

Baden /
douchebakken /
stoomcabines

Kranen

Douchegarnituur

Accessoires en
spiegels

Douchewanden











Toebehoren &
afvoeren









Spoel- &
installatiesystemen







Badkamermeubelen
en toiletkasten

Gootstenen en
wastroggen

Utiliteit

| | Art.nr | Specificaties | Kleur | Lev.nr | Ehd | Prijs | Grp | CC |
|---|---|--|-------|----------|------|--------|-----|----|
| | Grohe Essentials | | | | | | | |
| Sanitair producten |  | zeepdispenser wandmodel 0464971 | chrom | 40373000 | stuk | 48,50 | 241 | 1 |
| Baden / douchebakken / stoomcabines | | | | | | | | |
| Kranen |  | handdoekring 0464972 | chrom | 40365000 | stuk | 29,25 | 241 | 1 |
| Douchegarnituur | | | | | | | | |
| Accessoires en spiegels |  | 2-lids handdoekhouder draaibaar 0464973 | chrom | 40371000 | stuk | 48,50 | 241 | 1 |
| Douchewanden | | | | | | | | |
| Toebehoren & afvoeren |  | handdoekhouder 60cm 0464974 | chrom | 40366000 | stuk | 48,50 | 241 | 1 |
| Spoel- & installatiesystemen |  | closetborstelgarnituur wandmodel 0464975 | chrom | 40374000 | stuk | 55,00 | 241 | 1 |
| Badkamermeubelen en toiletkasten |  | closetrolhouder m. klep 0464976 | chrom | 40367000 | stuk | 38,75 | 241 | 1 |
| Gootstenen en wastroggen |  | haak 0464977 | chrom | 40364000 | stuk | 16,25 | 241 | 1 |
| Utiliteit | | | | | | | | |
| | Grohe Sinfonia | | | | | | | |
| |  | glashouder z. glas 0442011 | chrom | 40043000 | stuk | 78,50 | 241 | 1 |
| |  | zeephouder z. zeepschaal 0442038 | chrom | 40045000 | stuk | 78,50 | 241 | 1 |
| |  | handdoekhouder 0442062 60cm | chrom | 40049000 | stuk | 118,00 | 241 | 1 |

| Art.nr | Specificaties | Kleur | Lev.nr | Ehd | Prijs | Grp | CC | | |
|---|---------------|-------|----------|------|--------|-----|----|---|---|
| | | | | | | | | Grohe Sinfonia | |
| 2-lids handdoekhouder 0442054 | | chrom | 40048000 | stuk | 137,00 | 241 | 1 |  | Sanitair producten |
| handdoekring 205mm 0442046 | | chrom | 40047000 | stuk | 76,00 | 241 | 1 |  | Baden / douchebakken / stoomcabines |
| papierhouder 0442097 | | chrom | 40053000 | stuk | 99,00 | 241 | 1 |  | Kranen |
| closetborstelgarnituur 0442100 | | chrom | 40054000 | stuk | 143,00 | 241 | 1 |  | Douchegarnituur |
| handdoekhaak 0442089 | | chrom | 40052000 | stuk | 42,50 | 241 | 1 |  | Accessoires en spiegels |
| inzet voor zeephouder kristalglas 0441066 | | | 40166000 | stuk | 38,25 | 241 | 1 |  | Douchewanden |
| reserveglas voor 40174000 0435567 | | | 40175000 | stuk | 87,50 | 241 | 1 | | Toebehoren & afvoeren |
| reserveborstel voor 40174000 0430080 | | | 40176000 | stuk | 55,50 | 241 | 1 | | Spoel- & installatiesystemen |
| | | | | | | | | Grohe Taron | |
| glashouder z. glas 0443174 | | chrom | 40287000 | stuk | 92,50 | 162 | 1 |  | Badkamermeubelen en toiletkasten |
| zeephouder z. inzet 0443182 | | chrom | 40288000 | stuk | 92,50 | 162 | 1 | | Gootstenen en wastroggen |
| zeepdispenser 0443298 | | chrom | 40289000 | stuk | 183,00 | 162 | 1 |  | Utiliteit |

| | Art.nr | Specificaties | Kleur | Lev.nr | Ehd | Prijs | Grp | CC |
|---|--|--|-------|----------|------|--------|-----|----|
| Sanitair producten | Grohe Tenso | | | | | | | |
| | | handdoekring Ø198mm 0443190 | chrom | 40290000 | stuk | 111,00 | 162 | 1 |
| Baden / douchebakken / stoomcabines |  | | | | | | | |
| Kranen | | 2-lids handdoekhouder 0443204 | chrom | 40291000 | stuk | 130,00 | 162 | 1 |
| |  | | | | | | | |
| Douchegarnituur | | handdoekhouder 60cm 0443212 | chrom | 40292000 | stuk | 199,00 | 162 | 1 |
| |  | | | | | | | |
| Accessoires en spiegels | | closetrolhouder 0443255 | chrom | 40296000 | stuk | 153,00 | 162 | 1 |
| |  | | | | | | | |
| Douchewanden | | closetborstelgarnituur 0443271 | chrom | 40298000 | stuk | 262,00 | 162 | 1 |
| |  | | | | | | | |
| Toebehoren & afvoeren | | haak 0443247 | chrom | 40295000 | stuk | 81,50 | 162 | 1 |
| |  | | | | | | | |
| Spoel- & installatiesystemen | | | | | | | | |
| Badkamermeubelen en toiletkasten | | | | | | | | |
| Gootstenen en wastroggen | | | | | | | | |
| Utiliteit | | | | | | | | |

| Art.nr | Specificaties | Kleur | Lev.nr | Ehd | Prijs | Grp | CC | |
|---|---------------|--------|--------|------|-------|-----|----|---|
| Geesa Standaard | | | | | | | | |
| zeepdispenser wandmodel 0651217 | | RVS | 631 | stuk | 74,50 | 241 | 1 |  |
| badgreep 25cm 0650161 | | chroom | 13225 | stuk | 22,25 | 241 | 0 |  |
| badgreep 30cm 0650163 | | chroom | 13230 | stuk | 23,50 | 241 | 1 | |
| badgreep 30cm verdeckte bevestiging 0651753 | buis 20mm | chroom | 13130 | stuk | 23,50 | 241 | 0 |  |
| 0651822 | buis 24mm | chroom | 12930 | stuk | 26,25 | 241 | 1 | |
| badgreep m. zeephouder 0651752 | | chroom | 128 | stuk | 62,50 | 241 | 1 |  |
| handdoekhouder 60cm 0650078 | buis 20mm | chroom | 13260 | stuk | 30,25 | 241 | 1 |  |
| 0651821 | buis 24mm | chroom | 12960 | stuk | 33,75 | 241 | 1 | |
| handdoekdispenser 0650139 | | | 1221 | stuk | 63,00 | 247 | 1 | |
| closetrolhouder m. klep 0651761 | | chroom | 145 | stuk | 21,50 | 241 | 0 |  |
| reserverolhouder enkel 0651826 | | chroom | 126 | stuk | 21,75 | 241 | 1 |  |
| reserverolhouder dubbel 0651834 | | chroom | 127 | stuk | 23,00 | 241 | 1 |  |
| jas-/handdoekhaak klein 0651788 | | chroom | 2801 | stuk | 5,40 | 241 | 0 |  |

Sanitair producten

Baden /
douchebakken /
stoomcabines

Kranen

Douchegarnituur

Accessoires en
spiegels

Douchewanden

Toebehoren &
afvoeren

Spoel- &
installatiesystemen

Badkamermeubelen
en toiletkasten

Gootstenen en
wastroggen

Utiliteit

| | Art.nr | Specificaties | Kleur | Lev.nr | Ehd | Prijs | Grp | CC |
|---|---------------------------------|--|---------------------------------------|---------|------|-------|-------|-----|
| Sanitair producten | Geesa Standaard | | | | | | | |
| | | jas-/handdoekhaak groot 0651781 | chrom | 2802 | stuk | 11,75 | 241 | 0 |
| Baden / douchebakken / stoomcabines | | tissuehouder wandbevestiging 0650190 | chrom | 121 | stuk | 26,25 | 241 | 1 |
| | Kranen | | | | | | | |
| Douchegarnituur | | afvallemmer wandmodel 3-liter 0650004 | chrom | 624C | stuk | 31,75 | 241 | 0 |
| | Accessoires en spiegels | | pedaalemmer 3-liter 0650022 | chrom | 625C | stuk | 30,00 | 241 |
| Douchewanden | | | | | | | | |
| Toebehoren & afvoeren | | toiletset 0651305 | chrom | 5000105 | stuk | 92,50 | 241 | 1 |
| | Spoel- & installatiesystemen | Geesa Fun E | | | | | | |
| | | closetrolhouder m.houder voor hygienedoekjes 0650309 | chrom | 1130 | stuk | 37,25 | 241 | 1 |
| Badkamermeubelen en toiletkasten | | houder voor hygienedoekjes 0650311 | chrom | 1120 | stuk | 32,00 | 241 | 1 |
| | Gootstenen en wastroggen | | | | | | | |
| Utiliteit | | bekerhouder 0650034 | chrom | 1131 | stuk | 21,00 | 241 | 1 |
| | | zeephouder 0650035 | chrom | 1132 | stuk | 15,75 | 241 | 1 |
| | | zeepdispenser 0650036 | chrom | 1133 | stuk | 31,25 | 241 | 1 |
| | | wattendispenser 0650081 | wit | 1142 | stuk | 17,00 | 241 | 1 |

| Art.nr | Specificaties | Kleur | Lev.nr | Ehd | Prijs | Grp | CC | |
|--|---------------|--------|--------|------|-------|-----|----|---|
| Geesa Fun E | | | | | | | | |
| tandenborstelhouder 0650082 | | wit | 1143 | stuk | 22,00 | 241 | 1 | |
| houder voor elektrische tandenborstel 0650083 | | wit | 1144 | stuk | 20,00 | 241 | 1 | |
| organiser klein 0650037 | | | 1134 | stuk | 23,00 | 241 | 1 |  |
| organiser groot 0650038 | | | 1135 | stuk | 29,25 | 241 | 1 |  |
| closetrolhouder staand 0650039 | | chroom | 1140 | stuk | 26,00 | 241 | 1 |  |
| weegschaal gewicht/vetmeting 0651312 | | | 1141 | stuk | 74,50 | 241 | 1 |  |
| Geesa 2000 | | | | | | | | |
| zeephouder m. kunststof inzet 0650250 | | chroom | 2155 | stuk | 6,90 | 241 | 1 |  |
| zeephouder draadmodel 0650005 | | chroom | 2139 | stuk | 8,70 | 241 | 0 |  |
| closetrolhouder z. klep 0650129 | | chroom | 2146 | stuk | 3,99 | 241 | 0 |  |
| Geesa 5000 | | | | | | | | |
| glas-/tandenborstelhouder m. witte beker 0651052 | | chroom | 5149 | stuk | 25,00 | 241 | 1 |  |
| zeephouder m. kunststof inzet 0650315 | | wit | 5155 | stuk | 21,50 | 241 | 0 |  |

Sanitair producten

Baden /
douchebakken /
stoomcabines

Kranen

Douchegarnituur

Accessoires en
spiegels

Douchewanden









Toebehoren &
afvoeren





Spoel- &
installatiesystemen

Badkamermeubelen
en toiletkasten









Gootstenen en
wastroggen

Utiliteit

| | Art.nr | Specificaties | Kleur | Lev.nr | Ehd | Prijs | Grp | CC |
|---|---|---|--------|--------|------|-------|-----|----|
| | Geesa 5000 | | | | | | | |
| Sanitair producten |  | zeephouder draadmodel 0650242 | chroom | 5139 | stuk | 23,25 | 241 | 0 |
| Baden / douchebakken / stoomcabines |  | zeephouder hoekdraadmodel 0650021 | chroom | 5136 | stuk | 30,50 | 241 | 1 |
| Kranen | | | | | | | | |
| Douchegarnituur | | losse drinkbeker kunststof 0650366 | wit | 5160 | stuk | 2,86 | 241 | 1 |
| | | inzet voor zeephouder kunststof 0650323 | wit | 5154 | stuk | 2,90 | 241 | 0 |
| Accessoires en spiegels |  | wandasbak m. inzet RVS 0650390 | chroom | 5175 | stuk | 24,50 | 241 | 1 |
| Douchewanden | | | | | | | | |
| Toebehoren & afvoeren | | wandasbak m. kantelbare inzet 0650404 | chroom | 5175A | stuk | 31,75 | 241 | 1 |
| | | glasplaat voor planchet 0650447 50cm | | 519350 | stuk | 9,90 | 241 | 1 |
| | | 0650455 60cm | | 519360 | stuk | 10,75 | 241 | 1 |
| Spoel- & installatiesystemen |  | 2-lids handdoekhouder draaibaar buis 0650145 | chroom | 5123 | stuk | 35,50 | 241 | 0 |
| Badkamermeubelen en toiletkasten |  | 2-lids handdoekhouder draaibaar profiel 0650528 | chroom | 5249 | stuk | 39,00 | 241 | 0 |
| Gootstenen en wastroggen |  | handdoekkring 0650536 160mm | chroom | 5251 | stuk | 16,00 | 241 | 1 |
| | | 0650527 200mm | chroom | 5250 | stuk | 18,50 | 241 | 1 |
| Utiliteit | | | | | | | | |
| |  | handdoekhouder 0650072 40cm | chroom | 512140 | stuk | 29,00 | 241 | 1 |
| | | 0650080 50cm | chroom | 512150 | stuk | 29,50 | 241 | 0 |
| | | handdoekhouder 60cm 0650099 | chroom | 512160 | stuk | 31,00 | 241 | 0 |
| |  | handdoekhouder 60cm dubbel 0650374 | chroom | 516560 | stuk | 45,00 | 241 | 1 |
| |  | handdoekhouder 60cm m. slot 0650412 | chroom | 517760 | stuk | 49,25 | 241 | 0 |











| Art.nr | Specificaties | Kleur | Lev.nr | Ehd | Prijs | Grp | CC | | |
|--|---------------|--------|--------|------|-------|-----|----|---|---|
| | | | | | | | | Geesa 5000 | |
| 2-lids washandhouder 0650563 | | chroom | 5257 | stuk | 18,25 | 241 | 1 |  | Sanitair producten |
| badgreep 25cm verstelbaar 0650196 | | chroom | 513225 | stuk | 29,25 | 241 | 1 |  | Baden / douchebakken / stoomcabines |
| badgreep 25cm verstelbaar m. draadzeephouder 0650226 | | chroom | 513425 | stuk | 59,50 | 241 | 1 | | Kranen |
| spons-/zeephouder 0650277 | klein | chroom | 5141 | stuk | 43,50 | 241 | 1 |  | Douchegarnituur |
| 0650269 | groot | chroom | 5140 | stuk | 45,00 | 241 | 1 | | |
| closetrolhouder m. veer 0650293 | | chroom | 5146 | stuk | 18,75 | 241 | 0 |  | Accessoires en spiegels |
| closetrolhouder m. klep 0652792 | | chroom | 5144 | stuk | 25,50 | 241 | 0 |  | Douchewanden |
| closetrolhouder m. reserverolhouder klep RVS 0652793 | | chroom | 5144A | stuk | 34,00 | 241 | 0 |  | Toebehoren & afvoeren |
| closetrolhouder m. reserverolhouder 0650307 | | chroom | 5146A | stuk | 28,75 | 241 | 0 |  | Spoel- & installatiesystemen |
| reserverolhouder voor 5146A 0650325 | | chroom | 5146B | stuk | 10,25 | 241 | 1 |  | Badkamermeubelen en toiletkasten |
| reserverolhouder m. handdoekhaak 0650153 | | chroom | 5125 | stuk | 20,25 | 241 | 1 |  | Gootstenen en wastroggen |
| reserverolhouder voor 1 rol 0651672 | | chroom | 5128 | stuk | 20,50 | 241 | 0 |  | Utiliteit |

| | Art.nr | Specificaties | Kleur | Lev.nr | Ehd | Prijs | Grp | CC |
|---|---|---------------|--------|--------|------|-------|-----|----|
| | Geesa 5000 | | | | | | | |
| | reserverolhouder voor 2 rollen | | | | | | | |
| Sanitair producten | 0651664 | | chroom | 5126 | stuk | 23,00 | 241 | 0 |
| | closetborstelgarnituur m. satin glas | | | | | | | |
| Baden / douchebakken / stoomcabines | 0651842 | | chroom | 5117 | stuk | 42,75 | 241 | 0 |
| | 0650188 | | chroom | 5118 | stuk | 54,00 | 241 | 0 |
| Kranen | closetborstelgarnituur staand | | | | | | | |
| Douchegarnituur | 0651783 | | chroom | 5116 | stuk | 37,50 | 241 | 1 |
| | spiegelhouder 2-stuks draaibaar | | | | | | | |
| Accessoires en spiegels | 0651819 | | chroom | 5282 | stuk | 69,00 | 241 | 1 |
| | handdoekhaak enkel | | | | | | | |
| Douchewanden | 0650552 | | chroom | 5253 | stuk | 8,70 | 241 | 0 |
| | handdoekhaak dubbel | | | | | | | |
| Toebehoren & afvoeren | 0650560 | | chroom | 5254 | stuk | 9,70 | 241 | 0 |
| | 0651796 | | chroom | 5280 | stuk | 14,75 | 241 | 1 |
| Spoel- & installatiesystemen | garderobehaak m. 4 haakjes | | | | | | | |
| Badkamermeubelen en toiletkasten | 0651818 | | chroom | 5281 | stuk | 27,00 | 241 | 1 |
| | 0651680 | | chroom | 5189 | stuk | 20,50 | 241 | 1 |
| Gootstenen en wastroggen | garderobehaak m. 6 haakjes | | | | | | | |
| Utiliteit | 0650439 | | chroom | 5190 | stuk | 21,75 | 241 | 0 |
| | gastendoekkorf | | | | | | | |
| | 0650463 | | chroom | 5174 | stuk | 71,50 | 241 | 1 |
| | handdoekplateau 60x25cm | | | | | | | |
| | 0651745 | | chroom | 5353 | stuk | 73,50 | 241 | 1 |
| | handdoekplateau 60x25cm met handdoekhouder | | | | | | | |
| | 0651702 | | chroom | 5352 | stuk | 89,50 | 241 | 1 |
| | Geesa 6000 | | | | | | | |
| | bekerhouder enkel m. kunststof beker wit | | | | | | | |
| | 0650609 | | chroom | 6138 | stuk | 19,50 | 241 | 1 |













| Art.nr | Specificaties | Kleur | Lev.nr | Ehd | Prijs | Grp | CC | | |
|---|---------------|--------|--------|------|-------|-----|----|---|---|
| Geesa 6000 | | | | | | | | | |
| tandenborstel-/tubehouder 0650617 | | chroom | 6149 | stuk | 13,25 | 241 | 1 |  | Sanitair producten |
| glas-/tandenborstelhouder dubbel m. kunststof beker 0650633 | | chroom | 6164 | stuk | 33,50 | 241 | 1 |  | Baden / douchebakken / stoomcabines |
| beker kunststof 0651133 | | wit | 6160 | stuk | 2,44 | 241 | 1 |  | Kranen |
| Geesa 7000 | | | | | | | | | |
| glashouder enkel m. helder glas 0651265 | | chroom | 7138 | stuk | 17,75 | 241 | 1 |  | Douchegarnituur |
| glashouder dubbel m. helder glas dubbel 0651338 | | chroom | 7163 | stuk | 34,00 | 241 | 1 |  | Accessoires en spiegels |
| glas-/tandenborstelhouder 0653055 | | chroom | 7149 | stuk | 35,75 | 241 | 1 |  | Douchewanden |
| glas-/tandenborstelhouder dubbel m. glazen beker 0651346 | | chroom | 7164 | stuk | 30,00 | 241 | 1 |  | Toebehoren & afvoeren |
| zeepouder staand 0653056 | | chroom | 7151 | stuk | 29,25 | 241 | 1 |  | Spoel- & installatiesystemen |
| zeepouder m. glazen inzet helder 0651281 | | chroom | 7155 | stuk | 29,00 | 241 | 1 |  | Badkamermeubelen en toiletkasten |
| drinkglas recht model helder glas 0653063 | | | 7162 | stuk | 13,75 | 241 | 1 | | Gootstenen en wastroggen |
| drinkglas m. steunrand helder glas 0651311 | | | 7160 | stuk | 2,73 | 241 | 0 | | Utiliteit |

| | Art.nr | Specificaties | Kleur | Lev.nr | Ehd | Prijs | Grp | CC |
|---|--|--|-----------|---------|------|--------|-----|----|
| | Geesa 7000 | | | | | | | |
| Sanitair producten | | inzet voor zeephouder helder glas | | | | | | |
| | 0651273 | | | 7153 | stuk | 11,75 | 241 | 1 |
| | planchet 35cm | | | | | | | |
| Baden / douchebakken / stoomcabines | 0650635 | | chrom | 724835 | stuk | 49,50 | 241 | 1 |
| | planchet 50cm | | | | | | | |
| Kranen | 0650641 | | chrom | 719150 | stuk | 53,00 | 241 | 0 |
| | planchet 60cm | | | | | | | |
| Douchegarnituur | 0650668 | | chrom | 719160 | stuk | 56,00 | 241 | 0 |
| | planchet 60cm m. tandenborstel-tubehouder en glashouder | | | | | | | |
| Accessoires en spiegels | 0650692 | | chrom | 7191A60 | stuk | 104,00 | 241 | 1 |
| | Geesa Argos | | | | | | | |
| | glashouder enkel m. glas | | | | | | | |
| Douchewanden | 0651303 | m. clips matchr+goud | chrom | 800202 | stuk | 22,00 | 241 | 0 |
| | 0652008 | m. clips chr. + goud | matchroom | 800205 | stuk | 22,00 | 241 | 1 |
| | glashouder dubbel | | | | | | | |
| Toebehoren & afvoeren | 0651990 | m. clips chr. + goud | matchroom | 801305 | stuk | 27,75 | 241 | 1 |
| | 0651572 | m. clips matchr+goud | chrom | 801302 | stuk | 27,75 | 241 | 1 |
| | zeephouder m. helderglas inzet | | | | | | | |
| Spool- & installatiesystemen | 0652024 | m. clips chr. + goud | matchroom | 800305 | stuk | 29,50 | 241 | 1 |
| Badkamermeubelen en toiletkasten | 0651354 | m. clips matchr+goud | chrom | 800302 | stuk | 29,50 | 241 | 0 |
| | zeepdispenser | | | | | | | |
| Gootstenen en wastroggen | 0650024 | m. clips chr. + goud | matchroom | 801605 | stuk | 29,50 | 241 | 1 |
| | 0650018 | m. clips matchr+goud | chrom | 801602 | stuk | 29,50 | 241 | 0 |
| | planchet 60cm | | | | | | | |
| Utiliteit | 0652016 | m. clips chr. + goud | matchroom | 800105 | stuk | 36,25 | 241 | 1 |
| | 0651249 | m. clips matchr+goud | chrom | 800102 | stuk | 36,25 | 241 | 0 |
| | hoekplanchet | | | | | | | |
| | 0652121 | m. clips chr. + goud | matchroom | 802105 | stuk | 30,50 | 241 | 1 |
| | 0651583 | m. clips matchr+goud | chrom | 802102 | stuk | 30,50 | 241 | 1 |
| | 2-lids handdoekhouder draaibaar | | | | | | | |
| | 0652040 | m. clips chr. + goud | matchroom | 800505 | stuk | 30,75 | 241 | 1 |
| | 0651389 | m. clips matchr+goud | chrom | 800502 | stuk | 30,75 | 241 | 0 |
| | handdoekring | | | | | | | |
| | 0651362 | m. clips matchr+goud | chrom | 800402 | stuk | 22,25 | 241 | 0 |
| | 0652032 | m. clips chr. + goud | matchroom | 800405 | stuk | 22,25 | 241 | 1 |











| Art.nr | Specificaties | Kleur | Lev.nr | Ehd | Prijs | Grp | CC | | |
|--|----------------------|-----------|---------|------|--------|-----|----|---|---|
| | | | | | | | | Geesa Argos | |
| handdoekhouder 60cm | | | | | | | | | |
| 0652067 | m. clips chr. + goud | matchroom | 800705 | stuk | 36,75 | 241 | 1 |  | Sanitair producten |
| 0651451 | m. clips matchr+goud | chroom | 800702 | stuk | 36,75 | 241 | 1 | | |
| spons-/zeephouder draadmodel | | | | | | | | | |
| 0652059 | m. clips chr. + goud | matchroom | 800605 | stuk | 36,00 | 241 | 1 |  | Baden / douchebakken / stoomcabines |
| 0651419 | m. clips matchr+goud | chroom | 800602 | stuk | 36,00 | 241 | 1 | | |
| closetrolhouder z. klep | | | | | | | | | |
| 0652083 | m. clips chr. + goud | matchroom | 800905 | stuk | 21,00 | 241 | 1 |  | Kranen |
| 0651532 | m. clips matchr+goud | chroom | 800902 | stuk | 21,00 | 241 | 0 | | |
| closetrolhouder m. klep | | | | | | | | | |
| 0652075 | m. clips chr. + goud | matchroom | 800805 | stuk | 29,25 | 241 | 1 |  | Accessoires en spiegels |
| 0651478 | m. clips matchr+goud | chroom | 800802 | stuk | 29,25 | 241 | 0 | | |
| reserverolhouder | | | | | | | | | |
| 0652113 | m. clips chr. + goud | matchroom | 801205 | stuk | 23,25 | 241 | 1 |  | Douchewanden |
| 0651575 | m. clips matchr+goud | chroom | 801202 | stuk | 23,25 | 241 | 0 | | |
| dubbele reserverolhouder | | | | | | | | | |
| 0653330 | | matchroom | 801805 | stuk | 26,25 | 241 | 1 |  | Toebehoren & afvoeren |
| 0653322 | | chroom | 801802 | stuk | 26,25 | 241 | 1 | | |
| kunststof plaatje voor reserverolhouder 8012/8018 | | | | | | | | | |
| 0653349 | | | 80121 | stuk | 2,35 | 241 | 1 | | Gootstenen en wastroggen |
| closetborstelgarnituur | | | | | | | | | |
| 0652091 | m. clips chr. + goud | matchroom | 801005 | stuk | 45,25 | 241 | 1 |  | Utiliteit |
| 0651559 | m. clips matchr+goud | chroom | 801002 | stuk | 45,25 | 241 | 0 | | |
| garderobehaak dubbel | | | | | | | | | |
| 0652105 | m. clips chr. + goud | matchroom | 801105 | stuk | 19,50 | 241 | 1 |  | |
| 0651567 | m. clips matchr+goud | chroom | 801102 | stuk | 19,50 | 241 | 0 | | |
| toiletset m. clips | | | | | | | | | |
| 0650236 | m. clips matchr+goud | chroom | 8000100 | stuk | 108,00 | 241 | 1 | | |
| badkamerset | | | | | | | | | |
| 0650232 | m. clips matchr+goud | chroom | 8000102 | stuk | 136,00 | 241 | 1 | | |





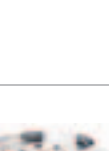

| | Art.nr | Specificaties | Kleur | Lev.nr | Ehd | Prijs | Grp | CC | |
|-------------------------------------|---|---|---|--------|------|-------|-------|-----|---|
| Sanitair producten |  | Geesa Basket Wing zeephouder 0653357 | chrom | 2500 | stuk | 32,00 | 241 | 1 | |
| | Baden / douchebakken / stoomcabines |  | spons-/zeephouder 0653365 | chrom | 2501 | stuk | 42,00 | 241 | 1 |
| Kranen | |  | fles-/sponshouder 0653373 | chrom | 2502 | stuk | 44,25 | 241 | 1 |
| Douchegarnituur |  | zeephouder hoekmodel 0653381 | chrom | 2510 | stuk | 32,00 | 241 | 1 | |
| Accessoires en spiegels | | spons-/zeephouder hoekmodel 0653403 | chrom | 2511 | stuk | 46,50 | 241 | 1 | |
| | Douchewanden |  | fles-/sponshouder hoekmodel 0653411 | chrom | 2512 | stuk | 49,75 | 241 | 1 |
| Toebehoren & afvoeren |  | spons-/zeephouder m. porseleinen inzet 0650040 | chrom | 2505 | stuk | 51,00 | 241 | 1 | |
| Spoel- & installatiesystemen | | inzet porselein los 0650041 | | 25051 | stuk | 9,30 | 241 | 1 | |
| Badkamermeubelen en toiletkasten |  | Geesa Basket sponshouder/zeephouder klein 0652474 | chrom | 151 | stuk | 34,25 | 241 | 1 | |
| Gootstenen en wastroggen | | sponshouder/zeephouder groot 0650169 | chrom | 150 | stuk | 37,75 | 241 | 1 | |
| Utiliteit |  | zeephouder 0650009 | chrom | 139 | stuk | 20,00 | 241 | 1 | |
| | | fles-/sponshouder hoekmodel 0651214 | chrom | 170 | stuk | 54,00 | 241 | 0 | |
| | |  | hoekspouder 0650165 | chrom | 144 | stuk | 36,75 | 241 | 0 |
| | |  | hoekzeephouder 0650249 | chrom | 137 | stuk | 23,75 | 241 | 1 |
| | | | | | | | | | |











| Art.nr | Specificaties | Kleur | Lev.nr | Ehd | Prijs | Grp | CC | | |
|---|---------------|--------|--------|------|--------|-----|----|---|---|
| | | | | | | | | Geesa Basket | |
| draadzeephouder 0650243 | | chroom | 138 | stuk | 26,00 | 241 | 1 |  | Sanitair producten |
| hoekkorf dubbel klein 0652482 | | chroom | 184 | stuk | 65,00 | 241 | 1 |  | Baden / douchebakken / stoomcabines |
| hoekkorf dubbel middel 0650253 | | chroom | 185 | stuk | 68,00 | 241 | 1 |  | Kranen |
| hoekkorf dubbel groot 0650257 | | chroom | 183 | stuk | 99,00 | 241 | 0 |  | Douchegarnituur |
| korf dubbel exclusive 0650248 | | chroom | 250 | stuk | 156,00 | 241 | 1 |  | Accessoires en spiegels |
| hoekkorf dubbel links medium 0650231 | | chroom | 251 | stuk | 96,00 | 241 | 1 |  | Douchewanden |
| hoekkorf dubbel links groot 0650241 | | chroom | 252 | stuk | 126,00 | 241 | 1 |  | Toebehoren & afvoeren |
| korf dubbel 0650239 | | chroom | 253 | stuk | 114,00 | 241 | 1 |  | Spoel- & installatiesystemen |
| hoekkorf dubbel rechts medium 0652490 | | chroom | 254 | stuk | 96,00 | 241 | 1 |  | Badkamermeubelen en toiletkasten |









| | Art.nr | Specificaties | Kleur | Lev.nr | Ehd | Prijs | Grp | CC |
|---|---|--|-------|--------|------|--------|-----|----|
| Sanitair producten | Geesa Basket | | | | | | | |
| | | hoekkorf dubbel rechts groot 0652504 | chrom | 255 | stuk | 126,00 | 241 | 1 |
| Baden / douchebakken / stoomcabines |  | | | | | | | |
| Kranen | hoekplanchet m. helderglasplaat | | | | | | | |
| | | 0650255 | chrom | 194 | stuk | 57,50 | 241 | 1 |
| Douchegarnituur |  | | | | | | | |
| Accessoires en spiegels | bevestigingsset verdekt | | | | | | | |
| | | 0651234 | chrom | 697 | stuk | 3,49 | 241 | 1 |
| Douchewanden |  | | | | | | | |
| Toebehoren & afvoeren | overschuifkap voor hoekmodel | | | | | | | |
| | | 0651111 | chrom | 698 | stuk | 2,35 | 241 | 1 |
| Spoel- & installatiesystemen |  | | | | | | | |
| Badkamermeubelen en toiletkasten | fles/sponshouder | | | | | | | |
| | | 0650010 | chrom | 143 | stuk | 38,00 | 241 | 1 |
| Gootstenen en wastroggen |  | | | | | | | |
| Utiliteit | fles/sponshouder groot model | | | | | | | |
| | | 0650162 | chrom | 140 | stuk | 45,00 | 241 | 0 |
| |  | | | | | | | |
| | fleshouder | | | | | | | |
| | | 0650020 | chrom | 1502 | stuk | 51,50 | 241 | 0 |
| |  | | | | | | | |
| | combikorf klein | | | | | | | |
| | | 0650023 | chrom | 1501 | stuk | 51,50 | 241 | 1 |
| |  | | | | | | | |
| | combikorf groot | | | | | | | |
| | | 0650251 | chrom | 1503 | stuk | 70,00 | 241 | 1 |
| |  | | | | | | | |
| | hoekkorf | | | | | | | |
| | | 0650252 | chrom | 1504 | stuk | 69,50 | 241 | 1 |
| |  | | | | | | | |
| | badkorf groot | | | | | | | |
| | | 0650254 | chrom | 152 | stuk | 70,00 | 241 | 1 |
| |  | | | | | | | |
| | gastendoekkorf | | | | | | | |
| | | 0650523 | chrom | 174 | stuk | 56,50 | 241 | 1 |
| |  | | | | | | | |

| Art.nr | Specificaties | Kleur | Lev.nr | Ehd | Prijs | Grp | CC | | |
|--|---------------|----------------|--------|-----|------------|-----|----|---|---|
| | | | | | | | | Geesa Bloq | |
| glashouder 0650176 | | matglas/chroom | 7002 | | stuk 25,50 | 241 | 1 |  | Sanitair producten |
| zeephouder wandmodel 0650177 | | matglas/chroom | 7003 | | stuk 31,50 | 241 | 1 |  | Baden / douchebakken / stoomcabines |
| draadzeephouder 0650180 | | chroom | 7006 | | stuk 34,75 | 241 | 1 |  | Kranen |
| zeepdispenser 0650189 | | matglas/chroom | 7016 | | stuk 32,50 | 241 | 1 |  | Douchegarnituur |
| planchet 60cm 0650175 | | matglas/chroom | 7001 | | stuk 78,00 | 241 | 1 |  | Accessoires en spiegels |
| ringhanddoekhouder 32cm 0650178 | | chroom | 7004 | | stuk 32,50 | 241 | 1 |  | Douchewanden |
| 2-lids handdoekhouder draaibaar 42cm 0650179 | | chroom | 7005 | | stuk 40,75 | 241 | 1 |  | Toebehoren & afvoeren |
| wandhanddoekhouder 64.5cm 0650181 | | chroom | 7007 | | stuk 39,50 | 241 | 1 |  | Spoel- & installatiesystemen |
| closetrolhouder m. klep 0650182 | | chroom | 7008 | | stuk 30,25 | 241 | 0 |  | Badkamermeubelen en toiletkasten |
| closetrolhouder z. klep 0650183 | | chroom | 7009 | | stuk 22,25 | 241 | 1 |  | Gootstenen en wastroggen |
| reserverolhouder 0650185 | | chroom | 7012 | | stuk 31,50 | 241 | 1 |  | Utiliteit |

| | Art.nr | Specificaties | Kleur | Lev.nr | Ehd | Prijs | Grp | CC |
|---|---|--------------------------------|----------------|---------|------|--------|-----|----|
| Sanitair producten | Geesa Bloq | | | | | | | |
| | | reserverolhouder dubbel | | | | | | |
| | 0650191 | | chroom | 7018 | stuk | 33,75 | 241 | 1 |
| Baden / douchebakken / stoomcabines |  | | | | | | | |
| Kranen | closetborstelgarnituur wandmodel | | | | | | | |
| | | 0650184 | matglas/chroom | 7010 | stuk | 48,75 | 241 | 0 |
| Douchegarnituur |  | | | | | | | |
| Accessoires en spiegels | fles-/sponshouder | | | | | | | |
| | | 0650186 | chroom | 7014 | stuk | 39,50 | 241 | 1 |
| |  | | | | | | | |
| Douchewanden | dubbele jashaak | | | | | | | |
| | | 0650187 | chroom | 7015 | stuk | 15,75 | 241 | 1 |
| |  | | | | | | | |
| Toebehoren & afvoeren | jas/handdoekhaak enkel | | | | | | | |
| | | 0650093 | chroom | 7011 | stuk | 16,00 | 241 | 1 |
| |  | | | | | | | |
| Spoel- & installatiesystemen | toiletset | | | | | | | |
| | | 0651308 | chroom | 7000100 | stuk | 122,00 | 241 | 1 |
| |  | | | | | | | |
| Badkamermeubelen en toiletkasten | Geesa Circles | | | | | | | |
| | | glashouder | | | | | | |
| | 0652954 | | chroom | 600202 | stuk | 64,00 | 241 | 1 |
| |  | | | | | | | |
| Gootstenen en wastroggen | glashouder staand | | | | | | | |
| | | 0650089 | chroom | 603102 | stuk | 27,75 | 241 | 1 |
| |  | | | | | | | |
| Utiliteit | zeephouder | | | | | | | |
| | | 0652962 | chroom | 600302 | stuk | 67,50 | 241 | 1 |
| |  | | | | | | | |
| | zeepschaal staand | | | | | | | |
| | | 0650092 | chroom | 603202 | stuk | 28,25 | 241 | 1 |
| |  | | | | | | | |
| | zeepdispenser staand | | | | | | | |
| | | 0653101 | chroom | 601602 | stuk | 80,00 | 241 | 1 |
| |  | | | | | | | |
| | zeepdispenser wand | | | | | | | |
| | | 0653128 | chroom | 601702 | stuk | 91,50 | 241 | 0 |
| |  | | | | | | | |

| Art.nr | Specificaties | Kleur | Lev.nr | Ehd | Prijs | Grp | CC | | |
|--|---------------|--------|--------|------|--------|-----|----|---|---|
| | | | | | | | | Geesa Circles | |
| zeepdispenser wandmodel 150ml 0650088 | | chroom | 602702 | stuk | 69,00 | 241 | 1 | | Sanitair producten |
| planchet 0652946 | | chroom | 600102 | stuk | 116,00 | 241 | 1 |  | Baden / douchebakken / stoomcabines |
| handdoekhouder 60cm 0652989 | | chroom | 600702 | stuk | 104,00 | 241 | 1 |  | Kranen |
| badgreep 30cm 0652970 | | chroom | 600602 | stuk | 91,00 | 241 | 1 |  | Douchegarnituur |
| closetrolhouder 0652997 | | chroom | 600902 | stuk | 58,00 | 241 | 0 |  | Accessoires en spiegels |
| reserverolhouder 0653020 | | chroom | 601202 | stuk | 51,00 | 241 | 1 |  | Douchewanden |
| closetborstelgarnituur staand 0653004 | | chroom | 601002 | stuk | 67,50 | 241 | 1 |  | Toebehoren & afvoeren |
| closetborstelgarnituur wand 0653012 | | chroom | 601102 | stuk | 72,00 | 241 | 0 | | Spoel- & installatiesystemen |
| jas-/handdoekhaak 3cm 0653039 | | chroom | 601302 | stuk | 14,25 | 241 | 0 |  | Badkamermeubelen en toiletkasten |
| jas-/handdoekhaak 5cm 0653047 | | chroom | 601502 | stuk | 19,75 | 241 | 1 |  | Gootstenen en wastroggen |
| houder voor hygienische zakjes 0650065 | | | 122 | stuk | 14,50 | 241 | 1 | | Utiliteit |
| handdoekring 0650046 | | chroom | 600402 | stuk | 52,50 | 241 | 1 | | |
| 2-lids handdoekhouder 0650047 | | chroom | 600502 | stuk | 64,00 | 241 | 1 | | |
| closetrolhouder m. klep 0650061 | | chroom | 600802 | stuk | 75,50 | 241 | 1 | | |
| handdoekplateau 0650063 | | chroom | 605302 | stuk | 110,00 | 241 | 1 | | |

| | Art.nr | Specificaties | Kleur | Lev.nr | Ehd | Prijs | Grp | CC |
|---|---|--------------------|-------|---------|------|--------|-----|----|
| | Geesa Circles | | | | | | | |
| Sanitair producten | toiletset 0651307 | | chrom | 6000100 | stuk | 194,00 | 241 | 1 |
| | multahaak m. spiegel 0650084 | | chrom | 602402 | stuk | 69,00 | 241 | 1 |
| Baden / douchebakken / stoomcabines | kledinghanger 0650087 | | chrom | 602602 | stuk | 15,00 | 241 | 1 |
| | Geesa Escala | | | | | | | |
| Kranen |  glashouder 0650498 | z. dichte sierring | chrom | 3002 | stuk | 55,00 | 241 | 1 |
| Douchegarnituur |  zeephouder 0650544 | z. dichte sierring | chrom | 3003 | stuk | 58,00 | 241 | 1 |
| Accessoires en spiegels |  zeepdispenser 0652512 | z. sierring | chrom | 3016 | stuk | 58,00 | 241 | 1 |
| Douchewanden |  planchet 60cm 0650420 | z. open sierring | chrom | 3001 | stuk | 78,00 | 241 | 1 |
| Toebehoren & afvoeren |  hoekplanchet 0651648 | z. open sierring | chrom | 3021 | stuk | 64,50 | 241 | 1 |
| Badkamermeubelen en toiletkasten |  2-lids handdoekhouder 0650595 | z. dichte sierring | chrom | 3005 | stuk | 52,00 | 241 | 1 |
| Gootstenen en wastroggen |  handdoekring 0650579 | z. dichte sierring | chrom | 3004 | stuk | 44,25 | 241 | 1 |
| Utiliteit |  handdoekhouder 60cm 0650994 | z. open sierring | chrom | 3007 | stuk | 95,00 | 241 | 1 |
| |  badgreep 30cm 0650935 | z. open sierring | chrom | 3006 | stuk | 85,00 | 241 | 1 |
| |  fles-/sponshouder 0651591 | z. dichte sierring | chrom | 3013 | stuk | 71,50 | 241 | 1 |

| Art.nr | Specificaties | Kleur | Lev.nr | Ehd | Prijs | Grp | CC | |
|--|---------------------------|-----------|--------|------|-------|-----|----|---|
| Geesa Escala | | | | | | | | |
| closetrolhouder 0651028 | z. dichte sierring | chroom | 3008 | stuk | 51,00 | 241 | 1 |  |
| reserverolhouder 0651044 | z. dichte sierring | chroom | 3009 | stuk | 51,50 | 241 | 1 |  |
| closetborstelgarnituur 0651060 | z. dichte sierring | chroom | 3010 | stuk | 81,00 | 241 | 1 |  |
| jas-/handdoekhaak 0651605 | enkel z. dichte sierring | chroom | 3014 | stuk | 32,25 | 241 | 1 |  |
| 0651621 | dubbel z. dichte sierring | chroom | 3015 | stuk | 33,50 | 241 | 1 | |
| sierring 0651095 | dicht per stuk | chroom | 3031 | stuk | 3,03 | 241 | 1 |  |
| 0651117 | dicht per stuk | goud | G3031 | stuk | 4,79 | 241 | 1 | |
| 0650074 | dicht per stuk | matchroom | S3031 | stuk | 4,79 | 241 | 1 | |
| 0651087 | open per paar | chroom | 3030 | paar | 6,00 | 241 | 1 | |
| 0651109 | open per paar | goud | G3030 | paar | 9,50 | 241 | 1 | |
| 0650073 | open per paar | matchroom | S3030 | stuk | 9,50 | 241 | 1 | |
| 0650103 | open per paar | chroom | 3032 | stuk | 3,28 | 241 | 1 | |
| 0652571 | open per paar | matchroom | S3032 | stuk | 5,10 | 241 | 1 | |
| 0651118 | open per paar | goud | G3032 | stuk | 5,10 | 241 | 1 | |
| Geesa Luna | | | | | | | | |
| glashouder m. glas 0653152 | | chroom | 5502 | stuk | 19,75 | 241 | 1 |  |
| zeepouder m. inzet 0653160 | | chroom | 5503 | stuk | 28,50 | 241 | 1 |  |
| spons-/zeepouder 0653195 | | chroom | 5506 | stuk | 32,50 | 241 | 1 |  |

Sanitair producten

Baden /
douchebakken /
stoomcabines

Kranen

Douchegarnituur

Accessoires en
spiegels

Douchewanden













Toebehoren &
afvoeren









Spoel- &
installatiesystemen

Badkamermeubelen
en toiletkasten

Gootstenen en
wastroggen

Utiliteit

| | Art.nr | Specificaties | Kleur | Lev.nr | Ehd | Prijs | Grp | CC |
|---|---|---|-------------|--------|------|-------|-----|----|
| | Geesa Luna | | | | | | | |
| Sanitair producten | | zeepdispenser 0653241 | chroom | 5516 | stuk | 29,00 | 241 | 0 |
| |  | | | | | | | |
| Baden / douchebakken / stoomcabines | | planchet 60cm 0653144 | chroom | 5501 | stuk | 42,50 | 241 | 1 |
| |  | | | | | | | |
| Kranen | | hoekplanchet 0653268 | glas/chroom | 5521 | stuk | 38,00 | 241 | 1 |
| |  | | | | | | | |
| Douchegarnituur | | handdoekring 0653179 | chroom | 5504 | stuk | 21,00 | 241 | 1 |
| |  | | | | | | | |
| Accessoires en spiegels | | 2-lids handdoekhouder 0653187 | chroom | 5505 | stuk | 38,25 | 241 | 0 |
| |  | | | | | | | |
| Douchewanden | | handdoekhouder 45cm 0653292 | chroom | 552945 | stuk | 32,50 | 241 | 1 |
| |  | | | | | | | |
| Toebehoren & afvoeren | | handdoekhouder 60cm 0653306 | chroom | 552960 | stuk | 37,25 | 241 | 1 |
| |  | | | | | | | |
| Spoel- & installatiesystemen | | handdoekplateau m. rek 0653314 | chroom | 5552 | stuk | 86,00 | 241 | 1 |
| |  | | | | | | | |
| Badkamermeubelen en toiletkasten | | handdoekplateau z. rek 0653136 | chroom | 5553 | stuk | 71,00 | 241 | 1 |
| |  | | | | | | | |
| Gootstenen en wastroggen | | badgreep m. zeephouder 0653276 | chroom | 5528 | stuk | 60,50 | 241 | 1 |
| |  | | | | | | | |
| Utiliteit | | badgreep 30cm 0653284 | chroom | 552930 | stuk | 27,75 | 241 | 1 |
| |  | | | | | | | |
| | | closetrolhouder m. klep 0653209 | chroom | 5508 | stuk | 25,50 | 241 | 0 |
| |  | | | | | | | |
| | | closetrolhouder z. klep 0650044 | chroom | 5509 | stuk | 21,50 | 241 | 1 |

| Art.nr | Specificaties | Kleur | Lev.nr | Ehd | Prijs | Grp | CC | | |
|---|---------------|-------------|---------|------|--------|-----|----|---|---|
| | | | | | | | | Geesa Luna | |
| reserverolhouder 0653225 | | chroom | 5512 | stuk | 21,00 | 241 | 1 |  | Sanitair producten |
| reserverolhouder dubbel 0650045 | | chroom | 5518 | stuk | 28,50 | 241 | 1 | | Baden / douchebakken / stoomcabines |
| closetborstelgarnituur 0653217 | | chroom | 5510 | stuk | 41,75 | 241 | 0 |  | Kranen Douchegarnituur |
| jashaak dubbel 0653233 | | chroom | 5515 | stuk | 14,50 | 241 | 0 |  | Accessoires en spiegels |
| toiletset compleet 0650229 | | chroom | 5500100 | stuk | 97,50 | 241 | 1 | | Douchewanden |
| badkamerset compleet 0650230 | | chroom | 5500102 | stuk | 122,00 | 241 | 1 | | Toebehoren & afvoeren |
| | | | | | | | | Geesa Montana | |
| glashouder m. mat glas 0651869 | z. cupje | chroom | 900202 | stuk | 43,25 | 241 | 1 |  | Spoel- & installatiesystemen |
| 0652156 | z. cupje | chroom/goud | 900204 | stuk | 43,25 | 241 | 1 | | |
| glas-/tandenborstelhouder m. mat glas 0651877 | z. cupje | chroom | 902202 | stuk | 55,50 | 241 | 1 |  | Badkamermeubelen en toiletkasten |
| 0652164 | z. cupje | chroom/goud | 902204 | stuk | 55,50 | 241 | 1 | | |
| zeephouder m. mat inzet 0651885 | z. cupje | chroom | 900302 | stuk | 44,00 | 241 | 1 |  | Gootstenen en wastroggen |
| 0652172 | z. cupje | chroom/goud | 900304 | stuk | 44,00 | 241 | 1 | | |
| spons/zeephouder 0651984 | z. cupje | chroom | 901402 | stuk | 54,50 | 241 | 1 |  | Utiliteit |
| 0652298 | z. cupje | chroom/goud | 901404 | stuk | 54,50 | 241 | 1 | | |
| zeepdispenser 0651986 | z. cupje | chroom | 901602 | stuk | 45,50 | 241 | 1 |  | |
| 0652300 | z. cupje | chroom/goud | 901604 | stuk | 45,50 | 241 | 1 | | |
| planchet 60cm 0651850 | z. cupje | chroom | 900102 | stuk | 87,50 | 241 | 1 |  | |
| 0652148 | z. cupje | chroom/goud | 900104 | stuk | 87,50 | 241 | 1 | | |

| Art.nr | Specificaties | Kleur | Lev.nr | Ehd | Prijs | Grp | CC |
|--------|---------------|-------|--------|-----|-------|-----|----|
|--------|---------------|-------|--------|-----|-------|-----|----|

Geesa Montana

spiegelhouders per paar

| | | | | | | | |
|---------|----------|-------------|--------|------|-------|-----|---|
| 0651982 | z. cupje | chroom | 901302 | paar | 71,00 | 241 | 1 |
| 0652296 | z. cupje | chroom/goud | 901304 | paar | 71,00 | 241 | 1 |



Sanitair producten

Baden /
douchebakken /
stoomcabines

2-lids handdoekhouder

| | | | | | | | |
|---------|----------|-------------|--------|------|-------|-----|---|
| 0651907 | z. cupje | chroom | 900502 | stuk | 59,00 | 241 | 1 |
| 0652202 | z. cupje | chroom/goud | 900504 | stuk | 59,00 | 241 | 1 |



Kranen

handdoekring

| | | | | | | | |
|---------|----------|-------------|--------|------|-------|-----|---|
| 0651893 | z. cupje | chroom | 900402 | stuk | 35,25 | 241 | 1 |
| 0652180 | z. cupje | chroom/goud | 900404 | stuk | 35,25 | 241 | 1 |



Douchegarnituur

Accessoires en
spiegels

handdoekhouder

| | | | | | | | |
|--------------|----------|-------------|--------|------|-------|-----|---|
| 0651923 60cm | z. cupje | chroom | 900702 | stuk | 81,50 | 241 | 1 |
| 0652237 60cm | z. cupje | chroom/goud | 900704 | stuk | 81,50 | 241 | 1 |



Douchewanden

badgreep

| | | | | | | | |
|--------------|----------|-------------|--------|------|-------|-----|---|
| 0651915 30cm | z. cupje | chroom | 900602 | stuk | 72,50 | 241 | 1 |
| 0652229 30cm | z. cupje | chroom/goud | 900604 | stuk | 72,50 | 241 | 1 |

Toebehoren &
afvoeren

closetrolhouder m. klep

| | | | | | | | |
|---------|----------|-------------|--------|------|-------|-----|---|
| 0651931 | z. cupje | chroom | 900802 | stuk | 49,00 | 241 | 1 |
| 0652245 | z. cupje | chroom/goud | 900804 | stuk | 49,00 | 241 | 1 |



Spoel- &
installatiesystemen

Badkamermeubelen
en toiletkasten

reserverolhouder

| | | | | | | | |
|---------|----------|-------------|--------|------|-------|-----|---|
| 0651974 | z. cupje | chroom | 901202 | stuk | 33,50 | 241 | 1 |
| 0652288 | z. cupje | chroom/goud | 901204 | stuk | 33,50 | 241 | 1 |



Gootstenen en
wastroggen

closetborstelgarnituur m. deksel

| | | | | | | | |
|---------|----------|-------------|--------|------|-------|-----|---|
| 0651958 | z. cupje | chroom | 901002 | stuk | 70,50 | 241 | 1 |
| 0652253 | z. cupje | chroom/goud | 901004 | stuk | 70,50 | 241 | 1 |



Utiliteit

jas-/handdoekhaak dubbel

| | | | | | | | |
|---------|----------|-------------|--------|------|-------|-----|---|
| 0651966 | z. cupje | chroom | 901102 | stuk | 31,00 | 241 | 1 |
| 0652261 | z. cupje | chroom/goud | 901104 | stuk | 31,00 | 241 | 1 |



cupje











| | | | | | | | |
|---------|-------------------|-----------|--------|------|------|-----|---|
| 0650192 | voor Classic/Nova | matchroom | 907105 | stuk | 2,48 | 241 | 1 |
| 0651096 | voor Classic/Nova | chroom | 907102 | stuk | 2,48 | 241 | 0 |
| 0651557 | voor Classic/Nova | notenhout | 907107 | stuk | 6,10 | 241 | 1 |
| 0651553 | voor Classic/Nova | beuken | 907103 | stuk | 6,10 | 241 | 1 |









Geesa Montana Nova









glashouder m. glas











| | | | | | | | |
|---------|----------|--------|--------|------|-------|-----|---|
| 0650014 | z. cupje | chroom | 950202 | stuk | 43,25 | 241 | 1 |
|---------|----------|--------|--------|------|-------|-----|---|



| Art.nr | Specificaties | Kleur | Lev.nr | Ehd | Prijs | Grp | CC | | |
|---|---------------|---------|--------|------|-------|-----|----|---|---|
| | | | | | | | | Geesa Montana Nova | |
| glas-/tandenborstelhouder m. glas 0650031 | z. cupje | chr/chr | 952202 | stuk | 55,50 | 241 | 1 |  | Sanitair producten |
| zeephouder m. inzet 0650015 | z. cupje | chrom | 950302 | stuk | 44,00 | 241 | 1 |  | Baden / douchebakken / stoomcabines |
| zeepdispenser 0650076 | z. cupje | chrom | 951602 | stuk | 45,50 | 241 | 1 |  | Kranen |
| planchet 60cm 0650059 | z. cupje | chrom | 950102 | stuk | 87,50 | 241 | 1 |  | Douchegarnituur |
| spiegelhouder per paar 0650085 | z. cupje | chrom | 951302 | stuk | 71,00 | 241 | 1 |  | Accessoires en spiegels |
| 2-lids handdoekhouder 0651558 | z. cupje | chrom | 950502 | stuk | 59,00 | 241 | 1 |  | Douchewanden |
| handdoekring 0650060 | z. cupje | chrom | 950402 | stuk | 35,25 | 241 | 0 |  | Toebehoren & afvoeren |
| handdoekhouder 60cm 0651570 | z. cupje | chrom | 950702 | stuk | 81,50 | 241 | 1 |  | Spoel- & installatiesystemen |
| badgreep 30cm 0651560 | z. cupje | chrom | 950602 | stuk | 72,50 | 241 | 1 |  | Badkamermeubelen en toiletkasten |
| spons-/zeephouder 0650090 | z. cupje | chrom | 951402 | stuk | 54,50 | 241 | 1 |  | Gootstenen en wastroggen |
| closetrolhouder m. klep 0650043 | z. cupje | chrom | 950802 | stuk | 49,00 | 241 | 0 |  | Utiliteit |

| | Art.nr | Specificaties | Kleur | Lev.nr | Ehd | Prijs | Grp | CC |
|---|---|--|----------|--------|---------|-------|--------|-------|
| | Geesa Montana Nova | | | | | | | |
| Sanitair producten |  | reserverolhouder 0650075 | z. cupje | chroom | 951202 | stuk | 33,50 | 241 0 |
| Baden / douchebakken / stoomcabines | | | | | | | | |
| Kranen |  | closetborstelgarnituur 0650049 | z. cupje | chroom | 951002 | stuk | 70,50 | 241 0 |
| Douchegarnituur | | | | | | | | |
| Accessoires en spiegels |  | jashaak dubbel 0651551 | z. cupje | chroom | 951102 | stuk | 31,00 | 241 0 |
| Douchewanden | | | | | | | | |
| | | toiletset 0650233 | m. cupje | chroom | 9500100 | stuk | 171,00 | 241 1 |
| | | badkamerset 0650235 | m. cupje | chroom | 9500102 | stuk | 219,00 | 241 1 |
| Toebehoren & afvoeren | Geesa Nexx | | | | | | | |
| |  | glashouder 0650101 | | chroom | 750202 | stuk | 47,75 | 241 1 |
| Spoel- & installatiesystemen | | | | | | | | |
| Badkamermeubelen en toiletkasten |  | zeepschaal 0650111 | | chroom | 750302 | stuk | 47,75 | 241 1 |
| Gootstenen en wastroggen | | | | | | | | |
| Utiliteit |  | zeepdispenser 0650068 | | chroom | 751602 | stuk | 69,00 | 241 1 |
| |  | planchet 0650100 | | chroom | 750102 | stuk | 85,00 | 241 1 |
| |  | handdoekring 0650112 | | chroom | 750402 | stuk | 53,50 | 241 1 |

| Art.nr | Specificaties | Kleur | Lev.nr | Ehd | Prijs | Grp | CC | | |
|--|---------------|--------|--------|------|-------|-----|----|---|---|
| | | | | | | | | Geesa Nexx | |
| 2-lids handdoekhouder 0650114 | | chroom | 750502 | stuk | 51,00 | 241 | 1 |  | Sanitair producten |
| badgreep 0650116 | | chroom | 750602 | stuk | 74,50 | 241 | 1 |  | Baden / douchebakken / stoomcabines |
| handdoekhouder 0650117 | | chroom | 750702 | stuk | 80,00 | 241 | 1 |  | Kranen |
| closetrolhouder m. klep 0650119 | | chroom | 750802 | stuk | 61,50 | 241 | 1 |  | Douchegarnituur |
| closetrolhouder z. klep 0650120 | | chroom | 750902 | stuk | 42,50 | 241 | 1 |  | Accessoires en spiegels |
| closetborstelgarnituur 0650121 | | chroom | 751002 | stuk | 66,00 | 241 | 1 |  | Douchewanden |
| handdoekhaak enkel 0650122 | | chroom | 751102 | stuk | 17,00 | 241 | 1 |  | Toebehoren & afvoeren |
| handdoekhaak dubbel 0650067 | | chroom | 751502 | stuk | 32,00 | 241 | 1 |  | Spoel- & installatiesystemen |
| fles-/sponshouder m. plaat 0650066 | | chroom | 751402 | stuk | 85,00 | 241 | 1 |  | Badkamermeubelen en toiletkasten |
| | | | | | | | | | Gootstenen en wastroggen |
| | | | | | | | | | Utiliteit |

| | Art.nr | Specificaties | Kleur | Lev.nr | Ehd | Prijs | Grp | CC |
|---|---|---|-----------------------|--------|--------|-------|-------|-------|
| Sanitair producten | Geesa Rodano | | | | | | | |
| |  | glashouder enkel m. glas 0652628 | m. kap chr. + matchr. | chroom | 400202 | stuk | 20,00 | 241 1 |
| Baden / douchebakken / stoomcabines |  | glashouder dubbel 0652725 | m. kap chr. + matchr. | chroom | 401302 | stuk | 25,00 | 241 1 |
| Kranen |  | glas/tandenborstelhouder 0652741 | m. kap chr. + matchr. | chroom | 402202 | stuk | 23,75 | 241 1 |
| Douchegarnituur |  | zeephouder m. inzet 0652636 | m. kap chr. + matchr. | chroom | 400302 | stuk | 26,75 | 241 1 |
| Accessoires en spiegels |  | zeephouder draadmodel 0652660 | m. kap chr. + matchr. | chroom | 400602 | stuk | 31,25 | 241 1 |
| Douchewanden |  | zeepdispenser 0652733 | m. kap chr. + matchr. | chroom | 401602 | stuk | 33,75 | 241 1 |
| Toebehoren & afvoeren |  | planchet 60cm 0652601 | m. kap chr. + matchr. | chroom | 400102 | stuk | 35,25 | 241 1 |
| Spoel- & installatiesystemen |  | 2-lids handdoekhouder draaibaar 0652652 | m. kap chr. + matchr. | chroom | 400502 | stuk | 35,25 | 241 1 |
| Badkamermeubelen en toiletkasten |  | handdoekring 0652644 | m. kap chr. + matchr. | chroom | 400402 | stuk | 20,00 | 241 1 |
| Gootstenen en wastroggen |  | handdoekhouder 60cm 0652679 | m. kap chr. + matchr. | chroom | 400702 | stuk | 30,00 | 241 1 |
| Utiliteit | | | | | | | | |

| Art.nr | Specificaties | Kleur | Lev.nr | Ehd | Prijs | Grp | CC |
|---|-----------------------|----------------|---------|------|--------|-----|----|
| Geesa Rodano | | | | | | | |
| closetrolhouder m. klep 0652687 | m. kap chr. + matchr. | chroom | 400802 | stuk | 24,75 | 241 | 0 |
| closetborstelgarnituur 0652695 | m. kap chr. + matchr. | chroom | 401002 | stuk | 35,75 | 241 | 0 |
| reserverolhouder 0652717 | m. kap chr. + matchr. | chroom | 401202 | stuk | 23,00 | 241 | 1 |
| jas/handdoekhaak enkel 0652709 | m. kap chr. + matchr. | chroom | 401102 | stuk | 13,00 | 241 | 0 |
| toiletset chroom 0650227 | | chroom/matchr. | 4000100 | stuk | 88,00 | 241 | 1 |
| badkamerset chroom 0650228 | | chroom/matchr. | 4000102 | stuk | 112,00 | 241 | 1 |



Sanitair producten

Baden /
douchebakken /
stoomcabines



Kranen

Douchegarnituur



Accessoires en
spiegels

Douchewanden













Toebehoren &
afvoeren











Spoel- &
installatiesystemen

Badkamermeubelen
en toiletkasten

Gootstenen en
wastroggen

Utiliteit

| | Art.nr | Specificaties | Kleur | Lev.nr | Ehd | Prijs | Grp | CC |
|---|---|---|----------------|----------------------|--------------|------------------|------------|--------|
| Sanitair producten | Gessi Mania | | | | | | | |
| |  | glashouder m. glas 0691585 | chrom | 14007031 | stuk | 85,50 | 169 | 1 |
| Baden / douchebakken / stoomcabines |  | glashouder staand 0463148 | chrom | 14031031 | stuk | 72,50 | 169 | 1 |
| Kranen |  | zeephouder 0691577 | chrom | 14001031 | stuk | 79,00 | 169 | 1 |
| Douchegarnituur |  | zeepschaalhouder staand 0463147 | chrom | 14025031 | stuk | 71,00 | 169 | 1 |
| Accessoires en spiegels |  | zeepdispenser compleet 0691593 | chrom | 14013031 | stuk | 158,00 | 169 | 1 |
| Douchewanden |  | zeepdispenser z. houder 0691712 | chrom | 14163031 | stuk | 79,50 | 169 | 1 |
| Toebehoren & afvoeren |  | zeepdispenser staand 0463149 | chrom | 14037031 | stuk | 149,00 | 169 | 1 |
| Spoel- & installatiesystemen |  | planchet 60cm 0691690 | chrom | 14145031 | stuk | 243,00 | 169 | 1 |
| Badkamermeubelen en toiletkasten |  | wandlamp 0691704 | chrom | 14187031 | stuk | 308,00 | 169 | 1 |
| Gootstenen en wastroggen |  | handdoekhouder 0463156 45cm 0691658 60cm | chrom chrom | 14100031 14103031 | stuk stuk | 111,00 115,00 | 169 169 | 1 1 |
| Utiliteit |  | 2-lids handdoekhouder 0691674 | chrom | 14115031 | stuk | 145,00 | 169 | 1 |

| Art.nr | Specificaties | Kleur | Lev.nr | Ehd | Prijs | Grp | CC | |
|--|---------------|--------|----------|------|--------|-----|----|---|
| | | | | | | | | Gessi Mania |
| handdoekring 0691666 | | chroom | 14109031 | stuk | 90,50 | 169 | 1 |  |
| badgreep 30cm 0691631 | | chroom | 14097031 | stuk | 106,00 | 169 | 1 |  |
| closetrolhouder m. klep 0691615 | | chroom | 14049031 | stuk | 134,00 | 169 | 1 |  |
| closetrolhouder z. klep 0691623 | | chroom | 14055031 | stuk | 76,50 | 169 | 1 |  |
| closetborstelgarnituur wandmodel 0691607 | | chroom | 14019031 | stuk | 135,00 | 169 | 1 |  |
| closetborstelgarnituur staand model 0463150 | | chroom | 14043031 | stuk | 128,00 | 169 | 1 |  |
| haak 0691682 | | chroom | 14121031 | stuk | 57,00 | 169 | 1 |  |
| wandset m. toiletrolhouder en closetborstelgarnituur 0463151 | | chroom | 14067031 | stuk | 317,00 | 169 | 1 |  |
| wandset m. handdoekhouder en zeepschaal 0463152 | | chroom | 14073031 | stuk | 282,00 | 169 | 1 |  |
| wandset m. zeepdispenser en handdoekhouder 0463153 | | chroom | 14079031 | stuk | 352,00 | 169 | 1 |  |

Sanitair producten

Baden /
douchebakken /
stoomcabines

Kranen

Douchegarnituur

Accessoires en
spiegels

Douchewanden







Toebehoren &
afvoeren











Spoel- &
installatiesystemen

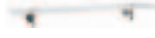



Badkamermeubelen
en toiletkasten



































































Gootstenen en
wastroggen









Utiliteit

| | Art.nr | Specificaties | Kleur | Lev.nr | Ehd | Prijs | Grp | CC |
|---|---|--|--------|----------|------|--------|-----|----|
| | Gessi Mania | | | | | | | |
| Sanitair producten | | wandset m. zeepschaal m. glas m. handdoekhouder 0463154 | chroom | 14085031 | stuk | 342,00 | 169 | 1 |
| Baden / douchebakken / stoomcabines |  | | | | | | | |
| Kranen | | wandset m. glashouder en zeepdispenser m. handdoekhouder 0463155 | chroom | 14091031 | stuk | 418,00 | 169 | 1 |
| Douchegarnituur |  | | | | | | | |
| Accessoires en spiegels | | staand set m. zeepschaal m. closetborstel m. toiletrolhouder m. handdoekhouder 0463157 | chroom | 14127031 | stuk | 487,00 | 169 | 1 |
| Douchewanden |  | | | | | | | |
| Toebehoren & afvoeren | | staand set met closetborstel en closetrolhouder 0463158 | chroom | 14133031 | stuk | 383,00 | 169 | 1 |
| Spoel- & installatiesystemen |  | | | | | | | |
| Badkamermeubelen en toiletkasten | | handdoekhouder staand model 0463160 | chroom | 14139031 | stuk | 412,00 | 169 | 1 |
| Gootstenen en wastroggen |  | | | | | | | |
| Utiliteit | | wandverlichting 0463161 | chroom | 14190031 | stuk | 710,00 | 169 | 1 |
| |  | | | | | | | |
| | Gessi Minix | | | | | | | |
| | | glashouder m. glas 0691380 | chroom | 15507031 | stuk | 114,00 | 169 | 0 |
| |  | | | | | | | |
| | | glashouder staand 0463163 | chroom | 15531031 | stuk | 104,00 | 169 | 1 |
| |  | | | | | | | |
| | | zeephouder 0691372 | chroom | 15501031 | stuk | 106,00 | 169 | 1 |
| |  | | | | | | | |

| Art.nr | Specificaties | Kleur | Lev.nr | Ehd | Prijs | Grp | CC | | |
|---|---------------|------------------|----------------------|--------------|------------------|------------|--------|---|---|
| | | | | | | | | Gessi Minix | |
| zeepschaalhouder staand 0463162 | | chroom | 15525031 | stuk | 95,50 | 169 | 1 |  | Sanitair producten |
| zeepdispenser 0691399 | | chroom | 15513031 | stuk | 202,00 | 169 | 0 |  | Baden / douchebakken / stoomcabines |
| zeepdispenser staand 0463164 | | chroom | 15537031 | stuk | 195,00 | 169 | 1 |  | Kranen |
| planchet 60cm 0691496 | | chroom | 15645031 | stuk | 232,00 | 169 | 1 |  | Douchegarnituur |
| 2-lids handdoekhouder 0691461 | | chroom | 15615031 | stuk | 184,00 | 169 | 0 |  | Accessoires en spiegels |
| handdoekring 0691453 | | chroom | 15609031 | stuk | 129,00 | 169 | 1 |  | Douchewanden |
| handdoekhouder 0463172 45cm 0691445 60cm | | chroom chroom | 15600031 15603031 | stuk stuk | 149,00 156,00 | 169 169 | 1 1 |  | Toebehoren & afvoeren |
| badgreep 30cm 0691437 | | chroom | 15597031 | stuk | 142,00 | 169 | 1 | | Spoel- & installatiesystemen |
| closetrolhouder 0691410 | | chroom | 15549031 | stuk | 158,00 | 169 | 0 |  | Badkamermeubelen en toiletkasten |
| closetborstelgarnituur 0691402 | | chroom | 15519031 | stuk | 161,00 | 169 | 0 |  | Gootstenen en wastroggen |
| closetborstelgarnituur staand 0463165 | | chroom | 15543031 | stuk | 158,00 | 169 | 1 |  | Utiliteit |
| kledinghaak dubbel 0691488 | | chroom | 15621031 | stuk | 86,00 | 169 | 0 |  | |

| | Art.nr | Specificaties | Kleur | Lev.nr | Ehd | Prijs | Grp | CC |
|---|---|---|--------|----------|------|--------|-----|----|
| Sanitair producten | Gessi Minix | | | | | | | |
| | reserverolhouder | | | | | | | |
| |  | 0691429 | chroom | 15555031 | stuk | 101,00 | 169 | 1 |
| Baden / douchebakken / stoomcabines | pedaalemmer | | | | | | | |
| |  | 0691518 | chroom | 14181031 | stuk | 125,00 | 169 | 1 |
| Kranen | wandset m. handdoekhouder m. zeepschaal | | | | | | | |
| Douchegarnituur |  | 0463168 | chroom | 15573031 | stuk | 336,00 | 169 | 1 |
| | wandset m. zeepdispenser m. handdoekhouder | | | | | | | |
| Accessoires en spiegels |  | 0463169 | chroom | 15579031 | stuk | 426,00 | 169 | 1 |
| | Douchewanden | wandset m. zeepschaal m. glas m. handdoekhouder | | | | | | |
| Toebehoren & afvoeren |  | 0463170 | chroom | 15585031 | stuk | 399,00 | 169 | 1 |
| | Spoel- & installatiesystemen | wandset m. glashouder m. zeepdispenser m. handdoekhouder | | | | | | |
| Badkamermeubelen en toiletkasten |  | 0463171 | chroom | 15591031 | stuk | 489,00 | 169 | 1 |
| | Gootstenen en wastroggen | Staannd model m. zeepschaal m. closetborstel / -houder m. handdoekhouder | | | | | | |
| Utiliteit |  | 0463173 | chroom | 15627031 | stuk | 617,00 | 169 | 1 |
| | staannd model m. closetborstel m. closetrolhouder | | | | | | | |
| |  | 0463174 | chroom | 15633031 | stuk | 481,00 | 169 | 1 |
| | handdoekhouder staand model | | | | | | | |
| |  | 0463176 | chroom | 15639031 | stuk | 498,00 | 169 | 1 |

| Art.nr | Specificaties | Kleur | Lev.nr | Ehd | Prijs | Grp | CC | | | | | | | | | | | | | | | | | | | | | | | | | | | | | | | | | | | | | | | | | | | | | | | | | | | | | | | | | | | | | | | | | | | | | | | | | | | | | | | | | | | | | | | | | | | | | | | | | | | | | | | | | | | | | | | | | | | | | | | | | | | | | | | | | | | | | | | | | | | | | | | | | | | | | | | | | | | | | | | | | | | | | | | | | | | | | | | | | | | | | | | | | | | | | | | | | | | | | | | | | | | | | | | | | | | | | | | | | | | | | | | | | | | | | | | | | | | | | | | | | | | | | | | | | | | | | | | | | | | | | | | | | | | | | | | | | | | | | | | | |
|---------------------------------|----------------|-----------------|------------|------|--------|-----|----|---|---|--------------------------------|--|--|--|--|--|--|--|--|--|---------|----------------|------------|---------|------|--------|-----|---|---|---|---------|----------------|-----------------|------------|------|--------|-----|---|--------------------------------|--|--|--|--|--|--|--|--|--|---------|----------------|--------|---------|------|--------|-----|---|---|-------------------------------------|---------|----------------|-------------|------------|------|--------|-----|---|--------------------------------|--|--|--|--|--|--|--|--|--|---------|----------------|--------|---------|------|--------|-----|---|---|-------------------------------------|---------|----------------|-------------|------------|------|--------|-----|---|--------------------------------|--|--|--|--|--|--|--|--|--|---------|----------------|--------|---------|------|--------|-----|---|---|-------------------------------------|---------|----------------|-------------|------------|------|--------|-----|---|--------------------------------|--|--|--|--|--|--|--|--|--|---------|----------------|--------|---------|------|--------|-----|---|---|-------------------------------------|---------|----------------|-------------|------------|------|--------|-----|---|--------------------------------|--|--|--|--|--|--|--|--|--|---------|----------------|--------|---------|------|--------|-----|---|---|-------------------------------------|---------|----------------|-------------|------------|------|--------|-----|---|--------------------------------|--|--|--|--|--|--|--|--|--|---------|----------------|--------|---------|------|--------|-----|---|---|-----------------------------|---------|----------------|-------------|------------|------|--------|-----|---|--------------------------------|--|--|--|--|--|--|--|--|--|---------|----------------|--------|---------|------|--------|-----|---|---|-----------|---------|----------------|-------------|------------|------|--------|-----|---|--------------------------------|--|--|--|--|--|--|--|--|--|---------|---------|--------|---------|------|--------|-----|---|---|--|---------|---------|-------------|------------|------|--------|-----|---|------------------------|--|--|--|--|--|--|--|--|--|---------|---------|--------|---------|------|--------|-----|---|---|--|---------|---------|-------------|------------|------|--------|
| | | | | | | | | Gessi Natura | | | | | | | | | | | | | | | | | | | | | | | | | | | | | | | | | | | | | | | | | | | | | | | | | | | | | | | | | | | | | | | | | | | | | | | | | | | | | | | | | | | | | | | | | | | | | | | | | | | | | | | | | | | | | | | | | | | | | | | | | | | | | | | | | | | | | | | | | | | | | | | | | | | | | | | | | | | | | | | | | | | | | | | | | | | | | | | | | | | | | | | | | | | | | | | | | | | | | | | | | | | | | | | | | | | | | | | | | | | | | | | | | | | | | | | | | | | | | | | | | | | | | | | | | | | | | | | | | | | | | | | | | | | | | | | | | | | | | | | |
| glashouder enkel m. glas | | | | | | | | | | | | | | | | | | | | | | | | | | | | | | | | | | | | | | | | | | | | | | | | | | | | | | | | | | | | | | | | | | | | | | | | | | | | | | | | | | | | | | | | | | | | | | | | | | | | | | | | | | | | | | | | | | | | | | | | | | | | | | | | | | | | | | | | | | | | | | | | | | | | | | | | | | | | | | | | | | | | | | | | | | | | | | | | | | | | | | | | | | | | | | | | | | | | | | | | | | | | | | | | | | | | | | | | | | | | | | | | | | | | | | | | | | | | | | | | | | | | | | | | | | | | | | | | | | | | | | | | | | | | | | | | | | | | | | | | | | | | | | | |
| 0690635 | | chroom | 4788031 | stuk | 79,00 | 169 | 0 |  | Sanitair producten | | | | | | | | | | | | | | | | | | | | | | | | | | | | | | | | | | | | | | | | | | | | | | | | | | | | | | | | | | | | | | | | | | | | | | | | | | | | | | | | | | | | | | | | | | | | | | | | | | | | | | | | | | | | | | | | | | | | | | | | | | | | | | | | | | | | | | | | | | | | | | | | | | | | | | | | | | | | | | | | | | | | | | | | | | | | | | | | | | | | | | | | | | | | | | | | | | | | | | | | | | | | | | | | | | | | | | | | | | | | | | | | | | | | | | | | | | | | | | | | | | | | | | | | | | | | | | | | | | | | | | | | | | | | | | | | | | | | | | |
| 0690732 | | chroom/goud | 4788081032 | stuk | 84,00 | 169 | 1 | | | glashouder staand | | | | | | | | | | 0690634 | | chroom/wit | 4793031 | stuk | 86,00 | 169 | 1 |  | Baden / douchebakken / stoomcabines | 0461216 | | chroom/goud/wit | 4793081 | stuk | 94,50 | 169 | 1 | zeep houder m. inzet | | | | | | | | | | 0690643 | | chroom | 4779031 | stuk | 78,00 | 169 | 0 |  | Douchegarnituur | 0690740 | | chroom/goud | 4779081032 | stuk | 82,50 | 169 | 1 | zeep- sponshouder | | | | | | | | | | 0463177 | | chroom | 4796031 | stuk | 92,50 | 169 | 1 |  | Accessoires en spiegels | 0463178 | | chroom/goud | 4796081 | stuk | 98,00 | 169 | 1 | planchet 60cm | | | | | | | | | | 0690627 | | chroom | 4929031 | stuk | 237,00 | 169 | 1 |  | Douchewanden | 0690724 | | chroom/goud | 4929081032 | stuk | 265,00 | 169 | 1 | handdoekring | | | | | | | | | | 0690678 | | chroom | 4842031 | stuk | 83,00 | 169 | 0 |  | Toebehoren & afvoeren | 0690767 | | chroom/goud | 4842081 | stuk | 91,00 | 169 | 1 | handdoekhouder 45cm | | | | | | | | | | 0690651 | | chroom | 4833031 | stuk | 79,00 | 169 | 1 |  | Badkamermeubelen en toiletkasten | 0690759 | | chroom/goud | 4833081032 | stuk | 91,00 | 169 | 1 | garderobehaak | | | | | | | | | | 0690694 | | chroom | 4851031 | stuk | 50,50 | 169 | 0 |  | Gootstenen en wastroggen | 0690783 | | chroom/goud | 4851081032 | stuk | 58,00 | 169 | 1 | handdoekhouder | | | | | | | | | | 0690686 | staand 3-delig | chroom | 4869031 | stuk | 292,00 | 169 | 1 |  | Utiliteit | 0690775 | staand 3-delig | chroom/goud | 4869081032 | stuk | 302,00 | 169 | 1 | closetrolhouder z. klep | | | | | | | | | | 0463179 | | chroom | 4815031 | stuk | 56,50 | 169 | 1 |  | | 0463180 | | chroom/goud | 4815081 | stuk | 69,50 | 169 | 1 | closetrolhouder | | | | | | | | | | 0690708 | m. klep | chroom | 4806031 | stuk | 119,00 | 169 | 0 |  | | 0690791 | m. klep | chroom/goud | 4806081032 | stuk | 120,00 |
| glashouder staand | | | | | | | | | | | | | | | | | | | | | | | | | | | | | | | | | | | | | | | | | | | | | | | | | | | | | | | | | | | | | | | | | | | | | | | | | | | | | | | | | | | | | | | | | | | | | | | | | | | | | | | | | | | | | | | | | | | | | | | | | | | | | | | | | | | | | | | | | | | | | | | | | | | | | | | | | | | | | | | | | | | | | | | | | | | | | | | | | | | | | | | | | | | | | | | | | | | | | | | | | | | | | | | | | | | | | | | | | | | | | | | | | | | | | | | | | | | | | | | | | | | | | | | | | | | | | | | | | | | | | | | | | | | | | | | | | | | | | | | | | | | | | | | |
| 0690634 | | chroom/wit | 4793031 | stuk | 86,00 | 169 | 1 |  | Baden / douchebakken / stoomcabines | | | | | | | | | | | | | | | | | | | | | | | | | | | | | | | | | | | | | | | | | | | | | | | | | | | | | | | | | | | | | | | | | | | | | | | | | | | | | | | | | | | | | | | | | | | | | | | | | | | | | | | | | | | | | | | | | | | | | | | | | | | | | | | | | | | | | | | | | | | | | | | | | | | | | | | | | | | | | | | | | | | | | | | | | | | | | | | | | | | | | | | | | | | | | | | | | | | | | | | | | | | | | | | | | | | | | | | | | | | | | | | | | | | | | | | | | | | | | | | | | | | | | | | | | | | | | | | | | | | | | | | | | | | | | | | | | | | | | | |
| 0461216 | | chroom/goud/wit | 4793081 | stuk | 94,50 | 169 | 1 | | | zeep houder m. inzet | | | | | | | | | | 0690643 | | chroom | 4779031 | stuk | 78,00 | 169 | 0 |  | Douchegarnituur | 0690740 | | chroom/goud | 4779081032 | stuk | 82,50 | 169 | 1 | zeep- sponshouder | | | | | | | | | | 0463177 | | chroom | 4796031 | stuk | 92,50 | 169 | 1 |  | Accessoires en spiegels | 0463178 | | chroom/goud | 4796081 | stuk | 98,00 | 169 | 1 | planchet 60cm | | | | | | | | | | 0690627 | | chroom | 4929031 | stuk | 237,00 | 169 | 1 |  | Douchewanden | 0690724 | | chroom/goud | 4929081032 | stuk | 265,00 | 169 | 1 | handdoekring | | | | | | | | | | 0690678 | | chroom | 4842031 | stuk | 83,00 | 169 | 0 |  | Toebehoren & afvoeren | 0690767 | | chroom/goud | 4842081 | stuk | 91,00 | 169 | 1 | handdoekhouder 45cm | | | | | | | | | | 0690651 | | chroom | 4833031 | stuk | 79,00 | 169 | 1 |  | Badkamermeubelen en toiletkasten | 0690759 | | chroom/goud | 4833081032 | stuk | 91,00 | 169 | 1 | garderobehaak | | | | | | | | | | 0690694 | | chroom | 4851031 | stuk | 50,50 | 169 | 0 |  | Gootstenen en wastroggen | 0690783 | | chroom/goud | 4851081032 | stuk | 58,00 | 169 | 1 | handdoekhouder | | | | | | | | | | 0690686 | staand 3-delig | chroom | 4869031 | stuk | 292,00 | 169 | 1 |  | Utiliteit | 0690775 | staand 3-delig | chroom/goud | 4869081032 | stuk | 302,00 | 169 | 1 | closetrolhouder z. klep | | | | | | | | | | 0463179 | | chroom | 4815031 | stuk | 56,50 | 169 | 1 |  | | 0463180 | | chroom/goud | 4815081 | stuk | 69,50 | 169 | 1 | closetrolhouder | | | | | | | | | | 0690708 | m. klep | chroom | 4806031 | stuk | 119,00 | 169 | 0 |  | | 0690791 | m. klep | chroom/goud | 4806081032 | stuk | 120,00 | 169 | 1 | | | | | | | | | | | | | | | | | | | | | | | | | | |
| zeep houder m. inzet | | | | | | | | | | | | | | | | | | | | | | | | | | | | | | | | | | | | | | | | | | | | | | | | | | | | | | | | | | | | | | | | | | | | | | | | | | | | | | | | | | | | | | | | | | | | | | | | | | | | | | | | | | | | | | | | | | | | | | | | | | | | | | | | | | | | | | | | | | | | | | | | | | | | | | | | | | | | | | | | | | | | | | | | | | | | | | | | | | | | | | | | | | | | | | | | | | | | | | | | | | | | | | | | | | | | | | | | | | | | | | | | | | | | | | | | | | | | | | | | | | | | | | | | | | | | | | | | | | | | | | | | | | | | | | | | | | | | | | | | | | | | | | | |
| 0690643 | | chroom | 4779031 | stuk | 78,00 | 169 | 0 |  | Douchegarnituur | | | | | | | | | | | | | | | | | | | | | | | | | | | | | | | | | | | | | | | | | | | | | | | | | | | | | | | | | | | | | | | | | | | | | | | | | | | | | | | | | | | | | | | | | | | | | | | | | | | | | | | | | | | | | | | | | | | | | | | | | | | | | | | | | | | | | | | | | | | | | | | | | | | | | | | | | | | | | | | | | | | | | | | | | | | | | | | | | | | | | | | | | | | | | | | | | | | | | | | | | | | | | | | | | | | | | | | | | | | | | | | | | | | | | | | | | | | | | | | | | | | | | | | | | | | | | | | | | | | | | | | | | | | | | | | | | | | | | | |
| 0690740 | | chroom/goud | 4779081032 | stuk | 82,50 | 169 | 1 | | | zeep- sponshouder | | | | | | | | | | 0463177 | | chroom | 4796031 | stuk | 92,50 | 169 | 1 |  | Accessoires en spiegels | 0463178 | | chroom/goud | 4796081 | stuk | 98,00 | 169 | 1 | planchet 60cm | | | | | | | | | | 0690627 | | chroom | 4929031 | stuk | 237,00 | 169 | 1 |  | Douchewanden | 0690724 | | chroom/goud | 4929081032 | stuk | 265,00 | 169 | 1 | handdoekring | | | | | | | | | | 0690678 | | chroom | 4842031 | stuk | 83,00 | 169 | 0 |  | Toebehoren & afvoeren | 0690767 | | chroom/goud | 4842081 | stuk | 91,00 | 169 | 1 | handdoekhouder 45cm | | | | | | | | | | 0690651 | | chroom | 4833031 | stuk | 79,00 | 169 | 1 |  | Badkamermeubelen en toiletkasten | 0690759 | | chroom/goud | 4833081032 | stuk | 91,00 | 169 | 1 | garderobehaak | | | | | | | | | | 0690694 | | chroom | 4851031 | stuk | 50,50 | 169 | 0 |  | Gootstenen en wastroggen | 0690783 | | chroom/goud | 4851081032 | stuk | 58,00 | 169 | 1 | handdoekhouder | | | | | | | | | | 0690686 | staand 3-delig | chroom | 4869031 | stuk | 292,00 | 169 | 1 |  | Utiliteit | 0690775 | staand 3-delig | chroom/goud | 4869081032 | stuk | 302,00 | 169 | 1 | closetrolhouder z. klep | | | | | | | | | | 0463179 | | chroom | 4815031 | stuk | 56,50 | 169 | 1 |  | | 0463180 | | chroom/goud | 4815081 | stuk | 69,50 | 169 | 1 | closetrolhouder | | | | | | | | | | 0690708 | m. klep | chroom | 4806031 | stuk | 119,00 | 169 | 0 |  | | 0690791 | m. klep | chroom/goud | 4806081032 | stuk | 120,00 | 169 | 1 | | | | | | | | | | | | | | | | | | | | | | | | | | | | | | | | | | | | | | | | | | | | | | | | | | | | | | |
| zeep- sponshouder | | | | | | | | | | | | | | | | | | | | | | | | | | | | | | | | | | | | | | | | | | | | | | | | | | | | | | | | | | | | | | | | | | | | | | | | | | | | | | | | | | | | | | | | | | | | | | | | | | | | | | | | | | | | | | | | | | | | | | | | | | | | | | | | | | | | | | | | | | | | | | | | | | | | | | | | | | | | | | | | | | | | | | | | | | | | | | | | | | | | | | | | | | | | | | | | | | | | | | | | | | | | | | | | | | | | | | | | | | | | | | | | | | | | | | | | | | | | | | | | | | | | | | | | | | | | | | | | | | | | | | | | | | | | | | | | | | | | | | | | | | | | | | | |
| 0463177 | | chroom | 4796031 | stuk | 92,50 | 169 | 1 |  | Accessoires en spiegels | | | | | | | | | | | | | | | | | | | | | | | | | | | | | | | | | | | | | | | | | | | | | | | | | | | | | | | | | | | | | | | | | | | | | | | | | | | | | | | | | | | | | | | | | | | | | | | | | | | | | | | | | | | | | | | | | | | | | | | | | | | | | | | | | | | | | | | | | | | | | | | | | | | | | | | | | | | | | | | | | | | | | | | | | | | | | | | | | | | | | | | | | | | | | | | | | | | | | | | | | | | | | | | | | | | | | | | | | | | | | | | | | | | | | | | | | | | | | | | | | | | | | | | | | | | | | | | | | | | | | | | | | | | | | | | | | | | | | | |
| 0463178 | | chroom/goud | 4796081 | stuk | 98,00 | 169 | 1 | | | planchet 60cm | | | | | | | | | | 0690627 | | chroom | 4929031 | stuk | 237,00 | 169 | 1 |  | Douchewanden | 0690724 | | chroom/goud | 4929081032 | stuk | 265,00 | 169 | 1 | handdoekring | | | | | | | | | | 0690678 | | chroom | 4842031 | stuk | 83,00 | 169 | 0 |  | Toebehoren & afvoeren | 0690767 | | chroom/goud | 4842081 | stuk | 91,00 | 169 | 1 | handdoekhouder 45cm | | | | | | | | | | 0690651 | | chroom | 4833031 | stuk | 79,00 | 169 | 1 |  | Badkamermeubelen en toiletkasten | 0690759 | | chroom/goud | 4833081032 | stuk | 91,00 | 169 | 1 | garderobehaak | | | | | | | | | | 0690694 | | chroom | 4851031 | stuk | 50,50 | 169 | 0 |  | Gootstenen en wastroggen | 0690783 | | chroom/goud | 4851081032 | stuk | 58,00 | 169 | 1 | handdoekhouder | | | | | | | | | | 0690686 | staand 3-delig | chroom | 4869031 | stuk | 292,00 | 169 | 1 |  | Utiliteit | 0690775 | staand 3-delig | chroom/goud | 4869081032 | stuk | 302,00 | 169 | 1 | closetrolhouder z. klep | | | | | | | | | | 0463179 | | chroom | 4815031 | stuk | 56,50 | 169 | 1 |  | | 0463180 | | chroom/goud | 4815081 | stuk | 69,50 | 169 | 1 | closetrolhouder | | | | | | | | | | 0690708 | m. klep | chroom | 4806031 | stuk | 119,00 | 169 | 0 |  | | 0690791 | m. klep | chroom/goud | 4806081032 | stuk | 120,00 | 169 | 1 | | | | | | | | | | | | | | | | | | | | | | | | | | | | | | | | | | | | | | | | | | | | | | | | | | | | | | | | | | | | | | | | | | | | | | | | | | | | | | | | | | |
| planchet 60cm | | | | | | | | | | | | | | | | | | | | | | | | | | | | | | | | | | | | | | | | | | | | | | | | | | | | | | | | | | | | | | | | | | | | | | | | | | | | | | | | | | | | | | | | | | | | | | | | | | | | | | | | | | | | | | | | | | | | | | | | | | | | | | | | | | | | | | | | | | | | | | | | | | | | | | | | | | | | | | | | | | | | | | | | | | | | | | | | | | | | | | | | | | | | | | | | | | | | | | | | | | | | | | | | | | | | | | | | | | | | | | | | | | | | | | | | | | | | | | | | | | | | | | | | | | | | | | | | | | | | | | | | | | | | | | | | | | | | | | | | | | | | | | | |
| 0690627 | | chroom | 4929031 | stuk | 237,00 | 169 | 1 |  | Douchewanden | | | | | | | | | | | | | | | | | | | | | | | | | | | | | | | | | | | | | | | | | | | | | | | | | | | | | | | | | | | | | | | | | | | | | | | | | | | | | | | | | | | | | | | | | | | | | | | | | | | | | | | | | | | | | | | | | | | | | | | | | | | | | | | | | | | | | | | | | | | | | | | | | | | | | | | | | | | | | | | | | | | | | | | | | | | | | | | | | | | | | | | | | | | | | | | | | | | | | | | | | | | | | | | | | | | | | | | | | | | | | | | | | | | | | | | | | | | | | | | | | | | | | | | | | | | | | | | | | | | | | | | | | | | | | | | | | | | | | | |
| 0690724 | | chroom/goud | 4929081032 | stuk | 265,00 | 169 | 1 | | | handdoekring | | | | | | | | | | 0690678 | | chroom | 4842031 | stuk | 83,00 | 169 | 0 |  | Toebehoren & afvoeren | 0690767 | | chroom/goud | 4842081 | stuk | 91,00 | 169 | 1 | handdoekhouder 45cm | | | | | | | | | | 0690651 | | chroom | 4833031 | stuk | 79,00 | 169 | 1 |  | Badkamermeubelen en toiletkasten | 0690759 | | chroom/goud | 4833081032 | stuk | 91,00 | 169 | 1 | garderobehaak | | | | | | | | | | 0690694 | | chroom | 4851031 | stuk | 50,50 | 169 | 0 |  | Gootstenen en wastroggen | 0690783 | | chroom/goud | 4851081032 | stuk | 58,00 | 169 | 1 | handdoekhouder | | | | | | | | | | 0690686 | staand 3-delig | chroom | 4869031 | stuk | 292,00 | 169 | 1 |  | Utiliteit | 0690775 | staand 3-delig | chroom/goud | 4869081032 | stuk | 302,00 | 169 | 1 | closetrolhouder z. klep | | | | | | | | | | 0463179 | | chroom | 4815031 | stuk | 56,50 | 169 | 1 |  | | 0463180 | | chroom/goud | 4815081 | stuk | 69,50 | 169 | 1 | closetrolhouder | | | | | | | | | | 0690708 | m. klep | chroom | 4806031 | stuk | 119,00 | 169 | 0 |  | | 0690791 | m. klep | chroom/goud | 4806081032 | stuk | 120,00 | 169 | 1 | | | | | | | | | | | | | | | | | | | | | | | | | | | | | | | | | | | | | | | | | | | | | | | | | | | | | | | | | | | | | | | | | | | | | | | | | | | | | | | | | | | | | | | | | | | | | | | | | | | | | | | | | | | | | | |
| handdoekring | | | | | | | | | | | | | | | | | | | | | | | | | | | | | | | | | | | | | | | | | | | | | | | | | | | | | | | | | | | | | | | | | | | | | | | | | | | | | | | | | | | | | | | | | | | | | | | | | | | | | | | | | | | | | | | | | | | | | | | | | | | | | | | | | | | | | | | | | | | | | | | | | | | | | | | | | | | | | | | | | | | | | | | | | | | | | | | | | | | | | | | | | | | | | | | | | | | | | | | | | | | | | | | | | | | | | | | | | | | | | | | | | | | | | | | | | | | | | | | | | | | | | | | | | | | | | | | | | | | | | | | | | | | | | | | | | | | | | | | | | | | | | | | |
| 0690678 | | chroom | 4842031 | stuk | 83,00 | 169 | 0 |  | Toebehoren & afvoeren | | | | | | | | | | | | | | | | | | | | | | | | | | | | | | | | | | | | | | | | | | | | | | | | | | | | | | | | | | | | | | | | | | | | | | | | | | | | | | | | | | | | | | | | | | | | | | | | | | | | | | | | | | | | | | | | | | | | | | | | | | | | | | | | | | | | | | | | | | | | | | | | | | | | | | | | | | | | | | | | | | | | | | | | | | | | | | | | | | | | | | | | | | | | | | | | | | | | | | | | | | | | | | | | | | | | | | | | | | | | | | | | | | | | | | | | | | | | | | | | | | | | | | | | | | | | | | | | | | | | | | | | | | | | | | | | | | | | | | |
| 0690767 | | chroom/goud | 4842081 | stuk | 91,00 | 169 | 1 | | | handdoekhouder 45cm | | | | | | | | | | 0690651 | | chroom | 4833031 | stuk | 79,00 | 169 | 1 |  | Badkamermeubelen en toiletkasten | 0690759 | | chroom/goud | 4833081032 | stuk | 91,00 | 169 | 1 | garderobehaak | | | | | | | | | | 0690694 | | chroom | 4851031 | stuk | 50,50 | 169 | 0 |  | Gootstenen en wastroggen | 0690783 | | chroom/goud | 4851081032 | stuk | 58,00 | 169 | 1 | handdoekhouder | | | | | | | | | | 0690686 | staand 3-delig | chroom | 4869031 | stuk | 292,00 | 169 | 1 |  | Utiliteit | 0690775 | staand 3-delig | chroom/goud | 4869081032 | stuk | 302,00 | 169 | 1 | closetrolhouder z. klep | | | | | | | | | | 0463179 | | chroom | 4815031 | stuk | 56,50 | 169 | 1 |  | | 0463180 | | chroom/goud | 4815081 | stuk | 69,50 | 169 | 1 | closetrolhouder | | | | | | | | | | 0690708 | m. klep | chroom | 4806031 | stuk | 119,00 | 169 | 0 |  | | 0690791 | m. klep | chroom/goud | 4806081032 | stuk | 120,00 | 169 | 1 | | | | | | | | | | | | | | | | | | | | | | | | | | | | | | | | | | | | | | | | | | | | | | | | | | | | | | | | | | | | | | | | | | | | | | | | | | | | | | | | | | | | | | | | | | | | | | | | | | | | | | | | | | | | | | | | | | | | | | | | | | | | | | | | | | | | | | | | | | |
| handdoekhouder 45cm | | | | | | | | | | | | | | | | | | | | | | | | | | | | | | | | | | | | | | | | | | | | | | | | | | | | | | | | | | | | | | | | | | | | | | | | | | | | | | | | | | | | | | | | | | | | | | | | | | | | | | | | | | | | | | | | | | | | | | | | | | | | | | | | | | | | | | | | | | | | | | | | | | | | | | | | | | | | | | | | | | | | | | | | | | | | | | | | | | | | | | | | | | | | | | | | | | | | | | | | | | | | | | | | | | | | | | | | | | | | | | | | | | | | | | | | | | | | | | | | | | | | | | | | | | | | | | | | | | | | | | | | | | | | | | | | | | | | | | | | | | | | | | | |
| 0690651 | | chroom | 4833031 | stuk | 79,00 | 169 | 1 |  | Badkamermeubelen en toiletkasten | | | | | | | | | | | | | | | | | | | | | | | | | | | | | | | | | | | | | | | | | | | | | | | | | | | | | | | | | | | | | | | | | | | | | | | | | | | | | | | | | | | | | | | | | | | | | | | | | | | | | | | | | | | | | | | | | | | | | | | | | | | | | | | | | | | | | | | | | | | | | | | | | | | | | | | | | | | | | | | | | | | | | | | | | | | | | | | | | | | | | | | | | | | | | | | | | | | | | | | | | | | | | | | | | | | | | | | | | | | | | | | | | | | | | | | | | | | | | | | | | | | | | | | | | | | | | | | | | | | | | | | | | | | | | | | | | | | | | | |
| 0690759 | | chroom/goud | 4833081032 | stuk | 91,00 | 169 | 1 | | | garderobehaak | | | | | | | | | | 0690694 | | chroom | 4851031 | stuk | 50,50 | 169 | 0 |  | Gootstenen en wastroggen | 0690783 | | chroom/goud | 4851081032 | stuk | 58,00 | 169 | 1 | handdoekhouder | | | | | | | | | | 0690686 | staand 3-delig | chroom | 4869031 | stuk | 292,00 | 169 | 1 |  | Utiliteit | 0690775 | staand 3-delig | chroom/goud | 4869081032 | stuk | 302,00 | 169 | 1 | closetrolhouder z. klep | | | | | | | | | | 0463179 | | chroom | 4815031 | stuk | 56,50 | 169 | 1 |  | | 0463180 | | chroom/goud | 4815081 | stuk | 69,50 | 169 | 1 | closetrolhouder | | | | | | | | | | 0690708 | m. klep | chroom | 4806031 | stuk | 119,00 | 169 | 0 |  | | 0690791 | m. klep | chroom/goud | 4806081032 | stuk | 120,00 | 169 | 1 | | | | | | | | | | | | | | | | | | | | | | | | | | | | | | | | | | | | | | | | | | | | | | | | | | | | | | | | | | | | | | | | | | | | | | | | | | | | | | | | | | | | | | | | | | | | | | | | | | | | | | | | | | | | | | | | | | | | | | | | | | | | | | | | | | | | | | | | | | | | | | | | | | | | | | | | | | | | | | | | | | | | | | |
| garderobehaak | | | | | | | | | | | | | | | | | | | | | | | | | | | | | | | | | | | | | | | | | | | | | | | | | | | | | | | | | | | | | | | | | | | | | | | | | | | | | | | | | | | | | | | | | | | | | | | | | | | | | | | | | | | | | | | | | | | | | | | | | | | | | | | | | | | | | | | | | | | | | | | | | | | | | | | | | | | | | | | | | | | | | | | | | | | | | | | | | | | | | | | | | | | | | | | | | | | | | | | | | | | | | | | | | | | | | | | | | | | | | | | | | | | | | | | | | | | | | | | | | | | | | | | | | | | | | | | | | | | | | | | | | | | | | | | | | | | | | | | | | | | | | | | |
| 0690694 | | chroom | 4851031 | stuk | 50,50 | 169 | 0 |  | Gootstenen en wastroggen | | | | | | | | | | | | | | | | | | | | | | | | | | | | | | | | | | | | | | | | | | | | | | | | | | | | | | | | | | | | | | | | | | | | | | | | | | | | | | | | | | | | | | | | | | | | | | | | | | | | | | | | | | | | | | | | | | | | | | | | | | | | | | | | | | | | | | | | | | | | | | | | | | | | | | | | | | | | | | | | | | | | | | | | | | | | | | | | | | | | | | | | | | | | | | | | | | | | | | | | | | | | | | | | | | | | | | | | | | | | | | | | | | | | | | | | | | | | | | | | | | | | | | | | | | | | | | | | | | | | | | | | | | | | | | | | | | | | | | |
| 0690783 | | chroom/goud | 4851081032 | stuk | 58,00 | 169 | 1 | | | handdoekhouder | | | | | | | | | | 0690686 | staand 3-delig | chroom | 4869031 | stuk | 292,00 | 169 | 1 |  | Utiliteit | 0690775 | staand 3-delig | chroom/goud | 4869081032 | stuk | 302,00 | 169 | 1 | closetrolhouder z. klep | | | | | | | | | | 0463179 | | chroom | 4815031 | stuk | 56,50 | 169 | 1 |  | | 0463180 | | chroom/goud | 4815081 | stuk | 69,50 | 169 | 1 | closetrolhouder | | | | | | | | | | 0690708 | m. klep | chroom | 4806031 | stuk | 119,00 | 169 | 0 |  | | 0690791 | m. klep | chroom/goud | 4806081032 | stuk | 120,00 | 169 | 1 | | | | | | | | | | | | | | | | | | | | | | | | | | | | | | | | | | | | | | | | | | | | | | | | | | | | | | | | | | | | | | | | | | | | | | | | | | | | | | | | | | | | | | | | | | | | | | | | | | | | | | | | | | | | | | | | | | | | | | | | | | | | | | | | | | | | | | | | | | | | | | | | | | | | | | | | | | | | | | | | | | | | | | | | | | | | | | | | | | | | | | | | | | | | | | | | | | |
| handdoekhouder | | | | | | | | | | | | | | | | | | | | | | | | | | | | | | | | | | | | | | | | | | | | | | | | | | | | | | | | | | | | | | | | | | | | | | | | | | | | | | | | | | | | | | | | | | | | | | | | | | | | | | | | | | | | | | | | | | | | | | | | | | | | | | | | | | | | | | | | | | | | | | | | | | | | | | | | | | | | | | | | | | | | | | | | | | | | | | | | | | | | | | | | | | | | | | | | | | | | | | | | | | | | | | | | | | | | | | | | | | | | | | | | | | | | | | | | | | | | | | | | | | | | | | | | | | | | | | | | | | | | | | | | | | | | | | | | | | | | | | | | | | | | | | | |
| 0690686 | staand 3-delig | chroom | 4869031 | stuk | 292,00 | 169 | 1 |  | Utiliteit | | | | | | | | | | | | | | | | | | | | | | | | | | | | | | | | | | | | | | | | | | | | | | | | | | | | | | | | | | | | | | | | | | | | | | | | | | | | | | | | | | | | | | | | | | | | | | | | | | | | | | | | | | | | | | | | | | | | | | | | | | | | | | | | | | | | | | | | | | | | | | | | | | | | | | | | | | | | | | | | | | | | | | | | | | | | | | | | | | | | | | | | | | | | | | | | | | | | | | | | | | | | | | | | | | | | | | | | | | | | | | | | | | | | | | | | | | | | | | | | | | | | | | | | | | | | | | | | | | | | | | | | | | | | | | | | | | | | | | |
| 0690775 | staand 3-delig | chroom/goud | 4869081032 | stuk | 302,00 | 169 | 1 | | | closetrolhouder z. klep | | | | | | | | | | 0463179 | | chroom | 4815031 | stuk | 56,50 | 169 | 1 |  | | 0463180 | | chroom/goud | 4815081 | stuk | 69,50 | 169 | 1 | closetrolhouder | | | | | | | | | | 0690708 | m. klep | chroom | 4806031 | stuk | 119,00 | 169 | 0 |  | | 0690791 | m. klep | chroom/goud | 4806081032 | stuk | 120,00 | 169 | 1 | | | | | | | | | | | | | | | | | | | | | | | | | | | | | | | | | | | | | | | | | | | | | | | | | | | | | | | | | | | | | | | | | | | | | | | | | | | | | | | | | | | | | | | | | | | | | | | | | | | | | | | | | | | | | | | | | | | | | | | | | | | | | | | | | | | | | | | | | | | | | | | | | | | | | | | | | | | | | | | | | | | | | | | | | | | | | | | | | | | | | | | | | | | | | | | | | | | | | | | | | | | | | | | | | | | | | | | | | | | | | | |
| closetrolhouder z. klep | | | | | | | | | | | | | | | | | | | | | | | | | | | | | | | | | | | | | | | | | | | | | | | | | | | | | | | | | | | | | | | | | | | | | | | | | | | | | | | | | | | | | | | | | | | | | | | | | | | | | | | | | | | | | | | | | | | | | | | | | | | | | | | | | | | | | | | | | | | | | | | | | | | | | | | | | | | | | | | | | | | | | | | | | | | | | | | | | | | | | | | | | | | | | | | | | | | | | | | | | | | | | | | | | | | | | | | | | | | | | | | | | | | | | | | | | | | | | | | | | | | | | | | | | | | | | | | | | | | | | | | | | | | | | | | | | | | | | | | | | | | | | | | |
| 0463179 | | chroom | 4815031 | stuk | 56,50 | 169 | 1 |  | | | | | | | | | | | | | | | | | | | | | | | | | | | | | | | | | | | | | | | | | | | | | | | | | | | | | | | | | | | | | | | | | | | | | | | | | | | | | | | | | | | | | | | | | | | | | | | | | | | | | | | | | | | | | | | | | | | | | | | | | | | | | | | | | | | | | | | | | | | | | | | | | | | | | | | | | | | | | | | | | | | | | | | | | | | | | | | | | | | | | | | | | | | | | | | | | | | | | | | | | | | | | | | | | | | | | | | | | | | | | | | | | | | | | | | | | | | | | | | | | | | | | | | | | | | | | | | | | | | | | | | | | | | | | | | | | | | | | | | |
| 0463180 | | chroom/goud | 4815081 | stuk | 69,50 | 169 | 1 | | | closetrolhouder | | | | | | | | | | 0690708 | m. klep | chroom | 4806031 | stuk | 119,00 | 169 | 0 |  | | 0690791 | m. klep | chroom/goud | 4806081032 | stuk | 120,00 | 169 | 1 | | | | | | | | | | | | | | | | | | | | | | | | | | | | | | | | | | | | | | | | | | | | | | | | | | | | | | | | | | | | | | | | | | | | | | | | | | | | | | | | | | | | | | | | | | | | | | | | | | | | | | | | | | | | | | | | | | | | | | | | | | | | | | | | | | | | | | | | | | | | | | | | | | | | | | | | | | | | | | | | | | | | | | | | | | | | | | | | | | | | | | | | | | | | | | | | | | | | | | | | | | | | | | | | | | | | | | | | | | | | | | | | | | | | | | | | | | | | | | | | | | | | | | | | | | |
| closetrolhouder | | | | | | | | | | | | | | | | | | | | | | | | | | | | | | | | | | | | | | | | | | | | | | | | | | | | | | | | | | | | | | | | | | | | | | | | | | | | | | | | | | | | | | | | | | | | | | | | | | | | | | | | | | | | | | | | | | | | | | | | | | | | | | | | | | | | | | | | | | | | | | | | | | | | | | | | | | | | | | | | | | | | | | | | | | | | | | | | | | | | | | | | | | | | | | | | | | | | | | | | | | | | | | | | | | | | | | | | | | | | | | | | | | | | | | | | | | | | | | | | | | | | | | | | | | | | | | | | | | | | | | | | | | | | | | | | | | | | | | | | | | | | | | | |
| 0690708 | m. klep | chroom | 4806031 | stuk | 119,00 | 169 | 0 |  | | | | | | | | | | | | | | | | | | | | | | | | | | | | | | | | | | | | | | | | | | | | | | | | | | | | | | | | | | | | | | | | | | | | | | | | | | | | | | | | | | | | | | | | | | | | | | | | | | | | | | | | | | | | | | | | | | | | | | | | | | | | | | | | | | | | | | | | | | | | | | | | | | | | | | | | | | | | | | | | | | | | | | | | | | | | | | | | | | | | | | | | | | | | | | | | | | | | | | | | | | | | | | | | | | | | | | | | | | | | | | | | | | | | | | | | | | | | | | | | | | | | | | | | | | | | | | | | | | | | | | | | | | | | | | | | | | | | | | | |
| 0690791 | m. klep | chroom/goud | 4806081032 | stuk | 120,00 | 169 | 1 | | | | | | | | | | | | | | | | | | | | | | | | | | | | | | | | | | | | | | | | | | | | | | | | | | | | | | | | | | | | | | | | | | | | | | | | | | | | | | | | | | | | | | | | | | | | | | | | | | | | | | | | | | | | | | | | | | | | | | | | | | | | | | | | | | | | | | | | | | | | | | | | | | | | | | | | | | | | | | | | | | | | | | | | | | | | | | | | | | | | | | | | | | | | | | | | | | | | | | | | | | | | | | | | | | | | | | | | | | | | | | | | | | | | | | | | | | | | | | | | | | | | | | | | | | | | | | | | | | | | | | | | | | | | | | | | | | | | | | | | |

| | Art.nr | Specificaties | Kleur | Lev.nr | Ehd | Prijs | Grp | CC |
|---|---|--|-------|------------|------------|-------|--------|-------|
| | Gessi Natura | | | | | | | |
| Sanitair producten |  | closetborstelgarnituur | | | | | | |
| | | 0690716 | | chrom | 4797031 | stuk | 109,00 | 169 |
| | | 0690805 | | chrom/goud | 4797081032 | stuk | 116,00 | 169 1 |
| Baden / douchebakken / stoomcabines | | | | | | | | |
| Kranen |  | wandhanddoekrek 30cm | | | | | | |
| | | 0463181 | | chrom/goud | 4824081 | stuk | 88,50 | 169 1 |
| | | | | | | | | |
| | Gessi Ovale | | | | | | | |
| Douchegarnituur |  | zeephouder m. satin houder wandmodel | | | | | | |
| | | 0463672 | | chrom | 25601031 | stuk | 144,00 | 169 1 |
| Accessoires en spiegels | | | | | | | | |
| Douchewanden |  | zeephouder m. satin houder staand model | | | | | | |
| | | 0463676 | | chrom | 25325031 | stuk | 112,00 | 169 1 |
| Toebehoren & afvoeren | | | | | | | | |
| Spool- & installatiesystemen |  | glashouder m. satin glas wandmodel | | | | | | |
| | | 0463673 | | chrom | 25607031 | stuk | 144,00 | 169 1 |
| Badkamermeubelen en toiletkasten | | | | | | | | |
| Gootstenen en wastroggen |  | glashouder m. satin glas staand model | | | | | | |
| | | 0463677 | | chrom | 25331031 | stuk | 112,00 | 169 1 |
| Utiliteit | | | | | | | | |
| |  | zeepdispenser m. houder satin glas wandmodel | | | | | | |
| | | 0463674 | | chrom | 25613031 | stuk | 238,00 | 169 1 |
| | | | | | | | | |
| |  | zeepdispenser m. houder satin glas staand model | | | | | | |
| | | 0463678 | | chrom | 25337031 | stuk | 203,00 | 169 1 |
| | | | | | | | | |
| |  | handdoekhouder | | | | | | |
| | | 0463682 | 30cm | chrom | 25697031 | stuk | 150,00 | 169 1 |
| | | 0463683 | 45cm | chrom | 25700031 | stuk | 156,00 | 169 1 |
| | | 0463684 | 60cm | chrom | 25703031 | stuk | 165,00 | 169 1 |

| Art.nr | Specificaties | Kleur | Lev.nr | Ehd | Prijs | Grp | CC | |
|---|---------------|--------|----------|------|--------|-----|----|---|
| | | | | | | | | Gessi Ovale |
| handdoekring 22cm 0463685 | | chroom | 25709031 | stuk | 138,00 | 169 | 1 |  |
| handdoekhouder staand 0463688 | | chroom | 25739031 | stuk | 330,00 | 169 | 1 |  |
| closetborstelgarnituur m. satin glas wandmodel 0463675 | | chroom | 25619031 | stuk | 227,00 | 169 | 1 |  |
| closetborstelgarnituur m. satin glas staand model 0463679 | | chroom | 25343031 | stuk | 198,00 | 169 | 1 |  |
| closetrolhouder m. klep 0463680 | | chroom | 25649031 | stuk | 178,00 | 169 | 1 |  |
| closetrolhouder z. klep 0463681 | | chroom | 25655031 | stuk | 114,00 | 169 | 1 |  |
| staander m. closetrolhouder m. closetborstelgarnituur in satin glas 0463687 | | chroom | 25733031 | stuk | 450,00 | 169 | 1 |  |
| kledinghaak dubbel 0463686 | | chroom | 25721031 | stuk | 90,00 | 169 | 1 |  |
| plafond- /wandlamp 0463689 | | chroom | 25478031 | stuk | 402,00 | 169 | 1 |  |

Sanitair producten

Baden /
douchebakken /
stoomcabines

Kranen

Douchegarnituur

Accessoires en
spiegels

Douchewanden









Toebehoren &
afvoeren







Spoel- &
installatiesystemen

Badkamermeubelen
en toiletkasten

Gootstenen en
wastroggen

Utiliteit

| | Art.nr | Specificaties | Kleur | Lev.nr | Ehd | Prijs | Grp | CC | |
|---|---|---|-------|--------|----------|-------|--------|-----|---|
| Sanitair producten | Gessi Ovale | | | | | | | | |
| |  | make-up spiegel staand model | | chroom | 25488031 | stuk | 270,00 | 169 | 1 |
| 0463690 | | | | | | | | | |
| Baden / douchebakken / stoomcabines | | | | | | | | | |
| Kranen | Gessi Ovale-T | | | | | | | | |
| |  | zeephouder m. satin glas houder wandmodel | | chroom | 25301031 | stuk | 144,00 | 169 | 1 |
| 0463702 | | | | | | | | | |
| Douchegarnituur | | | | | | | | | |
| Accessoires en spiegels |  | glashouder m. satin glas wandmodel | | chroom | 25307031 | stuk | 144,00 | 169 | 1 |
| | | 0463703 | | | | | | | |
| Douchewanden | | | | | | | | | |
| Toebehoren & afvoeren |  | zeepdispenser m. houder satin glas wandmodel | | chroom | 25313031 | stuk | 238,00 | 169 | 1 |
| | | 0463704 | | | | | | | |
| Spoel- & installatiesystemen | | | | | | | | | |
| Badkamermeubelen en toiletkasten |  | handdoekhouder | | chroom | 25397031 | stuk | 150,00 | 169 | 1 |
| | | 0463712 | 30cm | | | | | | |
| | | 0463713 | 45cm | | | | | | |
| | | 0463714 | 60cm | | | | | | |
| Gootstenen en wastroggen |  | handdoekring | | chroom | 25409031 | stuk | 138,00 | 169 | 1 |
| | | 0463715 | 22cm | | | | | | |
| Utiliteit | | | | | | | | | |
| |  | handdoekhouder staand | | chroom | 25439031 | stuk | 330,00 | 169 | 1 |
| | | 0463718 | | | | | | | |
| |  | closetborstelgarnituur m. satin glas wandmodel | | chroom | 25319031 | stuk | 227,00 | 169 | 1 |
| | | 0463705 | | | | | | | |
| |  | closetrolhouder m. klep | | chroom | 25349031 | stuk | 178,00 | 169 | 1 |
| | | 0463710 | | | | | | | |

| Art.nr | Specificaties | Kleur | Lev.nr | Ehd | Prijs | Grp | CC | |
|---|---------------|--------|----------|------|--------|-----|----|---|
| | | | | | | | | Gessi Ovale-T |
| closetrolhouder z. klep | | | | | | | | |
| 0463711 | | chroom | 25355031 | stuk | 114,00 | 169 | 1 |  |
| staander m. closetrolhouder m. closetborstelgarnituur in satijn glas | | | | | | | | |
| 0463717 | | chroom | 25433031 | stuk | 450,00 | 169 | 1 |  |
| kledinghaak dubbel | | | | | | | | |
| 0463716 | | chroom | 25421031 | stuk | 90,00 | 169 | 1 |  |
| | | | | | | | | Gessi Quadro |
| glashouder m. glas | | | | | | | | |
| 0691798 | | chroom | 15707031 | stuk | 152,00 | 169 | 0 |  |
| 0692158 | | inox | 15707142 | stuk | 197,00 | 169 | 1 | |
| glashouder staand | | | | | | | | |
| 0692352 | | chroom | 15731031 | stuk | 83,00 | 169 | 1 |  |
| 0692360 | | inox | 15731142 | stuk | 92,50 | 169 | 1 | |
| zeep-/glashouder | | | | | | | | |
| 0692271 | | chroom | 15785031 | stuk | 206,00 | 169 | 1 |  |
| 0692298 | | inox | 15785142 | stuk | 227,00 | 169 | 1 | |
| glashouder + zeepdispenser m. glas | | | | | | | | |
| 0691836 | | chroom | 15788031 | stuk | 291,00 | 169 | 0 |  |
| 0692182 | | inox | 15788142 | stuk | 375,00 | 169 | 1 | |
| zeephouder | | | | | | | | |
| 0691771 | | chroom | 15701031 | stuk | 146,00 | 169 | 0 |  |
| 0692131 | | inox | 15701142 | stuk | 190,00 | 169 | 1 | |
| zeepdispenser wandmodel compleet | | | | | | | | |
| 0691801 | | chroom | 15713031 | stuk | 237,00 | 169 | 0 |  |
| 0692166 | | inox | 15713142 | stuk | 309,00 | 169 | 1 | |

Sanitair producten

Baden /
douchebakken /
stoomcabines

Kranen

Douchegarnituur

Accessoires en
spiegels

Douchewanden

Toebehoren &
afvoeren











Spoel- &
installatiesystemen

Badkamermeubelen
en toiletkasten

Gootstenen en
wastroggen

Utiliteit

| | Art.nr | Specificaties | Kleur | Lev.nr | Ehd | Prijs | Grp | CC |
|----------------------------------|---|---------------|-------|----------|------|--------|-----|----|
| | Gessi Quadro | | | | | | | |
| | zeepdispenser + zeephouder | | | | | | | |
| Sanitair producten | 0692301 | | chrom | 15791031 | stuk | 289,00 | 169 | 1 |
| | 0692328 | | inox | 15791142 | stuk | 375,00 | 169 | 1 |
| | zeephouder staand | | | | | | | |
| Kranen | 0692336 | | chrom | 15725031 | stuk | 75,00 | 169 | 1 |
| | 0692344 | | inox | 15725142 | stuk | 85,50 | 169 | 1 |
| | zeepdispenser staandmodel compleet | | | | | | | |
| Douchegarnituur | 0692379 | | chrom | 15737031 | stuk | 174,00 | 169 | 1 |
| | 0692387 | | inox | 15737142 | stuk | 210,00 | 169 | 1 |
| | dispenser voor zeephouder | | | | | | | |
| Douchewanden | 0692573 | | chrom | 15863031 | stuk | 85,50 | 169 | 1 |
| | 0692581 | | inox | 15863142 | stuk | 115,00 | 169 | 1 |
| | planchet 60cm | | | | | | | |
| Toebehoren & afvoeren | 0691917 | | chrom | 15845031 | stuk | 289,00 | 169 | 1 |
| | 0692263 | | inox | 15845142 | stuk | 347,00 | 169 | 1 |
| | wandlamp | | | | | | | |
| Spool- & installatiesystemen | 0691925 | | chrom | 15878031 | stuk | 567,00 | 169 | 1 |
| | handdoekhouder 60cm | | | | | | | |
| Badkamermeubelen en toiletkasten | 0691879 | | chrom | 15803031 | stuk | 153,00 | 169 | 1 |
| | 0692220 | | inox | 15803142 | stuk | 198,00 | 169 | 1 |
| | handdoekring | | | | | | | |
| Gootstenen en wastroggen | 0691887 | | chrom | 15809031 | stuk | 137,00 | 169 | 0 |
| | 0692239 | | inox | 15809142 | stuk | 178,00 | 169 | 1 |
| | 2-lids handdoekhouder | | | | | | | |
| Utiliteit | 0691895 | | chrom | 15815031 | stuk | 200,00 | 169 | 0 |
| | 0692247 | | inox | 15815142 | stuk | 260,00 | 169 | 1 |
| | handdoekhouder staand m. 3 dragers | | | | | | | |
| | 0692522 | | chrom | 15839031 | stuk | 490,00 | 169 | 1 |
| | 0692530 | | inox | 15839142 | stuk | 637,00 | 169 | 1 |
| | handdoekhouder staand m. 1 drager | | | | | | | |
| | 0692549 | | chrom | 15841031 | stuk | 245,00 | 169 | 1 |
| | 0692557 | | inox | 15841142 | stuk | 317,00 | 169 | 1 |

| Art.nr | Specificaties | Kleur | Lev.nr | Ehd | Prijs | Grp | CC | | |
|---|---------------|--------|----------|------|--------|-----|----|---|---|
| | | | | | | | | Gessi Quadro | |
| badgreep 30cm | | | | | | | | | |
| 0691860 | | chroom | 15797031 | stuk | 142,00 | 169 | 1 |  | Sanitair producten |
| 0692212 | | inox | 15797140 | stuk | 184,00 | 169 | 1 | | |
| badlakenrek 45cm | | | | | | | | | |
| 0463145 | | chroom | 15800031 | stuk | 148,00 | 169 | 1 |  | Baden / douchebakken / stoomcabines |
| 0463146 | | inox | 15800142 | stuk | 192,00 | 169 | 1 | | |
| closetrolhouder m. klep | | | | | | | | | |
| 0691844 | | chroom | 15749031 | stuk | 177,00 | 169 | 0 |  | Kranen |
| 0692190 | | inox | 15749142 | stuk | 229,00 | 169 | 1 | | |
| closetrolhouder z. klep | | | | | | | | | |
| 0691852 | | chroom | 15755031 | stuk | 125,00 | 169 | 0 |  | Douchegarnituur |
| 0692204 | | inox | 15755142 | stuk | 161,00 | 169 | 1 | | |
| closetrolhouder dubbel | | | | | | | | | |
| 0463143 | | chroom | 15757031 | stuk | 174,00 | 169 | 1 |  | Douchewanden |
| 0463144 | | inox | 15757142 | stuk | 226,00 | 169 | 1 | | |
| closetborstelgarnituur wandmodel | | | | | | | | | |
| 0691828 | | chroom | 15719031 | stuk | 198,00 | 169 | 0 |  | Toebehoren & afvoeren |
| 0692174 | | inox | 15719142 | stuk | 255,00 | 169 | 1 | | |
| closetborstelgarnituur staandmodel | | | | | | | | | |
| 0692395 | | chroom | 15743031 | stuk | 137,00 | 169 | 1 |  | Badkamermeubelen en toiletkasten |
| 0692409 | | inox | 15743142 | stuk | 164,00 | 169 | 1 | | |
| houder voor closetborstelgarnituur | | | | | | | | | |
| 0692603 | | chroom | 15869031 | stuk | 77,50 | 169 | 1 |  | Gootstenen en wastroggen |
| | | | | | | | | | |
| kledinghaak dubbel | | | | | | | | | |
| 0691909 | | chroom | 15821031 | stuk | 111,00 | 169 | 0 |  | Utiliteit |
| 0692255 | | inox | 15821142 | stuk | 143,00 | 169 | 1 | | |
| toiletset wand m. closetrolhouder + closetborstelgarnituur | | | | | | | | | |
| 0692417 | | chroom | 15767031 | stuk | 299,00 | 169 | 1 |  | |
| 0692425 | | inox | 15767142 | stuk | 388,00 | 169 | 1 | | |

| Art.nr | Specificaties | Kleur | Lev.nr | Ehd | Prijs | Grp | CC |
|--------|---------------|-------|--------|-----|-------|-----|----|
|--------|---------------|-------|--------|-----|-------|-----|----|

Gessi Quadro

toiletset wand m. zeepouder + handdoekhouder

| | | | | | | | |
|--------|--|--------|----------|------|--------|-----|---|
| 092433 | | chroom | 15773031 | stuk | 223,00 | 169 | 1 |
| 092441 | | inox | 15773142 | stuk | 289,00 | 169 | 1 |



toiletset wand m. zeepdispenser + handdoekhouder

| | | | | | | | |
|---------|--|--------|----------|------|--------|-----|---|
| 0692468 | | chroom | 15779031 | stuk | 313,00 | 169 | 1 |
| 0692476 | | inox | 15779142 | stuk | 406,00 | 169 | 1 |



toiletset staand

| | | | | | | | |
|---------|--|--------|----------|------|--------|-----|---|
| 0692484 | | chroom | 15827031 | stuk | 628,00 | 169 | 1 |
| 0692492 | | inox | 15827142 | stuk | 807,00 | 169 | 1 |



toiletset staand m. closetrolhouder + closetborstelgarnituur

| | | | | | | | |
|---------|--|--------|----------|------|--------|-----|---|
| 0692506 | | chroom | 15833031 | stuk | 315,00 | 169 | 1 |
| 0692514 | | inox | 15833142 | stuk | 408,00 | 169 | 1 |



Gessi Rettangolo

glashouder

| | | | | | | | |
|---------|--|--------------|----------|------|--------|-----|---|
| 0463232 | | chroom/wit | 20807031 | stuk | 180,00 | 169 | 1 |
| 0463348 | | inox/wit | 20807142 | stuk | 225,00 | 169 | 1 |
| 0463233 | | chroom/zwart | 20808031 | stuk | 180,00 | 169 | 1 |
| 0463349 | | inox/zwart | 20808142 | stuk | 225,00 | 169 | 1 |



glas los voor 20810

| | | | | | | | |
|---------|--|-----|----------|------|-------|-----|---|
| 0463292 | | wit | 21085031 | stuk | 36,00 | 169 | 1 |
|---------|--|-----|----------|------|-------|-----|---|

glas los voor 20811

| | | | | | | | |
|---------|--|-------|----------|------|-------|-----|---|
| 0463293 | | zwart | 21086031 | stuk | 36,00 | 169 | 1 |
|---------|--|-------|----------|------|-------|-----|---|

glashouder dubbel

| | | | | | | | |
|---------|--|--------------|----------|------|--------|-----|---|
| 0463234 | | chroom/wit | 20810031 | stuk | 192,00 | 169 | 1 |
| 0463350 | | inox/wit | 20810142 | stuk | 240,00 | 169 | 1 |
| 0463235 | | chroom/zwart | 20811031 | stuk | 192,00 | 169 | 1 |
| 0463351 | | inox/zwart | 20811142 | stuk | 240,00 | 169 | 1 |













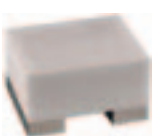









glas los voor 20810

| | | | | | | | |
|---------|--|-----|----------|------|-------|-----|---|
| 0463290 | | wit | 21083031 | stuk | 61,50 | 169 | 1 |
|---------|--|-----|----------|------|-------|-----|---|

glas los voor 20811

| | | | | | | | |
|---------|--|-------|----------|------|-------|-----|---|
| 0463291 | | zwart | 21084031 | stuk | 61,50 | 169 | 1 |
|---------|--|-------|----------|------|-------|-----|---|

| Art.nr | Specificaties | Kleur | Lev.nr | Ehd | Prijs | Grp | CC | | |
|--|---------------|--------------|----------|------|--------|-----|----|---|----------------------------------|
| | | | | | | | | Gessi Rettangolo | |
| glashouder staand | | | | | | | | | |
| 0463242 | | chroom/wit | 20831031 | stuk | 114,00 | 169 | 1 |  | Sanitair producten |
| 0463359 | | inox/wit | 20831142 | stuk | 137,00 | 169 | 1 | | |
| 0463243 | | chroom/zwart | 20832031 | stuk | 114,00 | 169 | 1 | | |
| 0463360 | | inox/zwart | 20832142 | stuk | 137,00 | 169 | 1 | | |
| 0463244 | | chroom/wit | 20834031 | stuk | 72,00 | 169 | 1 | | |
| 0463362 | | inox/wit | 20834142 | stuk | 86,50 | 169 | 1 | | |
| 0463245 | | chroom/zwart | 20835031 | stuk | 72,00 | 169 | 1 | | |
| 0463363 | | inox/zwart | 20835142 | stuk | 86,50 | 169 | 1 | | Kranen |
| zeephouder | | | | | | | | | |
| 0463229 | | chroom/wit | 20801031 | stuk | 180,00 | 169 | 0 |  | Douchegarnituur |
| 0463344 | | inox/wit | 20801142 | stuk | 225,00 | 169 | 1 | | |
| 0463230 | | chroom/zwart | 20802031 | stuk | 180,00 | 169 | 1 | | |
| 0463346 | | inox/zwart | 20802142 | stuk | 225,00 | 169 | 1 | | |
| zeepschaal los voor 20801 | | | | | | | | | |
| 0463288 | | wit | 21081031 | stuk | 52,00 | 169 | 1 | | Douchewanden |
| 0463289 | | zwart | 21082031 | stuk | 52,00 | 169 | 1 | | |
| zeepschaal | | | | | | | | | |
| 0463240 | | chroom/wit | 20825031 | stuk | 114,00 | 169 | 1 |  | Toebehoren & afvoeren |
| 0463357 | | inox/wit | 20825142 | stuk | 137,00 | 169 | 1 | | |
| 0463241 | | chroom/zwart | 20826031 | stuk | 114,00 | 169 | 1 | | |
| 0463358 | | inox/zwart | 20826142 | stuk | 137,00 | 169 | 1 | | |
| wandhouder | | | | | | | | | |
| 0463231 | | chroom | 20804031 | stuk | 144,00 | 169 | 1 |  | Spoel- & installatiesystemen |
| 0463347 | | inox | 20804142 | stuk | 189,00 | 169 | 1 | | |
| zeepdispenser | | | | | | | | | |
| 0463236 | | chroom/wit | 20813031 | stuk | 276,00 | 169 | 0 |  | Badkamermeubelen en toiletkasten |
| 0463352 | | inox/wit | 20813142 | stuk | 345,00 | 169 | 1 | | |
| 0463237 | | chroom/zwart | 20814031 | stuk | 276,00 | 169 | 1 | | |
| 0463354 | | inox/zwart | 20814142 | stuk | 345,00 | 169 | 1 | | |
| glas voor zeepdispenser 20813 | | | | | | | | | |
| 0463296 | | wit | 21089031 | stuk | 61,50 | 169 | 1 | | Utiliteit |
| glas voor zeepdispenser 20814 | | | | | | | | | |
| 0463297 | | zwart | 21090031 | stuk | 61,50 | 169 | 1 | | |
| zeepdispenser compleet voor 20813 | | | | | | | | | |
| 0463294 | | chroom/wit | 21087031 | stuk | 114,00 | 169 | 1 | | |
| 0463403 | | wit/inox | 21087142 | stuk | 148,00 | 169 | 1 | | |
| zeepdispenser compleet voor 20814 | | | | | | | | | |
| 0463295 | | chroom/zwart | 21088031 | stuk | 114,00 | 169 | 1 | | |
| 0463404 | | zwart/inox | 21088142 | stuk | 148,00 | 169 | 1 | | |
| zeepdispenser staand | | | | | | | | | |
| 0463246 | | chroom/wit | 20837031 | stuk | 198,00 | 169 | 1 |  | |
| 0463364 | | inox/wit | 20837142 | stuk | 238,00 | 169 | 1 | | |
| 0463247 | | chroom/zwart | 20838031 | stuk | 198,00 | 169 | 1 | | |
| 0463365 | | inox/zwart | 20838142 | stuk | 238,00 | 169 | 1 | | |
| planchet m. verex 60cm | | | | | | | | | |
| 0463273 | | chroom | 20945031 | stuk | 318,00 | 169 | 1 |  | |
| 0463387 | | inox | 20945142 | stuk | 413,00 | 169 | 1 | | |

| | Art.nr | Specificaties | Kleur | Lev.nr | Ehd | Prijs | Grp | CC |
|---|---|---------------|--------------|----------|------|--------|-----|----|
| Gessi Rettangolo | | | | | | | | |
| Sanitair producten | planchet draadmodel 30cm | | | | | | | |
| |  | 0463274 | chroom | 20947031 | stuk | 228,00 | 169 | 1 |
| | | 0463389 | inox | 20947142 | stuk | 296,00 | 169 | 1 |
| <hr/> | | | | | | | | |
| Baden / douchebakken / stoomcabines | planchet draadmodel 60cm | | | | | | | |
| |  | 0463275 | chroom | 20949031 | stuk | 300,00 | 169 | 1 |
| | | 0463390 | inox | 20949142 | stuk | 390,00 | 169 | 1 |
| <hr/> | | | | | | | | |
| Kranen | handdoekhouder 30cm | | | | | | | |
| |  | 0463261 | chroom | 20897031 | stuk | 189,00 | 169 | 1 |
| | | 0463377 | inox | 20897142 | stuk | 245,00 | 169 | 1 |
| <hr/> | | | | | | | | |
| Douchegarnituur | handdoekhouder 45cm | | | | | | | |
| |  | 0463262 | chroom | 20900031 | stuk | 195,00 | 169 | 1 |
| | | 0463378 | inox | 20900142 | stuk | 253,00 | 169 | 1 |
| <hr/> | | | | | | | | |
| Accessoires en spiegels | handdoekhouder 60cm | | | | | | | |
| |  | 0463263 | chroom | 20903031 | stuk | 203,00 | 169 | 1 |
| | | 0463379 | inox | 20903142 | stuk | 264,00 | 169 | 1 |
| <hr/> | | | | | | | | |
| Douchewanden | handdoekring 22cm | | | | | | | |
| |  | 0463265 | chroom | 20909031 | stuk | 144,00 | 169 | 0 |
| | | 0463380 | inox | 20909142 | stuk | 187,00 | 169 | 1 |
| <hr/> | | | | | | | | |
| Toebehoren & afvoeren | handdoekhouder dubbel | | | | | | | |
| |  | 0463266 | chroom | 20915031 | stuk | 180,00 | 169 | 1 |
| | | 0463381 | inox | 20915142 | stuk | 234,00 | 169 | 1 |
| <hr/> | | | | | | | | |
| Spoel- & installatiesystemen | handdoekhouder staand breedte=35cm | | | | | | | |
| |  | 0463270 | chroom | 20939031 | stuk | 562,00 | 169 | 1 |
| | | 0463385 | inox | 20939142 | stuk | 731,00 | 169 | 1 |
| <hr/> | | | | | | | | |
| Badkamermeubelen en toiletkasten | handdoekhouder staand breedte=60cm | | | | | | | |
| |  | 0463271 | chroom | 20941031 | stuk | 706,00 | 169 | 1 |
| | | 0463386 | inox | 20941142 | stuk | 918,00 | 169 | 1 |
| <hr/> | | | | | | | | |
| Gootstenen en wastroggen | handdoekhouder staand breedte=60cm | | | | | | | |
| |  | 0463271 | chroom | 20941031 | stuk | 706,00 | 169 | 1 |
| | | 0463386 | inox | 20941142 | stuk | 918,00 | 169 | 1 |
| <hr/> | | | | | | | | |
| Utiliteit | closetrolhouder z. klep | | | | | | | |
| |  | 0463253 | chroom | 20855031 | stuk | 144,00 | 169 | 1 |
| | | 0463370 | inox | 20855142 | stuk | 187,00 | 169 | 1 |
| <hr/> | | | | | | | | |
| | closetrolhouder m. klep | | | | | | | |
| |  | 0463252 | chroom | 20849031 | stuk | 204,00 | 169 | 0 |
| | | 0463369 | inox | 20849142 | stuk | 265,00 | 169 | 1 |
| <hr/> | | | | | | | | |
| | closetborstelgarnituur | | | | | | | |
| |  | 0463238 | chroom/wit | 20819031 | stuk | 240,00 | 169 | 0 |
| | | 0463355 | inox/wit | 20819142 | stuk | 300,00 | 169 | 1 |
| | | 0463239 | chroom/zwart | 20820031 | stuk | 240,00 | 169 | 1 |
| | | 0463356 | inox/zwart | 20820142 | stuk | 300,00 | 169 | 1 |

| Art.nr | Specificaties | Kleur | Lev.nr | Ehd | Prijs | Grp | CC | |
|--|---------------|-------------|----------|------|--------|-----|----|---|
| Gessi Rettangolo | | | | | | | | |
| closetborstelhouder los voor 20819 | | | | | | | | |
| 0463298 | | wit | 21091031 | stuk | 77,50 | 169 | 1 |  |
| closetborstelhouder los voor 20820 | | | | | | | | |
| 0463300 | | zwart | 21092031 | stuk | 77,50 | 169 | 1 | |
| closetborstelgarnituur staand | | | | | | | | |
| 0463250 | | chrom/wit | 20843031 | stuk | 174,00 | 169 | 1 | |
| 0463367 | | inox/wit | 20843142 | stuk | 209,00 | 169 | 1 | |
| closetborstelgarnituur | | | | | | | | |
| 0463251 | | chrom/zwart | 20844031 | stuk | 174,00 | 169 | 1 | |
| 0463368 | | inox/zwart | 20844142 | stuk | 209,00 | 169 | 1 | |
| closetborstelgarnituur m. closetrolhouder | | | | | | | | |
| 0463254 | | chrom/wit | 20867031 | stuk | 348,00 | 169 | 1 |  |
| 0463255 | | chrom/zwart | 20868031 | stuk | 348,00 | 169 | 1 | |
| 0463371 | | inox/wit | 20867142 | stuk | 452,00 | 169 | 1 | |
| 0463372 | | inox/zwart | 20868142 | stuk | 452,00 | 169 | 1 | |
| zeephouder m. handdoekhouder | | | | | | | | |
| 0463257 | | chrom/wit | 20873031 | stuk | 288,00 | 169 | 1 |  |
| 0463373 | | inox/wit | 20873142 | stuk | 374,00 | 169 | 1 | |
| 0463258 | | chrom/zwart | 20874031 | stuk | 288,00 | 169 | 1 | |
| 0463374 | | inox/zwart | 20874142 | stuk | 374,00 | 169 | 1 | |
| zeepdispenser m. handdoekhouder | | | | | | | | |
| 0463259 | | chrom/wit | 20879031 | stuk | 384,00 | 169 | 1 |  |
| 0463375 | | inox/wit | 20879142 | stuk | 499,00 | 169 | 1 | |
| 0463260 | | chrom/zwart | 20880031 | stuk | 384,00 | 169 | 1 | |
| 0463376 | | inox/zwart | 20880142 | stuk | 499,00 | 169 | 1 | |
| closetborstelgarnituur m. closetrolhouder | | | | | | | | |
| 0463268 | | chrom/wit | 20933031 | stuk | 359,00 | 169 | 1 |  |
| 0463383 | | inox/wit | 20933142 | stuk | 466,00 | 169 | 1 | |
| 0463269 | | chrom/zwart | 20934031 | stuk | 359,00 | 169 | 1 | |
| 0463384 | | inox/zwart | 20934142 | stuk | 466,00 | 169 | 1 | |
| haak | | | | | | | | |
| 0463267 | | chrom | 20921031 | stuk | 84,00 | 169 | 0 |  |
| 0463382 | | inox | 20921142 | stuk | 109,00 | 169 | 1 | |
| lamp | | | | | | | | |
| 0463278 | | chrom | 20978031 | stuk | 563,00 | 169 | 1 |  |
| 0463393 | | inox | 20978142 | stuk | 704,00 | 169 | 1 | |
| spiegel staand H=169cm | | | | | | | | |
| 0463279 | | chrom | 20987031 | stuk | 803,00 | 169 | 1 |  |
| 0463394 | | inox | 20987142 | stuk | 923,00 | 169 | 1 | |

Sanitair producten

Baden /
douchebakken /
stoomcabines

Kranen

Douchegarnituur

Accessoires en
spiegels

Douchewanden

Toebehoren &
afvoeren









Spoel- &
installatiesystemen





Badkamermeubelen
en toiletkasten



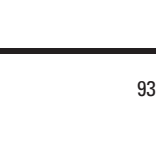







Gootstenen en
wastroggen



Utiliteit









| | Art.nr | Specificaties | Kleur | Lev.nr | Ehd | Prijs | Grp | CC | |
|-------------------------------------|---|--|-------|--------------|----------|-------|---------|-------|---|
| Gessi Rettangolo | | | | | | | | | |
| Sanitair producten |  | spiegel vergrotend 38cm verstelbaar | | | | | | | |
| | | 0463281 | | chroom | 20988031 | stuk | 300,00 | 169 | 1 |
| | | 0463395 | | inox | 20988142 | stuk | 360,00 | 169 1 | |
| <hr/> | | | | | | | | | |
| Kranen |  | papierkorf | | | | | | | |
| | | 0463286 | | chroom/wit | 20990031 | stuk | 312,00 | 169 | 1 |
| | | 0463401 | | inox/wit | 20990142 | stuk | 343,00 | 169 | 1 |
| | | 0463287 | | chroom/zwart | 20991031 | stuk | 312,00 | 169 | 1 |
| | | 0463402 | | inox/zwart | 20991142 | stuk | 343,00 | 169 1 | |
| <hr/> | | | | | | | | | |
| Douchegarnituur |  | hoekkorf | | | | | | | |
| | | 0463249 | | chroom | 20861031 | stuk | 239,00 | 169 | 1 |
| | | 0463366 | | inox | 20861142 | stuk | 310,00 | 169 1 | |
| <hr/> | | | | | | | | | |
| Douchewanden |  | spiegel 36x36cm | | | | | | | |
| | | 0463282 | | chroom | 20993031 | stuk | 416,00 | 169 | 1 |
| | | 0463397 | | inox | 20993142 | stuk | 437,00 | 169 1 | |
| <hr/> | | | | | | | | | |
| Spiegel 54x36cm |  | spiegel 54x36cm | | | | | | | |
| | | 0463283 | | chroom | 20994031 | stuk | 534,00 | 169 | 1 |
| | | 0463398 | | inox | 20994142 | stuk | 560,00 | 169 1 | |
| <hr/> | | | | | | | | | |
| Spiegel 36x90cm |  | spiegel 36x90cm | | | | | | | |
| | | 0463284 | | chroom | 20995031 | stuk | 689,00 | 169 | 1 |
| | | 0463399 | | inox | 20995142 | stuk | 724,00 | 169 1 | |
| <hr/> | | | | | | | | | |
| Spiegel 72x36cm |  | spiegel 72x36cm | | | | | | | |
| | | 0463285 | | chroom | 20996031 | stuk | 635,00 | 169 | 1 |
| | | 0463400 | | inox | 20996142 | stuk | 667,00 | 169 1 | |
| <hr/> | | | | | | | | | |
| Hocker 44x31.5cm |  | hocker 44x31.5cm | | | | | | | |
| | | 0463276 | | chroom | 20981031 | stuk | 779,00 | 169 | 1 |
| | | 0463391 | | inox | 20981142 | stuk | 1013,00 | 169 1 | |
| <hr/> | | | | | | | | | |
| Bank 44x101.5cm |  | bank 44x101.5cm | | | | | | | |
| | | 0463277 | | chroom | 20984031 | stuk | 1138,00 | 169 | 1 |
| | | 0463392 | | inox | 20984142 | stuk | 1480,00 | 169 1 | |
| <hr/> | | | | | | | | | |
| Gessi Onderdelen accessoires | | | | | | | | | |
| | 0461499 | montageblokje voor accessoires | | 0461499 | stuk | 0,01 | 169 | 0 | |

| Art.nr | Specificaties | Kleur | Lev.nr | Ehd | Prijs | Grp | CC | | |
|---|---------------|--------|----------|------|-------|-----|----|---|---|
| | | | | | | | | Haceka Balance | |
| glashouder dubbel 0600289 | | chroom | 23080110 | stuk | 25,25 | 241 | 1 |  | Sanitair producten |
| zeephouder m. acryl inzet 0600287 | | chroom | 23030110 | stuk | 21,00 | 241 | 1 |  | Baden / douchebakken / stoomcabines |
| zeepdispenser 0600294 | | chroom | 23160110 | stuk | 21,00 | 241 | 1 |  | Kranen |
| planchet 59cm 0600286 | | chroom | 23010110 | stuk | 29,50 | 241 | 1 |  | Douchegarnituur |
| combiplanchet 0600299 | | chroom | 23230110 | stuk | 50,50 | 241 | 1 |  | Accessoires en spiegels |
| badgreep 28cm 0600288 | | chroom | 23070110 | stuk | 32,00 | 241 | 1 |  | Douchewanden |
| handdoekhouder 0600290 | | chroom | 23090110 | stuk | 33,75 | 241 | 1 |  | Toebehoren & afvoeren |
| 2-lids handdoekhouder draaibaar 0600291 | | chroom | 23110110 | stuk | 29,50 | 241 | 1 |  | Spoel- & installatiesystemen |
| closetrolhouder 0600293 | | chroom | 23140110 | stuk | 17,00 | 241 | 1 |  | Badkamermeubelen en toiletkasten |
| closetrolhouder m. klep 0600292 | | chroom | 23130110 | stuk | 25,25 | 241 | 1 |  | Gootstenen en wastroggen |
| closetborstelgarnituur 0600298 | | chroom | 23190110 | stuk | 29,50 | 241 | 1 | | Utiliteit |

| | Art.nr | Specificaties | Kleur | Lev.nr | Ehd | Prijs | Grp | CC |
|---|---|--|--------------|----------|------|-------|-----|----|
| Sanitair producten | Haceka Balance | | | | | | | |
| |  | dubbele haak 0600297 | chrom | 23180110 | stuk | 16,00 | 241 | 1 |
| Baden / douchebakken / stoomcabines | | vochtige tissuehouder 0600300 | chrom | 23300110 | stuk | 25,25 | 241 | 1 |
| Kranen | | glasplaat voor planchet 59cm 0600301 | | 3010190 | stuk | 7,40 | 241 | 1 |
| Douchegarnituur | | glas voor houder 0600302 | | 23020190 | stuk | 5,90 | 241 | 1 |
| Accessoires en spiegels | | acryl opzet voor 2308 0600303 | | 23080190 | stuk | 2,48 | 241 | 1 |
| | | zeepschaal acryl 0600304 | | 23030190 | stuk | 4,16 | 241 | 1 |
| Douchewanden | | flacon voor zeepdispenser 0600305 | chrom | 23160190 | stuk | 12,00 | 241 | 1 |
| Toebehoren & afvoeren | | closetborstel 0600306 | chrom | 6190390 | stuk | 11,75 | 241 | 1 |
| Spoel- & installatiesystemen | | decorelement 0600309 | golf mat | 23810190 | stuk | 1,64 | 241 | 1 |
| | | 0600310 | stripe chrom | 23810290 | stuk | 1,64 | 241 | 1 |
| | | glasplaat voor combiplanchet 0600311 | | 23230190 | stuk | 6,70 | 241 | 1 |
| Badkamermeubelen en toiletkasten | Haceka Fiji | | | | | | | |
| |  | bekerhouder m. beker mat 0600125 | chrom | 6020110 | stuk | 10,50 | 241 | 1 |
| Gootstenen en wastroggen | | dubbele bekerhouder m. beker mat 0600128 | chrom | 6080110 | stuk | 16,00 | 241 | 1 |
| Utiliteit |  | | | | | | | |
| |  | zeephouder m. acryl inzet mat 0600126 | chrom | 6030110 | stuk | 11,00 | 241 | 1 |
| |  | zeepdispenser wandmodel mat 0600134 | chrom | 6160110 | stuk | 16,25 | 241 | 1 |







| Art.nr | Specificaties | Kleur | Lev.nr | Ehd | Prijs | Grp | CC | | |
|---|---------------|--------|---------|------|-------|-----|----|---|---|
| | | | | | | | | Haceka Fiji | |
| draadzeephouder 0600130 | | chroom | 6100110 | stuk | 13,25 | 241 | 1 |  | Sanitair producten |
| planchet 50cm m. mat glas 0600124 | | chroom | 6010110 | stuk | 23,50 | 241 | 1 |  | Baden / douchebakken / stoomcabines |
| handdoekhouder 60cm 0600129 | | chroom | 6090110 | stuk | 22,50 | 241 | 1 |  | Kranen |
| 2-lids handdoekhouder draaibaar 0600131 | | chroom | 6110110 | stuk | 19,75 | 241 | 1 |  | Douchegarnituur |
| handdoekring 0600127 | | chroom | 6060110 | stuk | 12,25 | 241 | 1 |  | Accessoires en spiegels |
| closetrolhouder m. klep 0600132 | | chroom | 6130110 | stuk | 18,00 | 241 | 1 |  | Douchewanden |
| closetrolhouder z. klep 0600133 | | chroom | 6140110 | stuk | 11,00 | 241 | 1 |  | Toebehoren & afvoeren |
| reserverolhouder 0600137 | | chroom | 6240110 | stuk | 9,10 | 241 | 1 |  | Spoel- & installatiesystemen |
| closetborstelgarnituur m. mat inzet 0600136 | | chroom | 6190110 | stuk | 22,50 | 241 | 1 |  | Badkamermeubelen en toiletkasten |
| handdoekhaak 0600135 | | chroom | 6180110 | stuk | 8,20 | 241 | 1 |  | Gootstenen en wastroggen |
| kapstokje 0600138 | | chroom | 6250110 | stuk | 10,50 | 241 | 1 |  | Utiliteit |

| | Art.nr | Specificaties | Kleur | Lev.nr | Ehd | Prijs | Grp | CC | |
|---|---|---------------|----------------|----------------|----------|-------|-------|-----|---|
| Haceka Fiji | | | | | | | | | |
| Sanitair producten | glasplaat voor planchet 50cm | | | | | | | | |
| | 0600139 | | mat | 870190 | stuk | 6,10 | 241 | 1 | |
| | 0600140 | | transparant | 870290 | stuk | 6,10 | 241 | 1 | |
| Baden / douchebakken / stoomcabines | beker | | | | | | | | |
| | 0600141 | | mat | 6020190 | stuk | 1,05 | 241 | 1 | |
| | 0600142 | | transparant | 6020290 | stuk | 1,05 | 241 | 1 | |
| Kranen | zeepschaal acryl | | | | | | | | |
| | 0600143 | | mat | 6030190 | stuk | 1,26 | 241 | 1 | |
| | 0600144 | | transparant | 6030290 | stuk | 1,26 | 241 | 1 | |
| Douchegarnituur | glazen inzet voor 619 | | | | | | | | |
| | 0600146 | | mat | 6190190 | stuk | 2,73 | 241 | 1 | |
| | 0600147 | | transparant | 6190290 | stuk | 2,73 | 241 | 1 | |
| Haceka Iris | | | | | | | | | |
| Accessoires en spiegels | glas-/tandenborstelhouder m. glas | | | | | | | | |
| |  | 0641238 | | chroom/matchr. | 14047110 | stuk | 19,25 | 241 | 1 |
| | | 0642375 | | chroom/hout | 14049110 | stuk | 19,25 | 241 | 1 |
| | 0642037 | | chroom | 14040110 | stuk | 19,25 | 241 | 1 | |
| Douchewanden | zeephouder m. inzet | | | | | | | | |
| |  | 0642029 | | chroom | 14030110 | stuk | 18,00 | 241 | 1 |
| | | 0641239 | | chroom/matchr. | 14037110 | stuk | 18,00 | 241 | 1 |
| | 0642371 | | chroom/hout | 14039110 | stuk | 18,00 | 241 | 1 | |
| Toebehoren & afvoeren | zeephouder draadmodel | | | | | | | | |
| |  | 0642061 | | chroom | 14100110 | stuk | 21,00 | 241 | 1 |
| | | 0600214 | | chroom/matchr. | 14107110 | stuk | 21,00 | 241 | 1 |
| | 0642376 | | chroom/hout | 14109110 | stuk | 21,00 | 241 | 1 | |
| Spool- & installatiesystemen | 2-lids handdoekhouder draaibaar | | | | | | | | |
| |  | 0641229 | | chroom/matchr. | 14117110 | stuk | 27,25 | 241 | 1 |
| | | 0642374 | | chroom/hout | 14119110 | stuk | 27,25 | 241 | 1 |
| | 0642088 | | chroom | 14110110 | stuk | 27,25 | 241 | 1 | |
| Badkamermeubelen en toiletkasten | planchet 60cm | | | | | | | | |
| |  | 0641995 | | chroom | 14010110 | stuk | 23,00 | 241 | 1 |
| | | 0600212 | | chroom/matchr. | 14017110 | stuk | 23,00 | 241 | 1 |
| | 0600219 | | chroom/hout | 14019110 | stuk | 23,00 | 241 | 1 | |
| Gootstenen en wastroggen | spiegelhouder per paar | | | | | | | | |
| |  | 0642150 | | chroom | 14200110 | paar | 31,00 | 241 | 1 |
| | 0600215 | | chroom/matchr. | 14207110 | stuk | 31,00 | 241 | 1 | |
| Utiliteit | closetrolhouder z. klep | | | | | | | | |
| |  | 0641230 | | chroom/matchr. | 14147110 | stuk | 16,00 | 241 | 1 |
| | | 0642362 | | chroom/hout | 14149110 | stuk | 16,00 | 241 | 1 |
| | 0642134 | | chroom | 14140110 | stuk | 16,00 | 241 | 1 | |
| | closetrolhouder m. klep | | | | | | | | |
| |  | 0641235 | | chroom/matchr. | 14137110 | stuk | 25,25 | 241 | 1 |
| | | 0642369 | | chroom/hout | 14139110 | stuk | 25,25 | 241 | 1 |
| | 0642138 | | chroom | 14130110 | stuk | 25,25 | 241 | 1 | |
| | reserverolhouder | | | | | | | | |
| |  | 0642185 | | chroom | 14240110 | stuk | 13,25 | 241 | 1 |
| | | 0600216 | | chroom/matchr. | 14247110 | stuk | 13,25 | 241 | 1 |
| | 0600222 | | chroom/hout | 14249110 | stuk | 13,25 | 241 | 1 | |

| Art.nr | Specificaties | Kleur | Lev.nr | Ehd | Prijs | Grp | CC | | |
|-------------------------------------|---------------|----------------|----------|------|-------|-----|----|---|---|
| | | | | | | | | Haceka Iris | |
| closetborstelgarnituur | | | | | | | | | |
| 0641234 | | chroom/matchr. | 14197110 | stuk | 27,75 | 241 | 1 |  | Sanitair producten |
| 0642367 | | chroom/hout | 14199110 | stuk | 27,75 | 241 | 1 | | Baden / douchebakken / stoomcabines |
| 0642142 | | chroom | 14190110 | stuk | 27,75 | 241 | 1 | | |
| handdoekhouder 60cm dubbel | | | | | | | | | |
| 0642215 | | chroom | 14290110 | stuk | 42,50 | 241 | 1 |  | Kranen |
| 0642378 | | chroom/hout | 14299110 | stuk | 42,50 | 241 | 1 | | |
| 0600218 | | chroom | 14297110 | stuk | 42,50 | 241 | 1 | | |
| handdoekhouder 60cm | | | | | | | | | |
| 0641237 | | chroom/matchr. | 14097110 | stuk | 29,00 | 241 | 1 |  | Douchegarnituur |
| 0642053 | | chroom | 14090110 | stuk | 29,00 | 241 | 1 | | |
| 0600221 | | chroom/hout | 14099110 | stuk | 29,00 | 241 | 1 | | |
| garderobehaak m. 2 haakjes | | | | | | | | | |
| 0642193 | | chroom | 14250110 | stuk | 16,75 | 241 | 1 |  | Accessoires en spiegels |
| kapstokje | | | | | | | | | |
| 0600217 | | chroom | 14257110 | stuk | 16,75 | 241 | 1 |  | Douchewanden |
| 0600223 | | hout/chroom | 14259110 | stuk | 16,75 | 241 | 1 | | |
| garderobehaak per paar | | | | | | | | | |
| 0641236 | | chroom/matchr. | 14127110 | stuk | 12,00 | 241 | 1 |  | Toebehoren & afvoeren |
| 0642377 | | chroom/hout | 14129110 | stuk | 12,00 | 241 | 1 | | |
| 0642126 | | chroom | 14120110 | paar | 12,00 | 241 | 1 | | |
| gastendoekhouder 25cm | | | | | | | | | |
| 0642045 | | chroom | 14060110 | stuk | 15,00 | 241 | 1 |  | Spoel- & installatiesystemen |
| 0600213 | | | 14067110 | stuk | 15,00 | 241 | 1 | | |
| 0600220 | | hout/chroom | 14069110 | stuk | 15,00 | 241 | 1 | | |
| decorrozet 4 stuks | | | | | | | | | |
| 0642304 | | chroom | 14810630 | stuk | 6,70 | 241 | 1 | | Badkamermeubelen en toiletkasten |
| 0642320 | | verguld | 14813230 | stuk | 6,70 | 241 | 1 | | |
| 0642266 | | wit | 14810530 | stuk | 3,99 | 241 | 1 | | |
| 0642339 | | zwart | 14813630 | stuk | 3,99 | 241 | 1 | | |
| glasplaat voor planchet 60cm | | | | | | | | | |
| 0600200 | | mat | 14010190 | stuk | 6,70 | 241 | 1 | | Gootstenen en wastroggen |
| zeepschaal acryl | | | | | | | | | |
| 0600203 | | mat | 14030190 | stuk | 3,99 | 241 | 1 | | Utiliteit |
| 0600204 | | transparant | 14030290 | stuk | 3,99 | 241 | 1 | | |
| inzet los voor 1404 | | | | | | | | | |
| 0642062 | | | 14040190 | stuk | 6,70 | 241 | 1 | | |
| inzet acryl transparant | | | | | | | | | |
| 0600205 | | | 14040290 | stuk | 3,99 | 241 | 1 | | |
| inzet acryl voor 1419 | | | | | | | | | |
| 0600206 | | mat | 14190190 | stuk | 5,90 | 241 | 1 | | |
| 0600207 | | transparant | 14190290 | stuk | 5,90 | 241 | 1 | | |
| bol voor 1422 | | | | | | | | | |
| 0600209 | | | 14220190 | stuk | 12,00 | 241 | 1 | | |
| | | | | | | | | Haceka Kosmos | |
| glashouder m. glas | | | | | | | | | |
| 0600010 | | chroom | 25020110 | stuk | 14,00 | 241 | 1 |  | |
| 0600076 | | tec | 25024510 | stuk | 16,75 | 241 | 1 | | |

Accessoires Haceka

| | Art.nr | Specificaties | Kleur | Lev.nr | Ehd | Prijs | Grp | CC |
|---|--|---------------|--------|----------|------|-------|-----|----|
| | Haceka Kosmos | | | | | | | |
| Sanitair producten | glashouder dubbel m. glas | | | | | | | |
| | 0600029 | | chroom | 25080110 | stuk | 21,25 | 241 | 1 |
| | 0600080 | | tec | 25084510 | stuk | 24,00 | 241 | 1 |
| Baden / douchebakken / stoomcabines | zeephouder m. glazen inzet | | | | | | | |
| | 0600017 | | chroom | 25030110 | stuk | 14,00 | 241 | 1 |
| Kranen | 0600077 | | tec | 25034510 | stuk | 16,75 | 241 | 1 |
| | zeephouder draadmodel | | | | | | | |
| Douchegarnituur | 0600038 | | chroom | 25100110 | stuk | 12,00 | 241 | 1 |
| | 0600084 | | tec | 25104510 | stuk | 16,00 | 241 | 1 |
| Accessoires en spiegels | zeepdispenser opaalglas | | | | | | | |
| | 0600043 | | chroom | 25160110 | stuk | 20,50 | 241 | 1 |
| Douchewanden | 0600097 | | rvs | 25164510 | stuk | 24,00 | 241 | 1 |
| | zeepdispenser geheel metaal | | | | | | | |
| Toebehoren & afvoeren | 0600045 | | chroom | 25160210 | stuk | 21,00 | 241 | 1 |
| | 0600098 | | rvs | 25164610 | stuk | 26,00 | 241 | 1 |
| Spoel- & installatiesystemen | planchet m. glasplaat 60cm | | | | | | | |
| | 0600009 | | chroom | 25010110 | stuk | 27,75 | 241 | 1 |
| Badkamermeubelen en toiletkasten | 0600075 | | tec | 25014510 | stuk | 32,50 | 241 | 1 |
| | 2-lids handdoekhouder draaibaar | | | | | | | |
| Gootstenen en wastroggen | 0600039 | | chroom | 25110110 | stuk | 20,50 | 241 | 1 |
| | 0600090 | | tec | 25114510 | stuk | 24,00 | 241 | 1 |
| Utiliteit | handdoekhouder 60cm | | | | | | | |
| | 0600031 | | chroom | 25090110 | stuk | 21,25 | 241 | 1 |
| | 0600082 | | tec | 25094510 | stuk | 26,00 | 241 | 1 |
| | handdoekring | | | | | | | |
| | 0600027 | | chroom | 25060110 | stuk | 14,75 | 241 | 1 |
| | 0600078 | | tec | 25064510 | stuk | 16,75 | 241 | 1 |
| | handdoekhouder 60cm dubbel | | | | | | | |
| | 0600051 | | chroom | 25290110 | stuk | 23,25 | 241 | 1 |
| | 0600103 | | tec | 25294510 | stuk | 27,75 | 241 | 1 |
| | badgreep 25cm | | | | | | | |
| | 0600028 | | chroom | 25070110 | stuk | 20,50 | 241 | 1 |
| | 0600079 | | tec | 25074510 | stuk | 23,25 | 241 | 1 |
| | closetborstelgarnituur wand | | | | | | | |
| | 0600049 | | chroom | 25190210 | stuk | 27,75 | 241 | 1 |
| | 0600101 | | tec | 25194610 | stuk | 32,50 | 241 | 1 |

| Art.nr | Specificaties | Kleur | Lev.nr | Ehd | Prijs | Grp | CC | |
|--|---------------|--------|----------|------|-------|-----|----|---|
| | | | | | | | | Haceka Kosmos |
| closetborstelgarnituur m. glas inzet | | | | | | | | |
| 0600047 | | chroom | 25190110 | stuk | 27,00 | 241 | 1 |  |
| 0600100 | | tec | 25194510 | stuk | 30,25 | 241 | 1 | |
| closetrolhouder m. klep | | | | | | | | |
| 0600041 | | chroom | 25130110 | stuk | 16,75 | 241 | 1 |  |
| 0900092 | | tec | 25134510 | stuk | 19,50 | 241 | 1 | |
| closetrolhouder z. klep | | | | | | | | |
| 0600042 | | chroom | 25140110 | stuk | 12,75 | 241 | 1 |  |
| 0600093 | | tec | 25144510 | stuk | 15,75 | 241 | 1 | |
| reserverolhouder | | | | | | | | |
| 0600050 | | chroom | 25240110 | stuk | 10,25 | 241 | 1 |  |
| 0600102 | | tec | 25244510 | stuk | 13,00 | 241 | 1 | |
| dubbele haak | | | | | | | | |
| 0600046 | | chroom | 25180110 | stuk | 10,25 | 241 | 1 |  |
| 0600099 | | tec | 25184510 | stuk | 12,00 | 241 | 1 | |
| vochtige tissuehouder | | | | | | | | |
| 0600052 | | chroom | 25300110 | stuk | 21,25 | 241 | 1 |  |
| 0600104 | | tec | 25304510 | stuk | 26,00 | 241 | 1 | |
| glasplaat 60cm los | | | | | | | | |
| 0600053 | | chroom | 25010190 | stuk | 8,00 | 241 | 1 | |
| glas los voor houder | | | | | | | | |
| 0600054 | | chroom | 25020190 | stuk | 3,78 | 241 | 1 | |
| zeepschaal los | | | | | | | | |
| 0600055 | | chroom | 25030190 | stuk | 3,78 | 241 | 1 | |
| borstel + steel los voor closetborstelgarnituur | | | | | | | | |
| 0600056 | | | 25190190 | stuk | 12,00 | 241 | 1 | |
| pot los | | | | | | | | |
| 0600057 | | | 25190290 | stuk | 9,90 | 241 | 1 | |
| flacon los voor zeepdispenser | | | | | | | | |
| 0600072 | | | 25160190 | stuk | 12,00 | 241 | 1 | |
| bakje acryl, mat voor 330 | | | | | | | | |
| 0600074 | | | 23300190 | stuk | 4,62 | 241 | 1 | |

Sanitair producten

Baden /
douchebakken /
stoomcabines

Kranen

Douchegarnituur

Accessoires en
spiegels

Douchewanden

Toebehoren &
afvoeren









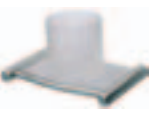

Spoel- &
installatiesystemen





Badkamermeubelen
en toiletkasten

Gootstenen en
wastroggen







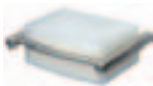

Utiliteit











Accessoires Haceka







| | Art.nr | Specificaties | Kleur | Lev.nr | Ehd | Prijs | Grp | CC |
|---|---|---|----------|----------|-------|-------|-----|----|
| Sanitair producten | Haceka Silence | | | | | | | |
| | | glashouder m. glas vrijstaand 0600273 | RVS | 22323510 | stuk | 17,00 | 241 | 1 |
| Baden / douchebakken / stoomcabines | | glashouder m. glas 0600261 | RVS | 22023510 | stuk | 25,25 | 241 | 1 |
| | Kranen |  | | | | | | |
| Douchegarnituur | | zeepouder m. acryl inzet vrijstaand 0600274 | RVS | 22333510 | stuk | 17,00 | 241 | 1 |
| | |  | | | | | | |
| Accessoires en spiegels | | zeepouder m. acryl inzet 0600262 | RVS | 22033510 | stuk | 29,50 | 241 | 1 |
| |  | | | | | | | |
| Douchewanden | | zeepdispenser vrijstaand 0600275 | RVS | 22463510 | stuk | 29,50 | 241 | 1 |
| |  | | | | | | | |
| Toebehoren & afvoeren | | zeepdispenser 0600268 | RVS | 22163510 | stuk | 33,50 | 241 | 1 |
| |  | | | | | | | |
| Badkamermeubelen en toiletkasten | | planchet 60cm 0600260 | RVS | 22013510 | stuk | 42,00 | 241 | 1 |
| |  | | | | | | | |
| Gootstenen en wastroggen | | haak per 2 stuks 0600269 | RVS | 22183510 | stuk | 21,00 | 241 | 1 |
| |  | | | | | | | |
| Utiliteit | | 2-lids handdoekhouder draaibaar 0600265 | RVS | 22113510 | stuk | 37,75 | 241 | 1 |
| | |  | | | | | | |
| | | handdoekhouder 0600264 | RVS | 22093510 | stuk | 42,00 | 241 | 1 |
| |  | | | | | | | |
| | handdoekring 0600263 | RVS | 22063510 | stuk | 25,25 | 241 | 1 | |
| |  | | | | | | | |











| Art.nr | Specificaties | Kleur | Lev.nr | Ehd | Prijs | Grp | CC | | |
|---|---------------|-------|----------|------|-------|-----|----|---|---|
| | | | | | | | | Haceka Silence | |
| closetrolhouder m. klep 0600266 | | RVS | 22133510 | stuk | 35,25 | 241 | 1 |  | Sanitair producten |
| closetrolhouder 0600267 | | RVS | 22143510 | stuk | 25,25 | 241 | 1 |  | Baden / douchebakken / stoomcabines |
| closetborstelgarnituur 0600270 | | RVS | 22193510 | stuk | 59,00 | 241 | 1 |  | Kranen |
| closetborstelgarnituur staand 0600271 | | RVS | 22193610 | stuk | 55,50 | 241 | 1 |  | Douchegarnituur |
| vochtige tissuehouder 0600272 | | RVS | 22303510 | stuk | 30,50 | 241 | 1 |  | Accessoires en spiegels |
| glasplaat voor planchet 50cm 0600276 | | | 22010190 | stuk | 9,20 | 241 | 1 | | Douchewanden |
| glas voor houder 0600277 | | | 22020190 | stuk | 7,20 | 241 | 1 | | Toebehoren & afvoeren |
| inzet acryl mat 0600278 | | | 22020290 | stuk | 3,78 | 241 | 1 | | Spoel- & installatiesystemen |
| zeepschaal acryl mat 0600279 | | | 22030190 | stuk | 4,62 | 241 | 1 | | Badkamermeubelen en toiletkasten |
| flacon zeepdispenser 0600280 | | RVS | 22160190 | stuk | 16,00 | 241 | 1 | | Gootstenen en wastroggen |
| inzet acryl voor 2219 mat 0600281 | | | 22190190 | stuk | 4,83 | 241 | 1 | | Utiliteit |
| glazen inzet voor 2219 mat 0600282 | | | 22190290 | stuk | 3,78 | 241 | 1 | | |
| closetborstel m. steel 0600283 | | | 22190390 | stuk | 15,00 | 241 | 1 | | |
| closetborstel z. steel 0600284 | | | 22190490 | stuk | 2,94 | 241 | 1 | | |
| bakje acryl mat voor 2230 0600285 | | | 22300190 | stuk | 5,30 | 241 | 1 | | |

Accessoires Haceka

| | Art.nr | Specificaties | Kleur | Lev.nr | Ehd | Prijs | Grp | CC |
|---|---|---|---|---------|--------|-------|-------|-----|
| Sanitair producten | Haceka Standaard | | | | | | | |
| |  | zeephouder m. inzet 0640867 | chroom/wit | 575000 | stuk | 6,30 | 241 | 0 |
| Baden / douchebakken / stoomcabines | | inzet voor zeephouder kunststof 0640875 | | 575090 | stuk | 1,39 | 241 | 0 |
| | Kranen |  | zeephouder draadmodel 0640859 | chroom | 560200 | stuk | 10,50 | 241 |
| Douchegarnituur | |  | planchet 50cm 0641359 | chroom | 870100 | stuk | 33,00 | 241 |
| Accessoires en spiegels |  | badgreep 25cm 0640395 | chroom | 200100 | stuk | 11,75 | 241 | 0 |
| | | badgreep 30cm 0640409 | chroom | 200200 | stuk | 12,50 | 241 | 0 |
| Douchewanden |  | closetrolhouder z. klep 0640220 | chroom | 70100 | stuk | 4,66 | 241 | 0 |
| | | 0640271 | chroom | 100100 | stuk | 10,75 | 241 | 0 |
| Toebehoren & afvoeren |  | closetrolhouder m. klep 0640360 | chroom | 190100 | stuk | 14,25 | 241 | 1 |
| Spoel- & installatiesystemen | | rolletje voor closetrolhouder 0609999 | | 190190 | stuk | 1,60 | 241 | 1 |
| Badkamermeubelen en toiletkasten |  | handdoekhaak m. schroef 0640506 | chroom | 310100 | stuk | 2,48 | 241 | 0 |
| Gootstenen en wastroggen | | Haceka Thema | | | | | | |
| |  | glashouder enkel m. glas 0640042 | chroom | 5020110 | stuk | 14,75 | 241 | 1 |
| Utiliteit |  | glashouder dubbel m. glas 0640123 | chroom | 5080110 | stuk | 20,25 | 241 | 1 |

| Art.nr | Specificaties | Kleur | Lev.nr | Ehd | Prijs | Grp | CC | | |
|---|---------------|--------|---------|------|-------|-----|----|---|---|
| | | | | | | | | Haceka Thema | |
| glas-/tandenborstelhouder 0640085 | | chroom | 5040110 | stuk | 21,50 | 241 | 1 |  | Sanitair producten |
| zeephouder m. acryl inzet 0641626 | | chroom | 5030110 | stuk | 21,50 | 241 | 1 |  | Baden / douchebakken / stoomcabines |
| zeephouder draadmodel 0640166 | | chroom | 5100110 | stuk | 21,25 | 241 | 0 |  | Kranen |
| zeepdispenser 0642436 | | chroom | 5160110 | stuk | 20,75 | 241 | 1 | | Douchegarnituur |
| planchet 50cm m. raam 0642428 | | chroom | 5010210 | stuk | 43,75 | 241 | 0 |  | Accessoires en spiegels |
| planchet 60cm 0640034 | | chroom | 5010110 | stuk | 28,75 | 241 | 1 |  | Douchewanden |
| 2-lids handdoekhouder draaibaar 0640182 | | chroom | 5110110 | stuk | 23,50 | 241 | 0 |  | Toebehoren & afvoeren |
| handdoekring 0640093 | | chroom | 5060110 | stuk | 16,25 | 241 | 0 |  | Spoel- & installatiesystemen |
| handdoekhouder 60cm 0640158 | | chroom | 5090110 | stuk | 26,50 | 241 | 0 |  | Badkamermeubelen en toiletkasten |
| badgreep 25cm 0640115 | | chroom | 5070110 | stuk | 21,25 | 241 | 0 |  | Gootstenen en wastroggen |
| closetrolhouder 0640212 | | chroom | 5140110 | stuk | 15,25 | 241 | 0 |  | Utiliteit |
| closetrolhouder m. klep 0640002 | | chroom | 5130110 | stuk | 23,50 | 241 | 0 |  | |





| | Art.nr | Specificaties | Kleur | Lev.nr | Ehd | Prijs | Grp | CC |
|---|---|------------------------------------|-------|----------|----------|-------|-------|-----|
| Sanitair producten | Haceka Thema | | | | | | | |
| | | reserverolhouder | | | | | | |
| | 0640006 | | chrom | 5240110 | stuk | 16,00 | 241 | 1 |
| Baden / douchebakken / stoomcabines |  | | | | | | | |
| Kranen | closetborstelgarnituur | | | | | | | |
| | | 0640255 | | chrom | 5190110 | stuk | 37,50 | 241 |
| Douchegarnituur |  | | | | | | | |
| Accessoires en spiegels | handdoekhaak enkel | | | | | | | |
| | | 0640204 | | chrom | 5120110 | stuk | 12,25 | 241 |
| Douchewanden |  | | | | | | | |
| Toebehoren & afvoeren | handdoekhaak dubbel | | | | | | | |
| | | 0640247 | | chrom | 5180110 | stuk | 12,25 | 241 |
| |  | | | | | | | |
| Spoel- & installatiesystemen | garderobehaak m. 4 haakjes | | | | | | | |
| | | 0640298 | | chrom | 5250110 | stuk | 18,75 | 241 |
| |  | | | | | | | |
| Badkamermeubelen en toiletkasten | Haceka Uniline | | | | | | | |
| | | zeephouder 303/903A in doos | | | | | | |
| | 4350502 | | acryl | 3030190 | stuk | 7,00 | 241 | 1 |
| Gootstenen en wastroggen | zeephouder hoekdraadmodel | | | | | | | |
| | | 0640014 | | chrom | 18410110 | stuk | 23,75 | 241 |
| Utiliteit | drinkglas voor alle series in blister | | | | | | | |
| | | 4356209 | | acryl | 18029910 | stuk | 2,94 | 241 |
| |  | | | | | | | |
| | planchet hoekdraadmodel in blister | | | | | | | |
| | 0642401 | | chrom | 18050210 | stuk | 25,00 | 241 | 1 |
| | haak 2-stuks groot | | | | | | | |
| | 0642405 | | chrom | 18330210 | stuk | 5,70 | 241 | 1 |

| Art.nr | Specificaties | Kleur | Lev.nr | Ehd | Prijs | Grp | CC | | |
|--|---------------|-------|----------|------|--------|-----|----|---|---|
| | | | | | | | | Hansa Designo | |
| glashouder enkel m. glas 0395331 | | chrom | 51290900 | stuk | 158,00 | 262 | 1 |  | Sanitair producten |
| zeephouder m. schaal 0395323 | | chrom | 51270900 | stuk | 162,00 | 262 | 1 |  | Baden / douchebakken / stoomcabines |
| zeepdispenser compleet 0395358 | | chrom | 51300900 | stuk | 228,00 | 262 | 1 |  | Kranen |
| sponschaal 0395366 | | chrom | 51340900 | stuk | 173,00 | 262 | 1 |  | Douchegarnituur |
| 2-lids handdoekhouder 0395382 | | chrom | 51230900 | stuk | 170,00 | 262 | 1 |  | Accessoires en spiegels |
| handdoekring 0395374 | | chrom | 51310900 | stuk | 146,00 | 262 | 1 |  | Douchewanden |
| badgreep 38cm 0395390 | | chrom | 51260900 | stuk | 165,00 | 262 | 1 |  | Toebehoren & afvoeren |
| closetrolhouder z. klep 0395412 | | chrom | 51240900 | stuk | 149,00 | 262 | 1 |  | Spoel- & installatiesystemen |
| reserverolhouder 0395420 | | chrom | 51330900 | stuk | 144,00 | 262 | 1 |  | Badkamermeubelen en toiletkasten |
| toiletborstelgarnituur 0395439 | | chrom | 51250900 | stuk | 225,00 | 262 | 1 |  | Gootstenen en wastroggen |
| handdoek/jashaak 0395404 | | chrom | 51320900 | stuk | 50,00 | 262 | 1 |  | Utiliteit |

| | Art.nr | Specificaties | Kleur | Lev.nr | Ehd | Prijs | Grp | CC |
|---|--------------------------|---|----------------|----------------------|--------------|------------------|------------|--------|
| Sanitair producten | Hansa Hansamotion | | | | | | | |
| | | glashouder m. glas 0300653 | chrom | 53720900 | stuk | 92,00 | 262 | 1 |
| Baden / douchebakken / stoomcabines | | zeephouder m. schaal 0300654 | chrom | 53730900 | stuk | 108,00 | 262 | 1 |
| Kranen | | | | | | | | |
| Douchegarnituur | | zeephouder draadmodel 0300664 | chrom | 53830900 | stuk | 77,00 | 262 | 1 |
| Accessoires en spiegels | | | | | | | | |
| Douchewanden | | zeepdispenser 0300655 | chrom | 53820900 | stuk | 153,00 | 262 | 1 |
| Toebehoren & afvoeren | | | | | | | | |
| Spoel- & installatiesystemen | | 2-lids handdoekhouder draaibaar 0300656 | chrom | 53790900 | stuk | 108,00 | 262 | 1 |
| Badkamermeubelen en toiletkasten | | | | | | | | |
| Gootstenen en wastroggen | | handdoekring 0300657 | chrom | 53710900 | stuk | 94,00 | 262 | 1 |
| Utiliteit | | | | | | | | |
| | | handdoekhouder 0300658 60cm 0300659 80cm | chrom chrom | 53740900 53750900 | stuk stuk | 130,00 141,00 | 262 262 | 1 1 |
| | | closetrolhouder m. klep 0300661 | chrom | 53760900 | stuk | 95,50 | 262 | 1 |
| | | closetborstelgarnituur 0300663 | chrom | 53810900 | stuk | 169,00 | 262 | 1 |

| Art.nr | Specificaties | Kleur | Lev.nr | Ehd | Prijs | Grp | CC | | |
|--|---------------|--------|----------|------|--------|-----|----|---|---|
| | | | | | | | | Hansa Hansamotion | |
| reserverolhouder 0300662 | | chroom | 53770900 | stuk | 74,50 | 262 | 1 |  | Sanitair producten |
| haak 0300660 | | chroom | 53780900 | stuk | 18,00 | 262 | 1 |  | Baden / douchebakken / stoomcabines |
| | | | | | | | | Hansa Murano | |
| glashouder enkel m. glas 0395690 | | chroom | 56290900 | stuk | 273,00 | 262 | 1 |  | Kranen |
| zeephouder m. inzet 0395691 | | chroom | 56270900 | stuk | 447,00 | 262 | 1 |  | Douchegarnituur |
| zeepdispenser compleet 0395693 | | chroom | 56300900 | stuk | 348,00 | 262 | 1 |  | Accessoires en spiegels |
| handdoekhouder enkel 0395687 | | chroom | 56230900 | stuk | 168,00 | 262 | 1 |  | Douchewanden |
| handdoekhouder 0395683 | | chroom | 56340900 | stuk | 327,00 | 262 | 1 |  | Toebehoren & afvoeren |
| badgreep 0395681 | | chroom | 56260900 | stuk | 294,00 | 262 | 1 |  | Spoel- & installatiesystemen |
| closetrolhouder 0395699 | | chroom | 56240900 | stuk | 174,00 | 262 | 1 |  | Badkamermeubelen en toiletkasten |
| reserverolhouder 0395689 | | chroom | 56330900 | stuk | 141,00 | 262 | 1 |  | Gootstenen en wastroggen |
| closetborstelgarnituur 0395695 | | chroom | 56250900 | stuk | 375,00 | 262 | 1 | | Utiliteit |

| | Art.nr | Specificaties | Kleur | Lev.nr | Ehd | Prijs | Grp | CC |
|---|--------------------------|---|--|----------|----------|--------|--------|-----|
| Sanitair producten | Hansa Murano | | | | | | | |
| | | handdoekhaak enkel 0395685 | chrom | 56320900 | stuk | 75,50 | 262 | 1 |
| Baden / douchebakken / stoomcabines | Hansa Ronda Style | | | | | | | |
| Kranen | | glashouder m. kristalglas 0300630 | chrom | 43190900 | stuk | 76,00 | 262 | 1 |
| | Douchegarnituur | | zeephouder m. kristalglas 0300631 | chrom | 43200900 | stuk | 89,50 | 262 |
| Accessoires en spiegels | | | zeepdispenser m. kristalglas 0300633 | chrom | 43350900 | stuk | 126,00 | 262 |
| Douchewanden | | set van 2 houders voor planchet 0300643 | chrom | 43300900 | stuk | 45,00 | 262 | 1 |
| Toebehoren & afvoeren | | badgreep 30cm 0300638 | chrom | 43160900 | stuk | 90,00 | 262 | 1 |
| Spoel- & installatiesystemen | | handdoekring 0300635 | chrom | 43170900 | stuk | 81,00 | 262 | 1 |
| Badkamermeubelen en toiletkasten | | handdoekhouder 0300636 60cm | chrom | 43220900 | stuk | 112,00 | 262 | 1 |
| Gootstenen en wastroggen | | 0300637 80cm | chrom | 43230900 | stuk | 122,00 | 262 | 1 |
| | Utiliteit | | handdoekhouder 2-delig 48cm 0300634 | chrom | 43290900 | stuk | 93,00 | 262 |

| Art.nr | Specificaties | Kleur | Lev.nr | Ehd | Prijs | Grp | CC | |
|--|---------------|--------|----------|------|--------|-----|----|---|
| | | | | | | | | Hansa Ronda Style |
| closetrolhouder 0300640 | | chroom | 43240900 | stuk | 83,00 | 262 | 1 |  |
| reserverolhouder 0300641 | | chroom | 43260900 | stuk | 64,50 | 262 | 1 |  |
| closetborstelgarnituur 0300642 | | chroom | 43330900 | stuk | 140,00 | 262 | 1 |  |
| handdoekhaakje 0300639 | | chroom | 43270900 | stuk | 15,50 | 262 | 1 |  |
| spons-/zeepkorf 0300632 | | chroom | 43800900 | stuk | 66,50 | 262 | 1 |  |

- Sanitair producten
- Baden /
douchebakken /
stoomcabines
- Kranen
- Douchegarnituur
- Accessoires en
spiegels
- Douchewanden
- Toebehoren &
afvoeren
- Spoel- &
installatiesystemen
- Badkamermeubelen
en toiletkasten
- Gootstenen en
wastroggen
- Utiliteit

| | Art.nr | Specificaties | Kleur | Lev.nr | Ehd | Prijs | Grp | CC |
|---|--|---------------|-------------|----------|------|--------|-----|----|
| Sanitair producten | Hansgrohe Atoll | | | | | | | |
| | glashouder enkel m. glas | | | | | | | |
| | 0471828 | | chroom | 40534000 | stuk | 107,00 | 223 | 1 |
| | 0471984 | | chroom/goud | 40534090 | stuk | 149,00 | 223 | 1 |
| Baden / douchebakken / stoomcabines | zeephouder m. kristal inzet | | | | | | | |
| | 0471798 | | chroom | 40533000 | stuk | 106,00 | 223 | 1 |
| Kranen | 0471968 | | chroom/goud | 40533090 | stuk | 148,00 | 223 | 1 |
| | zeepdispenser wandmodel | | | | | | | |
| Douchegarnituur | 0471801 | | chroom | 40519000 | stuk | 146,00 | 223 | 1 |
| | 0471976 | | chroom/goud | 40519090 | stuk | 194,00 | 223 | 1 |
| Accessoires en spiegels | planchet kristalglas | | | | | | | |
| Douchewanden | 0471771 | 70cm | chroom | 40550000 | stuk | 230,00 | 223 | 1 |
| | wandlamp m. kristal glas | | | | | | | |
| Toebehoren & afvoeren | 0471830 | | chroom | 40556000 | stuk | 260,00 | 223 | 1 |
| | 2-lids handdoekhouder draaibaar | | | | | | | |
| Spoel- & installatiesystemen | 0471704 | | chroom | 40520000 | stuk | 107,00 | 223 | 1 |
| | 0471879 | | chroom/goud | 40520090 | stuk | 129,00 | 223 | 1 |
| Badkamermeubelen en toiletkasten | handdoekring | | | | | | | |
| Gootstenen en wastroggen | 0471690 | | chroom | 40521000 | stuk | 85,00 | 223 | 1 |
| | 0471860 | | chroom/goud | 40521090 | stuk | 128,00 | 223 | 1 |
| Utiliteit | handdoekhouder 60cm | | | | | | | |
| | 0471674 | | chroom | 40506000 | stuk | 124,00 | 223 | 1 |
| | 0471844 | | chroom/goud | 40506090 | stuk | 181,00 | 223 | 1 |
| | handdoekhouder 80cm | | | | | | | |
| | 0471682 | | chroom | 40508000 | stuk | 131,00 | 223 | 1 |
| | 0471852 | | chroom/goud | 40508090 | stuk | 184,00 | 223 | 1 |
| | badgreep 30cm | | | | | | | |
| | 0471666 | | chroom | 40530000 | stuk | 116,00 | 223 | 1 |
| | 0471836 | | chroom/goud | 40530090 | stuk | 170,00 | 223 | 1 |

| Art.nr | Specificaties | Kleur | Lev.nr | Ehd | Prijs | Grp | CC | |
|---|---------------|------------|----------|------|--------|-----|----|---|
| Hansgrohe Atoll | | | | | | | | |
| closetrolhouder m. klep | | | | | | | | |
| 0471747 | | chrom | 40536000 | stuk | 124,00 | 223 | 1 |  |
| 0471917 | | chrom/goud | 40536090 | stuk | 180,00 | 223 | 1 | |
| reserverolhouder | | | | | | | | |
| 0471755 | | chrom | 40528000 | stuk | 63,00 | 223 | 1 |  |
| 0471925 | | chrom/goud | 40528090 | stuk | 93,00 | 223 | 1 | |
| closetborstelgarnituur | | | | | | | | |
| 0471763 | | chrom | 40535000 | stuk | 121,00 | 223 | 1 |  |
| 0471933 | | chrom/goud | 40535090 | stuk | 170,00 | 223 | 1 | |
| garderobehaak | | | | | | | | |
| 0471712 | | chrom | 40539000 | stuk | 46,75 | 223 | 1 |  |
| 0471887 | | chrom/goud | 40539090 | stuk | 78,00 | 223 | 1 | |
| handdoekhaak enkel | | | | | | | | |
| 0471720 | | chrom | 40537000 | stuk | 8,60 | 223 | 1 |  |
| handdoekhaak dubbel | | | | | | | | |
| 0471739 | | chrom | 40531000 | stuk | 35,50 | 223 | 1 |  |
| Hansgrohe Carlton | | | | | | | | |
| glashouder enkel m. kristal glas | | | | | | | | |
| 0456470 | | chrom | 41434000 | stuk | 116,00 | 223 | 1 |  |
| zeepouder m. kristal inzet | | | | | | | | |
| 0456489 | | chrom | 41433000 | stuk | 116,00 | 223 | 1 |  |
| wandlamp | | | | | | | | |
| 0456462 | | chrom | 41456000 | stuk | 247,00 | 223 | 1 |  |

Sanitair producten

Baden /
douchebakken /
stoomcabines

Kranen

Douche­garnituur

Accessoires en
spiegels

Douchewanden

Toebehoren &
afvoeren











Spoel- &
installatiesystemen











Badkamermeubelen
en toiletkasten













Gootstenen en
wastroggen









Utiliteit

Accessoires Hansgrohe

| | Art.nr | Specificaties | Kleur | Lev.nr | Ehd | Prijs | Grp | CC |
|---|---|--|-------|----------|------|--------|-----|----|
| Sanitair producten | Hansgrohe Carlton | | | | | | | |
| |  | 1-lids handdoekhouder 0456535 | chrom | 41420000 | stuk | 156,00 | 223 | 1 |
| Baden / douchebakken / stoomcabines |  | handdoekkring 0456544 | chrom | 41421000 | stuk | 116,00 | 223 | 1 |
| | Kranen | | | | | | | |
| Douchegarnituur |  | handdoekhouder 70cm 0456519 | chrom | 41406000 | stuk | 188,00 | 223 | 1 |
| | | handdoekhouder 90cm 0456527 | chrom | 41408000 | stuk | 197,00 | 223 | 1 |
| Accessoires en spiegels |  | badgreep 30cm 0456500 | chrom | 41430000 | stuk | 170,00 | 223 | 1 |
| Douchewanden |  | closetrolhouder m. klep 0456551 | chrom | 41438000 | stuk | 156,00 | 223 | 1 |
| Toebehoren & afvoeren | | | | | | | | |
| Spoel- & installatiesystemen |  | reserverolhouder 0456578 | chrom | 41428000 | stuk | 89,50 | 223 | 1 |
| Badkamermeubelen en toiletkasten |  | closetborstelgarnituur wandmodel 0456586 | chrom | 41435000 | stuk | 134,00 | 223 | 1 |
| | Gootstenen en wastroggen | | | | | | | |
| Utiliteit |  | zeepdispenser wandmodel 0456497 | chrom | 41419000 | stuk | 192,00 | 223 | 1 |
| | Hansgrohe Citterio | | | | | | | |
| |  | glashouder compleet 0467340 | chrom | 41734000 | stuk | 105,00 | 223 | 1 |
| |  | zeepschaal compleet 0467341 | chrom | 41733000 | stuk | 105,00 | 223 | 1 |

| Art.nr | Specificaties | Kleur | Lev.nr | Ehd | Prijs | Grp | CC | | |
|--|---------------|-------|----------|------|--------|-----|----|---|---|
| | | | | | | | | Hansgrohe Citterio | |
| zeepdispenser compleet 0467342 | | chrom | 41719000 | stuk | 144,00 | 223 | 1 |  | Sanitair producten |
| badgreep 0467335 | | chrom | 41730000 | stuk | 124,00 | 223 | 1 |  | Baden / douchebakken / stoomcabines |
| handdoekhouder 60cm 0467336 | | chrom | 41760000 | stuk | 136,00 | 223 | 1 |  | Kranen |
| badlakenrek 80cm 0467337 | | chrom | 41780000 | stuk | 163,00 | 223 | 1 | | Douchegarnituur |
| handdoekring 0467345 | | chrom | 41721000 | stuk | 105,00 | 223 | 1 |  | Accessoires en spiegels |
| closetrolhouder m. klep 0467347 | | chrom | 41738000 | stuk | 120,00 | 223 | 1 |  | Douchewanden |
| closetborstelgarnituur 0467349 | | chrom | 41735000 | stuk | 144,00 | 223 | 1 |  | Toebehoren & afvoeren |
| | | | | | | | | | Spoel- & installatiesystemen |
| | | | | | | | | | Badkamermeubelen en toiletkasten |
| | | | | | | | | | Gootstenen en wastroggen |
| | | | | | | | | Hansgrohe Logo | |
| drinkbeker m. wandhouder 0606634 | | chrom | 41635000 | stuk | 31,00 | 176 | 1 |  | Utiliteit |
| drinkglas m. wandhouder 0606642 | | chrom | 41645000 | stuk | 33,25 | 176 | 1 |  | |
| zeepschaal 120x110mm 0606650 | | chrom | 41636000 | stuk | 33,25 | 176 | 1 |  | |
| zeepschaap m. wandhouder 0606669 | | chrom | 41646000 | stuk | 45,25 | 176 | 1 |  | |

| | Art.nr | Specificaties | Kleur | Lev.nr | Ehd | Prijs | Grp | CC |
|---|---|--|-------|----------|------|--------|-----|----|
| | Hansgrohe Logo | | | | | | | |
| Sanitair producten | | lotiiondispenser m. wandhouder 0606677 | chrom | 41619000 | stuk | 66,50 | 176 | 1 |
| |  | | | | | | | |
| Baden / douchebakken / stoomcabines | | | | | | | | |
| Kranen | | planchet 45cm 0606693 | chrom | 41628000 | stuk | 142,00 | 176 | 1 |
| |  | | | | | | | |
| Douchegarnituur | | planchet 70cm 0606685 | chrom | 41638000 | stuk | 158,00 | 176 | 1 |
| |  | | | | | | | |
| Accessoires en spiegels | | badgreep 30cm 0606707 | chrom | 41630000 | stuk | 49,50 | 176 | 1 |
| |  | | | | | | | |
| Douchewanden | | handdoekhouder 60cm 0606715 | chrom | 41660000 | stuk | 76,00 | 176 | 1 |
| |  | | | | | | | |
| Toebehoren & afvoeren | | handdoekhouder 80cm 0606723 | chrom | 41680000 | stuk | 84,00 | 176 | 1 |
| |  | | | | | | | |
| Spoel- & installatiesystemen | | 2-lids handdoekhouder 46cm 0606731 | chrom | 41622000 | stuk | 94,00 | 176 | 1 |
| |  | | | | | | | |
| Badkamermeubelen en toiletkasten | | washandhaak 4.1x3.8cm 0606758 | chrom | 41624000 | stuk | 8,40 | 176 | 1 |
| |  | | | | | | | |
| Gootstenen en wastroggen | | kledinghaak 10.1x5.4cm 0606766 | chrom | 41625000 | stuk | 13,75 | 176 | 1 |
| |  | | | | | | | |
| Utiliteit | | handdoekring / closetrolhouder 0606774 | chrom | 41639000 | stuk | 50,50 | 176 | 1 |
| |  | | | | | | | |
| | | wandreserverolhouder 0606782 | chrom | 41640000 | stuk | 46,00 | 176 | 1 |
| |  | | | | | | | |
| | | closetborstelgarnituur 0606790 | chrom | 41637000 | stuk | 78,00 | 176 | 1 |
| |  | | | | | | | |

| Art.nr | Specificaties | Kleur | Lev.nr | Ehd | Prijs | Grp | CC | | |
|--|---------------|--------|----------|------|---------|-----|----|---|---|
| | | | | | | | | Hansgrohe Massaud | |
| drinkglas helder 0450602 | | | 42234000 | stuk | 107,00 | 176 | 1 |  | Sanitair producten |
| zeepschaal 0450603 | | | 42233000 | stuk | 107,00 | 176 | 1 |  | Baden / douchebakken / stoomcabines |
| closetrolhouder 0450608 | | chroom | 42236000 | stuk | 154,00 | 176 | 1 |  | Kranen |
| closetborstelgarnituur 0450609 | | chroom | 42235000 | stuk | 213,00 | 176 | 1 |  | Douchegarnituur |
| badgreep 30cm 0450605 | | chroom | 42230000 | stuk | 231,00 | 176 | 1 |  | Accessoires en spiegels |
| handdoekhouder 0450606 70cm | | chroom | 42260000 | stuk | 261,00 | 176 | 1 |  | Douchewanden |
| 0450607 90cm | | chroom | 42280000 | stuk | 284,00 | 176 | 1 | | Toebehoren & afvoeren |
| staande handdoekhouder 0450610 | | chroom | 42270000 | stuk | 1420,00 | 176 | 1 |  | Spoel- & installatiesystemen |
| kaarshouder 0450600 | | chroom | 42271000 | stuk | 77,00 | 176 | 1 |  | Badkamermeubelen en toiletkasten |
| wandhaakje 0450601 | | chroom | 42237000 | stuk | 119,00 | 176 | 1 |  | Gootstenen en wastroggen |
| | | | | | | | | | Utiliteit |

| Art.nr | Specificaties | Kleur | Lev.nr | Ehd | Prijs | Grp | CC |
|--------|---------------|-------|--------|-----|-------|-----|----|
|--------|---------------|-------|--------|-----|-------|-----|----|

Hansgrohe Massaud

staande spiegel tafemodel

| | | | | | | | |
|---------|--|--|----------|------|--------|-----|---|
| 0450604 | | | 42240000 | stuk | 296,00 | 176 | 1 |
|---------|--|--|----------|------|--------|-----|---|



Sanitair producten

Baden /
douchebakken /
stoomcabines

Hansgrohe Montreux

glashouder m. tandenborstelhouder

| | | | | | | | |
|---------|--|-------|----------|------|--------|-----|---|
| 0451128 | | chrom | 42034000 | stuk | 113,00 | 176 | 1 |
|---------|--|-------|----------|------|--------|-----|---|

| | | | | | | | |
|---------|--|----------------|----------|------|--------|-----|---|
| 0451129 | | brushed nikkel | 42034820 | stuk | 173,00 | 176 | 1 |
|---------|--|----------------|----------|------|--------|-----|---|

| | | | | | | | |
|---------|--|-----------------|----------|------|--------|-----|---|
| 0451130 | | polished nikkel | 42034830 | stuk | 150,00 | 176 | 1 |
|---------|--|-----------------|----------|------|--------|-----|---|



Kranen

Douchegarnituur

glashouder m. glas

| | | | | | | | |
|---------|--|-------|----------|------|--------|-----|---|
| 0451125 | | chrom | 42134000 | stuk | 107,00 | 176 | 1 |
|---------|--|-------|----------|------|--------|-----|---|

| | | | | | | | |
|---------|--|----------------|----------|------|--------|-----|---|
| 0451126 | | brushed nikkel | 42134820 | stuk | 163,00 | 176 | 1 |
|---------|--|----------------|----------|------|--------|-----|---|

| | | | | | | | |
|---------|--|-----------------|----------|------|--------|-----|---|
| 0451127 | | polished nikkel | 42134830 | stuk | 142,00 | 176 | 1 |
|---------|--|-----------------|----------|------|--------|-----|---|



Accessoires en
spiegels

Douchewanden

zeephouder m. inzet

| | | | | | | | |
|---------|--|-------|----------|------|--------|-----|---|
| 0451134 | | chrom | 42033000 | stuk | 107,00 | 176 | 1 |
|---------|--|-------|----------|------|--------|-----|---|

| | | | | | | | |
|---------|--|----------------|----------|------|--------|-----|---|
| 0451135 | | brushed nikkel | 42033820 | stuk | 163,00 | 176 | 1 |
|---------|--|----------------|----------|------|--------|-----|---|

| | | | | | | | |
|---------|--|-----------------|----------|------|--------|-----|---|
| 0451136 | | polished nikkel | 42033830 | stuk | 142,00 | 176 | 1 |
|---------|--|-----------------|----------|------|--------|-----|---|



Toebehoren &
afvoeren

zeepdispenser

| | | | | | | | |
|---------|--|-------|----------|------|--------|-----|---|
| 0451131 | | chrom | 42019000 | stuk | 142,00 | 176 | 1 |
|---------|--|-------|----------|------|--------|-----|---|

| | | | | | | | |
|---------|--|----------------|----------|------|--------|-----|---|
| 0451132 | | brushed nikkel | 42019820 | stuk | 218,00 | 176 | 1 |
|---------|--|----------------|----------|------|--------|-----|---|

| | | | | | | | |
|---------|--|-----------------|----------|------|--------|-----|---|
| 0451133 | | polished nikkel | 42019830 | stuk | 189,00 | 176 | 1 |
|---------|--|-----------------|----------|------|--------|-----|---|



Spoel- &
installatiesystemen

Badkamermeubelen
en toiletkasten

1-lids handdoekhouder

| | | | | | | | |
|---------|--|-------|----------|------|--------|-----|---|
| 0451152 | | chrom | 42020000 | stuk | 113,00 | 176 | 1 |
|---------|--|-------|----------|------|--------|-----|---|

| | | | | | | | |
|---------|--|----------------|----------|------|--------|-----|---|
| 0451153 | | brushed nikkel | 42020820 | stuk | 173,00 | 176 | 1 |
|---------|--|----------------|----------|------|--------|-----|---|

| | | | | | | | |
|---------|--|-----------------|----------|------|--------|-----|---|
| 0451154 | | polished nikkel | 42020830 | stuk | 150,00 | 176 | 1 |
|---------|--|-----------------|----------|------|--------|-----|---|



Gootstenen en
wastroggen

Utiliteit

handdoekring

| | | | | | | | |
|---------|--|-------|----------|------|--------|-----|---|
| 0451155 | | chrom | 42021000 | stuk | 113,00 | 176 | 1 |
|---------|--|-------|----------|------|--------|-----|---|

| | | | | | | | |
|---------|--|----------------|----------|------|--------|-----|---|
| 0451156 | | brushed nikkel | 42021820 | stuk | 173,00 | 176 | 1 |
|---------|--|----------------|----------|------|--------|-----|---|

| | | | | | | | |
|---------|--|-----------------|----------|------|--------|-----|---|
| 0451157 | | polished nikkel | 42021830 | stuk | 150,00 | 176 | 1 |
|---------|--|-----------------|----------|------|--------|-----|---|



badgreep

| | | | | | | | |
|---------|--|-------|----------|------|--------|-----|---|
| 0451143 | | chrom | 42030000 | stuk | 142,00 | 176 | 1 |
|---------|--|-------|----------|------|--------|-----|---|

| | | | | | | | |
|---------|--|----------------|----------|------|--------|-----|---|
| 0451144 | | brushed nikkel | 42030820 | stuk | 218,00 | 176 | 1 |
|---------|--|----------------|----------|------|--------|-----|---|

| | | | | | | | |
|---------|--|-----------------|----------|------|--------|-----|---|
| 0451145 | | polished nikkel | 42030830 | stuk | 189,00 | 176 | 1 |
|---------|--|-----------------|----------|------|--------|-----|---|



handdoekhouder

| | | | | | | | |
|--------------|--|-------|----------|------|--------|-----|---|
| 0451149 60cm | | chrom | 42060000 | stuk | 154,00 | 176 | 1 |
|--------------|--|-------|----------|------|--------|-----|---|

| | | | | | | | |
|--------------|--|----------------|----------|------|--------|-----|---|
| 0451150 60cm | | brushed nikkel | 42060820 | stuk | 236,00 | 176 | 1 |
|--------------|--|----------------|----------|------|--------|-----|---|

| | | | | | | | |
|--------------|--|-----------------|----------|------|--------|-----|---|
| 0451151 60cm | | polished nikkel | 42060830 | stuk | 204,00 | 176 | 1 |
|--------------|--|-----------------|----------|------|--------|-----|---|

| | | | | | | | |
|--------------|--|-------|----------|------|--------|-----|---|
| 0451146 80cm | | chrom | 42080000 | stuk | 166,00 | 176 | 1 |
|--------------|--|-------|----------|------|--------|-----|---|

| | | | | | | | |
|--------------|--|----------------|----------|------|--------|-----|---|
| 0451147 80cm | | brushed nikkel | 42080820 | stuk | 254,00 | 176 | 1 |
|--------------|--|----------------|----------|------|--------|-----|---|

| | | | | | | | |
|--------------|--|-----------------|----------|------|--------|-----|---|
| 0451148 80cm | | polished nikkel | 42080830 | stuk | 220,00 | 176 | 1 |
|--------------|--|-----------------|----------|------|--------|-----|---|



| Art.nr | Specificaties | Kleur | Lev.nr | Ehd | Prijs | Grp | CC |
|--------|---------------|-------|--------|-----|-------|-----|----|
|--------|---------------|-------|--------|-----|-------|-----|----|

Hansgrohe Montreux

closetrolhouder m. klep

| | | | | | | | |
|---------|--|-----------------|----------|------|--------|-----|---|
| 0451161 | | chrom | 42036000 | stuk | 125,00 | 176 | 1 |
| 0451162 | | brushed nikkel | 42036820 | stuk | 191,00 | 176 | 1 |
| 0451163 | | polished nikkel | 42036830 | stuk | 166,00 | 176 | 1 |



Sanitair producten

Baden /
douchebakken /
stoomcabines

reserverolhouder

| | | | | | | | |
|---------|--|-----------------|----------|------|--------|-----|---|
| 0451164 | | chrom | 42028000 | stuk | 65,50 | 176 | 1 |
| 0451165 | | brushed nikkel | 42028820 | stuk | 101,00 | 176 | 1 |
| 0451166 | | polished nikkel | 42028830 | stuk | 87,00 | 176 | 1 |



Kranen

Douchegarnituur

closetborstelgarnituur

| | | | | | | | |
|---------|--|-----------------|----------|------|--------|-----|---|
| 0451167 | | chrom | 42035000 | stuk | 142,00 | 176 | 1 |
| 0451168 | | brushed nikkel | 42035820 | stuk | 218,00 | 176 | 1 |
| 0451169 | | polished nikkel | 42035830 | stuk | 189,00 | 176 | 1 |



Accessoires en
spiegels

wandlamp

| | | | | | | | |
|---------|--|-----------------|----------|------|--------|-----|---|
| 0451119 | | chrom | 42056000 | stuk | 249,00 | 176 | 1 |
| 0451120 | | brushed nikkel | 42056820 | stuk | 380,00 | 176 | 1 |
| 0451121 | | polished nikkel | 42056830 | stuk | 330,00 | 176 | 1 |



Douchewanden

Toebehoren &
afvoeren

zeepkorf voor wandmontage

| | | | | | | | |
|---------|--|-----------------|----------|------|--------|-----|---|
| 0451137 | | chrom | 42065000 | stuk | 131,00 | 176 | 1 |
| 0451138 | | brushed nikkel | 42065820 | stuk | 199,00 | 176 | 1 |
| 0451139 | | polished nikkel | 42065830 | stuk | 173,00 | 176 | 1 |



Spoel- &
installatiesystemen

Badkamermeubelen
en toiletkasten

zeepkorf voor Unica glijstang

| | | | | | | | |
|---------|--|-----------------|----------|------|--------|-----|---|
| 0451140 | | chrom | 42066000 | stuk | 130,00 | 176 | 1 |
| 0451141 | | brushed nikkel | 42066820 | stuk | 199,00 | 176 | 1 |
| 0451142 | | polished nikkel | 42066830 | stuk | 173,00 | 176 | 1 |



Gootstenen en
wastroggen

Utiliteit

scheerspiegel uittrekbaar

| | | | | | | | |
|---------|--|-----------------|----------|------|--------|-----|---|
| 0451158 | | chrom | 42090000 | stuk | 296,00 | 176 | 1 |
| 0451159 | | brushed nikkel | 42090820 | stuk | 453,00 | 176 | 1 |
| 0451160 | | polished nikkel | 42090830 | stuk | 392,00 | 176 | 1 |



washandhaakje

| | | | | | | | |
|---------|--|-----------------|----------|------|-------|-----|---|
| 0451122 | | chrom | 42137000 | stuk | 29,75 | 176 | 1 |
| 0451123 | | brushed nikkel | 42137820 | stuk | 46,00 | 176 | 1 |
| 0451124 | | polished nikkel | 42137830 | stuk | 40,00 | 176 | 1 |













Hansgrohe Philippe Starck









glashouder m. wandhouder

| | | | | | | | |
|---------|--|-------|----------|------|--------|-----|---|
| 0452092 | | chrom | 40834000 | stuk | 165,00 | 223 | 0 |
|---------|--|-------|----------|------|--------|-----|---|











Accessoires Hansgrohe

| | Art.nr | Specificaties | Kleur | Lev.nr | Ehd | Prijs | Grp | CC |
|---|---|---|----------------|----------------------|--------------|------------------|------------|--------|
| | Hansgrohe Philippe Starck | | | | | | | |
| Sanitair producten | | zeephouder m. wandhouder 0452157 | chrom | 40833000 | stuk | 165,00 | 223 | 1 |
| |  | | | | | | | |
| Baden / douchebakken / stoomcabines | | planchet 60cm 0452912 | chrom | 40860000 | stuk | 228,00 | 223 | 1 |
| |  | | | | | | | |
| Kranen | | wandlamp 40W m. wit glas 0452149 | chrom | 40856000 | stuk | 265,00 | 223 | 1 |
| |  | | | | | | | |
| Douchegarnituur | | 2-lids handdoekhouder draaibaar 0453404 | chrom | 40820000 | stuk | 217,00 | 223 | 1 |
| |  | | | | | | | |
| Accessoires en spiegels | | handdoekring 0452106 | chrom | 40821000 | stuk | 165,00 | 223 | 1 |
| |  | | | | | | | |
| Douchewanden | | handdoekhouder 0452068 60cm 0452076 80cm | chrom chrom | 40806000 40808000 | stuk stuk | 237,00 246,00 | 223 223 | 1 1 |
| |  | | | | | | | |
| Toebehoren & afvoeren | | badgreep 30cm 0452084 | chrom | 40830000 | stuk | 210,00 | 223 | 1 |
| |  | | | | | | | |
| Spoel- & installatiesystemen | | closetrolhouder voor 2 rollen 0452122 | chrom | 40836000 | stuk | 117,00 | 223 | 0 |
| |  | | | | | | | |
| Badkamermeubelen en toiletkasten | | closetborstelgarnituur staand 0453412 | chrom | 40840000 | stuk | 306,00 | 223 | 1 |
| |  | | | | | | | |
| Gootstenen en wastroggen | | closetborstelgarnituur wandmodel 0452130 | chrom | 40835000 | stuk | 297,00 | 223 | 0 |
| |  | | | | | | | |
| Utiliteit | | | | | | | | |

| Art.nr | Specificaties | Kleur | Lev.nr | Ehd | Prijs | Grp | CC | | |
|--|---------------|-------|----------|------|--------|-----|----|---|---|
| | | | | | | | | Hansgrohe Philippe Starck | |
| handdoekhaak 0452114 | | chrom | 40837000 | stuk | 92,00 | 223 | 0 |  | Sanitair producten |
| wandspiegel 0606987 107.5x32.5cm | | chrom | 40140000 | stuk | 368,00 | 176 | 1 | | Baden / douchebakken / stoomcabines |
| wandspiegel m. verlichting 0650534 | | chrom | 40141000 | stuk | 612,00 | 238 | 1 | | Kranen |
| | | | | | | | | Hansgrohe Steel | |
| glashouder m. glas 0466743 | | RVS | 41834800 | stuk | 124,00 | 176 | 0 |  | Douchegarnituur |
| planchet 70cm 0453250 | | RVS | 41250800 | stuk | 223,00 | 176 | 1 |  | Douchewanden |
| zeepschaal m. inzet 0466751 | | RVS | 41833800 | stuk | 124,00 | 176 | 0 |  | Toebehoren & afvoeren |
| zeepdispenser wandmodel 0466778 | | RVS | 41819800 | stuk | 183,00 | 176 | 1 |  | Spoel- & installatiesystemen |
| wandlamp m. opaalglas 0453218 | | RVS | 41256800 | stuk | 223,00 | 176 | 1 |  | Badkamermeubelen en toiletkasten |
| badgreep 0466786 | | RVS | 41830800 | stuk | 129,00 | 176 | 1 |  | Gootstenen en wastroggen |
| handdoekhouder 0466794 60cm | | RVS | 41860800 | stuk | 143,00 | 176 | 1 |  | Utiliteit |
| 0466808 80cm | | RVS | 41880800 | stuk | 150,00 | 176 | 1 | | |
| 2-lids handdoekhouder 0466816 | | RVS | 41820800 | stuk | 150,00 | 176 | 1 |  | |

Accessoires Hansgrohe

| | Art.nr | Specificaties | Kleur | Lev.nr | Ehd | Prijs | Grp | CC |
|---|---|--|---------|----------|------|--------|-----|----|
| Sanitair producten | Hansgrohe Steel | | | | | | | |
| | | handdoekring | | | | | | |
| |  | 0466824 | RVS | 41821800 | stuk | 116,00 | 176 | 1 |
| Baden / douchebakken / stoomcabines | | haakje klein | | | | | | |
| |  | 0466832 | RVS | 41881800 | stuk | 39,25 | 176 | 1 |
| Kranen | | haakje groot | | | | | | |
| |  | 0466840 | RVS | 41839800 | stuk | 45,75 | 176 | 0 |
| Douchegarnituur | | closetrolhouder m. klep | | | | | | |
| |  | 0466859 | RVS | 41838800 | stuk | 144,00 | 176 | 0 |
| Accessoires en spiegels | | reserverolhouder | | | | | | |
| |  | 0466875 | RVS | 41828800 | stuk | 82,50 | 176 | 1 |
| Douchewanden | | closetborstelgarnituur | | | | | | |
| |  | 0466883 | RVS | 41835800 | stuk | 202,00 | 176 | 0 |
| Toebehoren & afvoeren | | Hansgrohe Terrano | | | | | | |
| | | glashouder enkel m. kristalglas | | | | | | |
| |  | 0454001 | chrom | 41334000 | stuk | 105,00 | 223 | 1 |
| | | 0456306 | satinox | 41334810 | stuk | 135,00 | 223 | 1 |
| Spoel- & installatiesystemen | | zeephouder m. kristal inzet | | | | | | |
| |  | 0454028 | chrom | 41333000 | stuk | 105,00 | 223 | 1 |
| Badkamermeubelen en toiletkasten | | 0456314 | satinox | 41333810 | stuk | 157,00 | 223 | 1 |
| Gootstenen en wastroggen | | zeepdispenser wandmodel | | | | | | |
| |  | 0454036 | chrom | 41319000 | stuk | 142,00 | 223 | 1 |
| Utiliteit | | 0456322 | satinox | 41319810 | stuk | 183,00 | 223 | 1 |

| Art.nr | Specificaties | Kleur | Lev.nr | Ehd | Prijs | Grp | CC | | |
|---|---------------|---------|----------|------|--------|-----|----|---|---|
| Hansgrohe Terrano | | | | | | | | | |
| wandlamp enkel | | | | | | | | | |
| 0454141 | | chroom | 41356000 | stuk | 247,00 | 223 | 1 |  | Sanitair producten |
| 0456284 | | satinox | 41356810 | stuk | 322,00 | 223 | 1 | | Baden / douchebakken / stoomcabines |
| wandlamp dubbel | | | | | | | | | |
| 0454168 | | chroom | 41366000 | stuk | 292,00 | 223 | 1 |  | Kranen |
| 0456292 | | satinox | 41366810 | stuk | 381,00 | 223 | 1 | | Douchegarnituur |
| 1-lids handdoekhouder vast | | | | | | | | | |
| 0454095 | | chroom | 41320000 | stuk | 109,00 | 223 | 1 |  | Accessoires en spiegels |
| 0456373 | | satinox | 41320810 | stuk | 142,00 | 223 | 1 | | |
| handdoekring | | | | | | | | | |
| 0454087 | | chroom | 41321000 | stuk | 105,00 | 223 | 1 |  | Toebehoren & afvoeren |
| 0456365 | | satinox | 41321810 | stuk | 135,00 | 223 | 1 | | |
| handdoekhouder | | | | | | | | | |
| 0454044 | 60cm | chroom | 41360000 | stuk | 135,00 | 223 | 1 |  | Badkamermeubelen en toiletkasten |
| 0456349 | 60cm | satinox | 41360810 | stuk | 176,00 | 223 | 1 | | |
| 0454052 | 80cm | chroom | 41380000 | stuk | 165,00 | 223 | 1 | | |
| 0456357 | 80cm | satinox | 41380810 | stuk | 213,00 | 223 | 1 | | |
| badgreep 30cm | | | | | | | | | |
| 0453986 | | chroom | 41330000 | stuk | 120,00 | 223 | 1 |  | Gootstenen en wastroggen |
| 0456330 | | satinox | 41330810 | stuk | 150,00 | 223 | 1 | | |
| closetrolhouder m. klep | | | | | | | | | |
| 0454109 | | chroom | 41338000 | stuk | 120,00 | 223 | 1 |  | Utiliteit |
| 0456381 | | satinox | 41338810 | stuk | 157,00 | 223 | 1 | | |
| reserverolhouder | | | | | | | | | |
| 0454117 | | chroom | 41328000 | stuk | 63,50 | 223 | 1 |  | Utiliteit |
| 0456403 | | satinox | 41328810 | stuk | 82,50 | 223 | 1 | | |
| closetborstelgarnituur wandmodel | | | | | | | | | |
| 0454125 | | chroom | 41335000 | stuk | 142,00 | 223 | 1 |  | |
| 0456411 | | satinox | 41335810 | stuk | 187,00 | 223 | 1 | | |
| closetborstelgarnituur staand | | | | | | | | | |
| 0454133 | | chroom | 41336000 | stuk | 142,00 | 223 | 1 |  | |
| 0456438 | | satinox | 41336810 | stuk | 187,00 | 223 | 1 | | |
| handdoekhaak klein | | | | | | | | | |
| 0454060 | | chroom | 41337000 | stuk | 18,75 | 223 | 1 |  | |
| 0456446 | | satinox | 41337810 | stuk | 26,25 | 223 | 1 | | |

Accessoires Hansgrohe

| | Art.nr | Specificaties | Kleur | Lev.nr | Ehd | Prijs | Grp | CC |
|---|--------------------------|---------------------------------|-------------|----------|-------|--------|-----|----|
| Sanitair producten | Hansgrohe Terrano | | | | | | | |
| | | handdoekhaak groot | | | | | | |
| | | 0454079 | chroom | 41383000 | stuk | 48,75 | 223 | 1 |
| | 0456454 | satinox | 41383810 | stuk | 63,50 | 223 | 1 | |
| Baden / douchebakken / stoomcabines | Hansgrohe Uno | | | | | | | |
| Kranen | | glashouder m. glas enkel | | | | | | |
| | | 0457213 | chroom | 41534000 | stuk | 105,00 | 259 | 0 |
| Douchegarnituur | | zeephouder m. inzet | | | | | | |
| | | 0457221 | chroom | 41533000 | stuk | 105,00 | 259 | 1 |
| Accessoires en spiegels | | zeepdispenser compleet | | | | | | |
| | | 0457248 | chroom | 41519000 | stuk | 142,00 | 259 | 1 |
| Douchewanden | | planchet 63cm | | | | | | |
| | | 0457256 | glas/chroom | 41550000 | stuk | 284,00 | 259 | 1 |
| Toebehoren & afvoeren | | handdoekhouder 1-delig | | | | | | |
| | | 0457272 | chroom | 41520000 | stuk | 108,00 | 259 | 0 |
| Badkamermeubelen en toiletkasten | | handdoekring | | | | | | |
| | | 0457280 | chroom | 41521000 | stuk | 105,00 | 259 | 1 |
| Gootstenen en wastroggen | | badgreep 30cm | | | | | | |
| | | 0457264 | chroom | 41530000 | stuk | 120,00 | 259 | 1 |
| Utiliteit | | handdoekhouder 60cm | | | | | | |
| | | 0457361 | chroom | 41560000 | stuk | 135,00 | 259 | 1 |
| | | closetrolhouder m. klep | | | | | | |
| | | 0457302 | chroom | 41538000 | stuk | 120,00 | 259 | 0 |
| | | reserverolhouder | | | | | | |
| | | 0457310 | chroom | 41528000 | stuk | 62,50 | 259 | 1 |

| Art.nr | Specificaties | Kleur | Lev.nr | Ehd | Prijs | Grp | CC | | |
|--|---------------|-------|----------|------|--------|-----|----|---|---|
| | | | | | | | | Hansgrohe Uno | |
| closetborstelgarnituur wandmodel 0457337 | | chrom | 41535000 | stuk | 142,00 | 259 | 0 |  | Sanitair producten |
| closetborstelgarnituur staand model 0457329 | | chrom | 41536000 | stuk | 139,00 | 259 | 1 |  | Baden / douchebakken / stoomcabines |
| washandhaakje 0457299 | | chrom | 41537000 | stuk | 18,50 | 259 | 0 |  | Kranen |
| wand-/plafondlamp enkel 0457191 | | chrom | 41556000 | stuk | 241,00 | 259 | 1 |  | Douchegarnituur |
| wand-/plafondlamp dubbel 0457205 | | chrom | 41566000 | stuk | 285,00 | 259 | 1 |  | Accessoires en spiegels |
| | | | | | | | | Hansgrohe spiegels en verlichting | |
| Comtesse scheerspiegel m. verlichting 0452025 | | | 73520000 | stuk | 428,00 | 238 | 1 |  | Douchewanden |
| Princess de luxe scheer- en make up spiegel m. verlichting 0606995 | | chrom | 73540000 | stuk | 392,00 | 238 | 1 |  | Toebehoren & afvoeren |
| Comtesse scheer- en make-up spiegel 0456632 | | chrom | 73525000 | stuk | 235,00 | 238 | 1 |  | Spoel- & installatiesystemen |
| Princess scheer- en make up spiegel 0606804 | | chrom | 73545000 | stuk | 213,00 | 238 | 1 |  | Badkamermeubelen en toiletkasten |
| | | | | | | | | | Gootstenen en wastroggen |
| | | | | | | | | | Utiliteit |

| Art.nr | Specificaties | Kleur | Lev.nr | Ehd | Prijs | Grp | CC |
|--------|---------------|-------|--------|-----|-------|-----|----|
|--------|---------------|-------|--------|-----|-------|-----|----|

Hansgrohe spiegels en verlichting



scheer- en make up spiegel draaibaar
0607002

chrom 40490000 stuk 331,00 238 1



spiegel m. RVS rand
0606960 50x90cm

41210800 stuk 334,00 238 1



spiegel ovaal
0606979 45x90cm

41212000 stuk 334,00 238 1

Sanitair producten

Baden /
douchebakken /
stoomcabines

Kranen

Douchegarnituur

Accessoires en
spiegels

Douchewanden

Toebehoren &
afvoeren

Spoel- &
installatiesystemen

Badkamermeubelen
en toiletkasten

Gootstenen en
wastroggen

Utiliteit

| Art.nr | Specificaties | Kleur | Lev.nr | Ehd | Prijs | Grp | CC | | | |
|-----------------------------------|---------------|----------|-----------|------|--------|-----|----|---|---|---|
| | | | | | | | | Hewi serie 440 | | |
| glashouder | | | | | | | | | | |
| 0090387 | enkel | wit | 440116099 | stuk | 62,50 | 241 | 1 |  | Sanitair producten | |
| 0090395 | enkel | zwart | 440116090 | stuk | 62,50 | 241 | 1 | | | |
| 0090409 | enkel | geel | 440116015 | stuk | 62,50 | 241 | 1 | | | |
| 0090417 | enkel | abrikoos | 440116025 | stuk | 62,50 | 241 | 1 | |  | Baden / douchebakken / stoomcabines |
| 0090433 | dubbel | wit | 440126099 | stuk | 131,00 | 241 | 1 | | | |
| 0090441 | dubbel | zwart | 440126090 | stuk | 131,00 | 241 | 1 | | | |
| 0090468 | dubbel | geel | 440126015 | stuk | 131,00 | 241 | 1 | | | |
| 0090476 | dubbel | abrikoos | 440126025 | stuk | 131,00 | 241 | 1 | | | |
| zeehouder m. matglas inzet | | | | | | | | | | |
| 0090603 | | wit | 440211099 | stuk | 62,50 | 241 | 1 |  | Kranen | |
| 0090611 | | zwart | 440211090 | stuk | 62,50 | 241 | 1 | | | |
| 0090638 | | geel | 440211015 | stuk | 62,50 | 241 | 1 | | | |
| 0090646 | | abrikoos | 440211025 | stuk | 62,50 | 241 | 1 | | | |
| zeepdispenser | | | | | | | | | | |
| 0091081 | | wit | 440310099 | stuk | 140,00 | 241 | 1 |  | Douchegarnituur | |
| 0091103 | | zwart | 440310090 | stuk | 140,00 | 241 | 1 | | | |
| 0091111 | | geel | 440310015 | stuk | 140,00 | 241 | 1 | | | |
| 0091138 | | abrikoos | 440310025 | stuk | 140,00 | 241 | 1 | | | |
| 0091154 | | wit | 440320099 | stuk | 140,00 | 241 | 1 | | | |
| 0091162 | | zwart | 440320090 | stuk | 140,00 | 241 | 1 | | | |
| 0091170 | | geel | 440320015 | stuk | 140,00 | 241 | 1 | | | |
| 0091189 | | abrikoos | 440320025 | stuk | 140,00 | 241 | 1 |  | Accessoires en spiegels | |
| planchet 68cm | | | | | | | | | | |
| 0091200 | | wit | 440568099 | stuk | 200,00 | 241 | 1 |  | Douchewanden | |
| 0091219 | | zwart | 440568090 | stuk | 200,00 | 241 | 1 | | | |
| 0091227 | | geel | 440568015 | stuk | 200,00 | 241 | 1 | | | |
| 0091235 | | abrikoos | 440568025 | stuk | 200,00 | 241 | 1 | | | |
| wandlamp | | | | | | | | | | |
| 0090492 | | wit | 440127499 | stuk | 183,00 | 241 | 1 |  | Toebehoren & afvoeren | |
| 0090506 | | zwart | 440127490 | stuk | 183,00 | 241 | 1 | | | |
| 0090514 | | geel | 440127415 | stuk | 183,00 | 241 | 1 | | | |
| 0090522 | | abrikoos | 440127425 | stuk | 183,00 | 241 | 1 | | | |
| 2-lids handdoekhouder | | | | | | | | | | |
| 0091413 | | wit | 4409199 | stuk | 103,00 | 241 | 1 |  | Badkamermeubelen en toiletkasten | |
| 0091421 | | zwart | 4409190 | stuk | 103,00 | 241 | 1 | | | |
| 0091448 | | geel | 4409115 | stuk | 103,00 | 241 | 1 | | | |
| 0091456 | | abrikoos | 4409125 | stuk | 103,00 | 241 | 1 | | | |
| handdoekhouder 60cm | | | | | | | | | | |
| 0091367 | | wit | 440760099 | stuk | 86,00 | 241 | 1 |  | Gootstenen en wastroggen | |
| 0091375 | | zwart | 440760090 | stuk | 86,00 | 241 | 1 | | | |
| 0091383 | | geel | 440760015 | stuk | 86,00 | 241 | 1 | | | |
| 0091391 | | abrikoos | 440760025 | stuk | 86,00 | 241 | 1 | | | |
| badgreep 26,4cm | | | | | | | | | | |
| 0091316 | | wit | 440724599 | stuk | 87,50 | 241 | 1 |  | Utiliteit | |
| 0091324 | | zwart | 440724590 | stuk | 87,50 | 241 | 1 | | | |
| 0091332 | | geel | 440724515 | stuk | 87,50 | 241 | 1 | | | |
| 0091340 | | abrikoos | 440724525 | stuk | 87,50 | 241 | 1 | | | |
| closetrolhouder | | | | | | | | | | |
| 0090263 | | wit | 44099 | stuk | 41,50 | 241 | 1 |  | | |
| 0090271 | | zwart | 44090 | stuk | 41,50 | 241 | 1 | | | |
| 0090298 | | geel | 44015 | stuk | 41,50 | 241 | 1 | | | |
| 0090301 | | abrikoos | 44025 | stuk | 41,50 | 241 | 1 | | | |
| reserverolhouder | | | | | | | | | | |
| 0090336 | | wit | 440R99 | stuk | 21,25 | 241 | 1 |  | | |
| 0090344 | | zwart | 440R90 | stuk | 21,25 | 241 | 1 | | | |
| 0090352 | | geel | 440R15 | stuk | 21,25 | 241 | 1 | | | |
| 0090360 | | abrikoos | 440R25 | stuk | 21,25 | 241 | 1 | | | |

| | Art.nr | Specificaties | Kleur | Lev.nr | Ehd | Prijs | Grp | CC |
|---|---|---------------|----------|---------------------|------|--------|-----|----|
| | Hewi serie 440 | | | | | | | |
| | closetborstelgarnituur | | | | | | | |
| Sanitair producten | 0090662 | | wit | 440217199 | stuk | 98,00 | 241 | 1 |
| | 0090670 | | zwart | 440217190 | stuk | 98,00 | 241 | 1 |
| | 0090689 | | geel | 440217115 | stuk | 98,00 | 241 | 1 |
| | 0090697 | | abrikoos | 440217125 | stuk | 98,00 | 241 | 1 |
| Baden / douchebakken / stoomcabines |  | | | | | | | |
| | handdoekhaak | | | | | | | |
| Kranen | 0091588 | | wit | 44040299 | stuk | 32,75 | 241 | 1 |
| | 0091596 | | zwart | 44040290 | stuk | 32,75 | 241 | 1 |
| | 0091618 | | geel | 44040215 | stuk | 32,75 | 241 | 1 |
| | 0091626 | | abrikoos | 44040225 | stuk | 32,75 | 241 | 1 |
| |  | | | | | | | |
| | afvalemmer staand model | | | | | | | |
| Douchegarnituur | 0091472 | | wit | 4401220099 | stuk | 127,00 | 241 | 1 |
| | 0091480 | | zwart | 4401220090 | stuk | 127,00 | 241 | 1 |
| | 0091499 | | geel | 4401220015 | stuk | 127,00 | 241 | 1 |
| | 0091502 | | abrikoos | 4401220025 | stuk | 127,00 | 241 | 1 |
| |  | | | | | | | |
| | Hewi serie | | | | | | | |
| | bekerhouder m. beker | | | | | | | |
| Douchewanden | 0090042 | | mat wit | 47700100+4770402005 | stuk | 37,50 | 241 | 1 |
| |  | | | | | | | |
| | zeephouder m. noppen | | | | | | | |
| Toebehoren & afvoeren | 0090034 | | wit | 4770210099 | stuk | 28,00 | 241 | 1 |
| |  | | | | | | | |
| | 2-lids handdoekhouder draaibaar | | | | | | | |
| Spoel- & installatiesystemen | 0090050 | | wit | 4770910099 | stuk | 84,50 | 241 | 1 |
| |  | | | | | | | |
| Badkamermeubelen en toiletkasten | | | | | | | | |
| | closetrolhouder | | | | | | | |
| Gootstenen en wastroggen | 0090018 | | wit | 4772110099 | stuk | 17,50 | 241 | 1 |
| |  | | | | | | | |
| | closetborstelgarnituur | | | | | | | |
| Utiliteit | 0090026 | | wit | 4772010005 | stuk | 69,00 | 241 | 1 |
| |  | | | | | | | |
| | afvalemmer voor wandmontage | | | | | | | |
| | 0090093 | | wit | 4770510099 | stuk | 158,00 | 241 | 1 |
| |  | | | | | | | |
| | haakje 50mm m. rozet | | | | | | | |
| | 0090069 | | wit | 4779001099 | stuk | 4,38 | 241 | 1 |
| |  | | | | | | | |

| Art.nr | Specificaties | Kleur | Lev.nr | Ehd | Prijs | Grp | CC |
|--------|---------------|-------|--------|-----|-------|-----|----|
|--------|---------------|-------|--------|-----|-------|-----|----|

Inda Alessi

glashouder m. glas
0084027

chrom A53100CR03 stuk 177,00 235 1



Sanitair producten

glashouder staand m. glas
0084028

chrom A53010CR03 stuk 149,00 235 1

Baden /
douchebakken /
stoomcabines

Kranen

zeepouder m. inzet glas
0084037

chrom A53110CR03 stuk 150,00 235 1



Douchegarnituur

Accessoires en
spiegels

zeepouder staand m. inzet glas
0084038

chrom A53020CR03 stuk 136,00 235 1



Douchewanden

Toebehoren &
afvoeren

zeepdispenser staand
0084041

chrom A53060CR stuk 190,00 235 1

Spoel- &
installatiesystemen

zeepdispenser
0084040

chrom A53670CR stuk 258,00 235 1

Badkamermeubelen
en toiletkastenGootstenen en
wastroggen

hoekzeepouder m. inzet glas
0084108

chrom A53310CR03 stuk 130,00 235 1



Utiliteit

planchet

| | | | | | | | |
|---------|--------------|------|-----------|------|--------|-----|---|
| 0084087 | 37.5x16.5cm | hout | A5309A XQ | stuk | 122,00 | 235 | 1 |
| 0084088 | 75x16.5cm | hout | A5309C XQ | stuk | 165,00 | 235 | 1 |
| 0084089 | 112.5x16.5cm | hout | A5309E XQ | stuk | 206,00 | 235 | 1 |
| 0084090 | 150x16.5cm | hout | A5309G XQ | stuk | 268,00 | 235 | 1 |









planchet voor AL533A







| | | | | | | | |
|---------|--------|------|-----------|------|--------|-----|---|
| 0084103 | 37.5cm | hout | A5309S XQ | stuk | 159,00 | 235 | 1 |
| 0084104 | 75cm | hout | A5309U XQ | stuk | 202,00 | 235 | 1 |



lamp voor planchet m. schakelaar
0084102





AL533ACR stuk 475,00 235 1











| | Art.nr | Specificaties | Kleur | Lev.nr | Ehd | Prijs | Grp | CC |
|---|---|---------------|-------|----------|------|--------|-----|----|
| | Inda Alessi | | | | | | | |
| | handdoekring | | | | | | | |
| Sanitair producten | 0084023 | | chrom | A53160CR | stuk | 116,00 | 235 | 1 |
| Baden / douchebakken / stoomcabines |  | | | | | | | |
| | handdoekhouder vrijstaand draaibaar | | | | | | | |
| Kranen | 0084031 | | chrom | A53840CR | stuk | 420,00 | 235 | 1 |
| Douchegarnituur |  | | | | | | | |
| | handdoekhouder staand 122.5cm | | | | | | | |
| Accessoires en spiegels | 0084030 | | chrom | A53850CR | stuk | 338,00 | 235 | 1 |
| Douchewanden |  | | | | | | | |
| | handdoekhouder staand 182.5cm | | | | | | | |
| Toebehoren & afvoeren | 0084029 | | chrom | A53880CR | stuk | 501,00 | 235 | 1 |
| Spoel- & installatiesystemen |  | | | | | | | |
| | handdoekhouder | | | | | | | |
| Badkamermeubelen en toiletkasten | 0084024 | 43x9.3cm | chrom | A5390ACR | stuk | 136,00 | 235 | 1 |
| | 0084025 | 63x9.3cm | chrom | A5390BCR | stuk | 158,00 | 235 | 1 |
| |  | | | | | | | |
| | badgreep | | | | | | | |
| Gootstenen en wastroggen | 0084110 | | chrom | A5390MCR | stuk | 136,00 | 235 | 1 |
| Utiliteit |  | | | | | | | |
| | closetborstelgarnituur staand | | | | | | | |
| | 0084039 | | chrom | A53140CR | stuk | 171,00 | 235 | 1 |
| |  | | | | | | | |
| | closetrolhouder | | | | | | | |
| | 0084035 | | chrom | A5325ACR | stuk | 82,00 | 235 | 1 |
| |  | | | | | | | |
| | closetrolhouder dubbel | | | | | | | |
| | 0084036 | | chrom | A5325BCR | stuk | 123,00 | 235 | 1 |
| |  | | | | | | | |











| Art.nr | Specificaties | Kleur | Lev.nr | Ehd | Prijs | Grp | CC | | |
|---|---------------|-------------|-----------|------|---------|-----|----|---|---|
| | | | | | | | | Inda Alessi | |
| badrek 0084032 | | chroom/hout | A53410DJ | stuk | 338,00 | 235 | 1 |  | Sanitair producten |
| spiegel vergrotend staand verstelbaar 0084109 | | chroom | A53590CR | stuk | 270,00 | 235 | 1 |  | Baden / douchebakken / stoomcabines |
| spiegel 0084096 75x75cm | | | A5371A | stuk | 189,00 | 235 | 1 | | Kranen |
| 0084097 112.5x75cm | | | A5371C | stuk | 226,00 | 235 | 1 | | Doucheapparatuur |
| 0084098 150x75cm | | | A5371E | stuk | 275,00 | 235 | 1 | | Accessoires en spiegels |
| 0084099 37.5x90cm | | | A5371F | stuk | 163,00 | 235 | 1 | | |
| 0084100 65x113cm | | | A5371G | stuk | 213,00 | 235 | 1 | | |
| 0084101 65x122.5cm | | | A5371L | stuk | 226,00 | 235 | 1 | | |
| kledinghaak 0084033 | | chroom | A53200CR | stuk | 54,00 | 235 | 1 |  | Douchewanden |
| krukje/wasmand + houten deksel 0084111 | | | A53750IL | stuk | 501,00 | 235 | 1 |  | Toebehoren & afvoeren |
| trolley m. 4 laden 0084112 | | hout | A53800XQ | stuk | 1355,00 | 235 | 1 | | Spoel- & installatiesystemen |
| sifon 0084137 | | chroom | A9161C CR | stuk | 106,00 | 235 | 1 | | Badkamermeubelen en toiletkasten |
| wandlamp halogeen 0084105 | | | AL5310CR | stuk | 379,00 | 235 | 1 |  | Gootstenen en wastroggen |
| lamp halogeen voor kastje 0084106 | | | AL5320CR | stuk | 430,00 | 235 | 1 |  | Utiliteit |









| | Art.nr | Specificaties | Kleur | Lev.nr | Ehd | Prijs | Grp | CC |
|---|----------------------|--|-----------|---------|------|--------|-----|----|
| Sanitair producten | Jado Geometry | | | | | | | |
| | | closetrolhouder m. achterplaat 0426083 | chrom | F1327AA | stuk | 112,00 | 219 | 1 |
| Baden / douchebakken / stoomcabines | | closetrolhouder z. achterplaat 0426091 | chrom | F1302AA | stuk | 66,00 | 219 | 1 |
| Kranen | | reserverolhouder 0426105 | chrom | F1325AA | stuk | 51,50 | 219 | 1 |
| Douchegarnituur | | closetborstelgarnituur 0426113 | chrom | F1326AA | stuk | 127,00 | 219 | 1 |
| Accessoires en spiegels | | handdoekhaak 2-stuks 0426121 | chrom | F1328AA | stuk | 39,50 | 219 | 1 |
| Douchewanden | | wandhanddoekrek 0426148 65cm | chrom | F1331AA | stuk | 83,00 | 219 | 1 |
| Toebehoren & afvoeren | | 0426156 75cm | chrom | F1332AA | stuk | 89,00 | 219 | 1 |
| | | 0426164 85cm | chrom | F1333AA | stuk | 94,50 | 219 | 1 |
| Spoel- & installatiesystemen | | handdoekkring 0426172 | chrom | F1314AA | stuk | 74,50 | 219 | 1 |
| Badkamermeubelen en toiletkasten | | spiegelhouder 4-stuks 0426180 | chrom | F1304AA | stuk | 103,00 | 219 | 1 |
| Gootstenen en wastroggen | | planchet 47cm 0426199 | chrom/RVS | F1310AA | stuk | 251,00 | 219 | 1 |
| Utiliteit | | zeephouder 0426202 | chrom/RVS | F1311AA | stuk | 157,00 | 219 | 1 |

| Art.nr | Specificaties | Kleur | Lev.nr | Ehd | Prijs | Grp | CC | | |
|---|---------------|------------|---------|------|--------|-----|----|---|---|
| | | | | | | | | Jado Geometry | |
| shampoo houder 25cm 0426210 | | chroom/RVS | F1313AA | stuk | 206,00 | 219 | 1 |  | Sanitair producten |
| zeepdispenser inbouw 0426229 | | chroom | F1648AA | stuk | 98,50 | 219 | 1 |  | Baden / douchebakken / stoomcabines |
| | | | | | | | | Jado New Haven | |
| glashouder enkel m. opaalgas 0530182 | | chroom | L4033AA | stuk | 153,00 | 219 | 1 |  | Kranen |
| zeephouder m. opaalgas inzet 0530190 | | chroom | L4032AA | stuk | 125,00 | 219 | 1 |  | Douchegarnituur |
| zeepdispenser m. opaalgas 0530204 | | chroom | L4037AA | stuk | 229,00 | 219 | 1 |  | Accessoires en spiegels |
| planchet 60cm 0530220 | | chroom | L4036AA | stuk | 204,00 | 219 | 1 |  | Douchewanden |
| 2-lids handdoekhouder draaibaar 0530115 | | chroom | H2136AA | stuk | 166,00 | 219 | 1 |  | Toebehoren & afvoeren |
| handdoekhouder 60cm 0530123 | | chroom | L4035AA | stuk | 191,00 | 219 | 1 |  | Spoel- & installatiesystemen |
| badgreep 30cm 0530131 | | chroom | H2135AA | stuk | 153,00 | 219 | 1 |  | Badkamermeubelen en toiletkasten |
| | | | | | | | | | Gootstenen en wastroggen |
| | | | | | | | | | Utiliteit |





| | Art.nr | Specificaties | Kleur | Lev.nr | Ehd | Prijs | Grp | CC |
|---|---|---|--------|---------|------|--------|-----|----|
| | Jado New Haven | | | | | | | |
| Sanitair producten | | closetrolhouder z. klep 0530166 | chroom | L4031AA | stuk | 120,00 | 219 | 1 |
| Baden / douchebakken / stoomcabines |  | | | | | | | |
| Kranen | | closetrolhouder m. klep 0530158 | chroom | L4030AA | stuk | 150,00 | 219 | 1 |
| Douchegarnituur |  | | | | | | | |
| Accessoires en spiegels | | reserverolhouder 0530174 | chroom | L4515AA | stuk | 85,50 | 219 | 1 |
| Douchewanden |  | | | | | | | |
| Toebehoren & afvoeren | | closetborstelgarnituur 0530239 | chroom | L4038AA | stuk | 175,00 | 219 | 1 |
| Spoel- & installatiesystemen |  | | | | | | | |
| Badkamermeubelen en toiletkasten | | handdoekhaak 0530212 | chroom | L4039AA | stuk | 48,75 | 219 | 1 |
| Gootstenen en wastroggen |  | | | | | | | |
| Utiliteit | | | | | | | | |









| Art.nr | Specificaties | Kleur | Lev.nr | Ehd | Prijs | Grp | CC | | |
|---|---------------|--------|------------|------|--------|-----|----|---|---|
| | | | | | | | | Keuco Alea | |
| glashouder m. glas enkel 0684007 | | chroom | 750019000 | stuk | 96,50 | 229 | 1 |  | Sanitair producten |
| zeephouder m. metalen inzet 0684031 | | chroom | 754010100 | stuk | 119,00 | 229 | 1 |  | Baden / douchebakken / stoomcabines |
| zeepdispenser wandmodel 0684015 | | chroom | 752019000 | stuk | 146,00 | 229 | 1 |  | Kranen |
| wandlamp m. opaalglas halogeen 0684090 | | chroom | 6509019000 | stuk | 153,00 | 229 | 1 |  | Douchegarnituur |
| 1-lids handdoekhouder draaibaar 0683973 | | chroom | 717010000 | stuk | 97,00 | 229 | 1 |  | Accessoires en spiegels |
| handdoekring 0683981 | | chroom | 721010000 | stuk | 126,00 | 229 | 1 |  | Douchewanden |
| handdoekhouder 60cm 0683949 | | chroom | 701010600 | stuk | 145,00 | 229 | 1 |  | Toebehoren & afvoeren |
| badgreep 35cm 0683957 | | chroom | 707010000 | stuk | 144,00 | 229 | 1 |  | Spoel- & installatiesystemen |
| closetrolhouder z. klep 0684066 | | chroom | 760010000 | stuk | 98,50 | 229 | 0 |  | Badkamermeubelen en toiletkasten |
| reserverolhouder 0684074 | | chroom | 763010000 | stuk | 74,00 | 229 | 1 |  | Gootstenen en wastroggen |
| closetborstelgarnituur 0684082 | | chroom | 764010100 | stuk | 114,00 | 229 | 0 |  | Utiliteit |











| | Art.nr | Specificaties | Kleur | Lev.nr | Ehd | Prijs | Grp | CC | |
|---|---|---|---------|------------|-------------|-------|--------|-----|---|
| Sanitair producten | Keuco Alea | | | | | | | | |
| |  | handdoekhaak dubbel | | chrom | 715010000 | stuk | 72,50 | 229 | 1 |
| 0683965 | | | | | | | | | |
| Baden / douchebakken / stoomcabines | | | | | | | | | |
| Kranen | Keuco Amaro | | | | | | | | |
| |  | glashouder m. kristalglas z. decor-set | | chrom | 1850019000 | stuk | 97,00 | 229 | 1 |
| | | 0680146 | rechts | | | | | | |
| 0680045 | | rechts | chrom | 1850019001 | stuk | 97,00 | 229 | 1 | |
| Douchegarnituur | | | | | | | | | |
| Accessoires en spiegels | zeepdispenser compleet | | | | | | | | |
| |  | 0680039 | links | chrom | 1852019001 | stuk | 158,00 | 229 | 1 |
| | | 0680043 | rechts | chrom | 1852019000 | stuk | 158,00 | 229 | 1 |
| | | | | | | | | | |
| Douchewanden | | | | | | | | | |
| Toebehoren & afvoeren | handdoekhouder 80cm z. decor-set | | | | | | | | |
| |  | 0680156 | | chrom | 1801010800 | stuk | 116,00 | 229 | 1 |
| | | | | | | | | | |
| glasplaat cristallin | | | | | | | | | |
| Spoel- & installatiesystemen |  | 0680157 | 65x13cm | | 1810005600 | stuk | 98,00 | 229 | 1 |
| | | | | | | | | | |
| | | planchetconsoles per paar z. decor-set | | | | | | | |
| Badkamermeubelen en toiletkasten |  | 0680154 | | chrom | 1810010000 | stuk | 76,50 | 229 | 1 |
| | | | | | | | | | |
| | | handdoekhouder 2-delig z. decor-set | | | | | | | |
| Gootstenen en wastroggen |  | 0680152 | | chrom | 1818010000 | stuk | 89,00 | 229 | 1 |
| | | | | | | | | | |
| | | closetrolhouder m. klep z. decor-set | | | | | | | |
| Utiliteit |  | 0680390 | | chrom | 1860010000 | stuk | 107,00 | 229 | 1 |
| | | | | | | | | | |
| | | closetrolhouder z. klep z. decor-set | | | | | | | |
| Utiliteit |  | 0686220 | | chrom | 01862010000 | stuk | 90,50 | 229 | 1 |
| | | | | | | | | | |
| | | closetborstelgarnituur z. decor-set | | | | | | | |
| Utiliteit |  | 0680147 | | chrom | 1864010100 | stuk | 129,00 | 229 | 1 |
| | | | | | | | | | |
| | | jashaak z. decor-set | | | | | | | |
| Utiliteit |  | 0686212 | | chrom | 1816010000 | stuk | 46,75 | 229 | 1 |
| | | | | | | | | | |
| | | | | | | | | | |











| Art.nr | Specificaties | Kleur | Lev.nr | Ehd | Prijs | Grp | CC | | |
|---|----------------------|----------------|-------------|------|--------|-----|----|---|--|
| | | | | | | | | Keuco Amaro | |
| handdoekhaak dubbel z. decor-set 0686204 | | chroom | 01813010000 | stuk | 54,50 | 229 | 1 |  | Sanitair producten |
| decor-set 0680055 | 01 Dornbracht Domani | chroom | 1901010000 | stuk | 15,50 | 229 | 1 | | Baden / douchebakken / stoomcabines |
| 0680151 | 08 F-Grohe Chiara | chroom/matchr. | 1908280000 | stuk | 22,50 | 229 | 1 | | |
| 0683966 | 24 F-Grohe Sentosa | chroom/matchr. | 1924280000 | stuk | 42,75 | 229 | 1 | | |
| wandlamp z. glas z. decor-set 0680155 | | chroom | 6514010000 | stuk | 130,00 | 229 | 1 |  | Kranen Douchegarnituur |
| opaalglas voor wandlamp klein 0680054 | | | 6514009000 | stuk | 57,00 | 229 | 1 | | Accessoires en spiegels |
| spiegel m. decorrand 0685000 65x80cm | | | 7771002500 | stuk | 234,00 | 229 | 1 |  | Douchewanden Toebehoren & afvoeren |
| spiegel rondom facetgeslepen m. verlichting en planchet 0680060 37x72cm | | chroom | 7819012000 | stuk | 537,20 | 229 | 1 | | |
| | | | | | | | | Keuco Apollo | |
| kristalspiegel 60x70cm 0680370 | | chroom | 7746002000 | stuk | 223,00 | 229 | 1 |  | Spoel- & installatiesystemen Badkamermeubelen en toiletkasten |
| opaalglas kegelvorm voor dispenser 0680011 | | | 4950009000 | stuk | 40,25 | 229 | 1 | | Gootstenen en wastroggen |
| opaalglas bolvorm voor dispenser 0680031 | | | 4951009000 | stuk | 40,25 | 229 | 1 | | |
| | | | | | | | | Keuco Astor | |
| glashouder m. glas enkel 0680096 | | chroom | 2150019000 | stuk | 106,00 | 229 | 1 |  | Utiliteit |
| handdoekhouder 60cm 0680236 | | chroom | 2101010600 | stuk | 122,00 | 229 | 1 |  | |
| badgreep 30cm 0680150 | | chroom | 2107010000 | stuk | 109,00 | 229 | 1 |  | |
| glasplaat cristallin 65x12cm 0680239 | | | 2110005600 | stuk | 115,00 | 229 | 1 |  | |
| planchetconsoles per paar 0680234 | | chroom | 2110010000 | stuk | 76,00 | 229 | 1 | | |













| | Art.nr | Specificaties | Kleur | Lev.nr | Ehd | Prijs | Grp | CC |
|---|--------------------|--|--|-------------|-------------|--------|--------|-----|
| Sanitair producten | Keuco Astor | | | | | | | |
| | | handdoekhaak klein 0680207 | chroom | 2114010000 | stuk | 19,25 | 229 | 1 |
| Baden / douchebakken / stoomcabines | | handdoekhaak groot 0680233 | chroom | 2116010000 | stuk | 42,75 | 229 | 1 |
| | Kranen | | handdoekkring 0633884 | chroom | 2121010000 | stuk | 76,50 | 229 |
| Douchegarnituur | | | 2-lids handdoekhouder 46cm 0686255 | chroom | 02118010000 | stuk | 136,00 | 229 |
| Accessoires en spiegels | | handdoekhouder vast 43cm 0686247 | chroom | 02117010000 | stuk | 66,00 | 229 | 1 |
| Douchewanden | | zeepdispenser compleet 0680091 | chroom | 2152019000 | stuk | 152,00 | 229 | 1 |
| Toebehoren & afvoeren | | closetrolhouder m. klep 0680090 | chroom | 2160010000 | stuk | 95,50 | 229 | 1 |
| Spool- & installatiesystemen | | reserverolhouder 0680093 | chroom | 2163010000 | stuk | 75,50 | 229 | 1 |
| Badkamermeubelen en toiletkasten | | closetborstelgarnituur wandmodel 0680084 | chroom | 2164019000 | stuk | 153,00 | 229 | 1 |
| Gootstenen en wastroggen | | wanddecoratieschijf 0680086 | chroom | 2191010000 | stuk | 32,50 | 229 | 1 |
| Utiliteit | | wanddecoratieschijf voor lamp 0680088 | chroom | 2195010000 | stuk | 42,75 | 229 | 1 |

| Art.nr | Specificaties | Kleur | Lev.nr | Ehd | Prijs | Grp | CC | | |
|--|---|-------------|-------------|------|--------|-----|----|---|---|
| | | | | | | | | Keuco Astor | |
| wandlamp m. opaalglas | | | | | | | | | |
| 0680089 | | chroom | 6541019000 | stuk | 171,00 | 229 | 1 |  | Sanitair producten |
| <hr/> | | | | | | | | | |
| | | | | | | | | Keuco City.2 | |
| glashouder dubbel z. glas | | | | | | | | | |
| 0680425 | | chroom | 2751010000 | stuk | 38,50 | 229 | 1 |  | Baden / douchebakken / stoomcabines |
| 0604130 | drinkglas voor houder kristalglas | | 02350009000 | stuk | 13,75 | 229 | 1 | | Kranen |
| <hr/> | | | | | | | | | |
| zeep-/glas-/dispenserhouder z. glas | | | | | | | | | |
| 0680419 | | chroom | 2750010000 | stuk | 32,75 | 229 | 1 |  | Douchegarnituur |
| 0604130 | drinkglas voor houder kristalglas | | 02350009000 | stuk | 13,75 | 229 | 1 | | Accessoires en spiegels |
| 0604134 | zeepschaal voor houder kristalglas | | 02355009000 | stuk | 18,50 | 229 | 1 | | |
| 0604137 | lotiondispenser kunststof m. pomp voor houder | chroom | 2353010100 | stuk | 26,25 | 229 | 1 | | |
| 0604138 | lotiondispenser kristalglas m. pomp voor houder | chroom | 02753019000 | stuk | 59,00 | 229 | 1 | | |
| <hr/> | | | | | | | | | |
| drinkglas voor houder | | | | | | | | | |
| 0604130 | | kristalglas | 02350009000 | stuk | 13,75 | 229 | 1 |  | Douchewanden |
| <hr/> | | | | | | | | | |
| zeepschaal voor houder | | | | | | | | | |
| 0604134 | | kristalglas | 02355009000 | stuk | 18,50 | 229 | 1 | | Toebehoren & afvoeren |
| <hr/> | | | | | | | | | |
| lotiondispenser kunststof m. pomp voor houder | | | | | | | | | |
| 0604137 | | chroom | 2353010100 | stuk | 26,25 | 229 | 1 |  | Spoel- & installatiesystemen |
| <hr/> | | | | | | | | | |
| handgreep 25cm | | | | | | | | | |
| 0680404 | | chroom | 2707010000 | stuk | 53,50 | 229 | 1 |  | Badkamermeubelen en toiletkasten |
| <hr/> | | | | | | | | | |
| planchet kristalglas | | | | | | | | | |
| 0680406 | 45x12cm | | 2710009400 | stuk | 64,50 | 229 | 1 |  | Gootstenen en wastroggen |
| 0680407 | 65x12cm | | 2710009600 | stuk | 77,50 | 229 | 1 | | |
| <hr/> | | | | | | | | | |
| planchetconsole per paar | | | | | | | | | |
| 0680405 | | chroom | 2710010000 | stuk | 38,50 | 229 | 1 | | Utiliteit |
| 0680406 | planchet kristalglas 45x12cm | | 2710009400 | stuk | 64,50 | 229 | 1 | | |
| 0680407 | planchet kristalglas 65x12cm | | 2710009600 | stuk | 77,50 | 229 | 1 | | |
| <hr/> | | | | | | | | | |
| handdoekhaak | | | | | | | | | |
| 0680408 | | chroom | 2714010000 | stuk | 4,75 | 229 | 1 |  | |













| | Art.nr | Specificaties | Kleur | Lev.nr | Ehd | Prijs | Grp | CC |
|---|---|----------------------------|--------|------------|------|--------|-----|----|
| Sanitair producten | Keuco City.2 | | | | | | | |
| | | handdoekhaak dubbel | | | | | | |
| | 0680409 | | chroom | 2715010000 | stuk | 24,75 | 229 | 1 |
| Baden / douchebakken / stoomcabines |  | | | | | | | |
| Kranen | 2-lids handdoekhouder draaibaar 43cm | | | | | | | |
| | | 0680410 | | | | | | |
| | | | chroom | 2718010000 | stuk | 49,50 | 229 | 1 |
| Douchegarnituur |  | | | | | | | |
| Accessoires en spiegels | handdoekring | | | | | | | |
| | | 0680418 | | | | | | |
| | | | chroom | 2721010000 | stuk | 44,25 | 229 | 1 |
| Douchewanden |  | | | | | | | |
| Toebehoren & afvoeren | handdoekhouder | | | | | | | |
| | | 0680400 40cm | | | | | | |
| | | 0680401 60cm | | | | | | |
| | | 0680402 80cm | | | | | | |
| | | | chroom | 2701010400 | stuk | 61,00 | 229 | 1 |
| | | | chroom | 2701010600 | stuk | 65,50 | 229 | 1 |
| | | | chroom | 2701010800 | stuk | 75,50 | 229 | 1 |
| Spoel- & installatiesystemen |  | | | | | | | |
| Badkamermeubelen en toiletkasten | handdoekhouder 2-delig | | | | | | | |
| | | 0680403 60cm | | | | | | |
| | | | chroom | 2703010600 | stuk | 122,00 | 229 | 1 |
| Badkamermeubelen en toiletkasten |  | | | | | | | |
| Gootstenen en wastroggen | closetrolhouder m. klep | | | | | | | |
| | | 0680431 | | | | | | |
| | | | chroom | 2760010000 | stuk | 42,00 | 229 | 1 |
| Gootstenen en wastroggen |  | | | | | | | |
| Utiliteit | closetrolhouder z. klep | | | | | | | |
| | | 0680432 | | | | | | |
| | | | chroom | 2762010000 | stuk | 37,50 | 229 | 1 |
| Utiliteit |  | | | | | | | |
| Utiliteit | reserverolhouder | | | | | | | |
| | | 0680433 | | | | | | |
| | | | chroom | 2763010000 | stuk | 27,00 | 229 | 1 |
| Utiliteit |  | | | | | | | |
| Utiliteit | closetborstelgarnituur kunststof | | | | | | | |
| | | 0680434 | | | | | | |
| | | | chroom | 2764010100 | stuk | 56,00 | 229 | 1 |
| Utiliteit |  | | | | | | | |









| Art.nr | Specificaties | Kleur | Lev.nr | Ehd | Prijs | Grp | CC | | |
|---|---|-------|-------------|------|--------|-----|----|---|----------------------------------|
| | | | | | | | | Keuco City.2 | |
| wandlamp m. opaalglas 0680445 | | chrom | 6523019000 | stuk | 138,00 | 229 | 1 |  | Sanitair producten |
| | | | | | | | | Keuco City.2 Onderdelen | |
| 0680438 | lampglas opaal | | 6523009000 | stuk | 76,50 | 229 | 1 | | |
| 0680436 | borstelkop voor closetborstelgarnituur wit | | 1864004000 | stuk | 10,00 | 229 | 1 | | Kranen |
| 0680435 | inzet voor closetborstelgarnituur wit | | 14972000100 | stuk | 11,75 | 229 | 1 | | |
| 0604139 | lotiondispenser kunststof z. houder z. pomp | | 4053000100 | stuk | 10,50 | 229 | 1 | | |
| 0604140 | lotiondispenser kristalglas z. houder z. pomp | | 2753009000 | stuk | 43,25 | 229 | 1 | | |
| 0604141 | pomp voor lotiondispenser | | 2353010000 | stuk | 15,75 | 229 | 1 | | Douchegarnituur |
| | | | | | | | | Keuco Cleo | |
| glashouder enkel m. kristalglas 0680333 | | chrom | 3850019000 | stuk | 103,00 | 229 | 1 |  | Accessoires en spiegels |
| drinkglas bleikristal 0680335 | | | 3850009000 | stuk | 48,50 | 229 | 1 | | Douchewanden |
| zeephouder vast geheel 0683832 | | chrom | 3854010000 | stuk | 107,00 | 229 | 1 |  | Toebehoren & afvoeren |
| zeephouder m. kristal inzet 0686263 | | chrom | 03855019000 | stuk | 103,00 | 229 | 1 |  | Spoel- & installatiesystemen |
| zeepdispenser z. houder 0680334 | | | 3853009000 | stuk | 42,25 | 229 | 1 |  | Badkamermeubelen en toiletkasten |
| 2-lids handdoekhouder draaibaar 0683879 | | chrom | 3818010000 | stuk | 140,00 | 229 | 1 |  | Gootstenen en wastroggen |
| handdoekring | | | | | | | | | |
| 0683881 | rechts | chrom | 3821010100 | stuk | 123,00 | 229 | 1 |  | |
| 0683831 | links | chrom | 3821010200 | stuk | 123,00 | 229 | 1 | | |
| handgreep 30cm 0680446 | | chrom | 3807010000 | stuk | 150,00 | 229 | 1 |  | |
| handdoekhouder 80cm 0633882 | | chrom | 3801010800 | stuk | 154,00 | 229 | 1 |  | |
| closetrolhouder z. klep 0683830 | | chrom | 3862010000 | stuk | 102,00 | 229 | 1 |  | |







| | Art.nr | Specificaties | Kleur | Lev.nr | Ehd | Prijs | Grp | CC |
|---|---|---|-------|-------------|------|--------|-----|----|
| Sanitair producten | Keuco Cleo | | | | | | | |
| |  | closetrolhouder m. klep 0680447 | chrom | 3860010000 | stuk | 137,00 | 229 | 1 |
| Baden / douchebakken / stoomcabines |  | reserverolhouder 0680448 | chrom | 3863010000 | stuk | 80,00 | 229 | 1 |
| Kranen | | | | | | | | |
| Douchegarnituur |  | handdoekhaak enkel 0680444 | chrom | 3814010000 | stuk | 19,50 | 229 | 1 |
| Accessoires en spiegels |  | wanddecoratieschijf 0680470 | chrom | 3891010000 | stuk | 29,25 | 229 | 1 |
| Douchewanden | | | | | | | | |
| Toebehoren & afvoeren |  | zeepdispenser compleet 0683002 | chrom | 3852019000 | stuk | 142,00 | 229 | 1 |
| Spoel- & installatiesystemen | | | | | | | | |
| Badkamermeubelen en toiletkasten | Keuco Edition 100 | | | | | | | |
| |  | glashouder m. glas 0684414 | chrom | 10050019000 | stuk | 92,50 | 229 | 1 |
| Gootstenen en wastroggen |  | zeephouder m. inzet 0684430 | chrom | 10055019000 | stuk | 93,50 | 229 | 1 |
| Utiliteit |  | zeepdispenser 0684422 | chrom | 10052019000 | stuk | 146,00 | 229 | 1 |
| |  | glasplaat voor planchet 0684341 35x12cm | | 10010015300 | stuk | 127,00 | 229 | 1 |
| | | 0684368 55x12cm | | 10010015500 | stuk | 142,00 | 229 | 1 |
| | | 0684376 75x12cm | | 10010015700 | stuk | 165,00 | 229 | 1 |
| | | planchetconsoles per paar 0684333 | | 10010010000 | stuk | 105,00 | 229 | 1 |
| |  | wandlamp compleet 0684503 | chrom | 10092019000 | stuk | 267,00 | 229 | 1 |







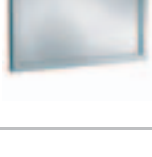

| Art.nr | Specificaties | Kleur | Lev.nr | Ehd | Prijs | Grp | CC | | |
|--|---------------|----------------|-------------|------|--------|-----|----|---|---|
| | | | | | | | | Keuco Edition 100 | |
| 2-lids handdoekhouder draaibaar | | | | | | | | | |
| 0684392 | | chroom | 10018010000 | stuk | 123,00 | 229 | 1 |  | Sanitair producten |
| handdoekhouder | | | | | | | | | |
| 0684309 | 60cm | chroom | 10001010600 | stuk | 121,00 | 229 | 1 |  | Baden / douchebakken / stoomcabines |
| 0684317 | 80cm | chroom | 10001010800 | stuk | 134,00 | 229 | 1 |  | |
| handgreep 30cm | | | | | | | | | |
| 0684325 | | chroom | 10007010000 | stuk | 113,00 | 229 | 1 |  | Kranen |
| handdoekring | | | | | | | | | |
| 0684406 | | chroom | 10021010000 | stuk | 83,00 | 229 | 1 |  | Douchegarnituur |
| closetrolhouder m. klep | | | | | | | | | |
| 0684457 | | chroom | 10060010000 | stuk | 102,00 | 229 | 1 |  | Accessoires en spiegels |
| closetrolhouder z. klep | | | | | | | | | |
| 0684465 | | chroom | 10062010000 | stuk | 94,50 | 229 | 1 |  | Douchewanden |
| reserverolhouder | | | | | | | | | |
| 0684473 | | chroom | 10063010000 | stuk | 57,50 | 229 | 1 |  | Toebehoren & afvoeren |
| closetborstelgarnituur | | | | | | | | | |
| 0684481 | | chroom | 10064010100 | stuk | 185,00 | 229 | 1 |  | Spoel- & installatiesystemen |
| sponshouder draadmodel | | | | | | | | | |
| 0684449 | | chroom | 10058010000 | stuk | 118,00 | 229 | 1 |  | Badkamermeubelen en toiletkasten |
| handdoekhaak dubbel | | | | | | | | | |
| 0684384 | | chroom | 10013010000 | stuk | 39,00 | 229 | 1 |  | Gootstenen en wastroggen |
| decoratiering | | | | | | | | | |
| 0684511 | | chroom | 10091010000 | stuk | 8,10 | 229 | 1 |  | Utiliteit |
| 0684538 | | chroom/matchr. | 10091150000 | stuk | 10,75 | 229 | 1 | | |
| 0684562 | | edelmessing | 10091600000 | stuk | 13,75 | 229 | 1 | | |
| 0684546 | | verguld | 10091220000 | stuk | 16,25 | 229 | 1 | | |
| 0684554 | | zwart | 10091570000 | stuk | 10,75 | 229 | 1 | | |
| spiegel m. facet | | | | | | | | | |
| 0686182 | 35x85cm | | 10095002000 | stuk | 178,00 | 229 | 1 |  | |
| 0686190 | 55x85cm | | 10095002500 | stuk | 203,00 | 229 | 1 | | |











| | Art.nr | Specificaties | Kleur | Lev.nr | Ehd | Prijs | Grp | CC |
|---|---|---|-----------|-------------|-------------|--------|--------|-------|
| Sanitair producten | Keuco Edition 100 | | | | | | | |
| | | spiegel m. halogeen verlichting | | | | | | |
| | | 0681319 | 35x94.7cm | chroom | 10096012000 | stuk | 455,00 | 229 1 |
| | | 0685895 | 55x94.7cm | chroom | 10096012500 | stuk | 479,00 | 229 1 |
| Baden / douchebakken / stoomcabines | | 0680069 | 75x94.7cm | chroom | 10096013000 | stuk | 509,40 | 229 1 |
| | Kranen | Bella Vista cosmeticspiegel voor wandmontage m. verlichting m. snoer | | | | | | |
| | | | 0680010 | | 17605019000 | stuk | 535,00 | 229 1 |
| Douchegarnituur | Bella Vista cosmeticspiegel voor wandmontage m. verlichting z. snoer | | | | | | | |
| | | 0680016 | | 17605019001 | stuk | 535,00 | 229 1 | |
| | Bella Vista spiegel staand m. verlichting | | | | | | | |
| | | 0680017 | | 17606019000 | stuk | 535,00 | 229 1 | |
| Accessoires en spiegels | Keuco Edition 200 | | | | | | | |
| | | glashouder m. glas compleet | | | | | | |
| | | 0685321 | | chroom | 20050019000 | stuk | 90,50 | 229 1 |
| Douchewanden | zeephouder compleet | | | | | | | |
| | | 0685356 | | chroom | 20055019000 | stuk | 86,00 | 229 1 |
| Toebehoren & afvoeren | zeepdispenser compleet | | | | | | | |
| | | 0685348 | | chroom | 20052019000 | stuk | 153,00 | 229 1 |
| Spool- & installatiesystemen | consoles voor planchet per paar | | | | | | | |
| | | 0685240 | | chroom | 20010010000 | stuk | 88,00 | 229 1 |
| Badkamermeubelen en toiletkasten | planchet kristalglas | | | | | | | |
| | | 0685259 | 430x130mm | | 20010005400 | stuk | 107,00 | 229 1 |
| Gootstenen en wastroggen | | 0685267 | 550x130mm | | 20010005500 | stuk | 110,00 | 229 1 |
| | Utiliteit | wandlamp | | | | | | |
| | | 0685399 | klein | chroom | 20092019000 | stuk | 157,00 | 229 1 |
| | | 0685402 | groot | chroom | 20093019000 | stuk | 182,00 | 229 1 |
| | 2-lids handdoekhouder | | | | | | | |
| | | 0685305 | | chroom | 20018010000 | stuk | 102,00 | 229 1 |
| | handdoekring | | | | | | | |
| | | 0685313 | | chroom | 20021010000 | stuk | 100,00 | 229 1 |









| Art.nr | Specificaties | Kleur | Lev.nr | Ehd | Prijs | Grp | CC | | |
|---|---------------|--------|-------------|------|--------|-----|----|---|---|
| Keuco Edition 200 | | | | | | | | | |
| handdoekhouder 60cm | | | | | | | | | |
| 0685216 | | chroom | 20001010600 | stuk | 116,00 | 229 | 1 |  | Sanitair producten |
| 0685224 | dubbel | chroom | 20003010600 | stuk | 180,00 | 229 | 1 |  | Baden / douchebakken / stoomcabines |
| badgreep 30cm | | | | | | | | | |
| 0685232 | | chroom | 20007010000 | stuk | 98,50 | 229 | 1 |  | Kranen |
| closetrolhouder m. klep | | | | | | | | | |
| 0685364 | | chroom | 20060010000 | stuk | 117,00 | 229 | 1 |  | Douchegarnituur |
| reserverolhouder | | | | | | | | | |
| 0685372 | | chroom | 20063010000 | stuk | 59,00 | 229 | 1 |  | Accessoires en spiegels |
| closetborstelgarnituur compleet | | | | | | | | | |
| 0685380 | | chroom | 20064019000 | stuk | 148,00 | 229 | 1 |  | Douchewanden |
| handdoekhaak dubbel | | | | | | | | | |
| 0685283 | | chroom | 20013010000 | stuk | 50,50 | 229 | 1 |  | Toebehoren & afvoeren |
| handdoekhaak trio | | | | | | | | | |
| 0685291 | | chroom | 20015010000 | stuk | 42,75 | 229 | 1 |  | Spoel- & installatiesystemen |
| handdoekhaak dubbel | | | | | | | | | |
| 0685283 | | chroom | 20013010000 | stuk | 50,50 | 229 | 1 |  | Badkamermeubelen en toiletkasten |
| handdoekhaak trio | | | | | | | | | |
| 0685291 | | chroom | 20015010000 | stuk | 42,75 | 229 | 1 |  | Gootstenen en wastroggen |
| handdoekhaak dubbel | | | | | | | | | |
| 0685283 | | chroom | 20013010000 | stuk | 50,50 | 229 | 1 |  | Utiliteit |
| Keuco Edition 300 | | | | | | | | | |
| glashouder m. kristalglas compleet | | | | | | | | | |
| 0604161 | | chroom | 30050019000 | stuk | 99,00 | 229 | 1 |  | |
| cosmeticaspiegel op wandstang z. verlichting | | | | | | | | | |
| 0680076 | diam. 23cm | chroom | 17620010000 | stuk | 217,25 | 229 | 1 | | |
| cosmeticaspiegel op wandstang m. verlichting | | | | | | | | | |
| 0680077 | diam. 26cm | chroom | 17620019000 | stuk | 372,95 | 229 | 1 | | |
| zeephouder m. kristal inzet | | | | | | | | | |
| 0604168 | | chroom | 30055019000 | stuk | 103,00 | 229 | 1 |  | |









| | Art.nr | Specificaties | Kleur | Lev.nr | Ehd | Prijs | Grp | CC |
|---|---|--|------------------|----------------------------|--------------|------------------|-----|----|
| | Keuco Edition 300 | | | | | | | |
| Sanitair producten | | zeepdispenser kristalglas m. houder 0604167 | chroom | 30052019000 | stuk | 124,00 | 229 | 1 |
| Baden / douchebakken / stoomcabines |  | | | | | | | |
| Kranen | | handdoekhouder 0604152 60cm 0604153 80cm | chroom chroom | 30001010600 30001010800 | stuk stuk | 127,00 143,00 | 229 | 1 |
| Douchegarnituur |  | | | | | | | |
| Accessoires en spiegels | | 2-lids handdoekhouder 0604155 46.5cm | chroom | 30018010000 | stuk | 138,00 | 229 | 1 |
| Douchewanden |  | | | | | | | |
| Toebehoren & afvoeren | | handdoekring 0604156 | chroom | 30021010000 | stuk | 89,50 | 229 | 1 |
| Spoel- & installatiesystemen |  | | | | | | | |
| Badkamermeubelen en toiletkasten | | badgreep 30cm 0604157 | chroom | 30007010000 | stuk | 111,00 | 229 | 1 |
| Gootstenen en wastroggen |  | | | | | | | |
| Utiliteit | | planchetconsole per paar 0604158 | chroom | 30010010000 | stuk | 57,50 | 229 | 1 |
| |  | | | | | | | |
| | | planchet kristalglas 0604159 65x12cm 0604160 125x12cm | | 30010005600 30010001200 | stuk stuk | 85,00 163,00 | 229 | 1 |
| | | closetrolhouder m. klep 0604163 | chroom | 30060010000 | stuk | 157,00 | 229 | 1 |
| |  | | | | | | | |
| | | reserverolhouder 0604164 | chroom | 30063010000 | stuk | 57,50 | 229 | 1 |
| |  | | | | | | | |

| Art.nr | Specificaties | Kleur | Lev.nr | Ehd | Prijs | Grp | CC | | |
|--------------------------------------|--|--------|-------------|------|---------|-----|----|---|---|
| Keuco Edition 300 | | | | | | | | | |
| closetborstelgarnituur | | | | | | | | | |
| 0604165 | | chroom | 30064019000 | stuk | 173,00 | 229 | 1 |  | Sanitair producten |
| wandlamp m. opaalglas | | | | | | | | | |
| 0604170 | | chroom | 30092019000 | stuk | 236,00 | 229 | 1 |  | Baden / douchebakken / stoomcabines |
| handdoekhaak dubbel | | | | | | | | | |
| 0604154 | | chroom | 30015010000 | stuk | 37,50 | 229 | 1 |  | Kranen |
| spiegel rondom facet geslepen | | | | | | | | | |
| 0604172 | 65x65cm | | 30095002000 | stuk | 174,00 | 229 | 1 |  | Douchegarnituur |
| 0604173 | 125x65cm | | 30095002500 | stuk | 257,00 | 229 | 1 | | Toebehoren & afvoeren |
| lichtspiegel | | | | | | | | | |
| 0604174 | 65x65cm | chroom | 30096012000 | stuk | 965,00 | 229 | 1 |  | Douchewanden |
| 0680075 | 95x65cm | chroom | 30096013000 | stuk | 1063,60 | 229 | 1 | | Toebehoren & afvoeren |
| 0604175 | 125x65cm | chroom | 30096012500 | stuk | 1256,00 | 229 | 1 | | Spoel- & installatiesystemen |
| Keuco Edition 300 Onderdelen | | | | | | | | | |
| 0604162 | kristalglas voor houder | | 30050009000 | stuk | 44,25 | 229 | 1 |  | Badkamermeubelen en toiletkasten |
| 0604166 | zeepdispenser kristalglas z. houder | | 30053009000 | stuk | 51,50 | 229 | 1 | | Gootstenen en wastroggen |
| 0604169 | kristal inzet voor zeephouder | | 30055009000 | stuk | 48,00 | 229 | 1 | | Utiliteit |
| 0604171 | opaalglas voor wandlamp | | 30092009000 | stuk | 117,00 | 229 | 1 | | |
| 0680436 | borstelkop voor closetborstelgarnituur wit | | 1864004000 | stuk | 10,00 | 229 | 1 | | |
| Keuco Elegance | | | | | | | | | |
| glashouder m. glas enkel | | | | | | | | | |
| 0684155 | | chroom | 1650016000 | stuk | 72,50 | 229 | 1 |  | |
| glashouder m. glas staand | | | | | | | | | |
| 0680411 | | chroom | 1649016000 | stuk | 76,00 | 229 | 1 |  | |









| | Art.nr | Specificaties | Kleur | Lev.nr | Ehd | Prijs | Grp | CC |
|---|---|---|-------|-------------|------|--------|-----|----|
| | Keuco Elegance | | | | | | | |
| Sanitair producten | | glashouder z. glas enkel 0684157 | chrom | 1650010000 | stuk | 56,50 | 229 | 1 |
| Baden / douchebakken / stoomcabines |  | zeep houder m. kristal inzet 0684163 | chrom | 1655016000 | stuk | 90,00 | 229 | 1 |
| Kranen |  | zeep houder m. kristal inzet staand 0680412 | chrom | 1654016000 | stuk | 93,50 | 229 | 1 |
| Douchegarnituur | | inzet voor zeep houder kristalglas 0684164 | | 1655006000 | stuk | 33,75 | 229 | 1 |
| Accessoires en spiegels | | glas-/zeep houder staand z. inzet 0680032 | chrom | 1649010000 | stuk | 59,50 | 229 | 1 |
| Douchewanden |  | magneetzeep houder 0680037 | chrom | 1659010000 | stuk | 37,00 | 229 | 1 |
| Toebehoren & afvoeren |  | wandlamp m. opaalglas 0680445 | chrom | 6523019000 | stuk | 138,00 | 229 | 1 |
| Spoel- & installatiesystemen | | plafondlamp m. opaalglas z. lamp 0680385 | | 6811019000 | stuk | 310,00 | 229 | 1 |
| Badkamermeubelen en toiletkasten |  | 2-lids handdoekhouder draaibaar 0684139 | chrom | 1619010000 | stuk | 78,50 | 229 | 1 |
| Gootstenen en wastroggen | | 2-lids handdoekhouder 35cm 0683908 | chrom | 1620010000 | stuk | 80,50 | 229 | 1 |
| Utiliteit |  | handdoekring 0684147 | chrom | 1621010000 | stuk | 58,50 | 229 | 1 |
| |  | handdoekhouder 60cm 0684104 | chrom | 1601010600 | stuk | 97,00 | 229 | 1 |
| |  | badlakenrek 65cm 0685887 | chrom | 04975010000 | stuk | 220,00 | 229 | 1 |





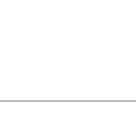



| Art.nr | Specificaties | Kleur | Lev.nr | Ehd | Prijs | Grp | CC | | |
|--|---------------|--------|-------------|------|--------|-----|----|---|---|
| | | | | | | | | Keuco Elegance | |
| badgreep 30cm 0684112 | | chroom | 1607010000 | stuk | 69,00 | 229 | 1 |  | Sanitair producten |
| closetrolhouder z. klep 0684198 | | chroom | 1662010000 | stuk | 65,50 | 229 | 1 |  | Baden / douchebakken / stoomcabines |
| closetrolhouder m. klep 0680008 | | chroom | 1660010000 | stuk | 64,50 | 229 | 1 |  | Kranen |
| reserverolhouder 0684201 | | chroom | 1663010000 | stuk | 53,00 | 229 | 1 |  | Douchegarnituur |
| closetborstelgarnituur m. deksel 0686271 | | chroom | 01664010100 | stuk | 92,00 | 229 | 1 |  | Accessoires en spiegels |
| closetborstelgarnituur m. kristal glas 0684228 | | chroom | 1669019000 | stuk | 141,00 | 229 | 1 |  | Douchewanden |
| handdoekhaak klein 0684120 | | chroom | 1614010000 | stuk | 8,40 | 229 | 1 |  | Toebehoren & afvoeren |
| handdoekhaak groot 0684122 | | chroom | 1615010000 | stuk | 14,75 | 229 | 1 |  | Spoel- & installatiesystemen |
| badjashaak 0684140 | | chroom | 1616010000 | stuk | 30,75 | 229 | 1 |  | Badkamermeubelen en toiletkasten |
| glasplaat cristallin 0684121 45x12cm | | | 1610005400 | stuk | 71,50 | 229 | 1 |  | Gootstenen en wastroggen |
| glasplaat cristallin voor spiegel 65cm 0684119 | | | 7727005600 | stuk | 72,50 | 229 | 1 | | Utiliteit |









| | Art.nr | Specificaties | Kleur | Lev.nr | Ehd | Prijs | Grp | CC | |
|---|---|---|--------------------------------|-------------------------|------------|--------|--------|-----|---|
| Sanitair producten | Keuco Elegance | | | | | | | | |
| | planchetconsoles per paar voor spiegel | | | | | | | | |
| | 0684110 | | chroom | 7727010000 | stuk | 31,25 | 229 | 1 | |
| Baden / douchebakken / stoomcabines |  | spiegel m. verlichting m. chroom sierlijst | | | | | | | |
| | | 0680312 | 45x92.4cm | | 7827012000 | stuk | 573,00 | 229 | 1 |
| | 0684123 | 65x95cm | | 7827012500 | stuk | 612,00 | 229 | 1 | |
| Douchegarnituur | Keuco Futura | | | | | | | | |
| | wandlamp m. opaalglas mat | | | | | | | | |
| | 0680923 | | | 6560019000 | stuk | 130,00 | 229 | 1 | |
| Douchewanden | Keuco Joly | | | | | | | | |
| | drinkglas bleikristal | | | | | | | | |
| | 0683835 | | | 1850009000 | stuk | 27,25 | 229 | 1 | |
| Toebehoren & afvoeren |  | decorset m. afdekkap | | | | | | | |
| | | 0684279 | | chroom | 1902010000 | stuk | 18,25 | 229 | 1 |
| Spoel- & installatiesystemen |  | toiletset | | | | | | | |
| | | 0684252 | rechts z. decorset | chroom | 1881010100 | stuk | 463,00 | 229 | 1 |
| | 0684260 | links z. decorset | chroom | 1881010200 | stuk | 463,00 | 229 | 1 | |
| Badkamermeubelen en toiletkasten |  | wastafelset | | | | | | | |
| | | 0684236 | rechts z. decorset | chroom | 1880010101 | stuk | 224,00 | 229 | 1 |
| | 0684244 | links z. decorset | chroom | 1880010201 | stuk | 224,00 | 229 | 1 | |
| Gootstenen en wastroggen |  | wastafelset | | | | | | | |
| | | 0684236 | rechts z. decorset | chroom | 1880010101 | stuk | 224,00 | 229 | 1 |
| | 0684244 | links z. decorset | chroom | 1880010201 | stuk | 224,00 | 229 | 1 | |
| Utiliteit |  | planchetconsoles per paar | | | | | | | |
| | | 0684246 | | chroom | 1884010000 | stuk | 117,00 | 229 | 1 |
| | glasplaat kristalglas | | | | | | | | |
| | 0684245 | | | 1884009000 | stuk | 132,00 | 229 | 1 | |
| |  | spiegel rondom facet geslepen m. verlichting | | | | | | | |
| | | 0680048 | 40x72cm z. decor element | chroom | 7816012000 | stuk | 456,00 | 229 | 1 |
| | | 0680035 | 40x77cm ovaal z. decor element | chroom | 7817012000 | stuk | 504,00 | 229 | 1 |
| | | 0680059 | 37x72cm gebogen | z. decor element chroom | 7818012000 | stuk | 464,30 | 229 | 1 |
| |  | | | | | | | | |











| Art.nr | Specificaties | Kleur | Lev.nr | Ehd | Prijs | Grp | CC | | |
|-----------------------------------|---------------|--------------|-------------|------|--------|-----|----|---|---|
| | | | | | | | | Keuco Joly | |
| decor element voor spiegel | | | | | | | | | |
| 0680046 | | chroom/blauw | 7816019001 | stuk | 156,00 | 229 | 1 |  | Sanitair producten |
| decorset wastafel-/wc-set | | | | | | | | | |
| 0680047 | | chroom/blauw | 1907010001 | stuk | 15,50 | 229 | 1 |  | Baden / douchebakken / stoomcabines |
| | | | | | | | | Keuco Plan | |
| glashouder m. glas | | | | | | | | | |
| 0684724 | | chroom | 14950019000 | stuk | 90,00 | 229 | 1 |  | Accessoires en spiegels |
| 0684732 | | geëloxeerd | 14950179000 | stuk | 73,50 | 229 | 1 | | |
| zeephouder m. inzet | | | | | | | | | |
| 0684740 | | chroom | 14955019000 | stuk | 88,00 | 229 | 1 |  | Douchewanden |
| 0684759 | | geëloxeerd | 14955179000 | stuk | 71,00 | 229 | 1 | | |
| zeepdispenser | | | | | | | | | |
| 0685119 | | chroom | 14954010100 | stuk | 154,00 | 229 | 1 |  | Toebehoren & afvoeren |
| 0685127 | | geëloxeerd | 14954170100 | stuk | 110,00 | 229 | 1 | | |
| zeepdispenser m. sensor | | | | | | | | | |
| 0685135 | | chroom | 14956010100 | stuk | 299,00 | 229 | 1 |  | Badkamermeubelen en toiletkasten |
| 0685143 | | geëloxeerd | 14956170100 | stuk | 253,00 | 229 | 1 | | |
| zeepdispenser staand | | | | | | | | | |
| 0684767 | | chroom | 14952010100 | stuk | 128,00 | 229 | 1 |  | Gootstenen en wastroggen |
| 0684775 | | geëloxeerd | 14952170100 | stuk | 117,00 | 229 | 1 | | |
| zeepdispenser wandmodel | | | | | | | | | |
| 0684783 | | chroom | 14953010100 | stuk | 147,00 | 229 | 1 |  | Utiliteit |
| 0684791 | | geëloxeerd | 14953170100 | stuk | 136,00 | 229 | 1 | | |
| zeepdispenser inbouw | | | | | | | | | |
| 0685178 | | geëloxeerd | 14949170200 | stuk | 98,50 | 229 | 1 |  | |









| | Art.nr | Specificaties | Kleur | Lev.nr | Ehd | Prijs | Grp | CC |
|---|--|---------------|------------|-------------|------|--------|-----|----|
| | Keuco Plan | | | | | | | |
| Sanitair producten | console voor planchet | | | | | | | |
| | 0685070 | | chroom | 14910010000 | stuk | 49,25 | 229 | 1 |
| | 0685089 | | geëloxeerd | 14910170000 | stuk | 40,75 | 229 | 1 |
| Baden / douchebakken / stoomcabines | planchet kristalglas | | | | | | | |
| | 0685097 | 550x120mm | | 14910005500 | stuk | 67,00 | 229 | 1 |
| | 0685186 | 210x115mm | | 14958009000 | stuk | 72,00 | 229 | 1 |
| Kranen | wandlamp | | | | | | | |
| | 0685194 | | chroom | 6549019000 | stuk | 219,00 | 229 | 1 |
| | 0685208 | | geëloxeerd | 6549179000 | stuk | 208,00 | 229 | 1 |
| Douchegarnituur | | | | | | | | |
| Accessoires en spiegels | 2-lids handdoekhouder draaibaar | | | | | | | |
| | 0684708 | | chroom | 14918010000 | stuk | 121,00 | 229 | 0 |
| | 0684716 | | geëloxeerd | 14918170000 | stuk | 101,00 | 229 | 1 |
| Douchewanden | handgreep 30cm | | | | | | | |
| | 0684619 | | chroom | 14907010000 | stuk | 81,00 | 229 | 1 |
| | 0684627 | | geëloxeerd | 14907170000 | stuk | 72,00 | 229 | 1 |
| Toebehoren & afvoeren | handdoekring | | | | | | | |
| | 0685100 | | chroom | 14921010000 | stuk | 134,00 | 229 | 1 |
| | 0685275 | | geëloxeerd | 14921170000 | stuk | 112,00 | 229 | 1 |
| Spoel- & installatiesystemen | | | | | | | | |
| Badkamermeubelen en toiletkasten | handdoekhouder 60cm | | | | | | | |
| | 0684570 | | chroom | 14901010600 | stuk | 106,00 | 229 | 1 |
| | 0684589 | | geëloxeerd | 14901170600 | stuk | 89,00 | 229 | 1 |
| Gootstenen en wastroggen | closetrolhouder dubbel m. diefstalbeveiliging | | | | | | | |
| | 0686328 | | chroom | 14961010000 | stuk | 107,00 | 229 | 1 |
| | 0686336 | | geëloxeerd | 14961170000 | stuk | 90,00 | 229 | 1 |
| Utiliteit | closetrolhouder z. klep | | | | | | | |
| | 0684821 | | chroom | 14962010000 | stuk | 59,50 | 229 | 0 |
| | 0684848 | | geëloxeerd | 14962170000 | stuk | 50,00 | 229 | 1 |
| | handdoekhouder 80cm | | | | | | | |
| | 0684597 | | chroom | 14901010800 | stuk | 119,00 | 229 | 1 |
| | 0684600 | | geëloxeerd | 14901170800 | stuk | 92,00 | 229 | 1 |
| | reserverolhouder | | | | | | | |
| | 0684856 | | chroom | 14963010000 | stuk | 26,00 | 229 | 0 |
| | 0684864 | | geëloxeerd | 14963170000 | stuk | 18,50 | 229 | 1 |
| | closetborstelgarnituur | | | | | | | |
| | 0684872 | | chroom | 14964010100 | stuk | 175,00 | 229 | 0 |
| | 0684880 | | geëloxeerd | 14964170100 | stuk | 57,50 | 229 | 1 |

| Art.nr | Specificaties | Kleur | Lev.nr | Ehd | Prijs | Grp | CC | | |
|--|---|-------------|-------------|------|---------|-----|----|---|---|
| | | | | | | | | Keuco Plan | |
| handdoekhaak klein | | | | | | | | | |
| 0684694 | | geëloxeerd | 14915170000 | stuk | 15,00 | 229 | 1 |  | Sanitair producten |
| handdoekhaak m. deurbuffer | | | | | | | | | |
| 0684635 | | chrom | 14911010000 | stuk | 25,50 | 229 | 1 |  | Baden / douchebakken / stoomcabines |
| 0684643 | | geëloxeerd | 14911170000 | stuk | 18,50 | 229 | 1 | | Kranen |
| handdoekhaak | | | | | | | | | |
| 0684651 | | chrom | 14914010000 | stuk | 23,25 | 229 | 0 |  | Douchegarnituur |
| 0684678 | | geëloxeerd | 14914170000 | stuk | 17,75 | 229 | 1 | | Accessoires en spiegels |
| asbak wandmodel | | | | | | | | | |
| 0684805 | | chrom | 14965010065 | stuk | 59,50 | 229 | 1 |  | Douchewanden |
| 0684813 | | geëloxeerd | 14965170065 | stuk | 26,25 | 229 | 1 | | Toebehoren & afvoeren |
| spiegel m. TL verlichting | | | | | | | | | |
| 0680071 | 40x80cm | chrom | 14996012000 | stuk | 775,00 | 229 | 1 |  | Toebehoren & afvoeren |
| 0680072 | 65x80cm | chrom | 14996012500 | stuk | 907,50 | 229 | 1 | | |
| 0680074 | 95x80cm | chrom | 14996013000 | stuk | 1119,50 | 229 | 1 | | |
| | | | | | | | | Keuco Smart | |
| glas-/zeep-/dispenserhouder enkel z. inzet | | | | | | | | | |
| 0604129 | | chrom | 2350010000 | stuk | 18,00 | 229 | 1 |  | Spoel- & installatiesystemen |
| 0604130 | drinkglas voor houder | kristalglas | 02350009000 | stuk | 13,75 | 229 | 1 | | |
| 0604134 | zeepschaal voor houder | kristalglas | 02355009000 | stuk | 18,50 | 229 | 1 | | |
| 0604137 | lotiondispenser kunststof m. pomp voor houder | chrom | 2353010100 | stuk | 26,25 | 229 | 1 | | |
| 0604138 | lotiondispenser kristalglas m. pomp voor houder | chrom | 02753019000 | stuk | 59,00 | 229 | 1 | | |
| glashouder m. kristalglas compleet | | | | | | | | | |
| 0604128 | | chrom | 2350019000 | stuk | 31,50 | 229 | 1 |  | Badkamermeubelen en toiletkasten |
| zeephouder m. kristalschaal | | | | | | | | | |
| 0604132 | | chrom | 2355019000 | stuk | 36,25 | 229 | 1 | Gootstenen en wastroggen | |
| lotiondispenser kristalglas m. pomp voor houder | | | | | | | | | |
| 0604138 | | chrom | 02753019000 | stuk | 59,00 | 229 | 1 |  | Utiliteit |
| lotiondispenser kunststof m. pomp voor houder | | | | | | | | | |
| 0604137 | | chrom | 2353010100 | stuk | 26,25 | 229 | 1 |  | |
| handgreep 25cm | | | | | | | | | |
| 0604120 | | chrom | 2307010000 | stuk | 35,75 | 229 | 1 | | |

| | Art.nr | Specificaties | Kleur | Lev.nr | Ehd | Prijs | Grp | CC |
|---|---|---------------------|--------|------------|------|-------|-----|----|
| | Keuco Smart | | | | | | | |
| | handgreep | | | | | | | |
| Sanitair producten | 0604121 | m. zeeprekje rechts | chroom | 2309010100 | stuk | 84,00 | 229 | 1 |
| | 0604122 | m. zeeprekje links | chroom | 2309010200 | stuk | 84,00 | 229 | 1 |
| Baden / douchebakken / stoomcabines |  | | | | | | | |
| Kranen |  | | | | | | | |
| Douchegarnituur | handdoekhaak 0604123 | | chroom | 2314010000 | stuk | 4,75 | 229 | 1 |
| Accessoires en spiegels |  | | | | | | | |
| Douchewanden | handdoekhaak dubbel 0604124 | | chroom | 2315010000 | stuk | 14,25 | 229 | 1 |
| Toebehoren & afvoeren |  | | | | | | | |
| Spoel- & installatiesystemen | 2-lids handdoekhouder 0604125 | | chroom | 2318010000 | stuk | 32,75 | 229 | 1 |
| Badkamermeubelen en toiletkasten |  | | | | | | | |
| | handdoekhouder 0604115 40cm | | chroom | 2301010400 | stuk | 31,00 | 229 | 1 |
| | 0604116 60cm | | chroom | 2301010600 | stuk | 36,25 | 229 | 1 |
| Gootstenen en wastroggen | 0604117 80cm | | chroom | 2301010800 | stuk | 42,00 | 229 | 1 |
| |  | | | | | | | |
| Utiliteit | handdoekhouder dubbel 0604118 60cm | | chroom | 2303010600 | stuk | 62,50 | 229 | 1 |
| |  | | | | | | | |
| | handdoekring 0604126 | | chroom | 2321010000 | stuk | 30,50 | 229 | 1 |
| |  | | | | | | | |
| | closetrolhouder m. klep 0604142 | | chroom | 2360010000 | stuk | 30,00 | 229 | 1 |
| |  | | | | | | | |

| Art.nr | Specificaties | Kleur | Lev.nr | Ehd | Prijs | Grp | CC | | |
|-------------------------------|---|-------|-------------|------|-------|-----|----|---|---|
| Keuco Smart | | | | | | | | | |
| 0604144 | closetrolhouder z. klep | chrom | 2362010000 | stuk | 21,00 | 229 | 1 |  | Sanitair producten |
| 0604145 | reserverolhouder | chrom | 2363010000 | stuk | 14,25 | 229 | 1 |  | Baden / douchebakken / stoomcabines |
| 0604146 | closetborstelgarnituur | chrom | 2364010100 | stuk | 32,25 | 229 | 1 |  | Kranen |
| Keuco Smart Onderdelen | | | | | | | | | |
| 0604130 | drinkglas voor houder kristalglas | | 02350009000 | stuk | 13,75 | 229 | 1 | | Douchegarnituur |
| 0604134 | zeepschaal voor houder kristalglas | | 02355009000 | stuk | 18,50 | 229 | 1 | | |
| 0604140 | lotiondispenser kristalglas z. houder z. pomp | | 2753009000 | stuk | 43,25 | 229 | 1 | | |
| 0680438 | lampglas opaal | | 6523009000 | stuk | 76,50 | 229 | 1 | | |
| 0680435 | inzet voor closetborstelgarnituur wit | | 14972000100 | stuk | 11,75 | 229 | 1 | | |
| 0604139 | lotiondispenser kunststof z. houder z. pomp | | 4053000100 | stuk | 10,50 | 229 | 1 | | |
| 0604141 | pomp voor lotiondispenser | | 2353010000 | stuk | 15,75 | 229 | 1 | | |
| Keuco Solo | | | | | | | | | |
| 0685984 | glashouder enkel m. glas | chrom | 01550016000 | stuk | 57,50 | 229 | 1 |  | Accessoires en spiegels |
| 0683477 | glashouder enkel z. glas | chrom | 1550010000 | stuk | 44,75 | 229 | 0 | | Douchewanden |
| 0683507 | glashouder dubbel z. glas | chrom | 1551010000 | stuk | 70,50 | 229 | 1 |  | Toebehoren & afvoeren |
| 0683566 | zeepouder m. acryl inzet | chrom | 1556010100 | stuk | 49,25 | 229 | 1 |  | Spoel- & installatiesystemen |
| 0683515 | zeepouder draadmodel | chrom | 24901010000 | stuk | 17,25 | 229 | 1 |  | Badkamermeubelen en toiletkasten |
| 0683531 | zeepouder hoekdraadmodel | chrom | 24903010000 | stuk | 19,25 | 229 | 1 |  | Gootstenen en wastroggen |
| | | | | | | | | | Utiliteit |

| | Art.nr | Specificaties | Kleur | Lev.nr | Ehd | Prijs | Grp | CC |
|---|---|--|-------|-------------|------|--------|-----|----|
| Sanitair producten | Keuco Solo | | | | | | | |
| |  | glasplaat kristalglas 0683418 45cm | | 1510009400 | stuk | 57,50 | 229 | 1 |
| | | 0683426 65cm | | 1510009600 | stuk | 65,00 | 229 | 1 |
| Baden / douchebakken / stoomcabines | planchetconsoles per paar 0683396 | | | | | | | |
| | | | chrom | 1510010000 | paar | 58,50 | 229 | 1 |
| Kranen |  | kristal spiegel m. facetrand 0683698 45x80cm | | 7790002000 | stuk | 178,00 | 229 | 1 |
| | | 0683701 65x90cm | | 7790002500 | stuk | 198,00 | 229 | 1 |
| Douchegarnituur |  | wandlamp verstelbaar m. opaalglas halogeen 0683663 | chrom | 6508019000 | stuk | 191,00 | 229 | 1 |
| Accessoires en spiegels | | | | | | | | |
| Douchewanden |  | 2-lids handdoekhouder draaibaar 0683450 | chrom | 1518010000 | stuk | 69,00 | 229 | 0 |
| Toebehoren & afvoeren |  | handdoekring 0683469 | chrom | 1521010000 | stuk | 50,50 | 229 | 1 |
| Spoel- & installatiesystemen | | | | | | | | |
| Badkamermeubelen en toiletkasten |  | handdoekhouder 0683353 60cm | chrom | 1501010600 | stuk | 74,00 | 229 | 1 |
| | | 0683361 80cm | chrom | 1501010800 | stuk | 86,00 | 229 | 1 |
| Gootstenen en wastroggen |  | badgreep 30cm 0683388 | chrom | 1507010000 | stuk | 56,00 | 229 | 1 |
| |  | sponshouder draadmodel 0683523 | chrom | 24902010000 | stuk | 19,75 | 229 | 1 |
| Utiliteit |  | sponshouder hoekdraadmodel 0683558 | chrom | 24904010000 | stuk | 22,75 | 229 | 1 |
| | | sponshouder hoekdraadmodel 186mm 0683508 | chrom | 24944010000 | stuk | 48,00 | 229 | 1 |
| |  | closetrolhouder m. klep 0683582 | chrom | 1560010000 | stuk | 58,50 | 229 | 0 |

| Art.nr | Specificaties | Kleur | Lev.nr | Ehd | Prijs | Grp | CC | | |
|--|---------------|-------|-------------|------|--------|-----|----|---|---|
| Keuco Solo | | | | | | | | | |
| reserverolhouder 0683590 | | chrom | 1563010000 | stuk | 41,50 | 229 | 0 |  | Sanitair producten |
| closetborstelgarnituur m. opak kunststof inzet 0683604 | | chrom | 1564010100 | stuk | 88,00 | 229 | 0 |  | Baden / douchebakken / stoomcabines |
| handdoekhaak groot 0683442 | | chrom | 1514010000 | stuk | 14,00 | 229 | 0 |  | Kranen |
| | | | | | | | | | Douchegarnituur |
| Keuco Trias | | | | | | | | | |
| glashouder m. glas 0685704 | | chrom | 04550019000 | stuk | 84,50 | 229 | 1 |  | Accessoires en spiegels |
| zeepouder m. inzet 0685720 | | chrom | 04555019000 | stuk | 72,50 | 229 | 1 |  | Douchewanden |
| zeepouder draadmodel 0685739 | | chrom | 04558010000 | stuk | 118,00 | 229 | 1 |  | Toebehoren & afvoeren |
| zeepdispenser compleet 0685712 | | chrom | 04552019000 | stuk | 140,00 | 229 | 1 |  | Spoel- & installatiesystemen |
| glasplaat cristallin 0685666 56x14cm | | chrom | 03711005500 | stuk | 115,00 | 229 | 1 |  | Badkamermeubelen en toiletkasten |
| planchetconsole per stuk 0685660 | | chrom | 4510010000 | stuk | 54,00 | 229 | 1 | | Gootstenen en wastroggen |
| handdoekhouder 60cm 0685631 | | chrom | 04501010600 | stuk | 115,00 | 229 | 1 |  | Utiliteit |
| badgreep 30cm 0685658 | | chrom | 04507010000 | stuk | 81,50 | 229 | 1 | | |

| | Art.nr | Specificaties | Kleur | Lev.nr | Ehd | Prijs | Grp | CC |
|---|--------------------|--|------------|-------------|------|--------|-----|----|
| Sanitair producten | Keuco Trias | | | | | | | |
| | | handdoekhaak 0685674 | chroom | 04514010000 | stuk | 13,25 | 229 | 1 |
| Baden / douchebakken / stoomcabines | | 2-lids handdoekhouder 0685682 | chroom | 04518010000 | stuk | 99,00 | 229 | 1 |
| Kranen | | handdoekring 0685690 | chroom | 04521010000 | stuk | 75,50 | 229 | 1 |
| Douchegarnituur | | closetrolhouder m. klep 0685747 | chroom | 04560010000 | stuk | 99,00 | 229 | 1 |
| Accessoires en spiegels | | reserverolhouder 0685755 | chroom | 04563010000 | stuk | 62,50 | 229 | 1 |
| Douchewanden | | closetborstelgarnituur 0685763 | chroom | 04564019000 | stuk | 136,00 | 229 | 1 |
| Toebehoren & afvoeren | | decoratieschijf 0685771 59mm | mat chroom | 04591080000 | stuk | 17,50 | 229 | 1 |
| Spoel- & installatiesystemen | | 0685798 78mm | mat chroom | 04592080000 | stuk | 17,50 | 229 | 1 |
| Badkamermeubelen en toiletkasten | | wandlamp draaibaar m. opaalglas 0685801 | chroom | 06545019000 | stuk | 182,00 | 229 | 1 |
| Gootstenen en wastroggen | | spiegellamp draaibaar m. opaalglas 0685828 | chroom | 06546019000 | stuk | 239,00 | 229 | 1 |
| Utiliteit | | | | | | | | |

| Art.nr | Specificaties | Kleur | Lev.nr | Ehd | Prijs | Grp | CC | |
|--|---------------|--------|-------------|------|--------|-----|----|---|
| Keuco Trias | | | | | | | | |
| spiegel 49x70cm m. facetrand 0685836 | | | 07707002000 | stuk | 190,00 | 229 | 1 | |
| Keuco Visit | | | | | | | | |
| handdoekhouder draaibaar 0685429 | | chroom | 18020170000 | stuk | 101,00 | 229 | 1 |  |
| handdoekring 0685437 | | chroom | 18021170000 | stuk | 137,00 | 229 | 1 |  |
| closetrolhouder 0685496 | | chroom | 18060170000 | stuk | 108,00 | 229 | 1 |  |
| reserverolhouder 0685518 | | chroom | 18063170000 | stuk | 80,50 | 229 | 1 |  |
| closetborstelgarnituur 0685526 | | chroom | 18069170100 | stuk | 136,00 | 229 | 1 |  |
| handdoekhaak 0685410 | | chroom | 18015170000 | stuk | 79,00 | 229 | 1 |  |
| wastafelarmatuur 32x16x4.1cm m. zeepdispenser 0685593 | | chroom | 58070170100 | stuk | 630,00 | 229 | 1 |  |
| 2-greeps wastafelarmatuur 32x16x4.1cm m. zeepdispenser 0685607 | | chroom | 58071170100 | stuk | 668,00 | 229 | 1 |  |
| spiegel m. TL verlichting 0685615 32x96cm m. schuifladen | | | 18096002000 | stuk | 721,00 | 229 | 1 |  |
| 0680070 32x96cm z. schuifladen | | | 18096002001 | stuk | 720,05 | 229 | 1 | |

Sanitair producten

Baden /
douchebakken /
stoomcabines

Kranen

Douchegarnituur

Accessoires en
spiegels

Douchewanden









Toebehoren &
afvoeren







Spoel- &
installatiesystemen

Badkamermeubelen
en toiletkasten

Gootstenen en
wastroggen

Utiliteit

| | Art.nr | Specificaties | Kleur | Lev.nr | Ehd | Prijs | Grp | CC | |
|---|---|---------------|-------------|-------------|-------------|--------|-------|-----|---|
| Sanitair producten | Keuco Visit | | | | | | | | |
| | toiletcombinatie 13,7x67,7x14cm compleet | | | | | | | | |
| | 0685445 | | zilver/glas | 18064173000 | stuk | 678,00 | 229 | 1 | |
| | 0685461 | | wit/wit | 18064510200 | stuk | 710,00 | 229 | 1 | |
| Baden / douchebakken / stoomcabines |  | | | | | | | | |
| Kranen | Keuco douchegordijn - stangen | | | | | | | | |
| | douchegordijnstang recht | | | | | | | | |
| | 0680391 | 500mm | chroom | 14930010500 | stuk | 19,75 | 229 | 1 | |
| | 0680397 | 700mm | chroom | 14930010700 | stuk | 27,25 | 229 | 1 | |
| | 0680399 | 800mm | chroom | 14930010800 | stuk | 30,75 | 229 | 1 | |
| Douchegarnituur |  | 0680040 | 900mm | chroom | 14930010900 | stuk | 34,25 | 229 | 1 |
| Accessoires en spiegels | wand- plafondbevestiging m. stop | | | | | | | | |
| | 0680398 | | chroom | 14935010000 | stuk | 18,50 | 229 | 1 | |
|  | | | | | | | | | |
| Douchewanden | gordijnring (set v. 10stuks) | | | | | | | | |
| 0680041 | | wit | 14927000103 | stuk | 15,25 | 229 | 1 | | |
|  | | | | | | | | | |
| Toebehoren & afvoeren | bocht 90° v. douchegordijnstang | | | | | | | | |
| 0680395 | | chroom | 14924010000 | stuk | 20,50 | 229 | 1 | | |
|  | | | | | | | | | |
| Spoel- & installatiesystemen | verbindingsstuk v. bocht 90° en plafondsteun | | | | | | | | |
| 0680396 | | chroom | 14931010000 | stuk | 5,80 | 229 | 1 | | |
|  | | | | | | | | | |
| Badkamermeubelen en toiletkasten | verbindingsbuis v. plafondsteun / verlengbuis v. douchegordijnstang | | | | | | | | |
| 0680393 | 202mm | chroom | 14932010000 | stuk | 12,00 | 229 | 1 | | |
|  | | | | | | | | | |
| Gootstenen en wastroggen | Keuco spiegels | | | | | | | | |
| spiegel m. facetrans rond 40cm | | | | | | | | | |
| 0680296 | | | 7737001500 | stuk | 106,00 | 229 | 1 | | |
|  | | | | | | | | | |
| kristalspiegel m. facetrans | | | | | | | | | |
| 0681334 | 37x80cm | | 7766002000 | stuk | 184,00 | 229 | 1 | | |
| 0681342 | 60x80cm | | 7766002500 | stuk | 228,00 | 229 | 1 | | |
| 0680958 | 45x60cm | | 7741002000 | stuk | 178,00 | 229 | 1 | | |
| 0680966 | 60x80cm | | 7741002500 | stuk | 237,00 | 229 | 1 | | |
|  | | | | | | | | | |

| Art.nr | Specificaties | Kleur | Lev.nr | Ehd | Prijs | Grp | CC | |
|---|---------------------|--------|-------------|------|--------|-----|----|---|
| Keuco spiegels | | | | | | | | |
| spiegel m. halogeen verlichting | | | | | | | | |
| 0680061 | 60x70cm m. lamp 50 | zilver | 7850012000 | stuk | 576,30 | 229 | 1 | |
| 0680062 | 80x70cm m. lamp 50 | zilver | 7850013000 | stuk | 616,05 | 229 | 1 | |
| 0680063 | 100x70cm m. lamp 50 | zilver | 7850014000 | stuk | 780,40 | 229 | 1 | |
| 0680064 | 130x70cm m. lamp 50 | zilver | 7850015000 | stuk | 881,05 | 229 | 1 | |
| 0680065 | 60x70cm m. lamp 56 | zilver | 7856012001 | stuk | 496,90 | 229 | 1 | |
| 0680066 | 80x70cm m. lamp 56 | zilver | 7856013001 | stuk | 523,30 | 229 | 1 | |
| 0680067 | 100x70cm m. lamp 56 | zilver | 7856014001 | stuk | 655,80 | 229 | 1 | |
| 0680068 | 130x70cm m. lamp 56 | zilver | 7856015001 | stuk | 775,00 | 229 | 1 | |
| Keuco lampen | | | | | | | | |
| Reflex wandlamp halogeen m. opaalglas | | | | | | | | |
| 0683664 | | chrom | 6510019000 | stuk | 192,00 | 229 | 1 |  |
| Reflex opaalglas voor wandlamp | | | | | | | | |
| 0686699 | | | 6510019100 | stuk | 70,50 | 229 | 1 | |
| Reflex halogeenlamp los 60W | | | | | | | | |
| 0680051 | | | 6508000100 | stuk | 28,50 | 229 | 1 | |
| Reflex-2 spiegellamp halogeen m. opaalglas | | | | | | | | |
| 0681221 | | chrom | 6513019000 | stuk | 216,00 | 229 | 1 |  |
| plafondlamp m. opaalglas mat | | | | | | | | |
| 0680931 | | | 6893019000 | stuk | 228,00 | 229 | 1 |  |
| Keuco Universeel | | | | | | | | |
| handgreep m. zeepschaal | | | | | | | | |
| 0680058 | | chrom | 4909010000 | stuk | 118,00 | 229 | 1 |  |
| handdoekrek uittrekbaar 37-57cm | | | | | | | | |
| 0683007 | | chrom | 4919010000 | stuk | 161,00 | 229 | 1 |  |
| zeepdispenser inbouw | | | | | | | | |
| 0685151 | | chrom | 14949010200 | stuk | 117,00 | 229 | 1 |  |
| reserverolhouder | | | | | | | | |
| 0683592 | | chrom | 4963010000 | stuk | 47,25 | 229 | 1 |  |

Sanitair producten

Baden /
douchebakken /
stoomcabines

Kranen

Douchegarnituur

Accessoires en
spiegels

Douchewanden



Toebehoren &
afvoeren









Spoel- &
installatiesystemen

Badkamermeubelen
en toiletkasten

Gootstenen en
wastroggen

Utiliteit

| | Art.nr | Specificaties | Kleur | Lev.nr | Ehd | Prijs | Grp | CC |
|---|---|--|------------------|------------|------------|-------|--------|-------|
| Sanitair producten | Keuco Universeel | | | | | | | |
| |  | tissuebox 0681256 | | chroom | 4967010000 | stuk | 170,00 | 229 1 |
| Baden / douchebakken / stoomcabines |  | gastendoekkorf 0681253 | voor alle series | chroom | 4972010000 | stuk | 148,00 | 229 1 |
| Kranen | | | | | | | | |
| Douchegarnituur |  | kleenexbox zijkant gesloten 0686666 | | chroom | 4977010000 | stuk | 59,50 | 229 1 |
| Accessoires en spiegels |  | handdoekplateau-61 3-delig 0684116 | | chroom | 4983010000 | stuk | 103,00 | 229 1 |
| Douchewanden |  | afvalemmer 0685115 | | RVS | 4988070000 | stuk | 69,00 | 229 1 |
| Toebehoren & afvoeren | | | | | | | | |
| Spoel- & installatiesystemen |  | closetborstelgarnituur compleet 0683011 | | chroom | 3864010100 | stuk | 143,00 | 229 1 |
| Badkamermeubelen en toiletkasten | | | | | | | | |
| Gootstenen en wastroggen | | glas voor closetborstelgarnituur kristal 0680894 | | | 464009000 | stuk | 39,00 | 229 1 |
| Utiliteit |  | klapzitje compleet 0680415 | | chroom/wit | 4980010003 | stuk | 321,00 | 229 1 |
| |  | zeephouder hoekdraadmodel 0680869 | | chroom | 1657010000 | stuk | 92,50 | 229 1 |
| |  | sponshouder draadmodel 0680877 | | chroom | 1658010000 | stuk | 98,00 | 229 1 |

| Art.nr | Specificaties | Kleur | Lev.nr | Ehd | Prijs | Grp | CC | | |
|---|---------------|----------------------------|------------------------|--------------|------------------|------------|--------|---|--|
| | | | | | | | | Kludi Joop! | |
| glashouder 0412503 | | chroom | 5597505H7 | stuk | 193,00 | 183 | 1 |  | Sanitair producten |
| zeepschaal glas 0412619 | | chroom | 5598505H7 | stuk | 98,00 | 183 | 1 |  | Baden / douchebakken / stoomcabines |
| zeepdispenser 0412511 | | chroom | 5597605H7 | stuk | 237,00 | 183 | 1 |  | Kranen Douchegarnituur |
| planchet 0412597 260x140mm 0412473 320x210mm | | chroom/glas chroom/glas | 5598305H7 5597305H7 | stuk stuk | 88,50 116,00 | 183 183 | 1 1 |  | Accessoires en spiegels |
| handdoekhouder 0412538 | | chroom | 5597705 | stuk | 158,00 | 183 | 1 |  | Douchewanden Toebehoren & afvoeren |
| handdoekring 0412546 | | chroom | 5597805 | stuk | 172,00 | 183 | 1 |  | Spoel- & installatiesystemen |
| handdoekhouder 0412562 60cm 0412554 80cm | | chroom chroom | 5598005 5597905 | stuk stuk | 224,00 268,00 | 183 183 | 1 1 |  | Badkamermeubelen en toiletkasten |
| badgreep 30cm 0412570 | | chroom | 5598105 | stuk | 170,00 | 183 | 1 |  | Gootstenen en wastroggen |
| closetrolhouder 0412457 | | chroom | 5597105 | stuk | 176,00 | 183 | 1 |  | Utiliteit |
| reserverolhouder 0412465 | | chroom | 5597205 | stuk | 108,00 | 183 | 1 |  | |
| closetborstelgarnituur 0412481 | | chroom | 5597405H7 | stuk | 265,00 | 183 | 1 |  | |

| Art.nr | Specificaties | Kleur | Lev.nr | Ehd | Prijs | Grp | CC |
|--------|---------------|-------|--------|-----|-------|-----|----|
|--------|---------------|-------|--------|-----|-------|-----|----|

Kludi Joop!

mantelhaak groot

0412589

chrom

5598205

stuk

71,50

183

1



Sanitair producten

Baden /
douchebakken /
stoomcabines

haakje klein

0412600

chrom

5598405

stuk

61,50

183

1



Kranen

Douchegarnituur

Accessoires en
spiegels

Douchewanden

Toebehoren &
afvoeren

Spoel- &
installatiesystemen

Badkamermeubelen
en toiletkasten

Gootstenen en
wastroggen

Utiliteit

| Art.nr | Specificaties | Kleur | Lev.nr | Ehd | Prijs | Grp | CC | |
|---|---------------|-------|---------|------|-------|-----|----|---|
| | | | | | | | | Plieger Brussel New |
| spiegel rechthoekig 0800000 57x40cm | | | 0800000 | stuk | 12,75 | 238 | 0 | |
| spiegel rond 5mm 0800105 60cm | | | 0800105 | stuk | 26,25 | 238 | 0 |  |
| glashouder enkel m. glas 0670480 | | chrom | 0670480 | stuk | 11,25 | 241 | 0 |  |
| zeephouder m. glas 0670484 | | chrom | 0670484 | stuk | 11,25 | 241 | 0 |  |
| 2-lids handdoekhouder draaibaar 0670472 | | chrom | 0670472 | stuk | 20,00 | 241 | 0 |  |
| handdoekring 0670474 | | chrom | 0670474 | stuk | 11,50 | 241 | 0 |  |
| closetrolhouder m. klep 0670470 | | chrom | 0670470 | stuk | 12,25 | 241 | 0 |  |
| closetrolhouder z. klep 0670476 | | chrom | 0670476 | stuk | 14,25 | 241 | 0 |  |
| closetborstelgarnituur m. glas 0670478 | | chrom | 0670478 | stuk | 16,75 | 241 | 0 |  |
| jashaak dubbel 0670486 | | chrom | 0670486 | stuk | 7,40 | 241 | 0 |  |
| badgreep 30cm 0670488 | | chrom | 0670488 | stuk | 16,75 | 241 | 0 |  |

Sanitair producten

Baden /
douchebakken /
stoomcabines

Kranen

Douchegarnituur

Accessoires en
spiegels

Douchewanden

Toebehoren &
afvoeren









Spoel- &
installatiesystemen

Badkamermeubelen
en toiletkasten

Gootstenen en
wastroggen

Utiliteit

| | Art.nr | Specificaties | Kleur | Lev.nr | Ehd | Prijs | Grp | CC | |
|---|----------------------------|--|--------------|---------|------|--------|-----|----|--|
| Sanitair producten | Plieger Brussel New | | | | | | | | |
| | | zeephouder draadmodel 0670490 | chrom | 0670490 | stuk | 11,50 | 241 | 0 | |
| Baden / douchebakken / stoomcabines | | handdoekhaak enkel 0670491 | chrom | 0670491 | stuk | 4,77 | 241 | 0 | |
| | Kranen | Plieger Liberty | | | | | | | |
| | | vormspiegel m. facetrand 0803650 80x60cm | | 0803650 | stuk | 166,00 | 238 | 0 | |
| Douchegarnituur | | spiegel m. buisspot 0803510 90x35cm | | 0803510 | stuk | 146,50 | 238 | 0 | |
| Accessoires en spiegels | | spiegel rechthoekig 0803723 90x35cm | | 0803723 | stuk | 57,00 | 238 | 0 | |
| Douchewanden | | spotset hoog/tube 0803243 | chr./matglas | 0803243 | stuk | 124,00 | 238 | 0 | |
| Toebehoren & afvoeren | | Plieger Liberty New | | | | | | | |
| Spoel- & installatiesystemen | | glashouder m. glas enkel 0690205 | chrom | 0690205 | stuk | 51,00 | 223 | 0 | |
| Badkamermeubelen en toiletkasten | | zeephouder m. inzet 0690207 | chrom | 0690207 | stuk | 62,50 | 223 | 0 | |
| Gootstenen en wastroggen | | zeepdispenser m. houder 0690206 | chrom | 0690206 | stuk | 76,50 | 223 | 0 | |
| Utiliteit | | 2-lids handdoekhouder draaibaar 0690208 | chrom | 0690208 | stuk | 66,50 | 223 | 0 | |
| | | handdoekring 0690209 | chrom | 0690209 | stuk | 38,50 | 223 | 0 | |

| Art.nr | Specificaties | Kleur | Lev.nr | Ehd | Prijs | Grp | CC | |
|--|--------------------------------|--------|---------|------|--------|-----|----|---|
| Plieger Liberty New | | | | | | | | |
| badgreep 30cm 0690210 | | chroom | 0690210 | stuk | 62,50 | 223 | 0 |  |
| closetrolhouder m. klep 0690202 | | chroom | 0690202 | stuk | 57,00 | 223 | 0 |  |
| reserverolhouder 0690203 | | chroom | 0690203 | stuk | 28,25 | 223 | 0 |  |
| closetborstelgarnituur 0690204 | | chroom | 0690204 | stuk | 87,00 | 223 | 0 |  |
| handdoekhaak enkel 0690211 | | chroom | 0690211 | stuk | 10,75 | 223 | 0 | |
| Plieger Liberty New Onderdelen | | | | | | | | |
| 0690212 | losse borstelkop | | 0690212 | stuk | 8,40 | 223 | 1 | |
| 0690213 | los glas voor borstelgarnituur | | 0690213 | stuk | 29,75 | 223 | 1 | |
| Plieger Spring | | | | | | | | |
| spiegel t.b.v. fontein 0801313 50x35cm | | | 0801313 | stuk | 95,50 | 238 | 0 |  |
| spiegel m. verlichting 0803634 80x60cm | | | 0803634 | stuk | 172,00 | 238 | 0 |  |
| Plieger Spring New | | | | | | | | |
| houder voor drinkglas / zeepdispenser / zeepschaal 0691106 | | chroom | 0691106 | stuk | 12,75 | 223 | 0 |  |
| drinkglas los voor houder 0691096 | | glas | 0691096 | stuk | 13,00 | 223 | 0 |  |

Sanitair producten

Baden /
douchebakken /
stoomcabines

Kranen

Douchegarnituur

Accessoires en
spiegels

Douchewanden













Toebehoren &
afvoeren











Spoel- &
installatiesystemen











Badkamermeubelen
en toiletkasten

Gootstenen en
wastroggen

Utiliteit

| | Art.nr | Specificaties | Kleur | Lev.nr | Ehd | Prijs | Grp | CC |
|---|---|--|------------|---------|------|-------|-----|----|
| | Plieger Spring New | | | | | | | |
| Sanitair producten | | zeepschaal los voor houder 0691099 | glas | 0691099 | stuk | 23,00 | 223 | 0 |
| |  | | | | | | | |
| Baden / douchebakken / stoomcabines | | zeepdispenser los voor houder 0691098 | glas | 0691098 | stuk | 39,75 | 223 | 0 |
| |  | | | | | | | |
| Kranen | | | | | | | | |
| Douchegarnituur | | planchet 60cm 0691093 | chrom/glas | 0691093 | stuk | 83,50 | 223 | 0 |
| |  | | | | | | | |
| Accessoires en spiegels | | 2-lids handdoekhouder 0691101 | chrom | 0691101 | stuk | 47,00 | 223 | 0 |
| |  | | | | | | | |
| Douchewanden | | handdoekring 0691102 | chrom | 0691102 | stuk | 14,50 | 223 | 0 |
| |  | | | | | | | |
| Toebehoren & afvoeren | | handdoekhouder 60cm 0691103 | chrom | 0691103 | stuk | 51,50 | 223 | 0 |
| |  | | | | | | | |
| Spoel- & installatiesystemen | | closetrolhouder m. klep 0691090 | chrom | 0691090 | stuk | 28,75 | 223 | 0 |
| |  | | | | | | | |
| Badkamermeubelen en toiletkasten | | closetrolhouder z. klep 0691091 | chrom | 0691091 | stuk | 16,25 | 223 | 0 |
| |  | | | | | | | |
| Gootstenen en wastroggen | | | | | | | | |
| Utiliteit | | reserverolhouder 0691092 | chrom | 0691092 | stuk | 15,75 | 223 | 0 |
| |  | | | | | | | |
| | | houder voor closetborstelgarnituur z. inzet 0691094 | chrom | 0691094 | stuk | 14,00 | 223 | 0 |
| |  | | | | | | | |
| | | inzet + borstel los voor closetborstelhouder 0691095 | glas | 0691095 | stuk | 43,50 | 223 | 0 |
| |  | | | | | | | |
| | | badgreep 0691104 | chrom | 0691104 | stuk | 35,25 | 223 | 0 |
| |  | | | | | | | |

| Art.nr | Specificaties | Kleur | Lev.nr | Ehd | Prijs | Grp | CC | | |
|--------------------------------|---------------|-------------|---------|------|-------|-----|----|---|----------------------------------|
| | | | | | | | | Plieger Spring New | |
| haak | | | | | | | | | |
| 0691105 | | chroom | 0691105 | stuk | 7,80 | 223 | 0 |  | Sanitair producten |
| | | | | | | | | Plieger Globe | |
| glashouder m. glas | | | | | | | | | |
| 4363114 | | glas/chroom | 4363114 | stuk | 15,00 | 241 | 0 |  | Kranen |
| 4363164 | | glas/inox | 4363164 | stuk | 16,00 | 241 | 0 | | Douchegarnituur |
| zeepschaal | | | | | | | | | |
| 4363108 | | glas/chroom | 4363108 | stuk | 15,00 | 241 | 0 |  | Accessoires en spiegels |
| 4363158 | | glas/inox | 4363158 | stuk | 16,00 | 241 | 0 | | |
| zeepschaal draadmodel | | | | | | | | | |
| 4363110 | | chroom | 4363110 | stuk | 22,00 | 241 | 0 |  | Douchewanden |
| 4363160 | | inox | 4363160 | stuk | 28,00 | 241 | 0 | | Toebehoren & afvoeren |
| zeepdispenser | | | | | | | | | |
| 4363112 | | glas/chroom | 4363112 | stuk | 27,75 | 241 | 0 |  | Spoel- & installatiesystemen |
| 4363162 | | glas/inox | 4363162 | stuk | 29,75 | 241 | 0 | | |
| planchet | | | | | | | | | |
| 4363118 | | glas/chroom | 4363118 | stuk | 27,50 | 241 | 0 |  | Badkamermeubelen en toiletkasten |
| 4363168 | | glas/inox | 4363168 | stuk | 30,25 | 241 | 0 | | |
| handdoekhaak dubbel | | | | | | | | | |
| 4363102 | | chroom | 4363102 | stuk | 9,80 | 241 | 0 |  | Gootstenen en wastroggen |
| 4363152 | | inox | 4363152 | stuk | 11,50 | 241 | 0 | | |
| 2-lids handdoekhouder | | | | | | | | | |
| 4363122 | | chroom | 4363122 | stuk | 17,25 | 241 | 0 |  | Utiliteit |
| 4363172 | | inox | 4363172 | stuk | 23,50 | 241 | 0 | | |
| handdoekhouder dubbel | | | | | | | | | |
| 4363120 | | chroom | 4363120 | stuk | 27,50 | 241 | 0 |  | |
| 4363170 | | inox | 4363170 | stuk | 39,00 | 241 | 0 | | |
| handdoekring | | | | | | | | | |
| 4363100 | | chroom | 4363100 | stuk | 14,50 | 241 | 0 |  | |
| 4363150 | | inox | 4363150 | stuk | 19,00 | 241 | 0 | | |
| closetrolhouder z. klep | | | | | | | | | |
| 4363106 | | chroom | 4363106 | stuk | 20,25 | 241 | 0 |  | |
| 4363156 | | inox | 4363156 | stuk | 26,75 | 241 | 0 | | |

| | Art.nr | Specificaties | Kleur | Lev.nr | Ehd | Prijs | Grp | CC |
|---|---|---------------|-------------|---------|------|-------|-----|----|
| | Plieger Globe | | | | | | | |
| Sanitair producten | closetrolhouder m. klep | | | | | | | |
| | 4363104 | | chrom | 4363104 | stuk | 21,75 | 241 | 0 |
| | 4363154 | | inox | 4363154 | stuk | 28,25 | 241 | 0 |
| Baden / douchebakken / stoomcabines |  | | | | | | | |
| | closetborstelgarnituur | | | | | | | |
| Kranen | 4363116 | | chrom | 4363116 | stuk | 54,50 | 241 | 0 |
| | 4363166 | | inox | 4363166 | stuk | 62,00 | 241 | 0 |
| Douchegarnituur |  | | | | | | | |
| | Plieger Havana | | | | | | | |
| Accessoires en spiegels | glashouder m. glas | | | | | | | |
| | 4363014 | | glas/chroom | 4363014 | stuk | 12,00 | 241 | 0 |
| Douchewanden |  | | | | | | | |
| | zeepschaal | | | | | | | |
| Toebehoren & afvoeren | 4363010 | | glas/chroom | 4363010 | stuk | 12,00 | 241 | 0 |
| | | | | | | | | |
| |  | | | | | | | |
| | zeepschaal draadmodel | | | | | | | |
| Spoel- & installatiesystemen | 4363008 | | chrom | 4363008 | stuk | 18,75 | 241 | 0 |
| | | | | | | | | |
| |  | | | | | | | |
| | zeepdispenser | | | | | | | |
| Badkamermeubelen en toiletkasten | 4363012 | | glas/chroom | 4363012 | stuk | 18,50 | 241 | 0 |
| | | | | | | | | |
| |  | | | | | | | |
| | planchet | | | | | | | |
| Gootstenen en wastroggen | 4363018 | | glas/chroom | 4363018 | stuk | 22,00 | 241 | 0 |
| | | | | | | | | |
| |  | | | | | | | |
| | handdoekhaak enkel | | | | | | | |
| Utiliteit | 4363002 | | chrom | 4363002 | stuk | 8,50 | 241 | 0 |
| | | | | | | | | |
| |  | | | | | | | |
| | 2-lids handdoekhouder | | | | | | | |
| Utiliteit | 4363022 | | chrom | 4363022 | stuk | 23,00 | 241 | 0 |
| | | | | | | | | |
| |  | | | | | | | |
| | handdoekhouder | | | | | | | |
| Utiliteit | 4363020 | | chrom | 4363020 | stuk | 17,50 | 241 | 0 |
| | | | | | | | | |
| |  | | | | | | | |

| Art.nr | Specificaties | Kleur | Lev.nr | Ehd | Prijs | Grp | CC |
|--------|---------------|-------|--------|-----|-------|-----|----|
|--------|---------------|-------|--------|-----|-------|-----|----|

Plieger Havana

handdoekring
4363000

chroom

4363000

stuk

13,25

241

0



Sanitair producten

closetrolhouder z. deksel
4363006

chroom

4363006

stuk

13,75

241

0



Baden /
douchebakken /
stoomcabines

Kranen

closetrolhouder m. deksel
4363004

chroom

4363004

stuk

14,75

241

0



Douchegarnituur

Accessoires en
spiegels

closetborstelgarnituur
4363016

glas/chroom

4363016

stuk

15,00

241

0



Douchewanden









Toebehoren &
afvoeren











Spoel- &
installatiesystemen

Badkamermeubelen
en toiletkasten











Gootstenen en
wastroggen







Utiliteit













| | Art.nr | Specificaties | Kleur | Lev.nr | Ehd | Prijs | Grp | CC |
|---|---|--|-------------|-----------|------|--------|-----|----|
| Sanitair producten | Sphinx 450/Atlantic | | | | | | | |
| |  | glashouder 0223174 | glas/chroom | S8HK43C00 | stuk | 156,00 | 042 | 1 |
| Baden / douchebakken / stoomcabines |  | zeephouder 0223166 | glas/chroom | S8HK41C00 | stuk | 156,00 | 042 | 1 |
| Kranen | | | | | | | | |
| Douchegarnituur |  | planchet 0223204 70x12cm | glas/chroom | S8HK46C00 | stuk | 315,00 | 042 | 0 |
| | | 0223190 60x12cm | glas/chroom | S8HK45C00 | stuk | 296,00 | 042 | 1 |
| | | 0223182 32.5x16cm | glas/chroom | S8HK44C00 | stuk | 188,00 | 042 | 1 |
| Accessoires en spiegels |  | | | | | | | |
| Douchewanden |  | handdoekhouder 0223212 | chroom | S8HK42C00 | stuk | 178,00 | 042 | 0 |
| Toebehoren & afvoeren |  | closetrolhouder 0223239 | glas/chroom | S8HK48C00 | stuk | 206,00 | 042 | 0 |
| Spoel- & installatiesystemen | | | | | | | | |
| Badkamermeubelen en toiletkasten |  | reserverolhouder 0223247 | chroom | S8HK49C00 | stuk | 85,50 | 042 | 1 |
| Gootstenen en wastroggen |  | closetborstelgarnituur 0223220 | chroom | S8HK47C00 | stuk | 254,00 | 042 | 0 |
| Utiliteit | | | | | | | | |
| <hr/> | | | | | | | | |
| Sphinx 340 | | | | | | | | |
| |  | wandzeepschaal 0226157 | glas/chroom | S8HK21C00 | stuk | 73,50 | 042 | 1 |
| | | zeepdispenser 0226165 | glas/chroom | S8HK22C00 | stuk | 113,00 | 042 | 1 |
| | | glashouder m. glas 0226173 | glas/chroom | S8HK23C00 | stuk | 98,50 | 042 | 0 |
| | | planchet 0226181 40cm | glas/chroom | S8HK24C00 | stuk | 88,00 | 042 | 1 |
| | | 0226203 60cm | glas/chroom | S8HK25C00 | stuk | 138,00 | 042 | 1 |
| | | 0226211 70cm | glas/chroom | S8HK26C00 | stuk | 148,00 | 042 | 1 |
| | | closetborstelgarnituur 0226238 | glas/chroom | S8HK27C00 | stuk | 127,00 | 042 | 1 |

| Art.nr | Specificaties | Kleur | Lev.nr | Ehd | Prijs | Grp | CC | | |
|---|---------------|----------------------------|-------------------------------------|----------------------|-------------------------|-----|-------------|---|---|
| Sphinx 340 / 360 | | | | | | | |  | |
| hoekplanchet 0220003 | | glas/chroom | S8HK07C00 | stuk | 73,50 | 241 | 1 | | Sanitair producten |
| wandlamp opaalglas 0220007 | | chroom | S8HK10C00 | stuk | 226,00 | 241 | 0 |  | Baden / douchebakken / stoomcabines |
| spiegel ovaal 0220016 45x60cm 0220014 60x80cm | | chroom chroom | S8HK12000 S8HK11000 | stuk stuk | 123,00 148,00 | 241 | 1 0 |  | Kranen |
| | | | | | | | |  | Douchegarnituur |
| 2-lids handdoekhouder draaibaar 0220020 | | chroom | S8HK02C00 | stuk | 109,00 | 241 | 1 |  | Accessoires en spiegels |
| handdoekring 0220018 | | chroom | S8HK01C00 | stuk | 79,00 | 241 | 0 |  | Douchewanden |
| handdoekhouder 0220022 40cm 0220024 60cm 0220026 80cm | | chroom chroom chroom | S8HK03C00 S8HK04C00 S8HK05C00 | stuk stuk stuk | 73,50 83,50 88,00 | 241 | 1 0 1 |  | Toebehoren & afvoeren |
| closetrolhouder 0220005 | | chroom | S8HK08C00 | stuk | 54,00 | 241 | 0 |  | Spoel- & installatiesystemen |
| kledinghaak enkel 0220001 | | chroom | S8HK06C00 | stuk | 39,50 | 241 | 0 |  | Badkamermeubelen en toiletkasten |
| Sphinx 420 | | | | | | | |  | |
| glashouder m. glas 0226521 | | glas/chroom | S8HK92C00 | stuk | 154,00 | 042 | 1 | | Gootstenen en wastroggen |
| | | | | | | | | | Utiliteit |









| | Art.nr | Specificaties | Kleur | Lev.nr | Ehd | Prijs | Grp | CC |
|---|------------------------|------------------------|-------------|-----------|------|--------|-----|----|
| Sanitair producten | Sphinx 420 | | | | | | | |
| | | zeepschaal | | | | | | |
| | 0226513 | | glas/chroom | S8HK91C00 | stuk | 154,00 | 042 | 1 |
| Baden / douchebakken / stoomcabines | closetrolhouder | | | | | | | |
| | | 0226580 | glas/chroom | S8HK93C00 | stuk | 206,00 | 042 | 1 |
| Douchegarnituur | planchet | | | | | | | |
| | 0226518 | 60x12cm | glas/chroom | S8HK94C00 | stuk | 295,00 | 042 | 1 |
| | 0226556 | 90x12cm | glas/chroom | S8HK96C00 | stuk | 351,00 | 042 | 1 |
| | 0226564 | 120x12cm | glas/chroom | S8HK97C00 | stuk | 395,00 | 042 | 1 |
| Accessoires en spiegels | | haak universeel | chroom | S8HK82C00 | stuk | 96,00 | 042 | 0 |
| Douchewanden | | | | | | | | |
| Toebehoren & afvoeren | | | | | | | | |
| Spoel- & installatiesystemen | | | | | | | | |
| Badkamermeubelen en toiletkasten | | | | | | | | |
| Gootstenen en wastroggen | | | | | | | | |
| Utiliteit | | | | | | | | |











| Art.nr | Specificaties | Kleur | Lev.nr | Ehd | Prijs | Grp | CC | | |
|--|---------------|--------|------------|------|--------|-----|----|---|---|
| | | | | | | | | Villeroy & Boch Circle | |
| glashouder compleet 0475025 | | chroom | 8340092044 | stuk | 139,00 | 172 | 1 |  | Sanitair producten |
| glashouder dubbel compleet 0475033 | | chroom | 8340292044 | stuk | 234,00 | 172 | 1 |  | Baden / douchebakken / stoomcabines |
| glas/zeephouder compleet 0475041 | | chroom | 8340892044 | stuk | 245,00 | 172 | 1 |  | Kranen |
| zeephouder compleet 0475068 | | chroom | 8341092044 | stuk | 150,00 | 172 | 1 |  | Douchegarnituur |
| zeepdispenser melkglas 0475076 | | chroom | 8343092044 | stuk | 223,00 | 172 | 1 |  | Accessoires en spiegels |
| badgeep 30cm 0474975 | | chroom | 8303092044 | stuk | 128,00 | 172 | 1 |  | Douchewanden |
| handdoekhouder 60cm 0474983 | | chroom | 8306092044 | stuk | 153,00 | 172 | 1 |  | Toebehoren & afvoeren |
| handdoekring 0474991 | | chroom | 8320092044 | stuk | 105,00 | 172 | 1 |  | Spoel- & installatiesystemen |
| 2-lids handdoekhouder 0475009 | | chroom | 8321092044 | stuk | 163,00 | 172 | 1 |  | Badkamermeubelen en toiletkasten |
| closetrolhouder m. klep 0475084 | | chroom | 8351092044 | stuk | 125,00 | 172 | 1 |  | Gootstenen en wastroggen |
| closetrolhouder z. klep 0475092 | | chroom | 8350092044 | stuk | 102,00 | 172 | 1 |  | Utiliteit |

| | Art.nr | Specificaties | Kleur | Lev.nr | Ehd | Prijs | Grp | CC |
|---|---|--|------------|------------|--------|--------|-----|----|
| Sanitair producten | Villeroy & Boch Circle | | | | | | | |
| | | reserverolhouder | | | | | | |
| |  | 0475106 | chrom | 8359092044 | stuk | 102,00 | 172 | 1 |
| Baden / douchebakken / stoomcabines | closetborstelgarnituur | | | | | | | |
| | | 0475114 | chrom | 8390092044 | stuk | 248,00 | 172 | 1 |
| Kranen |  | | | | | | | |
| Douchegarnituur | haak 2-delig | | | | | | | |
| | | 0475017 | chrom | 8325692044 | stuk | 105,00 | 172 | 1 |
| |  | | | | | | | |
| Accessoires en spiegels | toiletgarnituur wandmontage 895mm | | | | | | | |
| | | 0475122 | chrom | 8395092044 | stuk | 563,00 | 172 | 1 |
| |  | | | | | | | |
| Douchewanden | | | | | | | | |
| Toebehoren & afvoeren | toiletgarnituur wandmontage 535mm | | | | | | | |
| | | 0475149 | chrom | 8393092044 | stuk | 601,00 | 172 | 1 |
| |  | | | | | | | |
| Spoel- & installatiesystemen | wastafelgarnituur wandmontage | | | | | | | |
| | | 0475130 | chrom | 8392092044 | stuk | 504,00 | 172 | 1 |
| |  | | | | | | | |
| Badkamermeubelen en toiletkasten | | | | | | | | |
| Gootstenen en wastroggen | Villeroy & Boch Cult | | | | | | | |
| | | glashouder m. kristalglas | | | | | | |
| Utiliteit | | 0272646 | chrom | 8340096000 | stuk | 117,50 | 172 | 1 |
| | | zeephouder m. inzet | | | | | | |
| | | 0272647 | chrom | 8341096000 | stuk | 123,10 | 172 | 1 |
| | | zeepdispenser compleet m. kristalglas | | | | | | |
| | | 0272649 | chrom | 8343096000 | stuk | 178,90 | 172 | 1 |
| | | closetrolhouder z. klep | | | | | | |
| | | 0272653 | chrom | 8350096000 | stuk | 90,70 | 172 | 1 |
| | | closetborstelgarnituur m. kristal inzet | | | | | | |
| | | 0272654 | chrom | 8390096000 | stuk | 196,50 | 172 | 1 |
| | | badgreep 30cm | | | | | | |
| | 0272641 | chrom | 8303096000 | stuk | 110,40 | 172 | 1 | |
| | handdoekhouder 60cm | | | | | | | |
| | 0272642 | chrom | 8306096000 | stuk | 134,70 | 172 | 1 | |
| | handdoekring | | | | | | | |
| | 0272643 | chrom | 8320096000 | stuk | 96,10 | 172 | 1 | |

| Art.nr | Specificaties | Kleur | Lev.nr | Ehd | Prijs | Grp | CC | | |
|--|---------------|----------------|------------|------|--------|-----|----|---|---|
| Villeroy & Boch Cult | | | | | | | | | |
| 1-lids handdoekhouder 0272644 | | chroom | 8321196000 | stuk | 117,80 | 172 | 1 |  | Sanitair producten |
| haak 0272645 | | chroom | 8325196000 | stuk | 45,40 | 172 | 1 |  | Baden / douchebakken / stoomcabines |
| wandlamp opaalglas 0272657 | | chroom | 8330096000 | stuk | 236,30 | 172 | 1 |  | Kranen |
| sponshouder draadmodel 0272652 | | chroom | 8329097000 | stuk | 110,50 | 172 | 1 |  | |
| Villeroy & Boch Hype | | | | | | | | | |
| systeemrail m. schuif 0475922 | | chroom | 2671093000 | stuk | 352,00 | 172 | 1 |  | Douchegarnituur |
| opbergrekje 0476056 | | alu./cool-glas | 8226093081 | stuk | 165,00 | 172 | 1 |  | Accessoires en spiegels |
| wandlamp 0476048 | | wit | 8231593069 | stuk | 257,00 | 172 | 1 |  | Douchewanden |
| glashouder voor montageprofiel 0476099 | | alu./cool-glas | 8240093081 | stuk | 125,00 | 172 | 1 |  | Toebehoren & afvoeren |
| glashouder m. matglas 0476105 | | chroom | 8340093000 | stuk | 97,00 | 172 | 1 |  | Spoel- & installatiesystemen |
| zeepschaal voor montagerail 0476102 | | alu./mat glas | 8241093081 | stuk | 135,00 | 172 | 1 |  | Badkamermeubelen en toiletkasten |
| zeepdispenser voor montagerail 0476106 | | chroom | 8341093000 | stuk | 97,00 | 172 | 1 |  | Gootstenen en wastroggen |
| zeepdispenser voor montagerail 0476110 | | alu./mat glas | 8243093000 | stuk | 178,00 | 172 | 1 |  | Utiliteit |

| | Art.nr | Specificaties | Kleur | Lev.nr | Ehd | Prijs | Grp | CC |
|---|--------|---|----------------|--------------|------|--------|-----|----|
| Sanitair producten | | Villeroy & Boch Hype zeepdispenser compleet 0476107 | chroom | 8343093000 | stuk | 135,00 | 172 | 1 |
| Baden / douchebakken / stoomcabines | | inbouw zeepdispenser 0475971 | chroom | 8243593000 | stuk | 134,00 | 172 | 1 |
| Kranen | | planchet 0476013 | cool glas | 8244393081 | stuk | 134,00 | 172 | 1 |
| Douchegarnituur | | kastdeur m. 3 legplanken voor montageprofiel 0476080 | chroom/wit | 8263093069 | stuk | 531,00 | 172 | 1 |
| Accessoires en spiegels | | badgreep m. planchet 0476064 | chroom/wit | 8303593000 | stuk | 147,00 | 172 | 1 |
| Douchewanden | | handdoekhouder m. planchet 0476006 | chroom/wit | 8308593000 | stuk | 290,00 | 172 | 1 |
| Toebehoren & afvoeren | | spiegel + systeemrail 0476021 | alu./cool-glas | 8318093081 | stuk | 672,00 | 172 | 1 |
| Spoel- & installatiesystemen | | 2-lids handdoekhouder 0475998 | chroom/wit | 832109300069 | stuk | 132,00 | 172 | 1 |
| Badkamermeubelen en toiletkasten | | closetrolhouder compleet 0476137 | chroom/wit | 835509300069 | stuk | 215,00 | 172 | 1 |
| Gootstenen en wastroggen | | | | | | | | |
| Utiliteit | | | | | | | | |

| Art.nr | Specificaties | Kleur | Lev.nr | Ehd | Prijs | Grp | CC | | |
|--|---------------|------------|--------------|------|--------|-----|----|---|---|
| | | | | | | | | Villeroy & Boch Hype | |
| closetborstelgarnituur 0476129 | | chroom/wit | 839009300069 | stuk | 211,00 | 172 | 1 |  | Sanitair producten |
| handdoekhouder m. planchet 40cm 0475924 | | chroom | 8306593000 | stuk | 233,00 | 172 | 1 |  | Baden / douchebakken / stoomcabines |
| handdoekhouder m. planchet m. glashouder 0475926 | | chroom | 8306693000 | stuk | 248,00 | 172 | 1 |  | Kranen |
| badgreep 30cm 0475670 | | chroom | 8303093000 | stuk | 93,50 | 172 | 1 | | Douchegarnituur |
| handdoekhouder 60cm 0475671 | | chroom | 8306093000 | stuk | 117,00 | 172 | 1 |  | Accessoires en spiegels |
| handdoekring 0475672 | | chroom | 8320093000 | stuk | 88,00 | 172 | 1 |  | Douchewanden |
| 2-lids handdoekhouder 0475673 | | chroom | 8321193000 | stuk | 124,00 | 172 | 1 |  | Toebehoren & afvoeren |
| closetborstelgarnituur 0475677 | | chroom | 8390593000 | stuk | 197,00 | 172 | 1 |  | Spoel- & installatiesystemen |
| closetrolhouder z. klep 0475675 | | chroom | 8350093000 | stuk | 80,00 | 172 | 1 |  | Badkamermeubelen en toiletkasten |
| closetrolhouder m. klep 0475674 | | chroom | 8351093000 | stuk | 103,00 | 172 | 1 |  | Gootstenen en wastroggen |
| | | | | | | | | | Utiliteit |

| | Art.nr | Specificaties | Kleur | Lev.nr | Ehd | Prijs | Grp | CC | |
|---|---|---|---|------------|------------|--------|--------|-----|---|
| Sanitair producten | Villeroy & Boch Hype | | | | | | | | |
| | | reserverolhouder 0475676 | chrom | 8359093000 | stuk | 80,00 | 172 | 1 | |
| Baden / douchebakken / stoomcabines |  | Villeroy & Boch Look | | | | | | | |
| | | | glashouder m. helder glas 0475512 | chrom | 8340095000 | stuk | 102,00 | 172 | 1 |
| Kranen |  | zeephouder compleet 0475514 | | | | | | | |
| | | | chrom | 8341095000 | stuk | 87,50 | 172 | 1 | |
| Douchegarnituur |  | zeepdispenser compleet 0475515 | | | | | | | |
| | | | chrom | 8343095000 | stuk | 154,00 | 172 | 1 | |
| Accessoires en spiegels |  | planchet 60cm 0475516 | | | | | | | |
| | | | chrom | 8346095000 | stuk | 124,00 | 172 | 1 | |
| Douchewanden |  | handdoekkring 0475508 | | | | | | | |
| | | | chrom | 8320095000 | stuk | 85,00 | 172 | 1 | |
| Toebehoren & afvoeren |  | 2-lids handdoekhouder 0475509 | | | | | | | |
| | | | chrom | 8321095000 | stuk | 107,00 | 172 | 1 | |
| Spoel- & installatiesystemen |  | handdoekhaak enkel 0475510 | | | | | | | |
| | | | chrom | 8325195000 | stuk | 18,25 | 172 | 1 | |
| Badkamermeubelen en toiletkasten |  | 4-delig hakenset 0475511 | | | | | | | |
| | | | chrom | 8326095000 | stuk | 72,00 | 172 | 1 | |
| Gootstenen en wastroggen |  | wandgreep 30cm 0475506 | | | | | | | |
| | | | chrom | 8303095000 | stuk | 91,00 | 172 | 1 | |
| Utiliteit |  | handdoekhouder 60cm 0475507 | | | | | | | |
| | | | chrom | 8306095000 | stuk | 117,00 | 172 | 1 | |
| |  | closetrolhouder z. klep 0475517 | | | | | | | |
| | | | chrom | 8350095000 | stuk | 68,00 | 172 | 1 | |

| Art.nr | Specificaties | Kleur | Lev.nr | Ehd | Prijs | Grp | CC | | |
|--|---------------|--------|------------|------|--------|-----|----|---|---|
| | | | | | | | | Villeroy & Boch Look | |
| reserverolhouder 0475518 | | chroom | 8359095000 | stuk | 65,50 | 172 | 1 |  | Sanitair producten |
| closetborstelgarnituur 0475519 | | chroom | 8390095000 | stuk | 160,00 | 172 | 1 |  | Baden / douchebakken / stoomcabines |
| | | | | | | | | Villeroy & Boch Source | |
| glashouder met glas 0475551 | | chroom | 8340094000 | stuk | 162,00 | 272 | 1 |  | Accessoires en spiegels |
| zeephouder met inzet 0475552 | | chroom | 8341094025 | stuk | 187,00 | 272 | 1 |  | Douchewanden |
| zeepdispenser compleet 0475553 | | chroom | 8343094000 | stuk | 253,00 | 272 | 1 |  | Toebehoren & afvoeren |
| zeepdispenser staand model 0475554 | | chroom | 8443094000 | stuk | 176,00 | 272 | 1 |  | Spoel- & installatiesystemen |
| badgreep 0475545 30cm | | chroom | 8303094000 | stuk | 166,00 | 272 | 1 |  | Badkamermeubelen en toiletkasten |
| badlakenrek 0475546 45cm | | chroom | 8304594000 | stuk | 170,00 | 272 | 1 |  | Gootstenen en wastroggen |
| 0475547 60cm | | chroom | 8306094000 | stuk | 176,00 | 272 | 1 | | |
| handdoekhaak enkel 0475550 | | chroom | 8325194000 | stuk | 56,00 | 272 | 1 |  | Utiliteit |
| closetrolhouder z.klep 0475565 | | chroom | 8350094000 | stuk | 117,00 | 272 | 1 |  | |

| | Art.nr | Specificaties | Kleur | Lev.nr | Ehd | Prijs | Grp | CC |
|---|-----------------------------------|--|-------|------------|------|--------|-----|----|
| Sanitair producten | Villeroy & Boch Source | | | | | | | |
| | | closetrolhouder m.klep 0475555 | chrom | 8351094000 | stuk | 146,00 | 272 | 1 |
| Baden / douchebakken / stoomcabines | | closetrolhouder dubbel 0475557 | chrom | 8352594000 | stuk | 203,00 | 272 | 1 |
| Kranen | | reserverolhouder 0475558 | chrom | 8359094000 | stuk | 117,00 | 272 | 1 |
| Douchegarnituur | | closetborstelgarnituur 0475559 | chrom | 8390094025 | stuk | 278,00 | 272 | 1 |
| Accessoires en spiegels | | lamp 0475567 | | 8330094000 | stuk | 284,00 | 272 | 1 |
| Douchewanden | | glashouder compleet 0474908 | chrom | 8340091000 | stuk | 166,00 | 172 | 1 |
| Toebehoren & afvoeren | | zeepouder compleet 0474916 | chrom | 8341091000 | stuk | 180,00 | 172 | 1 |
| Spoel- & installatiesystemen | | badgreep 30cm 0474843 | chrom | 8303091000 | stuk | 148,00 | 172 | 1 |
| Badkamermeubelen en toiletkasten | | handdoekhouder 60cm 0474851 | chrom | 8306091000 | stuk | 173,00 | 172 | 1 |
| Gootstenen en wastroggen | | handdoekring 0474878 | chrom | 8320091000 | stuk | 134,00 | 172 | 1 |
| Utiliteit | | 1-lids handdoekhouder 0474886 | chrom | 8321191000 | stuk | 134,00 | 172 | 1 |

| Art.nr | Specificaties | Kleur | Lev.nr | Ehd | Prijs | Grp | CC | | |
|---|--|--------|--------------|------|--------|-----|----|---|---|
| | | | | | | | | Villeroy & Boch Square | |
| closetrolhouder m. klep 0474924 | | chroom | 8351091000 | stuk | 148,00 | 172 | 1 |  | Sanitair producten |
| closetrolhouder z. klep 0474932 | | chroom | 8350091000 | stuk | 112,00 | 172 | 1 |  | Baden / douchebakken / stoomcabines |
| reserverolhouder 0474940 | | chroom | 8359091000 | stuk | 112,00 | 172 | 1 |  | Kranen |
| closetborstelgarnituur 0474959 | | chroom | 8390091000 | stuk | 253,00 | 172 | 1 |  | Douchegarnituur |
| haak 6cm 0474897 | | chroom | 8325191000 | stuk | 52,00 | 172 | 1 |  | Accessoires en spiegels |
| spiegellamp 0474967 | | chroom | 8330091000 | stuk | 299,00 | 172 | 1 |  | Douchewanden |
| | | | | | | | | Villeroy & Boch Onderdelen | |
| 0272650 | pomp los voor zeepdispenser | chroom | 510105000500 | stuk | 82,90 | 172 | 1 | | Toebehoren & afvoeren |
| 0272656 | borstelkop wit voor closetborstelgarnituur | | 8185060090 | stuk | 16,90 | 172 | 1 | | Spoel- & installatiesystemen |
| 0272648 | kristal inzet voor zeephouder | | 8900100884 | stuk | 523,00 | 172 | 1 | | Badkamermeubelen en toiletkasten |
| 0272658 | opaalglas los voor wandlamp | | 8900309283 | stuk | 87,10 | 172 | 1 | | Gootstenen en wastroggen |
| 0272655 | glasinzet voor closetborstelgarnituur | | 8900400882 | stuk | 69,60 | 172 | 1 | | Utiliteit |
| 0272651 | kristalglas los voor zeepdispenser | | 8900400982 | stuk | 69,60 | 172 | 1 | | |

| Art.nr | Specificaties | Kleur | Lev.nr | Ehd | Prijs | Grp | CC |
|--------|---------------|-------|--------|-----|-------|-----|----|
|--------|---------------|-------|--------|-----|-------|-----|----|



Luca vloerwiser

Luca vloerwiser m. ophanghaak
2345678

RVS

2345678

stuk

83,50

247

0

Sanitair producten

Baden /
douchebakken /
stoomcabines

Kranen

Douchegarnituur

Accessoires en
spiegels

Douchewanden







Toebehoren &
afvoeren









Spoel- &
installatiesystemen









Badkamermeubelen
en toiletkasten

Gootstenen en
wastroggen

Utiliteit

| Art.nr | Specificaties | Kleur | Lev.nr | Ehd | Prijs | Grp | CC | | | |
|---|---------------|------------------------|---------|------|--------|-----|----|---|---|----------------------------|
| | | | | | | | | spiegels | | |
| spiegel rechthoekig 5mm | | | | | | | | | | |
| 0801100 | 40x30cm | | 0801100 | stuk | 11,00 | 238 | 0 |  | Sanitair producten | |
| 0800066 | 50x40cm | | 0800066 | stuk | 13,00 | 238 | 0 | | | |
| 0800082 | 57x40cm | | 0800082 | stuk | 12,75 | 238 | 0 | | | |
| 0800023 | 57x45cm | | 0800023 | stuk | 18,25 | 238 | 0 | | | |
| 0800095 | 57x60cm | | 0800095 | stuk | 23,25 | 238 | 0 | | Baden / douchebakken / stoomcabines | |
| 0800104 | 60x40cm | | 0800104 | stuk | 14,50 | 238 | 0 | | | |
| 0801119 | 60x45cm | | 0801119 | stuk | 15,50 | 238 | 0 | | | |
| 0800112 | 63x40cm | | 0800112 | stuk | 14,50 | 238 | 0 | | | |
| 0801356 | 70x55cm | | 0801356 | stuk | 24,50 | 238 | 0 | | Kranen | |
| 0806000 | 80x40cm | | 0806000 | stuk | 25,25 | 238 | 1 | | | |
| 0801089 | 80x60cm | | 0801089 | stuk | 38,25 | 238 | 0 | | | |
| 0801113 | 100x40cm | | 0801113 | stuk | 67,50 | 238 | 1 | | | |
| 0800115 | 100x60cm | | 0800115 | stuk | 22,75 | 238 | 0 | | Douchegarnituur | |
| 0801392 | 150x60cm | | 0801392 | stuk | 151,00 | 238 | 1 | | | |
| spiegel rond 5mm | | | | | | | | | | |
| 0800279 | 30cm | | 0800279 | stuk | 10,25 | 238 | 0 |  | | Accessoires en spiegels |
| 0800295 | 40cm | | 0800295 | stuk | 15,50 | 238 | 0 | | | |
| 0800317 | 50cm | | 0800317 | stuk | 20,50 | 238 | 0 | | | |
| 0800333 | 60cm | | 0800333 | stuk | 26,25 | 238 | 0 | | | |
| 0800411 | 65cm | | 0800411 | stuk | 35,50 | 238 | 0 | | | |
| spiegel toog 5mm | | | | | | | | | | |
| 0801402 | 80x60cm | | 0801402 | stuk | 49,50 | 238 | 0 |  | Douchewanden | |
| spiegel rechthoekig m. facetrand | | | | | | | | | | |
| 0801410 | 40x30cm | | 0801410 | stuk | 23,00 | 238 | 0 |  | Toebehoren & afvoeren | |
| 0801429 | 50x40cm | | 0801429 | stuk | 25,75 | 238 | 0 | | | |
| 0801445 | 60x40cm | | 0801445 | stuk | 29,50 | 238 | 0 | | | |
| 0801488 | 70x55cm | | 0801488 | stuk | 41,50 | 238 | 0 | | | |
| 0801496 | 80x60cm | | 0801496 | stuk | 48,75 | 238 | 0 | | | |
| spiegel m. facetrand | | | | | | | | | | |
| 0800070 | 58x58cm | m. verdeckte ophanging | 0800070 | stuk | 31,50 | 238 | 1 | | Badkamermeubelen en toiletkasten | |
| spiegel rond m. facetrand | | | | | | | | | | |
| 0800511 | 40cm | | 0800511 | stuk | 33,75 | 238 | 0 |  | Gootstenen en wastroggen | |
| 0801186 | 50cm | | 0801186 | stuk | 42,00 | 238 | 1 | | | |
| 0800481 | 60cm | | 0800481 | stuk | 55,50 | 238 | 0 | | | |
| spiegel ovaal m. facetrand | | | | | | | | | | |
| 0801518 | 45x30cm | | 0801518 | stuk | 36,75 | 238 | 0 |  | Utiliteit | |
| 0801178 | 50x40cm | | 0801178 | stuk | 40,50 | 238 | 1 | | | |
| 0801194 | 70x50cm | | 0801194 | stuk | 54,50 | 238 | 0 | | | |
| spiegel toog m. facetrand | | | | | | | | | | |
| 0801526 | 40x30cm | | 0801526 | stuk | 44,25 | 238 | 0 |  | | |
| 0800538 | 50x40cm | | 0800538 | stuk | 46,50 | 238 | 0 | | | |
| 0801542 | 70x55cm | | 0801542 | stuk | 62,50 | 238 | 1 | | | |

| | Art.nr | Specificaties | Kleur | Lev.nr | Ehd | Prijs | Grp | CC |
|---|---|---|-------|---------|------|--------|-----|----|
| | spiegels | | | | | | | |
| Sanitair producten | | spiegel toog m. facetrand m. afgeronde hoeken 0800473 80x60cm | | 0800473 | stuk | 79,00 | 238 | 0 |
| Baden / douchebakken / stoomcabines |  | | | | | | | |
| Kranen | | spiegel m. gezandstraalde rand 35x50cm 0803391 | | 0803391 | stuk | 73,00 | 238 | 0 |
| Douchegarnituur |  | | | | | | | |
| Accessoires en spiegels | | spiegel m. gezandstraalde rand 60x60cm 0803413 | | 0803413 | stuk | 76,50 | 238 | 0 |
| Douchewanden |  | | | | | | | |
| Toebehoren & afvoeren | | spiegel m. gezandstraalde rand 80x60cm 0803421 | | 0803421 | stuk | 87,00 | 238 | 0 |
| Douchewanden |  | | | | | | | |
| Spoel- & installatiesystemen | | spiegel m. gezandstraalde rand 105x30cm 0803448 | | 0803448 | stuk | 75,00 | 238 | 0 |
| Badkamermeubelen en toiletkasten |  | | | | | | | |
| Gootstenen en wastroggen | | spiegel m. gezandstraalde rand rond 60x60cm 0803375 | | 0803375 | stuk | 76,50 | 238 | 0 |
| Gootstenen en wastroggen |  | | | | | | | |
| Utiliteit | | spiegel m. inox rand 40x40cm 0803537 | | 0803537 | stuk | 82,00 | 238 | 0 |
| Utiliteit |  | | | | | | | |
| | | spiegel m. inox rand 60x60cm 0801844 | | 0801844 | stuk | 167,00 | 238 | 0 |
| |  | | | | | | | |
| | | spiegel m. inox rand 80x60cm 0803553 | | 0803553 | stuk | 225,00 | 238 | 0 |
| |  | | | | | | | |

| Art.nr | Specificaties | Kleur | Lev.nr | Ehd | Prijs | Grp | CC | | |
|---------|--|---------------|---------|------|--------|-----|----|---|---|
| | | | | | | | | spiegels | |
| 0803561 | spiegel m. inox rand 90x25cm | | 0803561 | stuk | 169,00 | 238 | 0 |  | Sanitair producten |
| 0803626 | spiegel m. spot melkglas 80x60cm | | 0803626 | stuk | 200,50 | 238 | 0 |  | Baden / douchebakken / stoomcabines |
| 0803502 | spiegel m. verlichting mat 70x55cm | | 0803502 | stuk | 220,50 | 238 | 0 |  | Kranen |
| | | | | | | | | Spiegels Raminex SilkLine | |
| 0820340 | dubbelzijdige spiegel 60x80cm | | 600101 | stuk | 174,00 | 238 | 0 | | Douchegarnituur |
| 0820343 | spiegelopstand 100cm voor dubbelzijdige spiegel | chrom | 800173 | stuk | 399,00 | 238 | 0 |  | Accessoires en spiegels |
| | | | | | | | | Verlichting voor spiegels | |
| 0802719 | 1xmini spot halogeen m. trafo | chrom/wit | 0802719 | stuk | 89,50 | 238 | 0 |  | Douchewanden |
| 0803251 | 1xspot halogeen m. trafo links+rechts | chrom | 0803251 | stuk | 126,00 | 238 | 0 |  | Toebehoren & afvoeren |
| 0803278 | 1xmini spot halogeen m. trafo | chr./melkglas | 0803278 | stuk | 85,00 | 238 | 0 |  | Spoel- & installatiesystemen |
| 0803286 | 1xmini spot m. trafo flexibel m. mat buis | | 0803286 | stuk | 61,50 | 238 | 0 |  | Badkamermeubelen en toiletkasten |
| 0803219 | spotset glas=mat buis=chrom 220V | | 0803219 | stuk | 89,50 | 238 | 0 |  | Gootstenen en wastroggen |
| | | | | | | | | Utiliteit | |

| | Art.nr | Specificaties | Kleur | Lev.nr | Ehd | Prijs | Grp | CC |
|---|--|--------------------------------|-------|---------|------|--------|-----|----|
| Sanitair producten | Verlichting voor spiegels | | | | | | | |
| | | spotset pianomodel 220V | | | | | | |
| | 0803235 | | chrom | 0803235 | stuk | 105,00 | 238 | 0 |
| Baden / douchebakken / stoomcabines | los glas voor spot 0803286 | | | | | | | |
| | 0805010 | | | 0805010 | stuk | 3,65 | 238 | 1 |
| Kranen | planchets | | | | | | | |
| | planchet helderglas | | | | | | | |
| Douchegarnituur | 0820032 | 50x12cm | | 0820032 | stuk | 6,50 | 238 | 0 |
| | 0820067 | 60x12cm | | 0820067 | stuk | 6,30 | 238 | 0 |
| | planchet helderglas gehard | | | | | | | |
| | 0820059 | 60x12cm | | 0820059 | stuk | 6,80 | 238 | 0 |
| Accessoires en spiegels | bevestigingssets | | | | | | | |
| | ophangset verdekt voor spiegel compleet tot 6 kilo | | | | | | | |
| Douchewanden | 0802409 | | | 0802409 | stuk | 12,50 | 238 | 0 |
| | ophangset verdekt voor spiegel + verlichting compleet | | | | | | | |
| | 0802417 | | | 0802417 | stuk | 13,75 | 238 | 0 |
| Toebehoren & afvoeren | | | | | | | | |
| Spoel- & installatiesystemen | | | | | | | | |
| Badkamermeubelen en toiletkasten | | | | | | | | |
| Gootstenen en wastroggen | | | | | | | | |
| Utiliteit | | | | | | | | |

| Art.nr | Specificaties | Kleur | Lev.nr | Ehd | Prijs | Grp | CC |
|--------------------------------------|---------------------------|----------------|-----------|------|-------|-----|----|
| planchets Carrara & Matta | | | | | | | |
| planchet kunststof | | | | | | | |
| 0820261 | 50x12cm | wit | 101603000 | stuk | 16,25 | 362 | 0 |
| 0820326 | 60x12cm | wit | 101606000 | stuk | 18,75 | 362 | 0 |
| planchets Plieger | | | | | | | |
| planchet kunststof | | | | | | | |
| 0820200 | 50cm | wit | 0820200 | stuk | 4,34 | 362 | 0 |
| planchet | | | | | | | |
| 0260347 | 60cm | pergamon | 0260347 | stuk | 22,75 | 004 | 0 |
| 0260517 | 50cm | wit | 0260517 | stuk | 14,75 | 004 | 0 |
| 0260525 | 50cm | pergamon | 0260525 | stuk | 22,75 | 004 | 0 |
| 0260584 | 60cm | wit | 0260584 | stuk | 14,75 | 004 | 0 |
| 0830410 | set potschroeven 5.5x60mm | wit | 0830410 | stuk | 0,84 | 362 | 0 |
| 0830453 | set potschroeven 5.5x60mm | chrom | 0830453 | stuk | 2,28 | 362 | 0 |
| planchets Schwab | | | | | | | |
| planchet kunststof | | | | | | | |
| 0820008 | 50x12cm | m. bevestiging | Z975001 | stuk | 10,50 | 362 | 0 |
| 0820016 | 60x12cm | m. bevestiging | Z976001 | stuk | 11,50 | 362 | 0 |



Sanitair producten

Baden /
douchebakken /
stoomcabines

Kranen

Douchegarnituur

Accessoires en
spiegels

Douchewanden

Toebehoren &
afvoerenSpoel- &
installatiesystemenBadkamermeubelen
en toiletkastenGootstenen en
wastroggen

Utiliteit

Toebehoren accessoires en spiegels

| | Art.nr | Specificaties | Kleur | Lev.nr | Ehd | Prijs | Grp | CC |
|---|---------------------------|--|-----------------------|-----------|---------|-------|-------|-------|
| | 0800392 | spiegelklemmen 4-delig | chroom | 70101000 | stuk | 5,30 | 238 | 0 |
| Sanitair producten | Toebehoren Kipp | | | | | | | |
| | 0800309 | spiegelgarnituur | | 320160001 | stuk | 27,01 | 238 | 0 |
| Baden / douchebakken / stoomcabines | Toebehoren Magnum | | | | | | | |
| | 7457717 | Look spiegelverwarming element 57x75cm | | 110W | 310075 | stuk | 87,50 | 737 0 |
| | 0100163 | Look spiegelverwarming rond 35cm | | 100W | 310035 | stuk | 64,00 | 737 1 |
| Kranen | Toebehoren Plieger | | | | | | | |
| | 0800414 | spiegelklemmen per stel | kunststof | 0800414 | stuk | 1,14 | 238 | 0 |
| | 0800406 | spiegelklemmen per stel | chroom | 0800406 | stuk | 1,55 | 238 | 0 |
| | 0802395 | spiegelklemmen acryl (tot 6mm) | | 0802395 | stuk | 8,70 | 238 | 0 |
| | 4362024 | spiegelverwarming 29x29cm. | 27W | 4362024 | stuk | 34,50 | 740 | 0 |
| | 4362026 | spiegelverwarming 41x58cm. | 65W | 4362026 | stuk | 38,75 | 740 | 0 |
| Douchegarnituur | 0820342 | paar glasplaatconsoles | verend chroom | 0820342 | paar | 10,50 | 238 | 0 |
| | 0823384 | paar glasplaatconsoles | verend m. 4 schroeven | chroom | 0823384 | paar | 10,86 | 238 0 |
| Accessoires en spiegels | | | | | | | | |
| Douchewanden | | | | | | | | |
| Toebehoren & afvoeren | | | | | | | | |
| Spoel- & installatiesystemen | | | | | | | | |
| Badkamermeubelen en toiletkasten | | | | | | | | |
| Gootstenen en wastroggen | | | | | | | | |
| Utiliteit | | | | | | | | |

Douchewanden

| | |
|------------------------------|------|
| Douchewanden Duscholux | 1036 |
| Douchewanden Hoesch | 1045 |
| Douchewanden Huppe | 1046 |
| Douchewanden Keramag JOOP! | 1062 |
| Douchewanden Kermi | 1063 |
| Douchewanden Novellini | 1098 |
| Douchewanden Plieger | 1108 |
| Douchewanden Riho | 1110 |
| Shower Collection | 1111 |
| Douchewanden Sphinx | 1113 |
| Douchewanden Ucosan | 1116 |
| Douchewanden Villeroy & Boch | 1117 |
| Sanishield | 1118 |

Douchewanden



| | Art.nr | Specificaties | Kleur | Lev.nr | Ehd | Prijs | Grp | CC |
|---|---|------------------------------|-----------------|-----------------|-----------------|---------|---------|-----|
| | Duscholux Bella Vita | | | | | | | |
| | pendeldeur voor nis 4-delig | | | | | | | |
| Sanitair producten | 1020862 | 130x200cm | wit/helder | 250011320551001 | stuk | 2267,00 | 276 | 1 |
| | 1020870 | 130x200cm | platinum/helder | 250011320551062 | stuk | 2420,00 | 276 | 1 |
| | 0977853 | 130x200cm m. Cleartec | wit/helder | 250011320751001 | stuk | 2571,00 | 276 | 1 |
| | 0977861 | 130x200cm m. Cleartec | platinum/helder | 250011320751062 | stuk | 2724,00 | 276 | 1 |
| | 1020889 | 140x200cm | wit/helder | 250011420551001 | stuk | 2305,00 | 276 | 1 |
| | 1020897 | 140x200cm | platinum/helder | 250011420551062 | stuk | 2458,00 | 276 | 1 |
| Baden / douchebakken / stoomcabines | 0977888 | 140x200cm m. Cleartec | wit/helder | 250011420751001 | stuk | 2609,00 | 276 | 1 |
| | 0977896 | 140x200cm m. Cleartec | platinum/helder | 250011420751062 | stuk | 2762,00 | 276 | 1 |
| | draaivouwdeur voor nis 2-delig | | | | | | | |
| Kranen | 1020900 | 90x200cm links | wit/helder | 249117021551001 | stuk | 1578,00 | 276 | 1 |
| | 1020919 | 90x200cm links | platinum/helder | 249117021551062 | stuk | 1652,00 | 276 | 1 |
| | 0977918 | 90x200cm links m. Cleartec | wit/helder | 249117021751001 | stuk | 1730,00 | 276 | 1 |
| | 0978116 | 90x200cm links m. Cleartec | platinum/helder | 249117021751062 | stuk | 1804,00 | 276 | 1 |
| Douchegarnituur | 1020927 | 90x200cm rechts | wit/helder | 249117022551001 | stuk | 1578,00 | 276 | 1 |
| | 1020935 | 90x200cm rechts | platinum/helder | 249117022551062 | stuk | 1652,00 | 276 | 1 |
| | 0977926 | 90x200cm rechts m. Cleartec | wit/helder | 249117022751001 | stuk | 1730,00 | 276 | 1 |
| | 0977934 | 90x200cm rechts m. Cleartec | platinum/helder | 249117022751062 | stuk | 1804,00 | 276 | 1 |
| | 1020943 | 100x200cm links | wit/helder | 249119021551001 | stuk | 1653,00 | 276 | 1 |
| | 1020951 | 100x200cm links | platinum/helder | 249119021551062 | stuk | 1727,00 | 276 | 1 |
| Accessoires en spiegels | 0977942 | 100x200cm links m. Cleartec | wit/helder | 249119021751001 | stuk | 1805,00 | 276 | 1 |
| | 0977950 | 100x200cm links m. Cleartec | platinum/helder | 249119021751062 | stuk | 1879,00 | 276 | 1 |
| | 1020978 | 100x200cm rechts | wit/helder | 249119022551001 | stuk | 1653,00 | 276 | 1 |
| | 1020986 | 100x200cm rechts | platinum/helder | 249119022551062 | stuk | 1727,00 | 276 | 1 |
| Douchewanden | 0977969 | 100x200cm rechts m. Cleartec | wit/helder | 249119022751001 | stuk | 1805,00 | 276 | 1 |
| | 0977977 | 100x200cm rechts m. Cleartec | platinum/helder | 249119022751062 | stuk | 1879,00 | 276 | 1 |
| | draaivouwdeur voor nis 4-delig | | | | | | | |
| | Toebehoren & afvoeren | 1020994 | 110x200cm | wit/helder | 249341120551001 | stuk | 2501,00 | 276 |
| 1021001 | | 110x200cm | platinum/helder | 249341120551062 | stuk | 2653,00 | 276 | 1 |
| 0977985 | | 110x200cm m. Cleartec | wit/helder | 249341120751001 | stuk | 2805,00 | 276 | 1 |
| 0977993 | | 110x200cm m. Cleartec | platinum/helder | 249341120751062 | stuk | 2957,00 | 276 | 1 |
| 1021028 | | 120x200cm | wit/helder | 249341220551001 | stuk | 2540,00 | 276 | 1 |
| 1021036 | | 120x200cm | platinum/helder | 249341220551062 | stuk | 2692,00 | 276 | 1 |
| Spoel- & installatiesystemen | 0978000 | 120x200cm m. Cleartec | wit/helder | 249341220751001 | stuk | 2844,00 | 276 | 1 |
| | 0978019 | 120x200cm m. Cleartec | platinum/helder | 249341220751062 | stuk | 2996,00 | 276 | 1 |
| | schuifdeur 2-delig voor nis | | | | | | | |
| Badkamermeubelen en toiletkasten | 1021044 | 120x200cm links | wit/helder | 248111221551001 | stuk | 1229,00 | 276 | 1 |
| | 1021052 | 120x200cm links | platinum/helder | 248111221551062 | stuk | 1280,00 | 276 | 1 |
| | 0978027 | 120x200cm links m. Cleartec | wit/helder | 248111221751001 | stuk | 1381,00 | 276 | 1 |
| | 0978035 | 120x200cm links m. Cleartec | platinum/helder | 248111221751062 | stuk | 1432,00 | 276 | 1 |
| Gootstenen en wastroggen | 1021060 | 120x200cm rechts | wit/helder | 248111222551001 | stuk | 1229,00 | 276 | 1 |
| | 1021079 | 120x200cm rechts | platinum/helder | 248111222551062 | stuk | 1280,00 | 276 | 1 |
| | 0978043 | 120x200cm rechts m. Cleartec | wit/helder | 248111222751001 | stuk | 1381,00 | 276 | 1 |
| | 0978051 | 120x200cm rechts m. Cleartec | platinum/helder | 248111222751062 | stuk | 1432,00 | 276 | 1 |
| Utiliteit | badschuifdeur 2-delig m. plafondsteun | | | | | | | |
| | 1021087 | 120x150cm links | wit/helder | 248181251551001 | stuk | 1182,00 | 276 | 1 |
| | 1021095 | 120x150cm links | platinum/helder | 248181251551062 | stuk | 1233,00 | 276 | 1 |
| | 0978078 | 120x150cm links m. Cleartec | wit/helder | 248181251751001 | stuk | 1334,00 | 276 | 1 |
| | 0978086 | 120x150cm links m. Cleartec | platinum/helder | 248181251751062 | stuk | 1385,00 | 276 | 1 |
| | 1021109 | 120x150cm rechts | wit/helder | 248181252551001 | stuk | 1182,00 | 276 | 1 |
| | 1021117 | 120x150cm rechts | platinum/helder | 248181252551062 | stuk | 1233,00 | 276 | 1 |
| | 0978094 | 120x150cm rechts m. Cleartec | wit/helder | 248181252751001 | stuk | 1334,00 | 276 | 1 |
| 0978108 | 120x150cm rechts m. Cleartec | platinum/helder | 248181252751062 | stuk | 1385,00 | 276 | 1 | |
| | schuifdeur voor hoekinstap (per zijde) | | | | | | | |
| | 1021435 | 120x200cm links | wit/helder | 248421220551001 | stuk | 1068,00 | 276 | 1 |
| | 1021451 | 120x200cm links | platinum/helder | 248421220551062 | stuk | 1121,00 | 276 | 1 |
| | 0123021 | 120x200cm links m. Cleartec | wit/helder | 248421220751001 | stuk | 1220,00 | 276 | 1 |
| | 0123048 | 120x200cm links m. Cleartec | platinum/helder | 248421220751062 | stuk | 1273,00 | 276 | 1 |
| | 1021443 | 120x200cm rechts | wit/helder | 248431220551001 | stuk | 1068,00 | 276 | 1 |
| | 1021478 | 120x200cm rechts | platinum/helder | 248431220551062 | stuk | 1121,00 | 276 | 1 |
| | 0123056 | 120x200cm rechts m. Cleartec | wit/helder | 248431220751001 | stuk | 1220,00 | 276 | 1 |
| 0123064 | 120x200cm rechts m. Cleartec | platinum/helder | 248431220751062 | stuk | 1273,00 | 276 | 1 | |

| Art.nr | Specificaties | Kleur | Lev.nr | Ehd | Prijs | Grp | CC |
|---|------------------------------|-------------------|-----------------|------|---------|-----|----|
| Duscholux Carat | | | | | | | |
| draaideur voor nis of met zijpaneel | | | | | | | |
| 7720637 | 80x190cm links | edelmat/helder | 288105091551070 | stuk | 804,00 | 276 | 1 |
| 7720638 | 80x190cm links | wit/helder | 288105091551001 | stuk | 913,00 | 276 | 1 |
| 7720639 | 80x190cm links | platzilver/helder | 288105091551062 | stuk | 1132,00 | 276 | 1 |
| 7720640 | 80x190cm links m. Cleartec | edelmat/helder | 288105091751070 | stuk | 956,00 | 276 | 1 |
| 7720641 | 80x190cm links m. Cleartec | wit/helder | 288105091751001 | stuk | 1065,00 | 276 | 1 |
| 7720642 | 80x190cm links m. Cleartec | platzilver/helder | 288105091751062 | stuk | 1284,00 | 276 | 1 |
| 7720643 | 80x190cm rechts | edelmat/helder | 288105092551070 | stuk | 804,00 | 276 | 1 |
| 7720644 | 80x190cm rechts | wit/helder | 288105092551001 | stuk | 913,00 | 276 | 1 |
| 7720645 | 80x190cm rechts | platzilver/helder | 288105092551062 | stuk | 1132,00 | 276 | 1 |
| 7720646 | 80x190cm rechts m. Cleartec | edelmat/helder | 288105092751070 | stuk | 956,00 | 276 | 1 |
| 7720647 | 80x190cm rechts m. Cleartec | wit/helder | 288105092751001 | stuk | 1065,00 | 276 | 1 |
| 7720648 | 80x190cm rechts m. Cleartec | platzilver/helder | 288105092751062 | stuk | 1284,00 | 276 | 1 |
| 7720649 | 90x190cm links | edelmat/helder | 288107091551070 | stuk | 804,00 | 276 | 1 |
| 7720650 | 90x190cm links | wit/helder | 288107091551001 | stuk | 913,00 | 276 | 1 |
| 7720651 | 90x190cm links | platzilver/helder | 288107091551062 | stuk | 1132,00 | 276 | 1 |
| 7720652 | 90x190cm links m. Cleartec | edelmat/helder | 288107091751070 | stuk | 956,00 | 276 | 1 |
| 7720653 | 90x190cm links m. Cleartec | wit/helder | 288107091751001 | stuk | 1065,00 | 276 | 1 |
| 7720654 | 90x190cm links m. Cleartec | platzilver/helder | 288107091751062 | stuk | 1284,00 | 276 | 1 |
| 7720655 | 90x190cm rechts | edelmat/helder | 288107092551070 | stuk | 804,00 | 276 | 1 |
| 7720656 | 90x190cm rechts | wit/helder | 288107092551001 | stuk | 913,00 | 276 | 1 |
| 7720657 | 90x190cm rechts | platzilver/helder | 288107092551062 | stuk | 1132,00 | 276 | 1 |
| 7720658 | 90x190cm rechts m. Cleartec | edelmat/helder | 288107092751070 | stuk | 956,00 | 276 | 1 |
| 7720659 | 90x190cm rechts m. Cleartec | wit/helder | 288107092751001 | stuk | 1065,00 | 276 | 1 |
| 7720660 | 90x190cm rechts m. Cleartec | platzilver/helder | 288107092751062 | stuk | 1284,00 | 276 | 1 |
| 7720661 | 100x190cm links | edelmat/helder | 288109091551070 | stuk | 848,00 | 276 | 1 |
| 7720662 | 100x190cm links | wit/helder | 288109091551001 | stuk | 957,00 | 276 | 1 |
| 7720663 | 100x190cm links | platzilver/helder | 288109091551062 | stuk | 1176,00 | 276 | 1 |
| 7720664 | 100x190cm links m. Cleartec | edelmat/helder | 288109091751070 | stuk | 1000,00 | 276 | 1 |
| 7720665 | 100x190cm links m. Cleartec | wit/helder | 288109091751001 | stuk | 1109,00 | 276 | 1 |
| 7720666 | 100x190cm links m. Cleartec | platzilver/helder | 288109091751062 | stuk | 1328,00 | 276 | 1 |
| 7720667 | 100x190cm rechts | edelmat/helder | 288109092551070 | stuk | 848,00 | 276 | 1 |
| 7720668 | 100x190cm rechts | wit/helder | 288109092551001 | stuk | 957,00 | 276 | 1 |
| 7720669 | 100x190cm rechts | platzilver/helder | 288109092551062 | stuk | 1176,00 | 276 | 1 |
| 7720670 | 100x190cm rechts m. Cleartec | edelmat/helder | 288109092751070 | stuk | 1000,00 | 276 | 1 |
| 7720671 | 100x190cm rechts m. Cleartec | wit/helder | 288109092751001 | stuk | 1109,00 | 276 | 1 |
| 7720672 | 100x190cm rechts m. Cleartec | platzilver/helder | 288109092751062 | stuk | 1328,00 | 276 | 1 |
| pendeldeur voor nis of met zijpaneel | | | | | | | |
| 7720673 | 80x190cm | edelmat/helder | 289105090551070 | stuk | 911,00 | 276 | 1 |
| 7720674 | 80x190cm | wit/helder | 289105090551001 | stuk | 1020,00 | 276 | 1 |
| 7720675 | 80x190cm | platzilver/helder | 289105090551062 | stuk | 1294,00 | 276 | 1 |
| 7720676 | 80x190cm m. Cleartec | edelmat/helder | 289105090751070 | stuk | 1063,00 | 276 | 1 |
| 7720677 | 80x190cm m. Cleartec | wit/helder | 289105090751001 | stuk | 1172,00 | 276 | 1 |
| 7720678 | 80x190cm m. Cleartec | platzilver/helder | 289105090751062 | stuk | 1446,00 | 276 | 1 |
| 7720679 | 90x190cm | edelmat/helder | 289107090551070 | stuk | 911,00 | 276 | 1 |
| 7720680 | 90x190cm | wit/helder | 289107090551001 | stuk | 1020,00 | 276 | 1 |
| 7720681 | 90x190cm | platzilver/helder | 289107090551062 | stuk | 1294,00 | 276 | 1 |
| 7720682 | 90x190cm m. Cleartec | edelmat/helder | 289107090751070 | stuk | 1063,00 | 276 | 1 |
| 7720683 | 90x190cm m. Cleartec | wit/helder | 289107090751001 | stuk | 1172,00 | 276 | 1 |
| 7720684 | 90x190cm m. Cleartec | platzilver/helder | 289107090751062 | stuk | 1446,00 | 276 | 1 |
| 7720685 | 100x190cm | edelmat/helder | 289109090551070 | stuk | 952,00 | 276 | 1 |
| 7720686 | 100x190cm | wit/helder | 289109090551001 | stuk | 1061,00 | 276 | 1 |
| 7720687 | 100x190cm | platzilver/helder | 289109090551062 | stuk | 1335,00 | 276 | 1 |
| 7720688 | 100x190cm m. Cleartec | edelmat/helder | 289109090751070 | stuk | 1104,00 | 276 | 1 |
| 7720689 | 100x190cm m. Cleartec | wit/helder | 289109090751001 | stuk | 1213,00 | 276 | 1 |
| 7720690 | 100x190cm m. Cleartec | platzilver/helder | 289109090751062 | stuk | 1487,00 | 276 | 1 |
| 7720691 | 120x190cm | edelmat/helder | 289101290551070 | stuk | 1071,00 | 276 | 1 |
| 7720692 | 120x190cm | wit/helder | 289101290551001 | stuk | 1180,00 | 276 | 1 |
| 7720693 | 120x190cm | platzilver/helder | 289101290551062 | stuk | 1454,00 | 276 | 1 |
| 7720694 | 120x190cm m. Cleartec | edelmat/helder | 289101290751070 | stuk | 1223,00 | 276 | 1 |
| 7720695 | 120x190cm m. Cleartec | wit/helder | 289101290751001 | stuk | 1332,00 | 276 | 1 |
| 7720696 | 120x190cm m. Cleartec | platzilver/helder | 289101290751062 | stuk | 1606,00 | 276 | 1 |



Sanitair producten

Baden /
douchebakken /
stoomcabines

Kranen

Douchegarnituur

Accessoires en
spiegels

Douchewanden

Toebehoren &
afvoeren

Spoel- &
installatiesystemen

Badkamermeubelen
en toiletkasten

Gootstenen en
wastroggen

Utiliteit

| Art.nr | Specificaties | Kleur | Lev.nr | Ehd | Prijs | Grp | CC |
|---|---|-----------|-------------------------------|-----------------|-------|---------|-------|
| Duscholux Carat | | | | | | | |
| schuifdeur 3-delig voor nis of met zijpaneel | | | | | | | |
| Sanitair producten | 7720697 | 90x190cm | edelmat/helder | 291107090551070 | stuk | 857,00 | 276 1 |
| | 7720698 | 90x190cm | wit/helder | 291107090551001 | stuk | 966,00 | 276 1 |
| | 7720699 | 90x190cm | platzilver/helder | 291107090551062 | stuk | 1185,00 | 276 1 |
| | 7720700 | 90x190cm | m. Cleartec edelmat/helder | 291107090751070 | stuk | 1009,00 | 276 1 |
| Baden / douchebakken / stoomcabines | 7720701 | 90x190cm | m. Cleartec wit/helder | 291107090751001 | stuk | 1118,00 | 276 1 |
| | 7720702 | 90x190cm | m. Cleartec platzilver/helder | 291107090751062 | stuk | 1337,00 | 276 1 |
| | 7720703 | 100x190cm | edelmat/helder | 291109090551070 | stuk | 884,00 | 276 1 |
| | 7720704 | 100x190cm | wit/helder | 291109090551001 | stuk | 993,00 | 276 1 |
| Kranen | 7720705 | 100x190cm | platzilver/helder | 291109090551062 | stuk | 1212,00 | 276 1 |
| | 7720706 | 100x190cm | m. Cleartec edelmat/helder | 291109090751070 | stuk | 1036,00 | 276 1 |
| | 7720707 | 100x190cm | m. Cleartec wit/helder | 291109090751001 | stuk | 1145,00 | 276 1 |
| | 7720708 | 100x190cm | m. Cleartec platzilver/helder | 291109090751062 | stuk | 1364,00 | 276 1 |
| Douchegarnituur | 7720709 | 120x190cm | edelmat/helder | 291101290551070 | stuk | 988,00 | 276 1 |
| | 7720710 | 120x190cm | wit/helder | 291101290551001 | stuk | 1097,00 | 276 1 |
| | 7720711 | 120x190cm | platzilver/helder | 291101290551062 | stuk | 1316,00 | 276 1 |
| | 7720712 | 120x190cm | m. Cleartec edelmat/helder | 291101290751070 | stuk | 1140,00 | 276 1 |
| Accessoires en spiegels | 7720713 | 120x190cm | m. Cleartec wit/helder | 291101290751001 | stuk | 1249,00 | 276 1 |
| | 7720714 | 120x190cm | m. Cleartec platzilver/helder | 291101290751062 | stuk | 1468,00 | 276 1 |
| | vouwdeur voor nis of met zijpaneel | | | | | | |
| Douchewanden | 7720715 | 90x190cm | edelmat/helder | 290107090551070 | stuk | 911,00 | 276 1 |
| | 7720716 | 90x190cm | wit/helder | 290107090551001 | stuk | 1020,00 | 276 1 |
| | 7720717 | 90x190cm | platzilver/helder | 290107090551062 | stuk | 1294,00 | 276 1 |
| | 7720718 | 90x190cm | m. Cleartec edelmat/helder | 290107090751070 | stuk | 1063,00 | 276 1 |
| | 7720719 | 90x190cm | m. Cleartec wit/helder | 290107090751001 | stuk | 1172,00 | 276 1 |
| | 7720720 | 90x190cm | m. Cleartec platzilver/helder | 290107090751062 | stuk | 1446,00 | 276 1 |
| | 7720721 | 100x190cm | edelmat/helder | 290109090551070 | stuk | 988,00 | 276 1 |
| | 7720722 | 100x190cm | wit/helder | 290109090551001 | stuk | 1097,00 | 276 1 |
| | 7720723 | 100x190cm | platzilver/helder | 290109090551062 | stuk | 1371,00 | 276 1 |
| | 7720724 | 100x190cm | m. Cleartec edelmat/helder | 290109090751070 | stuk | 1140,00 | 276 1 |
| Toebehoren & afvoeren | 7720725 | 100x190cm | m. Cleartec wit/helder | 290109090751001 | stuk | 1249,00 | 276 1 |
| | 7720726 | 100x190cm | m. Cleartec platzilver/helder | 290109090751062 | stuk | 1523,00 | 276 1 |
| | zijwand | | | | | | |
| Spoel- & installatiesystemen | 7720727 | 80x190cm | edelmat/helder | 291205090551070 | stuk | 401,00 | 276 1 |
| | 7720728 | 80x190cm | wit/helder | 291205090551001 | stuk | 510,00 | 276 1 |
| | 7720729 | 80x190cm | platzilver/helder | 291205090551062 | stuk | 565,00 | 276 1 |
| | 7720730 | 80x190cm | m. Cleartec edelmat/helder | 291205090751070 | stuk | 553,00 | 276 1 |
| Badkamermeubelen en toiletkasten | 7720731 | 80x190cm | m. Cleartec wit/helder | 291205090751001 | stuk | 662,00 | 276 1 |
| | 7720732 | 80x190cm | m. Cleartec platzilver/helder | 291205090751062 | stuk | 717,00 | 276 1 |
| | 7720733 | 90x190cm | edelmat/helder | 291207090551070 | stuk | 401,00 | 276 1 |
| | 7720734 | 90x190cm | wit/helder | 291207090551001 | stuk | 510,00 | 276 1 |
| Gootstenen en wastroggen | 7720735 | 90x190cm | platzilver/helder | 291207090551062 | stuk | 565,00 | 276 1 |
| | 7720736 | 90x190cm | m. Cleartec edelmat/helder | 291207090751070 | stuk | 553,00 | 276 1 |
| | 7720737 | 90x190cm | m. Cleartec wit/helder | 291207090751001 | stuk | 662,00 | 276 1 |
| | 7720738 | 90x190cm | m. Cleartec platzilver/helder | 291207090751062 | stuk | 717,00 | 276 1 |
| Utiliteit | 7720739 | 100x190cm | edelmat/helder | 291209090551070 | stuk | 411,00 | 276 1 |
| | 7720740 | 100x190cm | wit/helder | 291209090551001 | stuk | 520,00 | 276 1 |
| | 7720741 | 100x190cm | platzilver/helder | 291209090551062 | stuk | 575,00 | 276 1 |
| | 7720742 | 100x190cm | m. Cleartec edelmat/helder | 291209090751070 | stuk | 563,00 | 276 1 |
| | 7720743 | 100x190cm | m. Cleartec wit/helder | 291209090751001 | stuk | 672,00 | 276 1 |
| | 7720744 | 100x190cm | m. Cleartec platzilver/helder | 291209090751062 | stuk | 727,00 | 276 1 |

| Art.nr | Specificaties | Kleur | Lev.nr | Ehd | Prijs | Grp | CC |
|---|---------------|--------------------|-------------------|-----------------|-------|---------|-------|
| Duscholux Carat | | | | | | | |
| schuifdeur 2-delig voor hoekinstap (per zijde) | | | | | | | |
| 7720746 | 90x190cm | links | edelmat/helder | 291427090551070 | stuk | 643,00 | 276 1 |
| 7720749 | 90x190cm | links | wit/helder | 291427090551001 | stuk | 752,00 | 276 1 |
| 7720752 | 90x190cm | links | platzilver/helder | 291427090551062 | stuk | 943,00 | 276 1 |
| 7720755 | 90x190cm | links m. Cleartec | edelmat/helder | 291427090751070 | stuk | 795,00 | 276 1 |
| 7720758 | 90x190cm | links m. Cleartec | wit/helder | 291427090751001 | stuk | 904,00 | 276 1 |
| 7720761 | 90x190cm | links m. Cleartec | platzilver/helder | 291427090751062 | stuk | 1095,00 | 276 1 |
| 7720764 | 100x190cm | links | edelmat/helder | 291429090551070 | stuk | 750,00 | 276 1 |
| 7720767 | 100x190cm | links | wit/helder | 291429090551001 | stuk | 859,00 | 276 1 |
| 7720770 | 100x190cm | links | platzilver/helder | 291429090551062 | stuk | 1050,00 | 276 1 |
| 7720773 | 100x190cm | links m. Cleartec | edelmat/helder | 291429090751070 | stuk | 902,00 | 276 1 |
| 7720776 | 100x190cm | links m. Cleartec | wit/helder | 291429090751001 | stuk | 1011,00 | 276 1 |
| 7720779 | 100x190cm | links m. Cleartec | platzilver/helder | 291429090751062 | stuk | 1202,00 | 276 1 |
| 7720747 | 90x190cm | rechts | edelmat/helder | 291437090551070 | stuk | 643,00 | 276 1 |
| 7720750 | 90x190cm | rechts | wit/helder | 291437090551001 | stuk | 752,00 | 276 1 |
| 7720753 | 90x190cm | rechts | platzilver/helder | 291437090551062 | stuk | 943,00 | 276 1 |
| 7720756 | 90x190cm | rechts m. Cleartec | edelmat/helder | 291437090751070 | stuk | 795,00 | 276 1 |
| 7720759 | 90x190cm | rechts m. Cleartec | wit/helder | 291437090751001 | stuk | 904,00 | 276 1 |
| 7720762 | 90x190cm | rechts m. Cleartec | platzilver/helder | 291437090751062 | stuk | 1095,00 | 276 1 |
| 7720765 | 100x190cm | rechts | edelmat/helder | 291439090551070 | stuk | 750,00 | 276 1 |
| 7720768 | 100x190cm | rechts | wit/helder | 291439090551001 | stuk | 859,00 | 276 1 |
| 7720771 | 100x190cm | rechts | platzilver/helder | 291439090551062 | stuk | 1050,00 | 276 1 |
| 7720777 | 100x190cm | rechts m. Cleartec | wit/helder | 291439090751001 | stuk | 1011,00 | 276 1 |
| 7720774 | 100x190cm | rechts m. Cleartec | edelmat/helder | 291439090751070 | stuk | 902,00 | 276 1 |
| 7720780 | 100x190cm | rechts m. Cleartec | platzilver/helder | 291439090751062 | stuk | 1202,00 | 276 1 |

douchecabine hoekinstap 2-delig m. 2 schuifdeuren compleet

| | | | | | | | |
|---------|-----------|-------------|-------------------|-------|------|---------|-------|
| 7720745 | 90x190cm | | edelmat/helder | CARAT | stuk | 1286,00 | 276 1 |
| 7720748 | 90x190cm | | wit/helder | CARAT | stuk | 1504,00 | 276 1 |
| 7720751 | 90x190cm | | platzilver/helder | CARAT | stuk | 1886,00 | 276 1 |
| 7720754 | 90x190cm | m. Cleartec | edelmat/helder | CARAT | stuk | 1590,00 | 276 1 |
| 7720757 | 90x190cm | m. Cleartec | wit/helder | CARAT | stuk | 1808,00 | 276 1 |
| 7720760 | 90x190cm | m. Cleartec | platzilver/helder | CARAT | stuk | 2190,00 | 276 1 |
| 7720763 | 100x190cm | | edelmat/helder | CARAT | stuk | 1500,00 | 276 1 |
| 7720766 | 100x190cm | | wit/helder | CARAT | stuk | 1718,00 | 276 1 |
| 7720769 | 100x190cm | | platzilver/helder | CARAT | stuk | 2100,00 | 276 1 |
| 7720772 | 100x190cm | m. Cleartec | edelmat/helder | CARAT | stuk | 1804,00 | 276 1 |
| 7720775 | 100x190cm | m. Cleartec | wit/helder | CARAT | stuk | 2022,00 | 276 1 |
| 7720778 | 100x190cm | m. Cleartec | platzilver/helder | CARAT | stuk | 2404,00 | 276 1 |

schuifdeur 3-delig voor hoekinstap (per zijde)

| | | | | | | | |
|---------|-----------|--------------------|-------------------|-----------------|------|---------|-------|
| 7720782 | 90x190cm | links | edelmat/helder | 291627090551070 | stuk | 750,00 | 276 1 |
| 7720785 | 90x190cm | links | wit/helder | 291627090551001 | stuk | 859,00 | 276 1 |
| 7720788 | 90x190cm | links | platzilver/helder | 291627090551062 | stuk | 1133,00 | 276 1 |
| 7720791 | 90x190cm | links m. Cleartec | edelmat/helder | 291627090751070 | stuk | 902,00 | 276 1 |
| 7720794 | 90x190cm | links m. Cleartec | wit/helder | 291627090751001 | stuk | 1011,00 | 276 1 |
| 7720797 | 90x190cm | links m. Cleartec | platzilver/helder | 291627090751062 | stuk | 1285,00 | 276 1 |
| 7720800 | 100x190cm | links | edelmat/helder | 291629090551070 | stuk | 857,00 | 276 1 |
| 7720803 | 100x190cm | links | wit/helder | 291629090551001 | stuk | 966,00 | 276 1 |
| 7720806 | 100x190cm | links | platzilver/helder | 291629090551062 | stuk | 1240,00 | 276 1 |
| 7720809 | 100x190cm | links m. Cleartec | edelmat/helder | 291629090751070 | stuk | 1009,00 | 276 1 |
| 7720812 | 100x190cm | links m. Cleartec | wit/helder | 291629090751001 | stuk | 1118,00 | 276 1 |
| 7720815 | 100x190cm | links m. Cleartec | platzilver/helder | 291629090751062 | stuk | 1392,00 | 276 1 |
| 7720783 | 90x190cm | rechts | edelmat/helder | 291637090551070 | stuk | 750,00 | 276 1 |
| 7720786 | 90x190cm | rechts | wit/helder | 291637090551001 | stuk | 859,00 | 276 1 |
| 7720789 | 90x190cm | rechts | platzilver/helder | 291637090551062 | stuk | 1133,00 | 276 1 |
| 7720792 | 90x190cm | rechts m. Cleartec | edelmat/helder | 291637090751070 | stuk | 902,00 | 276 1 |
| 7720795 | 90x190cm | rechts m. Cleartec | wit/helder | 291637090751001 | stuk | 1011,00 | 276 1 |
| 7720798 | 90x190cm | rechts m. Cleartec | platzilver/helder | 291637090751062 | stuk | 1285,00 | 276 1 |
| 7720801 | 100x190cm | rechts | edelmat/helder | 291639090551070 | stuk | 857,00 | 276 1 |
| 7720804 | 100x190cm | rechts | wit/helder | 291639090551001 | stuk | 966,00 | 276 1 |
| 7720807 | 100x190cm | rechts | platzilver/helder | 291639090551062 | stuk | 1240,00 | 276 1 |
| 7720810 | 100x190cm | rechts m. Cleartec | edelmat/helder | 291639090751070 | stuk | 1009,00 | 276 1 |
| 7720813 | 100x190cm | rechts m. Cleartec | wit/helder | 291639090751001 | stuk | 1118,00 | 276 1 |
| 7720816 | 100x190cm | rechts m. Cleartec | platzilver/helder | 291639090751062 | stuk | 1392,00 | 276 1 |



Sanitair producten

Baden /
douchebakken /
stoomcabines

Kranen

Douchegarnituur

Accessoires en
spiegels

Douchewanden

Toebehoren &
afvoeren

Spoel- &
installatiesystemen

Badkamermeubelen
en toiletkasten

Gootstenen en
wastroggen

Utiliteit

| | Art.nr | Specificaties | Kleur | Lev.nr | Ehd | Prijs | Grp | CC | |
|---|--|------------------------------|-------------------|-----------------|---------|---------|-----|----|--|
| Duscholux Carat | | | | | | | | | |
| douchecabine hoekinstap 3-delig m. 2 schuifdeuren compleet | | | | | | | | | |
| Sanitair producten | 7720781 | 90x190cm | edelmat/helder | CARAT | stuk | 1500,00 | 276 | 1 | |
| | 7720784 | 90x190cm | wit/helder | CARAT | stuk | 1718,00 | 276 | 1 | |
| | 7720787 | 90x190cm | platzilver/helder | CARAT | stuk | 2266,00 | 276 | 1 | |
| Baden / douchebakken / stoomcabines | 7720790 | 90x190cm m. Cleartec | edelmat/helder | CARAT | stuk | 1804,00 | 276 | 1 | |
| | 7720793 | 90x190cm m. Cleartec | wit/helder | CARAT | stuk | 2022,00 | 276 | 1 | |
| | 7720796 | 90x190cm m. Cleartec | platzilver/helder | CARAT | stuk | 2570,00 | 276 | 1 | |
| | 7720799 | 100x190cm | edelmat/helder | CARAT | stuk | 1714,00 | 276 | 1 | |
| | 7720802 | 100x190cm | wit/helder | CARAT | stuk | 1932,00 | 276 | 1 | |
| Kranen | 7720805 | 100x190cm | platzilver/helder | CARAT | stuk | 2480,00 | 276 | 1 | |
| | 7720808 | 100x190cm m. Cleartec | edelmat/helder | CARAT | stuk | 2018,00 | 276 | 1 | |
| | 7720811 | 100x190cm m. Cleartec | wit/helder | CARAT | stuk | 2236,00 | 276 | 1 | |
| | 7720814 | 100x190cm m. Cleartec | platzilver/helder | CARAT | stuk | 2784,00 | 276 | 1 | |
| Douchegarnituur | douchecabine vijfhoekig m. draaideur | | | | | | | | |
| | 7720817 | 90x190cm links | edelmat/helder | 296500191551070 | stuk | 1345,00 | 276 | 1 | |
| | 7720818 | 90x190cm links | wit/helder | 296500191551001 | stuk | 1509,00 | 276 | 1 | |
| Accessoires en spiegels | 7720819 | 90x190cm links | platzilver/helder | 296500191551062 | stuk | 1782,00 | 276 | 1 | |
| | 7720823 | 90x190cm links m. Cleartec | edelmat/helder | 296500191751070 | stuk | 1649,00 | 276 | 1 | |
| | 7720824 | 90x190cm links m. Cleartec | wit/helder | 296500191751001 | stuk | 1813,00 | 276 | 1 | |
| | 7720825 | 90x190cm links m. Cleartec | platzilver/helder | 296500191751062 | stuk | 2086,00 | 276 | 1 | |
| | 7720829 | 100x190cm links | edelmat/helder | 296600191551070 | stuk | 1503,00 | 276 | 1 | |
| Douchewanden | 7720830 | 100x190cm links | wit/helder | 296600191551001 | stuk | 1667,00 | 276 | 1 | |
| | 7720831 | 100x190cm links | platzilver/helder | 296600191551062 | stuk | 1940,00 | 276 | 1 | |
| | 7720835 | 100x190cm links m. Cleartec | edelmat/helder | 296600191751070 | stuk | 1807,00 | 276 | 1 | |
| | 7720836 | 100x190cm links m. Cleartec | wit/helder | 296600191751001 | stuk | 1971,00 | 276 | 1 | |
| | 7720837 | 100x190cm links m. Cleartec | platzilver/helder | 296600191751062 | stuk | 2244,00 | 276 | 1 | |
| | 7720820 | 90x190cm rechts | edelmat/helder | 296500192551070 | stuk | 1345,00 | 276 | 1 | |
| | 7720821 | 90x190cm rechts | wit/helder | 296500192551001 | stuk | 1509,00 | 276 | 1 | |
| | 7720822 | 90x190cm rechts | platzilver/helder | 296500192551062 | stuk | 1782,00 | 276 | 1 | |
| | 7720826 | 90x190cm rechts m. Cleartec | edelmat/helder | 296500192751070 | stuk | 1649,00 | 276 | 1 | |
| | 7720827 | 90x190cm rechts m. Cleartec | wit/helder | 296500192751001 | stuk | 1813,00 | 276 | 1 | |
| Toebehoren & afvoeren | 7720828 | 90x190cm rechts m. Cleartec | platzilver/helder | 296500192751062 | stuk | 2086,00 | 276 | 1 | |
| | 7720832 | 100x190cm rechts | edelmat/helder | 296600192551070 | stuk | 1503,00 | 276 | 1 | |
| | 7720833 | 100x190cm rechts | wit/helder | 296600192551001 | stuk | 1667,00 | 276 | 1 | |
| | 7720834 | 100x190cm rechts | platzilver/helder | 296600192551062 | stuk | 1940,00 | 276 | 1 | |
| Spool- & installatiesystemen | 7720838 | 100x190cm rechts m. Cleartec | edelmat/helder | 296600192751070 | stuk | 1807,00 | 276 | 1 | |
| | 7720839 | 100x190cm rechts m. Cleartec | wit/helder | 296600192751001 | stuk | 1971,00 | 276 | 1 | |
| | 7720840 | 100x190cm rechts m. Cleartec | platzilver/helder | 296600192751062 | stuk | 2244,00 | 276 | 1 | |
| | douchecabine kwart rond m. draaideur | | | | | | | | |
| Gootstenen en wastroggen | 7720841 | 90x190cm links | edelmat/helder | 292500191551070 | stuk | 1463,00 | 276 | 1 | |
| | 7720842 | 90x190cm links | wit/helder | 292500191551001 | stuk | 1627,00 | 276 | 1 | |
| | 7720843 | 90x190cm links | platzilver/helder | 292500191551062 | stuk | 2064,00 | 276 | 1 | |
| | 7720844 | 90x190cm rechts | edelmat/helder | 292500192551070 | stuk | 1463,00 | 276 | 1 | |
| | 7720845 | 90x190cm rechts | wit/helder | 292500192551001 | stuk | 1627,00 | 276 | 1 | |
| | 7720846 | 90x190cm rechts | platzilver/helder | 292500192551062 | stuk | 2064,00 | 276 | 1 | |
| | 7720847 | 90x190cm links m. Cleartec | edelmat/helder | 292500191751070 | stuk | 1767,00 | 276 | 1 | |
| Utiliteit | 7720848 | 90x190cm links m. Cleartec | wit/helder | 292500191751001 | stuk | 1931,00 | 276 | 1 | |
| | 7720849 | 90x190cm links m. Cleartec | platzilver/helder | 292500191751062 | stuk | 2368,00 | 276 | 1 | |
| | 7720850 | 90x190cm rechts m. Cleartec | edelmat/helder | 292500192751070 | stuk | 1767,00 | 276 | 1 | |
| | 7720851 | 90x190cm rechts m. Cleartec | wit/helder | 292500192751001 | stuk | 1931,00 | 276 | 1 | |
| | 7720852 | 90x190cm rechts m. Cleartec | platzilver/helder | 292500192751062 | stuk | 2368,00 | 276 | 1 | |
| Badkamermeubelen en toiletkasten | douchecabine kwart rond m. 2 pendeldeuren | | | | | | | | |
| | 7720853 | 90x190cm | edelmat/helder | 294500190551070 | stuk | 1563,00 | 276 | 1 | |
| | 7720854 | 90x190cm | wit/helder | 294500190551001 | stuk | 1727,00 | 276 | 1 | |
| | 7720855 | 90x190cm | platzilver/helder | 294500190551062 | stuk | 2164,00 | 276 | 1 | |
| | 7720856 | 90x190cm m. Cleartec | edelmat/helder | 294500190751070 | stuk | 1867,00 | 276 | 1 | |
| | 7720857 | 90x190cm m. Cleartec | wit/helder | 294500190751001 | stuk | 2031,00 | 276 | 1 | |
| 7720858 | 90x190cm m. Cleartec | platzilver/helder | 294500190751062 | stuk | 2468,00 | 276 | 1 | | |
| douchecabine kwart rond m. 2 schuifdeuren | | | | | | | | | |
| | 7720859 | 90x190cm | edelmat/helder | 295500190551070 | stuk | 1404,00 | 276 | 1 | |
| | 7720860 | 90x190cm | wit/helder | 295500190551001 | stuk | 1639,00 | 276 | 1 | |
| | 7720861 | 90x190cm | platzilver/helder | 295500190551062 | stuk | 2005,00 | 276 | 1 | |
| | 7720862 | 90x190cm m. Cleartec | edelmat/helder | 295500190751070 | stuk | 1708,00 | 276 | 1 | |
| | 7720863 | 90x190cm m. Cleartec | wit/helder | 295500190751001 | stuk | 1943,00 | 276 | 1 | |
| | 7720864 | 90x190cm m. Cleartec | platzilver/helder | 295500190751062 | stuk | 2309,00 | 276 | 1 | |

| Art.nr | Specificaties | Kleur | Lev.nr | Ehd | Prijs | Grp | CC |
|---|------------------|-----------------|-----------------|------|---------|-----|----|
| Duscholux Duschosmart | | | | | | | |
| schuifdeur 3-delig voor nis of zijpaneel | | | | | | | |
| 0986706 | 75x185cm | wit/helder | 271104080551001 | stuk | 440,00 | 276 | 1 |
| 0986705 | 75x185cm | edelmat/helder | 271104080551070 | stuk | 406,00 | 276 | 1 |
| 0986708 | 80x185cm | wit/helder | 271105080551001 | stuk | 444,00 | 276 | 1 |
| 0986707 | 80x185cm | edelmat/helder | 271105080551070 | stuk | 410,00 | 276 | 1 |
| 0986710 | 90x185cm | wit/helder | 271107080551001 | stuk | 457,00 | 276 | 1 |
| 0986709 | 90x185cm | edelmat/helder | 271107080551070 | stuk | 423,00 | 276 | 1 |
| 0986713 | 100x185cm | wit/helder | 271109080551001 | stuk | 475,00 | 276 | 1 |
| 0986711 | 100x185cm | edelmat/helder | 271109080551070 | stuk | 441,00 | 276 | 1 |
| schuifdeur 2-delig voor hoekinstap (per zijde) | | | | | | | |
| 0986721 | 80x185cm links | wit/helder | 271425080551001 | stuk | 304,00 | 276 | 1 |
| 0986714 | 80x185cm links | edelmat/helder | 271425080551070 | stuk | 270,00 | 276 | 1 |
| 0986723 | 90x185cm links | wit/helder glas | 271427080551001 | stuk | 310,00 | 276 | 1 |
| 0986716 | 90x185cm links | edelmat/helder | 271427080551070 | stuk | 276,00 | 276 | 1 |
| 0986726 | 100x185cm links | wit/helder | 271429080551001 | stuk | 323,00 | 276 | 1 |
| 0986718 | 100x185cm links | edelmat/helder | 271429080551070 | stuk | 289,00 | 276 | 1 |
| 0986722 | 80x185cm rechts | wit/helder | 271435080551001 | stuk | 304,00 | 276 | 1 |
| 0986715 | 80x185cm rechts | edelmat/helder | 271435080551070 | stuk | 270,00 | 276 | 1 |
| 0986724 | 90x185cm rechts | wit/helder | 271437080551001 | stuk | 310,00 | 276 | 1 |
| 0986717 | 90x185cm rechts | edelmat/helder | 271437080551070 | stuk | 276,00 | 276 | 1 |
| 0986728 | 100x185cm rechts | wit/helder | 271439080551001 | stuk | 323,00 | 276 | 1 |
| 0986719 | 100x185cm rechts | edelmat/helder | 271439080551070 | stuk | 289,00 | 276 | 1 |
| schuifdeur 3-delig voor hoekinstap (per zijde) | | | | | | | |
| 0986735 | 80x185cm links | wit/helder | 271625080551001 | stuk | 347,00 | 276 | 1 |
| 0986729 | 80x185cm links | edelmat/helder | 271625080551070 | stuk | 313,00 | 276 | 1 |
| 0986737 | 90x185cm links | wit/helder | 271627080551001 | stuk | 356,00 | 276 | 1 |
| 0986731 | 90x185cm links | edelmat/helder | 271627080551070 | stuk | 322,00 | 276 | 1 |
| 0986740 | 100x185cm links | wit/helder | 271629080551001 | stuk | 370,00 | 276 | 1 |
| 0986733 | 100x185cm links | edelmat/helder | 271629080551070 | stuk | 336,00 | 276 | 1 |
| 0986736 | 80x185cm rechts | wit/helder | 271635080551001 | stuk | 347,00 | 276 | 1 |
| 0986730 | 80x185cm rechts | edelmat/helder | 271635080551070 | stuk | 313,00 | 276 | 1 |
| 0986738 | 90x185cm rechts | wit/helder | 271637080551001 | stuk | 356,00 | 276 | 1 |
| 0986732 | 90x185cm rechts | edelmat/helder | 271637080551070 | stuk | 322,00 | 276 | 1 |
| 0986741 | 100x185cm rechts | wit/helder | 271639080551001 | stuk | 370,00 | 276 | 1 |
| 0986734 | 100x185cm rechts | edelmat/helder | 271639080551070 | stuk | 336,00 | 276 | 1 |
| zijpaneel | | | | | | | |
| 0986743 | 80x185cm | wit/helder | 271205080551001 | stuk | 226,00 | 276 | 1 |
| 0986742 | 80x185cm | edelmat/helder | 271205080551070 | stuk | 192,00 | 276 | 1 |
| 0986745 | 90x185cm | wit/helder | 271207080551001 | stuk | 233,00 | 276 | 1 |
| 0986744 | 90x185cm | edelmat/helder | 271207080551070 | stuk | 199,00 | 276 | 1 |
| verkort zijpaneel m. sokkelprofiel | | | | | | | |
| 0986748 | 80x160cm | wit/helder | 271215060551001 | stuk | 226,00 | 276 | 1 |
| 0986746 | 80x160cm | edelmat/helder | 271215060551070 | stuk | 192,00 | 276 | 1 |
| 0986751 | 90x160cm | wit/helder | 271217060551001 | stuk | 233,00 | 276 | 1 |
| 0986749 | 90x160cm | edelmat/helder | 271217060551070 | stuk | 199,00 | 276 | 1 |
| douchecabine kwartrond m. schuifdeuren | | | | | | | |
| 0986753 | 90x185cm | wit/helder | 272500190551001 | stuk | 1270,00 | 276 | 1 |
| 0986752 | 90x185cm | edelmat/helder | 272500190551070 | stuk | 1180,00 | 276 | 1 |

Duscholux DuschoStar

| | | | | | | | |
|-------------------------------------|------------------------------|-----------------|-----------------|------|---------|-----|---|
| draaideur voor nis scharnier | | | | | | | |
| 0982695 | 90x190cm rechts | platinum/helder | 184117012551062 | stuk | 895,00 | 276 | 1 |
| 0996467 | 90x190cm rechts | edelmat/helder | 184117012551070 | stuk | 776,00 | 276 | 1 |
| 0978191 | 90x190cm rechts m. Cleartec | platinum/helder | 184117012751062 | stuk | 1047,00 | 276 | 1 |
| 0978205 | 90x190cm rechts m. Cleartec | edelmat/helder | 184117012751070 | stuk | 928,00 | 276 | 1 |
| 0982687 | 90x190cm links | platinum/helder | 184117011551062 | stuk | 895,00 | 276 | 1 |
| 0996483 | 90x190cm links | edelmat/helder | 184117011551070 | stuk | 776,00 | 276 | 1 |
| 0978175 | 90x190cm links m. Cleartec | platinum/helder | 184117011751062 | stuk | 1047,00 | 276 | 1 |
| 0978183 | 90x190cm links m. Cleartec | edelmat/helder | 184117011751070 | stuk | 928,00 | 276 | 1 |
| 0987441 | 100x190cm rechts | platinum/helder | 184119012551062 | stuk | 975,00 | 276 | 1 |
| 0996459 | 100x190cm rechts | edelmat/helder | 184119012551070 | stuk | 856,00 | 276 | 1 |
| 0978248 | 100x190cm rechts m. Cleartec | platinum/helder | 184119012751062 | stuk | 1127,00 | 276 | 1 |
| 0978256 | 100x190cm rechts m. Cleartec | edelmat/helder | 184119012751070 | stuk | 1008,00 | 276 | 1 |
| 0987433 | 100x190cm links | platinum/helder | 184119011551062 | stuk | 975,00 | 276 | 1 |
| 0996475 | 100x190cm links | edelmat/helder | 184119011551070 | stuk | 856,00 | 276 | 1 |
| 0978213 | 100x190cm links m. Cleartec | platinum/helder | 184119011751062 | stuk | 1127,00 | 276 | 1 |
| 0978221 | 100x190cm links m. Cleartec | edelmat/helder | 184119011751070 | stuk | 1008,00 | 276 | 1 |



Sanitair producten

Baden /
douchebakken /
stoomcabines

Kranen

Douchegarnituur







Accessoires en
spiegels

Douchewanden

Toebehoren &
afvoerenSpoel- &
installatiesystemenBadkamermeubelen
en toiletkastenGootstenen en
wastroggen

Utiliteit

| | Art.nr | Specificaties | Kleur | Lev.nr | Ehd | Prijs | Grp | CC |
|---|--|-----------------------------|-----------------|---------------------|---------|---------|-----|----|
| | Duscholux Duschostar | | | | | | | |
| Sanitair producten | draaideur voor zijpaneel scharnier | | | | | | | |
| | 0982725 | 90x190cm rechts | platinum/helder | 184147012551062 | stuk | 844,00 | 276 | 1 |
| | 0996491 | 90x190cm rechts | edelmat/helder | 184147012551070 | stuk | 735,00 | 276 | 1 |
| | 0978280 | 90x190cm rechts m. Cleartec | platinum/helder | 184147012751062 | stuk | 996,00 | 276 | 1 |
| | 0978299 | 90x190cm rechts m. Cleartec | edelmat/helder | 184147012751070 | stuk | 887,00 | 276 | 1 |
| | 0982717 | 90x190cm links | platinum/helder | 184147011551062 | stuk | 844,00 | 276 | 1 |
| | 0996505 | 90x190cm links | edelmat/helder | 184147011551070 | stuk | 735,00 | 276 | 1 |
| | 0978264 | 90x190cm links m. Cleartec | platinum/helder | 184147011751062 | stuk | 996,00 | 276 | 1 |
| Baden / douchebakken / stoomcabines | 0978272 | 90x190cm links m. Cleartec | edelmat/helder | 184147011751070 | stuk | 887,00 | 276 | 1 |
| | zijwand scharnier | | | | | | | |
| | 0987476 | 90x190cm rechts | platinum/helder | 184207012551062 | stuk | 714,00 | 276 | 1 |
| | 0996521 | 90x190cm rechts | edelmat/helder | 184207012551070 | stuk | 621,00 | 276 | 1 |
| | 0978329 | 90x190cm rechts m. Cleartec | platinum/helder | 184207012751062 | stuk | 866,00 | 276 | 1 |
| | 0978337 | 90x190cm rechts m. Cleartec | edelmat/helder | 184207012751070 | stuk | 773,00 | 276 | 1 |
| | 0987468 | 90x190cm links | platinum/helder | 184207011551062 | stuk | 714,00 | 276 | 1 |
| | 0996513 | 90x190cm links | edelmat/helder | 184207011551070 | stuk | 621,00 | 276 | 1 |
| Douchegarnituur | 0978302 | 90x190cm links m. Cleartec | platinum/helder | 184207011751062 | stuk | 866,00 | 276 | 1 |
| | 0978310 | 90x190cm links m. Cleartec | edelmat/helder | 184207011751070 | stuk | 773,00 | 276 | 1 |
| | hoekinstap compleet m. draaideuren | | | | | | | |
| | 0982709 | 90x90x190cm | platinum/helder | 184147011+184147012 | stuk | 1688,00 | 276 | 1 |
| Accessoires en spiegels | Douchewanden | | | | | | | |
| | douchecabine kwartrond m. draaideuren | | | | | | | |
| | 0982768 | 90x190cm | platinum/helder | 186500110551062 | stuk | 1687,00 | 276 | 1 |
| | 0996548 | 90x190cm | edelmat/helder | 186500110551070 | stuk | 1470,00 | 276 | 1 |
| Toebehoren & afvoeren | 0978426 | 90x190cm m. Cleartec | platinum/helder | 186500110751062 | stuk | 1991,00 | 276 | 1 |
| | 0978434 | 90x190cm m. Cleartec | zilver/helder | 186500110751070 | stuk | 1774,00 | 276 | 1 |
| | Duscholux Holydoor Plus | | | | | | | |
| | badklapwand 2-delig | | | | | | | |
| Badkamermeubelen en toiletkasten | 0979619 | 124x140cm links | edelmes./helder | 159320141551070 | stuk | 680,00 | 276 | 1 |
| | 0979635 | 124x140cm links | zilver/helder | 159320141551062 | stuk | 955,00 | 276 | 1 |
| | 0979627 | 124x140cm rechts | edelmes./helder | 159320142551070 | stuk | 680,00 | 276 | 1 |
| | 0979643 | 124x140cm rechts | zilver/helder | 159320142551062 | stuk | 955,00 | 276 | 1 |
| Gootstenen en wastroggen | Duscholux Magic Top | | | | | | | |
| | draaideur voor nis | | | | | | | |
| | 0996025 | 90x190cm | platinum/helder | 226117090551062 | stuk | 1229,00 | 276 | 1 |
| | 0996041 | 90x190cm | edelmat/helder | 226117090551070 | stuk | 987,00 | 276 | 1 |
| Utiliteit | 0976792 | 90x190cm m. Cleartec | platinum/helder | 226117090751062 | stuk | 1381,00 | 276 | 1 |
| | 0976806 | 90x190cm m. Cleartec | edelmat/helder | 226117090751070 | stuk | 1139,00 | 276 | 1 |
| | draaideur voor combinatie | | | | | | | |
| | 0995991 | 90x190cm | platinum/helder | 226147090551062 | stuk | 1100,00 | 276 | 1 |
| Utiliteit | 0996009 | 90x190cm | wit/helder | 226147090551001 | stuk | 1100,00 | 276 | 1 |
| | 0996017 | 90x190cm | edelmat/helder | 226147090551070 | stuk | 886,00 | 276 | 1 |
| | 0976822 | 90x190cm m. Cleartec | platinum/helder | 226147090751062 | stuk | 1252,00 | 276 | 1 |
| | 0976814 | 90x190cm m. Cleartec | wit/helder | 226147090751001 | stuk | 1252,00 | 276 | 1 |
| | 0976830 | 90x190cm m. Cleartec | edelmat/helder | 226147090751070 | stuk | 1038,00 | 276 | 1 |
| | deur m. paneel voor combinatie | | | | | | | |
| 0996068 | 90x190cm | platinum/helder | 225147090551062 | stuk | 1292,00 | 276 | 1 | |
| 0996076 | 90x190cm | wit/helder | 225147090551001 | stuk | 1292,00 | 276 | 1 | |
| 0996084 | 90x190cm | edelmat/helder | 225147090551070 | stuk | 1065,00 | 276 | 1 | |
| 0976733 | 90x190cm m. Cleartec | platinum/helder | 225147090751062 | stuk | 1444,00 | 276 | 1 | |
| 0976725 | 90x190cm m. Cleartec | wit/helder | 225147090751001 | stuk | 1444,00 | 276 | 1 | |
| 0976741 | 90x190cm m. Cleartec | edelmat/helder | 225147090751070 | stuk | 1217,00 | 276 | 1 | |

| Art.nr | Specificaties | Kleur | Lev.nr | Ehd | Prijs | Grp | CC | | | |
|---|---------------|-----------------|-----------------|-----------------|---------|---------|-----|---|---|---|
| | | | | | | | | Duscholux Magic Top | | |
| deur m. paneel voor nis | | | | | | | | | | |
| 0996092 | 90x190cm | platinum/helder | 225117090551062 | stuk | 1509,00 | 276 | 1 |  | Sanitair producten | |
| 0996106 | 90x190cm | wit/helder | 225117090551001 | stuk | 1509,00 | 276 | 1 | | | |
| 0996114 | 90x190cm | edelmat/helder | 225117090551070 | stuk | 1240,00 | 276 | 1 | | | |
| 0976679 | 90x190cm | m. Cleartec | platinum/helder | 225117090751062 | stuk | 1661,00 | 276 | | | 1 |
| 0976660 | 90x190cm | m. Cleartec | wit/helder | 225117090751001 | stuk | 1661,00 | 276 | | | 1 |
| 0976687 | 90x190cm | m. Cleartec | edelmat/helder | 225117090751070 | stuk | 1392,00 | 276 | | | 1 |
| 0996122 | 100x190cm | platinum/helder | 225119090551062 | stuk | 1576,00 | 276 | 1 | | Baden / douchebakken / stoomcabines | |
| 0996130 | 100x190cm | wit/helder | 225119090551001 | stuk | 1576,00 | 276 | 1 | | | |
| 0996149 | 100x190cm | edelmat/helder | 225119090551070 | stuk | 1298,00 | 276 | 1 | | | |
| 0976709 | 100x190cm | m. Cleartec | platinum/helder | 225119090751062 | stuk | 1728,00 | 276 | | | 1 |
| 0976695 | 100x190cm | m. Cleartec | wit/helder | 225119090751001 | stuk | 1728,00 | 276 | | | 1 |
| 0976717 | 100x190cm | m. Cleartec | edelmat/helder | 225119090751070 | stuk | 1450,00 | 276 | | | 1 |
| douchewand | | | | | | | | | | |
| 0996327 | 90x190cm | platinum/helder | 225207090551062 | stuk | 827,00 | 276 | 1 |  | Douchegarnituur | |
| 0996335 | 90x190cm | wit/helder | 225207090551001 | stuk | 827,00 | 276 | 1 | | | |
| 0996343 | 90x190cm | edelmat/helder | 225207090551070 | stuk | 679,00 | 276 | 1 | | | |
| 0976776 | 90x190cm | m. Cleartec | platinum/helder | 225207090751062 | stuk | 979,00 | 276 | | 1 | |
| 0976768 | 90x190cm | m. Cleartec | wit/helder | 225207090751001 | stuk | 979,00 | 276 | | 1 | |
| 0976784 | 90x190cm | m. Cleartec | edelmat/helder | 225207090751070 | stuk | 831,00 | 276 | | 1 | |
| douchecabine kwartrond m. 1 deur | | | | | | | | | | |
| 0996157 | 90x190cm | platinum/helder | 229500190551062 | stuk | 2377,00 | 276 | 1 |  | Accessoires en spiegels | |
| 0996165 | 90x190cm | wit/helder | 229500190551001 | stuk | 2377,00 | 276 | 1 | | | |
| 0996173 | 90x190cm | edelmat/helder | 229500190551070 | stuk | 2085,00 | 276 | 1 | | | |
| 0977020 | 90x190cm | m. Cleartec | platinum/helder | 229500190751062 | stuk | 2681,00 | 276 | | 1 | |
| 0977012 | 90x190cm | m. Cleartec | wit/helder | 229500190751001 | stuk | 2681,00 | 276 | | 1 | |
| 0977039 | 90x190cm | m. Cleartec | edelmat/helder | 229500190751070 | stuk | 2389,00 | 276 | | 1 | |
| douchecabine kwartrond m. 2 deuren | | | | | | | | | | |
| 0996238 | 90x190cm | platinum/helder | 230500190551062 | stuk | 2377,00 | 276 | 1 |  | Douchewanden | |
| 0996246 | 90x190cm | wit/helder | 230500190551001 | stuk | 2377,00 | 276 | 1 | | | |
| 0996254 | 90x190cm | edelmat/helder | 230500190551070 | stuk | 2085,00 | 276 | 1 | | | |
| 0977055 | 90x190cm | m. Cleartec | platinum/helder | 230500190751062 | stuk | 2681,00 | 276 | | 1 | |
| 0977047 | 90x190cm | m. Cleartec | wit/helder | 230500190751001 | stuk | 2681,00 | 276 | | 1 | |
| 0977063 | 90x190cm | m. Cleartec | edelmat/helder | 230500190751070 | stuk | 2389,00 | 276 | | 1 | |
| 0996181 | 100x190cm | platinum/helder | 230600190551062 | stuk | 2629,00 | 276 | 1 | | Toebehoren & afvoeren | |
| 0996203 | 100x190cm | wit/helder | 230600190551001 | stuk | 2629,00 | 276 | 1 | | | |
| 0996211 | 100x190cm | edelmat/helder | 230600190551070 | stuk | 2244,00 | 276 | 1 | | | |
| 0977098 | 100x190cm | m. Cleartec | platinum/helder | 230600190751062 | stuk | 2933,00 | 276 | | | 1 |
| 0977071 | 100x190cm | m. Cleartec | wit/helder | 230600190751001 | stuk | 2933,00 | 276 | | | 1 |
| 0977101 | 100x190cm | m. Cleartec | edelmat/helder | 230600190751070 | stuk | 2548,00 | 276 | | | 1 |
| douchecabine vijfhoekig | | | | | | | | | | |
| 0996262 | 90x190cm | platinum/helder | 228500190551062 | stuk | 2377,00 | 276 | 1 |  | Spoeel- & installatiesystemen | |
| 0996270 | 90x190cm | wit/helder | 228500190551001 | stuk | 2377,00 | 276 | 1 | | | |
| 0996289 | 90x190cm | edelmat/helder | 228500190551070 | stuk | 2085,00 | 276 | 1 | | | |
| 0976962 | 90x190cm | m. Cleartec | platinum/helder | 228500190751062 | stuk | 2681,00 | 276 | | 1 | |
| 0976954 | 90x190cm | m. Cleartec | wit/helder | 228500190751001 | stuk | 2681,00 | 276 | | 1 | |
| 0976970 | 90x190cm | m. Cleartec | edelmat/helder | 228500190751070 | stuk | 2389,00 | 276 | | 1 | |
| 0996297 | 100x190cm | platinum/helder | 228600190551062 | stuk | 2629,00 | 276 | 1 | | Badkamermeubelen en toiletkasten | |
| 0996300 | 100x190cm | wit/helder | 228600190551001 | stuk | 2629,00 | 276 | 1 | | | |
| 0996319 | 100x190cm | edelmat/helder | 228600190551070 | stuk | 2244,00 | 276 | 1 | | | |
| 0976997 | 100x190cm | m. Cleartec | platinum/helder | 228600190751062 | stuk | 2933,00 | 276 | | | 1 |
| 0976989 | 100x190cm | m. Cleartec | wit/helder | 228600190751001 | stuk | 2933,00 | 276 | | | 1 |
| 0977004 | 100x190cm | m. Cleartec | edelmat/helder | 228600190751070 | stuk | 2548,00 | 276 | | | 1 |
| klapdeur voor nis | | | | | | | | | | |
| 0996351 | 90x190cm | platinum/helder | 227117090551062 | stuk | 1600,00 | 276 | 1 |  | Gootstenen en wastroggen | |
| 0996378 | 90x190cm | wit/helder | 227117090551001 | stuk | 1600,00 | 276 | 1 | | | |
| 0996386 | 90x190cm | edelmat/helder | 227117090551070 | stuk | 1174,00 | 276 | 1 | | | |
| 0976857 | 90x190cm | m. Cleartec | platinum/helder | 227117090751062 | stuk | 1752,00 | 276 | | 1 | |
| 0976849 | 90x190cm | m. Cleartec | wit/helder | 227117090751001 | stuk | 1752,00 | 276 | | 1 | |
| 0976865 | 90x190cm | m. Cleartec | edelmat/helder | 227117090751070 | stuk | 1326,00 | 276 | | 1 | |
| klapdeur | | | | | | | | | | |
| 0996394 | 90x190cm | platinum/helder | 227127090551062 | stuk | 1600,00 | 276 | 1 | | | |
| 0996408 | 90x190cm | wit/helder | 227127090551001 | stuk | 1600,00 | 276 | 1 | | | |
| 0996416 | 90x190cm | edelmat/helder | 227127090551070 | stuk | 1174,00 | 276 | 1 | | | |
| 0976881 | 90x190cm | m. Cleartec | platinum/helder | 227127090751062 | stuk | 1752,00 | 276 | | 1 | |
| 0976873 | 90x190cm | m. Cleartec | wit/helder | 227127090751001 | stuk | 1752,00 | 276 | | 1 | |
| 0976903 | 90x190cm | m. Cleartec | edelmat/helder | 227127090751070 | stuk | 1326,00 | 276 | | 1 | |



| Art.nr | Specificaties | Kleur | Lev.nr | Ehd | Prijs | Grp | CC | |
|--------------------------------|---------------|-----------------|-----------------|-----------------|---------|---------|-----|---|
| Duscholux Magic Top | | | | | | | | |
| zijpaneel voor klapdeur | | | | | | | | |
| 0996424 | 90x190cm | platinum/helder | 227207090551062 | stuk | 1034,00 | 276 | 1 | |
| 0996432 | 90x190cm | wit/helder | 227207090551001 | stuk | 1034,00 | 276 | 1 | |
| 0996440 | 90x190cm | edelmat/helder | 227207090551070 | stuk | 756,00 | 276 | 1 | |
| 0976938 | 90x190cm | m. Cleartec | platinum/helder | 227207090751062 | stuk | 1186,00 | 276 | 1 |
| 0976911 | 90x190cm | m. Cleartec | wit/helder glas | 227207090751001 | stuk | 1186,00 | 276 | 1 |
| 0976946 | 90x190cm | m. Cleartec | edelmat/helder | 227207090751070 | stuk | 908,00 | 276 | 1 |

| | | | | | | | |
|-----------------------------|--------------|---------------|-----------------|------|---------|-----|---|
| Duscholux Urban | | | | | | | |
| douchepaneel gebogen | | | | | | | |
| 0986829 | 81x42x195cm | zilver/helder | 236010020551062 | stuk | 1297,00 | 276 | 1 |
| 0986830 | 115x42x195cm | zilver/helder | 236020020551062 | stuk | 1798,00 | 276 | 1 |
| douchepaneel recht | | | | | | | |
| 0986831 | 90x195cm | zilver/helder | 236037020551062 | stuk | 1002,00 | 276 | 1 |
| 0986832 | 100x195cm | zilver/helder | 236039020551062 | stuk | 1065,00 | 276 | 1 |
| 0986833 | 110x195cm | zilver/helder | 236031120551062 | stuk | 1121,00 | 276 | 1 |
| 0986834 | 120x195cm | zilver/helder | 236031220551062 | stuk | 1179,00 | 276 | 1 |
| 0986835 | 140x195cm | zilver/helder | 236031420551062 | stuk | 1297,00 | 276 | 1 |

- Sanitair producten
- Baden /
douchebakken /
stoomcabines
- Kranen
- Douchegarnituur
- Accessoires en
spiegels
- Douchewanden**
- Toebehoren &
afvoeren
- Spoel- &
installatiesystemen
- Badkamermeubelen
en toiletkasten
- Gootstenen en
wastroggen
- Utiliteit

| Art.nr | Specificaties | Kleur | Lev.nr | Ehd | Prijs | Grp | CC |
|--|---------------|-----------------|------------------|------|---------|-----|----|
| Hoesch Foster | | | | | | | |
| douchecabine 0383147 | 120x190cm | wit/transparant | 8656125100410 | stuk | 2877,00 | 279 | 1 |
| douchecabine everclean 0383155 | 120x190cm | wit/transparant | 8656125101410 | stuk | 3256,00 | 279 | 1 |
| douchecabine m. zijdouches 0383163 | 120x190cm | wit/transparant | 8656124100410305 | stuk | 3127,00 | 279 | 1 |
| douchecabine m. zijdouches everclean 0383171 | 120x190cm | wit/transparant | 8656124101410305 | stuk | 3572,00 | 279 | 1 |
| douchecabine 0383198 | 160x190cm | wit/transparant | 8656225100410 | stuk | 3188,00 | 279 | 1 |
| douchecabine everclean 0383201 | 160x190cm | wit/transparant | 8656225101410 | stuk | 3623,00 | 279 | 1 |
| douchecabine m. zijdouches 0383228 | 160x190cm | wit/transparant | 8656224100410305 | stuk | 3437,00 | 279 | 1 |
| douchecabine m. zijdouches everclean 0383236 | 160x190cm | wit/transparant | 8656224101410305 | stuk | 3766,00 | 279 | 1 |
| Hoesch Giorno Clever | | | | | | | |
| douchecabine kwartrond 0382639 | 100cm | wit/transparant | 8665710100410 | stuk | 2213,00 | 279 | 1 |
| douchecabine kwartrond everclean 0382647 | 100cm | wit/transparant | 8665710101410 | stuk | 2670,00 | 279 | 1 |



Sanitair producten

Baden /
douchebakken /
stoomcabines

Kranen

Douchegarnituur

Accessoires en
spiegels

Douchewanden

Toebehoren &
afvoeren

Spoel- &
installatiesystemen

Badkamermeubelen
en toiletkasten

Gootstenen en
wastroggen

Utiliteit

| | Art.nr | Specificaties | Kleur | Lev.nr | Ehd | Prijs | Grp | CC | |
|---|----------------------------|---------------------------------|-----------------|--------------|--------------|---------|--------|-----|---|
| Huppe Butler 2000 | | | | | | | | | |
| planchetsysteem voor douche | | | | | | | | | |
| Sanitair producten | 0966878 | | chrom | 492001091 | stuk | 159,00 | 281 | 0 | |
| Huppe 501 Classic badklapwand | | | | | | | | | |
| badklapwand 1-delig | | | | | | | | | |
| Baden / douchebakken / stoomcabines | 0979678 | 75x135cm links | wit/helder | 175123055321 | stuk | 248,00 | 281 | 1 | |
| | 0979687 | 75x135cm links | zilver/helder | 175123042321 | stuk | 248,00 | 281 | 1 | |
| | 0360732 | 75x135cm links m. Anti-Plaque | wit/helder | 175123055322 | stuk | 427,00 | 281 | 1 | |
| | 0360740 | 75x135cm links m. Anti-Plaque | zilver/helder | 175123042322 | stuk | 427,00 | 281 | 1 | |
| Kranen | 0979695 | 75x135cm rechts | wit/helder | 175124055321 | stuk | 248,00 | 281 | 1 | |
| | 0979708 | 75x135cm rechts | zilver/helder | 175124042321 | stuk | 248,00 | 281 | 1 | |
| | 0360759 | 75x135cm rechts m. Anti-Plaque | wit/helder | 175124055322 | stuk | 427,00 | 281 | 1 | |
| | 0360767 | 75x135cm rechts m. Anti-Plaque | zilver/helder | 175124042322 | stuk | 427,00 | 281 | 1 | |
| badklapwand 2-delig | | | | | | | | | |
| Douchegarnituur | 0979716 | 22+73x135 links | wit/helder | 175201055321 | stuk | 368,00 | 281 | 1 | |
| | 0979724 | 22+73x135 links | zilver/helder | 175201042321 | stuk | 368,00 | 281 | 1 | |
| | 0360775 | 22+73x135 links m. Anti-Plaque | wit/helder | 175201055322 | stuk | 547,00 | 281 | 1 | |
| | 0360783 | 22+73x135 links m. Anti-Plaque | zilver/helder | 175201042322 | stuk | 547,00 | 281 | 1 | |
| Accessoires en spiegels | 0979732 | 22+73x135 rechts | wit/helder | 175200055321 | stuk | 368,00 | 281 | 1 | |
| | 0979740 | 22+73x135 rechts | zilver/helder | 175200042321 | stuk | 368,00 | 281 | 1 | |
| | 0360791 | 22+73x135 rechts m. Anti-Plaque | wit/helder | 175200055322 | stuk | 547,00 | 281 | 1 | |
| | 0360805 | 22+73x135 rechts m. Anti-Plaque | zilver/helder | 175200042322 | stuk | 547,00 | 281 | 1 | |
| Huppe 2000 badklapwand | | | | | | | | | |
| badklapwand 2-delig | | | | | | | | | |
| Douchewanden | 0984469 | 113x140cm | zilver/classic | 374500087204 | stuk | 623,00 | 281 | 1 | |
| | 0984477 | 113x140cm | zilver/helder | 374500087321 | stuk | 742,00 | 281 | 1 | |
| | 0984493 | 113x140cm | wit/classic | 374500055204 | stuk | 623,00 | 281 | 1 | |
| | 0984507 | 113x140cm | wit/helder | 374500055321 | stuk | 742,00 | 281 | 1 | |
| Toebehoren & afvoeren | 0974153 | 113x140cm m. Anti-Plaque | zilver/helder | 374500087322 | stuk | 920,00 | 281 | 1 | |
| | 0974145 | 113x140cm m. Anti-Plaque | wit/helder | 374500055322 | stuk | 920,00 | 281 | 1 | |
| badklapwand 3-delig | | | | | | | | | |
| Spoel- & installatiesystemen | 0984523 | 140x140cm | zilver/classic | 370100087204 | stuk | 725,00 | 281 | 1 | |
| | 0984531 | 140x140cm | zilver/helder | 370100087321 | stuk | 844,00 | 281 | 1 | |
| | 0984566 | 140x140cm | wit/classic | 370100055204 | stuk | 725,00 | 281 | 1 | |
| | 0984574 | 140x140cm | wit/helder | 370100055321 | stuk | 844,00 | 281 | 1 | |
| Badkamermeubelen en toiletkasten | 0974110 | 140x140cm m. Anti-Plaque | zilver/helder | 370100087322 | stuk | 1022,00 | 281 | 1 | |
| | 0974102 | 140x140cm m. Anti-Plaque | wit/helder | 370100055322 | stuk | 1022,00 | 281 | 1 | |
| | 0995495 | 140x140cm | zilver/helder | 372100087321 | stuk | 1012,00 | 281 | 1 | |
| | 0995509 | 140x140cm | wit/helder | 372100055321 | stuk | 1012,00 | 281 | 1 | |
| Gootstenen en wastroggen | 0974099 | 140x140cm m. Anti-Plaque | zilver/helder | 372100087322 | stuk | 1190,00 | 281 | 1 | |
| | 0974080 | 140x140cm m. Anti-Plaque | wit/helder | 372100055322 | stuk | 1190,00 | 281 | 1 | |
| Huppe 2000A badklapwand | | | | | | | | | |
| badklapwand 2-delig | | | | | | | | | |
| Utiliteit | 0995517 | 114x148cm links | chrom/helder | 527311091321 | stuk | 702,00 | 281 | 1 | |
| | 0995525 | 114x148cm links | wit/helder | 527311055321 | stuk | 602,00 | 281 | 1 | |
| | 0974196 | 114x148cm links m. Anti-Plaque | chrom/helder | 527311091322 | stuk | 881,00 | 281 | 1 | |
| | 0974161 | 114x148cm links m. Anti-Plaque | wit/helder | 527311055322 | stuk | 781,00 | 281 | 1 | |
| | 0995533 | 114x148cm rechts | chrom/helder | 527312091321 | stuk | 702,00 | 281 | 1 | |
| | 0995541 | 114x148cm rechts | wit/helder | 527312055321 | stuk | 602,00 | 281 | 1 | |
| | 0974226 | 114x148cm rechts m. Anti-Plaque | chrom/helder | 527312091322 | stuk | 881,00 | 281 | 1 | |
| | 0974218 | 114x148cm rechts m. Anti-Plaque | wit/helder | 527312055322 | stuk | 781,00 | 281 | 1 | |
| | badklapwand 3-delig | | | | | | | | |
| | | 0995568 | 140x148cm links | chrom/helder | 527321091321 | stuk | 799,00 | 281 | 1 |
| 0995576 | | 140x148cm links | wit/helder | 527321055321 | stuk | 699,00 | 281 | 1 | |
| 0974242 | | 140x148cm links m. Anti-Plaque | chrom/helder | 527321091322 | stuk | 978,00 | 281 | 1 | |
| 0974234 | | 140x148cm links m. Anti-Plaque | wit/helder | 527321055322 | stuk | 878,00 | 281 | 1 | |
| 0995592 | | 140x148cm rechts | wit/helder | 527322055321 | stuk | 699,00 | 281 | 1 | |
| 0974269 | | 140x148cm rechts m. Anti-Plaque | chrom/helder | 527322091322 | stuk | 978,00 | 281 | 1 | |
| 0974250 | | 140x148cm rechts m. Anti-Plaque | wit/helder | 527322055322 | stuk | 878,00 | 281 | 1 | |
| Huppe 3000 badklapwand | | | | | | | | | |
| badklapwand 3-delig | | | | | | | | | |
| | 0360813 | 140x148cm links | chrom/helder | 527021091321 | stuk | 1346,00 | 281 | 1 | |
| | 0393617 | 140x148cm links m. Anti-Plaque | chrom/helder | 527021091322 | stuk | 1525,00 | 281 | 1 | |
| | 0986050 | 140x148cm rechts | chrom/helder | 527022091321 | stuk | 1346,00 | 281 | 1 | |
| | 0360821 | 140x148cm rechts m. Anti-Plaque | chrom/helder | 527022091322 | stuk | 1525,00 | 281 | 1 | |

| Art.nr | Specificaties | Kleur | Lev.nr | Ehd | Prijs | Grp | CC | |
|--|---------------|------------------|------------------|--------------|--------|--------|-----|---|
| Huppe 501 Classic vierhoek | | | | | | | | |
| douchecabine vierhoekig m. schuifdeuren 2-delig | | | | | | | | |
| 0361817 | 80x190cm | wit/helder | 501111055321 | stuk | 649,00 | 281 | 1 | |
| 0361818 | 80x190cm | wit/kunstglas | 501111055204 | stuk | 458,00 | 281 | 1 | |
| 0361820 | 80x190cm | zilver/helder | 501111042321 | stuk | 649,00 | 281 | 1 | |
| 0361821 | 80x190cm | zilver/kunstglas | 501111042204 | stuk | 458,00 | 281 | 1 | |
| 0361816 | 80x190cm | m. Anti-Plaque | wit/helder | 501111055322 | stuk | 946,00 | 281 | 1 |
| 0361819 | 80x190cm | m. Anti-Plaque | zilvermat/helder | 501111042322 | stuk | 946,00 | 281 | 1 |
| 0983024 | 90x190cm | | wit/helder | 501112055321 | stuk | 649,00 | 281 | 1 |
| 0361824 | 90x190cm | | wit/kunstglas | 501112055204 | stuk | 458,00 | 281 | 1 |
| 0983025 | 90x190cm | | zilvermat/helder | 501112042321 | stuk | 649,00 | 281 | 1 |
| 0361827 | 90x190cm | | zilver/kunstglas | 501112042204 | stuk | 458,00 | 281 | 1 |
| 0361822 | 90x190cm | m. Anti-Plaque | wit/helder | 501112055322 | stuk | 946,00 | 281 | 1 |
| 0361825 | 90x190cm | m. Anti-Plaque | zilvermat/helder | 501112042322 | stuk | 946,00 | 281 | 1 |
| 0983030 | 100x190cm | | wit/helder glas | 501115055321 | stuk | 649,00 | 281 | 1 |
| 0983031 | 100x190cm | | zilvermat/helder | 501115042321 | stuk | 649,00 | 281 | 1 |
| douchecabine vierhoekig m. schuifdeuren 3-delig | | | | | | | | |
| 0983034 | 90x190cm | | wit/helder glas | 501212055321 | stuk | 803,00 | 281 | 1 |
| 0983035 | 90x190cm | | zilvermat/helder | 501212042321 | stuk | 803,00 | 281 | 1 |
| 0983038 | 100x190cm | | wit/helder glas | 501215055321 | stuk | 803,00 | 281 | 1 |
| 0983172 | 100x190cm | | zilvermat/helder | 501215042321 | stuk | 803,00 | 281 | 1 |
| schuifdeur 3-delig | | | | | | | | |
| 0983041 | 76/80x190cm | | wit/helder glas | 501012055321 | stuk | 519,00 | 281 | 1 |
| 0361854 | 76/80x190cm | | wit/kunstglas | 501012055204 | stuk | 400,00 | 281 | 1 |
| 0983042 | 76/80x190cm | | zilvermat/helder | 501012042321 | stuk | 519,00 | 281 | 1 |
| 0361857 | 76/80x190cm | | zilver/kunstglas | 501012042204 | stuk | 400,00 | 281 | 1 |
| 0361852 | 76/80x190cm | m. Anti-Plaque | wit/helder | 501012055322 | stuk | 697,00 | 281 | 1 |
| 0361855 | 76/80x190cm | m. Anti-Plaque | zilvermat/helder | 501012042322 | stuk | 697,00 | 281 | 1 |
| 0983044 | 86/90x190cm | | wit/helder glas | 501013055321 | stuk | 519,00 | 281 | 1 |
| 0361860 | 86/90x190cm | | wit/kunstglas | 501013055204 | stuk | 400,00 | 281 | 1 |
| 0983045 | 86/90x190cm | | zilvermat/helder | 501013042321 | stuk | 519,00 | 281 | 1 |
| 0361863 | 86/90x190cm | | zilver/kunstglas | 501013042204 | stuk | 400,00 | 281 | 1 |
| 0361858 | 86/90x190cm | m. Anti-Plaque | wit/helder | 501013055322 | stuk | 697,00 | 281 | 1 |
| 0361861 | 86/90x190cm | m. Anti-Plaque | zilvermat/helder | 501013042322 | stuk | 697,00 | 281 | 1 |
| 0983048 | 96/100x190cm | | wit/helder glas | 501014055321 | stuk | 519,00 | 281 | 1 |
| 0361866 | 96/100x190cm | | wit/kunstglas | 501014055204 | stuk | 400,00 | 281 | 1 |
| 0983049 | 96/100x190cm | | zilvermat/helder | 501014042321 | stuk | 519,00 | 281 | 1 |
| 0361864 | 96/100x190cm | m. Anti-Plaque | wit/helder | 501014055322 | stuk | 697,00 | 281 | 1 |
| zwaaideur | | | | | | | | |
| 0361841 | 76/80x190cm | | wit/helder | 501501055321 | stuk | 519,00 | 281 | 1 |
| 0361842 | 76/80x190cm | | wit/kunstglas | 501501055204 | stuk | 400,00 | 281 | 1 |
| 0361847 | 76/80x190cm | | zilvermat/helder | 501501042321 | stuk | 519,00 | 281 | 1 |
| 0361848 | 76/80x190cm | | zilver/kunstglas | 501501042204 | stuk | 400,00 | 281 | 1 |
| 0361840 | 76/80x190cm | m. Anti-Plaque | wit/helder | 501501055322 | stuk | 697,00 | 281 | 1 |
| 0361846 | 76/80x190cm | m. Anti-Plaque | zilvermat/helder | 501501042322 | stuk | 697,00 | 281 | 1 |
| 0983051 | 86/90x190cm | | wit/helder glas | 501502055321 | stuk | 519,00 | 281 | 1 |
| 0361845 | 86/90x190cm | | wit/kunstglas | 501502055204 | stuk | 400,00 | 281 | 1 |
| 0983052 | 86/90x190cm | | zilvermat/helder | 501502042321 | stuk | 519,00 | 281 | 1 |
| 0361851 | 86/90x190cm | | zilver/kunstglas | 501502042204 | stuk | 400,00 | 281 | 1 |
| 0361843 | 86/90x190cm | m. Anti-Plaque | wit/helder | 501502055322 | stuk | 697,00 | 281 | 1 |
| 0361849 | 86/90x190cm | m. Anti-Plaque | zilvermat/helder | 501502042322 | stuk | 697,00 | 281 | 1 |
| 0983054 | 100x190cm | | wit/helder glas | 501503055321 | stuk | 519,00 | 281 | 1 |
| 0983056 | 100x190cm | | zilvermat/helder | 501503042321 | stuk | 519,00 | 281 | 1 |
| 0983058 | 120x190cm | | wit/helder glas | 501504055321 | stuk | 519,00 | 281 | 1 |
| 0983059 | 120x190cm | | zilvermat/helder | 501504042321 | stuk | 519,00 | 281 | 1 |



Sanitair producten

Baden /
douchebakken /
stoomcabines

Kranen

Douchegarnituur

Accessoires en
spiegels

Douchewanden

Toebehoren &
afvoeren

Spoel- &
installatiesystemen

Badkamermeubelen
en toiletkasten

Gootstenen en
wastroggen

Utiliteit

Art.nr Specificaties Kleur Lev.nr Ehd Prijs Grp CC

Huppe 501 Classic vierhoek

zijwand



| | | | | | | | | |
|---|---------|----------------------------|------------------|--------------|------|--------|-----|---|
| Sanitair producten | 0361876 | 78/80x165cm | wit/helder | 501316055321 | stuk | 279,00 | 281 | 1 |
| | 0361877 | 78/80x165cm | wit/kunstglas | 501316055204 | stuk | 239,00 | 281 | 1 |
| | 0361882 | 78/80x165cm | zilvermat/helder | 501316042321 | stuk | 279,00 | 281 | 1 |
| | 0361883 | 78/80x165cm | zilver/kunstglas | 501316042204 | stuk | 239,00 | 281 | 1 |
| Baden / douchebakken / stoomcabines | 0361875 | 78/80x165cm m. Anti-Plaque | wit/helder | 501316055322 | stuk | 398,00 | 281 | 1 |
| | 0361881 | 78/80x165cm m. Anti-Plaque | zilvermat/helder | 501316042322 | stuk | 398,00 | 281 | 1 |
| | 0361879 | 88/90x165cm | wit/helder | 501317055321 | stuk | 279,00 | 281 | 1 |
| | 0361880 | 88/90x165cm | wit/kunstglas | 501317055204 | stuk | 239,00 | 281 | 1 |
| | 0361885 | 88/90x165cm | zilvermat/helder | 501317042321 | stuk | 279,00 | 281 | 1 |
| Kranen | 0361886 | 88/90x165cm | zilver/kunstglas | 501317042204 | stuk | 239,00 | 281 | 1 |
| | 0361878 | 88/90x165cm m. Anti-Plaque | wit/helder | 501317055322 | stuk | 398,00 | 281 | 1 |
| | 0361884 | 88/90x165cm m. Anti-Plaque | zilvermat/helder | 501317042322 | stuk | 398,00 | 281 | 1 |
| | 0983078 | 78/80x190cm | wit/helder glas | 501312055321 | stuk | 279,00 | 281 | 1 |
| | 0983079 | 78/80x190cm | zilvermat/helder | 501312042321 | stuk | 279,00 | 281 | 1 |
| Douchegarnituur | 0983081 | 88/90x190cm | wit/helder glas | 501313055321 | stuk | 279,00 | 281 | 1 |
| | 0983082 | 88/90x190cm | zilvermat/helder | 501313042321 | stuk | 279,00 | 281 | 1 |
| | 0983084 | 98/100x190cm | wit/helder glas | 501314055321 | stuk | 279,00 | 281 | 1 |
| | 0983085 | 98/100x190cm | zilvermat/helder | 501314042321 | stuk | 279,00 | 281 | 1 |

pendeldeur



| | | | | | | | | |
|---------------------------------|---------|----------------------------|------------------|--------------|------|--------|-----|---|
| Accessoires en spiegels | 0983061 | 76/80x190cm | wit/helder glas | 501401055321 | stuk | 519,00 | 281 | 1 |
| | 0361830 | 76/80x190cm | wit/kunstglas | 501401055204 | stuk | 400,00 | 281 | 1 |
| | 0983062 | 76/80x190cm | zilvermat/helder | 501401042321 | stuk | 519,00 | 281 | 1 |
| | 0361836 | 76/80x190cm | zilver/kunstglas | 501401042204 | stuk | 400,00 | 281 | 1 |
| Douchewanden | 0361828 | 76/80x190cm m. Anti-Plaque | wit/helder | 501401055322 | stuk | 697,00 | 281 | 1 |
| | 0361834 | 76/80x190cm m. Anti-Plaque | zilvermat/helder | 501401042322 | stuk | 697,00 | 281 | 1 |
| | 0983065 | 86/90x190cm | wit/helder glas | 501402055321 | stuk | 519,00 | 281 | 1 |
| | 0361833 | 86/90x190cm | wit/kunstglas | 501402055204 | stuk | 400,00 | 281 | 1 |
| Toebehoren & afvoeren | 0983066 | 86/90x190cm | zilvermat/helder | 501402042321 | stuk | 519,00 | 281 | 1 |
| | 0361839 | 86/90x190cm | zilver/kunstglas | 501402042204 | stuk | 400,00 | 281 | 1 |
| | 0361831 | 86/90x190cm m. Anti-Plaque | wit/helder | 501402055322 | stuk | 697,00 | 281 | 1 |
| | 0361837 | 86/90x190cm m. Anti-Plaque | zilvermat/helder | 501402042322 | stuk | 697,00 | 281 | 1 |
| Spoel- & installatiesystemen | 0983068 | 100x190cm | wit/helder glas | 501403055321 | stuk | 519,00 | 281 | 1 |
| | 0983069 | 100x190cm | zilvermat/helder | 501403042321 | stuk | 519,00 | 281 | 1 |
| | 0983072 | 120x190cm | wit/helder glas | 501404055321 | stuk | 519,00 | 281 | 1 |
| | 0983073 | 120x190cm | zilvermat/helder | 501404042321 | stuk | 519,00 | 281 | 1 |

comfortdeur



| | | | | | | | | |
|-------------------------------------|---------|----------------------------|------------------|--------------|------|--------|-----|---|
| Badkamermeubelen en toiletkasten | 0361867 | 76/80x190cm | wit/helder | 501422055321 | stuk | 519,00 | 281 | 1 |
| | 0361869 | 76/80x190cm | zilvermat/helder | 501422042321 | stuk | 519,00 | 281 | 1 |
| | 0361868 | 76/80x190cm m. Anti-Plaque | wit/helder | 501422055322 | stuk | 697,00 | 281 | 1 |
| | 0361870 | 76/80x190cm m. Anti-Plaque | zilvermat/helder | 501422042322 | stuk | 697,00 | 281 | 1 |
| Gootstenen en wastroggen | 0361873 | 86/90x190cm | zilvermat/helder | 501423042321 | stuk | 519,00 | 281 | 1 |
| | 0361874 | 86/90x190cm m. Anti-Plaque | zilvermat/helder | 501423042322 | stuk | 697,00 | 281 | 1 |

douchecabine kwartrond m. schuifdeuren



| | | | | | | | | |
|-----------|---------|------------------------------|------------------|--------------|------|---------|-----|---|
| Utiliteit | 0983093 | 90x190cm R55 | wit/helder glas | 503400055321 | stuk | 803,00 | 281 | 1 |
| | 0361889 | 90x190cm R55 | wit/kunstglas | 503400055204 | stuk | 612,00 | 281 | 1 |
| | 0983094 | 90x190cm R55 | zilvermat/helder | 503400042321 | stuk | 803,00 | 281 | 1 |
| | 0361895 | 90x190cm R55 | zilver/kunstglas | 503400042204 | stuk | 612,00 | 281 | 1 |
| | 0361887 | 90x190cm R55 m. Anti-Plaque | wit/helder | 503400055322 | stuk | 1100,00 | 281 | 1 |
| | 0361893 | 90x190cm R55 m. Anti-Plaque | zilvermat/helder | 503400042322 | stuk | 1100,00 | 281 | 1 |
| | 0361891 | 100x100cm R55 | wit/helder | 503600055321 | stuk | 803,00 | 281 | 1 |
| | 0361892 | 100x100cm R55 | wit/kunstglas | 503600055204 | stuk | 612,00 | 281 | 1 |
| | 0361897 | 100x100cm R55 | zilvermat/helder | 503600042321 | stuk | 803,00 | 281 | 1 |
| | 0361898 | 100x100cm R55 | zilver/kunstglas | 503600042204 | stuk | 612,00 | 281 | 1 |
| | 0361890 | 100x100cm R55 m. Anti-Plaque | wit/helder | 503600055322 | stuk | 1100,00 | 281 | 1 |
| | 0361896 | 100x100cm R55 m. Anti-Plaque | zilvermat/helder | 503600042322 | stuk | 1100,00 | 281 | 1 |
| | 0983087 | 90x190cm R50 | wit/helder glas | 503100055321 | stuk | 803,00 | 281 | 1 |
| | 0983088 | 90x190cm R50 | zilvermat/helder | 503100042321 | stuk | 803,00 | 281 | 1 |
| | 0983090 | 100x190cm R50 | wit/helder glas | 503000055321 | stuk | 803,00 | 281 | 1 |
| | 0983091 | 100x190cm R50 | zilvermat/helder | 503000042321 | stuk | 803,00 | 281 | 1 |

| Art.nr | Specificaties | Kleur | Lev.nr | Ehd | Prijs | Grp | CC |
|--------|---------------|-------|--------|-----|-------|-----|----|
|--------|---------------|-------|--------|-----|-------|-----|----|

Huppe 501 Classic vierhoek

douchecabine kwartrond m. pendeldeuren

| | | | | | | | |
|---------|------------------------------|------------------|--------------|------|---------|-----|---|
| 7777701 | 90x190cm R50 | wit/helder | 503810055321 | stuk | 803,00 | 281 | 1 |
| 7777702 | 90x190cm R50 | zilvermat/helder | 503810042321 | stuk | 803,00 | 281 | 1 |
| 7777703 | 100x190cm R50 | wit/helder | 503820055321 | stuk | 803,00 | 281 | 1 |
| 7777704 | 100x190cm R50 | zilvermat/helder | 503820042321 | stuk | 803,00 | 281 | 1 |
| 0361900 | 90x190cm R55 | wit/helder | 503920055321 | stuk | 803,00 | 281 | 1 |
| 0361904 | 90x190cm R55 | zilvermat/helder | 503920042321 | stuk | 803,00 | 281 | 1 |
| 0361899 | 90x190cm R55 m. Anti-Plaque | wit/helder | 503920055322 | stuk | 1100,00 | 281 | 1 |
| 0361903 | 90x190cm R55 m. Anti-Plaque | zilvermat/helder | 503920042322 | stuk | 1100,00 | 281 | 1 |
| 0361902 | 100x100cm R55 | wit/helder | 503930055321 | stuk | 803,00 | 281 | 1 |
| 0361906 | 100x100cm R55 | zilvermat/helder | 503930042321 | stuk | 803,00 | 281 | 1 |
| 0361901 | 100x100cm R55 m. Anti-Plaque | wit/helder | 503930055322 | stuk | 1100,00 | 281 | 1 |
| 0361905 | 100x100cm R55 m. Anti-Plaque | zilvermat/helder | 503930042322 | stuk | 1100,00 | 281 | 1 |



Sanitair producten

Baden /
douchebakken /
stoomcabines

Kranen

Huppe 501 Toebehoren

| | | | | | | | |
|---------|---|--|-----------|------|-------|-----|---|
| 0360847 | poten en haken voor douchebak Classique | | 234899000 | stuk | 33,00 | 281 | 1 |
| 0983028 | verbredingsprofiel 10mm zilvermat | | 501070042 | stuk | 19,00 | 281 | 1 |
| 0983027 | verbredingsprofiel 10mm wit | | 501070055 | stuk | 19,00 | 281 | 1 |
| 0983021 | wisser chrom | | 608510000 | stuk | 13,75 | 281 | 1 |

Douchegarnituur

Accessoires en
spiegels

Huppe 501 Design

| | | | | | | | |
|---|------------------|---------------|------------------|------|---------|-----|---|
| zwaaideur | | | | | | | |
| 0360823 | 90x190cm | zilver/helder | 510601087321 | stuk | 519,00 | 281 | 1 |
| 0360826 | 100x190cm | zilver/helder | 510602087321 | stuk | 519,00 | 281 | 1 |
| zwaaideur voor nis m. set | | | | | | | |
| 0360822 | 90x190cm | zilver/helder | HUPPE 501 DESIGN | stuk | 598,00 | 281 | 1 |
| 0360825 | 100x190cm | zilver/helder | HUPPE 501 DESIGN | stuk | 598,00 | 281 | 1 |
| hoekinstap m. zwaaiendeuren | | | | | | | |
| 0360827 | 90x190cm | zilver/helder | HUPPE 501 DESIGN | stuk | 1038,00 | 281 | 1 |
| 0360828 | 100x190cm | zilver/helder | HUPPE 501 DESIGN | stuk | 1038,00 | 281 | 1 |
| zwaaideur m. vaste segmenten | | | | | | | |
| 0360830 | 90x190cm | zilver/helder | 510611087321 | stuk | 519,00 | 281 | 1 |
| 0360832 | 100x190cm | zilver/helder | 510612087321 | stuk | 519,00 | 281 | 1 |
| zwaaideur m. vaste segmenten voor nis | | | | | | | |
| 0360829 | 90x190cm m. set | zilver/helder | HUPPE 501 DESIGN | stuk | 598,00 | 281 | 1 |
| 0360831 | 100x190cm m. set | zilver/helder | HUPPE 501 DESIGN | stuk | 598,00 | 281 | 1 |
| hoekinstap m. zwaaiendeuren m. vaste segmenten | | | | | | | |
| 0360833 | 90x190cm | zilver/helder | HUPPE 501 DESIGN | stuk | 1038,00 | 281 | 1 |
| 0360834 | 100x190cm | zilver/helder | HUPPE 501 DESIGN | stuk | 1038,00 | 281 | 1 |
| zijwand voor zwaaideur | | | | | | | |
| 0360835 | 90x190cm | zilver/helder | 510622087321 | stuk | 365,00 | 281 | 1 |
| 0360836 | 100x190cm | zilver/helder | 510623087321 | stuk | 365,00 | 281 | 1 |
| zwaaideur voor douchecabine kwartrond per deel | | | | | | | |
| 0360838 | 90x190cm | zilver/helder | 510651087321 | stuk | 535,00 | 281 | 1 |
| 0360840 | 100x190cm | zilver/helder | 510652087321 | stuk | 535,00 | 281 | 1 |
| douchecabine kwartrond m. zwaaiendeuren | | | | | | | |
| 0360837 | 90x190cm | zilver/helder | HUPPE 501 DESIGN | stuk | 1070,00 | 281 | 1 |
| 0360839 | 100x190cm | zilver/helder | HUPPE 501 DESIGN | stuk | 1070,00 | 281 | 1 |
| zwaaideur m. vast segment voor douchecabine kwartrond per deel | | | | | | | |
| 0360842 | 90x190cm | zilver/helder | 510671087321 | stuk | 535,00 | 281 | 1 |
| 0360844 | 100x190cm | zilver/helder | 510672087321 | stuk | 535,00 | 281 | 1 |
| douchecabine kwartrond m. zwaaiendeuren m. vaste segmenten | | | | | | | |
| 0360841 | 90x190cm | zilver/helder | HUPPE 501 DESIGN | stuk | 1070,00 | 281 | 1 |
| 0360843 | 100x190cm | zilver/helder | HUPPE 501 DESIGN | stuk | 1070,00 | 281 | 1 |
| pendeldeur voor nis | | | | | | | |
| 0360845 | 90x190cm | zilver/helder | 510631087321 | stuk | 598,00 | 281 | 1 |
| 0360846 | 100x190cm | zilver/helder | 510632087321 | stuk | 598,00 | 281 | 1 |
| aanvullingsset voor nis | | | | | | | |
| 0360824 | | zilvermat | 510699087 | stuk | 79,00 | 281 | 1 |

Douchewanden

Toebehoren &
afvoerenSpoel- &
installatiesystemenBadkamermeubelen
en toiletkastenGootstenen en
wastroggen

Utiliteit

| | Art.nr | Specificaties | Kleur | Lev.nr | Ehd | Prijs | Grp | CC |
|---|---|----------------------------|--------------------|--------------|------|---------|-----|----|
| | Huppe 1002 Jette Joop vierhoek | | | | | | | |
| | hoekinstap m. draaideur voor Marano douchebak E2 | | | | | | | |
| Sanitair producten | 0967327 | 90x192cm | wit/helder glas | 980011055321 | stuk | 1339,00 | 281 | 1 |
| | 0967319 | 90x192cm | zilvermat/helder | 980011087321 | stuk | 1339,00 | 281 | 1 |
| | 0967355 | 90x192cm | glanszilver/helder | 980011069321 | stuk | 1555,00 | 281 | 1 |
| Baden / douchebakken / stoomcabines | 0968315 | 90x192cm m. Anti-Plaque | wit/helder glas | 980011055322 | stuk | 1636,00 | 281 | 1 |
| | 0968307 | 90x192cm m. Anti-Plaque | zilvermat/helder | 980011087322 | stuk | 1636,00 | 281 | 1 |
| | 0968323 | 90x192cm m. Anti-Plaque | glanszilver/helder | 980011069322 | stuk | 1852,00 | 281 | 1 |
| | douchebak voor 1002 Jette Joop hoekinstap | | | | | | | |
| | 0967343 | 90x90cm | wit | 984002055 | stuk | 378,00 | 281 | 1 |
| | hoekinstap m. draaideur E1 | | | | | | | |
| Kranen | 0967297 | 90x192cm | wit/helder glas | 980001055321 | stuk | 1339,00 | 281 | 1 |
| | 0967289 | 90x192cm | zilvermat/helder | 980001087321 | stuk | 1339,00 | 281 | 1 |
| | 0967300 | 90x192cm | glanszilver/helder | 980001069321 | stuk | 1555,00 | 281 | 1 |
| Douchegarnituur | 0968285 | 90x192cm m. Anti-Plaque | wit/helder glas | 980001055322 | stuk | 1636,00 | 281 | 1 |
| | 0968277 | 90x192cm m. Anti-Plaque | zilvermat/helder | 980001087322 | stuk | 1636,00 | 281 | 1 |
| | 0968293 | 90x192cm m. Anti-Plaque | glanszilver/helder | 980001069322 | stuk | 1852,00 | 281 | 1 |
| | hoekinstap m. draaideur m. vast segment E1 | | | | | | | |
| Accessoires en spiegels | 0393612 | 90x192cm | wit/helder | 981001055321 | stuk | 1339,00 | 281 | 1 |
| | 0967351 | 90x192cm | zilvermat/helder | 981001087321 | stuk | 1339,00 | 281 | 1 |
| | 0967386 | 90x192cm | glanszilver/helder | 981001069321 | stuk | 1555,00 | 281 | 1 |
| Douchewanden | 0968358 | 90x192cm m. Anti-Plaque | wit/helder glas | 981001055352 | stuk | 1636,00 | 281 | 1 |
| | 0968331 | 90x192cm m. Anti-Plaque | zilvermat/helder | 981001087352 | stuk | 1636,00 | 281 | 1 |
| | 0968366 | 90x192cm m. Anti-Plaque | glanszilver/helder | 981001069352 | stuk | 1852,00 | 281 | 1 |
| | zwaaiendeur STS | | | | | | | |
| Toebehoren & afvoeren | 0967467 | 90x192.8cm | wit/helder glas | 982051055321 | stuk | 733,00 | 281 | 1 |
| | 0967459 | 90x192.8cm | zilvermat/helder | 982051087321 | stuk | 733,00 | 281 | 0 |
| | 0967475 | 90x192.8cm | glanszilver/helder | 982051069321 | stuk | 854,00 | 281 | 1 |
| Spoel- & installatiesystemen | 0968447 | 90x192.8cm m. Anti-Plaque | wit/helder glas | 982051055322 | stuk | 912,00 | 281 | 1 |
| | 0968439 | 90x192.8cm m. Anti-Plaque | zilvermat/helder | 982051087322 | stuk | 912,00 | 281 | 1 |
| | 0968455 | 90x192.8cm m. Anti-Plaque | glanszilver/helder | 982051069322 | stuk | 1033,00 | 281 | 1 |
| Badkamermeubelen en toiletkasten | 0967521 | 100x192.8cm | wit/helder glas | 982052055321 | stuk | 733,00 | 281 | 1 |
| | 0967513 | 100x192.8cm | zilvermat/helder | 982052087321 | stuk | 733,00 | 281 | 1 |
| | 0967548 | 100x192.8cm | glanszilver/helder | 982052069321 | stuk | 854,00 | 281 | 1 |
| Gootstenen en wastroggen | 0968528 | 100x192.8cm m. Anti-Plaque | wit/helder glas | 982052055322 | stuk | 912,00 | 281 | 1 |
| | 0968501 | 100x192.8cm m. Anti-Plaque | zilvermat/helder | 982052087322 | stuk | 912,00 | 281 | 1 |
| | 0968536 | 100x192.8cm m. Anti-Plaque | glanszilver/helder | 982052069322 | stuk | 1033,00 | 281 | 1 |
| | zwaaiendeur voor nis STN | | | | | | | |
| Utiliteit | 0967653 | 80x192.8cm | wit/helder glas | 982000055321 | stuk | 733,00 | 281 | 1 |
| | 0967645 | 80x192.8cm | zilvermat/helder | 982000087321 | stuk | 733,00 | 281 | 1 |
| | 0967661 | 80x192.8cm | glanszilver/helder | 982000069321 | stuk | 854,00 | 281 | 1 |
| Utiliteit | 0968668 | 80x192.8cm m. Anti-Plaque | wit/helder glas | 982000055322 | stuk | 912,00 | 281 | 1 |
| | 0968641 | 80x192.8cm m. Anti-Plaque | zilvermat/helder | 982000087322 | stuk | 912,00 | 281 | 1 |
| | 0968676 | 80x192.8cm m. Anti-Plaque | glanszilver/helder | 982000069322 | stuk | 1033,00 | 281 | 1 |
| Utiliteit | 0967599 | 90x192.8cm | wit/helder glas | 982001055321 | stuk | 733,00 | 281 | 1 |
| | 0967580 | 90x192.8cm | zilvermat/helder | 982001087321 | stuk | 733,00 | 281 | 0 |
| | 0393613 | 90x192.8cm | glanszilver/helder | 982001069321 | stuk | 854,00 | 281 | 1 |
| Utiliteit | 0968587 | 90x192.8cm m. Anti-Plaque | wit/helder glas | 982001055322 | stuk | 912,00 | 281 | 1 |
| | 0968479 | 90x192.8cm m. Anti-Plaque | zilvermat/helder | 982001087322 | stuk | 912,00 | 281 | 1 |
| | 0968595 | 90x192.8cm m. Anti-Plaque | glanszilver/helder | 982001069322 | stuk | 1033,00 | 281 | 1 |
| Utiliteit | 0967629 | 100x192.8cm | wit/helder glas | 982002055321 | stuk | 733,00 | 281 | 1 |
| | 0967610 | 100x192.8cm | zilvermat/helder | 982002087321 | stuk | 733,00 | 281 | 1 |
| | 0967637 | 100x192.8cm | glanszilver/helder | 982002069321 | stuk | 854,00 | 281 | 1 |
| Utiliteit | 0968617 | 100x192.8cm m. Anti-Plaque | wit/helder glas | 982002055322 | stuk | 912,00 | 281 | 1 |
| | 0968609 | 100x192.8cm m. Anti-Plaque | zilvermat/helder | 982002087322 | stuk | 912,00 | 281 | 1 |
| | 0968625 | 100x192.8cm m. Anti-Plaque | glanszilver/helder | 982002069322 | stuk | 1033,00 | 281 | 1 |
| | zwaaiendeur m. vast segment voor zijwand STS | | | | | | | |
| Utiliteit | 0967769 | 90x192.8cm | wit/helder glas | 981081055321 | stuk | 733,00 | 281 | 1 |
| | 0967750 | 90x192.8cm | zilvermat/helder | 981081087321 | stuk | 733,00 | 281 | 1 |
| | 0967777 | 90x192.8cm | glanszilver/helder | 981081069321 | stuk | 854,00 | 281 | 1 |
| Utiliteit | 0968757 | 90x192.8cm m. Anti-Plaque | wit/helder glas | 981081055352 | stuk | 912,00 | 281 | 1 |
| | 0968749 | 90x192.8cm m. Anti-Plaque | zilvermat/helder | 981081087352 | stuk | 912,00 | 281 | 1 |
| | 0968766 | 90x192.8cm m. Anti-Plaque | glanszilver/helder | 981081069352 | stuk | 1033,00 | 281 | 1 |
| Utiliteit | 0360961 | 100x192.8cm | wit/helder glas | 981082055321 | stuk | 733,00 | 281 | 1 |
| | 0360953 | 100x192.8cm | zilvermat/helder | 981082087321 | stuk | 733,00 | 281 | 1 |
| | 0360996 | 100x192.8cm m. Anti-Plaque | wit/helder glas | 981082055352 | stuk | 912,00 | 281 | 1 |
| Utiliteit | 0360988 | 100x192.8cm m. Anti-Plaque | zilvermat/helder | 981082087352 | stuk | 912,00 | 281 | 1 |

| Art.nr | Specificaties | Kleur | Lev.nr | Ehd | Prijs | Grp | CC |
|---|----------------------------|--------------------|--------------|------|---------|-----|----|
| Huppe 1002 Jette Joop vierhoek | | | | | | | |
| zwaaiendeur voor nis m. vast segment STN | | | | | | | |
| 0393614 | 90x192.8cm | wit/helder | 981051055321 | stuk | 733,00 | 281 | 1 |
| 0967688 | 90x192.8cm | zilvermat/helder | 981051087321 | stuk | 733,00 | 281 | 0 |
| 0967718 | 90x192.8cm | glanszilver/helder | 981051069321 | stuk | 854,00 | 281 | 1 |
| 0968692 | 90x192.8cm m. Anti-Plaque | wit/helder glas | 981051055352 | stuk | 912,00 | 281 | 1 |
| 0968684 | 90x192.8cm m. Anti-Plaque | zilvermat/helder | 981051087352 | stuk | 912,00 | 281 | 1 |
| 0968706 | 90x192.8cm m. Anti-Plaque | glanszilver/helder | 981051069352 | stuk | 1033,00 | 281 | 1 |
| 0967734 | 100x192.8cm | wit/helder glas | 981052055321 | stuk | 733,00 | 281 | 1 |
| 0967726 | 100x192.8cm | zilvermat/helder | 981052087321 | stuk | 733,00 | 281 | 1 |
| 0967742 | 100x192.8cm | glanszilver/helder | 981052069321 | stuk | 854,00 | 281 | 1 |
| 0968722 | 100x192.8cm m. Anti-Plaque | wit/helder glas | 981052055352 | stuk | 912,00 | 281 | 1 |
| 0968714 | 100x192.8cm m. Anti-Plaque | zilvermat/helder | 981052087352 | stuk | 912,00 | 281 | 1 |
| 0968730 | 100x192.8cm m. Anti-Plaque | glanszilver/helder | 981052069352 | stuk | 1033,00 | 281 | 1 |
| zijwand voor zwaaiendeur SW | | | | | | | |
| 0967491 | 90x192.8cm | wit/helder glas | 983203055321 | stuk | 406,00 | 281 | 1 |
| 0967483 | 90x192.8cm | zilvermat/helder | 983203087321 | stuk | 406,00 | 281 | 0 |
| 0967505 | 90x192.8cm | glanszilver/helder | 983203069321 | stuk | 486,00 | 281 | 1 |
| 0968471 | 90x192.8cm m. Anti-Plaque | wit/helder glas | 983203055322 | stuk | 525,00 | 281 | 1 |
| 0968463 | 90x192.8cm m. Anti-Plaque | zilvermat/helder | 983203087322 | stuk | 525,00 | 281 | 1 |
| 0968498 | 90x192.8cm m. Anti-Plaque | glanszilver/helder | 983203069322 | stuk | 605,00 | 281 | 1 |
| 0967564 | 100x192.8cm | wit/helder glas | 983204055321 | stuk | 406,00 | 281 | 1 |
| 0967556 | 100x192.8cm | zilvermat/helder | 983204087321 | stuk | 406,00 | 281 | 1 |
| 0967572 | 100x192.8cm | glanszilver/helder | 983204069321 | stuk | 486,00 | 281 | 1 |
| 0968552 | 100x192.8cm m. Anti-Plaque | wit/helder glas | 983204055322 | stuk | 525,00 | 281 | 1 |
| 0968544 | 100x192.8cm m. Anti-Plaque | zilvermat/helder | 983204087322 | stuk | 525,00 | 281 | 1 |
| 0968560 | 100x192.8cm m. Anti-Plaque | glanszilver/helder | 983204069322 | stuk | 605,00 | 281 | 1 |
| pendelendeur voor nis PTN | | | | | | | |
| 0966888 | 90x192.8cm | wit/helder glas | 983501055321 | stuk | 959,00 | 281 | 1 |
| 0966887 | 90x192.8cm | zilvermat/helder | 983501087321 | stuk | 959,00 | 281 | 1 |
| 0966889 | 90x192.8cm | glanszilver/helder | 983501069321 | stuk | 1100,00 | 281 | 1 |
| 0966891 | 90x192.8cm m. Anti-Plaque | wit/helder glas | 983501055352 | stuk | 1138,00 | 281 | 1 |
| 0966890 | 90x192.8cm m. Anti-Plaque | zilvermat/helder | 983501087352 | stuk | 1138,00 | 281 | 1 |
| 0966892 | 90x192.8cm m. Anti-Plaque | glanszilver/helder | 983501069352 | stuk | 1280,00 | 281 | 1 |
| 0966895 | 100x192.8cm | wit/helder glas | 983502055321 | stuk | 959,00 | 281 | 1 |
| 0966893 | 100x192.8cm | zilvermat/helder | 983502087321 | stuk | 959,00 | 281 | 1 |
| 0966896 | 100x192.8cm | glanszilver/helder | 983502069321 | stuk | 1100,00 | 281 | 1 |
| 0966898 | 100x192.8cm m. Anti-Plaque | wit/helder glas | 983502055352 | stuk | 1138,00 | 281 | 1 |
| 0966897 | 100x192.8cm m. Anti-Plaque | zilvermat/helder | 983502087352 | stuk | 1138,00 | 281 | 1 |
| 0966899 | 100x192.8cm m. Anti-Plaque | glanszilver/helder | 983502069352 | stuk | 1280,00 | 281 | 1 |
| douchecabine vierhoekig m. schuifdeuren 2-delig (z. drempel) | | | | | | | |
| 0983102 | 90x200cm | wit/helder glas | 983601055321 | stuk | 984,00 | 281 | 1 |
| 0983095 | 90x200cm | glanszilver/helder | 983601069321 | stuk | 1200,00 | 281 | 1 |
| 0983097 | 90x200cm | tit. zilver/helder | 983601084321 | stuk | 984,00 | 281 | 1 |
| 0983103 | 90x200cm m. Anti-Plaque | wit/helder glas | 983601055322 | stuk | 1281,00 | 281 | 1 |
| 0983096 | 90x200cm m. Anti-Plaque | glanszilver/helder | 983601069322 | stuk | 1449,00 | 281 | 1 |
| 0983100 | 90x200cm m. Anti-Plaque | tit. zilver/helder | 983601084322 | stuk | 1281,00 | 281 | 1 |
| 0983108 | 100x200cm | wit/helder glas | 983602055321 | stuk | 984,00 | 281 | 1 |
| 0983104 | 100x200cm | glanszilver/helder | 983602069321 | stuk | 1200,00 | 281 | 1 |
| 0983106 | 100x200cm | tit. zilver/helder | 983602084321 | stuk | 984,00 | 281 | 1 |
| 0983109 | 100x200cm m. Anti-Plaque | wit/helder glas | 983602055322 | stuk | 1281,00 | 281 | 1 |
| 0983105 | 100x200cm m. Anti-Plaque | glanszilver/helder | 983602069322 | stuk | 1449,00 | 281 | 1 |
| 0983107 | 100x200cm m. Anti-Plaque | tit. zilver/helder | 983602084322 | stuk | 1281,00 | 281 | 1 |
| 0983114 | 110x200cm | wit/helder glas | 983603055321 | stuk | 984,00 | 281 | 1 |
| 0983110 | 110x200cm | glanszilver/helder | 983603069321 | stuk | 1200,00 | 281 | 1 |
| 0983112 | 110x200cm | tit. zilver/helder | 983603084321 | stuk | 984,00 | 281 | 1 |
| 0983115 | 110x200cm m. Anti-Plaque | wit/helder glas | 983603055322 | stuk | 1281,00 | 281 | 1 |
| 0983111 | 110x200cm m. Anti-Plaque | glanszilver/helder | 983603069322 | stuk | 1449,00 | 281 | 1 |
| 0983113 | 110x200cm m. Anti-Plaque | tit. zilver/helder | 983603084322 | stuk | 1281,00 | 281 | 1 |
| 0983120 | 120x200cm | wit/helder glas | 983604055321 | stuk | 984,00 | 281 | 1 |
| 0983116 | 120x200cm | glanszilver/helder | 983604069321 | stuk | 1200,00 | 281 | 1 |
| 0983118 | 120x200cm | tit. zilver/helder | 983604084321 | stuk | 984,00 | 281 | 1 |
| 0983121 | 120x200cm m. Anti-Plaque | wit/helder glas | 983604055322 | stuk | 1281,00 | 281 | 1 |
| 0983117 | 120x200cm m. Anti-Plaque | glanszilver/helder | 983604069322 | stuk | 1449,00 | 281 | 1 |
| 0983119 | 120x200cm m. Anti-Plaque | tit. zilver/helder | 983604084322 | stuk | 1281,00 | 281 | 1 |

Sanitair producten

Baden /
douchebakken /
stoomcabines

Kranen

Douchegarnituur

Accessoires en
spiegels

Douchewanden

Toebehoren &
afvoerenSpoel- &
installatiesystemenBadkamermeubelen
en toiletkastenGootstenen en
wastroggen

Utiliteit

| | Art.nr | Specificaties | Kleur | Lev.nr | Ehd | Prijs | Grp | CC | |
|---|-----------------------------------|--------------------------|--------------------|--------------|------|---------|-----|----|--|
| Huppe 1002 Jette Joop vierhoek | | | | | | | | | |
| hoekinstap m. schuifdeur 2-delig E2 | | | | | | | | | |
| Sanitair producten | 0361011 | 90x190cm | wit/helder glas | 983001055321 | stuk | 936,00 | 281 | 1 | |
| | 0361003 | 90x190cm | zilvermat/helder | 983001087321 | stuk | 936,00 | 281 | 1 | |
| | 0393616 | 90x190cm | glanszilver/helder | 983001069321 | stuk | 1152,00 | 281 | 1 | |
| Baden / douchebakken / stoomcabines | 0968226 | 90x190cm m. Anti-Plaque | wit/helder glas | 983001055322 | stuk | 1233,00 | 281 | 1 | |
| | 0968218 | 90x190cm m. Anti-Plaque | zilvermat/helder | 983001087322 | stuk | 1233,00 | 281 | 1 | |
| | 0968234 | 90x190cm m. Anti-Plaque | glanszilver/helder | 983001069322 | stuk | 1449,00 | 281 | 1 | |
| | 0967238 | 100x190cm | wit/helder glas | 983002055321 | stuk | 936,00 | 281 | 1 | |
| Kranen | 0967211 | 100x190cm | zilvermat/helder | 983002087321 | stuk | 936,00 | 281 | 1 | |
| | 0967246 | 100x190cm | glanszilver/helder | 983002069321 | stuk | 1152,00 | 281 | 1 | |
| | 0361046 | 100x190cm m. Anti-Plaque | wit/helder glas | 983002055322 | stuk | 1233,00 | 281 | 1 | |
| | 0361038 | 100x190cm m. Anti-Plaque | zilvermat/helder | 983002087322 | stuk | 1233,00 | 281 | 1 | |
| | 0393615 | 100x190cm m. Anti-Plaque | glanszilver/helder | 983002069322 | stuk | 1449,00 | 281 | 1 | |
| hoekinstap m. schuifdeur 3-delig E3 | | | | | | | | | |
| Douchegarnituur | 0967262 | 90x190cm | wit/helder glas | 983021055321 | stuk | 1128,00 | 281 | 1 | |
| | 0967254 | 90x190cm | zilvermat/helder | 983021087321 | stuk | 1128,00 | 281 | 1 | |
| | 0967270 | 90x190cm | glanszilver/helder | 983021069321 | stuk | 1344,00 | 281 | 1 | |
| Accessoires en spiegels | 0968250 | 90x190cm m. Anti-Plaque | wit/helder glas | 983021055322 | stuk | 1425,00 | 281 | 1 | |
| | 0968242 | 90x190cm m. Anti-Plaque | zilvermat/helder | 983021087322 | stuk | 1425,00 | 281 | 1 | |
| | 0968269 | 90x190cm m. Anti-Plaque | glanszilver/helder | 983021069322 | stuk | 1641,00 | 281 | 1 | |
| schuifdeur 3-delig GT | | | | | | | | | |
| Douchewanden | 0967408 | 90x190cm | wit/helder glas | 983051055321 | stuk | 688,00 | 281 | 1 | |
| | 0967394 | 90x190cm | zilvermat/helder | 983051087321 | stuk | 688,00 | 281 | 1 | |
| | 0967416 | 90x190cm | glanszilver/helder | 983051069321 | stuk | 830,00 | 281 | 1 | |
| | 0968382 | 90x190cm m. Anti-Plaque | wit/helder glas | 983051055322 | stuk | 867,00 | 281 | 1 | |
| | 0968374 | 90x190cm m. Anti-Plaque | zilvermat/helder | 983051087322 | stuk | 867,00 | 281 | 1 | |
| | 0968390 | 90x190cm m. Anti-Plaque | glanszilver/helder | 983051069322 | stuk | 970,00 | 281 | 1 | |
| schuifdeur 2-delig GT | | | | | | | | | |
| Toebehoren & afvoeren | 0983126 | 120x190cm | wit/helder glas | 983070055321 | stuk | 830,00 | 281 | 1 | |
| | 0983129 | 120x190cm | zilvermat/helder | 983070087321 | stuk | 791,00 | 281 | 1 | |
| Spoel- & installatiesystemen | 0983122 | 120x190cm | glanszilver/helder | 983070069321 | stuk | 933,00 | 281 | 1 | |
| | 0983124 | 120x190cm | tit. zilver/helder | 983070084321 | stuk | 791,00 | 281 | 1 | |
| | 0983127 | 120x190cm m. Anti-Plaque | wit/helder glas | 983070055322 | stuk | 970,00 | 281 | 1 | |
| | 0983130 | 120x190cm m. Anti-Plaque | zilvermat/helder | 983070087322 | stuk | 970,00 | 281 | 1 | |
| | 0983123 | 120x190cm m. Anti-Plaque | glanszilver/helder | 983070069322 | stuk | 1112,00 | 281 | 1 | |
| Badkamermeubelen en toiletkasten | 0983125 | 120x190cm m. Anti-Plaque | tit. zilver/helder | 983070084322 | stuk | 970,00 | 281 | 1 | |
| | zijwand voor schuifdeur SW | | | | | | | | |
| | 0983135 | 80x190cm | zilvermat/helder | 983252087321 | stuk | 406,00 | 281 | 1 | |
| | 0983131 | 80x190cm | glanszilver/helder | 983252069321 | stuk | 486,00 | 281 | 1 | |
| | 0983133 | 80x190cm | tit. zilver/helder | 983252084321 | stuk | 406,00 | 281 | 1 | |
| Gootstenen en wastroggen | 0983137 | 80x190cm m. Anti-Plaque | zilvermat/helder | 983252087322 | stuk | 525,00 | 281 | 1 | |
| | 0983134 | 80x190cm m. Anti-Plaque | tit. zilver/helder | 983252084322 | stuk | 525,00 | 281 | 1 | |
| | 0983132 | 80x190cm m. Anti-Plaque | glanszilver/helder | 983252069322 | stuk | 605,00 | 281 | 1 | |
| | 0967432 | 90x190cm | wit/helder glas | 983253055321 | stuk | 406,00 | 281 | 1 | |
| Utiliteit | 0967424 | 90x190cm | zilvermat/helder | 983253087321 | stuk | 406,00 | 281 | 1 | |
| | 0967440 | 90x190cm | glanszilver/helder | 983253069321 | stuk | 486,00 | 281 | 1 | |
| | 0968412 | 90x190cm m. Anti-Plaque | wit/helder glas | 983253055322 | stuk | 525,00 | 281 | 1 | |
| | 0968404 | 90x190cm m. Anti-Plaque | zilvermat/helder | 983253087322 | stuk | 525,00 | 281 | 1 | |
| | 0968420 | 90x190cm m. Anti-Plaque | glanszilver/helder | 983253069322 | stuk | 605,00 | 281 | 1 | |
| hoekinstap m. zwaaiendeuren m. vaste segmenten voor HappyD | | | | | | | | | |
| | 7777705 | 90x90cm | wit/helder | 981030055321 | stuk | 1598,00 | 281 | 1 | |
| | 7777706 | 90x90cm | zilver/helder | 981030087321 | stuk | 1598,00 | 281 | 1 | |
| | 7777707 | 90x90cm | glanszilver/helder | 981030069321 | stuk | 1814,00 | 281 | 1 | |
| | 7777708 | 90x90cm m. Anti-Plaque | wit/helder | 981030055352 | stuk | 1895,00 | 281 | 1 | |
| | 7777709 | 90x90cm m. Anti-Plaque | zilver/helder | 981030087352 | stuk | 1895,00 | 281 | 1 | |
| | 7777710 | 90x90cm m. Anti-Plaque | glanszilver/helder | 981030069352 | stuk | 2011,00 | 281 | 1 | |
| | 7777711 | 100x100cm | wit/helder | 981031055321 | stuk | 1598,00 | 281 | 1 | |
| | 7777712 | 100x100cm | zilver/helder | 981031087321 | stuk | 1598,00 | 281 | 1 | |
| | 7777713 | 100x100cm | glanszilver/helder | 981031069321 | stuk | 1814,00 | 281 | 1 | |
| | 7777714 | 100x100cm m. Anti-Plaque | wit/helder | 981031055352 | stuk | 1895,00 | 281 | 1 | |
| | 7777715 | 100x100cm m. Anti-Plaque | zilver/helder | 981031087352 | stuk | 1895,00 | 281 | 1 | |
| | 7777716 | 100x100cm m. Anti-Plaque | glanszilver/helder | 981031069352 | stuk | 2111,00 | 281 | 1 | |

| Art.nr | Specificaties | Kleur | Lev.nr | Ehd | Prijs | Grp | CC |
|--|-------------------------------------|--------------------|--------------|------|---------|-----|----|
| Huppe 1002 Jette Joop vierhoek | | | | | | | |
| hoekinstap m. zwaaiuder m. vaste segment m. 2 zijwanden voor HappyD | | | | | | | |
| 777717 | 80x100x190cm links | wit/helder | 981040055321 | stuk | 1557,00 | 281 | 1 |
| 777718 | 80x100x190cm links | zilver/helder | 981040087321 | stuk | 1557,00 | 281 | 1 |
| 777719 | 80x100x190cm links | glanszilver/helder | 981040069321 | stuk | 1862,00 | 281 | 1 |
| 777720 | 80x100x190cm links m. Anti-Plaque | wit/helder | 981040055352 | stuk | 2021,00 | 281 | 1 |
| 777721 | 80x100x190cm links m. Anti-Plaque | zilver/helder | 981040087352 | stuk | 2021,00 | 281 | 1 |
| 777722 | 80x100x190cm links m. Anti-Plaque | glanszilver/helder | 981040069352 | stuk | 2326,00 | 281 | 1 |
| 777723 | 90x120x190cm links | wit/helder | 981041055321 | stuk | 1557,00 | 281 | 1 |
| 777724 | 90x120x190cm links | zilver/helder | 981041087321 | stuk | 1557,00 | 281 | 1 |
| 777725 | 90x120x190cm links | glanszilver/helder | 981041069321 | stuk | 1862,00 | 281 | 1 |
| 777726 | 90x120x190cm links m. Anti-Plaque | wit/helder | 981041055352 | stuk | 2021,00 | 281 | 1 |
| 777727 | 90x120x190cm links m. Anti-Plaque | zilver/helder | 981041087352 | stuk | 2021,00 | 281 | 1 |
| 777728 | 90x120x190cm links m. Anti-Plaque | glanszilver/helder | 981041069352 | stuk | 2326,00 | 281 | 1 |
| 777729 | 100x120x190cm links | wit/helder | 981042055321 | stuk | 1557,00 | 281 | 1 |
| 777730 | 100x120x190cm links | zilver/helder | 981042087321 | stuk | 1557,00 | 281 | 1 |
| 777731 | 100x120x190cm links | glanszilver/helder | 981042069321 | stuk | 1862,00 | 281 | 1 |
| 777732 | 100x120x190cm links m. Anti-Plaque | wit/helder | 981042055352 | stuk | 2021,00 | 281 | 1 |
| 777733 | 100x120x190cm links m. Anti-Plaque | zilver/helder | 981042087352 | stuk | 2021,00 | 281 | 1 |
| 777734 | 100x120x190cm links m. Anti-Plaque | glanszilver/helder | 981042069352 | stuk | 2326,00 | 281 | 1 |
| 777735 | 80x100x190cm rechts | wit/helder | 981043055321 | stuk | 1557,00 | 281 | 1 |
| 777736 | 80x100x190cm rechts | zilver/helder | 981043087321 | stuk | 1557,00 | 281 | 1 |
| 777737 | 80x100x190cm rechts | glanszilver/helder | 981043069321 | stuk | 1862,00 | 281 | 1 |
| 777738 | 80x100x190cm rechts m. Anti-Plaque | wit/helder | 981043055352 | stuk | 2021,00 | 281 | 1 |
| 777739 | 80x100x190cm rechts m. Anti-Plaque | zilver/helder | 981043087352 | stuk | 2021,00 | 281 | 1 |
| 777740 | 80x100x190cm rechts m. Anti-Plaque | glanszilver/helder | 981043069352 | stuk | 2326,00 | 281 | 1 |
| 777741 | 90x120x190cm rechts | wit/helder | 981044055321 | stuk | 1557,00 | 281 | 1 |
| 777742 | 90x120x190cm rechts | zilver/helder | 981044087321 | stuk | 1557,00 | 281 | 1 |
| 777743 | 90x120x190cm rechts | glanszilver/helder | 981044069321 | stuk | 1862,00 | 281 | 1 |
| 777744 | 90x120x190cm rechts m. Anti-Plaque | wit/helder | 981044055352 | stuk | 2021,00 | 281 | 1 |
| 777745 | 90x120x190cm rechts m. Anti-Plaque | zilver/helder | 981044087352 | stuk | 2021,00 | 281 | 1 |
| 777746 | 90x120x190cm rechts m. Anti-Plaque | glanszilver/helder | 981044069352 | stuk | 2326,00 | 281 | 1 |
| 777747 | 100x120x190cm rechts | wit/helder | 981045055321 | stuk | 1557,00 | 281 | 1 |
| 777748 | 100x120x190cm rechts | zilver/helder | 981045087321 | stuk | 1557,00 | 281 | 1 |
| 777749 | 100x120x190cm rechts | glanszilver/helder | 981045069321 | stuk | 1862,00 | 281 | 1 |
| 777750 | 100x120x190cm rechts m. Anti-Plaque | wit/helder | 981045055352 | stuk | 2021,00 | 281 | 1 |
| 777751 | 100x120x190cm rechts m. Anti-Plaque | zilver/helder | 981045087352 | stuk | 2021,00 | 281 | 1 |
| 777752 | 100x120x190cm rechts m. Anti-Plaque | glanszilver/helder | 981045069352 | stuk | 2326,00 | 281 | 1 |

Huppe 1002 Jette Joop vijfhoek

| | | | | | | | |
|--|--------------------------|-------------------|--------------|------|---------|-----|---|
| douchecabine vijfhoekig m. 2 vleugels voor Marano douchecab | | | | | | | |
| 0967793 | 90x192cm | wit/helder glas | 980200055321 | stuk | 1339,00 | 281 | 1 |
| 0967785 | 90x192cm | zilvermat/helder | 980200087321 | stuk | 1339,00 | 281 | 1 |
| 0967807 | 90x192cm | glanszilv./helder | 980200069321 | stuk | 1555,00 | 281 | 1 |
| 0968781 | 90x192cm m. Anti-Plaque | wit/helder glas | 980200055322 | stuk | 1636,00 | 281 | 1 |
| 0968773 | 90x192cm m. Anti-Plaque | zilvermat/helder | 980200087322 | stuk | 1636,00 | 281 | 1 |
| 0968803 | 90x192cm m. Anti-Plaque | glanszilv./helder | 980200069322 | stuk | 1852,00 | 281 | 1 |
| 0967823 | 100x192cm | wit/helder glas | 980210055321 | stuk | 1339,00 | 281 | 1 |
| 0967815 | 100x192cm | zilvermat/helder | 980210087321 | stuk | 1339,00 | 281 | 1 |
| 0967831 | 100x192cm | glanszilv./helder | 980210069321 | stuk | 1555,00 | 281 | 1 |
| 0968838 | 100x192cm m. Anti-Plaque | wit/helder glas | 980210055322 | stuk | 1636,00 | 281 | 1 |
| 0968811 | 100x192cm m. Anti-Plaque | zilvermat/helder | 980210087322 | stuk | 1636,00 | 281 | 1 |
| 0968846 | 100x192cm m. Anti-Plaque | glanszilv./helder | 980210069322 | stuk | 1852,00 | 281 | 1 |
| douchecabine vijfhoekig voor 1002 Jette Joop douchecabine | | | | | | | |
| 0967858 | 90x90cm | wit | 984010055 | stuk | 532,00 | 281 | 1 |
| 0967866 | 100x100cm | wit | 984012055 | stuk | 532,00 | 281 | 1 |

Huppe 1002 Jette Joop kwart rond

| | | | | | | | |
|---|-------------------------|-------------------|--------------|------|---------|-----|---|
| schuifdeur kwart rond voor Marano/Purano/Classique douchecab | | | | | | | |
| 0966894 | 90x190cm | wit/helder glas | 983310055321 | stuk | 1128,00 | 281 | 1 |
| 0966886 | 90x190cm | zilvermat/helder | 983310087321 | stuk | 1128,00 | 281 | 1 |
| 0966908 | 90x190cm | glanszilv./helder | 983310069321 | stuk | 1344,00 | 281 | 1 |
| 0967882 | 90x190cm m. Anti-Plaque | wit/helder glas | 983310055322 | stuk | 1425,00 | 281 | 1 |
| 0967874 | 90x190cm m. Anti-Plaque | zilvermat/helder | 983310087322 | stuk | 1425,00 | 281 | 1 |
| 0967890 | 90x190cm m. Anti-Plaque | glanszilv./helder | 983310069322 | stuk | 1641,00 | 281 | 1 |
| schuifdeur kwart rond R55 | | | | | | | |
| 0968854 | 90x190cm | wit/helder glas | 983370055321 | stuk | 1128,00 | 281 | 1 |
| 0966916 | 90x190cm | zilvermat/helder | 983370087321 | stuk | 1128,00 | 281 | 1 |
| 0966924 | 90x190cm | glanszilv./helder | 983370069321 | stuk | 1344,00 | 281 | 1 |
| 0967912 | 90x190cm m. Anti-Plaque | wit/helder glas | 983370055322 | stuk | 1425,00 | 281 | 1 |
| 0967904 | 90x190cm m. Anti-Plaque | zilvermat/helder | 983370087322 | stuk | 1425,00 | 281 | 1 |
| 0967920 | 90x190cm m. Anti-Plaque | glanszilv./helder | 983370069322 | stuk | 1641,00 | 281 | 1 |

| | Art.nr | Specificaties | Kleur | Lev.nr | Ehd | Prijs | Grp | CC | |
|--|--|-------------------------|---------------------|--------------|------|---------|-----|----|--|
| Huppe 1002 Jette Joop kwartrond | | | | | | | | | |
| zwaai deur kwartrond voor Marano douchebak | | | | | | | | | |
| Sanitair producten | 0967130 | 90cm | wit/helder glas | 980510055321 | stuk | 1339,00 | 281 | 1 | |
| | 0967122 | 90cm | zilvermat/helder | 980510087321 | stuk | 1339,00 | 281 | 1 | |
| | 0967149 | 90cm | glanszilver/helder | 980510069321 | stuk | 1555,00 | 281 | 1 | |
| Baden / douchebakken / stoomcabines | 0968145 | 90cm m. Anti-Plaque | wit/helder glas | 980510055322 | stuk | 1636,00 | 281 | 1 | |
| | 0968137 | 90cm m. Anti-Plaque | zilvermat/helder | 980510087322 | stuk | 1636,00 | 281 | 1 | |
| | 0968153 | 90cm m. Anti-Plaque | glanszilver/helder | 980510069322 | stuk | 1852,00 | 281 | 1 | |
| | 0967165 | 100cm | wit/helder glas | 980520055321 | stuk | 1339,00 | 281 | 1 | |
| Kranen | 0967157 | 100cm | zilvermat/helder | 980520087321 | stuk | 1339,00 | 281 | 1 | |
| | 0967173 | 100cm | glanszilver/helder | 980520069321 | stuk | 1555,00 | 281 | 1 | |
| | 0968188 | 100cm m. Anti-Plaque | wit/helder glas | 980520055322 | stuk | 1636,00 | 281 | 1 | |
| | 0968161 | 100cm m. Anti-Plaque | zilvermat/helder | 980520087322 | stuk | 1636,00 | 281 | 1 | |
| Douchegarnituur | 0968196 | 100cm m. Anti-Plaque | glanszilver/helder | 980520069322 | stuk | 1852,00 | 281 | 1 | |
| | douchebak kwartrond voor 1002 Jette Joop zwaai deur | | | | | | | | |
| | 0967181 | 90x90cm z. paneel | wit | 984021055 | stuk | 532,00 | 281 | 1 | |
| | 0967203 | 100x100cm z. paneel | wit | 984022055 | stuk | 532,00 | 281 | 1 | |
| draai deur kwartrond voor Purano/Classique douchebak | | | | | | | | | |
| Accessoires en spiegels | 0966940 | 90x192cm | wit/helder glas | 980110055321 | stuk | 1339,00 | 281 | 1 | |
| | 0966932 | 90x192cm | zilvermat/helder | 980110087321 | stuk | 1339,00 | 281 | 1 | |
| | 0966959 | 90x192cm | glanszilver/helder | 980110069321 | stuk | 1555,00 | 281 | 1 | |
| | 0967947 | 90x192cm m. Anti-Plaque | wit/helder glas | 980110055322 | stuk | 1636,00 | 281 | 1 | |
| | 0967939 | 90x192cm m. Anti-Plaque | zilvermat/helder | 980110087322 | stuk | 1636,00 | 281 | 1 | |
| | 0967955 | 90x192cm m. Anti-Plaque | glanszilver/helder | 980110069322 | stuk | 1852,00 | 281 | 1 | |
| Douchewanden | | | | | | | | | |
| draai deur kwartrond R55 | | | | | | | | | |
| Toebehoren & afvoeren | 0966975 | 90x192cm | wit/helder glas | 980410055321 | stuk | 1339,00 | 281 | 1 | |
| | 0966967 | 90x192cm | zilvermat/helder | 980410087321 | stuk | 1339,00 | 281 | 1 | |
| | 0966983 | 90x192cm | glanszilver/helder | 980410069321 | stuk | 1555,00 | 281 | 1 | |
| | 0967971 | 90x192cm m. Anti-Plaque | wit/helder glas | 980410055322 | stuk | 1636,00 | 281 | 1 | |
| | 0967963 | 90x192cm m. Anti-Plaque | zilvermat/helder | 980410087322 | stuk | 1636,00 | 281 | 1 | |
| | 0967998 | 90x192cm m. Anti-Plaque | glanszilver/helder | 980410069322 | stuk | 1852,00 | 281 | 1 | |
| zwaai deur kwartrond m. vast segment m. 1 vleugel v. Marano/Purano/Classique | | | | | | | | | |
| Spoel- & installatiesystemen | 0967009 | 90x192cm | wit/helder glas | 981110055321 | stuk | 1339,00 | 281 | 1 | |
| | 0966991 | 90x192cm | zilvermat/helder | 981110087321 | stuk | 1339,00 | 281 | 1 | |
| | 0967017 | 90x192cm | glanszilver/helder | 981110069321 | stuk | 1555,00 | 281 | 1 | |
| | 0968013 | 90x192cm m. Anti-Plaque | wit/helder glas | 981110055352 | stuk | 1636,00 | 281 | 1 | |
| | 0968005 | 90x192cm m. Anti-Plaque | zilvermat/helder | 981110087352 | stuk | 1636,00 | 281 | 1 | |
| | 0968021 | 90x192cm m. Anti-Plaque | glanszilver/helder | 981110069352 | stuk | 1852,00 | 281 | 1 | |
| zwaai deur kwartrond m. vast segment m. 1 vleugel R55 | | | | | | | | | |
| Badkamermeubelen en toiletkasten | 0967033 | 90x192cm | wit/helder glas | 981510055321 | stuk | 1339,00 | 281 | 1 | |
| | 0967025 | 90x192cm | zilvermat/helder | 981510087321 | stuk | 1339,00 | 281 | 1 | |
| | 0977041 | 90x192cm | glanszilver/helder | 981510069321 | stuk | 1555,00 | 281 | 1 | |
| | 0968056 | 90x192cm m. Anti-Plaque | wit/helder glas | 981510055352 | stuk | 1636,00 | 281 | 1 | |
| | 0968048 | 90x192cm m. Anti-Plaque | zilvermat/helder | 981510087352 | stuk | 1636,00 | 281 | 1 | |
| | 0968064 | 90x192cm m. Anti-Plaque | glanszilver/helder | 981510069352 | stuk | 1852,00 | 281 | 1 | |
| zwaai deur kwartrond m. vast segment m. 2 vleugels v. Marano/Purano/Classique | | | | | | | | | |
| Gootstenen en wastroggen | 0967076 | 90x192cm | wit/helder glas | 981210055321 | stuk | 1339,00 | 281 | 1 | |
| | 0976068 | 90x192cm | zilvermat/helder | 981210087321 | stuk | 1339,00 | 281 | 1 | |
| | 0967084 | 90x192cm | glanszilver/helder | 981210069321 | stuk | 1555,00 | 281 | 1 | |
| | 0968080 | 90x192cm m. Anti-Plaque | wit/helder glas | 981210055352 | stuk | 1636,00 | 281 | 1 | |
| | 0968072 | 90x192cm m. Anti-Plaque | zilvermat/helder | 981210087352 | stuk | 1636,00 | 281 | 1 | |
| | 0968099 | 90x192cm m. Anti-Plaque | glanszilver/helder | 981210069352 | stuk | 1852,00 | 281 | 1 | |
| zwaai deur kwartrond m. vast segment m. 2 vleugels R55 | | | | | | | | | |
| Utiliteit | 0967106 | 90x192cm | wit/helder glas | 981710055321 | stuk | 1339,00 | 281 | 1 | |
| | 0967092 | 90x192cm | zilvermat/helder | 981710087321 | stuk | 1339,00 | 281 | 1 | |
| | 0967114 | 90x192cm | glanszilver/helder | 981710069321 | stuk | 1555,00 | 281 | 1 | |
| | 0968110 | 90x192cm m. Anti-Plaque | wit/helder glas | 981710055352 | stuk | 1636,00 | 281 | 1 | |
| | 0968102 | 90x192cm m. Anti-Plaque | zilvermat/helder | 981710087352 | stuk | 1636,00 | 281 | 1 | |
| | 0968129 | 90x192cm m. Anti-Plaque | glanszilver/helder | 981710069352 | stuk | 1852,00 | 281 | 1 | |
| | Huppe Jette Joop JJ3 vierhoek | | | | | | | | |
| | hoekinstap m. zwaai deuren m. achterwand | | | | | | | | |
| | 0969916 | | wit/creme wit | 4212120100 | stuk | 4110,00 | 281 | 1 | |
| | 0969924 | | wit/zilver | 4212120200 | stuk | 4110,00 | 281 | 1 | |
| | 0969920 | | perg./creme wit | 4213130100 | stuk | 4110,00 | 281 | 1 | |
| | 0969928 | | perg./zilver | 4213130200 | stuk | 4110,00 | 281 | 1 | |
| | 0969918 | | zilver/wit/cr.wit | 4218120100 | stuk | 4326,00 | 281 | 1 | |
| | 0969926 | | zilver/wit/zilver | 4218120200 | stuk | 4326,00 | 281 | 1 | |
| | 0969922 | | zilver/perg./cr.wit | 4218130100 | stuk | 4326,00 | 281 | 1 | |
| | 0969930 | | zilver/perg.zilver | 4218130200 | stuk | 4326,00 | 281 | 1 | |

| Art.nr | Specificaties | Kleur | Lev.nr | Ehd | Prijs | Grp | CC |
|--------|---------------|-------|--------|-----|-------|-----|----|
|--------|---------------|-------|--------|-----|-------|-----|----|

Huppe Jette Joop JJ3 vierhoek

hoekinstap m. zwaaideuren m. achterwand m. vaste segmenten

| | | | | | | | |
|---------|--|--------------------|------------|------|---------|-----|---|
| 0969932 | | wit/creme wit | 4612420100 | stuk | 4110,00 | 281 | 1 |
| 0969940 | | wit/zilver | 4612420200 | stuk | 4110,00 | 281 | 1 |
| 0969936 | | perg./cr.wit | 4613430100 | stuk | 4110,00 | 281 | 1 |
| 0969944 | | perg./zilver | 4613430200 | stuk | 4110,00 | 281 | 1 |
| 0969934 | | zilv./wit/cr.wit | 4618420100 | stuk | 4326,00 | 281 | 1 |
| 0969942 | | zilv./wit/zilver | 4618420200 | stuk | 4326,00 | 281 | 1 |
| 0969938 | | zilv./perg./cr.wit | 4618430100 | stuk | 4326,00 | 281 | 1 |
| 0969946 | | zilv./perg./zilver | 4618430200 | stuk | 4326,00 | 281 | 1 |

Sanitair producten

Baden /
douchebakken /
stoomcabines

Huppe Jette Joop JJ3 kwartrond

douchecabine kwartrond m. zwaai deur m. vaste segmenten

| | | | | | | | |
|---------|--|--------------------|------------|------|---------|-----|---|
| 0969964 | | wit/creme wit | 4412420100 | stuk | 4110,00 | 281 | 1 |
| 0969972 | | wit/zilver | 4412420200 | stuk | 4110,00 | 281 | 1 |
| 0969968 | | perg./cr.wit | 4413430100 | stuk | 4110,00 | 281 | 1 |
| 0969976 | | perg./zilver | 4413430200 | stuk | 4110,00 | 281 | 1 |
| 0969966 | | zilv./wit/cr.wit | 4418420100 | stuk | 4326,00 | 281 | 1 |
| 0969974 | | zilv./wit/zilver | 4418420200 | stuk | 4326,00 | 281 | 1 |
| 0969970 | | zilv./perg./cr.wit | 4418430100 | stuk | 4326,00 | 281 | 1 |
| 0969978 | | zilv./perg./zilver | 4418430200 | stuk | 4326,00 | 281 | 1 |

Kranen

Douchegarnituur

Accessoires en
spiegels

douchecabine kwartrond m. 2 zwaaideuren m. achterwand

| | | | | | | | |
|---------|--|--------------------|------------|------|---------|-----|---|
| 0969948 | | wit/creme wit | 4512120100 | stuk | 4110,00 | 281 | 1 |
| 0969956 | | wit/zilver | 4512120200 | stuk | 4110,00 | 281 | 1 |
| 0969952 | | perg./cr.wit | 4513130100 | stuk | 4110,00 | 281 | 1 |
| 0969960 | | perg./zilver | 4513130200 | stuk | 4110,00 | 281 | 1 |
| 0969950 | | zilv./wit/cr.wit | 4518120100 | stuk | 4326,00 | 281 | 1 |
| 0969958 | | zilv./wit/zilver | 4518120200 | stuk | 4326,00 | 281 | 1 |
| 0969954 | | zilv./perg./cr.wit | 4518130100 | stuk | 4326,00 | 281 | 1 |
| 0969962 | | zilv./perg./zilver | 4518130200 | stuk | 4326,00 | 281 | 1 |

Douchewanden

Toebehoren &
afvoeren

Huppe 2002 vierhoek

hoekinstap m. schuifdeur 2-delig E2

| | | | | | | | | |
|---------|----------|----------------|---------------|--------------|--------|---------|-----|---|
| 0361054 | 90x180cm | zilver/helder | 358001092321 | stuk | 967,00 | 281 | 1 | |
| 0361062 | 90x180cm | wit/helder | 358001055321 | stuk | 967,00 | 281 | 1 | |
| 0361070 | 90x180cm | m. Anti-Plaque | zilver/helder | 358001092322 | stuk | 1264,00 | 281 | 1 |
| 0361089 | 90x180cm | m. Anti-Plaque | wit/helder | 358001055322 | stuk | 1264,00 | 281 | 1 |
| 0361097 | 90x200cm | | zilver/helder | 358011092321 | stuk | 967,00 | 281 | 1 |
| 0361119 | 90x200cm | | wit/helder | 358011055321 | stuk | 967,00 | 281 | 1 |
| 0361127 | 90x200cm | m. Anti-Plaque | zilver/helder | 358011092322 | stuk | 1264,00 | 281 | 1 |
| 0361135 | 90x200cm | m. Anti-Plaque | wit/helder | 358011055322 | stuk | 1264,00 | 281 | 1 |

Spoel- &
installatiesystemenBadkamermeubelen
en toiletkasten

Huppe 2002 kwartrond

douchecabine kwartrond m. schuifdeuren

| | | | | | | | | |
|---------|-----------|----------------|---------------|--------------|------|---------|-----|---|
| 0361143 | 90x180cm | | zilver/helder | 350100092321 | stuk | 1352,00 | 281 | 1 |
| 0361151 | 90x180cm | | wit/helder | 350100055321 | stuk | 1352,00 | 281 | 1 |
| 0361178 | 90x180cm | m. Anti-Plaque | zilver/helder | 350100092322 | stuk | 1649,00 | 281 | 1 |
| 0361186 | 90x180cm | m. Anti-Plaque | wit/helder | 350100055322 | stuk | 1649,00 | 281 | 1 |
| 0361194 | 100x180cm | | zilver/helder | 350300092321 | stuk | 1352,00 | 281 | 1 |
| 0361208 | 100x180cm | | wit/helder | 350300055321 | stuk | 1352,00 | 281 | 1 |
| 0361216 | 100x180cm | m. Anti-Plaque | zilver/helder | 350300092322 | stuk | 1649,00 | 281 | 1 |
| 0361224 | 100x180cm | m. Anti-Plaque | wit/helder | 350300055322 | stuk | 1649,00 | 281 | 1 |

Gootstenen en
wastroggen

Utiliteit

| | Art.nr | Specificaties | Kleur | Lev.nr | Ehd | Prijs | Grp | CC |
|---|---------|--|---------------------|-----------------|------|---------|-----|----|
| Huppe 2003JJ vierhoek | | | | | | | | |
| draaideur voor zijwand | | | | | | | | |
| Sanitair producten | 0993670 | 90x190cm links lijn-A | wit/helder | 540001055321600 | stuk | 832,00 | 281 | 1 |
| | 0993689 | 90x190cm links lijn-A | perg./helder | 540001014321600 | stuk | 832,00 | 281 | 1 |
| | 0994502 | 90x190cm links lijn-A | chroom/helder | 540001091321600 | stuk | 984,00 | 281 | 1 |
| | 0975222 | 90x190cm links lijn-A m. Anti-Plaque | wit/helder glas | 540001055352600 | stuk | 1011,00 | 281 | 1 |
| Baden / douchebakken / stoomcabines | 0975214 | 90x190cm links lijn-A m. Anti-Plaque | perg./helder | 540001014352600 | stuk | 1011,00 | 281 | 1 |
| | 0975230 | 90x190cm links lijn-A m. Anti-Plaque | chroom/helder | 540001091352600 | stuk | 1163,00 | 281 | 1 |
| | 0993697 | 90x190cm rechts lijn-A | wit/helder glas | 540011055321600 | stuk | 832,00 | 281 | 1 |
| | 0993700 | 90x190cm rechts lijn-A | perg./helder | 540011014321600 | stuk | 832,00 | 281 | 1 |
| Kranen | 0994499 | 90x190cm rechts lijn-A | chroom/helder | 540011091321600 | stuk | 984,00 | 281 | 1 |
| | 0975257 | 90x190cm rechts lijn-A m. Anti-Plaque | wit/helder glas | 540011055352600 | stuk | 1011,00 | 281 | 1 |
| | 0975249 | 90x190cm rechts lijn-A m. Anti-Plaque | perg./helder | 540011014352600 | stuk | 1011,00 | 281 | 1 |
| Douchegarnituur | 0975265 | 90x190cm rechts lijn-A m. Anti-Plaque | chroom/helder | 540011091352600 | stuk | 1163,00 | 281 | 1 |
| | 0361232 | 100x190cm links lijn-A | wit/helder glas | 540002055321600 | stuk | 832,00 | 281 | 1 |
| | 0361240 | 100x190cm links lijn-A | chroom/helder | 540002091321600 | stuk | 984,00 | 281 | 1 |
| | 0361275 | 100x190cm links lijn-A m. Anti-Plaque | wit/helder glas | 540002055352600 | stuk | 1011,00 | 281 | 1 |
| | 0361283 | 100x190cm links lijn-A m. Anti-Plaque | chroom/helder | 540002091352600 | stuk | 1163,00 | 281 | 1 |
| Accessoires en spiegels | 0361259 | 100x190cm rechts lijn-A | wit/helder glas | 540012055321600 | stuk | 832,00 | 281 | 1 |
| | 0361267 | 100x190cm rechts lijn-A | chroom/helder | 540012091321600 | stuk | 984,00 | 281 | 1 |
| | 0361291 | 100x190cm rechts lijn-A m. Anti-Plaque | wit/helder glas | 540012055352600 | stuk | 1011,00 | 281 | 1 |
| | 0361305 | 100x190cm rechts lijn-A m. Anti-Plaque | chroom/helder | 540012091352600 | stuk | 1163,00 | 281 | 1 |
| draaideur voor nis m. vast segment | | | | | | | | |
| Douchewanden | 0361348 | 90x190cm links lijn-A | wit/helder glas | 540071055321600 | stuk | 832,00 | 281 | 1 |
| | 0361364 | 90x190cm links lijn-A | chroom/helder | 540071091321600 | stuk | 984,00 | 281 | 1 |
| | 0361356 | 90x190cm links lijn-A m. Anti-Plaque | wit/helder glas | 540071055352600 | stuk | 1011,00 | 281 | 1 |
| | 0361372 | 90x190cm links lijn-A m. Anti-Plaque | chroom/helder | 540071091352600 | stuk | 1163,00 | 281 | 1 |
| | 0361313 | 90x190cm rechts lijn-A | wit/helder glas | 540081055321600 | stuk | 832,00 | 281 | 1 |
| | 0981021 | 90x190cm rechts lijn-A | chroom/helder | 540081091321600 | stuk | 984,00 | 281 | 1 |
| | 0361321 | 90x190cm rechts lijn-A m. Anti-Plaque | wit/helder glas | 540081055352600 | stuk | 1011,00 | 281 | 1 |
| | 0975206 | 90x190cm rechts lijn-A m. Anti-Plaque | chroom/helder | 540081091352600 | stuk | 1163,00 | 281 | 1 |
| | 0361380 | 100x190cm links lijn-A | wit/helder glas | 540072055321600 | stuk | 832,00 | 281 | 1 |
| | 0361402 | 100x190cm links lijn-A | chroom/helder | 540072091321600 | stuk | 984,00 | 281 | 1 |
| Spool- & installatiesystemen | 0361399 | 100x190cm links lijn-A m. Anti-Plaque | wit/helder glas | 540072055352600 | stuk | 1011,00 | 281 | 1 |
| | 0361410 | 100x190cm links lijn-A m. Anti-Plaque | chroom/helder | 540072091352600 | stuk | 1163,00 | 281 | 1 |
| | 0361429 | 100x190cm rechts lijn-A | wit/helder glas | 540082055321600 | stuk | 832,00 | 281 | 1 |
| | 0361445 | 100x190cm rechts lijn-A | chroom/helder | 540082091321600 | stuk | 984,00 | 281 | 1 |
| Badkamermeubelen en toiletkasten | 0361437 | 100x190cm rechts lijn-A m. Anti-Plaque | wit/helder glas | 540082055352600 | stuk | 1011,00 | 281 | 1 |
| | 0361453 | 100x190cm rechts lijn-A m. Anti-Plaque | chroom/helder | 540082091352600 | stuk | 1163,00 | 281 | 1 |
| draaideur voor nis | | | | | | | | |
| Gootstenen en wastroggen | 0983139 | 90x190cm links lijn-A | titaan zilv./helder | 540021084321600 | stuk | 832,00 | 281 | 1 |
| | 0983138 | 90x190cm links lijn-A | chroom/helder | 540021091321600 | stuk | 984,00 | 281 | 1 |
| | 0983143 | 100x190cm links lijn-A | titaan zilv./helder | 540022084321600 | stuk | 832,00 | 281 | 1 |
| | 0983142 | 100x190cm links lijn-A | chroom/helder | 540022091321600 | stuk | 984,00 | 281 | 1 |
| | 0983141 | 90x190cm rechts lijn-A | titaan zilv./helder | 540031084321600 | stuk | 832,00 | 281 | 1 |
| | 0983140 | 90x190cm rechts lijn-A | chroom/helder | 540031091321600 | stuk | 984,00 | 281 | 1 |
| | 0983146 | 100x190cm rechts lijn-A | titaan zilv./helder | 540032084321600 | stuk | 832,00 | 281 | 1 |
| Utiliteit | 0983145 | 100x190cm rechts lijn-A | chroom/helder | 540032091321600 | stuk | 984,00 | 281 | 1 |
| klapdeur voor zijwand | | | | | | | | |
| Douchewanden | 0993719 | 90x190cm lijn-A | wit/helder | 541041055321600 | stuk | 1110,00 | 281 | 1 |
| | 0393621 | 90x190cm lijn-A | titaan/helder | 541041084321600 | stuk | 1110,00 | 281 | 1 |
| | 0393619 | 90x190cm lijn-A | chroom/helder | 541041091321600 | stuk | 1290,00 | 281 | 1 |
| | 0393618 | 90x190cm lijn-A m. Anti-Plaque | wit/helder | 541041055352600 | stuk | 1289,00 | 281 | 1 |
| | 0393622 | 90x190cm lijn-A m. Anti-Plaque | titaan/helder | 541041084352600 | stuk | 1289,00 | 281 | 1 |
| | 0393620 | 90x190cm lijn-A m. Anti-Plaque | chroom/helder | 541041091352600 | stuk | 1469,00 | 281 | 1 |
| klapdeur voor nis | | | | | | | | |
| Douchewanden | 0993824 | 90x190cm lijn-A | wit/helder | 541051055321600 | stuk | 1110,00 | 281 | 1 |
| | 0993832 | 90x190cm lijn-A | perg./helder | 541051014321600 | stuk | 1110,00 | 281 | 1 |
| | 0980186 | 90x190cm lijn-A | chroom/helder | 541051091321600 | stuk | 1290,00 | 281 | 1 |
| | 0975281 | 90x190cm lijn-A m. Anti-Plaque | wit/helder glas | 541051055352600 | stuk | 1289,00 | 281 | 1 |
| | 0975273 | 90x190cm lijn-A m. Anti-Plaque | perg./helder | 541051014352600 | stuk | 1289,00 | 281 | 1 |
| | 0975303 | 90x190cm lijn-A m. Anti-Plaque | chroom/helder | 541051091352600 | stuk | 1469,00 | 281 | 1 |
| | 0361461 | 100x190cm lijn-A | wit/helder glas | 541052055321600 | stuk | 1110,00 | 281 | 1 |
| | 0361488 | 100x190cm lijn-A | chroom/helder | 541052091321600 | stuk | 1290,00 | 281 | 1 |
| | 0361496 | 100x190cm lijn-A m. Anti-Plaque | wit/helder glas | 541052055352600 | stuk | 1289,00 | 281 | 1 |
| | 0361518 | 100x190cm lijn-A m. Anti-Plaque | chroom/helder | 541052091352600 | stuk | 1469,00 | 281 | 1 |

| Art.nr | Specificaties | Kleur | Lev.nr | Ehd | Prijs | Grp | CC |
|--------|---------------|-------|--------|-----|-------|-----|----|
|--------|---------------|-------|--------|-----|-------|-----|----|

Huppe 2003JJ vierhoek

zijwand

| | | | | | | | |
|---------|----------|------------------------------|-----------------|-----------------|------|--------|-------|
| 0993735 | 90x190cm | links lijn-A | wit/helder glas | 541002055321600 | stuk | 564,00 | 281 1 |
| 0993743 | 90x190cm | links lijn-A | perg./helder | 541002014321600 | stuk | 564,00 | 281 1 |
| 0994472 | 90x190cm | links lijn-A | chroom/helder | 541002091321600 | stuk | 664,00 | 281 1 |
| 0975362 | 90x190cm | links lijn-A m. Anti-Plaque | wit/helder glas | 541002055352600 | stuk | 683,00 | 281 1 |
| 0975354 | 90x190cm | links lijn-A m. Anti-Plaque | perg./helder | 541002014352600 | stuk | 683,00 | 281 1 |
| 0975370 | 90x190cm | links lijn-A m. Anti-Plaque | chroom/helder | 541002091352600 | stuk | 783,00 | 281 1 |
| 0993751 | 90x190cm | rechts lijn-A | wit/helder glas | 541022055321600 | stuk | 564,00 | 281 1 |
| 0993778 | 90x190cm | rechts lijn-A | perg./helder | 541022014321600 | stuk | 564,00 | 281 1 |
| 0994464 | 90x190cm | rechts lijn-A | chroom/helder | 541022091321600 | stuk | 664,00 | 281 1 |
| 0975397 | 90x190cm | rechts lijn-A m. Anti-Plaque | wit/helder glas | 541022055352600 | stuk | 683,00 | 281 1 |
| 0975389 | 90x190cm | rechts lijn-A m. Anti-Plaque | perg./helder | 541022014352600 | stuk | 683,00 | 281 1 |
| 0975400 | 90x190cm | rechts lijn-A m. Anti-Plaque | chroom/helder | 541022091352600 | stuk | 783,00 | 281 1 |



Sanitair producten

Baden /
douchebakken /
stoomcabines

Kranen

hoekinstap m. draaideuren m. vast segment

| | | | | | | | |
|---------|----------|-----------------------|-----------------|-----------------|------|---------|-------|
| 0993840 | 90x190cm | lijn-A | wit/helder glas | 540091055321600 | stuk | 1664,00 | 281 1 |
| 0993859 | 90x190cm | lijn-A | perg./helder | 540091014321600 | stuk | 1664,00 | 281 1 |
| 0975184 | 90x190cm | lijn-A m. Anti-Plaque | wit/helder glas | 540091055352600 | stuk | 1961,00 | 281 1 |
| 0975176 | 90x190cm | lijn-A m. Anti-Plaque | perg./helder | 540091014352600 | stuk | 1961,00 | 281 1 |
| 0975192 | 90x190cm | lijn-A m. Anti-Plaque | chroom/helder | 540091091352600 | stuk | 2235,00 | 281 1 |



Douchegarnituur

Accessoires en
spiegels

Huppe 2003JJ vijfhoek

douchecabine vijfhoekig m. draaideuren

| | | | | | | | |
|---------|-----------|-----------------------|-----------------|-----------------|------|---------|-------|
| 0993867 | 90x190cm | lijn-A | wit/helder glas | 542600055321600 | stuk | 1664,00 | 281 1 |
| 0993875 | 90x190cm | lijn-A | perg./helder | 542600014321600 | stuk | 1664,00 | 281 1 |
| 0994421 | 90x190cm | lijn-A | chroom/helder | 542600091321600 | stuk | 1938,00 | 281 1 |
| 0974455 | 90x190cm | lijn-A m. Anti-Plaque | wit/helder glas | 542600055352600 | stuk | 1961,00 | 281 1 |
| 0974447 | 90x190cm | lijn-A m. Anti-Plaque | perg./helder | 542600014352600 | stuk | 1961,00 | 281 1 |
| 0974463 | 90x190cm | lijn-A m. Anti-Plaque | chroom/helder | 542600091352600 | stuk | 2235,00 | 281 1 |
| 0993883 | 90x190cm | lijn-A | wit/helder glas | 542610055321600 | stuk | 1664,00 | 281 1 |
| 0993891 | 90x190cm | lijn-A | perg./helder | 542610014321600 | stuk | 1664,00 | 281 1 |
| 0994413 | 90x190cm | lijn-A | chroom/helder | 542610091321600 | stuk | 1938,00 | 281 1 |
| 0974498 | 90x190cm | lijn-A m. Anti-Plaque | wit/helder glas | 542610055352600 | stuk | 1961,00 | 281 1 |
| 0974471 | 90x190cm | lijn-A m. Anti-Plaque | perg./helder | 542610014352600 | stuk | 1961,00 | 281 1 |
| 0974501 | 90x190cm | lijn-A m. Anti-Plaque | chroom/helder | 542610091321600 | stuk | 2235,00 | 281 1 |
| 0993905 | 100x190cm | lijn-A | wit/helder glas | 542750055321600 | stuk | 1664,00 | 281 1 |
| 0993913 | 100x190cm | lijn-A | perg./helder | 542750014321600 | stuk | 1664,00 | 281 1 |
| 0994405 | 100x190cm | lijn-A | chroom/helder | 542750091321600 | stuk | 1938,00 | 281 1 |
| 0974536 | 100x190cm | lijn-A m. Anti-Plaque | wit/helder glas | 542750055352600 | stuk | 1961,00 | 281 1 |
| 0974528 | 100x190cm | lijn-A m. Anti-Plaque | perg./helder | 542750014352600 | stuk | 1961,00 | 281 1 |
| 0974544 | 100x190cm | lijn-A m. Anti-Plaque | chroom/helder | 542750091352600 | stuk | 2235,00 | 281 1 |
| 0993921 | 100x190cm | lijn-A | wit/helder glas | 542770055321600 | stuk | 1664,00 | 281 1 |
| 0993948 | 100x190cm | lijn-A | perg./helder | 542770014321600 | stuk | 1664,00 | 281 1 |
| 0994391 | 100x190cm | lijn-A | chroom/helder | 542770091321600 | stuk | 1938,00 | 281 1 |
| 0974560 | 100x190cm | lijn-A m. Anti-Plaque | wit/helder glas | 542770055352600 | stuk | 1961,00 | 281 1 |
| 0974552 | 100x190cm | lijn-A m. Anti-Plaque | perg./helder | 542770014352600 | stuk | 1961,00 | 281 1 |
| 0974579 | 100x190cm | lijn-A m. Anti-Plaque | chroom/helder | 542770091352600 | stuk | 2235,00 | 281 1 |



Douchewanden

Toebehoren &
afvoerenSpoel- &
installatiesystemenBadkamermeubelen
en toiletkastenGootstenen en
wastroggen

Utiliteit

draaideur m. 2 vleugels vijfhoekig voor Marano douchebak 566008

| | | | | | | | |
|---------|----------|--------|---------------------|-----------------|------|---------|-------|
| 0983157 | 90x195cm | lijn A | titaan zilv./helder | 568010084321600 | stuk | 1664,00 | 281 1 |
| 0983156 | 90x195cm | lijn A | chroom/helder | 568010091321600 | stuk | 1938,00 | 281 1 |
| 0983162 | 90x195cm | lijn-C | titaan zilv./helder | 568010084321601 | stuk | 1664,00 | 281 1 |
| 0983161 | 90x195cm | lijn-C | chroom/helder | 568010091321601 | stuk | 1938,00 | 281 1 |

draaideur m. 2 vleugels vijfhoekig voor Marano douchebak 566009

| | | | | | | | |
|---------|-----------|--------|---------------------|-----------------|------|---------|-------|
| 0983159 | 100x195cm | lijn A | titaan zilv./helder | 568011084321600 | stuk | 1664,00 | 281 1 |
| 0983158 | 100x195cm | lijn A | chroom/helder | 568011091321600 | stuk | 1938,00 | 281 1 |
| 0983164 | 100x195cm | lijn-C | titaan zilv./helder | 568011084321601 | stuk | 1664,00 | 281 1 |
| 0983163 | 100x195cm | lijn-C | chroom/helder | 568011091321601 | stuk | 1938,00 | 281 1 |

Marano douchebak vijfhoekig

| | | | | | | |
|---------|-----------|----------|-----------|------|--------|-------|
| 0983165 | 90x90cm | wit | 566008055 | stuk | 414,00 | 281 1 |
| 0987333 | 90x90cm | pergamon | 566008014 | stuk | 414,00 | 281 1 |
| 0983168 | 100x100cm | wit | 566009055 | stuk | 414,00 | 281 1 |
| 0983169 | 100x100cm | pergamon | 566009014 | stuk | 414,00 | 281 1 |

Marano ommanteling voor douchebak vijfhoekig

| | | | | | | |
|---------|-----------|----------|-----------|------|--------|-------|
| 0983166 | 90x90cm | wit | 566018055 | stuk | 112,00 | 281 1 |
| 0983167 | 90x90cm | pergamon | 566018014 | stuk | 112,00 | 281 1 |
| 0983170 | 100x100cm | wit | 566019055 | stuk | 112,00 | 281 1 |
| 0983171 | 100x100cm | pergamon | 566019014 | stuk | 112,00 | 281 1 |

| | Art.nr | Specificaties | Kleur | Lev.nr | Ehd | Prijs | Grp | CC |
|---|---|---------------------------------------|---------------------|-----------------|------|---------|-----|----|
| | Huppe 2003JJ kwartrond | | | | | | | |
| | douchecabine kwartrond m. draaideuren v. Marano/Purano | | | | | | | |
| Sanitair producten | 0993956 | 90x190cm lijn-A | wit/helder | 544100055321600 | stuk | 1664,00 | 281 | 1 |
| | 0993964 | 90x190cm lijn-A | perg./helder | 544100014321600 | stuk | 1664,00 | 281 | 1 |
| | 0994383 | 90x190cm lijn-A | chroom/helder | 544100091321600 | stuk | 1938,00 | 281 | 1 |
| | 0973769 | 90x190cm lijn-A m. Anti-Plaque | wit/helder | 544100055352600 | stuk | 1961,00 | 281 | 1 |
| Baden / douchebakken / stoomcabines | 0973750 | 90x190cm lijn-A m. Anti-Plaque | perg./helder | 544100014352600 | stuk | 1961,00 | 281 | 1 |
| | 0973777 | 90x190cm lijn-A m. Anti-Plaque | chroom/helder | 544100091352600 | stuk | 2235,00 | 281 | 1 |
| | 0993999 | 100x190cm lijn-A | wit/helder | 544150055321600 | stuk | 1664,00 | 281 | 1 |
| | 0994006 | 100x190cm lijn-A | perg./helder | 544150014321600 | stuk | 1664,00 | 281 | 1 |
| Kranen | 0994367 | 100x190cm lijn-A | chroom/helder | 544150091321600 | stuk | 1938,00 | 281 | 1 |
| | 0973823 | 100x190cm lijn-A m. Anti-Plaque | wit/helder | 544150055352600 | stuk | 1961,00 | 281 | 1 |
| | 0973815 | 100x190cm lijn-A m. Anti-Plaque | perg./helder | 544150014352600 | stuk | 1961,00 | 281 | 1 |
| | 0973831 | 100x190cm lijn-A m. Anti-Plaque | chroom/helder | 544150091352600 | stuk | 2235,00 | 281 | 1 |
| | douchecabine kwartrond m. draaideuren voor Marano | | | | | | | |
| Douchegarnituur | 0983148 | 90x195cm lijn-A | titaan zilv./helder | 568020084321600 | stuk | 1664,00 | 281 | 1 |
| | 0983147 | 90x195cm lijn-A | chroom/helder | 568020091321600 | stuk | 1938,00 | 281 | 1 |
| | 0983153 | 90x195cm lijn-C | titaan zilv./helder | 568020084321601 | stuk | 1664,00 | 281 | 1 |
| | 0983151 | 90x195cm lijn-C | chroom/helder | 568020091321601 | stuk | 1938,00 | 281 | 1 |
| Accessoires en spiegels | 0983150 | 100x195cm lijn-A | titaan zilv./helder | 568021084321600 | stuk | 1664,00 | 281 | 1 |
| | 0983149 | 100x195cm lijn-A | chroom/helder | 568021091321600 | stuk | 1938,00 | 281 | 1 |
| | 0983155 | 100x195cm lijn-C | titaan zilv./helder | 568021084321601 | stuk | 1664,00 | 281 | 1 |
| | 0983154 | 100x195cm lijn-C | chroom/helder | 568021091321601 | stuk | 1938,00 | 281 | 1 |
| | Huppe 2003JJ vierhoek | | | | | | | |
| | draaideur voor zijwand | | | | | | | |
| Douchewanden | 0994529 | 90x190cm links lijn-C | wit/helder | 540009055321601 | stuk | 832,00 | 281 | 1 |
| | 0994537 | 90x190cm links lijn-C | perg./helder | 540009014321601 | stuk | 832,00 | 281 | 1 |
| | 0994545 | 90x190cm links lijn-C | chroom/helder | 540009091321601 | stuk | 984,00 | 281 | 1 |
| | 0975494 | 90x190cm links lijn-C m. Anti-Plaque | wit/helder | 540009055352601 | stuk | 1011,00 | 281 | 1 |
| Toebehoren & afvoeren | 0975486 | 90x190cm links lijn-C m. Anti-Plaque | perg./helder | 540009014352601 | stuk | 1011,00 | 281 | 1 |
| | 0975508 | 90x190cm links lijn-C m. Anti-Plaque | chroom/helder | 540009091352601 | stuk | 1163,00 | 281 | 1 |
| | 0994553 | 90x190cm rechts lijn-C | wit/helder | 540019055321601 | stuk | 832,00 | 281 | 1 |
| | 0994561 | 90x190cm rechts lijn-C | perg./helder | 540019014321601 | stuk | 832,00 | 281 | 1 |
| Spoel- & installatiesystemen | 0994588 | 90x190cm rechts lijn-C | chroom/helder | 540019091321601 | stuk | 984,00 | 281 | 1 |
| | 0975524 | 90x190cm rechts lijn-C m. Anti-Plaque | wit/helder | 540019055352601 | stuk | 1011,00 | 281 | 1 |
| | 0975516 | 90x190cm rechts lijn-C m. Anti-Plaque | perg./helder | 540019014352601 | stuk | 1011,00 | 281 | 1 |
| | 0975532 | 90x190cm rechts lijn-C m. Anti-Plaque | chroom/helder | 540019091352601 | stuk | 1163,00 | 281 | 1 |
| | draaideur voor nis m. vast segment | | | | | | | |
| Badkamermeubelen en toiletkasten | 0994618 | 90x190cm links lijn-C | perg./helder | 540071014321601 | stuk | 832,00 | 281 | 1 |
| | 0994626 | 90x190cm links lijn-C | chroom/helder | 540071091321601 | stuk | 984,00 | 281 | 1 |
| | 0975427 | 90x190cm links lijn-C m. Anti-Plaque | wit/helder | 540071055352601 | stuk | 1011,00 | 281 | 1 |
| | 0975419 | 90x190cm links lijn-C m. Anti-Plaque | perg./helder | 540071014352601 | stuk | 1011,00 | 281 | 1 |
| Gootstenen en wastroggen | 0975435 | 90x190cm links lijn-C m. Anti-Plaque | chroom/helder | 540071091352601 | stuk | 1163,00 | 281 | 1 |
| | 0994634 | 90x190cm rechts lijn-C | wit/helder | 540081055321601 | stuk | 832,00 | 281 | 1 |
| | 0994642 | 90x190cm rechts lijn-C | perg./helder | 540081014321601 | stuk | 832,00 | 281 | 1 |
| | 0994650 | 90x190cm rechts lijn-C | chroom/helder | 540081091321601 | stuk | 984,00 | 281 | 1 |
| Utiliteit | 0975451 | 90x190cm rechts lijn-C m. Anti-Plaque | wit/helder | 540081055352601 | stuk | 1011,00 | 281 | 1 |
| | 0975443 | 90x190cm rechts lijn-C m. Anti-Plaque | perg./helder | 540081014352601 | stuk | 1011,00 | 281 | 1 |
| | 0975478 | 90x190cm rechts lijn-C m. Anti-Plaque | chroom/helder | 540081091352601 | stuk | 1163,00 | 281 | 1 |
| | | zijwand | | | | | | |
| | 0994669 | 90x190cm links lijn-C | wit/helder | 541002055321601 | stuk | 564,00 | 281 | 1 |
| | 0994677 | 90x190cm links lijn-C | perg./helder | 541002014321601 | stuk | 564,00 | 281 | 1 |
| | 0994685 | 90x190cm links lijn-C | chroom/helder | 541002091321601 | stuk | 664,00 | 281 | 1 |
| | 0975583 | 90x190cm links lijn-C m. Anti-Plaque | wit/helder | 541002055352601 | stuk | 683,00 | 281 | 1 |
| | 0975575 | 90x190cm links lijn-C m. Anti-Plaque | perg./helder | 541002014352601 | stuk | 683,00 | 281 | 1 |
| | 0975591 | 90x190cm links lijn-C m. Anti-Plaque | chroom/helder | 541002091352601 | stuk | 783,00 | 281 | 1 |
| | 0994693 | 90x190cm rechts lijn-C | wit/helder glas | 541022055321601 | stuk | 564,00 | 281 | 1 |
| | 0994707 | 90x190cm rechts lijn-C | perg./helder | 541022014321601 | stuk | 564,00 | 281 | 1 |
| | 0994715 | 90x190cm rechts lijn-C | chroom/helder | 541022091321601 | stuk | 664,00 | 281 | 1 |
| | 0975613 | 90x190cm rechts lijn-C m. Anti-Plaque | wit/helder glas | 541022055352601 | stuk | 683,00 | 281 | 1 |
| | 0975605 | 90x190cm rechts lijn-C m. Anti-Plaque | perg./helder | 541022014352601 | stuk | 683,00 | 281 | 1 |
| | 0975621 | 90x190cm rechts lijn-C m. Anti-Plaque | chroom/helder | 541022091352601 | stuk | 783,00 | 281 | 1 |
| | douchecabine m. draaideuren | | | | | | | |
| | 0994723 | 90x190cm lijn-C | wit/helder glas | 540091055321601 | stuk | 1664,00 | 281 | 1 |
| | 0994731 | 90x190cm lijn-C | perg./helder | 540091014321601 | stuk | 1664,00 | 281 | 1 |
| | 0994758 | 90x190cm lijn-C | chroom/helder | 540091091321601 | stuk | 1938,00 | 281 | 1 |
| | 0975559 | 90x190cm lijn-C m. Anti-Plaque | wit/helder glas | 540091055352601 | stuk | 1961,00 | 281 | 1 |
| | 0975540 | 90x190cm lijn-C m. Anti-Plaque | perg./helder | 540091014352601 | stuk | 1961,00 | 281 | 1 |
| | 0975567 | 90x190cm lijn-C m. Anti-Plaque | chroom/helder | 540091091352601 | stuk | 2235,00 | 281 | 1 |

| Art.nr | Specificaties | Kleur | Lev.nr | Ehd | Prijs | Grp | CC |
|--------|---------------|-------|--------|-----|-------|-----|----|
|--------|---------------|-------|--------|-----|-------|-----|----|

Huppe 2003JJ vierhoek Walk-In

Walk-In douchecombinatie

| | | | | | | | |
|--------|--|---------------|-----------------|------|---------|-----|---|
| 777753 | 150x100x190cm links lijn-A | wit/helder | 545000055321600 | stuk | 1176,00 | 281 | 1 |
| 777754 | 150x100x190cm links lijn-A | perg/helder | 545000014321600 | stuk | 1176,00 | 281 | 1 |
| 777755 | 150x100x190cm links lijn-A | zilver/helder | 545000084321600 | stuk | 1176,00 | 281 | 1 |
| 777756 | 150x100x190cm links lijn-A | chroom/helder | 545000091321600 | stuk | 1450,00 | 281 | 1 |
| 777757 | 150x100x190cm links lijn-A m. Anti-Plaque | wit/helder | 545000055352600 | stuk | 1473,00 | 281 | 1 |
| 777758 | 150x100x190cm links lijn-A m. Anti-Plaque | perg/helder | 545000014352600 | stuk | 1473,00 | 281 | 1 |
| 777759 | 150x100x190cm links lijn-A m. Anti-Plaque | zilver/helder | 545000084352600 | stuk | 1473,00 | 281 | 1 |
| 777760 | 150x100x190cm links lijn-A m. Anti-Plaque | chroom/helder | 545000091352600 | stuk | 1747,00 | 281 | 1 |
| 777761 | 150x100x190cm links lijn-C | wit/helder | 545000055321601 | stuk | 1176,00 | 281 | 1 |
| 777762 | 150x100x190cm links lijn-C | perg/helder | 545000014321601 | stuk | 1176,00 | 281 | 1 |
| 777763 | 150x100x190cm links lijn-C | zilver/helder | 545000084321601 | stuk | 1176,00 | 281 | 1 |
| 777764 | 150x100x190cm links lijn-C | chroom/helder | 545000091321601 | stuk | 1450,00 | 281 | 1 |
| 777765 | 150x100x190cm links lijn-C m. Anti-Plaque | wit/helder | 545000055352601 | stuk | 1473,00 | 281 | 1 |
| 777766 | 150x100x190cm links lijn-C m. Anti-Plaque | perg/helder | 545000014352601 | stuk | 1473,00 | 281 | 1 |
| 777767 | 150x100x190cm links lijn-C m. Anti-Plaque | zilver/helder | 545000084352601 | stuk | 1473,00 | 281 | 1 |
| 777768 | 150x100x190cm links lijn-C m. Anti-Plaque | chroom/helder | 545000091352601 | stuk | 1747,00 | 281 | 1 |
| 777769 | 100x150x190cm rechts lijn-A | wit/helder | 545010055321600 | stuk | 1176,00 | 281 | 1 |
| 777770 | 100x150x190cm rechts lijn-A | perg/helder | 545010014321600 | stuk | 1176,00 | 281 | 1 |
| 777771 | 100x150x190cm rechts lijn-A | zilver/helder | 545010084321600 | stuk | 1176,00 | 281 | 1 |
| 777772 | 100x150x190cm rechts lijn-A | chroom/helder | 545010091321600 | stuk | 1450,00 | 281 | 1 |
| 777773 | 100x150x190cm rechts lijn-A m. Anti-Plaque | wit/helder | 545010055352600 | stuk | 1473,00 | 281 | 1 |
| 777774 | 100x150x190cm rechts lijn-A m. Anti-Plaque | perg/helder | 545010014352600 | stuk | 1473,00 | 281 | 1 |
| 777775 | 100x150x190cm rechts lijn-A m. Anti-Plaque | zilver/helder | 545010084352600 | stuk | 1473,00 | 281 | 1 |
| 777776 | 100x150x190cm rechts lijn-A m. Anti-Plaque | chroom/helder | 545010091352600 | stuk | 1747,00 | 281 | 1 |
| 777777 | 100x150x190cm rechts lijn-C | wit/helder | 545010055321601 | stuk | 1176,00 | 281 | 1 |
| 777778 | 100x150x190cm rechts lijn-C | perg/helder | 545010014321601 | stuk | 1176,00 | 281 | 1 |
| 777779 | 100x150x190cm rechts lijn-C | zilver/helder | 545010084321601 | stuk | 1176,00 | 281 | 1 |
| 777780 | 100x150x190cm rechts lijn-C | chroom/helder | 545010091321601 | stuk | 1450,00 | 281 | 1 |
| 777781 | 100x150x190cm rechts lijn-C m. Anti-Plaque | wit/helder | 545010055352601 | stuk | 1473,00 | 281 | 1 |
| 777782 | 100x150x190cm rechts lijn-C m. Anti-Plaque | perg/helder | 545010014352601 | stuk | 1473,00 | 281 | 1 |
| 777783 | 100x150x190cm rechts lijn-C m. Anti-Plaque | zilver/helder | 545010084352601 | stuk | 1473,00 | 281 | 1 |
| 777784 | 100x150x190cm rechts lijn-C m. Anti-Plaque | chroom/helder | 545010091352601 | stuk | 1747,00 | 281 | 1 |

Walk-In douchebak

| | | | | | | | |
|--------|------------------|----------|-----------|------|--------|-----|---|
| 777785 | 150x100cm rechts | wit | 545100055 | stuk | 494,00 | 281 | 1 |
| 777786 | 150x100cm rechts | pergamon | 545100014 | stuk | 494,00 | 281 | 1 |
| 777787 | 100x150cm links | wit | 545110055 | stuk | 494,00 | 281 | 1 |
| 777788 | 100x150cm links | pergamon | 545110014 | stuk | 494,00 | 281 | 1 |

Huppe 2003JJ vijfhoek

douchecabine vijfhoekig m. draaideur v. Marano/Classique

| | | | | | | | |
|---------|--|-----------------|-----------------|------|---------|-----|---|
| 0994766 | 90x190cm links lijn-C instap 60cm | wit/helder glas | 542000055321601 | stuk | 1664,00 | 281 | 1 |
| 0994774 | 90x190cm links lijn-C instap 60cm | perg./helder | 542000014321601 | stuk | 1664,00 | 281 | 1 |
| 0994782 | 90x190cm links lijn-C instap 60cm | chroom/helder | 542000091321601 | stuk | 1938,00 | 281 | 1 |
| 0974595 | 90x190cm links lijn-C m. Anti-Pl. instap 60cm | wit/helder glas | 542000055352601 | stuk | 1961,00 | 281 | 1 |
| 0974587 | 90x190cm links lijn-C m. Anti-Pl. instap 60cm | perg./helder | 542000014352601 | stuk | 1961,00 | 281 | 1 |
| 0974609 | 90x190cm links lijn-C m. Anti-Pl. instap 60cm | chroom/helder | 542000091352601 | stuk | 2235,00 | 281 | 1 |
| 0994790 | 90x190cm rechts lijn-C instap 60cm | wit/helder glas | 542200055321601 | stuk | 1664,00 | 281 | 1 |
| 0994804 | 90x190cm rechts lijn-C instap 60cm | perg./helder | 542200014321601 | stuk | 1664,00 | 281 | 1 |
| 0994812 | 90x190cm rechts lijn-C instap 60cm | chroom/helder | 542200091321601 | stuk | 1938,00 | 281 | 1 |
| 0974692 | 90x190cm rechts lijn-C m. Anti-Pl. instap 60cm | wit/helder glas | 542200055352601 | stuk | 1961,00 | 281 | 1 |
| 0974684 | 90x190cm rechts lijn-C m. Anti-Pl. instap 60cm | perg./helder | 542200014352601 | stuk | 1961,00 | 281 | 1 |
| 0974706 | 90x190cm rechts lijn-C m. Anti-Pl. instap 60cm | chroom/helder | 542200091352601 | stuk | 2235,00 | 281 | 1 |

douchecabine vijfhoekig m. draaideur

| | | | | | | | |
|---------|--|-----------------|-----------------|------|---------|-----|---|
| 0994820 | 90x190cm links lijn-C instap 48cm | wit/helder glas | 542080055321601 | stuk | 1664,00 | 281 | 1 |
| 0994839 | 90x190cm links lijn-C instap 48cm | perg./helder | 542080014321601 | stuk | 1664,00 | 281 | 1 |
| 0994847 | 90x190cm links lijn-C instap 48cm | chroom/helder | 542080091321601 | stuk | 1938,00 | 281 | 1 |
| 0974625 | 90x190cm links lijn-C m. Anti-Pl. instap 48cm | wit/helder glas | 542080055352601 | stuk | 1961,00 | 281 | 1 |
| 0974617 | 90x190cm links lijn-C m. Anti-Pl. instap 48cm | perg./helder | 542080014352601 | stuk | 1961,00 | 281 | 1 |
| 0974633 | 90x190cm links lijn-C m. Anti-Pl. instap 48cm | chroom/helder | 542080091352601 | stuk | 2235,00 | 281 | 1 |
| 0994855 | 90x190cm rechts lijn-C instap 48cm | wit/helder glas | 542280055321601 | stuk | 1664,00 | 281 | 1 |
| 0994863 | 90x190cm rechts lijn-C instap 48cm | perg./helder | 542280014321601 | stuk | 1664,00 | 281 | 1 |
| 0994871 | 90x190cm rechts lijn-C instap 48cm | chroom/helder | 542280091321601 | stuk | 1938,00 | 281 | 1 |
| 0974730 | 90x190cm rechts lijn-C m. Anti-Pl. instap 48cm | wit/helder glas | 542280055352601 | stuk | 1961,00 | 281 | 1 |
| 0974722 | 90x190cm rechts lijn-C m. Anti-Pl. instap 48cm | perg./helder | 542280014352601 | stuk | 1961,00 | 281 | 1 |
| 0974749 | 90x190cm rechts lijn-C m. Anti-Pl. instap 48cm | chroom/helder | 542280091352601 | stuk | 2235,00 | 281 | 1 |



Sanitair producten

Baden /
douchebakken /
stoomcabines

Kranen

Douchegarnituur

Accessoires en
spiegels

Douchewanden

Toebehoren &
afvoeren

Spoel- &
installatiesystemen

Badkamermeubelen
en toiletkasten

Gootstenen en
wastroggen

Utiliteit

Huppe 2003JJ vijfhoek

douchecabine vijfhoekig m. draaideur v. Marano

| | | | | | | | | |
|---------|-----------|---------------------------------------|-----------------|-----------------|------|---------|-----|---|
| 0994898 | 100x190cm | links lijn-C instap 67cm | wit/helder glas | 542150055321601 | stuk | 1664,00 | 281 | 1 |
| 0994901 | 100x190cm | links lijn-C instap 67cm | perg./helder | 542150014321601 | stuk | 1664,00 | 281 | 1 |
| 0994928 | 100x190cm | links lijn-C instap 67cm | chroom/helder | 542150091321601 | stuk | 1938,00 | 281 | 1 |
| 0974668 | 100x190cm | links lijn-C m. Anti-Pl. instap 67cm | wit/helder glas | 542150055352601 | stuk | 1961,00 | 281 | 1 |
| 0974641 | 100x190cm | links lijn-C m. Anti-Pl. instap 67cm | perg./helder | 542150014352601 | stuk | 1961,00 | 281 | 1 |
| 0974676 | 100x190cm | links lijn-C m. Anti-Pl. instap 67cm | chroom/helder | 542150091352601 | stuk | 2235,00 | 281 | 1 |
| 0994936 | 100x190cm | rechts lijn-C instap 67cm | wit/helder glas | 542350055321601 | stuk | 1664,00 | 281 | 1 |
| 0994944 | 100x190cm | rechts lijn-C instap 67cm | perg./helder | 542350014321601 | stuk | 1664,00 | 281 | 1 |
| 0994952 | 100x190cm | rechts lijn-C instap 67cm | chroom/helder | 542350091321601 | stuk | 1938,00 | 281 | 1 |
| 0974765 | 100x190cm | rechts lijn-C m. Anti-Pl. instap 67cm | wit/helder glas | 542350055352601 | stuk | 1961,00 | 281 | 1 |
| 0974757 | 100x190cm | rechts lijn-C m. Anti-Pl. instap 67cm | perg./helder | 542350014352601 | stuk | 1961,00 | 281 | 1 |
| 0974773 | 100x190cm | rechts lijn-C m. Anti-Pl. instap 67cm | chroom/helder | 542350091352601 | stuk | 2235,00 | 281 | 1 |

Huppe 2003JJ kwartrond

douchecabine kwartrond m. draaideur v. Classique

| | | | | | | | | |
|---------|----------|------------------------------|-----------------|-----------------|------|---------|-----|---|
| 0994960 | 90x190cm | links lijn-C | wit/helder glas | 543100055321601 | stuk | 1664,00 | 281 | 1 |
| 0994979 | 90x190cm | links lijn-C | perg./helder | 543100014321601 | stuk | 1664,00 | 281 | 1 |
| 0994987 | 90x190cm | links lijn-C | chroom/helder | 543100091321601 | stuk | 1938,00 | 281 | 1 |
| 0973866 | 90x190cm | links lijn-C m. Anti-Plaque | wit/helder glas | 543100055352601 | stuk | 1961,00 | 281 | 1 |
| 0973858 | 90x190cm | links lijn-C m. Anti-Plaque | perg./helder | 543100014352601 | stuk | 1961,00 | 281 | 1 |
| 0973874 | 90x190cm | links lijn-C m. Anti-Plaque | chroom/helder | 543100091352601 | stuk | 2235,00 | 281 | 1 |
| 0994995 | 90x190cm | rechts lijn-C | wit/helder glas | 543500055321601 | stuk | 1664,00 | 281 | 1 |
| 0993611 | 90x190cm | rechts lijn-C | perg./helder | 543500014321601 | stuk | 1664,00 | 281 | 1 |
| 0995010 | 90x190cm | rechts lijn-C | chroom/helder | 543500091321601 | stuk | 1938,00 | 281 | 1 |
| 0973955 | 90x190cm | rechts lijn-C m. Anti-Plaque | wit/helder glas | 543500055352601 | stuk | 1961,00 | 281 | 1 |
| 0973947 | 90x190cm | rechts lijn-C m. Anti-Plaque | perg./helder | 543500014352601 | stuk | 1961,00 | 281 | 1 |
| 0973963 | 90x190cm | rechts lijn-C m. Anti-Plaque | chroom/helder | 543500091352601 | stuk | 2235,00 | 281 | 1 |

douchecabine kwartrond m. draaideur

| | | | | | | | | |
|---------|----------|------------------------------|-----------------|-----------------|------|---------|-----|---|
| 0995029 | 90x190cm | links lijn-C | wit/helder glas | 543120055321601 | stuk | 1664,00 | 281 | 1 |
| 0995037 | 90x190cm | links lijn-C | perg./helder | 543120014321601 | stuk | 1664,00 | 281 | 1 |
| 0995045 | 90x190cm | links lijn-C | chroom/helder | 543120091321601 | stuk | 1938,00 | 281 | 1 |
| 0973890 | 90x190cm | links lijn-C m. Anti-Plaque | wit/helder glas | 543120055352601 | stuk | 1961,00 | 281 | 1 |
| 0973882 | 90x190cm | links lijn-C m. Anti-Plaque | perg./helder | 543120014352601 | stuk | 1961,00 | 281 | 1 |
| 0973904 | 90x190cm | links lijn-C m. Anti-Plaque | chroom/helder | 543120091352601 | stuk | 2235,00 | 281 | 1 |
| 0995053 | 90x190cm | rechts lijn-C | wit/helder glas | 543520055321601 | stuk | 1664,00 | 281 | 1 |
| 0995061 | 90x190cm | rechts lijn-C | perg./helder | 543520014321601 | stuk | 1664,00 | 281 | 1 |
| 0995088 | 90x190cm | rechts lijn-C | chroom/helder | 543520091321601 | stuk | 1938,00 | 281 | 1 |
| 0973998 | 90x190cm | rechts lijn-C m. Anti-Plaque | wit/helder glas | 543520055352601 | stuk | 1961,00 | 281 | 1 |
| 0973971 | 90x190cm | rechts lijn-C m. Anti-Plaque | perg./helder | 543520014352601 | stuk | 1961,00 | 281 | 1 |
| 0974005 | 90x190cm | rechts lijn-C m. Anti-Plaque | chroom/helder | 543520091352601 | stuk | 2235,00 | 281 | 1 |

douchecabine kwartrond m. draaideur v. Marano/Purano

| | | | | | | | | |
|---------|-----------|------------------------------|-----------------|-----------------|------|---------|-----|---|
| 0995096 | 100x190cm | links lijn-C | wit/helder glas | 543150055321601 | stuk | 1664,00 | 281 | 1 |
| 0995118 | 100x190cm | links lijn-C | perg./helder | 543150014321601 | stuk | 1664,00 | 281 | 1 |
| 0995126 | 100x190cm | links lijn-C | chroom/helder | 543150091321601 | stuk | 1938,00 | 281 | 1 |
| 0973920 | 100x190cm | links lijn-C m. Anti-Plaque | wit/helder glas | 543150055352601 | stuk | 1961,00 | 281 | 1 |
| 0973912 | 100x190cm | links lijn-C m. Anti-Plaque | perg./helder | 543150014352601 | stuk | 1961,00 | 281 | 1 |
| 0973939 | 100x190cm | links lijn-C m. Anti-Plaque | chroom/helder | 543150091352601 | stuk | 2235,00 | 281 | 1 |
| 0995134 | 100x190cm | rechts lijn-C | wit/helder glas | 543550055321601 | stuk | 1664,00 | 281 | 1 |
| 0995142 | 100x190cm | rechts lijn-C | perg./helder | 543550014321601 | stuk | 1664,00 | 281 | 1 |
| 0996815 | 100x190cm | rechts lijn-C | chroom/helder | 543550091321601 | stuk | 1938,00 | 281 | 1 |
| 0974021 | 100x190cm | rechts lijn-C m. Anti-Plaque | wit/helder glas | 543550055352601 | stuk | 1961,00 | 281 | 1 |
| 0974013 | 100x190cm | rechts lijn-C m. Anti-Plaque | perg./helder | 543550014352601 | stuk | 1961,00 | 281 | 1 |
| 0974048 | 100x190cm | rechts lijn-C m. Anti-Plaque | chroom/helder | 543550091352601 | stuk | 2235,00 | 281 | 1 |

Huppe 3000 Magna

douchecabine kwartrond m. draaideur

| | | | | | | | | |
|---------|-----------|----------------|-----------------|--------------|------|---------|-----|---|
| 0997927 | 90x190cm | | wit/helder glas | 572001055321 | stuk | 2017,00 | 281 | 1 |
| 0997935 | 90x190cm | | perg./helder | 572001014321 | stuk | 2017,00 | 281 | 1 |
| 0997919 | 90x190cm | | chroom/helder | 572001091321 | stuk | 2514,00 | 281 | 1 |
| 0974420 | 90x190cm | m. Anti-Plaque | wit/helder glas | 572001055322 | stuk | 2314,00 | 281 | 1 |
| 0974412 | 90x190cm | m. Anti-Plaque | perg./helder | 572001014322 | stuk | 2314,00 | 281 | 1 |
| 0974439 | 90x190cm | m. Anti-Plaque | chroom/helder | 572001091322 | stuk | 2811,00 | 281 | 1 |
| 0361704 | 100x190cm | | wit/helder glas | 572002055321 | stuk | 2017,00 | 281 | 1 |
| 0361690 | 100x190cm | | chroom/helder | 572002091321 | stuk | 2514,00 | 281 | 1 |
| 0361712 | 100x190cm | m. Anti-Plaque | wit/helder glas | 572002055322 | stuk | 2314,00 | 281 | 1 |
| 0361720 | 100x190cm | m. Anti-Plaque | chroom/helder | 572002091322 | stuk | 2811,00 | 281 | 1 |

| Art.nr | Specificaties | Kleur | Lev.nr | Ehd | Prijs | Grp | CC |
|--|-----------------------------------|----------|-------------|------|--------|-----|----|
| Huppe 3000 Magna | | | | | | | |
| kunststof douchebak acryl Magna3000 | | | | | | | |
| 0997943 | 90x90cm links kwartrond | wit | 572100055 | stuk | 576,00 | 281 | 1 |
| 0997951 | 90x90cm links kwartrond | pergamon | 572100014 | stuk | 576,00 | 281 | 1 |
| 0997978 | 90x90cm rechts kwartrond | wit | 572101055 | stuk | 576,00 | 281 | 1 |
| 0997986 | 90x90cm rechts kwartrond | pergamon | 572101014 | stuk | 576,00 | 281 | 1 |
| Huppe toebehoren | | | | | | | |
| 0982974 | verlengbeugel 44.5cm wit | | 406153055 | stuk | 47,25 | 281 | 1 |
| 0982975 | verlengbeugel 44.5cm pergamon | | 406153014 | stuk | 47,25 | 281 | 1 |
| 0982977 | verlengbeugel 44.5cm titan zilver | | 406153084 | stuk | 47,25 | 281 | 1 |
| 0982976 | verlengbeugel 44.5cm chroom | | 406153091 | stuk | 47,25 | 281 | 1 |
| 0982978 | verlengbeugel 54.5cm wit | | 406152055 | stuk | 47,25 | 281 | 1 |
| 0982979 | verlengbeugel 54.5cm pergamon | | 406152014 | stuk | 47,25 | 281 | 1 |
| 0982981 | verlengbeugel 54.5cm titan zilver | | 406152084 | stuk | 47,25 | 281 | 1 |
| 0982980 | verlengbeugel 54.5cm chroom | | 406152091 | stuk | 47,25 | 281 | 1 |
| 0982982 | verlengbeugel 74.5cm wit | | 406154055 | stuk | 58,00 | 281 | 1 |
| 0982986 | verlengbeugel 74.5cm pergamon | | 406154014 | stuk | 58,00 | 281 | 1 |
| 0982988 | verlengbeugel 74.5cm titan zilver | | 406154084 | stuk | 58,00 | 281 | 1 |
| 0982987 | verlengbeugel 74.5cm chroom | | 406154091 | stuk | 58,00 | 281 | 1 |
| 0984478 | afwateringsstrip per meter 6mm | | 65665034000 | stuk | 29,00 | 281 | 1 |
| 0984479 | afwateringsstrip per meter 8mm | | 65664034000 | stuk | 29,00 | 281 | 1 |

Sanitair producten

Baden /
douchebakken /
stoomcabines

Kranen

Douchegarnituur

Accessoires en
spiegels

Douchewanden

Toebehoren &
afvoerenSpoel- &
installatiesystemenBadkamermeubelen
en toiletkastenGootstenen en
wastroggen

Utiliteit

| | Art.nr | Specificaties | Kleur | Lev.nr | Ehd | Prijs | Grp | CC |
|---|---|-------------------|--------------|---------|------|---------|-----|----|
| | Keramag JOOP! douchewanden | | | | | | | |
| | douchewand U-combinatie m. draaideur m. 2 vaste wanden scharnier | | | | | | | |
| Sanitair producten | 0340047 | 90x90x195 links | helder glas | 0340047 | stuk | 3362,00 | 112 | 1 |
| | 0340048 | 90x90x195 links | helder glas+ | 0340048 | stuk | 3395,00 | 112 | 1 |
| | 0340055 | 90x120x195 links | helder glas | 0340055 | stuk | 3583,00 | 112 | 1 |
| | 0340056 | 90x120x195 links | helder glas+ | 0340056 | stuk | 3595,00 | 112 | 1 |
| Baden / douchebakken / stoomcabines | 0340045 | 90x90x195 rechts | helder glas | 0340045 | stuk | 3362,00 | 112 | 1 |
| | 0340046 | 90x90x195 rechts | helder glas+ | 0340046 | stuk | 3395,00 | 112 | 1 |
| | 0340049 | 90x100x195 rechts | helder glas | 0340049 | stuk | 3473,00 | 112 | 1 |
| | 0340053 | 90x120x195 rechts | helder glas | 0340053 | stuk | 3583,00 | 112 | 1 |
| | 0340054 | 90x120x195 rechts | helder glas+ | 0340054 | stuk | 3595,00 | 112 | 1 |
| Kranen | draaideur voor hoekinstap | | | | | | | |
| | 0340057 | 90x195cm links | helder glas | 0340057 | stuk | 1268,00 | 112 | 1 |
| | 0340058 | 90x195cm links | helder glas+ | 0340058 | stuk | 1380,00 | 112 | 1 |
| | 0340061 | 100x195cm links | helder glas | 0340061 | stuk | 1379,00 | 112 | 1 |
| Douchegarnituur | 0340062 | 100x195cm links | helder glas+ | 0340062 | stuk | 1480,00 | 112 | 1 |
| | 0340065 | 120x195cm links | helder glas | 0340065 | stuk | 1489,00 | 112 | 1 |
| | 0340066 | 120x195cm links | helder glas+ | 0340066 | stuk | 1580,00 | 112 | 1 |
| | 0340059 | 90x195cm rechts | helder glas | 0340059 | stuk | 1268,00 | 112 | 1 |
| Accessoires en spiegels | 0340060 | 90x195cm rechts | helder glas+ | 0340060 | stuk | 1380,00 | 112 | 1 |
| | 0340063 | 100x195cm rechts | helder glas | 0340063 | stuk | 1379,00 | 112 | 1 |
| | 0340064 | 100x195cm rechts | helder glas+ | 0340064 | stuk | 1480,00 | 112 | 1 |
| | 0340067 | 120x195cm rechts | helder glas | 0340067 | stuk | 1489,00 | 112 | 1 |
| | 0340068 | 120x195cm rechts | helder glas+ | 0340068 | stuk | 1580,00 | 112 | 1 |
| Douchewanden | draaideur voor nis | | | | | | | |
| | 0340069 | 90x195cm links | helder glas | 0340069 | stuk | 1268,00 | 112 | 1 |
| | 0340070 | 90x195cm links | helder glas+ | 0340070 | stuk | 1265,00 | 112 | 1 |
| | 0340083 | 100x195cm links | helder glas | 0340083 | stuk | 1379,00 | 112 | 1 |
| Toebehoren & afvoeren | 0340084 | 100x195cm links | helder glas+ | 0340084 | stuk | 1365,00 | 112 | 1 |
| | 0340087 | 120x195cm links | helder glas | 0340087 | stuk | 1489,00 | 112 | 1 |
| | 0340088 | 120x195cm links | helder glas+ | 0340088 | stuk | 1465,00 | 112 | 1 |
| | 0340071 | 90x195cm rechts | helder glas | 0340071 | stuk | 1268,00 | 112 | 1 |
| | 0340082 | 90x195cm rechts | helder glas+ | 0340082 | stuk | 1265,00 | 112 | 1 |
| Spoel- & installatiesystemen | 0340085 | 100x195cm rechts | helder glas | 0340085 | stuk | 1379,00 | 112 | 1 |
| | 0340086 | 100x195cm rechts | helder glas+ | 0340086 | stuk | 1365,00 | 112 | 1 |
| | 0340089 | 120x195cm rechts | helder glas | 0340089 | stuk | 1489,00 | 112 | 1 |
| | 0340090 | 120x195cm rechts | helder glas+ | 0340090 | stuk | 1465,00 | 112 | 1 |
| Badkamermeubelen en toiletkasten | draaideur links m. vaste wand | | | | | | | |
| | 0340093 | 90x90x195 | helder glas | 0340093 | stuk | 2315,00 | 112 | 1 |
| | 0340094 | 90x90x195 | helder glas+ | 0340094 | stuk | 2330,00 | 112 | 1 |
| | 0340097 | 100x90x195 | helder glas | 0340097 | stuk | 2425,00 | 112 | 1 |
| | 0340098 | 100x90x195 | helder glas+ | 0340098 | stuk | 2430,00 | 112 | 1 |
| Gootstenen en wastroggen | 0340101 | 120x90x195 | helder glas | 0340101 | stuk | 2535,00 | 112 | 1 |
| | 0340102 | 120x90x195 | helder glas+ | 0340102 | stuk | 2530,00 | 112 | 1 |
| | draaideur rechts m. zijwand | | | | | | | |
| | 0340091 | 90x90x195 | helder glas | 0340091 | stuk | 2315,00 | 112 | 1 |
| | 0340092 | 90x90x195 | helder glas+ | 0340092 | stuk | 2330,00 | 112 | 1 |
| | 0340095 | 100x90x195 | helder glas | 0340095 | stuk | 2425,00 | 112 | 1 |
| | 0340096 | 100x90x195 | helder glas+ | 0340096 | stuk | 2430,00 | 112 | 1 |
| | 0340099 | 120x90x195 | helder glas | 0340099 | stuk | 2535,00 | 112 | 1 |
| Utiliteit | 0340100 | 120x90x195 | helder glas+ | 0340100 | stuk | 2530,00 | 112 | 1 |

| Art.nr | Specificaties | Kleur | Lev.nr | Ehd | Prijs | Grp | CC |
|--|--------------------------------|--------------------|--------------|------|---------|-----|----|
| Kermi Aska XP | | | | | | | |
| douchecabine kwartrond m. deur | | | | | | | |
| 0980712 | 90x185cm links | zilvermat/helder | AX55L090181A | stuk | 1443,00 | 284 | 1 |
| 0980710 | 90x185cm links | wit/helder glas | AX55L090182A | stuk | 1519,00 | 284 | 1 |
| 0980754 | 90x185cm links | glanszilver/helder | AX55L09018VA | stuk | 1745,00 | 284 | 1 |
| 0980745 | 90x185cm links m. KermiClean | zilvermat/helder | AX55L090181P | stuk | 1715,00 | 284 | 1 |
| 0980711 | 90x185cm links m. KermiClean | wit/helder glas | AX55L090182P | stuk | 1791,00 | 284 | 1 |
| 0980755 | 90x185cm links m. KermiClean | glanszilver/helder | AX55L09018VP | stuk | 2018,00 | 284 | 1 |
| 0980770 | 100x185cm links | zilvermat/helder | AX55L101181A | stuk | 1659,00 | 284 | 1 |
| 0980768 | 100x185cm links | wit/helder glas | AX55L101182A | stuk | 1746,00 | 284 | 1 |
| 0980772 | 100x185cm links | glanszilver/helder | AX55L10118VA | stuk | 2006,00 | 284 | 1 |
| 0980771 | 100x185cm links m. KermiClean | zilvermat/helder | AX55L101181P | stuk | 1932,00 | 284 | 1 |
| 0980769 | 100x185cm links m. KermiClean | wit/helder glas | AX55L101182P | stuk | 2019,00 | 284 | 1 |
| 0980773 | 100x185cm links m. KermiClean | glanszilver/helder | AX55L10118VP | stuk | 2279,00 | 284 | 1 |
| 0980704 | 90x185cm rechts | zilvermat/helder | AX55R090181A | stuk | 1443,00 | 284 | 0 |
| 0980702 | 90x185cm rechts | wit/helder glas | AX55R090182A | stuk | 1519,00 | 284 | 1 |
| 0980708 | 90x185cm rechts | glanszilver/helder | AX55R09018VA | stuk | 1745,00 | 284 | 1 |
| 0980707 | 90x185cm rechts m. KermiClean | zilvermat/helder | AX55R090181P | stuk | 1715,00 | 284 | 1 |
| 0980703 | 90x185cm rechts m. KermiClean | wit/helder glas | AX55R090182P | stuk | 1791,00 | 284 | 1 |
| 0980709 | 90x185cm rechts m. KermiClean | glanszilver/helder | AX55R09018VP | stuk | 2018,00 | 284 | 1 |
| 0980764 | 100x185cm rechts | zilvermat/helder | AX55R101181A | stuk | 1659,00 | 284 | 1 |
| 0980762 | 100x185cm rechts | wit/helder glas | AX55R101182A | stuk | 1746,00 | 284 | 1 |
| 0980766 | 100x185cm rechts | glanszilver/helder | AX55R10118VA | stuk | 2006,00 | 284 | 1 |
| 0980765 | 100x185cm rechts m. KermiClean | zilvermat/helder | AX55R101181P | stuk | 1932,00 | 284 | 1 |
| 0980763 | 100x185cm rechts m. KermiClean | wit/helder glas | AX55R101182P | stuk | 2019,00 | 284 | 1 |
| 0980767 | 100x185cm rechts m. KermiClean | glanszilver/helder | AX55R10118VP | stuk | 2279,00 | 284 | 1 |
| douchecabine kwartrond m. pendel deur | | | | | | | |
| 0980758 | 90x185cm | zilvermat/helder | AXE55090181A | stuk | 1443,00 | 284 | 1 |
| 0980756 | 90x185cm | wit/helder glas | AXE55090182A | stuk | 1519,00 | 284 | 1 |
| 0980760 | 90x185cm | glanszilver/helder | AXE5509018VA | stuk | 1745,00 | 284 | 1 |
| 0980759 | 90x185cm m. KermiClean | zilvermat/helder | AXE55090181P | stuk | 1715,00 | 284 | 1 |
| 0980757 | 90x185cm m. KermiClean | wit/helder glas | AXE55090182P | stuk | 1791,00 | 284 | 1 |
| 0980761 | 90x185cm m. KermiClean | glanszilver/helder | AXE5509018VP | stuk | 2018,00 | 284 | 1 |
| 0980776 | 100x185cm | zilvermat/helder | AXE55101181A | stuk | 1659,00 | 284 | 1 |
| 0980774 | 100x185cm | wit/helder glas | AXE55101182A | stuk | 1746,00 | 284 | 1 |
| 0980778 | 100x185cm | glanszilver/helder | AXE5510118VA | stuk | 2006,00 | 284 | 1 |
| 0980777 | 100x185cm m. KermiClean | zilvermat/helder | AXE55101181P | stuk | 1932,00 | 284 | 1 |
| 0980775 | 100x185cm m. KermiClean | wit/helder glas | AXE55101182P | stuk | 2019,00 | 284 | 1 |
| 0980779 | 100x185cm m. KermiClean | glanszilver/helder | AXE5510118VP | stuk | 2279,00 | 284 | 1 |

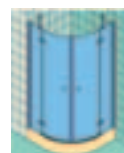
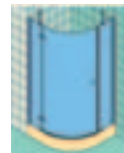

Sanitair producten

Baden /
douchebakken /
stoomcabines

Kranen

Douchegarnituur

Accessoires en
spiegels

Douchewanden

Toebehoren &
afvoerenSpoel- &
installatiesystemenBadkamermeubelen
en toiletkastenGootstenen en
wastroggen

Utiliteit

| Art.nr | Specificaties | Kleur | Lev.nr | Ehd | Prijs | Grp | CC |
|---|---------------|--------------------------------|--------------------|--------------|-------|---------|-------|
| Kermi Aska XP | | | | | | | |
| draaideur m. vast segment | | | | | | | |
| Sanitair producten | 0980660 | 88x185cm links | zilvermat/helder | AXESL088181A | stuk | 721,00 | 284 1 |
| | 0980656 | 88x185cm links | wit/helder glas | AXESL088182A | stuk | 759,00 | 284 1 |
| Baden / douchebakken / stoomcabines | 0980662 | 88x185cm links | glanszilver/helder | AXESL08818VA | stuk | 873,00 | 284 1 |
| | 0980661 | 88x185cm links m. KermiClean | zilvermat/helder | AXESL088181P | stuk | 874,00 | 284 1 |
| | 0980657 | 88x185cm links m. KermiClean | wit/helder glas | AXESL088182P | stuk | 912,00 | 284 1 |
| | 0980663 | 88x185cm links m. KermiClean | glanszilver/helder | AXESL08818VP | stuk | 1025,00 | 284 1 |
| | 0980675 | 90x185cm links | zilvermat/helder | AXESL090181A | stuk | 721,00 | 284 1 |
| | 0980670 | 90x185cm links | wit/helder glas | AXESL090182A | stuk | 759,00 | 284 1 |
| Kranen | 0980678 | 90x185cm links | glanszilver/helder | AXESL09018VA | stuk | 873,00 | 284 1 |
| | 0980677 | 90x185cm links m. KermiClean | zilvermat/helder | AXESL090181P | stuk | 874,00 | 284 1 |
| | 0980673 | 90x185cm links m. KermiClean | wit/helder glas | AXESL090182P | stuk | 912,00 | 284 1 |
| | 0980679 | 90x185cm links m. KermiClean | glanszilver/helder | AXESL09018VP | stuk | 1025,00 | 284 1 |
| Douchegarnituur | 0980697 | 100x185cm links | zilvermat/helder | AXESL100181A | stuk | 815,00 | 284 1 |
| | 0980695 | 100x185cm links | wit/helder glas | AXESL100182A | stuk | 858,00 | 284 1 |
| | 0980699 | 100x185cm links | glanszilver/helder | AXESL10018VA | stuk | 987,00 | 284 1 |
| | 0980698 | 100x185cm links m. KermiClean | zilvermat/helder | AXESL100181P | stuk | 968,00 | 284 1 |
| Accessoires en spiegels | 0980696 | 100x185cm links m. KermiClean | wit/helder glas | AXESL100182P | stuk | 1011,00 | 284 1 |
| | 0980701 | 100x185cm links m. KermiClean | glanszilver/helder | AXESL10018VP | stuk | 1139,00 | 284 1 |
| | 0980650 | 88x185cm rechts | zilvermat/helder | AXESR088181A | stuk | 721,00 | 284 1 |
| | 0980648 | 88x185cm rechts | wit/helder glas | AXESR088182A | stuk | 759,00 | 284 1 |
| Douchewanden | 0980654 | 88x185cm rechts | glanszilver/helder | AXESR08818VA | stuk | 873,00 | 284 1 |
| | 0980651 | 88x185cm rechts m. KermiClean | zilvermat/helder | AXESR088181P | stuk | 874,00 | 284 1 |
| | 0980649 | 88x185cm rechts m. KermiClean | wit/helder glas | AXESR088182P | stuk | 912,00 | 284 1 |
| | 0980655 | 88x185cm rechts m. KermiClean | glanszilver/helder | AXESR08818VP | stuk | 1025,00 | 284 1 |
| | 0980666 | 90x185cm rechts | zilvermat/helder | AXESR090181A | stuk | 721,00 | 284 1 |
| | 0980664 | 90x185cm rechts | wit/helder glas | AXESR090182A | stuk | 759,00 | 284 1 |
| | 0980668 | 90x185cm rechts | glanszilver/helder | AXESR09018VA | stuk | 873,00 | 284 1 |
| | 0980667 | 90x185cm rechts m. KermiClean | zilvermat/helder | AXESR090181P | stuk | 874,00 | 284 1 |
| Toebehoren & afvoeren | 0980665 | 90x185cm rechts m. KermiClean | wit/helder glas | AXESR090182P | stuk | 912,00 | 284 1 |
| | 0980669 | 90x185cm rechts m. KermiClean | glanszilver/helder | AXESR09018VP | stuk | 1025,00 | 284 1 |
| | 0980687 | 100x185cm rechts | zilvermat/helder | AXESR100181A | stuk | 815,00 | 284 1 |
| Spoel- & installatiesystemen | 0980680 | 100x185cm rechts | wit/helder glas | AXESR100182A | stuk | 858,00 | 284 1 |
| | 0980691 | 100x185cm rechts | glanszilver/helder | AXESR10018VA | stuk | 987,00 | 284 1 |
| | 0980688 | 100x185cm rechts m. KermiClean | zilvermat/helder | AXESR100181P | stuk | 968,00 | 284 1 |
| Badkamermeubelen en toiletkasten | 0980686 | 100x185cm rechts m. KermiClean | wit/helder glas | AXESR100182P | stuk | 1011,00 | 284 1 |
| | 0980694 | 100x185cm rechts m. KermiClean | glanszilver/helder | AXESR10018VP | stuk | 1139,00 | 284 1 |

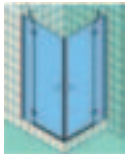

| Art.nr | Specificaties | Kleur | Lev.nr | Ehd | Prijs | Grp | CC |
|--|-------------------------------------|--------------------|--------------|------|---------|-----|----|
| Kermi Aska XP | | | | | | | |
| douchecabine vijfhoekig m. deur | | | | | | | |
| 0980788 | 90x185cm (40) links | zilvermat/helder | AXL40090181A | stuk | 1470,00 | 284 | 1 |
| 0980786 | 90x185cm (40) links | wit/helder glas | AXL40090182A | stuk | 1548,00 | 284 | 1 |
| 0980790 | 90x185cm (40) links | glanszilver/helder | AXL4009018VA | stuk | 1780,00 | 284 | 1 |
| 0980789 | 90x185cm (40) links m. KermiClean | zilvermat/helder | AXL40090181P | stuk | 1743,00 | 284 | 1 |
| 0980787 | 90x185cm (40) links m. KermiClean | wit/helder glas | AXL40090182P | stuk | 1821,00 | 284 | 1 |
| 0980791 | 90x185cm (40) links m. KermiClean | glanszilver/helder | AXL4009018VP | stuk | 2053,00 | 284 | 1 |
| 0980800 | 90x185cm (45) links | zilvermat/helder | AXL45090181A | stuk | 1470,00 | 284 | 1 |
| 0980798 | 90x185cm (45) links | wit/helder glas | AXL45090182A | stuk | 1548,00 | 284 | 1 |
| 0980802 | 90x185cm (45) links | glanszilver/helder | AXL4509018VA | stuk | 1780,00 | 284 | 1 |
| 0980801 | 90x185cm (45) links m. KermiClean | zilvermat/helder | AXL45090181P | stuk | 1743,00 | 284 | 1 |
| 0980799 | 90x185cm (45) links m. KermiClean | wit/helder glas | AXL45090182P | stuk | 1821,00 | 284 | 1 |
| 0980803 | 90x185cm (45) links m. KermiClean | glanszilver/helder | AXL4509018VP | stuk | 2053,00 | 284 | 1 |
| 0980812 | 100x185cm (50) links | zilvermat/helder | AXL50100181A | stuk | 1618,00 | 284 | 1 |
| 0980810 | 100x185cm (50) links | wit/helder glas | AXL50100182A | stuk | 1703,00 | 284 | 1 |
| 0980814 | 100x185cm (50) links | glanszilver/helder | AXL5010018VA | stuk | 1957,00 | 284 | 1 |
| 0980813 | 100x185cm (50) links m. KermiClean | zilvermat/helder | AXL50100181P | stuk | 1891,00 | 284 | 1 |
| 0980811 | 100x185cm (50) links m. KermiClean | wit/helder glas | AXL50100182P | stuk | 1976,00 | 284 | 1 |
| 0980815 | 100x185cm (50) links m. KermiClean | glanszilver/helder | AXL5010018VP | stuk | 2230,00 | 284 | 1 |
| 0980782 | 90x185cm (40) rechts | zilvermat/helder | AXR40090181A | stuk | 1470,00 | 284 | 1 |
| 0980780 | 90x185cm (40) rechts | wit/helder glas | AXR40090182A | stuk | 1548,00 | 284 | 1 |
| 0980784 | 90x185cm (40) rechts | glanszilver/helder | AXR4009018VA | stuk | 1780,00 | 284 | 1 |
| 0980783 | 90x185cm (40) rechts m. KermiClean | zilvermat/helder | AXR40090181P | stuk | 1743,00 | 284 | 1 |
| 0980781 | 90x185cm (40) rechts m. KermiClean | wit/helder glas | AXR40090182P | stuk | 1821,00 | 284 | 1 |
| 0980785 | 90x185cm (40) rechts m. KermiClean | glanszilver/helder | AXR4009018VP | stuk | 2053,00 | 284 | 1 |
| 0980794 | 90x185cm (45) rechts | zilvermat/helder | AXR45090181A | stuk | 1470,00 | 284 | 1 |
| 0980792 | 90x185cm (45) rechts | wit/helder glas | AXR45090182A | stuk | 1548,00 | 284 | 1 |
| 0980796 | 90x185cm (45) rechts | glanszilver/helder | AXR4509018VA | stuk | 1780,00 | 284 | 1 |
| 0980795 | 90x185cm (45) rechts m. KermiClean | zilvermat/helder | AXR45090181P | stuk | 1743,00 | 284 | 1 |
| 0980793 | 90x185cm (45) rechts m. KermiClean | wit/helder glas | AXR45090182P | stuk | 1821,00 | 284 | 1 |
| 0980797 | 90x185cm (45) rechts m. KermiClean | glanszilver/helder | AXR4509018VP | stuk | 2053,00 | 284 | 1 |
| 0980806 | 100x185cm (50) rechts | zilvermat/helder | AXR50100181A | stuk | 1618,00 | 284 | 1 |
| 0980804 | 100x185cm (50) rechts | wit/helder glas | AXR50100182A | stuk | 1703,00 | 284 | 1 |
| 0980808 | 100x185cm (50) rechts | glanszilver/helder | AXR5010018VA | stuk | 1957,00 | 284 | 1 |
| 0980807 | 100x185cm (50) rechts m. KermiClean | zilvermat/helder | AXR50100181P | stuk | 1891,00 | 284 | 1 |
| 0980805 | 100x185cm (50) rechts m. KermiClean | wit/helder glas | AXR50100182P | stuk | 1976,00 | 284 | 1 |
| 0980809 | 100x185cm (50) rechts m. KermiClean | glanszilver/helder | AXR5010018VP | stuk | 2230,00 | 284 | 1 |

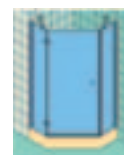

Sanitair producten

Baden /
douchebakken /
stoomcabines

Kranen

Douchegarnituur

Accessoires en
spiegels**Douchewanden**Toebehoren &
afvoerenSpoel- &
installatiesystemenBadkamermeubelen
en toiletkastenGootstenen en
wastroggen

Utiliteit

| | Art.nr | Specificaties | Kleur | Lev.nr | Ehd | Prijs | Grp | CC |
|---|--------------------------------|--------------------------------|--------------------|--------------|------|---------|-----|----|
| | Kermi Aska XP | | | | | | | |
| | nisdeur m. vast segment | | | | | | | |
| Sanitair producten | 0980475 | 80x185cm links | zilvermat/helder | AXSTL080181A | stuk | 704,00 | 284 | 1 |
| | 0980473 | 80x185cm links | wit/helder glas | AXSTL080182A | stuk | 742,00 | 284 | 1 |
| Baden / douchebakken / stoomcabines | 0980477 | 80x185cm links | glanszilver/helder | AXSTL08018VA | stuk | 852,00 | 284 | 1 |
| | 0980476 | 80x185cm links m. KermiClean | zilvermat/helder | AXSTL080181P | stuk | 856,00 | 284 | 1 |
| | 0980474 | 80x185cm links m. KermiClean | wit/helder glas | AXSTL080182P | stuk | 894,00 | 284 | 1 |
| | 0980478 | 80x185cm links m. KermiClean | glanszilver/helder | AXSTL08018VP | stuk | 1005,00 | 284 | 1 |
| | 0980487 | 88x185cm links | zilvermat/helder | AXSTL088181A | stuk | 726,00 | 284 | 1 |
| | 0980485 | 88x185cm links | wit/helder glas | AXSTL088182A | stuk | 764,00 | 284 | 1 |
| Kranen | 0980489 | 88x185cm links | glanszilver/helder | AXSTL08818VA | stuk | 878,00 | 284 | 1 |
| | 0980488 | 88x185cm links m. KermiClean | zilvermat/helder | AXSTL088181P | stuk | 879,00 | 284 | 1 |
| | 0980486 | 88x185cm links m. KermiClean | wit/helder glas | AXSTL088182P | stuk | 917,00 | 284 | 1 |
| | 0980490 | 88x185cm links m. KermiClean | glanszilver/helder | AXSTL08818VP | stuk | 1031,00 | 284 | 1 |
| Douchegarnituur | 0980499 | 90x185cm links | zilvermat/helder | AXSTL090181A | stuk | 726,00 | 284 | 0 |
| | 0980497 | 90x185cm links | wit/helder glas | AXSTL090182A | stuk | 764,00 | 284 | 1 |
| | 0980502 | 90x185cm links | glanszilver/helder | AXSTL09018VA | stuk | 878,00 | 284 | 1 |
| | 0980816 | 90x185cm links m. KermiClean | zilvermat/helder | AXSTL090181P | stuk | 879,00 | 284 | 1 |
| | 0980498 | 90x185cm links m. KermiClean | wit/helder glas | AXSTL090182P | stuk | 917,00 | 284 | 1 |
| Accessoires en spiegels | 0980503 | 90x185cm links m. KermiClean | glanszilver/helder | AXSTL09018VP | stuk | 1031,00 | 284 | 1 |
| | 0980523 | 100x185cm links | zilvermat/helder | AXSTL100181A | stuk | 820,00 | 284 | 1 |
| | 0980515 | 100x185cm links | wit/helder glas | AXSTL100182A | stuk | 864,00 | 284 | 1 |
| Douchewanden | 0980525 | 100x185cm links | glanszilver/helder | AXSTL10018VA | stuk | 993,00 | 284 | 1 |
| | 0980524 | 100x185cm links m. KermiClean | zilvermat/helder | AXSTL100181P | stuk | 973,00 | 284 | 1 |
| | 0980516 | 100x185cm links m. KermiClean | wit/helder glas | AXSTL100182P | stuk | 1016,00 | 284 | 1 |
| | 0980526 | 100x185cm links m. KermiClean | glanszilver/helder | AXSTL10018VP | stuk | 1145,00 | 284 | 1 |
| | 0980469 | 80x185cm rechts | zilvermat/helder | AXSTR080181A | stuk | 704,00 | 284 | 1 |
| | 0980467 | 80x185cm rechts | wit/helder glas | AXSTR080182A | stuk | 742,00 | 284 | 1 |
| Toebehoren & afvoeren | 0980471 | 80x185cm rechts | glanszilver/helder | AXSTR08018VA | stuk | 852,00 | 284 | 1 |
| | 0980470 | 80x185cm rechts m. KermiClean | zilvermat/helder | AXSTR080181P | stuk | 856,00 | 284 | 1 |
| | 0980468 | 80x185cm rechts m. KermiClean | wit/helder glas | AXSTR080182P | stuk | 894,00 | 284 | 1 |
| | 0980472 | 80x185cm rechts m. KermiClean | glanszilver/helder | AXSTR08018VP | stuk | 1005,00 | 284 | 1 |
| | 0980481 | 88x185cm rechts | zilvermat/helder | AXSTR088181A | stuk | 726,00 | 284 | 1 |
| Spoel- & installatiesystemen | 0980479 | 88x185cm rechts | wit/helder glas | AXSTR088182A | stuk | 764,00 | 284 | 1 |
| | 0980483 | 88x185cm rechts | glanszilver/helder | AXSTR08818VA | stuk | 878,00 | 284 | 1 |
| | 0980482 | 88x185cm rechts m. KermiClean | zilvermat/helder | AXSTR088181P | stuk | 879,00 | 284 | 1 |
| | 0980480 | 88x185cm rechts m. KermiClean | wit/helder glas | AXSTR088182P | stuk | 917,00 | 284 | 1 |
| Badkamermeubelen en toiletkasten | 0980484 | 88x185cm rechts m. KermiClean | glanszilver/helder | AXSTR08818VP | stuk | 1031,00 | 284 | 1 |
| | 0980493 | 90x185cm rechts | zilvermat/helder | AXSTR090181A | stuk | 726,00 | 284 | 0 |
| | 0980491 | 90x185cm rechts | wit/helder glas | AXSTR090182A | stuk | 764,00 | 284 | 1 |
| Gootstenen en wastroggen | 0980495 | 90x185cm rechts | glanszilver/helder | AXSTR09018VA | stuk | 878,00 | 284 | 1 |
| | 0980494 | 90x185cm rechts m. KermiClean | zilvermat/helder | AXSTR090181P | stuk | 879,00 | 284 | 1 |
| | 0980492 | 90x185cm rechts m. KermiClean | wit/helder glas | AXSTR090182P | stuk | 917,00 | 284 | 1 |
| | 0980496 | 90x185cm rechts m. KermiClean | glanszilver/helder | AXSTR09018VP | stuk | 1031,00 | 284 | 1 |
| | 0980510 | 100x185cm rechts | zilvermat/helder | AXSTR100181A | stuk | 820,00 | 284 | 1 |
| Utiliteit | 0980504 | 100x185cm rechts | wit/helder glas | AXSTR100182A | stuk | 864,00 | 284 | 1 |
| | 0980513 | 100x185cm rechts | glanszilver/helder | AXSTR10018VA | stuk | 993,00 | 284 | 1 |
| | 0980511 | 100x185cm rechts m. KermiClean | zilvermat/helder | AXSTR100181P | stuk | 973,00 | 284 | 1 |
| | 0980509 | 100x185cm rechts m. KermiClean | wit/helder glas | AXSTR100182P | stuk | 1016,00 | 284 | 1 |
| | 0980514 | 100x185cm rechts m. KermiClean | glanszilver/helder | AXSTR10018VP | stuk | 1145,00 | 284 | 1 |

| Art.nr | Specificaties | Kleur | Lev.nr | Ehd | Prijs | Grp | CC |
|---|--------------------------------|--------------------|--------------|------|---------|-----|----|
| Kermi Aska XP | | | | | | | |
| draaideur m. vast segment voor zijwand | | | | | | | |
| 0980535 | 80x185cm links | zilvermat/helder | AXSWL080181A | stuk | 662,00 | 284 | 1 |
| 0980533 | 80x185cm links | wit/helder glas | AXSWL080182A | stuk | 696,00 | 284 | 1 |
| 0980537 | 80x185cm links | glanszilver/helder | AXSWL08018VA | stuk | 801,00 | 284 | 1 |
| 0980536 | 80x185cm links m. KermiClean | zilvermat/helder | AXSWL080181P | stuk | 814,00 | 284 | 1 |
| 0980534 | 80x185cm links m. KermiClean | wit/helder glas | AXSWL080182P | stuk | 849,00 | 284 | 1 |
| 0980538 | 80x185cm links m. KermiClean | glanszilver/helder | AXSWL08018VP | stuk | 954,00 | 284 | 1 |
| 0980547 | 88x185cm links | zilvermat/helder | AXSWL088181A | stuk | 682,00 | 284 | 1 |
| 0980545 | 88x185cm links | wit/helder glas | AXSWL088182A | stuk | 718,00 | 284 | 1 |
| 0980549 | 88x185cm links | glanszilver/helder | AXSWL08818VA | stuk | 826,00 | 284 | 1 |
| 0980548 | 88x185cm links m. KermiClean | zilvermat/helder | AXSWL088181P | stuk | 835,00 | 284 | 1 |
| 0980546 | 88x185cm links m. KermiClean | wit/helder glas | AXSWL088182P | stuk | 871,00 | 284 | 1 |
| 0980550 | 88x185cm links m. KermiClean | glanszilver/helder | AXSWL08818VP | stuk | 978,00 | 284 | 1 |
| 0980559 | 90x185cm links | zilvermat/helder | AXSWL090181A | stuk | 682,00 | 284 | 0 |
| 0980557 | 90x185cm links | wit/helder glas | AXSWL090182A | stuk | 718,00 | 284 | 1 |
| 0980561 | 90x185cm links | glanszilver/helder | AXSWL09018VA | stuk | 826,00 | 284 | 1 |
| 0980560 | 90x185cm links m. KermiClean | zilvermat/helder | AXSWL090181P | stuk | 835,00 | 284 | 1 |
| 0980558 | 90x185cm links m. KermiClean | wit/helder glas | AXSWL090182P | stuk | 871,00 | 284 | 1 |
| 0980562 | 90x185cm links m. KermiClean | glanszilver/helder | AXSWL09018VP | stuk | 978,00 | 284 | 1 |
| 0980571 | 100x185cm links | zilvermat/helder | AXSWL100181A | stuk | 785,00 | 284 | 1 |
| 0980569 | 100x185cm links | wit/helder glas | AXSWL100182A | stuk | 826,00 | 284 | 1 |
| 0980573 | 100x185cm links | glanszilver/helder | AXSWL10018VA | stuk | 950,00 | 284 | 1 |
| 0980572 | 100x185cm links m. KermiClean | zilvermat/helder | AXSWL100181P | stuk | 937,00 | 284 | 1 |
| 0980570 | 100x185cm links m. KermiClean | wit/helder glas | AXSWL100182P | stuk | 978,00 | 284 | 1 |
| 0980574 | 100x185cm links m. KermiClean | glanszilver/helder | AXSWL10018VP | stuk | 1102,00 | 284 | 1 |
| 0980529 | 80x185cm rechts | zilvermat/helder | AXSWR080181A | stuk | 662,00 | 284 | 1 |
| 0980527 | 80x185cm rechts | wit/helder glas | AXSWR080182A | stuk | 696,00 | 284 | 1 |
| 0980531 | 80x185cm rechts | glanszilver/helder | AXSWR08018VA | stuk | 801,00 | 284 | 1 |
| 0980530 | 80x185cm rechts m. KermiClean | zilvermat/helder | AXSWR080181P | stuk | 814,00 | 284 | 1 |
| 0980528 | 80x185cm rechts m. KermiClean | wit/helder glas | AXSWR080182P | stuk | 849,00 | 284 | 1 |
| 0980532 | 80x185cm rechts m. KermiClean | glanszilver/helder | AXSWR08018VP | stuk | 954,00 | 284 | 1 |
| 0980541 | 88x185cm rechts | zilvermat/helder | AXSWR088181A | stuk | 682,00 | 284 | 1 |
| 0980539 | 88x185cm rechts | wit/helder glas | AXSWR088182A | stuk | 718,00 | 284 | 1 |
| 0980543 | 88x185cm rechts | glanszilver/helder | AXSWR08818VA | stuk | 826,00 | 284 | 1 |
| 0980542 | 88x185cm rechts m. KermiClean | zilvermat/helder | AXSWR088181P | stuk | 835,00 | 284 | 1 |
| 0980540 | 88x185cm rechts m. KermiClean | wit/helder glas | AXSWR088182P | stuk | 871,00 | 284 | 1 |
| 0980544 | 88x185cm rechts m. KermiClean | glanszilver/helder | AXSWR08818VP | stuk | 978,00 | 284 | 1 |
| 0980553 | 90x185cm rechts | zilvermat/helder | AXSWR090181A | stuk | 682,00 | 284 | 0 |
| 0980551 | 90x185cm rechts | wit/helder glas | AXSWR090182A | stuk | 718,00 | 284 | 1 |
| 0980555 | 90x185cm rechts | glanszilver/helder | AXSWR09018VA | stuk | 826,00 | 284 | 1 |
| 0980554 | 90x185cm rechts m. KermiClean | zilvermat/helder | AXSWR090181P | stuk | 835,00 | 284 | 1 |
| 0980552 | 90x185cm rechts m. KermiClean | wit/helder glas | AXSWR090182P | stuk | 871,00 | 284 | 1 |
| 0980556 | 90x185cm rechts m. KermiClean | glanszilver/helder | AXSWR09018VP | stuk | 978,00 | 284 | 1 |
| 0980565 | 100x185cm rechts | zilvermat/helder | AXSWR100181A | stuk | 785,00 | 284 | 1 |
| 0980563 | 100x185cm rechts | wit/helder glas | AXSWR100182A | stuk | 826,00 | 284 | 1 |
| 0980567 | 100x185cm rechts | glanszilver/helder | AXSWR10018VA | stuk | 950,00 | 284 | 1 |
| 0980566 | 100x185cm rechts m. KermiClean | zilvermat/helder | AXSWR100181P | stuk | 937,00 | 284 | 1 |
| 0980564 | 100x185cm rechts m. KermiClean | wit/helder glas | AXSWR100182P | stuk | 978,00 | 284 | 1 |
| 0980568 | 100x185cm rechts m. KermiClean | glanszilver/helder | AXSWR10018VP | stuk | 1102,00 | 284 | 1 |



Sanitair producten

Baden /
douchebakken /
stoomcabines

Kranen

Douchegarnituur

Accessoires en
spiegels**Douchewanden**Toebehoren &
afvoerenSpoel- &
installatiesystemenBadkamermeubelen
en toiletkastenGootstenen en
wastroggen

Utiliteit

| | Art.nr | Specificaties | Kleur | Lev.nr | Ehd | Prijs | Grp | CC |
|---|----------------------|--------------------------------|--------------------|--------------|------|--------|-----|----|
| | Kermi Aska XP | | | | | | | |
| | zijwand | | | | | | | |
| Sanitair producten | 0980577 | 80x185cm rechts | zilvermat/helder | AXTWR080181A | stuk | 447,00 | 284 | 1 |
| | 0980575 | 80x185cm rechts | wit/helder glas | AXTWR080182A | stuk | 471,00 | 284 | 1 |
| Baden / douchebakken / stoomcabines | 0980579 | 80x185cm rechts | glanszilver/helder | AXTWR08018VA | stuk | 542,00 | 284 | 1 |
| | 0980578 | 80x185cm rechts m. KermiClean | zilvermat/helder | AXTWR080181P | stuk | 600,00 | 284 | 1 |
| | 0980576 | 80x185cm rechts m. KermiClean | wit/helder glas | AXTWR080182P | stuk | 624,00 | 284 | 1 |
| | 0980580 | 80x185cm rechts m. KermiClean | glanszilver/helder | AXTWR08018VP | stuk | 694,00 | 284 | 1 |
| | 0984915 | 80x185cm links | wit/helder | AXTWR080182A | stuk | 471,00 | 284 | 1 |
| | 0984917 | 80x185cm links | matzilver/helder | AXTWR080181A | stuk | 447,00 | 284 | 1 |
| Kranen | 0984919 | 80x185cm links | glanszilver/helder | AXTWR08018VA | stuk | 542,00 | 284 | 1 |
| | 0984916 | 80x185cm links m. KermiClean | wit/helder | AXTWR080182P | stuk | 624,00 | 284 | 1 |
| | 0984918 | 80x185cm links m. KermiClean | matzilver/helder | AXTWR080181P | stuk | 600,00 | 284 | 1 |
| | 0984920 | 80x185cm links m. KermiClean | glanszilver/helder | AXTWR08018VP | stuk | 694,00 | 284 | 1 |
| Douchegarnituur | 0980621 | 88x185cm rechts | zilvermat/helder | AXTWR088181A | stuk | 462,00 | 284 | 1 |
| | 0980581 | 88x185cm rechts | wit/helder glas | AXTWR088182A | stuk | 485,00 | 284 | 1 |
| | 0980623 | 88x185cm rechts | glanszilver/helder | AXTWR08818VA | stuk | 558,00 | 284 | 1 |
| | 0980622 | 88x185cm rechts m. KermiClean | zilvermat/helder | AXTWR088181P | stuk | 614,00 | 284 | 1 |
| Accessoires en spiegels | 0980617 | 88x185cm rechts m. KermiClean | wit/helder glas | AXTWR088182P | stuk | 638,00 | 284 | 1 |
| | 0980626 | 88x185cm rechts m. KermiClean | glanszilver/helder | AXTWR08818VP | stuk | 711,00 | 284 | 1 |
| | 0984921 | 88x185cm links | wit/helder | AXTWR088182A | stuk | 485,00 | 284 | 1 |
| | 0984925 | 88x185cm links | matzilver/helder | AXTWR088181A | stuk | 462,00 | 284 | 1 |
| | 0984927 | 88x185cm links | glanszilver/helder | AXTWR08818VA | stuk | 558,00 | 284 | 1 |
| | 0984924 | 88x185cm links m. KermiClean | wit/helder | AXTWR088182P | stuk | 638,00 | 284 | 1 |
| Douchewanden | 0984926 | 88x185cm links m. KermiClean | matzilver/helder | AXTWR088181P | stuk | 614,00 | 284 | 1 |
| | 0984928 | 88x185cm links m. KermiClean | glanszilver/helder | AXTWR08818VP | stuk | 711,00 | 284 | 1 |
| | 0980634 | 90x185cm rechts | zilvermat/helder | AXTWR090181A | stuk | 462,00 | 284 | 0 |
| Toebehoren & afvoeren | 0980630 | 90x185cm rechts | wit/helder glas | AXTWR090182A | stuk | 485,00 | 284 | 1 |
| | 0980638 | 90x185cm rechts | glanszilver/helder | AXTWR09018VA | stuk | 558,00 | 284 | 1 |
| | 0980636 | 90x185cm rechts m. KermiClean | zilvermat/helder | AXTWR090181P | stuk | 614,00 | 284 | 1 |
| | 0980633 | 90x185cm rechts m. KermiClean | wit/helder glas | AXTWR090182P | stuk | 638,00 | 284 | 1 |
| | 0980640 | 90x185cm rechts m. KermiClean | glanszilver/helder | AXTWR09018VP | stuk | 711,00 | 284 | 1 |
| | 0984929 | 90x185cm links | wit/helder | AXTWR090182A | stuk | 485,00 | 284 | 1 |
| Spoel- & installatiesystemen | 0984934 | 90x185cm links | matzilver/helder | AXTWR090181A | stuk | 462,00 | 284 | 1 |
| | 0984966 | 90x185cm links | glanszilver/helder | AXTWR09018VA | stuk | 558,00 | 284 | 1 |
| | 0984933 | 90x185cm links m. KermiClean | wit/helder | AXTWR090182P | stuk | 638,00 | 284 | 1 |
| | 0984964 | 90x185cm links m. KermiClean | matzilver/helder | AXTWR090181P | stuk | 614,00 | 284 | 1 |
| Badkamermeubelen en toiletkasten | 0984970 | 90x185cm links m. KermiClean | glanszilver/helder | AXTWR09018VP | stuk | 711,00 | 284 | 1 |
| | 0980644 | 100x185cm rechts | zilvermat/helder | AXTWR100181A | stuk | 530,00 | 284 | 1 |
| | 0980642 | 100x185cm rechts | wit/helder glas | AXTWR100182A | stuk | 558,00 | 284 | 1 |
| Gootstenen en wastroggen | 0980646 | 100x185cm rechts | glanszilver/helder | AXTWR10018VA | stuk | 642,00 | 284 | 1 |
| | 0980645 | 100x185cm rechts m. KermiClean | zilvermat/helder | AXTWR100181P | stuk | 683,00 | 284 | 1 |
| | 0980643 | 100x185cm rechts m. KermiClean | wit/helder glas | AXTWR100182P | stuk | 711,00 | 284 | 1 |
| | 0980647 | 100x185cm rechts m. KermiClean | glanszilver/helder | AXTWR10018VP | stuk | 795,00 | 284 | 1 |
| | 0984971 | 100x185cm links | wit/helder | AXTWR100182A | stuk | 558,00 | 284 | 1 |
| | 0984974 | 100x185cm links | matzilver/helder | AXTWR100181A | stuk | 530,00 | 284 | 1 |
| Utiliteit | 0984976 | 100x185cm links | glanszilver/helder | AXTWR10018VA | stuk | 642,00 | 284 | 1 |
| | 0984972 | 100x185cm links m. KermiClean | wit/helder | AXTWR100182P | stuk | 711,00 | 284 | 1 |
| | 0984975 | 100x185cm links m. KermiClean | matzilver/helder | AXTWR100181P | stuk | 683,00 | 284 | 1 |
| | 0984977 | 100x185cm links m. KermiClean | glanszilver/helder | AXTWR10018VP | stuk | 795,00 | 284 | 1 |

Kermi Atea

draaideur

| | | | | | | | |
|---------|-------------------------------|------------------|---------------|------|--------|-----|---|
| 0969615 | 75x185cm links | wit/helder | ATSTL075182AK | stuk | 550,00 | 284 | 1 |
| 0969614 | 75x185cm links | gl.zilver/helder | ATSTL07518VAK | stuk | 610,00 | 284 | 1 |
| 0969617 | 75x185cm links m. KermiClean | wit/helder | ATSTL075182PK | stuk | 703,00 | 284 | 1 |
| 0969616 | 75x185cm links m. KermiClean | gl.zilver/helder | ATSTL07518VPK | stuk | 763,00 | 284 | 1 |
| 0969610 | 75x185cm rechts | wit/helder | ATSTR075182AK | stuk | 550,00 | 284 | 1 |
| 0969609 | 75x185cm rechts | gl.zilver/helder | ATSTR07518VAK | stuk | 610,00 | 284 | 1 |
| 0969612 | 75x185cm rechts m. KermiClean | wit/helder | ATSTR075182PK | stuk | 703,00 | 284 | 1 |
| 0969611 | 75x185cm rechts m. KermiClean | gl.zilver/helder | ATSTR07518VPK | stuk | 763,00 | 284 | 1 |
| 0060000 | 75x200cm rechts | gl.zilver/helder | ATSTR07520VAK | stuk | 671,00 | 284 | 1 |
| 0060001 | 75x200cm rechts | wit/helder glas | ATSTR075202AK | stuk | 605,00 | 284 | 1 |
| 0060002 | 75x200cm rechts m. KermiClean | gl.zilver/helder | ATSTR07520VPK | stuk | 824,00 | 284 | 1 |
| 0060003 | 75x200cm rechts m. KermiClean | wit/helder glas | ATSTR075202PK | stuk | 757,00 | 284 | 1 |
| 0060004 | 75x200cm links | gl.zilver/helder | ATSTL07520VAK | stuk | 671,00 | 284 | 1 |
| 0060005 | 75x200cm links | wit/helder glas | ATSTL075202AK | stuk | 605,00 | 284 | 1 |
| 0060006 | 75x200cm links m. KermiClean | gl.zilver/helder | ATSTL07520VPK | stuk | 824,00 | 284 | 1 |
| 0060007 | 75x200cm links m. KermiClean | wit/helder glas | ATSTL075202PK | stuk | 757,00 | 284 | 1 |
| 0969624 | 80x185cm links | wit/helder | ATSTL080182AK | stuk | 561,00 | 284 | 1 |
| 0969623 | 80x185cm links | gl.zilver/helder | ATSTL08018VAK | stuk | 624,00 | 284 | 1 |

| Art.nr | Specificaties | Kleur | Lev.nr | Ehd | Prijs | Grp | CC |
|-------------------|---------------|----------------------|------------------|---------------|-------|--------|-------|
| Kermi Atea | | | | | | | |
| draaideur | | | | | | | |
| 0969626 | 80x185cm | links m. KermiClean | wit/helder | ATSTL080182PK | stuk | 714,00 | 284 1 |
| 0969625 | 80x185cm | links m. KermiClean | gl.zilver/helder | ATSTL08018VPK | stuk | 776,00 | 284 1 |
| 0969619 | 80x185cm | rechts | wit/helder | ATSTR080182AK | stuk | 561,00 | 284 1 |
| 0969618 | 80x185cm | rechts | gl.zilver/helder | ATSTR08018VAK | stuk | 624,00 | 284 1 |
| 0969622 | 80x185cm | rechts m. KermiClean | wit/helder | ATSTR080182PK | stuk | 714,00 | 284 1 |
| 0969620 | 80x185cm | rechts m. KermiClean | gl.zilver/helder | ATSTR08018VPK | stuk | 776,00 | 284 1 |
| 0060008 | 80x200cm | rechts | gl.zilver/helder | ATSTR08020VAK | stuk | 686,00 | 284 1 |
| 0060009 | 80x200cm | rechts | wit/helder glas | ATSTR080202AK | stuk | 617,00 | 284 1 |
| 0060010 | 80x200cm | rechts m. Kermiclean | gl.zilver/helder | ATSTR08020VPK | stuk | 839,00 | 284 1 |
| 0060011 | 80x200cm | rechts m. Kermiclean | wit/helder glas | ATSTR080202PK | stuk | 770,00 | 284 1 |
| 0060012 | 80x200cm | links | gl.zilver/helder | ATSTL08020VAK | stuk | 686,00 | 284 1 |
| 0060013 | 80x200cm | links | wit/helder glas | ATSTL080202AK | stuk | 617,00 | 284 1 |
| 0060014 | 80x200cm | links m. KermiClean | gl.zilver/helder | ATSTL08020VPK | stuk | 839,00 | 284 1 |
| 0060015 | 80x200cm | links m. KermiClean | wit/helder glas | ATSTL080202PK | stuk | 770,00 | 284 1 |
| 0969633 | 85x185cm | links | wit/helder | ATSTL085182AK | stuk | 573,00 | 284 1 |
| 0969632 | 85x185cm | links | gl.zilver/helder | ATSTL08518VAK | stuk | 637,00 | 284 1 |
| 0969635 | 85x185cm | links m. KermiClean | wit/helder | ATSTL085182PK | stuk | 726,00 | 284 1 |
| 0969634 | 85x185cm | links m. KermiClean | gl.zilver/helder | ATSTL08518VPK | stuk | 790,00 | 284 1 |
| 0969629 | 85x185cm | rechts | wit/helder | ATSTR085182AK | stuk | 573,00 | 284 1 |
| 0969628 | 85x185cm | rechts | gl.zilver/helder | ATSTR08518VAK | stuk | 637,00 | 284 1 |
| 0969631 | 85x185cm | rechts m. KermiClean | wit/helder | ATSTR085182PK | stuk | 726,00 | 284 1 |
| 0969630 | 85x185cm | rechts m. KermiClean | gl.zilver/helder | ATSTR08518VPK | stuk | 790,00 | 284 1 |
| 0060016 | 85x200cm | rechts | gl.zilver/helder | ATSTR08520VAK | stuk | 701,00 | 284 1 |
| 0060017 | 85x200cm | rechts | wit/helder glas | ATSTR085202AK | stuk | 631,00 | 284 1 |
| 0060018 | 85x200cm | rechts m. Kermiclean | gl.zilver/helder | ATSTR08520VPK | stuk | 853,00 | 284 1 |
| 0060019 | 85x200cm | rechts m. Kermiclean | wit/helder glas | ATSTR085202PK | stuk | 783,00 | 284 1 |
| 0060020 | 85x200cm | links | gl.zilver/helder | ATSTL08520VAK | stuk | 701,00 | 284 1 |
| 0060021 | 85x200cm | links | wit/helder glas | ATSTL085202AK | stuk | 631,00 | 284 1 |
| 0060022 | 85x200cm | links m. KermiClean | gl.zilver/helder | ATSTL08520VPK | stuk | 853,00 | 284 1 |
| 0060023 | 85x200cm | links m. KermiClean | wit/helder glas | ATSTL085202PK | stuk | 783,00 | 284 1 |
| 0969641 | 90x185cm | links | wit/helder | ATSTL090182AK | stuk | 585,00 | 284 1 |
| 0969640 | 90x185cm | links | gl.zilver/helder | ATSTL09018VAK | stuk | 649,00 | 284 1 |
| 0969643 | 90x185cm | links m. KermiClean | wit/helder | ATSTL090182PK | stuk | 737,00 | 284 1 |
| 0969642 | 90x185cm | links m. KermiClean | gl.zilver/helder | ATSTL09018VPK | stuk | 802,00 | 284 1 |
| 0969637 | 90x185cm | rechts | wit/helder | ATSTR090182AK | stuk | 585,00 | 284 1 |
| 0969636 | 90x185cm | rechts | gl.zilver/helder | ATSTR09018VAK | stuk | 649,00 | 284 1 |
| 0969639 | 90x185cm | rechts m. KermiClean | wit/helder | ATSTR090182PK | stuk | 737,00 | 284 1 |
| 0969638 | 90x185cm | rechts m. KermiClean | gl.zilver/helder | ATSTR09018VPK | stuk | 802,00 | 284 1 |
| 0060024 | 90x200cm | rechts | gl.zilver/helder | ATSTR09020VAK | stuk | 714,00 | 284 1 |
| 0060025 | 90x200cm | rechts | wit/helder glas | ATSTR090202AK | stuk | 643,00 | 284 1 |
| 0060026 | 90x200cm | rechts m. Kermiclean | gl.zilver/helder | ATSTR09020VPK | stuk | 867,00 | 284 1 |
| 0060027 | 90x200cm | rechts m. Kermiclean | wit/helder glas | ATSTR090202PK | stuk | 796,00 | 284 1 |
| 0060028 | 90x200cm | links | gl.zilver/helder | ATSTL09020VAK | stuk | 714,00 | 284 1 |
| 0060029 | 90x200cm | links | wit/helder glas | ATSTL090202AK | stuk | 643,00 | 284 1 |
| 0060030 | 90x200cm | links m. KermiClean | gl.zilver/helder | ATSTL09020VPK | stuk | 867,00 | 284 1 |
| 0060031 | 90x200cm | links m. KermiClean | wit/helder glas | ATSTL090202PK | stuk | 796,00 | 284 1 |
| 0969650 | 95x185cm | links | wit/helder | ATSTL095182AK | stuk | 597,00 | 284 1 |
| 0969649 | 95x185cm | links | gl.zilver/helder | ATSTL09518VAK | stuk | 663,00 | 284 1 |
| 0969652 | 95x185cm | links m. KermiClean | wit/helder | ATSTL095182PK | stuk | 750,00 | 284 1 |
| 0969651 | 95x185cm | links m. KermiClean | gl.zilver/helder | ATSTL09518VPK | stuk | 815,00 | 284 1 |
| 0969645 | 95x185cm | rechts | wit/helder | ATSTR095182AK | stuk | 597,00 | 284 1 |
| 0969644 | 95x185cm | rechts | gl.zilver/helder | ATSTR09518VAK | stuk | 663,00 | 284 1 |
| 0969647 | 95x185cm | rechts m. KermiClean | wit/helder | ATSTR095182PK | stuk | 750,00 | 284 1 |
| 0969646 | 95x185cm | rechts m. KermiClean | gl.zilver/helder | ATSTR09518VPK | stuk | 815,00 | 284 1 |
| 0060032 | 95x200cm | rechts | gl.zilver/helder | ATSTR09520VAK | stuk | 729,00 | 284 1 |
| 0060033 | 95x200cm | rechts | wit/helder glas | ATSTR095202AK | stuk | 657,00 | 284 1 |
| 0060034 | 95x200cm | rechts m. Kermiclean | gl.zilver/helder | ATSTR09520VPK | stuk | 882,00 | 284 1 |
| 0060035 | 95x200cm | rechts m. Kermiclean | wit/helder glas | ATSTR095202PK | stuk | 809,00 | 284 1 |
| 0060036 | 95x200cm | links | gl.zilver/helder | ATSTL09520VAK | stuk | 729,00 | 284 1 |
| 0060037 | 95x200cm | links | wit/helder glas | ATSTL095202AK | stuk | 657,00 | 284 1 |
| 0060038 | 95x200cm | links m. KermiClean | gl.zilver/helder | ATSTL09520VPK | stuk | 882,00 | 284 1 |
| 0060039 | 95x200cm | links m. KermiClean | wit/helder glas | ATSTL095202PK | stuk | 809,00 | 284 1 |
| 0969654 | 100x185cm | rechts | wit/helder | ATSTR100182AK | stuk | 614,00 | 284 1 |
| 0969653 | 100x185cm | rechts | gl.zilver/helder | ATSTR10018VAK | stuk | 682,00 | 284 1 |
| 0969657 | 100x185cm | rechts m. KermiClean | wit/helder | ATSTR100182PK | stuk | 767,00 | 284 1 |
| 0969655 | 100x185cm | rechts m. KermiClean | gl.zilver/helder | ATSTR10018VPK | stuk | 835,00 | 284 1 |
| 0969659 | 100x185cm | links | wit/helder | ATSTL100182AK | stuk | 614,00 | 284 1 |
| 0969658 | 100x185cm | links | gl.zilver/helder | ATSTL10018VAK | stuk | 682,00 | 284 1 |
| 0969661 | 100x185cm | links m. KermiClean | wit/helder | ATSTL100182PK | stuk | 767,00 | 284 1 |

Sanitair producten

Baden /
douchebakken /
stoomcabines

Kranen

Douchegarnituur

Accessoires en
spiegels

Douchewanden

Toebehoren &
afvoeren

Spoel- &
installatiesystemen

Badkamermeubelen
en toiletkasten

Gootstenen en
wastroggen

Utiliteit

| | Art.nr | Specificaties | Kleur | Lev.nr | Ehd | Prijs | Grp | CC | |
|---|----------------------------|--------------------------------|--------------------|--------------------|---------------|--------|--------|-----|---|
| Kermi Atea | | | | | | | | | |
| draaideur | | | | | | | | | |
| Sanitair producten | 0969660 | 100x185cm links m. KermiClean | gl.zilver/helder | ATSTL10018VPK | stuk | 835,00 | 284 | 1 | |
| | 0060040 | 100x200cm rechts | gl.zilver/helder | ATSTR10020VAK | stuk | 750,00 | 284 | 1 | |
| | 0060041 | 100x200cm rechts | wit/helder glas | ATSTR100202AK | stuk | 676,00 | 284 | 1 | |
| Baden / douchebakken / stoomcabines | 0060042 | 100x200cm rechts m. KermiClean | gl.zilver/helder | ATSTR10020VPK | stuk | 903,00 | 284 | 1 | |
| | 0060043 | 100x200cm rechts m. KermiClean | wit/helder glas | ATSTR100202PK | stuk | 829,00 | 284 | 1 | |
| | 0060044 | 100x200cm links | gl.zilver/helder | ATSTL10020VAK | stuk | 750,00 | 284 | 1 | |
| | 0060045 | 100x200cm links | wit/helder glas | ATSTL100202AK | stuk | 676,00 | 284 | 1 | |
| | 0060046 | 100x200cm links m. KermiClean | gl.zilver/helder | ATSTL10020VPK | stuk | 903,00 | 284 | 1 | |
| Kranen | 0060047 | 100x200cm links m. KermiClean | wit/helder glas | ATSTL100202PK | stuk | 829,00 | 284 | 1 | |
| | zijwand | | | | | | | | |
| Douchegarnituur | 0968870 | 80x185cm | glanszilver/helder | ATTWD08018VAK | stuk | 379,00 | 284 | 1 | |
| | 0968889 | 80x185cm | wit/helder glas | ATTWD080182AK | stuk | 341,00 | 284 | 1 | |
| | 0969346 | 80x185cm m. KermiClean | glanszilver/helder | ATTWD08018VPK | stuk | 531,00 | 284 | 1 | |
| | 0969354 | 80x185cm m. KermiClean | wit/helder glas | ATTWD080182PK | stuk | 494,00 | 284 | 1 | |
| | 0060060 | 80x200cm | gl.zilver/helder | ATTWD08020VAK | stuk | 417,00 | 284 | 1 | |
| | 0060061 | 80x200cm | wit/helder glas | ATTWD080202AK | stuk | 375,00 | 284 | 1 | |
| | 0060062 | 80x200cm m. KermiClean | gl.zilver/helder | ATTWD08020VPK | stuk | 569,00 | 284 | 1 | |
| | 0060063 | 80x200cm m. KermiClean | wit/helder glas | ATTWD080202PK | stuk | 528,00 | 284 | 1 | |
| | Accessoires en spiegels | 0968855 | 90x185cm | glanszilver/helder | ATTWD09018VAK | stuk | 394,00 | 284 | 0 |
| | | 0968862 | 90x185cm | wit/helder glas | ATTWD090182AK | stuk | 355,00 | 284 | 1 |
| 0969311 | | 90x185cm m. KermiClean | glanszilver/helder | ATTWD09018VPK | stuk | 547,00 | 284 | 1 | |
| Douchewanden | 0969338 | 90x185cm m. KermiClean | wit/helder glas | ATTWD090182PK | stuk | 508,00 | 284 | 1 | |
| | 0060064 | 90x200cm | gl.zilver/helder | ATTWD09020VAK | stuk | 433,00 | 284 | 1 | |
| | 0060065 | 90x200cm | wit/helder glas | ATTWD090202AK | stuk | 356,00 | 284 | 1 | |
| | 0060066 | 90x200cm m. KermiClean | gl.zilver/helder | ATTWD09020VPK | stuk | 586,00 | 284 | 1 | |
| | 0060067 | 90x200cm m. KermiClean | wit/helder glas | ATTWD090202PK | stuk | 509,00 | 284 | 1 | |
| | Toebehoren & afvoeren | 0968897 | 100x185cm | glanszilver/helder | ATTWD10018VAK | stuk | 414,00 | 284 | 1 |
| | | 0968900 | 100x185cm | wit/helder glas | ATTWD100182AK | stuk | 373,00 | 284 | 1 |
| 0969362 | | 100x185cm m. KermiClean | glanszilver/helder | ATTWD10018VPK | stuk | 566,00 | 284 | 1 | |
| Spoel- & installatiesystemen | 0969370 | 100x185cm m. KermiClean | wit/helder glas | ATTWD100182PK | stuk | 525,00 | 284 | 1 | |
| | 0060068 | 100x200cm | gl.zilver/helder | ATTWD10020VAK | stuk | 455,00 | 284 | 1 | |
| | 0060069 | 100x200cm | wit/helder glas | ATTWD100202AK | stuk | 410,00 | 284 | 1 | |
| | 0060071 | 100x200cm m. KermiClean | wit/helder glas | ATTWD100202PK | stuk | 563,00 | 284 | 1 | |
| | 0060070 | 100x200cm m. KermiClean | gl.zilver/helder | ATTWD10020VPK | stuk | 608,00 | 284 | 1 | |
| pendeldeur m. vast segment voor hoekinstap | | | | | | | | | |
| Badkamermeubelen en toiletkasten | 0968919 | 90x185cm links | glanszilver/helder | ATESL09018VAK | stuk | 564,00 | 284 | 1 | |
| | 0968927 | 90x185cm links | wit/helder glas | ATESL090182AK | stuk | 508,00 | 284 | 1 | |
| | 0969389 | 90x185cm links m. KermiClean | glanszilver/helder | ATESL09018VPK | stuk | 717,00 | 284 | 1 | |
| | 0969397 | 90x185cm links m. KermiClean | wit/helder glas | ATESL090182PK | stuk | 661,00 | 284 | 1 | |
| Gootstenen en wastroggen | 0060076 | 90x200cm links | gl.zilver/helder | ATESL09020VAK | stuk | 621,00 | 284 | 1 | |
| | 0060077 | 90x200cm links | wit/helder glas | ATESL090202AK | stuk | 559,00 | 284 | 1 | |
| | 0060078 | 90x200cm links m. KermiClean | gl.zilver/helder | ATESL09020VPK | stuk | 773,00 | 284 | 1 | |
| | 0060079 | 90x200cm links m. KermiClean | wit/helder glas | ATESL090202PK | stuk | 711,00 | 284 | 1 | |
| | 0968935 | 90x185cm rechts | glanszilver/helder | ATESR09018VAK | stuk | 564,00 | 284 | 1 | |
| Utiliteit | 0968943 | 90x185cm rechts | wit/helder glas | ATESR090182AK | stuk | 508,00 | 284 | 1 | |
| | 0969400 | 90x185cm rechts m. KermiClean | glanszilver/helder | ATESR09018VPK | stuk | 717,00 | 284 | 1 | |
| | 0969419 | 90x185cm rechts m. KermiClean | wit/helder glas | ATESR090182PK | stuk | 661,00 | 284 | 1 | |
| | 0060072 | 90x200cm rechts | gl.zilver/helder | ATESR09020VAK | stuk | 621,00 | 284 | 1 | |
| | 0060073 | 90x200cm rechts | wit/helder glas | ATESR090202AK | stuk | 559,00 | 284 | 1 | |
| | 0060074 | 90x200cm rechts m. KermiClean | gl.zilver/helder | ATESR09020VPK | stuk | 773,00 | 284 | 1 | |
| | 0060075 | 90x200cm rechts m. KermiClean | wit/helder glas | ATESR090202PK | stuk | 711,00 | 284 | 1 | |

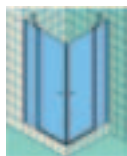
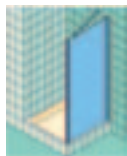

| Art.nr | Specificaties | Kleur | Lev.nr | Ehd | Prijs | Grp | CC |
|--------------------------------|--------------------------------|-------------------|---------------|------|---------|-----|----|
| Kermi Atea | | | | | | | |
| douchecabine kwartrond | | | | | | | |
| 0968951 | 90x185cm R50 | glanszilv./helder | ATP5009018VAK | stuk | 1399,00 | 284 | 1 |
| 0968978 | 90x185cm R50 | wit/helder glas | ATP50090182AK | stuk | 1258,00 | 284 | 1 |
| 0969427 | 90x185cm R50 m. KermiClean | glanszilv./helder | ATP5009018VPK | stuk | 1671,00 | 284 | 1 |
| 0969435 | 90x185cm R50 m. KermiClean | wit/helder glas | ATP50090182PK | stuk | 1531,00 | 284 | 1 |
| 0968986 | 90x185cm R55 | glanszilv./helder | ATP5509018VAK | stuk | 1399,00 | 284 | 0 |
| 0968994 | 90x185cm R55 | wit/helder glas | ATP55090182AK | stuk | 1258,00 | 284 | 1 |
| 0969443 | 90x185cm R55 m. KermiClean | glanszilv./helder | ATP5509018VPK | stuk | 1671,00 | 284 | 1 |
| 0969451 | 90x185cm R55 m. KermiClean | wit/helder glas | ATP55090182PK | stuk | 1531,00 | 284 | 1 |
| 0060080 | 90x200cm R50 | gl.zilver/helder | ATP5009020VAK | stuk | 1608,00 | 284 | 1 |
| 0060081 | 90x200cm R50 | wit/helder glas | ATP50090202AK | stuk | 1447,00 | 284 | 1 |
| 0060082 | 90x200cm R50 m. KermiClean | gl.zilver/helder | ATP5009020VPK | stuk | 1881,00 | 284 | 1 |
| 0060083 | 90x200cm R50 m. KermiClean | wit/helder glas | ATP50090202PK | stuk | 1719,00 | 284 | 1 |
| 0060084 | 90x200cm R55 | gl.zilver/helder | ATP5509020VAK | stuk | 1608,00 | 284 | 1 |
| 0060085 | 90x200cm R55 | wit/helder glas | ATP55090202AK | stuk | 1447,00 | 284 | 1 |
| 0060086 | 90x200cm R55 m. KermiClean | gl.zilver/helder | ATP5509020VPK | stuk | 1881,00 | 284 | 1 |
| 0060087 | 90x200cm R55 m. KermiClean | wit/helder glas | ATP55090202PK | stuk | 1719,00 | 284 | 1 |
| 0969001 | 100x185cm R50 | glanszilv./helder | ATP5010018VA | stuk | 1468,00 | 284 | 1 |
| 0969028 | 100x185cm R50 | wit/helder glas | ATP50100182A | stuk | 1322,00 | 284 | 1 |
| 0969478 | 100x185cm R50 m. KermiClean | glanszilv./helder | ATP5010018VPK | stuk | 1741,00 | 284 | 1 |
| 0969486 | 100x185cm R50 m. KermiClean | wit/helder glas | ATP50100182PK | stuk | 1594,00 | 284 | 1 |
| 0969036 | 100x185cm R55 | glanszilv./helder | ATP5510118VA | stuk | 1468,00 | 284 | 1 |
| 0969044 | 100x185cm R55 | wit/helder glas | ATP55101182A | stuk | 1322,00 | 284 | 1 |
| 0969494 | 100x185cm R55 m. KermiClean | glanszilv./helder | ATP5510118VPK | stuk | 1741,00 | 284 | 1 |
| 0969508 | 100x185cm R55 m. KermiClean | wit/helder glas | ATP55101182PK | stuk | 1594,00 | 284 | 1 |
| 0060088 | 100x200cm R50 | gl.zilver/helder | ATP5010020VAK | stuk | 1688,00 | 284 | 1 |
| 0060089 | 100x200cm R50 | wit/helder glas | ATP50100202AK | stuk | 1520,00 | 284 | 1 |
| 0060090 | 100x200cm R 50 m. KermiClean | gl.zilver/helder | ATP5010020VPK | stuk | 1961,00 | 284 | 1 |
| 0060091 | 100x200cm R50 m. KermiClean | wit/helder glas | ATP50100202PK | stuk | 1793,00 | 284 | 1 |
| 0060092 | 100x200cm R55 | gl.zilver/helder | ATP5510120VAK | stuk | 1688,00 | 284 | 1 |
| 0060093 | 100x200cm R55 | wit/helder glas | ATP55101202AK | stuk | 1520,00 | 284 | 1 |
| 0060094 | 100x200cm R55 m. KermiClean | gl.zilver/helder | ATP5510120VPK | stuk | 1961,00 | 284 | 1 |
| 0060095 | 100x200cm R55 m. KermiClean | wit/helder glas | ATP55101202PK | stuk | 1793,00 | 284 | 1 |
| douchecabine vijfhoekig | | | | | | | |
| 0969052 | 90x185cm -45 | glanszilv./helder | ATF4509018VAK | stuk | 1492,00 | 284 | 1 |
| 0969060 | 90x185cm -45 | wit/helder glas | ATF45090182AK | stuk | 1342,00 | 284 | 1 |
| 0969516 | 90x185cm (45) m. KermiClean | glanszilv./helder | ATF4509018VPK | stuk | 1765,00 | 284 | 1 |
| 0969524 | 90x185cm (45) m. KermiClean | wit/helder glas | ATF45090182PK | stuk | 1615,00 | 284 | 1 |
| 0060096 | 90x200cm -45 | gl.zilver/helder | ATF4509020VAK | stuk | 1641,00 | 284 | 1 |
| 0060097 | 90x200cm -45 | wit/helder glas | ATF45090202AK | stuk | 1476,00 | 284 | 1 |
| 0060098 | 90x200cm (45) m. KermiClean | gl.zilver/helder | ATF4509020VPK | stuk | 1914,00 | 284 | 1 |
| 0060099 | 90x200cm (45) m. KermiClean | wit/helder glas | ATF45090202PK | stuk | 1749,00 | 284 | 1 |
| 0969600 | 100x185cm -50 | glanszilv./helder | ATF5010018VAK | stuk | 1567,00 | 284 | 1 |
| 0969601 | 100x185cm -50 | wit/helder glas | ATF50100182AK | stuk | 1410,00 | 284 | 1 |
| 0969602 | 100x185cm (50) m. KermiClean | glanszilv./helder | ATF5010018VPK | stuk | 1839,00 | 284 | 1 |
| 0969603 | 100x185cm (50) m. KermiClean | wit/helder glas | ATF50100182PK | stuk | 1683,00 | 284 | 1 |
| 0969079 | 100x185cm -53,7 | glanszilv./helder | ATF5310018VA | stuk | 1567,00 | 284 | 1 |
| 0969087 | 100x185cm -53,7 | wit/helder glas | ATF53100182A | stuk | 1410,00 | 284 | 1 |
| 0969532 | 100x185cm (53.7) m. KermiClean | glanszilv./helder | ATF5310018VP | stuk | 1839,00 | 284 | 1 |
| 0969540 | 100x185cm (53.7) m. KermiClean | wit/helder glas | ATF53100182P | stuk | 1683,00 | 284 | 1 |
| 0060100 | 100x200cm -50 | gl.zilver/helder | ATF5010020VAK | stuk | 1723,00 | 284 | 1 |
| 0060101 | 100x200cm -50 | wit/helder glas | ATF50100202AK | stuk | 1551,00 | 284 | 1 |
| 0060102 | 100x200cm (50) m. KermiClean | gl.zilver/helder | ATF5010020VPK | stuk | 1996,00 | 284 | 1 |
| 0060103 | 100x200cm (50) m. KermiClean | wit/helder glas | ATF50100202PK | stuk | 1823,00 | 284 | 1 |
| 0060104 | 100x200cm -55 | gl.zilver/helder | ATF5310020VAK | stuk | 1723,00 | 284 | 1 |
| 0060105 | 100x200cm -55 | wit/helder glas | ATF53100202AK | stuk | 1551,00 | 284 | 1 |
| 0060106 | 100x200cm (55) m. KermiClean | gl.zilver/helder | ATF5310020VPK | stuk | 1996,00 | 284 | 1 |
| 0060107 | 100x200cm (55) m. KermiClean | wit/helder glas | ATF53100202PK | stuk | 1823,00 | 284 | 1 |



Sanitair producten

Baden /
douchebakken /
stoomcabines

Kranen

Douchegarnituur

Accessoires en
spiegels**Douchewanden**Toebehoren &
afvoerenSpoel- &
installatiesystemenBadkamermeubelen
en toiletkastenGootstenen en
wastroggen

Utiliteit

| Art.nr | Specificaties | Kleur | Lev.nr | Ehd | Prijs | Grp | CC |
|--------|---------------|-------|--------|-----|-------|-----|----|
|--------|---------------|-------|--------|-----|-------|-----|----|

Kermi Atea

pendel deur



| | | | | | | | | |
|---------|-----------|---------------|--------------------|---------------|------|---------|-----|---|
| 0969168 | 80x185cm | | glanszilver/helder | ATPTD08018VAK | stuk | 719,00 | 284 | 1 |
| 0969192 | 80x185cm | | wit/helder glas | ATPTD080182AK | stuk | 647,00 | 284 | 1 |
| 0969613 | 80x185cm | m. KermiClean | glanszilver/helder | ATPTD08018VPK | stuk | 872,00 | 284 | 1 |
| 0969656 | 80x185cm | m. KermiClean | wit/helder glas | ATPTD080182PK | stuk | 800,00 | 284 | 1 |
| 0960048 | 80x200cm | | gl.zilver/helder | ATPTD08020VAK | stuk | 791,00 | 284 | 1 |
| 0960049 | 80x200cm | | wit/helder glas | ATPTD080202AK | stuk | 712,00 | 284 | 1 |
| 0960050 | 80x200cm | m. KermiClean | gl.zilver/helder | ATPTD08020VPK | stuk | 944,00 | 284 | 1 |
| 0960051 | 80x200cm | m. KermiClean | wit/helder glas | ATPTD080202PK | stuk | 852,00 | 284 | 1 |
| 0969176 | 90x185cm | | glanszilver/helder | ATPTD09018VAK | stuk | 749,00 | 284 | 0 |
| 0969206 | 90x185cm | | wit/helder glas | ATPTD090182A | stuk | 674,00 | 284 | 1 |
| 0969621 | 90x185cm | m. KermiClean | glanszilver/helder | ATPTD09018VPK | stuk | 901,00 | 284 | 1 |
| 0969664 | 90x185cm | m. KermiClean | wit/helder glas | ATPTD090182P | stuk | 827,00 | 284 | 1 |
| 0960052 | 90x200cm | | gl.zilver/helder | ATPTD09020VAK | stuk | 824,00 | 284 | 1 |
| 0960053 | 90x200cm | | wit/helder glas | ATPTD090202AK | stuk | 741,00 | 284 | 1 |
| 0960054 | 90x200cm | m. KermiClean | gl.zilver/helder | ATPTD09020VPK | stuk | 976,00 | 284 | 1 |
| 0960055 | 90x200cm | m. KermiClean | wit/helder glas | ATPTD090202PK | stuk | 894,00 | 284 | 1 |
| 0969184 | 100x185cm | | glanszilver/helder | ATPTD10018VAK | stuk | 787,00 | 284 | 1 |
| 0969214 | 100x185cm | | wit/helder glas | ATPTD100182A | stuk | 708,00 | 284 | 1 |
| 0969648 | 100x185cm | m. KermiClean | glanszilver/helder | ATPTD10018VPK | stuk | 939,00 | 284 | 1 |
| 0969672 | 100x185cm | m. KermiClean | wit/helder glas | ATPTD100182PK | stuk | 860,00 | 284 | 1 |
| 0960056 | 100x200cm | | gl.zilver/helder | ATPTD10020VAK | stuk | 865,00 | 284 | 1 |
| 0960057 | 100x200cm | | wit/helder glas | ATPTD100202AK | stuk | 778,00 | 284 | 1 |
| 0960058 | 100x200cm | m. KermiClean | gl.zilver/helder | ATPTD10020VPK | stuk | 1018,00 | 284 | 1 |
| 0960059 | 100x200cm | m. KermiClean | wit/helder glas | ATPTD100202PK | stuk | 931,00 | 284 | 1 |

badklapwand

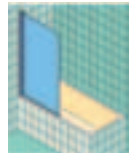

| | | | | | | | | |
|---------|----------|----------------------|--------------------|---------------|------|--------|-----|---|
| 0969222 | 75x150cm | rechts | glanszilver/helder | ATDFR07515VAK | stuk | 441,00 | 284 | 1 |
| 0969230 | 75x150cm | rechts | wit/helder glas | ATDFR075152AK | stuk | 397,00 | 284 | 1 |
| 0969680 | 75x150cm | rechts m. KermiClean | glanszilver/helder | ATDFR07515VPK | stuk | 593,00 | 284 | 1 |
| 0969699 | 75x150cm | rechts m. KermiClean | wit/helder glas | ATDFR075152PK | stuk | 549,00 | 284 | 1 |
| 0969249 | 75x150cm | links | glanszilver/helder | ATDFL07515VAK | stuk | 441,00 | 284 | 1 |
| 0969257 | 75x150cm | links | wit/helder glas | ATDFL075152AK | stuk | 397,00 | 284 | 1 |
| 0969702 | 75x150cm | links m. KermiClean | glanszilver/helder | ATDFL07515VPK | stuk | 593,00 | 284 | 1 |
| 0969710 | 75x150cm | links m. KermiClean | wit/helder glas | ATDFL075152PK | stuk | 549,00 | 284 | 1 |

Kermi Atea accessoires

| | | | | | | | | |
|---------|--------------------|-------------|--|--------------|------|-------|-----|---|
| 0969265 | verbredingsprofiel | glanszilver | | ZDSVSPAT185V | stuk | 71,00 | 284 | 1 |
| 0969273 | verbredingsprofiel | wit | | ZDSVSPAT1852 | stuk | 58,50 | 284 | 1 |

Kermi Ibiza 2000

draaideur m. bovenprofiel

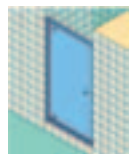

| | | | | | | | | |
|---------|----------|---------------|------------------|--------------|------|--------|-----|---|
| 0987654 | 80x185cm | | matzilver/helder | I2KTD080181A | stuk | 470,00 | 284 | 1 |
| 0987662 | 80x185cm | | wit/helder | I2KTD080182A | stuk | 526,00 | 284 | 1 |
| 0987670 | 80x185cm | | perg./helder | I2KTD08018FA | stuk | 526,00 | 284 | 1 |
| 0970913 | 80x185cm | m. KermiClean | matzilver/helder | I2KTD080181P | stuk | 620,00 | 284 | 1 |
| 0970921 | 80x185cm | m. KermiClean | wit/helder | I2KTD080182P | stuk | 676,00 | 284 | 1 |
| 0970948 | 80x185cm | m. KermiClean | perg./helder | I2KTD08018FP | stuk | 676,00 | 284 | 1 |
| 0984922 | 90x185cm | | matzilver/helder | I2KTD090181A | stuk | 484,00 | 284 | 0 |
| 0984930 | 90x185cm | | wit/helder | I2KTD090182A | stuk | 543,00 | 284 | 0 |
| 0984949 | 90x185cm | | perg./helder | I2KTD09018FA | stuk | 543,00 | 284 | 1 |
| 0970956 | 90x185cm | m. KermiClean | matzilver/helder | I2KTD090181P | stuk | 634,00 | 284 | 1 |
| 0970964 | 90x185cm | m. KermiClean | wit/helder | I2KTD090182P | stuk | 692,00 | 284 | 1 |
| 0970972 | 90x185cm | m. KermiClean | perg./helder | I2KTD09018FP | stuk | 692,00 | 284 | 1 |

| Art.nr | Specificaties | Kleur | Lev.nr | Ehd | Prijs | Grp | CC | |
|---|---------------|----------------------|-----------------|--------------|--------|--------|-----|---|
| Kermi Ibiza 2000 | | | | | | | | |
| draaideur z. bovenprofiel | | | | | | | | |
| 0995665 | 80x185cm | matzilv./helder | I2STW080181A | stuk | 461,00 | 284 | 1 | |
| 0995673 | 80x185cm | wit/helder | I2STW080182A | stuk | 516,00 | 284 | 1 | |
| 0995681 | 80x185cm | perg./helder | I2STW08018FA | stuk | 516,00 | 284 | 1 | |
| 0971189 | 80x185cm | m. KermiClean | zilver/helder | I2STW080181P | stuk | 610,00 | 284 | 1 |
| 0971197 | 80x185cm | m. KermiClean | wit/helder | I2STW080182P | stuk | 666,00 | 284 | 1 |
| 0971200 | 80x185cm | m. KermiClean | perg./helder | I2STW08018FP | stuk | 666,00 | 284 | 1 |
| 0995703 | 90x185cm | matzilv./helder | I2STW090181A | stuk | 474,00 | 284 | 0 | |
| 0995711 | 90x185cm | wit/helder | I2STW090182A | stuk | 531,00 | 284 | 1 | |
| 0995738 | 90x185cm | perg./helder | I2STW09018FA | stuk | 531,00 | 284 | 1 | |
| 0971219 | 90x185cm | m. KermiClean | zilver/helder | I2STW090181P | stuk | 624,00 | 284 | 1 |
| 0971227 | 90x185cm | m. KermiClean | wit/helder | I2STW090182P | stuk | 681,00 | 284 | 1 |
| 0971235 | 90x185cm | m. KermiClean | perg./helder | I2STW09018FP | stuk | 681,00 | 284 | 1 |
| 0995746 | 100x185cm | matzilv./helder | I2STW100181A | stuk | 499,00 | 284 | 0 | |
| 0995754 | 100x185cm | wit/helder | I2STW100182A | stuk | 558,00 | 284 | 1 | |
| 0995762 | 100x185cm | perg./helder | I2STW10018FA | stuk | 558,00 | 284 | 1 | |
| 0971243 | 100x185cm | m. KermiClean | zilver/helder | I2STW100181P | stuk | 648,00 | 284 | 1 |
| 0971251 | 100x185cm | m. KermiClean | wit/helder | I2STW100182P | stuk | 708,00 | 284 | 1 |
| 0971278 | 100x185cm | m. KermiClean | perg./helder | I2STW10018FP | stuk | 708,00 | 284 | 1 |
| klapdeur | | | | | | | | |
| 0985058 | 80x185cm | matzilv./helder | I2PTD080181A | stuk | 434,00 | 284 | 1 | |
| 0985066 | 80x185cm | wit/helder | I2PTD080182A | stuk | 485,00 | 284 | 1 | |
| 0985074 | 80x185cm | perg./helder | I2PTD08018FA | stuk | 485,00 | 284 | 1 | |
| 0971014 | 80x185cm | m. KermiClean | matzilv./helder | I2PTD080181P | stuk | 584,00 | 284 | 1 |
| 0971022 | 80x185cm | m. KermiClean | wit/helder | I2PTD080182P | stuk | 635,00 | 284 | 1 |
| 0971030 | 80x185cm | m. KermiClean | perg./helder | I2PTD08018FP | stuk | 635,00 | 284 | 1 |
| 0985082 | 90x185cm | matzilv./helder | I2PTD090181A | stuk | 442,00 | 284 | 0 | |
| 0985090 | 90x185cm | wit/helder | I2PTD090182A | stuk | 496,00 | 284 | 0 | |
| 0985104 | 90x185cm | perg./helder | I2PTD09018FA | stuk | 496,00 | 284 | 1 | |
| 0971049 | 90x185cm | m. KermiClean | matzilv./helder | I2PTD090181P | stuk | 592,00 | 284 | 1 |
| 0971057 | 90x185cm | m. KermiClean | wit/helder | I2PTD090182P | stuk | 645,00 | 284 | 1 |
| 0971065 | 90x185cm | m. KermiClean | perg./helder | I2PTD09018FP | stuk | 645,00 | 284 | 1 |
| pendeldeur m. vast segment | | | | | | | | |
| 0985007 | 120x185cm | rechts | matzilv./helder | I2PFR120181A | stuk | 733,00 | 284 | 1 |
| 0985008 | 120x185cm | rechts | wit/helder | I2PFR120182A | stuk | 822,00 | 284 | 1 |
| 0985009 | 120x185cm | rechts | perg./helder | I2PFR12018FA | stuk | 822,00 | 284 | 1 |
| 0980595 | 120x185cm | rechts m. KermiClean | matzilv./helder | I2PFR120181P | stuk | 883,00 | 284 | 1 |
| 0980997 | 120x185cm | rechts m. KermiClean | wit/helder | I2PFR120182P | stuk | 971,00 | 284 | 1 |
| 0980998 | 120x185cm | rechts m. KermiClean | perg./helder | I2PFR12018FP | stuk | 971,00 | 284 | 1 |
| 0985011 | 120x185cm | links | matzilv./helder | I2PFL120181A | stuk | 733,00 | 284 | 1 |
| 0985018 | 120x185cm | links | wit/helder | I2PFL120182A | stuk | 822,00 | 284 | 1 |
| 0985021 | 120x185cm | links | perg./helder | I2PFL12018FA | stuk | 822,00 | 284 | 1 |
| 0980999 | 120x185cm | links m. KermiClean | matzilv./helder | I2PFL120181P | stuk | 883,00 | 284 | 1 |
| 0981066 | 120x185cm | links m. KermiClean | wit/helder | I2PFL120182P | stuk | 971,00 | 284 | 1 |
| 0981067 | 120x185cm | links m. KermiClean | perg./helder | I2PFL12018FP | stuk | 971,00 | 284 | 1 |
| klapdeur 2-delig voor hoekinstap | | | | | | | | |
| 0988855 | 90x185cm | links | matzilv./helder | I2ESL090181A | stuk | 407,00 | 284 | 0 |
| 0988871 | 90x185cm | links | wit/helder | I2ESL090182A | stuk | 457,00 | 284 | 1 |
| 0988901 | 90x185cm | links | perg./helder | I2ESL09018FA | stuk | 457,00 | 284 | 1 |
| 0970751 | 90x185cm | links m. KermiClean | matzilv./helder | I2ESL090181P | stuk | 557,00 | 284 | 1 |
| 0970766 | 90x185cm | links m. KermiClean | wit/helder | I2ESL090182P | stuk | 606,00 | 284 | 1 |
| 0970778 | 90x185cm | links m. KermiClean | perg./helder | I2ESL09018FP | stuk | 606,00 | 284 | 1 |
| 0988847 | 90x185cm | rechts | matzilv./helder | I2ESR090181A | stuk | 407,00 | 284 | 0 |
| 0988863 | 90x185cm | rechts | wit/helder | I2ESR090182A | stuk | 457,00 | 284 | 1 |
| 0988898 | 90x185cm | rechts | perg./helder | I2ESR09018FA | stuk | 457,00 | 284 | 1 |
| 0970786 | 90x185cm | rechts m. KermiClean | matzilv./helder | I2ESR090181P | stuk | 557,00 | 284 | 1 |
| 0970794 | 90x185cm | rechts m. KermiClean | wit/helder | I2ESR090182P | stuk | 606,00 | 284 | 1 |
| 0970808 | 90x185cm | rechts m. KermiClean | perg./helder | I2ESR09018FP | stuk | 606,00 | 284 | 1 |



Sanitair producten

Baden /
douchebakken /
stoomcabines

Kranen

Douchegarnituur

Accessoires en
spiegels

Douchewanden

Toebehoren &
afvoerenSpoel- &
installatiesystemenBadkamermeubelen
en toiletkastenGootstenen en
wastroggen

Utiliteit

| | Art.nr | Specificaties | Kleur | Lev.nr | Ehd | Prijs | Grp | CC | |
|---|---|---|----------------------|------------------|---------------|--------|---------|-----|---|
| | Kermi Ibiza 2000 | | | | | | | | |
| | schuifdeur 2-delig voor hoekinstap | | | | | | | | |
| Sanitair producten | 0987743 | 80x185cm | matzilver/helder | I2ED2080181A | stuk | 333,00 | 284 | 1 | |
| | 0987751 | 80x185cm | wit/helder | I2ED2080182A | stuk | 355,00 | 284 | 1 | |
| | 0987778 | 80x185cm | perg./helder | I2ED208018FA | stuk | 355,00 | 284 | 1 | |
| | 0970700 | 80x185cm | m. KermiClean | matzilver/helder | I2ED2080181P | stuk | 482,00 | 284 | 1 |
| Baden / douchebakken / stoomcabines | 0970719 | 80x185cm | m. KermiClean | wit/helder glas | I2ED2080182P | stuk | 505,00 | 284 | 1 |
| | 0970727 | 80x185cm | m. KermiClean | perg./helder | I2ED208018FP | stuk | 505,00 | 284 | 1 |
| | 0985759 | 90x185cm | | matzilver/helder | I2ED2090181A | stuk | 341,00 | 284 | 0 |
| | 0985767 | 90x185cm | | wit/helder | I2ED2090182A | stuk | 381,00 | 284 | 0 |
| Kranen | 0985775 | 90x185cm | | perg./helder | I2ED209018FA | stuk | 381,00 | 284 | 1 |
| | 0970728 | 90x185cm | m. KermiClean | matzilver/helder | I2ED2090181P | stuk | 490,00 | 284 | 1 |
| | 0970735 | 90x185cm | m. KermiClean | wit/helder | I2ED2090182P | stuk | 530,00 | 284 | 1 |
| | 0970743 | 90x185cm | m. KermiClean | perg./helder | I2ED209018FP | stuk | 530,00 | 284 | 1 |
| | schuifdeur 3-delig voor hoekinstap | | | | | | | | |
| Douchegarnituur | 0979031 | 90x185cm | matzilver/helder | I2ED30901851A | stuk | 421,00 | 284 | 1 | |
| | 0979058 | 90x185cm | wit/helder | I2ED30901852A | stuk | 471,00 | 284 | 1 | |
| | 0979066 | 90x185cm | | perg./helder | I2ED3090185FA | stuk | 471,00 | 284 | 1 |
| | 0979074 | 90x185cm | m. KermiClean | matzilver/helder | I2ED30901851P | stuk | 570,00 | 284 | 1 |
| Accessoires en spiegels | 0979082 | 90x185cm | m. KermiClean | wit/helder | I2ED30901852P | stuk | 621,00 | 284 | 1 |
| | 0979090 | 90x185cm | m. KermiClean | perg./helder | I2ED3090185FP | stuk | 621,00 | 284 | 1 |
| | hoekinstap 3-delig | | | | | | | | |
| Douchewanden | 0979376 | 90x185cm | zilver/helder | IBIZA2000 | stuk | 842,00 | 284 | 1 | |
| | 0979384 | 90x185cm | wit/helder | IBIZA2000 | stuk | 942,00 | 284 | 1 | |
| | 0979392 | 90x185cm | | perg./helder | IBIZA2000 | stuk | 942,00 | 284 | 1 |
| | 0979333 | 90x185cm | m. KermiClean | zilver/helder | IBIZA2000 | stuk | 1140,00 | 284 | 1 |
| | 0979341 | 90x185cm | m. KermiClean | wit/helder | IBIZA2000 | stuk | 1242,00 | 284 | 1 |
| | 0979368 | 90x185cm | m. KermiClean | perg./helder | IBIZA2000 | stuk | 1242,00 | 284 | 1 |
| | schuifdeur 2-delig voor hoekinstap z. bodemprofiel | | | | | | | | |
| Toebehoren & afvoeren | 0979104 | 90x200cm | links | zilver/helder | IME2L090201A | stuk | 414,00 | 284 | 1 |
| | 0979112 | 90x200cm | links | wit/helder | IME2L090202A | stuk | 464,00 | 284 | 1 |
| | 0979120 | 90x200cm | links | perg./helder | IME2L09020FA | stuk | 464,00 | 284 | 1 |
| | 0979163 | 90x200cm | links m. KermiClean | zilver/helder | IME2L090201P | stuk | 563,00 | 284 | 1 |
| Spoel- & installatiesystemen | 0979177 | 90x200cm | links m. KermiClean | wit/helder | IME2L090202P | stuk | 613,00 | 284 | 1 |
| | 0979198 | 90x200cm | links m. KermiClean | perg./helder | IME2L09020FP | stuk | 613,00 | 284 | 1 |
| | 0979139 | 90x200cm | rechts | zilver/helder | IME2R090201A | stuk | 414,00 | 284 | 1 |
| | 0979147 | 90x200cm | rechts | wit/helder | IME2R090202A | stuk | 464,00 | 284 | 1 |
| | 0979155 | 90x200cm | rechts | perg./helder | IME2R09020FA | stuk | 464,00 | 284 | 1 |
| | 0979201 | 90x200cm | rechts m. KermiClean | zilver/helder | IME2R090201P | stuk | 563,00 | 284 | 1 |
| Badkamermeubelen en toiletkasten | 0979228 | 90x200cm | rechts m. KermiClean | wit/helder | IME2R090202P | stuk | 613,00 | 284 | 1 |
| | 0979236 | 90x200cm | rechts m. KermiClean | perg./helder | IME2R09020FP | stuk | 613,00 | 284 | 1 |
| | | hoekinstap 2-delig z. bodemprofiel m. schuifdeuren | | | | | | | |
| Gootstenen en wastroggen | 0979406 | 90x200cm | zilver/helder | IBIZA2000 | stuk | 828,00 | 284 | 1 | |
| | 0979414 | 90x200cm | wit/helder | IBIZA2000 | stuk | 928,00 | 284 | 1 | |
| | 0979422 | 90x200cm | | perg./helder | IBIZA2000 | stuk | 928,00 | 284 | 1 |
| | 0979430 | 90x200cm | m. KermiClean | zilver/helder | IBIZA2000 | stuk | 1126,00 | 284 | 1 |
| | 0979449 | 90x200cm | m. KermiClean | wit/helder | IBIZA2000 | stuk | 1226,00 | 284 | 1 |
| | 0979457 | 90x200cm | m. KermiClean | perg./helder | IBIZA2000 | stuk | 1226,00 | 284 | 1 |
| | schuifdeur 3-delig | | | | | | | | |
| Utiliteit | 0987689 | 80x185cm | matzilver/helder | I2STD080181A | stuk | 417,00 | 284 | 1 | |
| | 0987697 | 80x185cm | wit/helder | I2STD080182A | stuk | 467,00 | 284 | 1 | |
| | 0987700 | 80x185cm | | perg./helder | I2STD08018FA | stuk | 467,00 | 284 | 1 |
| | 0971111 | 80x185cm | m. KermiClean | matzilver/helder | I2STD080181P | stuk | 566,00 | 284 | 1 |
| | 0971138 | 80x185cm | m. KermiClean | wit/helder | I2STD080182P | stuk | 617,00 | 284 | 1 |
| | 0971146 | 80x185cm | m. KermiClean | perg./helder | I2STD08018FP | stuk | 617,00 | 284 | 1 |
| | 0985783 | 90x185cm | | matzilver/helder | I2STD090181A | stuk | 426,00 | 284 | 0 |
| | 0985791 | 90x185cm | | wit/helder | I2STD090182A | stuk | 477,00 | 284 | 1 |
| | 0985805 | 90x185cm | | perg./helder | I2STD09018FA | stuk | 477,00 | 284 | 1 |
| | 0971154 | 90x185cm | m. KermiClean | matzilver/helder | I2STD090181P | stuk | 576,00 | 284 | 1 |
| | 0971162 | 90x185cm | m. KermiClean | wit/helder | I2STD090182P | stuk | 627,00 | 284 | 1 |
| | 0971170 | 90x185cm | m. KermiClean | perg./helder | I2STD09018FP | stuk | 627,00 | 284 | 1 |

Art.nr Specificaties Kleur Lev.nr Ehd Prijs Grp CC

Kermi Ibiza 2000

zijwand

| | | | | | | | | |
|---------|-------------|---------------|------------------|--------------|------|--------|-----|---|
| 0987719 | 77/80x185cm | | matzilver/helder | I2TWD080181A | stuk | 274,00 | 284 | 1 |
| 0987727 | 77/80x185cm | | wit/helder | I2TWD080182A | stuk | 307,00 | 284 | 1 |
| 0987735 | 77/80x185cm | | perg./helder | I2TWD08018FA | stuk | 307,00 | 284 | 1 |
| 0971286 | 77/80x185cm | m. KermiClean | matzilver/helder | I2TWD080181P | stuk | 394,00 | 284 | 1 |
| 0971308 | 77/80x185cm | m. KermiClean | wit/helder | I2TWD080182P | stuk | 427,00 | 284 | 1 |
| 0971316 | 77/80x185cm | m. KermiClean | perg./helder | I2TWD08018FP | stuk | 427,00 | 284 | 1 |
| 0984965 | 87/90x185cm | | matzilver/helder | I2TWD090181A | stuk | 280,00 | 284 | 0 |
| 0984973 | 87/90x185cm | | wit/helder | I2TWD090182A | stuk | 313,00 | 284 | 0 |
| 0984981 | 87/90x185cm | | perg./helder | I2TWD09018FA | stuk | 313,00 | 284 | 1 |
| 0971324 | 87/90x185cm | m. KermiClean | matzilver/helder | I2TWD090181P | stuk | 400,00 | 284 | 1 |
| 0971332 | 87/90x185cm | m. KermiClean | wit/helder | I2TWD090182P | stuk | 433,00 | 284 | 1 |
| 0971340 | 87/90x185cm | m. KermiClean | perg./helder | I2TWD09018FP | stuk | 433,00 | 284 | 1 |
| 0979899 | 98/101x185 | | matzilver/helder | I2TWD100181A | stuk | 319,00 | 284 | 0 |
| 0979902 | 98/101x185 | | wit/helder | I2TWD100182A | stuk | 357,00 | 284 | 1 |
| 0979929 | 98/101x185 | | perg./helder | I2TWD10018FA | stuk | 357,00 | 284 | 1 |
| 0979937 | 98/101x185 | m. KermiClean | matzilver/helder | I2TWD100181P | stuk | 439,00 | 284 | 1 |
| 0979945 | 98/101x185 | m. KermiClean | wit/helder | I2TWD100182P | stuk | 477,00 | 284 | 1 |
| 0979953 | 98/101x185 | m. KermiClean | perg./helder | I2TWD10018FP | stuk | 477,00 | 284 | 1 |

douchecabine hoekinstap 2-delig m. schuifdeuren

| | | | | | | | | |
|---------|----------|--|------------------|-----------|------|--------|-----|---|
| 0987786 | 80x185cm | | matzilver/helder | IBIZA2000 | stuk | 666,00 | 284 | 1 |
| 0987794 | 80x185cm | | wit/helder | IBIZA2000 | stuk | 710,00 | 284 | 1 |
| 0987808 | 80x185cm | | perg./helder | IBIZA2000 | stuk | 710,00 | 284 | 1 |
| 0985880 | 90x185cm | | matzilver/helder | IBIZA2000 | stuk | 682,00 | 284 | 0 |
| 0985899 | 90x185cm | | wit/helder | IBIZA2000 | stuk | 762,00 | 284 | 0 |
| 0985902 | 90x185cm | | perg./helder | IBIZA2000 | stuk | 762,00 | 284 | 1 |



douchecabine hoekinstap m. klapdeuren

| | | | | | | | | |
|---------|----------|--|------------------|-----------|------|--------|-----|---|
| 0988928 | 90x185cm | | matzilver/helder | IBIZA2000 | stuk | 814,00 | 284 | 1 |
| 0988936 | 90x185cm | | wit/helder | IBIZA2000 | stuk | 914,00 | 284 | 1 |
| 0988944 | 90x185cm | | perg./helder | IBIZA2000 | stuk | 914,00 | 284 | 1 |



douchecabine kwartrond m. klapdeuren

| | | | | | | | | |
|---------|----------|---------------|------------------|--------------|------|---------|-----|---|
| 0985694 | 90x185cm | | matzilver/helder | I2P53090181A | stuk | 917,00 | 284 | 0 |
| 0985708 | 90x185cm | | wit/helder | I2P53090182A | stuk | 1025,00 | 284 | 0 |
| 0985716 | 90x185cm | | perg./helder | I2P5309018FA | stuk | 1025,00 | 284 | 1 |
| 0970980 | 90x185cm | m. KermiClean | zilver/helder | I2P53090181P | stuk | 1184,00 | 284 | 1 |
| 0970999 | 90x185cm | m. KermiClean | wit/helder | I2P53090182P | stuk | 1293,00 | 284 | 1 |
| 0971006 | 90x185cm | m. KermiClean | perg./helder | I2P5309018FP | stuk | 1293,00 | 284 | 1 |



douchecabine kwartrond m. schuifdeuren

| | | | | | | | | |
|---------|----------|---------------|------------------|--------------|------|---------|-----|---|
| 0985015 | 90x185cm | | matzilver/helder | I2R53090181A | stuk | 1031,00 | 284 | 1 |
| 0985023 | 90x185cm | | wit/helder | I2R53090182A | stuk | 1155,00 | 284 | 1 |
| 0985031 | 90x185cm | | perg./helder | I2R5309018FA | stuk | 1155,00 | 284 | 1 |
| 0971073 | 90x185cm | m. KermiClean | zilver/helder | I2R53090181P | stuk | 1298,00 | 284 | 1 |
| 0971081 | 90x185cm | m. KermiClean | wit/helder glas | I2R53090182P | stuk | 1422,00 | 284 | 1 |
| 0971103 | 90x185cm | m. KermiClean | perg./helder | I2R5309018FP | stuk | 1422,00 | 284 | 1 |



douchecabine vijfhoekig m. klapdeuren

| | | | | | | | | |
|---------|---------------|---------------|------------------|--------------|------|---------|-----|---|
| 0985724 | 90x185 (40) | | matzilver/helder | I2F40090181A | stuk | 907,00 | 284 | 1 |
| 0985732 | 90x185 (40) | | wit/helder | I2F40090182A | stuk | 1015,00 | 284 | 1 |
| 0985740 | 90x185 (40) | | perg./helder | I2F4009018FA | stuk | 1015,00 | 284 | 1 |
| 0970816 | 90x185 (40) | m. KermiClean | zilver/helder | I2F40090181P | stuk | 1174,00 | 284 | 1 |
| 0970824 | 90x185 (40) | m. KermiClean | wit/helder | I2F40090182P | stuk | 1283,00 | 284 | 1 |
| 0970832 | 90x185 (40) | m. KermiClean | perg./helder | I2F4009018FP | stuk | 1283,00 | 284 | 1 |
| 0985112 | 90x185 (45) | | matzilver/helder | I2F45090181A | stuk | 907,00 | 284 | 1 |
| 0985120 | 90x185 (45) | | wit/helder | I2F45090182A | stuk | 1015,00 | 284 | 1 |
| 0985139 | 90x185 (45) | | perg./helder | I2F4509018FA | stuk | 1015,00 | 284 | 1 |
| 0970840 | 90x185 (45) | m. KermiClean | zilver/helder | I2F45090181P | stuk | 1174,00 | 284 | 1 |
| 0970859 | 90x185 (45) | m. KermiClean | wit/helder | I2F45090182P | stuk | 1283,00 | 284 | 1 |
| 0970867 | 90x185 (45) | m. KermiClean | perg./helder | I2F4509018FP | stuk | 1283,00 | 284 | 1 |
| 0985953 | 90x185 (47.5) | | matzilver/helder | I2F53090181A | stuk | 907,00 | 284 | 1 |
| 0985961 | 90x185 (47.5) | | wit/helder | I2F53090182A | stuk | 1015,00 | 284 | 1 |
| 0985988 | 90x185 (47.5) | | perg./helder | I2F5309018FA | stuk | 1015,00 | 284 | 1 |
| 0970875 | 90x185 (47.5) | m. KermiClean | zilver/helder | I2F53090181P | stuk | 1174,00 | 284 | 1 |
| 0970891 | 90x185 (47.5) | m. KermiClean | wit/helder | I2F53090182P | stuk | 1283,00 | 284 | 1 |
| 0970905 | 90x185 (47.5) | m. KermiClean | perg./helder | I2F5309018FP | stuk | 1283,00 | 284 | 1 |



Sanitair producten

Baden /
douchebakken /
stoomcabines

Kranen

Douchegarnituur

Accessoires en
spiegels

Douchewanden

Toebehoren &
afvoeren

Spoel- &
installatiesystemen

Badkamermeubelen
en toiletkasten

Gootstenen en
wastroggen

Utiliteit

| Art.nr | Specificaties | Kleur | Lev.nr | Ehd | Prijs | Grp | CC |
|--------|---------------|-------|--------|-----|-------|-----|----|
|--------|---------------|-------|--------|-----|-------|-----|----|

Kermi Ibiza 2000

vouwdeur voor combinatie m. schuifdeur ED2

| | | | | | | | |
|---------|----------|------------------|--------------|------|--------|-----|---|
| 0979759 | 90x185cm | matzilver/helder | I2EF2090181A | stuk | 488,00 | 284 | 1 |
| 0979767 | 90x185cm | wit/helder | I2EF2090182A | stuk | 547,00 | 284 | 1 |
| 0979775 | 90x185cm | perg./helder | I2EF209018FA | stuk | 547,00 | 284 | 1 |

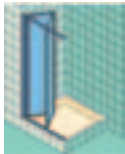

Sanitair producten

Baden /
douchebakken /
stoomcabines

vouwdeur voor nis of zijwand

| | | | | | | | |
|---------|----------|------------------|--------------|------|--------|-----|---|
| 0979848 | 90x185cm | matzilver/helder | I2FTD090181A | stuk | 488,00 | 284 | 1 |
| 0979856 | 90x185cm | wit/helder | I2FTD090182A | stuk | 547,00 | 284 | 1 |
| 0979864 | 90x185cm | perg./helder | I2FTD09018FA | stuk | 547,00 | 284 | 1 |

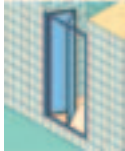

Kranen

Douchegarnituur

zijwand

| | | | | | | | | |
|---------|--------------|------------------|------------------|--------------|--------|--------|-----|---|
| 0990934 | 77/80x185cm | matzilver/helder | I2TWO080181A | stuk | 273,68 | 284 | 1 | |
| 0990935 | 77/80x185cm | wit/helder | I2TWO080182A | stuk | 305,45 | 284 | 1 | |
| 0990936 | 77/80x185cm | pergamon/helder | I2TWO08018FA | stuk | 305,45 | 284 | 1 | |
| 0990974 | 77/80x185cm | m. KermiClean | matzilver/helder | I2TWO080181P | stuk | 393,61 | 284 | 1 |
| 0990975 | 77/80x185cm | m. KermiClean | wit/helder | I2TWO080182P | stuk | 425,38 | 284 | 1 |
| 0990976 | 77/80x185cm | m. KermiClean | pergamon/helder | I2TWO08018FP | stuk | 425,38 | 284 | 1 |
| 0990910 | 87/90x185cm | matzilver/helder | I2TWO090181A | stuk | 279,83 | 284 | 1 | |
| 0990911 | 87/90x185cm | wit/helder | I2TWO090182A | stuk | 312,63 | 284 | 1 | |
| 0990912 | 87/90x185cm | pergamon/helder | I2TWO09018FA | stuk | 312,63 | 284 | 1 | |
| 0990977 | 87/90x185cm | m. KermiClean | matzilver/helder | I2TWO090181P | stuk | 399,76 | 284 | 1 |
| 0990978 | 87/90x185cm | m. KermiClean | wit/helder | I2TWO090182P | stuk | 432,56 | 284 | 1 |
| 0990979 | 87/90x185cm | m. KermiClean | pergamon/helder | I2TWO09018FP | stuk | 432,56 | 284 | 1 |
| 0990980 | 98/101x185cm | matzilver/helder | I2TWO100181A | stuk | 318,78 | 284 | 1 | |
| 0990982 | 98/101x185cm | wit/helder | I2TWO100182A | stuk | 356,70 | 284 | 1 | |
| 0990983 | 98/101x185cm | pergamon/helder | I2TWO10018FA | stuk | 356,70 | 284 | 1 | |
| 0990984 | 98/101x185cm | m. KermiClean | matzilver/helder | I2TWO100181P | stuk | 438,71 | 284 | 1 |
| 0990985 | 98/101x185cm | m. KermiClean | wit/helder | I2TWO100182P | stuk | 476,63 | 284 | 1 |
| 0990986 | 98/101x185cm | m. KermiClean | pergamon/helder | I2TWO10018FP | stuk | 476,63 | 284 | 1 |

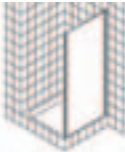

Accessoires en
spiegels

Douchewanden

Toebehoren &
afvoeren

Spoel- &
installatiesystemen

pendeldeur m. vast segment voor hoekinstap

| | | | | | | | | |
|---------|----------|----------------------|------------------|--------------|------|--------|-----|---|
| 0990938 | 90x185cm | links | matzilver/helder | I2EOL090181A | stuk | 447,93 | 284 | 1 |
| 0990940 | 90x185cm | links | wit/helder | I2EOL090182A | stuk | 502,25 | 284 | 1 |
| 0990942 | 90x185cm | links | pergamon/helder | I2EOL09018FA | stuk | 502,25 | 284 | 1 |
| 0990943 | 90x185cm | links m. KermiClean | matzilver/helder | I2EOL090181P | stuk | 597,58 | 284 | 1 |
| 0990944 | 90x185cm | links m. KermiClean | wit/helder | I2EOL090182P | stuk | 651,90 | 284 | 1 |
| 0990945 | 90x185cm | links m. KermiClean | pergamon/helder | I2EOL09018FP | stuk | 651,90 | 284 | 1 |
| 0990937 | 90x185cm | rechts | matzilver/helder | I2EOR090181A | stuk | 447,93 | 284 | 1 |
| 0990939 | 90x185cm | rechts | wit/helder | I2EOR090182A | stuk | 502,25 | 284 | 1 |
| 0990941 | 90x185cm | rechts | pergamon/helder | I2EOR09018FA | stuk | 502,25 | 284 | 1 |
| 0990946 | 90x185cm | rechts m. KermiClean | matzilver/helder | I2EOR090181P | stuk | 597,58 | 284 | 1 |
| 0990947 | 90x185cm | rechts m. KermiClean | wit/helder | I2EOR090182P | stuk | 651,90 | 284 | 1 |
| 0990948 | 90x185cm | rechts m. KermiClean | pergamon/helder | I2EOR09018FP | stuk | 651,90 | 284 | 1 |

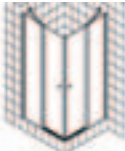

Badkamermeubelen
en toiletkasten

Gootstenen en
wastroggen

Utiliteit

douchecabine kwartrond m. vaste segmenten m. schuifdeuren

| | | | | | | | | |
|---------|----------|------------------|------------------|--------------|---------|---------|-----|---|
| 0990970 | 90x185cm | matzilver/helder | I2T20090181A | stuk | 1133,65 | 284 | 1 | |
| 0990971 | 90x185cm | wit/helder | I2T20090182A | stuk | 1269,68 | 284 | 1 | |
| 0990972 | 90x185cm | pergamon/helder | I2T2009018FA | stuk | 1269,98 | 284 | 1 | |
| 0990913 | 90x185cm | m. KermiClean | matzilver/helder | I2T20090181P | stuk | 1401,03 | 284 | 1 |
| 0990915 | 90x185cm | m. KermiClean | wit/helder | I2T20090182P | stuk | 1537,36 | 284 | 1 |
| 0990916 | 90x185cm | m. KermiClean | pergamon/helder | I2T2009018FP | stuk | 1537,36 | 284 | 1 |



draaideur m. bovenprofiel

| | | | | | | | | |
|---------|----------|------------------|------------------|--------------|--------|--------|-----|---|
| 0991032 | 80x185cm | matzilver/helder | I2KOD080181A | stuk | 469,45 | 284 | 1 | |
| 0991034 | 80x185cm | wit/helder | I2KOD080182A | stuk | 525,83 | 284 | 1 | |
| 0991036 | 80x185cm | pergamon/helder | I2KOD08018FA | stuk | 525,83 | 284 | 1 | |
| 0991033 | 80x185cm | m. KermiClean | matzilver/helder | I2KOD080181P | stuk | 619,10 | 284 | 1 |
| 0991035 | 80x185cm | m. KermiClean | wit/helder | I2KOD080182P | stuk | 675,48 | 284 | 1 |
| 0991037 | 80x185cm | m. KermiClean | pergamon/helder | I2KOD08018FP | stuk | 678,48 | 284 | 1 |
| 0990907 | 90x185cm | matzilver/helder | I2KOD090181A | stuk | 483,80 | 284 | 1 | |
| 0990908 | 90x185cm | wit/helder | I2KOD090182A | stuk | 542,23 | 284 | 1 | |
| 0990909 | 90x185cm | pergamon/helder | I2KOD09018FA | stuk | 542,23 | 284 | 1 | |
| 0990963 | 90x185cm | m. KermiClean | matzilver/helder | I2KOD090181P | stuk | 633,45 | 284 | 1 |
| 0990964 | 90x185cm | m. KermiClean | wit/helder | I2KOD090182P | stuk | 691,88 | 284 | 1 |
| 0990966 | 90x185cm | m. KermiClean | pergamon/helder | I2KOD09018FP | stuk | 691,88 | 284 | 1 |

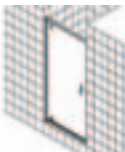

| Art.nr | Specificaties | Kleur | Lev.nr | Ehd | Prijs | Grp | CC |
|--------|---------------|-------|--------|-----|-------|-----|----|
|--------|---------------|-------|--------|-----|-------|-----|----|

Kermi Ibiza 2000

douchecabine kwartrond m. vaste segmenten m. pendeldeuren z. profiel

| | | | | | | | |
|---------|----------|---------------|------------------|--------------|------|---------|-------|
| 0990920 | 90x185cm | | matzilver/helder | I2020090181A | stuk | 916,35 | 284 1 |
| 0990921 | 90x185cm | | wit/helder | I2020090182A | stuk | 1025,00 | 284 1 |
| 0990923 | 90x185cm | | pergamon/helder | I202009018FA | stuk | 1025,00 | 284 1 |
| 0990967 | 90x185cm | m. KermiClean | matzilver/helder | I2020090181P | stuk | 1183,73 | 284 1 |
| 0990968 | 90x185cm | m. KermiClean | wit/helder | I2020090182P | stuk | 1292,38 | 284 1 |
| 0990969 | 90x185cm | m. KermiClean | pergamon/helder | I202009018FP | stuk | 1292,38 | 284 1 |

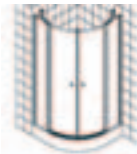

Sanitair producten

Baden /
douchebakken /
stoomcabines**pendeldeur m. vast segment z. profiel**

| | | | | | | | |
|---------|-----------|----------------------|------------------|--------------|------|--------|-------|
| 0990987 | 120x185cm | rechts | matzilver/helder | I2POR120181A | stuk | 732,88 | 284 1 |
| 0990988 | 120x185cm | rechts | wit/helder | I2POR120182A | stuk | 821,03 | 284 1 |
| 0990989 | 120x185cm | rechts | pergamon/helder | I2POR12018FA | stuk | 821,03 | 284 1 |
| 0990993 | 120x185cm | rechts m. KermiClean | matzilver/helder | I2POR120181P | stuk | 882,53 | 284 1 |
| 0990994 | 120x185cm | rechts m. KermiClean | wit/helder | I2POR120182P | stuk | 970,68 | 284 1 |
| 0990995 | 120x185cm | rechts m. KermiClean | pergamon/helder | I2POR12018FP | stuk | 970,68 | 284 1 |
| 0990990 | 120x185cm | links | matzilver/helder | I2POL120181A | stuk | 732,88 | 284 1 |
| 0990991 | 120x185cm | links | wit/helder | I2POL120182A | stuk | 821,03 | 284 1 |
| 0990992 | 120x185cm | links | pergamon/helder | I2POL12018FA | stuk | 821,03 | 284 1 |
| 0990996 | 120x185cm | links m. KermiClean | matzilver/helder | I2POL120181P | stuk | 882,53 | 284 1 |
| 0990997 | 120x185cm | links m. KermiClean | wit/helder | I2POL120182P | stuk | 970,68 | 284 1 |
| 0990998 | 120x185cm | links m. KermiClean | pergamon/helder | I2POL12018FP | stuk | 970,68 | 284 1 |



Kranen

Douchegarnituur

Accessoires en
spiegels**douchecabine vijfhoekig m. pendeldeuren z. profiel**

| | | | | | | | |
|---------|----------|--------------------|------------------|--------------|------|---------|-------|
| 0990924 | 90x185cm | -40 | matzilver/helder | I2B40090181A | stuk | 906,10 | 284 1 |
| 0990925 | 90x185cm | -40 | wit/helder | I2B40090182A | stuk | 1014,75 | 284 1 |
| 0990926 | 90x185cm | -40 | pergamon/helder | I2B4009018FA | stuk | 1014,75 | 284 1 |
| 0990950 | 90x185cm | (40) m. KermiClean | matzilver/helder | I2B40090181P | stuk | 1173,48 | 284 1 |
| 0990951 | 90x185cm | (40) m. KermiClean | wit/helder | I2B40090182P | stuk | 1282,13 | 284 1 |
| 0990952 | 90x185cm | (40) m. KermiClean | pergamon/helder | I2B4009018FP | stuk | 1282,13 | 284 1 |
| 0990917 | 90x185cm | -45 | matzilver/helder | I2B45090181A | stuk | 906,10 | 284 1 |
| 0990918 | 90x185cm | -45 | wit/helder | I2B45090182A | stuk | 1014,75 | 284 1 |
| 0990919 | 90x185cm | -45 | pergamon/helder | I2B4509018FA | stuk | 1014,75 | 284 1 |
| 0990953 | 90x185cm | (45) m. KermiClean | matzilver/helder | I2B45090181P | stuk | 1173,48 | 284 1 |
| 0990954 | 90x185cm | (45) m. KermiClean | wit/helder | I2B45090182P | stuk | 1282,13 | 284 1 |
| 0990955 | 90x185cm | (45) m. KermiClean | pergamon/helder | I2B4509018FP | stuk | 1282,13 | 284 1 |
| 0991038 | 90x185cm | -53 | matzilver/helder | I2B53090181A | stuk | 906,10 | 284 1 |
| 0991040 | 90x185cm | -53 | wit/helder | I2B53090182A | stuk | 1014,75 | 284 1 |
| 0991042 | 90x185cm | -53 | pergamon/helder | I2B5309018FA | stuk | 1014,75 | 284 1 |
| 0991039 | 90x185cm | (53) m. KermiClean | matzilver/helder | I2B53090181P | stuk | 1173,48 | 284 1 |
| 0991041 | 90x185cm | (53) m. KermiClean | wit/helder | I2B53090182P | stuk | 1282,13 | 284 1 |
| 0991043 | 90x185cm | (53) m. KermiClean | pergamon/helder | I2B5309018FP | stuk | 1282,13 | 284 1 |

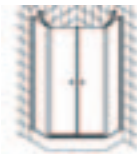

Douchewanden

Toebehoren &
afvoerenSpoel- &
installatiesystemenBadkamermeubelen
en toiletkasten

Kermi Ibiza 2000 accessoires

| | | | | | | |
|---------|--|-----------|---------------|------|--------|-------|
| 1040480 | verbredingsprofiel draaideur m. bovenprof. 185cm | matzilver | ZDSVSVKI21851 | stuk | 45,25 | 284 1 |
| 1040464 | verbredingsprofiel draaideur m. bovenprof. 185cm | wit | ZDSVSVKI21852 | stuk | 58,50 | 284 1 |
| 1040472 | verbredingsprofiel draaideur m. bovenprof. 185cm | pergamon | ZDSVSVKI2185F | stuk | 58,50 | 284 1 |
| 1040510 | verbredingsprof. pendeldeur PTD 185cm | matzilver | ZDSVSVPI21851 | stuk | 45,25 | 284 1 |
| 1040499 | verbredingsprof. pendeldeur PTD 185cm | wit | ZDSVSVPI21852 | stuk | 58,50 | 284 1 |
| 1040502 | verbredingsprof. pendeldeur PTD 185cm | pergamon | ZDSVSVPI2185F | stuk | 58,50 | 284 1 |
| 1040545 | verbredingsprof. schuifdeur STD 185cm | matzilver | ZDSVSVSI21851 | stuk | 95,50 | 284 1 |
| 1040529 | verbredingsprof. schuifdeur STD 185cm | wit | ZDSVSVSI21852 | stuk | 125,00 | 284 1 |
| 1040537 | verbredingsprof. schuifdeur STD 185cm | pergamon | ZDSVSVSI2185F | stuk | 125,00 | 284 1 |
| 1040049 | combinatieprof. schuifdeur en zijwand 185cm | matzilver | ZDKPKSFI21851 | stuk | 58,50 | 284 1 |
| 1040057 | combinatieprof. schuifdeur en zijwand 185cm | wit | ZDKPKSFI21852 | stuk | 76,00 | 284 1 |
| 1040065 | combinatieprof. schuifdeur en zijwand 185cm | pergamon | ZDKPKSFI2185F | stuk | 76,00 | 284 1 |
| 1040073 | combinatieprof. hoekinstap 185cm | matzilver | ZDKPKEFI21851 | stuk | 58,50 | 284 1 |
| 1040081 | combinatieprof. hoekinstap 185cm | wit | ZDKPKEFI21852 | stuk | 76,00 | 284 1 |
| 1040103 | combinatieprof. hoekinstap 185cm | pergamon | ZDKPKEFI2185F | stuk | 76,00 | 284 1 |
| 1040111 | combinatieprof. 2 zijwanden haaks 185cm | matzilver | ZDKPKTWI21851 | stuk | 63,00 | 284 1 |
| 1040138 | combinatieprof. 2 zijwanden haaks 185cm | wit | ZDKPKTWI21852 | stuk | 81,00 | 284 1 |
| 1040146 | combinatieprof. 2 zijwanden haaks 185cm | pergamon | ZDKPKTWI2185F | stuk | 81,00 | 284 1 |
| 1040154 | combinatieprof. 2 zijwanden in lijn 185cm | matzilver | ZDKPKTFI21851 | stuk | 44,25 | 284 1 |
| 1040162 | combinatieprof. 2 zijwanden in lijn 185cm | wit | ZDKPKTFI21852 | stuk | 57,50 | 284 1 |
| 1040170 | combinatieprof. 2 zijwanden in lijn 185cm | pergamon | ZDKPKTFI2185F | stuk | 57,50 | 284 1 |
| 1040219 | plafondsteun op zijwand incl. bevestiging | matzilver | ZDDSDSSI20001 | stuk | 195,00 | 284 1 |
| 1040227 | plafondsteun op zijwand incl. bevestiging | wit | ZDDSDSSI20002 | stuk | 255,00 | 284 1 |
| 1040235 | plafondsteun op zijwand incl. bevestiging | pergamon | ZDDSDSSI2000F | stuk | 255,00 | 284 1 |
| 1040286 | Multimax versterkingsstang muur-zijwand 70cm | matzilver | ZDMMWTFI20701 | stuk | 104,00 | 284 0 |
| 1040294 | Multimax versterkingsstang muur-zijwand 70cm | wit | ZDMMWTFI20702 | stuk | 136,00 | 284 1 |
| 1040308 | Multimax versterkingsstang muur-zijwand 70cm | pergamon | ZDMMWTFI2070F | stuk | 136,00 | 284 1 |
| 1040316 | Multimax versterkingsstang zijwand-zijwand 70cm | matzilver | ZDMMTTFI20701 | stuk | 108,00 | 284 1 |
| 1040324 | Multimax versterkingsstang zijwand-zijwand 70cm | wit | ZDMMTTFI20702 | stuk | 141,00 | 284 1 |

Gootstenen en
wastroggen

Utiliteit

| Art.nr | Specificaties | Kleur | Lev.nr | Ehd | Prijs | Grp | CC |
|--------|---------------|-------|--------|-----|-------|-----|----|
|--------|---------------|-------|--------|-----|-------|-----|----|

Kermi Ibiza 2000 accessoires

| | | | | | | | |
|---------|--|-----------|----------------|------|--------|-----|---|
| 1040332 | Multimax verstevigingsstang zijwand-zijwand 70cm | pergamon | ZDMMTTFI2070F | stuk | 141,00 | 284 | 1 |
| 1040340 | muurbevestiging voor STW + TWD | matzilver | ZDVSSI001 | stuk | 42,25 | 284 | 0 |
| 1040359 | muurbevestiging voor STW + TWD | wit | ZDVSSI002 | stuk | 54,50 | 284 | 0 |
| 1040367 | muurbevestiging voor STW + TWD | pergamon | ZDVSSI00F | stuk | 54,50 | 284 | 1 |
| 0985084 | buisprofiel 70cm | matzilver | ZDRRVR11210701 | stuk | 41,00 | 284 | 1 |
| 1040022 | greepset binnen/buiten compleet | wit | ZDGSGR0AT0002 | stuk | 46,25 | 284 | 1 |
| 1040030 | greepset binnen/buiten compleet | chrom | ZDGSGR0AT000Z | stuk | 55,50 | 284 | 1 |

Kermi Nova 2000

klapdeur

| | | | | | | | |
|---------|----------|------------------|--------------|------|--------|-----|---|
| 0984876 | 80x185cm | matzilv./fontana | N2PTD0801811 | stuk | 322,00 | 284 | 1 |
| 0984884 | 80x185cm | wit/fontana | N2PTD0801821 | stuk | 354,00 | 284 | 1 |
| 0984892 | 90x185cm | matzilv./fontana | N2PTD0901811 | stuk | 332,00 | 284 | 1 |
| 0984906 | 90x185cm | wit/fontana | N2PTD0901821 | stuk | 364,00 | 284 | 1 |

schuifdeur 3-delig

| | | | | | | | |
|---------|----------|------------------|--------------|------|--------|-----|---|
| 0987816 | 80x185cm | matzilv./fontana | N2STD0801811 | stuk | 311,00 | 284 | 1 |
| 0987824 | 80x185cm | wit/fontana | N2STD0801821 | stuk | 342,00 | 284 | 1 |
| 0984787 | 90x185cm | matzilv./fontana | N2STD0901811 | stuk | 321,00 | 284 | 0 |
| 0984795 | 90x185cm | wit/fontana | N2STD0901821 | stuk | 353,00 | 284 | 1 |

schuifdeur 2-delig voor hoekinstap

| | | | | | | | |
|---------|----------|------------------|--------------|------|--------|-----|---|
| 0987859 | 80x185cm | matzilv./fontana | N2ED20801811 | stuk | 240,00 | 284 | 1 |
| 0987867 | 80x185cm | wit/fontana | N2ED20801821 | stuk | 263,00 | 284 | 1 |
| 0984825 | 90x185cm | matzilv./fontana | N2ED20901811 | stuk | 248,00 | 284 | 0 |
| 0984833 | 90x185cm | wit/kerolan | N2ED20901821 | stuk | 272,00 | 284 | 1 |

zijwand

| | | | | | | | |
|---------|----------|------------------|--------------|------|--------|-----|---|
| 0987832 | 80x185cm | matzilv./fontana | N2TWD0801811 | stuk | 195,00 | 284 | 1 |
| 0987840 | 80x185cm | wit/fontana | N2TWD0801821 | stuk | 215,00 | 284 | 1 |
| 0984809 | 90x185cm | matzilv./fontana | N2TWD0901811 | stuk | 201,00 | 284 | 0 |
| 0984817 | 90x185cm | wit/fontana | N2TWD0901821 | stuk | 221,00 | 284 | 1 |

douchecabine hoekinstap 2-delig compleet m. schuifdeuren

| | | | | | | | |
|---------|----------|------------------|----------|------|--------|-----|---|
| 0987875 | 80x185cm | matzilv./fontana | NOVA2000 | stuk | 480,00 | 284 | 1 |
| 0987883 | 80x185cm | wit/fontana | NOVA2000 | stuk | 526,00 | 284 | 1 |
| 0985910 | 90x185cm | matzilv./fontana | NOVA2000 | stuk | 496,00 | 284 | 0 |
| 0985929 | 90x185cm | wit/fontana | NOVA2000 | stuk | 544,00 | 284 | 0 |

douchecabine kwartrond m. klapdeuren

| | | | | | | | |
|---------|----------|-------------|--------------|------|--------|-----|---|
| 0985643 | 90x185cm | wit/fontana | N2P530901821 | stuk | 812,00 | 284 | 1 |
|---------|----------|-------------|--------------|------|--------|-----|---|

douchecabine kwartrond m. schuifdeuren

| | | | | | | | |
|---------|----------|------------------|--------------|------|--------|-----|---|
| 0984841 | 90x185cm | matzilv./fontana | N2R530901811 | stuk | 741,00 | 284 | 1 |
| 0984868 | 90x185cm | wit/fontana | N2R530901821 | stuk | 815,00 | 284 | 1 |

douchecabine vijfhoekig m. klapdeuren

| | | | | | | | | |
|---------|----------|-----|------------------|--------------|------|--------|-----|---|
| 0984914 | 90x185cm | -40 | matzilv./fontana | N2F400901811 | stuk | 662,00 | 284 | 1 |
| 0985651 | 90x185cm | -40 | wit/fontana | N2F400901821 | stuk | 728,00 | 284 | 1 |
| 0985678 | 90x185cm | -45 | matzilv./fontana | N2F450901811 | stuk | 662,00 | 284 | 1 |
| 0985686 | 90x185cm | -45 | wit/fontana | N2F450901821 | stuk | 728,00 | 284 | 1 |
| 0985937 | 90x185cm | -53 | matzilv./fontana | N2F530901811 | stuk | 662,00 | 284 | 1 |
| 0985945 | 90x185cm | -53 | wit/fontana | N2F530901821 | stuk | 728,00 | 284 | 1 |

| Art.nr | Specificaties | Kleur | Lev.nr | Ehd | Prijs | Grp | CC |
|--------|---------------|-------|--------|-----|-------|-----|----|
|--------|---------------|-------|--------|-----|-------|-----|----|

Kermi Nova 2000

vouwdeur voor combinatie m. schuifdeur ED2

| | | | | | | | |
|---------|----------|------------------|--------------|------|--------|-----|---|
| 0979813 | 90x185cm | matzilv./fontana | N2EF20901811 | stuk | 365,00 | 284 | 1 |
| 0979821 | 90x185cm | wit/fontana | N2EF20901821 | stuk | 403,00 | 284 | 1 |

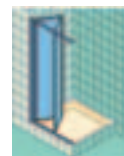

Sanitair producten

Baden /
douchebakken /
stoomcabines

Kermi Rialto XS

draaideur voor nis m. bovenprofiel

| | | | | | | | |
|---------|----------|-----------------------------------|--------------|------|---------|-----|---|
| 0989584 | 80x185cm | gl.zilver/helder | RXSTO08018VA | stuk | 980,00 | 284 | 1 |
| 0998095 | 80x185cm | wit/helder | RXSTO080182A | stuk | 860,00 | 284 | 1 |
| 0998109 | 80x185cm | perg./helder | RXSTO08018FA | stuk | 860,00 | 284 | 1 |
| 0972339 | 80x185cm | m. KermiClean gl.zilver/helder | RXSTO08018VP | stuk | 1133,00 | 284 | 1 |
| 0972312 | 80x185cm | m. KermiClean wit/helder glas | RXSTO080182P | stuk | 1013,00 | 284 | 1 |
| 0972320 | 80x185cm | m. KermiClean perg./helder | RXSTO08018FP | stuk | 1013,00 | 284 | 1 |
| 0996890 | 80x200cm | gl.zilver/helder | RXSTO08020VA | stuk | 1107,00 | 284 | 1 |
| 0996904 | 80x200cm | wit/helder | RXSTO080202A | stuk | 988,00 | 284 | 1 |
| 0996912 | 80x200cm | perg./helder | RXSTO08020FA | stuk | 988,00 | 284 | 1 |
| 0972363 | 80x200cm | m. KermiClean gl.zilver/helder | RXSTO08020VP | stuk | 1260,00 | 284 | 1 |
| 0972347 | 80x200cm | m. KermiClean wit/helder glas | RXSTO080202P | stuk | 1140,00 | 284 | 1 |
| 0972355 | 80x200cm | m. KermiClean perg./helder | RXSTO08020FP | stuk | 1140,00 | 284 | 1 |
| 0989126 | 90x185cm | gl.zilver/helder | RXSTD09018VA | stuk | 1003,00 | 284 | 1 |
| 0989134 | 90x185cm | wit/helder | RXSTO090182A | stuk | 883,00 | 284 | 1 |
| 0989142 | 90x185cm | perg./helder | RXSTO09018FA | stuk | 883,00 | 284 | 1 |
| 0972401 | 90x185cm | m. KermiClean gl.zilver/helder | RXSTO09018VP | stuk | 1156,00 | 284 | 1 |
| 0972371 | 90x185cm | m. KermiClean wit/helder glas | RXSTO090182P | stuk | 1036,00 | 284 | 1 |
| 0972398 | 90x185cm | m. KermiClean perg./helder | RXSTO09018FP | stuk | 1036,00 | 284 | 1 |
| 0998117 | 90x200cm | gl.zilver/helder | RXSTO09020VA | stuk | 1135,00 | 284 | 1 |
| 0989452 | 90x200cm | wit/helder | RXSTO090202A | stuk | 1016,00 | 284 | 1 |
| 0996858 | 90x200cm | perg./helder | RXSTO09020FA | stuk | 1016,00 | 284 | 1 |
| 0972444 | 90x200cm | m. KermiClean gl.zilver/helder | RXSTO09020VP | stuk | 1288,00 | 284 | 1 |
| 0972428 | 90x200cm | m. KermiClean wit/helder glas | RXSTO090202P | stuk | 1169,00 | 284 | 1 |
| 0972436 | 90x200cm | m. KermiClean perg./helder | RXSTO09020FP | stuk | 1169,00 | 284 | 1 |



Kranen

Douchegarnituur

Accessoires en
spiegels

Douchewanden

Toebehoren &
afvoerenSpoel- &
installatiesystemenBadkamermeubelen
en toiletkastenGootstenen en
wastroggen

Utiliteit

draaideur voor nis z. bovenprofiel

| | | | | | | | |
|---------|----------|-----------------------------------|--------------|------|---------|-----|---|
| 0996866 | 80x185cm | gl.zilver/helder | RXSTO08018VA | stuk | 980,00 | 284 | 1 |
| 0996874 | 80x185cm | wit/helder | RXSTO080182A | stuk | 860,00 | 284 | 1 |
| 0996882 | 80x185cm | perg./helder | RXSTO08018FA | stuk | 860,00 | 284 | 1 |
| 0972924 | 80x185cm | m. KermiClean gl.zilver/helder | RXSTO08018VP | stuk | 1133,00 | 284 | 1 |
| 0972908 | 80x185cm | m. KermiClean wit/helder glas | RXSTO080182P | stuk | 1013,00 | 284 | 1 |
| 0972916 | 80x185cm | m. KermiClean perg./helder | RXSTO08018FP | stuk | 1013,00 | 284 | 1 |
| 0996920 | 80x200cm | gl.zilver/helder | RXSTO08020VA | stuk | 1107,00 | 284 | 1 |
| 0996939 | 80x200cm | wit/helder | RXSTO080202A | stuk | 988,00 | 284 | 1 |
| 0996947 | 80x200cm | perg./helder | RXSTO08020FA | stuk | 988,00 | 284 | 1 |
| 0972959 | 80x200cm | m. KermiClean gl.zilver/helder | RXSTO08020VP | stuk | 1260,00 | 284 | 1 |
| 0972932 | 80x200cm | m. KermiClean wit/helder glas | RXSTO080202P | stuk | 1140,00 | 284 | 1 |
| 0972940 | 80x200cm | m. KermiClean perg./helder | RXSTO08020FP | stuk | 1140,00 | 284 | 1 |
| 0989150 | 90x185cm | gl.zilver/helder | RXSTO09018VA | stuk | 1003,00 | 284 | 1 |
| 0989169 | 90x185cm | wit/helder | RXSTO090182A | stuk | 883,00 | 284 | 1 |
| 0989177 | 90x185cm | perg./helder | RXSTO09018FA | stuk | 883,00 | 284 | 1 |
| 0973041 | 90x185cm | m. KermiClean gl.zilver/helder | RXSTO09018VP | stuk | 1156,00 | 284 | 1 |
| 0973025 | 90x185cm | m. KermiClean wit/helder glas | RXSTO090182P | stuk | 1036,00 | 284 | 1 |
| 0973033 | 90x185cm | m. KermiClean perg./helder | RXSTO09018FP | stuk | 1036,00 | 284 | 1 |
| 0996955 | 90x200cm | gl.zilver/helder | RXSTO09020VA | stuk | 1135,00 | 284 | 1 |
| 0996963 | 90x200cm | wit/helder | RXSTO090202A | stuk | 1016,00 | 284 | 1 |
| 0996971 | 90x200cm | perg./helder | RXSTO09020FA | stuk | 1016,00 | 284 | 1 |
| 0972983 | 90x200cm | m. KermiClean gl.zilver/helder | RXSTO09020VP | stuk | 1288,00 | 284 | 1 |
| 0972967 | 90x200cm | m. KermiClean wit/helder glas | RXSTO090202P | stuk | 1169,00 | 284 | 1 |
| 0972975 | 90x200cm | m. KermiClean perg./helder | RXSTO09020FP | stuk | 1169,00 | 284 | 1 |

klapdeur voor nis z. bovenprofiel

| | | | | | | | |
|---------|----------|-----------------------------------|--------------|------|---------|-----|---|
| 0997013 | 80x185cm | gl.zilver/helder | RXPTD08018VA | stuk | 1135,00 | 284 | 1 |
| 0997021 | 80x185cm | wit/helder | RXPTD080182A | stuk | 1015,00 | 284 | 1 |
| 0997048 | 80x185cm | perg./helder | RXPTD08018FA | stuk | 1015,00 | 284 | 1 |
| 0972894 | 80x185cm | m. KermiClean gl.zilver/helder | RXPTD08018VP | stuk | 1288,00 | 284 | 1 |
| 0972851 | 80x185cm | m. KermiClean wit/helder glas | RXPTD080182P | stuk | 1168,00 | 284 | 1 |
| 0972886 | 80x185cm | m. KermiClean perg./helder | RXPTD08018FP | stuk | 1168,00 | 284 | 1 |



| | Art.nr | Specificaties | Kleur | Lev.nr | Ehd | Prijs | Grp | CC |
|---|---|------------------------|------------------|--------------|---------|---------|-----|----|
| Kermi Rialto XS | | | | | | | | |
| klapdeur voor nis m. bovenprofiel | | | | | | | | |
| Sanitair producten | 0989622 | 80x185cm | gl.zilver/helder | RXPTD08018VA | stuk | 1135,00 | 284 | 1 |
| | 0996998 | 80x185cm | wit/helder | RXPTD080182A | stuk | 1015,00 | 284 | 1 |
| | 0997005 | 80x185cm | perg./helder | RXPTD08018FA | stuk | 1015,00 | 284 | 1 |
| Baden / douchebakken / stoomcabines | 0971995 | 80x185cm m. KermiClean | gl.zilver/helder | RXPTD08018VP | stuk | 1288,00 | 284 | 1 |
| | 0971979 | 80x185cm m. KermiClean | wit/helder glas | RXPTD080182P | stuk | 1168,00 | 284 | 1 |
| | 0971987 | 80x185cm m. KermiClean | perg./helder | RXPTD08018FP | stuk | 1168,00 | 284 | 1 |
| klapdeur voor nis z. bovenprofiel | | | | | | | | |
| Kranen | 0989312 | 90x185cm | gl.zilver/helder | RXPTD09018VA | stuk | 1163,00 | 284 | 1 |
| | 0989320 | 90x185cm | wit/helder | RXPTD090182A | stuk | 1043,00 | 284 | 1 |
| | 0989339 | 90x185cm | perg./helder | RXPTD09018FA | stuk | 1043,00 | 284 | 1 |
| | 0973017 | 90x185cm m. KermiClean | gl.zilver/helder | RXPTD09018VP | stuk | 1316,00 | 284 | 1 |
| | 0972991 | 90x185cm m. KermiClean | wit/helder glas | RXPTD090182P | stuk | 1196,00 | 284 | 1 |
| Douchegarnituur | 0973009 | 90x185cm m. KermiClean | perg./helder | RXPTD09018FP | stuk | 1196,00 | 284 | 1 |
| | klapdeur voor nis m. bovenprofiel | | | | | | | |
| Accessoires en spiegels | 0989282 | 90x185cm | gl.zilver/helder | RXPTD09018VA | stuk | 1163,00 | 284 | 1 |
| | 0989290 | 90x185cm | wit/helder | RXPTD090182A | stuk | 1043,00 | 284 | 1 |
| | 0989304 | 90x185cm | perg./helder | RXPTD09018FA | stuk | 1043,00 | 284 | 1 |
| | 0972029 | 90x185cm m. KermiClean | gl.zilver/helder | RXPTD09018VP | stuk | 1316,00 | 284 | 1 |
| | 0972002 | 90x185cm m. KermiClean | wit/helder glas | RXPTD090182P | stuk | 1196,00 | 284 | 1 |
| 0972010 | 90x185cm m. KermiClean | perg./helder | RXPTD09018FP | stuk | 1196,00 | 284 | 1 | |
| | draaideur voor zijwand | | | | | | | |
| Douchewanden | 0989517 | 80x185cm | gl.zilver/helder | RXSTW08018VA | stuk | 980,00 | 284 | 1 |
| | 0997056 | 80x185cm | wit/helder | RXSTW080182A | stuk | 860,00 | 284 | 1 |
| | 0997064 | 80x185cm | perg./helder | RXSTW08018FA | stuk | 860,00 | 284 | 1 |
| | 0972479 | 80x185cm m. KermiClean | gl.zilver/helder | RXSTW08018VP | stuk | 1133,00 | 284 | 1 |
| | 0972452 | 80x185cm m. KermiClean | wit/helder glas | RXSTW080182P | stuk | 1013,00 | 284 | 1 |
| | 0972460 | 80x185cm m. KermiClean | perg./helder | RXSTW08018FP | stuk | 1013,00 | 284 | 1 |
| | 0989185 | 90x185cm | gl.zilver/helder | RXSTW09018VA | stuk | 1003,00 | 284 | 1 |
| | 0989193 | 90x185cm | wit/helder | RXSTW090182A | stuk | 883,00 | 284 | 1 |
| | 0989207 | 90x185cm | perg./helder | RXSTW09018FA | stuk | 883,00 | 284 | 1 |
| | 0972517 | 90x185cm m. KermiClean | gl.zilver/helder | RXSTW09018VP | stuk | 1156,00 | 284 | 1 |
| Spool- & installatiesystemen | 0972487 | 90x185cm m. KermiClean | wit/helder glas | RXSTW090182P | stuk | 1036,00 | 284 | 1 |
| | 0972509 | 90x185cm m. KermiClean | perg./helder | RXSTW09018FP | stuk | 1036,00 | 284 | 1 |
| zijwand gedeeld wegklapbaar voor draaideur | | | | | | | | |
| Badkamermeubelen en toiletkasten | 0997072 | 80x185cm | gl.zilver/helder | RXTGD08018VA | stuk | 980,00 | 284 | 1 |
| | 0997080 | 80x185cm | wit/helder | RXTGD080182A | stuk | 860,00 | 284 | 1 |
| | 0997099 | 80x185cm | perg./helder | RXTGD08018FA | stuk | 860,00 | 284 | 1 |
| | 0972614 | 80x185cm m. KermiClean | gl.zilver/helder | RXTGD08018VP | stuk | 1133,00 | 284 | 1 |
| | 0972592 | 80x185cm m. KermiClean | wit/helder glas | RXTGD080182P | stuk | 1013,00 | 284 | 1 |
| Gootstenen en wastroggen | 0972606 | 80x185cm m. KermiClean | perg./helder | RXTGD08018FP | stuk | 1013,00 | 284 | 1 |
| | 0989533 | 90x185cm | gl.zilver/helder | RXTGD09018VA | stuk | 1003,00 | 284 | 1 |
| | 0993034 | 90x185cm | wit/helder | RXTGD090182A | stuk | 883,00 | 284 | 1 |
| Utiliteit | 0993042 | 90x185cm | perg./helder | RXTGD09018FA | stuk | 883,00 | 284 | 1 |
| | 0972649 | 90x185cm m. KermiClean | gl.zilver/helder | RXTGD09018VP | stuk | 1156,00 | 284 | 1 |
| | 0972622 | 90x185cm m. KermiClean | wit/helder glas | RXTGD090182P | stuk | 1036,00 | 284 | 1 |
| | 0972630 | 90x185cm m. KermiClean | perg./helder | RXTGD09018FP | stuk | 1036,00 | 284 | 1 |
| | zijwand wegklapbaar voor draaideur | | | | | | | |
|  | 0997102 | 80x185cm | gl.zilver/helder | RXTBD08018VA | stuk | 860,00 | 284 | 1 |
| | 0989541 | 80x185cm | wit/helder | RXTBD080182A | stuk | 741,00 | 284 | 1 |
| | 0997110 | 80x185cm | perg./helder | RXTBD08018FA | stuk | 741,00 | 284 | 1 |
| | 0972541 | 80x185cm m. KermiClean | gl.zilver/helder | RXTBD08018VP | stuk | 1013,00 | 284 | 1 |
| | 0972525 | 80x185cm m. KermiClean | wit/helder glas | RXTBD080182P | stuk | 893,00 | 284 | 1 |
| | 0972533 | 80x185cm m. KermiClean | perg./helder | RXTBD08018FP | stuk | 893,00 | 284 | 1 |
| | 0989258 | 90x185cm | gl.zilver/helder | RXTBD09018VA | stuk | 883,00 | 284 | 1 |
| | 0989266 | 90x185cm | wit/helder | RXTBD090182A | stuk | 763,00 | 284 | 1 |
| | 0989274 | 90x185cm | perg./helder | RXTBD09018FA | stuk | 763,00 | 284 | 1 |
| | 0972584 | 90x185cm m. KermiClean | gl.zilver/helder | RXTBD09018VP | stuk | 1036,00 | 284 | 1 |
| | 0972568 | 90x185cm m. KermiClean | wit/helder glas | RXTBD090182P | stuk | 916,00 | 284 | 1 |
| | 0972576 | 90x185cm m. KermiClean | perg./helder | RXTBD09018FP | stuk | 916,00 | 284 | 1 |

| Art.nr | Specificaties | Kleur | Lev.nr | Ehd | Prijs | Grp | CC |
|---|---------------|----------------------|------------------|---------------|-------|---------|-------|
| Kermi Rialto XS | | | | | | | |
| zijwand verkort wegklapbaar voor draaideur | | | | | | | |
| 0989525 | 80x172.5cm | rechts | gl.zilver/helder | RXTVR08017VA | stuk | 703,00 | 284 1 |
| 0997129 | 80x172.5cm | rechts | wit/helder | RXTVR080172A | stuk | 583,00 | 284 1 |
| 0997137 | 80x172.5cm | rechts | perg./helder | RXTVR08017FA | stuk | 583,00 | 284 1 |
| 0972754 | 80x172.5cm | rechts m. KermiClean | gl.zilver/helder | RXTVR08017VP | stuk | 855,00 | 284 1 |
| 0972738 | 80x172.5cm | rechts m. KermiClean | wit/helder glas | RXTVR080172P | stuk | 735,00 | 284 1 |
| 0972746 | 80x172.5cm | rechts m. KermiClean | perg./helder | RXTVR08017FP | stuk | 735,00 | 284 1 |
| 0997145 | 80x172.5cm | links | gl.zilver/helder | RXTVL08017VA | stuk | 703,00 | 284 1 |
| 0997153 | 80x172.5cm | links | wit/helder | RXTVL080172A | stuk | 583,00 | 284 1 |
| 0997161 | 80x172.5cm | links | perg./helder | RXTVL08017FA | stuk | 583,00 | 284 1 |
| 0972673 | 80x172.5cm | links m. KermiClean | gl.zilver/helder | RXTVL08017VP | stuk | 855,00 | 284 1 |
| 0972657 | 80x172.5cm | links m. KermiClean | wit/helder glas | RXTVL080172P | stuk | 735,00 | 284 1 |
| 0972665 | 80x172.5cm | links m. KermiClean | perg./helder | RXTVL08017FP | stuk | 735,00 | 284 1 |
| 0997188 | 90x172.5cm | rechts | gl.zilver/helder | RXTVR09017VA | stuk | 723,00 | 284 1 |
| 0997196 | 90x172.5cm | rechts | wit/helder | RXTVR090172VA | stuk | 603,00 | 284 1 |
| 0997218 | 90x172.5cm | rechts | perg./helder | RXTVR09017FA | stuk | 603,00 | 284 1 |
| 0972789 | 90x172.5cm | rechts m. KermiClean | gl.zilver/helder | RXTVR09017VP | stuk | 876,00 | 284 1 |
| 0972762 | 90x172.5cm | rechts m. KermiClean | wit/helder glas | RXTVR090172P | stuk | 756,00 | 284 1 |
| 0972770 | 90x172.5cm | rechts m. KermiClean | perg./helder | RXTVR09017FP | stuk | 756,00 | 284 1 |
| 0997226 | 90x172.5cm | links | gl.zilver/helder | RXTVL09017VA | stuk | 723,00 | 284 1 |
| 0997234 | 90x172.5cm | links | wit/helder | RXTVL090172A | stuk | 603,00 | 284 1 |
| 0997242 | 90x172.5cm | links | perg./helder | RXTVL09017FA | stuk | 603,00 | 284 1 |
| 0972711 | 90x172.5cm | links m. KermiClean | gl.zilver/helder | RXTVL09017VP | stuk | 876,00 | 284 1 |
| 0972681 | 90x172.5cm | links m. KermiClean | wit/helder glas | RXTVL090172P | stuk | 756,00 | 284 1 |
| 0972703 | 90x172.5cm | links m. KermiClean | perg./helder | RXTVL09017FP | stuk | 756,00 | 284 1 |
| zijwand voor draaideur | | | | | | | |
| 0997250 | 80x185cm | | gl.zilver/helder | RXTWD08018VA | stuk | 703,00 | 284 1 |
| 0997269 | 80x185cm | | wit/helder | RXTWD080182A | stuk | 583,00 | 284 1 |
| 0997277 | 80x185cm | | perg./helder | RXTWD08018FA | stuk | 583,00 | 284 1 |
| 0972819 | 80x185cm | m. KermiClean | gl.zilver/helder | RXTWD08018VP | stuk | 855,00 | 284 1 |
| 0972797 | 80x185cm | m. KermiClean | wit/helder glas | RXTWD080182P | stuk | 735,00 | 284 1 |
| 0972800 | 80x185cm | m. KermiClean | perg./helder | RXTWD08018FP | stuk | 735,00 | 284 1 |
| 0989215 | 90x185cm | | gl.zilver/helder | RXTWD09018VA | stuk | 723,00 | 284 1 |
| 0989223 | 90x185cm | | wit/helder | RXTWD090182A | stuk | 603,00 | 284 1 |
| 0989231 | 90x185cm | | perg./helder | RXTWD09018FA | stuk | 603,00 | 284 1 |
| 0972843 | 90x185cm | m. KermiClean | gl.zilver/helder | RXTWD09018VP | stuk | 876,00 | 284 1 |
| 0972827 | 90x185cm | m. KermiClean | wit/helder glas | RXTWD090182P | stuk | 756,00 | 284 1 |
| 0972835 | 90x185cm | m. KermiClean | perg./helder | RXTWD09018FP | stuk | 756,00 | 284 1 |
| klapdeur voor zijwand | | | | | | | |
| 0989630 | 80x185cm | rechts | gl.zilver/helder | RXPTR08018VA | stuk | 1135,00 | 284 1 |
| 0997285 | 80x185cm | rechts | wit/helder | RXPTR080182A | stuk | 1015,00 | 284 1 |
| 0997293 | 80x185cm | rechts | perg./helder | RXPTR08018FA | stuk | 1015,00 | 284 1 |
| 0972118 | 80x185cm | rechts m. KermiClean | gl.zilver/helder | RXPTR08018VP | stuk | 1288,00 | 284 1 |
| 0972088 | 80x185cm | rechts m. KermiClean | wit/helder glas | RXPTR080182P | stuk | 1168,00 | 284 1 |
| 0972096 | 80x185cm | rechts m. KermiClean | perg./helder | RXPTR08018FP | stuk | 1168,00 | 284 1 |
| 0989347 | 90x185cm | rechts | gl.zilver/helder | RXPTR09018VA | stuk | 1163,00 | 284 1 |
| 0989355 | 90x185cm | rechts | wit/helder | RXPTR090182A | stuk | 1043,00 | 284 1 |
| 0989363 | 90x185cm | rechts | perg./helder | RXPTR09018FA | stuk | 1043,00 | 284 1 |
| 0972142 | 90x185cm | rechts m. KermiClean | gl.zilver/helder | RXPTR09018VP | stuk | 1316,00 | 284 1 |
| 0972126 | 90x185cm | rechts m. KermiClean | wit/helder glas | RXPTR090182P | stuk | 1196,00 | 284 1 |
| 0972134 | 90x185cm | rechts m. KermiClean | perg./helder | RXPTR09018FP | stuk | 1196,00 | 284 1 |
| 0996777 | 80x185cm | links | gl.zilver/helder | RXPTL08018VA | stuk | 1135,00 | 284 1 |
| 0972037 | 80x185cm | links m. KermiClean | gl.zilver/helder | RXPTL08018VP | stuk | 1288,00 | 284 1 |
| 0996785 | 90x185cm | links | gl.zilver/helder | RXPTL09018VA | stuk | 1163,00 | 284 1 |
| 0996793 | 90x185cm | links | wit/helder | RXPTL090182A | stuk | 1043,00 | 284 1 |
| 0996807 | 90x185cm | links | perg./helder | RXPTL09018FA | stuk | 1043,00 | 284 1 |
| 0972061 | 90x185cm | links m. KermiClean | gl.zilver/helder | RXPTL09018VP | stuk | 1316,00 | 284 1 |
| 0972045 | 90x185cm | links m. KermiClean | wit/helder glas | RXPTL090182P | stuk | 1196,00 | 284 1 |
| 0972053 | 90x185cm | links m. KermiClean | perg./helder | RXPTL09018FP | stuk | 1196,00 | 284 1 |



Sanitair producten

Baden /
douchebakken /
stoomcabines

Kranen

Douchegarnituur

Accessoires en
spiegels

Douchewanden

Toebehoren &
afvoerenSpoel- &
installatiesystemenBadkamermeubelen
en toiletkastenGootstenen en
wastroggen

Utiliteit

| Art.nr | Specificaties | Kleur | Lev.nr | Ehd | Prijs | Grp | CC | |
|--|------------------------------|---------------|------------------|------------------|--------------|---------|---------|-------|
| Kermi Rialto XS | | | | | | | | |
| zijwand gedeeld wegklapbaar voor klapdeur | | | | | | | | |
| Sanitair producten | 0997307 | 80x185cm | gl.zilver/helder | RXPGD08018VA | stuk | 980,00 | 284 1 | |
| | 0997315 | 80x185cm | wit/helder | RXPGD080182A | stuk | 860,00 | 284 1 | |
| | 0997323 | 80x185cm | perg./helder | RXPGD08018FA | stuk | 860,00 | 284 1 | |
| Baden / douchebakken / stoomcabines | 0971936 | 80x185cm | m. KermiClean | gl.zilver/helder | RXPGD08018VP | stuk | 1133,00 | 284 1 |
| | 0971901 | 80x185cm | m. KermiClean | wit/helder glas | RXPGD080182P | stuk | 1013,00 | 284 1 |
| | 0971928 | 80x185cm | m. KermiClean | perg./helder | RXPGD08018FP | stuk | 1013,00 | 284 1 |
| | 0989614 | 90x185cm | | gl.zilver/helder | RXPGD09018VA | stuk | 1003,00 | 284 1 |
| | 0992992 | 90x185cm | | wit/helder | RXPGD090182A | stuk | 883,00 | 284 1 |
| Kranen | 0993018 | 90x185cm | | perg./helder | RXPGD09018FA | stuk | 883,00 | 284 1 |
| | 0971960 | 90x185cm | m. KermiClean | gl.zilver/helder | RXPGD09018VP | stuk | 1156,00 | 284 1 |
| | 0971944 | 90x185cm | m. KermiClean | wit/helder glas | RXPGD090182P | stuk | 1036,00 | 284 1 |
| 0971952 | 90x185cm | m. KermiClean | perg./helder | RXPGD09018FP | stuk | 1036,00 | 284 1 | |
| zijwand wegklapbaar voor klapdeur | | | | | | | | |
| Douchegarnituur | 0997331 | 80x185cm | gl.zilver/helder | RXPBD08018VA | stuk | 860,00 | 284 1 | |
| | 0997358 | 80x185cm | wit/helder | RXPBD080182A | stuk | 741,00 | 284 1 | |
| | 0997366 | 80x185cm | perg./helder | RXPBD08018FA | stuk | 741,00 | 284 1 | |
| Accessoires en spiegels | 0971855 | 80x185cm | m. KermiClean | gl.zilver/helder | RXPBD08018VP | stuk | 1013,00 | 284 1 |
| | 0971839 | 80x185cm | m. KermiClean | wit/helder glas | RXPBD080182P | stuk | 893,00 | 284 1 |
| | 0971847 | 80x185cm | m. KermiClean | perg./helder | RXPBD08018FP | stuk | 893,00 | 284 1 |
| | 0989428 | 90x185cm | | gl.zilver/helder | RXPBD09018VA | stuk | 883,00 | 284 1 |
| | 0989436 | 90x185cm | | wit/helder | RXPBD090182A | stuk | 763,00 | 284 1 |
| Douchewanden | 0989444 | 90x185cm | | perg./helder | RXPBD09018FA | stuk | 763,00 | 284 1 |
| | 0971898 | 90x185cm | m. KermiClean | gl.zilver/helder | RXPBD09018VP | stuk | 1036,00 | 284 1 |
| | 0971863 | 90x185cm | m. KermiClean | wit/helder glas | RXPBD090182P | stuk | 916,00 | 284 1 |
| | 0971871 | 90x185cm | m. KermiClean | perg./helder | RXPBD09018FP | stuk | 916,00 | 284 1 |
| | zijwand voor klapdeur | | | | | | | |
| Toebehoren & afvoeren | 0989649 | 80x185cm | gl.zilver/helder | RXPWD08018VA | stuk | 703,00 | 284 1 | |
| | 0997374 | 80x185cm | wit/helder | RXPWD080182A | stuk | 583,00 | 284 1 | |
| | 0997382 | 80x185cm | perg./helder | RXPWD08018FA | stuk | 583,00 | 284 1 | |
| Spoel- & installatiesystemen | 0972177 | 80x185cm | m. KermiClean | gl.zilver/helder | RXPWD08018VP | stuk | 826,00 | 284 1 |
| | 0972150 | 80x185cm | m. KermiClean | wit/helder glas | RXPWD080182P | stuk | 706,00 | 284 1 |
| | 0972169 | 80x185cm | m. KermiClean | perg./helder | RXPWD08018FP | stuk | 706,00 | 284 1 |
| | 0989371 | 90x185cm | | gl.zilver/helder | RXPWD09018VA | stuk | 723,00 | 284 1 |
| | 0989398 | 90x185cm | | wit/helder | RXPWD090182A | stuk | 603,00 | 284 1 |
| Badkamermeubelen en toiletkasten | 0989401 | 90x185cm | | perg./helder | RXPWD09018FA | stuk | 603,00 | 284 1 |
| | 0972207 | 90x185cm | m. KermiClean | gl.zilver/helder | RXPWD09018VP | stuk | 846,00 | 284 1 |
| | 0972185 | 90x185cm | m. KermiClean | wit/helder glas | RXPWD090182P | stuk | 726,00 | 284 1 |
| 0972193 | 90x185cm | m. KermiClean | perg./helder | RXPWD09018FP | stuk | 726,00 | 284 1 | |
| Gootstenen en wastroggen | | | | | | | | |
| Utiliteit | | | | | | | | |

| Art.nr | Specificaties | Kleur | Lev.nr | Ehd | Prijs | Grp | CC |
|--|--------------------------------------|------------------|--------------|------|---------|-----|----|
| Kermi Rialto XS | | | | | | | |
| douchecabine vijfhoekig m. draaideur | | | | | | | |
| 0997412 | 90x185cm (40) rechts | gl.zilver/helder | RXR4009018VA | stuk | 1975,00 | 284 | 1 |
| 0993069 | 90x185cm (40) rechts | wit/helder | RXR40090182A | stuk | 1766,00 | 284 | 1 |
| 0993050 | 90x185cm (40) rechts | perg./helder | RXR4009018FA | stuk | 1766,00 | 284 | 1 |
| 0972231 | 90x185cm (40) rechts m. KermiClean | gl.zilver/helder | RXR4009018VP | stuk | 2247,00 | 284 | 1 |
| 0972215 | 90x185cm (40) rechts m. KermiClean | wit/helder glas | RXR40090182P | stuk | 2038,00 | 284 | 1 |
| 0972223 | 90x185cm (40) rechts m. KermiClean | perg./helder | RXR4009018FP | stuk | 2038,00 | 284 | 1 |
| 0993077 | 90x185cm (45) rechts | gl.zilver/helder | RXR4509018VA | stuk | 1975,00 | 284 | 1 |
| 0993085 | 90x185cm (45) rechts | wit/helder | RXR45090182A | stuk | 1766,00 | 284 | 1 |
| 0993093 | 90x185cm (45) rechts | perg./helder | RXR4509018FA | stuk | 1766,00 | 284 | 1 |
| 0972274 | 90x185cm (45) rechts m. KermiClean | gl.zilver/helder | RXR4509018VP | stuk | 2247,00 | 284 | 1 |
| 0972258 | 90x185cm (45) rechts m. KermiClean | wit/helder glas | RXR45090182P | stuk | 2038,00 | 284 | 1 |
| 0972266 | 90x185cm (45) rechts m. KermiClean | perg./helder | RXR4509018FP | stuk | 2038,00 | 284 | 1 |
| 0993107 | 100x185cm (50) rechts | gl.zilver/helder | RXR5010018VA | stuk | 2070,00 | 284 | 1 |
| 0993115 | 100x185cm (50) rechts | wit/helder | RXR50100182A | stuk | 1861,00 | 284 | 1 |
| 0993123 | 100x185cm (50) rechts | perg./helder | RXR5010018FA | stuk | 1861,00 | 284 | 1 |
| 0972304 | 100x185cm (50) rechts m. KermiClean | gl.zilver/helder | RXR5010018VP | stuk | 2343,00 | 284 | 1 |
| 0972282 | 100x185cm (50) rechts m. KermiClean | wit/helder glas | RXR50100182P | stuk | 2134,00 | 284 | 1 |
| 0972290 | 100x185cm (50) rechts m. KermiClean | perg./helder | RXR5010018FP | stuk | 2134,00 | 284 | 1 |
| 0989495 | 90x185cm (45) links | gl.zilver/helder | RXL4509018VA | stuk | 1975,00 | 284 | 1 |
| 0993131 | 90x185cm (45) links | wit/helder | RXL45090182A | stuk | 1766,00 | 284 | 1 |
| 0993158 | 90x185cm (45) links | perg./helder | RXL4509018FA | stuk | 1766,00 | 284 | 1 |
| 0971723 | 90x185cm (45) links m. KermiClean | gl.zilver/helder | RXL4509018VP | stuk | 2247,00 | 284 | 1 |
| 0971707 | 90x185cm (45) links m. KermiClean | wit/helder glas | RXL45090182P | stuk | 2038,00 | 284 | 1 |
| 0971715 | 90x185cm (45) links m. KermiClean | perg./helder | RXL4509018FP | stuk | 2038,00 | 284 | 1 |
| 0989509 | 90x185cm (53) links | gl.zilver/helder | RXL5309018VA | stuk | 1975,00 | 284 | 1 |
| 0997404 | 90x185cm (53) links | wit/helder | RXL53090182A | stuk | 1766,00 | 284 | 1 |
| 0997390 | 90x185cm (53) links | perg./helder | RXL5309018FA | stuk | 1766,00 | 284 | 1 |
| 0971790 | 90x185cm (53) links m. KermiClean | gl.zilver/helder | RXL5309018VP | stuk | 2247,00 | 284 | 1 |
| 0971774 | 90x185cm (53) links m. KermiClean | wit/helder glas | RXL53090182P | stuk | 2038,00 | 284 | 1 |
| 0971782 | 90x185cm (53) links m. KermiClean | perg./helder | RXL5309018FP | stuk | 2038,00 | 284 | 1 |
| 0993166 | 100x185cm (50) links | gl.zilver/helder | RXL5010018VA | stuk | 2070,00 | 284 | 1 |
| 0993174 | 100x185cm (50) links | wit/helder | RXL50100182A | stuk | 1861,00 | 284 | 1 |
| 0997420 | 100x185cm (50) links | perg./helder | RXL5010018FA | stuk | 1861,00 | 284 | 1 |
| 0971766 | 100x185cm (50) links m. KermiClean | gl.zilver/helder | RXL5010018VP | stuk | 2343,00 | 284 | 1 |
| 0971731 | 100x185cm (50) links m. KermiClean | wit/helder glas | RXL50100182P | stuk | 2134,00 | 284 | 1 |
| 0971758 | 100x185cm (50) links m. KermiClean | perg./helder | RXL5010018FP | stuk | 2134,00 | 284 | 1 |
| douchecabine vijfhoekig m. pendeldeuren | | | | | | | |
| 0989606 | 90x185cm (40) rechts | gl.zilver/helder | RX40R09018VA | stuk | 1975,00 | 284 | 1 |
| 0997439 | 90x185cm (40) rechts | wit/helder | RX40R090182A | stuk | 1766,00 | 284 | 1 |
| 0997447 | 90x185cm (40) rechts | perg./helder | RX40R09018FA | stuk | 1766,00 | 284 | 1 |
| 0971529 | 90x185cm (40) rechts m. KermiClean | gl.zilver/helder | RX40R09018VP | stuk | 2247,00 | 284 | 1 |
| 0971502 | 90x185cm (40) rechts m. KermiClean | wit/helder glas | RX40R090182P | stuk | 2038,00 | 284 | 1 |
| 0971510 | 90x185cm (40) rechts m. KermiClean | perg./helder | RX40R09018FP | stuk | 2038,00 | 284 | 1 |
| 0997455 | 90x185cm (45) rechts | gl.zilver/helder | RX45R09018VA | stuk | 1975,00 | 284 | 1 |
| 0997463 | 90x185cm (45) rechts | wit/helder | RX45R090182A | stuk | 1766,00 | 284 | 1 |
| 0997471 | 90x185cm (45) rechts | perg./helder | RX45R09018FA | stuk | 1766,00 | 284 | 1 |
| 0971596 | 90x185cm (45) rechts m. KermiClean | gl.zilver/helder | RX45R09018VP | stuk | 2247,00 | 284 | 1 |
| 0971561 | 90x185cm (45) rechts m. KermiClean | wit/helder glas | RX45R090182P | stuk | 2038,00 | 284 | 1 |
| 0971588 | 90x185cm (45) rechts m. KermiClean | perg./helder | RX45R09018FP | stuk | 2038,00 | 284 | 1 |
| 0989592 | 90x185cm (45) links | gl.zilver/helder | RX45L09018VA | stuk | 1975,00 | 284 | 1 |
| 0997536 | 90x185cm (45) links | wit/helder | RX45L090182A | stuk | 1766,00 | 284 | 1 |
| 0997544 | 90x185cm (45) links | perg./helder | RX45L09018FA | stuk | 1766,00 | 284 | 1 |
| 0971553 | 90x185cm (45) links m. KermiClean | gl.zilver/helder | RX45L09018VP | stuk | 2247,00 | 284 | 1 |
| 0971537 | 90x185cm (45) links m. KermiClean | wit/helder glas | RX45L090182P | stuk | 2038,00 | 284 | 1 |
| 0971545 | 90x185cm (45) links m. KermiClean | perg./helder | RX45L09018FP | stuk | 2038,00 | 284 | 1 |
| 0997579 | 100x185cm (53.7) links | gl.zilver/helder | RX53L10018VA | stuk | 2070,00 | 284 | 1 |
| 0989569 | 100x185cm (53.7) links | wit/helder | RX53L100182A | stuk | 1861,00 | 284 | 1 |
| 0997587 | 100x185cm (53.7) links | perg./helder | RX53L10018FA | stuk | 1861,00 | 284 | 1 |
| 0971693 | 100x185cm (53.7) links m. KermiClean | gl.zilver/helder | RX53L10018VP | stuk | 2343,00 | 284 | 1 |
| 0971677 | 100x185cm (53.7) links m. KermiClean | wit/helder glas | RX53L100182P | stuk | 2134,00 | 284 | 1 |
| 0971685 | 100x185cm (53.7) links m. KermiClean | perg./helder | RX53L10018FP | stuk | 2134,00 | 284 | 1 |
| douchecabine kwartrond m. klapdeuren | | | | | | | |
| 0989460 | 90x185cm | gl.zilver/helder | RXP2009018VA | stuk | 1924,00 | 284 | 1 |
| 0989568 | 90x185cm | wit/helder | RXP20090182A | stuk | 1714,00 | 284 | 1 |
| 0993182 | 90x185cm | perg./helder | RXP2009018FA | stuk | 1714,00 | 284 | 1 |
| 0971820 | 90x185cm m. KermiClean | gl.zilver/helder | RXP2009018VP | stuk | 2197,00 | 284 | 1 |
| 0971804 | 90x185cm m. KermiClean | wit/helder glas | RXP20090182P | stuk | 1987,00 | 284 | 1 |
| 0971812 | 90x185cm m. KermiClean | perg./helder | RXP2009018FP | stuk | 1987,00 | 284 | 1 |



Sanitair producten

Baden /
douchebakken /
stoomcabines

Kranen

Douchegarnituur

Accessoires en
spiegels

Douchewanden

Toebehoren &
afvoerenSpoel- &
installatiesystemenBadkamermeubelen
en toiletkastenGootstenen en
wastroggen

Utiliteit



| Art.nr | Specificaties | Kleur | Lev.nr | Ehd | Prijs | Grp | CC |
|--------|---------------|-------|--------|-----|-------|-----|----|
|--------|---------------|-------|--------|-----|-------|-----|----|

Kermi Rialto XS

Starck-3 douchecabine kwartrond m. pendeldeuren

| | | | | | | | | |
|---------|-----------|---------------|-------------------|--------------|------|---------|-----|---|
| 0985036 | 90x185cm | | zilver/helderglas | RXZ40090181A | stuk | 1493,00 | 284 | 1 |
| 0985042 | 90x185cm | | gl.zilver/helder | RXZ4009018VA | stuk | 1877,00 | 284 | 1 |
| 0985038 | 90x185cm | | wit/helder | RXZ40090182A | stuk | 1672,00 | 284 | 1 |
| 0985040 | 90x185cm | | pergamon/helder | RXZ4009018FA | stuk | 1672,00 | 284 | 1 |
| 0985037 | 90x185cm | m. KermiClean | zilver/helder | RXZ40090181P | stuk | 1759,00 | 284 | 1 |
| 0985039 | 90x185cm | m. KermiClean | wit/helder | RXZ40090182P | stuk | 1938,00 | 284 | 1 |
| 0985041 | 90x185cm | m. KermiClean | pergamon/helder | RXZ4009018FP | stuk | 1938,00 | 284 | 1 |
| 0985043 | 90x185cm | m. KermiClean | gl.zilver/helder | RXZ4009018VP | stuk | 2143,00 | 284 | 1 |
| 0985044 | 100x185cm | | zilver/helder | RXZ40100181A | stuk | 1572,00 | 284 | 1 |
| 0985050 | 100x185cm | | gl.zilver/helder | RXZ4010018VA | stuk | 1966,00 | 284 | 1 |
| 0985046 | 100x185cm | | wit/helder | RXZ40100182A | stuk | 1761,00 | 284 | 1 |
| 0985048 | 100x185cm | | pergamon/helder | RXZ4010018FA | stuk | 1761,00 | 284 | 1 |
| 0985045 | 100x185cm | m. KermiClean | zilver/helder | RXZ40100181P | stuk | 1838,00 | 284 | 1 |
| 0985047 | 100x185cm | m. KermiClean | wit/helder | RXZ40100182P | stuk | 2027,00 | 284 | 1 |
| 0985049 | 100x185cm | m. KermiClean | pergamon/helder | RXZ4010018FP | stuk | 2027,00 | 284 | 1 |
| 0985052 | 100x185cm | m. KermiClean | gl.zilver/helder | RXZ4010018VP | stuk | 2232,00 | 284 | 1 |

Kermi Rialto accessoires

| | | | | | | | | |
|---------|--|-------------|--|---------------|------|--------|-----|---|
| 1040375 | Multimax verstevigingsprof. vast:muur-zijw. 70cm | wit | | ZDMMWTFRX0702 | stuk | 136,00 | 284 | 1 |
| 1040383 | Multimax verstevigingsprof. vast:muur-zijw. 70cm | pergamon | | ZDMMWTFRX070F | stuk | 136,00 | 284 | 1 |
| 1040391 | Multimax verstevigingsprof. vast:muur-zijw. 70cm | glanszilver | | ZDMMWTFRX070Z | stuk | 211,00 | 284 | 1 |
| 1040006 | wandaansluitprofiel 45° | wit | | ZDWPPRORX1852 | stuk | 152,00 | 284 | 1 |
| 1040014 | wandaansluitprofiel 45° | pergamon | | ZDWPPRORX185F | stuk | 152,00 | 284 | 1 |
| 0989657 | doucherek voor zijwand 80cm | glanszilver | | ZDACAK1080RXV | stuk | 331,00 | 284 | 1 |
| 0989479 | doucherek voor zijwand 90cm | glanszilver | | ZDACAK1090RXV | stuk | 331,00 | 284 | 1 |

Kermi Siesta

nisdeur compleet

| | | | | | | | | |
|---------|----------|---------------|------------------|--------|------|---------|-----|---|
| 0988537 | 90x185cm | | gl.zilver/helder | SIESTA | stuk | 994,00 | 284 | 0 |
| 0979465 | 90x185cm | m. KermiClean | gl.zilver/helder | SIESTA | stuk | 1137,00 | 284 | 1 |
| 0979473 | 90x185cm | m. KermiClean | wit/helder glas | SIESTA | stuk | 1009,50 | 284 | 1 |

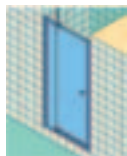

hoekinstap compleet

| | | | | | | | | |
|---------|----------|---------------|------------------|--------|------|---------|-----|---|
| 0988596 | 90x185cm | | gl.zilver/helder | SIESTA | stuk | 1602,00 | 284 | 0 |
| 0979481 | 90x185cm | m. KermiClean | gl.zilver/helder | SIESTA | stuk | 1888,00 | 284 | 1 |
| 0979503 | 90x185cm | m. KermiClean | wit/helder glas | SIESTA | stuk | 1696,00 | 284 | 1 |

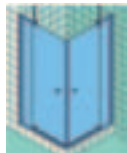

douchecabine kwartrond compleet

| | | | | | | | | |
|---------|----------|---------------|------------------|--------|------|---------|-----|---|
| 0988634 | 90x185cm | | gl.zilver/helder | SIESTA | stuk | 1764,50 | 284 | 0 |
| 0979511 | 90x185cm | m. KermiClean | gl.zilver/helder | SIESTA | stuk | 2020,50 | 284 | 1 |
| 0979562 | 90x185cm | m. KermiClean | wit/helder glas | SIESTA | stuk | 1796,50 | 284 | 1 |



douchecabine vijfhoekig compleet

| | | | | | | | | |
|---------|----------|--------------------|------------------|--------|------|---------|-----|---|
| 0988642 | 90x185cm | -40 | gl.zilver/helder | SIESTA | stuk | 1890,50 | 284 | 1 |
| 0979538 | 90x185cm | (40) m. KermiClean | gl.zilver/helder | SIESTA | stuk | 2146,50 | 284 | 1 |
| 0979570 | 90x185cm | (40) m. KermiClean | wit/helder glas | SIESTA | stuk | 1922,50 | 284 | 1 |
| 0988677 | 90x185cm | -45 | gl.zilver/helder | SIESTA | stuk | 1890,50 | 284 | 0 |
| 0979546 | 90x185cm | (45) m. KermiClean | gl.zilver/helder | SIESTA | stuk | 2146,50 | 284 | 1 |
| 0979589 | 90x185cm | (45) m. KermiClean | wit/helder glas | SIESTA | stuk | 1922,50 | 284 | 1 |
| 0988707 | 90x185cm | -53 | gl.zilver/helder | SIESTA | stuk | 1890,50 | 284 | 0 |
| 0979554 | 90x185cm | (53) m. KermiClean | gl.zilver/helder | SIESTA | stuk | 2146,50 | 284 | 1 |
| 0979597 | 90x185cm | (53) m. KermiClean | wit/helder glas | SIESTA | stuk | 1922,50 | 284 | 1 |

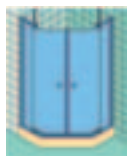

sluitprofiel voor draaideur 185cm

| | | | | | | | | |
|---------|--|-------------|--|--------------|------|--------|-----|---|
| 0970689 | | wit | | SIAT1000182X | stuk | 102,00 | 284 | 1 |
| 0988561 | | glanszilver | | SIAT100018VX | stuk | 120,00 | 284 | 0 |

vast element 185cm

| | | | | | | | | |
|---------|--|------------------|---------------|--------------|------|--------|-----|---|
| 0970670 | | wit/helder | | SIFF1025182A | stuk | 404,00 | 284 | 1 |
| 0988545 | | glanszilver | | SIFF102518VA | stuk | 500,00 | 284 | 0 |
| 0971421 | | wit/helder glas | m. KermiClean | SIFF1025182P | stuk | 445,00 | 284 | 1 |
| 0971448 | | gl.zilver/helder | m. KermiClean | SIFF102518VP | stuk | 541,00 | 284 | 1 |

| Art.nr | Specificaties | Kleur | Lev.nr | Ehd | Prijs | Grp | CC |
|----------------------------------|-------------------|-------------|---------------|------|--------|-----|----|
| Kermi Siesta | | | | | | | |
| onderprofiel vijfhoekig | | | | | | | |
| 0970638 | SF1 | wit | SISF1000002X | stuk | 59,50 | 284 | 1 |
| 0988723 | SF1 | glanszilver | SISF100000VX | stuk | 91,50 | 284 | 1 |
| 0970646 | SF3 | wit | SISF3000002X | stuk | 59,50 | 284 | 1 |
| 0988693 | SF3 | glanszilver | SISF300000VX | stuk | 91,50 | 284 | 1 |
| 0970654 | SF5 | wit | SISF5000002X | stuk | 59,50 | 284 | 1 |
| 0988669 | SF5 | glanszilver | SISF500000VX | stuk | 91,50 | 284 | 1 |
| onderprofiel kwartrond | | | | | | | |
| 0970662 | | wit | SISR2000002X | stuk | 59,50 | 284 | 1 |
| 0988626 | | glanszilver | SISR200000VX | stuk | 91,50 | 284 | 0 |
| glasdeel vijfhoekig 185cm | | | | | | | |
| 0988715 | TF1 | helder | SITF100018XA | stuk | 799,00 | 284 | 1 |
| 0971456 | TF1 m. KermiClean | helder | SITF100018XP | stuk | 973,00 | 284 | 1 |
| 0988685 | TF3 | helder | SITF300018XA | stuk | 799,00 | 284 | 1 |
| 0971464 | TF3 m. KermiClean | helder | SITF300018XP | stuk | 973,00 | 284 | 1 |
| 0988650 | TF5 | helder | SITF500018XA | stuk | 799,00 | 284 | 1 |
| 0971472 | TF5 m. KermiClean | helder | SITF500018XP | stuk | 973,00 | 284 | 1 |
| glasdeel recht 185cm | | | | | | | |
| 0988553 | | helder | SITG307618XA | stuk | 301,00 | 284 | 0 |
| 0971480 | m. KermiClean | helder | SITG307618XP | stuk | 403,00 | 284 | 1 |
| glasdeel kwartrond 185cm | | | | | | | |
| 0988618 | | helder | SITR200018XA | stuk | 673,00 | 284 | 0 |
| 0971499 | m. KermiClean | helder | SITR200018XP | stuk | 847,00 | 284 | 1 |
| muurprofiel 185cm | | | | | | | |
| 0970697 | | wit | SIWA1000182X | stuk | 59,50 | 284 | 1 |
| 0988588 | | glanszilver | SIWA100018VX | stuk | 73,00 | 284 | 0 |
| buisprofiel 70cm | | | | | | | |
| 0985083 | | glanszilver | ZDRRVR1SIV070 | stuk | 56,50 | 284 | 1 |

Sanitair producten

Baden /
douchebakken /
stoomcabines

Kranen

Douchegarnituur

Accessoires en
spiegels

Douchewanden

Toebehoren &
afvoerenSpoel- &
installatiesystemenBadkamermeubelen
en toiletkastenGootstenen en
wastroggen

Utiliteit

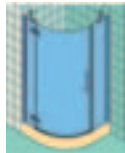

| Art.nr | Specificaties | Kleur | Lev.nr | Ehd | Prijs | Grp | CC |
|---|--------------------------------------|--------------------------------------|--------------------|----------------|---------|---------|-------|
| Kermi Toca-XP | | | | | | | |
| douchecabine kwartrond m. deur | | | | | | | |
| Sanitair producten | 0986863 | 90x185cm (R50) links | matzilver/helder | TX50L090181AK | stuk | 1626,00 | 284 1 |
| | 0986869 | 90x185cm (R50) links | glanszilver/helder | TX50L090181VAK | stuk | 1967,00 | 284 1 |
| | 0986864 | 90x185cm (R50) links m. KermiClean | zilver/helderglas | TX50L090181PK | stuk | 1899,00 | 284 1 |
| Baden / douchebakken / stoomcabines | 0986870 | 90x185cm (R50) links m. KermiClean | glanszilver/helder | TX50L090181VPK | stuk | 2240,00 | 284 1 |
| | 0986875 | 90x185cm (R55) links m. KermiClean | matzilver/helder | TX55L090181AK | stuk | 1626,00 | 284 1 |
| | 0986910 | 90x185cm (R55) links | glanszilver/helder | TX55L090181VAK | stuk | 1967,00 | 284 1 |
| | 0986876 | 90x185cm (R55) links m. KermiClean | matzilver/helder | TX55L090181PK | stuk | 1899,00 | 284 1 |
| | 0986911 | 90x185cm (R55) links m. KermiClean | glanszilver/helder | TX55L090181VPK | stuk | 2240,00 | 284 1 |
| Kranen | 0984347 | 90x200cm (R50) links | matzilver/helder | TX50L090201AK | stuk | 1870,00 | 284 1 |
| | 0984354 | 90x200cm (R50) links | glanszilver/helder | TX50L090201VAK | stuk | 2263,00 | 284 1 |
| | 0984348 | 90x200cm (R50) links m. KermiClean | matzilver/helder | TX50L090201PK | stuk | 2143,00 | 284 1 |
| | 0984355 | 90x200cm (R50) links m. KermiClean | glanszilver/helder | TX50L090201VPK | stuk | 2535,00 | 284 1 |
| Douchegarnituur | 0984360 | 90x200cm (R55) links m. KermiClean | matzilver/helder | TX55L090201AK | stuk | 1870,00 | 284 1 |
| | 0984368 | 90x200cm (R55) links | glanszilver/helder | TX55L090201VAK | stuk | 2263,00 | 284 1 |
| | 0984363 | 90x200cm (R55) links m. KermiClean | matzilver/helder | TX55L090201PK | stuk | 2143,00 | 284 1 |
| | 0984369 | 90x200cm (R55) links m. KermiClean | glanszilver/helder | TX55L090201VPK | stuk | 2535,00 | 284 1 |
| Accessoires en spiegels | 0986916 | 100x185cm (R50) links | matzilver/helder | TX50L100181AK | stuk | 1789,00 | 284 1 |
| | 0986923 | 100x185cm (R50) links | glanszilver/helder | TX50L100181VAK | stuk | 2164,00 | 284 1 |
| | 0986918 | 100x185cm (R50) links m. KermiClean | matzilver/helder | TX50L100181PK | stuk | 2062,00 | 284 1 |
| | 0986924 | 100x185cm (R50) links m. KermiClean | glanszilver/helder | TX50L100181VPK | stuk | 2437,00 | 284 1 |
| Douchewanden | 0984374 | 100x200cm (R50) links | matzilver/helder | TX50L100201AK | stuk | 2057,00 | 284 1 |
| | 0984381 | 100x200cm (R50) links | glanszilver/helder | TX50L100201VAK | stuk | 2489,00 | 284 1 |
| | 0984376 | 100x200cm (R50) links m. KermiClean | matzilver/helder | TX50L100201PK | stuk | 2329,00 | 284 1 |
| | 0984382 | 100x200cm (R50) links m. KermiClean | glanszilver/helder | TX50L100201VPK | stuk | 2762,00 | 284 1 |
| | 0986956 | 100x185cm (R55) links | matzilver/helder | TX55L101181AK | stuk | 1870,00 | 284 1 |
| | 0986962 | 100x185cm (R55) links | glanszilver/helder | TX55L101181VAK | stuk | 2263,00 | 284 1 |
| | 0986957 | 100x185cm (R55) links m. KermiClean | matzilver/helder | TX55L101181PK | stuk | 2143,00 | 284 1 |
| Toebehoren & afvoeren | 0986963 | 100x185cm (R55) links m. KermiClean | glanszilver/helder | TX55L101181VPK | stuk | 2535,00 | 284 1 |
| | 0984400 | 100x200cm (R55) links | matzilver/helder | TX55L101201AK | stuk | 2151,00 | 284 1 |
| | 0984406 | 100x200cm (R55) links | glanszilver/helder | TX55L101201VAK | stuk | 2602,00 | 284 1 |
| Spoel- & installatiesystemen | 0984401 | 100x200cm (R55) links m. KermiClean | matzilver/helder | TX55L101201PK | stuk | 2424,00 | 284 1 |
| | 0984407 | 100x200cm (R55) links m. KermiClean | glanszilver/helder | TX55L101201VPK | stuk | 2875,00 | 284 1 |
| | 0986843 | 90x185cm (R50) rechts | matzilver/helder | TX50R090181AK | stuk | 1626,00 | 284 1 |
| | 0986867 | 90x185cm (R50) rechts | glanszilver/helder | TX50R090181VAK | stuk | 1967,00 | 284 1 |
| Badkamermeubelen en toiletkasten | 0986868 | 90x185cm (R50) rechts m. KermiClean | glanszilver/helder | TX50R090181VPK | stuk | 2240,00 | 284 1 |
| | 0986862 | 90x185cm (R50) rechts m. KermiClean | matzilver/helder | TX50R090181PK | stuk | 1899,00 | 284 1 |
| | 0986873 | 90x185cm (R55) rechts | matzilver/helder | TX55R090181AK | stuk | 1626,00 | 284 1 |
| | 0986908 | 90x185cm (R55) rechts | glanszilver/helder | TX55R090181VAK | stuk | 1967,00 | 284 1 |
| | 0986874 | 90x185cm (R55) rechts m. KermiClean | matzilver/helder | TX55R090181PK | stuk | 1899,00 | 284 1 |
| Gootstenen en wastroggen | 0986909 | 90x185cm (R55) rechts m. KermiClean | glanszilver/helder | TX55R090181VPK | stuk | 2240,00 | 284 1 |
| | 0984319 | 90x200cm (R50) rechts | matzilver/helder | TX50R090201AK | stuk | 1870,00 | 284 1 |
| | 0984351 | 90x200cm (R50) rechts | glanszilver/helder | TX50R090201VAK | stuk | 2263,00 | 284 1 |
| | 0984320 | 90x200cm (R50) rechts m. KermiClean | matzilver/helder | TX50R090201PK | stuk | 2143,00 | 284 1 |
| Utiliteit | 0984352 | 90x200cm (R50) rechts m. KermiClean | glanszilver/helder | TX50R090201VPK | stuk | 2535,00 | 284 1 |
| | 0984358 | 90x200cm (R55) rechts | matzilver/helder | TX55R090201AK | stuk | 1870,00 | 284 1 |
| | 0984366 | 90x200cm (R55) rechts | glanszilver/helder | TX55R090201VAK | stuk | 2263,00 | 284 1 |
| | 0984359 | 90x200cm (R55) rechts m. KermiClean | matzilver/helder | TX55R090201PK | stuk | 2143,00 | 284 1 |
| | 0984367 | 90x200cm (R55) rechts m. KermiClean | glanszilver/helder | TX55R090201VPK | stuk | 2535,00 | 284 1 |
| | 0986914 | 100x185cm (R50) rechts | matzilver/helder | TX50R100181AK | stuk | 1789,00 | 284 1 |
| | 0986921 | 100x185cm (R50) rechts | glanszilver/helder | TX50R100181VAK | stuk | 2164,00 | 284 1 |
| | 0986915 | 100x185cm (R50) rechts m. KermiClean | matzilver/helder | TX50R100181PK | stuk | 2062,00 | 284 1 |
| | 0986922 | 100x185cm (R50) rechts m. KermiClean | glanszilver/helder | TX50R100181VPK | stuk | 2437,00 | 284 1 |
| | 0986954 | 100x185cm (R55) rechts | matzilver/helder | TX55R101181AK | stuk | 1870,00 | 284 1 |
| | 0986960 | 100x185cm (R55) rechts | glanszilver/helder | TX55R101181VAK | stuk | 2263,00 | 284 1 |
| | 0986955 | 100x185cm (R55) rechts m. KermiClean | matzilver/helder | TX55R101181PK | stuk | 2143,00 | 284 1 |
| | 0986961 | 100x185cm (R55) rechts m. KermiClean | glanszilver/helder | TX55R101181VPK | stuk | 2535,00 | 284 1 |
| | 0984398 | 100x200cm (R55) rechts | matzilver/helder | TX55R101201AK | stuk | 2151,00 | 284 1 |
| | 0984404 | 100x200cm (R55) rechts | glanszilver/helder | TX55R101201VAK | stuk | 2602,00 | 284 1 |
| | 0984399 | 100x200cm (R55) rechts m. KermiClean | matzilver/helder | TX55R101201PK | stuk | 2424,00 | 284 1 |
| | 0984405 | 100x200cm (R55) rechts m. KermiClean | glanszilver/helder | TX55R101201VPK | stuk | 2875,00 | 284 1 |
| 0984372 | 100x200cm (R50) rechts | matzilver/helder | TX50R100201AK | stuk | 2057,00 | 284 1 | |
| 0984379 | 100x200cm (R50) rechts | glanszilver/helder | TX50R100201VAK | stuk | 2489,00 | 284 1 | |
| 0984373 | 100x200cm (R50) rechts m. KermiClean | matzilver/helder | TX50R100201PK | stuk | 2329,00 | 284 1 | |
| 0984380 | 100x200cm (R50) rechts m. KermiClean | glanszilver/helder | TX50R100201VPK | stuk | 2762,00 | 284 1 | |

| Art.nr | Specificaties | Kleur | Lev.nr | Ehd | Prijs | Grp | CC |
|--|-------------------------------------|-------------------|---------------|------|---------|-----|----|
| Kermi Toca-XP | | | | | | | |
| douchecabine vijfhoekig m. deur | | | | | | | |
| 0986977 | 90x185cm (40) links | matzilv./helder | TXL40090181AK | stuk | 1658,00 | 284 | 1 |
| 0986983 | 90x185cm (40) links | glanszilv./helder | TXL4009018VAK | stuk | 2006,00 | 284 | 1 |
| 0986978 | 90x185cm (40) links m. KermiClean | matzilv./helder | TXL40090181PK | stuk | 1931,00 | 284 | 1 |
| 0986985 | 90x185cm (40) links m. KermiClean | glanszilv./helder | TXL4009018VPK | stuk | 2279,00 | 284 | 1 |
| 0986990 | 90x185cm (45) links | matzilv./helder | TXL45090181AK | stuk | 1658,00 | 284 | 1 |
| 0987003 | 90x185cm (45) links | glanszilv./helder | TXL4509018VAK | stuk | 2006,00 | 284 | 1 |
| 0986991 | 90x185cm (45) links m. KermiClean | matzilv./helder | TXL45090181PK | stuk | 1931,00 | 284 | 1 |
| 0987004 | 90x185cm (45) links m. KermiClean | glanszilv./helder | TXL4509018VPK | stuk | 2279,00 | 284 | 1 |
| 0986966 | 90x185cm (40) rechts | matzilv./helder | TXR40090181AK | stuk | 1658,00 | 284 | 1 |
| 0986981 | 90x185cm (40) rechts | glanszilv./helder | TXR4009018VAK | stuk | 2006,00 | 284 | 1 |
| 0986967 | 90x185cm (40) rechts m. KermiClean | matzilv./helder | TXR40090181PK | stuk | 1931,00 | 284 | 1 |
| 0986982 | 90x185cm (40) rechts m. KermiClean | glanszilv./helder | TXR4009018VPK | stuk | 2279,00 | 284 | 1 |
| 0986988 | 90x185cm (45) rechts m. KermiClean | matzilv./helder | TXR45090181AK | stuk | 1658,00 | 284 | 1 |
| 0987001 | 90x185cm (45) rechts | glanszilv./helder | TXR4509018VAK | stuk | 2006,00 | 284 | 1 |
| 0986989 | 90x185cm (45) rechts m. KermiClean | matzilv./helder | TXR45090181PK | stuk | 1931,00 | 284 | 1 |
| 0987002 | 90x185cm (45) rechts m. KermiClean | glanszilv./helder | TXR4509018VPK | stuk | 2279,00 | 284 | 1 |
| 0984412 | 90x200cm (40) links | matzilv./helder | TXL40090201AK | stuk | 1824,00 | 284 | 1 |
| 0984419 | 90x200cm (40) links | glanszilv./helder | TXL4009020VAK | stuk | 2206,00 | 284 | 1 |
| 0984413 | 90x200cm (40) links m. KermiClean | matzilv./helder | TXL40090201PK | stuk | 2097,00 | 284 | 1 |
| 0984420 | 90x200cm (40) links m. KermiClean | glanszilv./helder | TXL4009020VPK | stuk | 2479,00 | 284 | 1 |
| 0984425 | 90x200cm (45) links | matzilv./helder | TXL45090201AK | stuk | 1824,00 | 284 | 1 |
| 0984432 | 90x200cm (45) links | glanszilv./helder | TXL4509020VAK | stuk | 2206,00 | 284 | 1 |
| 0984427 | 90x200cm (45) links m. KermiClean | matzilv./helder | TXL45090201PK | stuk | 2097,00 | 284 | 1 |
| 0984433 | 90x200cm (45) links m. KermiClean | glanszilv./helder | TXL4509020VPK | stuk | 2479,00 | 284 | 1 |
| 0984410 | 90x200cm (40) rechts | matzilv./helder | TXR40090201AK | stuk | 1824,00 | 284 | 1 |
| 0984416 | 90x200cm (40) rechts | glanszilv./helder | TXR4009020VAK | stuk | 2206,00 | 284 | 1 |
| 0984411 | 90x200cm (40) rechts m. KermiClean | matzilv./helder | TXR40090201PK | stuk | 2097,00 | 284 | 1 |
| 0984417 | 90x200cm (40) rechts m. KermiClean | glanszilv./helder | TXR4009020VPK | stuk | 2479,00 | 284 | 1 |
| 0984423 | 90x200cm (45) rechts | matzilv./helder | TXR45090201AK | stuk | 1824,00 | 284 | 1 |
| 0984430 | 90x200cm (45) rechts | glanszilv./helder | TXR4509020VAK | stuk | 2206,00 | 284 | 1 |
| 0984424 | 90x200cm (45) rechts m. KermiClean | matzilv./helder | TXR45090201PK | stuk | 2097,00 | 284 | 1 |
| 0984431 | 90x200cm (45) rechts m. KermiClean | glanszilv./helder | TXR4509020VPK | stuk | 2479,00 | 284 | 1 |
| 0987009 | 100x185cm (50) links | matzilv./helder | TXL50100181AK | stuk | 1824,00 | 284 | 1 |
| 0987015 | 100x185cm (50) links | glanszilv./helder | TXL5010018VAK | stuk | 2206,00 | 284 | 1 |
| 0987010 | 100x185cm (50) links m. KermiClean | matzilv./helder | TXL50100181PK | stuk | 2097,00 | 284 | 1 |
| 0987016 | 100x185cm (50) links m. KermiClean | glanszilv./helder | TXL5010018VPK | stuk | 2479,00 | 284 | 1 |
| 0987007 | 100x185cm (50) rechts | matzilv./helder | TXR50100181AK | stuk | 1824,00 | 284 | 1 |
| 0987013 | 100x185cm (50) rechts | glanszilv./helder | TXR5010018VAK | stuk | 2206,00 | 284 | 1 |
| 0987008 | 100x185cm (50) rechts m. KermiClean | matzilv./helder | TXR50100181PK | stuk | 2097,00 | 284 | 1 |
| 0987014 | 100x185cm (50) rechts m. KermiClean | glanszilv./helder | TXR5010018VPK | stuk | 2479,00 | 284 | 1 |
| 0984439 | 100x200cm (50) links | matzilv./helder | TXL50100201AK | stuk | 2006,00 | 284 | 1 |
| 0984446 | 100x200cm (50) links | glanszilv./helder | TXL5010020VAK | stuk | 2428,00 | 284 | 1 |
| 0984440 | 100x200cm (50) links m. KermiClean | matzilv./helder | TXL50100201PK | stuk | 2279,00 | 284 | 1 |
| 0984447 | 100x200cm (50) links m. KermiClean | glanszilv./helder | TXL5010020VPK | stuk | 2700,00 | 284 | 1 |
| 0984437 | 100x200cm (50) rechts | matzilv./helder | TXR50100201AK | stuk | 2006,00 | 284 | 1 |
| 0984444 | 100x200cm (50) rechts | glanszilv./helder | TXR5010020VAK | stuk | 2428,00 | 284 | 1 |
| 0984438 | 100x200cm (50) rechts m. KermiClean | matzilv./helder | TXR50100201PK | stuk | 2279,00 | 284 | 1 |
| 0984445 | 100x200cm (50) rechts m. KermiClean | glanszilv./helder | TXR5010020VPK | stuk | 2700,00 | 284 | 1 |



Sanitair producten

Baden /
douchebakken /
stoomcabines

Kranen

Douchegarnituur

Accessoires en
spiegels

Douchewanden

Toebehoren &
afvoerenSpoel- &
installatiesystemenBadkamermeubelen
en toiletkastenGootstenen en
wastroggen

Utiliteit

Art.nr Specificaties Kleur Lev.nr Ehd Prijs Grp CC

Kermi Toca-XP

deur voor zijwand

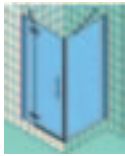

| | | | | | | | | | |
|---|---------|-----------|----------------------|--------------------|----------------|------|---------|-----|---|
| Sanitair producten | 0986679 | 90x185cm | links | matzilver/helder | TXSWL090181AK | stuk | 769,00 | 284 | 1 |
| | 0986693 | 90x185cm | links | glanszilver/helder | TXSWL090181VAK | stuk | 930,00 | 284 | 1 |
| Baden / douchebakken / stoomcabines | 0986680 | 90x185cm | links m. KermiClean | matzilver/helder | TXSWL090181PK | stuk | 922,00 | 284 | 1 |
| | 0986694 | 90x185cm | links m. KermiClean | glanszilver/helder | TXSWL090181VPK | stuk | 1083,00 | 284 | 1 |
| | 0986677 | 90x185cm | rechts | matzilver/helder | TXSWR090181AK | stuk | 769,00 | 284 | 1 |
| | 0986681 | 90x185cm | rechts | glanszilver/helder | TXSWR090181VAK | stuk | 930,00 | 284 | 1 |
| | 0986678 | 90x185cm | rechts m. KermiClean | matzilver/helder | TXSWR090181PK | stuk | 922,00 | 284 | 1 |
| | 0986692 | 90x185cm | rechts m. KermiClean | glanszilver/helder | TXSWR090181VPK | stuk | 1083,00 | 284 | 1 |
| Kranen | 0981133 | 90x200cm | links | matzilver/helder | TXSWL090201AK | stuk | 846,00 | 284 | 1 |
| | 0981145 | 90x200cm | links | glanszilver/helder | TXSWL090201VAK | stuk | 1023,00 | 284 | 1 |
| | 0981142 | 90x200cm | links m. KermiClean | matzilver/helder | TXSWL090201PK | stuk | 999,00 | 284 | 1 |
| | 0981146 | 90x200cm | links m. KermiClean | glanszilver/helder | TXSWL090201VPK | stuk | 1176,00 | 284 | 1 |
| Douchegarnituur | 0981131 | 90x200cm | rechts | matzilver/helder | TXSWR090201AK | stuk | 846,00 | 284 | 1 |
| | 0981143 | 90x200cm | rechts | glanszilver/helder | TXSWR090201VAK | stuk | 1023,00 | 284 | 1 |
| | 0981132 | 90x200cm | rechts m. KermiClean | matzilver/helder | TXSWR090201PK | stuk | 999,00 | 284 | 1 |
| | 0981144 | 90x200cm | rechts m. KermiClean | glanszilver/helder | TXSWR090201VPK | stuk | 1176,00 | 284 | 1 |
| | 0986697 | 100x185cm | links | matzilver/helder | TXSWL100181AK | stuk | 885,00 | 284 | 1 |
| | 0986781 | 100x185cm | links | glanszilver/helder | TXSWL100181VAK | stuk | 1071,00 | 284 | 1 |
| Accessoires en spiegels | 0986698 | 100x185cm | links m. KermiClean | matzilver/helder | TXSWL100181PK | stuk | 1038,00 | 284 | 1 |
| | 0986782 | 100x185cm | links m. KermiClean | glanszilver/helder | TXSWL100181VPK | stuk | 1223,00 | 284 | 1 |
| | 0986695 | 100x185cm | rechts | matzilver/helder | TXSWR100181AK | stuk | 885,00 | 284 | 1 |
| Douchewanden | 0986779 | 100x185cm | rechts | glanszilver/helder | TXSWR100181VAK | stuk | 1071,00 | 284 | 1 |
| | 0986696 | 100x185cm | rechts m. KermiClean | matzilver/helder | TXSWR100181PK | stuk | 1038,00 | 284 | 1 |
| | 0986780 | 100x185cm | rechts m. KermiClean | glanszilver/helder | TXSWR100181VPK | stuk | 1223,00 | 284 | 1 |
| | 0981149 | 100x200cm | links | matzilver/helder | TXSWL100201AK | stuk | 973,00 | 284 | 1 |
| | 0981153 | 100x200cm | links | glanszilver/helder | TXSWL100201VAK | stuk | 1177,00 | 284 | 1 |
| | 0981150 | 100x200cm | links m. KermiClean | matzilver/helder | TXSWL100201PK | stuk | 1126,00 | 284 | 1 |
| Toebehoren & afvoeren | 0981154 | 100x200cm | links m. KermiClean | glanszilver/helder | TXSWL100201VPK | stuk | 1330,00 | 284 | 1 |
| | 0981147 | 100x200cm | rechts | matzilver/helder | TXSWR100201AK | stuk | 973,00 | 284 | 1 |
| | 0981151 | 100x200cm | rechts | glanszilver/helder | TXSWR100201VAK | stuk | 1177,00 | 284 | 1 |
| | 0981148 | 100x200cm | rechts m. KermiClean | matzilver/helder | TXSWR100201PK | stuk | 1126,00 | 284 | 1 |
| Spoel- & installatiesystemen | 0981152 | 100x200cm | rechts m. KermiClean | glanszilver/helder | TXSWR100201VPK | stuk | 1330,00 | 284 | 1 |

deur voor hoekinstap

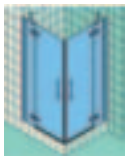

| | | | | | | | | | |
|-------------------------------------|-----------|----------------------|----------------------|--------------------|----------------|---------|---------|-----|---|
| Badkamermeubelen en toiletkasten | 0986817 | 90x185cm | links | matzilver/helder | TXESL090181AK | stuk | 813,00 | 284 | 1 |
| | 0986821 | 90x185cm | links | glanszilver/helder | TXESL090181VAK | stuk | 984,00 | 284 | 1 |
| | 0986818 | 90x185cm | links m. KermiClean | matzilver/helder | TXESL090181PK | stuk | 966,00 | 284 | 1 |
| | 0986822 | 90x185cm | links m. KermiClean | glanszilver/helder | TXESL090181VPK | stuk | 1137,00 | 284 | 1 |
| | 0981185 | 90x200cm | links | matzilver/helder | TXESL090201AK | stuk | 894,00 | 284 | 1 |
| | 0981189 | 90x200cm | links | glanszilver/helder | TXESL090201VAK | stuk | 1083,00 | 284 | 1 |
| Gootstenen en wastroggen | 0981186 | 90x200cm | links m. KermiClean | matzilver/helder | TXESL090201PK | stuk | 1047,00 | 284 | 1 |
| | 0981190 | 90x200cm | links m. KermiClean | glanszilver/helder | TXESL090201VPK | stuk | 1236,00 | 284 | 1 |
| | 0986837 | 100x185cm | links | matzilver/helder | TXESL100181AK | stuk | 919,00 | 284 | 1 |
| | 0986841 | 100x185cm | links | glanszilver/helder | TXESL100181VAK | stuk | 1112,00 | 284 | 1 |
| Utiliteit | 0986838 | 100x185cm | links m. KermiClean | matzilver/helder | TXESL100181PK | stuk | 1072,00 | 284 | 1 |
| | 0986842 | 100x185cm | links m. KermiClean | glanszilver/helder | TXESL100181VPK | stuk | 1264,00 | 284 | 1 |
| | 0984313 | 100x200cm | links | matzilver/helder | TXESL100201AK | stuk | 1011,00 | 284 | 1 |
| | 0984317 | 100x200cm | links | glanszilver/helder | TXESL100201VAK | stuk | 1223,00 | 284 | 1 |
| | 0984314 | 100x200cm | links m. KermiClean | matzilver/helder | TXESL100201PK | stuk | 1164,00 | 284 | 1 |
| | 0984318 | 100x200cm | links m. KermiClean | glanszilver/helder | TXESL100201VPK | stuk | 1376,00 | 284 | 1 |
| | 0986815 | 90x185cm | rechts | matzilver/helder | TXESR090181AK | stuk | 813,00 | 284 | 1 |
| | 0986819 | 90x185cm | rechts | glanszilver/helder | TXESR090181VAK | stuk | 984,00 | 284 | 1 |
| | 0986816 | 90x185cm | rechts m. KermiClean | matzilver/helder | TXESR090181PK | stuk | 966,00 | 284 | 1 |
| | 0986820 | 90x185cm | rechts m. KermiClean | glanszilver/helder | TXESR090181VPK | stuk | 1137,00 | 284 | 1 |
| | 0981183 | 90x200cm | rechts | matzilver/helder | TXESR090201AK | stuk | 894,00 | 284 | 1 |
| | 0981187 | 90x200cm | rechts | glanszilver/helder | TXESR090201VAK | stuk | 1083,00 | 284 | 1 |
| | 0981184 | 90x200cm | rechts m. KermiClean | matzilver/helder | TXESR090201PK | stuk | 1047,00 | 284 | 1 |
| | 0981188 | 90x200cm | rechts m. KermiClean | glanszilver/helder | TXESR090201VPK | stuk | 1236,00 | 284 | 1 |
| | 0986823 | 100x185cm | rechts | matzilver/helder | TXESR100181AK | stuk | 919,00 | 284 | 1 |
| | 0986839 | 100x185cm | rechts | glanszilver/helder | TXESR100181VAK | stuk | 1112,00 | 284 | 1 |
| 0986824 | 100x185cm | rechts m. KermiClean | matzilver/helder | TXESR100181PK | stuk | 1072,00 | 284 | 1 | |
| 0986840 | 100x185cm | rechts m. KermiClean | glanszilver/helder | TXESR100181VPK | stuk | 1264,00 | 284 | 1 | |
| 0984311 | 100x200cm | rechts | matzilver/helder | TXESR100201AK | stuk | 1011,00 | 284 | 1 | |
| 0984315 | 100x200cm | rechts | glanszilver/helder | TXESR100201VAK | stuk | 1223,00 | 284 | 1 | |
| 0984312 | 100x200cm | rechts m. KermiClean | matzilver/helder | TXESR100201PK | stuk | 1164,00 | 284 | 1 | |
| 0984316 | 100x200cm | rechts m. KermiClean | glanszilver/helder | TXESR100201VPK | stuk | 1376,00 | 284 | 1 | |

| Art.nr | Specificaties | Kleur | Lev.nr | Ehd | Prijs | Grp | CC |
|-----------------------------------|--------------------------------|-------------------|----------------|------|---------|-----|----|
| Kermi Toca-XP | | | | | | | |
| deur voor verkorte zijwand | | | | | | | |
| 0986785 | 90x185cm links | matzilv./helder | TXSVL090181AK | stuk | 769,00 | 284 | 1 |
| 0986789 | 90x185cm links | glanszilv./helder | TXSVL090181VAK | stuk | 930,00 | 284 | 1 |
| 0986786 | 90x185cm links m. KermiClean | matzilv./helder | TXSVL090181PK | stuk | 922,00 | 284 | 1 |
| 0986790 | 90x185cm links m. KermiClean | glanszilv./helder | TXSVL090181VPK | stuk | 1083,00 | 284 | 1 |
| 0986783 | 90x185cm rechts | matzilv./helder | TXSVR090181AK | stuk | 769,00 | 284 | 1 |
| 0986787 | 90x185cm rechts | glanszilv./helder | TXSVR090181VAK | stuk | 930,00 | 284 | 1 |
| 0986784 | 90x185cm rechts m. KermiClean | matzilv./helder | TXSVR090181PK | stuk | 922,00 | 284 | 1 |
| 0986788 | 90x185cm rechts m. KermiClean | glanszilv./helder | TXSVR090181VPK | stuk | 1083,00 | 284 | 1 |
| 0981157 | 90x200cm links | matzilv./helder | TXSVL090201AK | stuk | 846,00 | 284 | 1 |
| 0981161 | 90x200cm links | glanszilv./helder | TXSVL090201VAK | stuk | 1023,00 | 284 | 1 |
| 0981158 | 90x200cm links m. KermiClean | matzilv./helder | TXSVL090201PK | stuk | 999,00 | 284 | 1 |
| 0981162 | 90x200cm links m. KermiClean | glanszilv./helder | TXSVL090201VPK | stuk | 1176,00 | 284 | 1 |
| 0981155 | 90x200cm rechts | matzilv./helder | TXSVR090201AK | stuk | 846,00 | 284 | 1 |
| 0981159 | 90x200cm rechts | glanszilv./helder | TXSVR090201VAK | stuk | 1023,00 | 284 | 1 |
| 0981156 | 90x200cm rechts m. KermiClean | matzilv./helder | TXSVR090201PK | stuk | 999,00 | 284 | 1 |
| 0981160 | 90x200cm rechts m. KermiClean | glanszilv./helder | TXSVR090201VPK | stuk | 1176,00 | 284 | 1 |
| 0986793 | 100x185cm links | matzilv./helder | TXSVL100181AK | stuk | 885,00 | 284 | 1 |
| 0986797 | 100x185cm links | glanszilv./helder | TXSVL100181VAK | stuk | 1071,00 | 284 | 1 |
| 0986794 | 100x185cm links m. KermiClean | matzilv./helder | TXSVL100181PK | stuk | 1038,00 | 284 | 1 |
| 0986802 | 100x185cm links m. KermiClean | glanszilv./helder | TXSVL100181VPK | stuk | 1223,00 | 284 | 1 |
| 0986791 | 100x185cm rechts | matzilv./helder | TXSVR100181AK | stuk | 885,00 | 284 | 1 |
| 0986795 | 100x185cm rechts | glanszilv./helder | TXSVR100181VAK | stuk | 1071,00 | 284 | 1 |
| 0986792 | 100x185cm rechts m. KermiClean | matzilv./helder | TXSVR100181PK | stuk | 1038,00 | 284 | 1 |
| 0986796 | 100x185cm rechts m. KermiClean | glanszilv./helder | TXSVR100181VPK | stuk | 1223,00 | 284 | 1 |
| 0981165 | 100x200cm links | matzilv./helder | TXSVL100201AK | stuk | 973,00 | 284 | 1 |
| 0981169 | 100x200cm links | glanszilv./helder | TXSVL100201VAK | stuk | 1177,00 | 284 | 1 |
| 0981166 | 100x200cm links m. KermiClean | matzilv./helder | TXSVL100201PK | stuk | 1126,00 | 284 | 1 |
| 0981170 | 100x200cm links m. KermiClean | glanszilv./helder | TXSVL100201VPK | stuk | 1330,00 | 284 | 1 |
| 0981163 | 100x200cm rechts | matzilv./helder | TXSVR100201AK | stuk | 973,00 | 284 | 1 |
| 0981167 | 100x200cm rechts | glanszilv./helder | TXSVR100201VAK | stuk | 1177,00 | 284 | 1 |
| 0981164 | 100x200cm rechts m. KermiClean | matzilv./helder | TXSVR100201PK | stuk | 1126,00 | 284 | 1 |
| 0981168 | 100x200cm rechts m. KermiClean | glanszilv./helder | TXSVR100201VPK | stuk | 1330,00 | 284 | 1 |
| deur voor nis | | | | | | | |
| 0986638 | 90x185cm links | matzilv./helder | TXSTL090181AK | stuk | 818,00 | 284 | 1 |
| 0986642 | 90x185cm links | glanszilv./helder | TXSTL090181VAK | stuk | 990,00 | 284 | 1 |
| 0986639 | 90x185cm links m. KermiClean | matzilv./helder | TXSTL090181PK | stuk | 971,00 | 284 | 1 |
| 0986643 | 90x185cm links m. KermiClean | glanszilv./helder | TXSTL090181VPK | stuk | 1142,00 | 284 | 1 |
| 0981117 | 90x200cm links | matzilv./helder | TXSTL090201AK | stuk | 900,00 | 284 | 1 |
| 0981121 | 90x200cm links | glanszilv./helder | TXSTL090201VAK | stuk | 1089,00 | 284 | 1 |
| 0981118 | 90x200cm links m. KermiClean | matzilv./helder | TXSTL090201PK | stuk | 1053,00 | 284 | 1 |
| 0981122 | 90x200cm links m. KermiClean | glanszilv./helder | TXSTL090201VPK | stuk | 1242,00 | 284 | 1 |
| 0986646 | 100x185cm links | matzilv./helder | TXSTL100181AK | stuk | 925,00 | 284 | 1 |
| 0986675 | 100x185cm links | glanszilv./helder | TXSTL100181VAK | stuk | 1119,00 | 284 | 1 |
| 0986647 | 100x185cm links m. KermiClean | matzilv./helder | TXSTL100181PK | stuk | 1078,00 | 284 | 1 |
| 0986676 | 100x185cm links m. KermiClean | glanszilv./helder | TXSTL100181VPK | stuk | 1271,00 | 284 | 1 |
| 0981125 | 100x200cm links | matzilv./helder | TXSTL100201AK | stuk | 1017,00 | 284 | 1 |
| 0981129 | 100x200cm links | glanszilv./helder | TXSTL100201VAK | stuk | 1230,00 | 284 | 1 |
| 0981126 | 100x200cm links m. KermiClean | matzilv./helder | TXSTL100201PK | stuk | 1170,00 | 284 | 1 |
| 0981130 | 100x200cm links m. KermiClean | glanszilv./helder | TXSTL100201VPK | stuk | 1383,00 | 284 | 1 |
| 0986636 | 90x185cm rechts | matzilv./helder | TXSTR090181AK | stuk | 818,00 | 284 | 1 |
| 0986640 | 90x185cm rechts | glanszilv./helder | TXSTR090181VAK | stuk | 990,00 | 284 | 1 |
| 0986637 | 90x185cm rechts m. KermiClean | matzilv./helder | TXSTR090181PK | stuk | 971,00 | 284 | 1 |
| 0986641 | 90x185cm rechts m. KermiClean | glanszilv./helder | TXSTR090181VPK | stuk | 1142,00 | 284 | 1 |
| 0981115 | 90x200cm rechts | matzilv./helder | TXSTR090201AK | stuk | 900,00 | 284 | 1 |
| 0981119 | 90x200cm rechts | glanszilv./helder | TXSTR090201VAK | stuk | 1089,00 | 284 | 1 |
| 0981116 | 90x200cm rechts m. KermiClean | matzilv./helder | TXSTR090201PK | stuk | 1053,00 | 284 | 1 |
| 0981120 | 90x200cm rechts m. KermiClean | glanszilv./helder | TXSTR090201VPK | stuk | 1242,00 | 284 | 1 |
| 0986644 | 100x185cm rechts | matzilv./helder | TXSTR100181AK | stuk | 925,00 | 284 | 1 |
| 0986648 | 100x185cm rechts | glanszilv./helder | TXSTR100181VAK | stuk | 1119,00 | 284 | 1 |
| 0986645 | 100x185cm rechts m. KermiClean | matzilv./helder | TXSTR100181PK | stuk | 1078,00 | 284 | 1 |
| 0986649 | 100x185cm rechts m. KermiClean | glanszilv./helder | TXSTR100181VPK | stuk | 1271,00 | 284 | 1 |
| 0981123 | 100x200cm rechts | matzilv./helder | TXSTR100201AK | stuk | 1017,00 | 284 | 1 |
| 0981127 | 100x200cm rechts | glanszilv./helder | TXSTR100201VAK | stuk | 1230,00 | 284 | 1 |
| 0981124 | 100x200cm rechts m. KermiClean | matzilv./helder | TXSTR100201PK | stuk | 1170,00 | 284 | 1 |
| 0981128 | 100x200cm rechts m. KermiClean | glanszilv./helder | TXSTR100201VPK | stuk | 1383,00 | 284 | 1 |



Sanitair producten

Baden /
douchebakken /
stoomcabines

Kranen

Douchegarnituur

Accessoires en
spiegels**Douchewanden**Toebehoren &
afvoerenSpoel- &
installatiesystemenBadkamermeubelen
en toiletkastenGootstenen en
wastroggen

Utiliteit

| Art.nr | Specificaties | Kleur | Lev.nr | Ehd | Prijs | Grp | CC |
|---|--|-------------------------------|-------------------|----------------|---------|---------|-------|
| Kermi Toca-XP | | | | | | | |
| douchecabine kwartrond m. pendeldeuren | | | | | | | |
| Sanitair producten | 0986865 | 90x185cm (R50) | matzilv./helder | TXE50090181AK | stuk | 1626,00 | 284 1 |
| | 0986871 | 90x185cm (R50) | glanszilv./helder | TXE50090181VAK | stuk | 1967,00 | 284 1 |
| Baden / douchebakken / stoomcabines | 0986866 | 90x185cm (R50) m. KermiClean | matzilv./helder | TXE50090181PK | stuk | 1899,00 | 284 1 |
| | 0986872 | 90x185cm (R50) m. KermiClean | glanszilv./helder | TXE50090181VPK | stuk | 2240,00 | 284 1 |
| | 0986877 | 90x185cm (R55) | matzilv./helder | TXE55090181AK | stuk | 1626,00 | 284 1 |
| | 0986912 | 90x185cm (R55) | glanszilv./helder | TXE55090181VAK | stuk | 1967,00 | 284 1 |
| | 0986878 | 90x185cm (R55) m. KermiClean | matzilv./helder | TXE55090181PK | stuk | 1899,00 | 284 1 |
| | 0986913 | 90x185cm (R55) m. KermiClean | glanszilv./helder | TXE55090181VPK | stuk | 2240,00 | 284 1 |
| Kranen | 0984349 | 90x200cm (R50) | matzilv./helder | TXE50090201AK | stuk | 1870,00 | 284 1 |
| | 0984356 | 90x200cm (R50) | glanszilv./helder | TXE50090201VAK | stuk | 2263,00 | 284 1 |
| | 0984350 | 90x200cm (R50) m. KermiClean | matzilv./helder | TXE50090201PK | stuk | 2143,00 | 284 1 |
| | 0984357 | 90x200cm (R50) m. KermiClean | glanszilv./helder | TXE50090201VPK | stuk | 2535,00 | 284 1 |
| Douchegarnituur | 0984364 | 90x200cm (R55) | matzilv./helder | TXE55090201AK | stuk | 1870,00 | 284 1 |
| | 0984370 | 90x200cm (R55) | glanszilv./helder | TXE55090201VAK | stuk | 2263,00 | 284 1 |
| | 0984365 | 90x200cm (R55) m. KermiClean | matzilv./helder | TXE55090201PK | stuk | 2143,00 | 284 1 |
| | 0984371 | 90x200cm (R55) m. KermiClean | glanszilv./helder | TXE55090201VPK | stuk | 2535,00 | 284 1 |
| | 0986919 | 100x185cm (R50) | matzilv./helder | TXE50100181AK | stuk | 1789,00 | 284 1 |
| Accessoires en spiegels | 0986926 | 100x185cm (R50) | glanszilv./helder | TXE50100181VAK | stuk | 2164,00 | 284 1 |
| | 0986920 | 100x185cm (R50) m. KermiClean | matzilv./helder | TXE50100181PK | stuk | 2062,00 | 284 1 |
| | 0986927 | 100x185cm (R50) m. KermiClean | glanszilv./helder | TXE50100181VPK | stuk | 2437,00 | 284 1 |
| | 0984377 | 100x200cm (R50) | matzilv./helder | TXE50100201AK | stuk | 2057,00 | 284 1 |
| Douchewanden | 0984383 | 100x200cm (R50) | glanszilv./helder | TXE50100201VAK | stuk | 2489,00 | 284 1 |
| | 0984378 | 100x200cm (R50) m. KermiClean | matzilv./helder | TXE50100201PK | stuk | 2329,00 | 284 1 |
| | 0984384 | 100x200cm (R50) m. KermiClean | glanszilv./helder | TXE50100201VPK | stuk | 2762,00 | 284 1 |
| | 0986958 | 100x185cm (R55) | matzilv./helder | TXE55101181AK | stuk | 1870,00 | 284 1 |
| | 0986964 | 100x185cm (R55) | glanszilv./helder | TXE55101181VAK | stuk | 2263,00 | 284 1 |
| | 0986959 | 100x185cm (R55) m. KermiClean | matzilv./helder | TXE55101181PK | stuk | 2143,00 | 284 1 |
| | 0986965 | 100x185cm (R55) m. KermiClean | glanszilv./helder | TXE55101181VPK | stuk | 2535,00 | 284 1 |
| Toebehoren & afvoeren | 0984402 | 100x200cm (R55) | matzilv./helder | TXE55101201AK | stuk | 2151,00 | 284 1 |
| | 0984408 | 100x200cm (R55) | glanszilv./helder | TXE55101201VAK | stuk | 2602,00 | 284 1 |
| | 0984403 | 100x200cm (R55) m. KermiClean | matzilv./helder | TXE55101201PK | stuk | 2424,00 | 284 1 |
| | 0984409 | 100x200cm (R55) m. KermiClean | glanszilv./helder | TXE55101201VPK | stuk | 2875,00 | 284 1 |
| SPOOL- & installatiesystemen | douchecabine vijfhoekig m. pendeldeuren | | | | | | |
| | 0986979 | 90x185cm -40 | matzilv./helder | TXF40090181AK | stuk | 1658,00 | 284 1 |
| Badkamermeubelen en toiletkasten | 0986986 | 90x185cm -40 | glanszilv./helder | TXF40090181VAK | stuk | 2006,00 | 284 1 |
| | 0986980 | 90x185cm (40) m. KermiClean | matzilv./helder | TXF40090181PK | stuk | 1931,00 | 284 1 |
| | 0986987 | 90x185cm (40) m. KermiClean | glanszilv./helder | TXF40090181VPK | stuk | 2279,00 | 284 1 |
| | 0987024 | 90x185cm -45 | matzilv./helder | TXF45090181AK | stuk | 1658,00 | 284 1 |
| | 0987005 | 90x185cm -45 | glanszilv./helder | TXF45090181VAK | stuk | 2006,00 | 284 1 |
| Gootstenen en wastroggen | 0987000 | 90x185cm (45) m. KermiClean | matzilv./helder | TXF45090181PK | stuk | 1931,00 | 284 1 |
| | 0987006 | 90x185cm (45) m. KermiClean | glanszilv./helder | TXF45090181VPK | stuk | 2279,00 | 284 1 |
| | 0984414 | 90x200cm -40 | matzilv./helder | TXF40090201AK | stuk | 1824,00 | 284 1 |
| | 0984421 | 90x200cm -40 | glanszilv./helder | TXF40090201VAK | stuk | 2206,00 | 284 1 |
| Utiliteit | 0984415 | 90x200cm (40) m. KermiClean | matzilv./helder | TXF40090201PK | stuk | 2097,00 | 284 1 |
| | 0984422 | 90x200cm (40) m. KermiClean | glanszilv./helder | TXF40090201VPK | stuk | 2479,00 | 284 1 |
| | 0984428 | 90x200cm -45 | matzilv./helder | TXF45090201AK | stuk | 1824,00 | 284 1 |
| | 0984435 | 90x200cm -45 | glanszilv./helder | TXF45090201VAK | stuk | 2206,00 | 284 1 |
| | 0984429 | 90x200cm (45) m. KermiClean | matzilv./helder | TXF45090201PK | stuk | 2097,00 | 284 1 |
| | 0984436 | 90x200cm (45) m. KermiClean | glanszilv./helder | TXF45090201VPK | stuk | 2479,00 | 284 1 |
| | 0987011 | 100x185cm -50 | matzilv./helder | TXF50100181AK | stuk | 1824,00 | 284 1 |
| | 0987021 | 100x185cm -50 | glanszilv./helder | TXF50100181VAK | stuk | 2206,00 | 284 1 |
| | 0987012 | 100x185cm (50) m. KermiClean | matzilv./helder | TXF50100181PK | stuk | 2097,00 | 284 1 |
| | 0987022 | 100x185cm (50) m. KermiClean | glanszilv./helder | TXF50100181VPK | stuk | 2479,00 | 284 1 |
| 0984441 | 100x200cm -50 | matzilv./helder | TXF50100201AK | stuk | 2006,00 | 284 1 | |
| 0984448 | 100x200cm -50 | glanszilv./helder | TXF50100201VAK | stuk | 2428,00 | 284 1 | |
| 0984443 | 100x200cm (50) m. KermiClean | matzilv./helder | TXF50100201PK | stuk | 2279,00 | 284 1 | |
| 0984449 | 100x200cm (50) m. KermiClean | glanszilv./helder | TXF50100201VPK | stuk | 2700,00 | 284 1 | |

| Art.nr | Specificaties | Kleur | Lev.nr | Ehd | Prijs | Grp | CC |
|------------------------|--------------------------------|-------------------|----------------|------|--------|-----|----|
| Kermi Toca-XP | | | | | | | |
| zijwand verkort | | | | | | | |
| 0984456 | 80x160cm rechts | matzilv./helder | TXTVR080161AK | stuk | 505,00 | 284 | 1 |
| 0984458 | 80x160cm rechts | glanszilv./helder | TXTVR080161VAK | stuk | 610,00 | 284 | 1 |
| 0984457 | 80x160cm rechts m. KermiClean | matzilv./helder | TXTVR080161PK | stuk | 658,00 | 284 | 1 |
| 0984459 | 80x160cm rechts m. KermiClean | glanszilv./helder | TXTVR080161VPK | stuk | 763,00 | 284 | 1 |
| 0986970 | 80x160cm links | matzilv./helder | TXTVL080161AK | stuk | 505,00 | 284 | 1 |
| 0986972 | 80x160cm links | glanszilv./helder | TXTVL080161VAK | stuk | 610,00 | 284 | 1 |
| 0986971 | 80x160cm links m. KermiClean | matzilv./helder | TXTVL080161PK | stuk | 658,00 | 284 | 1 |
| 0986973 | 80x160cm links m. KermiClean | glanszilv./helder | TXTVL080161VPK | stuk | 763,00 | 284 | 1 |
| 0984468 | 80x175cm rechts | matzilv./helder | TXTVR080171AK | stuk | 555,00 | 284 | 1 |
| 0984471 | 80x175cm rechts | glanszilv./helder | TXTVR080171VAK | stuk | 672,00 | 284 | 1 |
| 0984470 | 80x175cm rechts m. KermiClean | matzilv./helder | TXTVR080171PK | stuk | 708,00 | 284 | 1 |
| 0984472 | 80x175cm rechts m. KermiClean | glanszilv./helder | TXTVR080171VPK | stuk | 825,00 | 284 | 1 |
| 0987027 | 80x175cm links | matzilv./helder | TXTVL080171AK | stuk | 555,00 | 284 | 1 |
| 0987030 | 80x175cm links | glanszilv./helder | TXTVL080171VAK | stuk | 672,00 | 284 | 1 |
| 0987028 | 80x175cm links m. KermiClean | matzilv./helder | TXTVL080171PK | stuk | 708,00 | 284 | 1 |
| 0987031 | 80x175cm links m. KermiClean | glanszilv./helder | TXTVL080171VPK | stuk | 825,00 | 284 | 1 |
| 0984460 | 90x160cm rechts | matzilv./helder | TXTVR090161AK | stuk | 520,00 | 284 | 1 |
| 0984462 | 90x160cm rechts | glanszilv./helder | TXTVR090161VAK | stuk | 630,00 | 284 | 1 |
| 0984461 | 90x160cm rechts m. KermiClean | matzilv./helder | TXTVR090161PK | stuk | 673,00 | 284 | 1 |
| 0984463 | 90x160cm rechts m. KermiClean | glanszilv./helder | TXTVR090161VPK | stuk | 783,00 | 284 | 1 |
| 0986974 | 90x160cm links | matzilv./helder | TXTVL090161AK | stuk | 520,00 | 284 | 1 |
| 0986993 | 90x160cm links | glanszilv./helder | TXTVL090161VAK | stuk | 630,00 | 284 | 1 |
| 0986975 | 90x160cm links m. KermiClean | matzilv./helder | TXTVL090161PK | stuk | 673,00 | 284 | 1 |
| 0986995 | 90x160cm links m. KermiClean | glanszilv./helder | TXTVL090161VPK | stuk | 783,00 | 284 | 1 |
| 0984473 | 90x175cm rechts | matzilv./helder | TXTVR090171AK | stuk | 572,00 | 284 | 1 |
| 0984475 | 90x175cm rechts | glanszilv./helder | TXTVR090171VAK | stuk | 692,00 | 284 | 1 |
| 0984474 | 90x175cm rechts m. KermiClean | matzilv./helder | TXTVR090171PK | stuk | 725,00 | 284 | 1 |
| 0984476 | 90x175cm rechts m. KermiClean | glanszilv./helder | TXTVR090171VPK | stuk | 845,00 | 284 | 1 |
| 0987032 | 90x175cm links | matzilv./helder | TXTVL090171AK | stuk | 572,00 | 284 | 1 |
| 0987035 | 90x175cm links | glanszilv./helder | TXTVL090171VAK | stuk | 692,00 | 284 | 1 |
| 0987033 | 90x175cm links m. KermiClean | matzilv./helder | TXTVL090171PK | stuk | 725,00 | 284 | 1 |
| 0987036 | 90x175cm links m. KermiClean | glanszilv./helder | TXTVL090171VPK | stuk | 845,00 | 284 | 1 |
| 0984464 | 100x160cm rechts | matzilv./helder | TXTVR100161AK | stuk | 598,00 | 284 | 1 |
| 0984466 | 100x160cm rechts | glanszilv./helder | TXTVR100161VAK | stuk | 724,00 | 284 | 1 |
| 0984465 | 100x160cm rechts m. KermiClean | matzilv./helder | TXTVR100161PK | stuk | 751,00 | 284 | 1 |
| 0984467 | 100x160cm rechts m. KermiClean | glanszilv./helder | TXTVR100161VPK | stuk | 877,00 | 284 | 1 |
| 0986996 | 100x160cm links | matzilv./helder | TXTVL100161AK | stuk | 598,00 | 284 | 1 |
| 0986998 | 100x160cm links | glanszilv./helder | TXTVL100161VAK | stuk | 724,00 | 284 | 1 |
| 0986997 | 100x160cm links m. KermiClean | matzilv./helder | TXTVL100161PK | stuk | 751,00 | 284 | 1 |
| 0987017 | 100x160cm links m. KermiClean | glanszilv./helder | TXTVL100161VPK | stuk | 877,00 | 284 | 1 |
| 0986632 | 100x175cm rechts | matzilv./helder | TXTVR100171AK | stuk | 659,00 | 284 | 1 |
| 0986634 | 100x175cm rechts | glanszilv./helder | TXTVR100171VAK | stuk | 796,00 | 284 | 1 |
| 0986633 | 100x175cm rechts m. KermiClean | matzilv./helder | TXTVR100171PK | stuk | 811,00 | 284 | 1 |
| 0986635 | 100x175cm rechts m. KermiClean | glanszilv./helder | TXTVR100171VPK | stuk | 949,00 | 284 | 1 |
| 0987037 | 100x175cm links | matzilv./helder | TXTVL100171AK | stuk | 659,00 | 284 | 1 |
| 0987039 | 100x175cm links | glanszilv./helder | TXTVL100171VAK | stuk | 796,00 | 284 | 1 |
| 0987038 | 100x175cm links m. KermiClean | matzilv./helder | TXTVL100171PK | stuk | 811,00 | 284 | 1 |
| 0987040 | 100x175cm links m. KermiClean | glanszilv./helder | TXTVL100171VPK | stuk | 949,00 | 284 | 1 |



Sanitair producten

Baden /
douchebakken /
stoomcabines

Kranen

Douchegarnituur

Accessoires en
spiegels**Douchewanden**Toebehoren &
afvoerenSpoel- &
installatiesystemenBadkamermeubelen
en toiletkastenGootstenen en
wastroggen

Utiliteit

| Art.nr | Specificaties | Kleur | Lev.nr | Ehd | Prijs | Grp | CC |
|---|---------------|--------------------------------|-------------------|---------------|-------|--------|-------|
| Kermi Toca-XP | | | | | | | |
| zijwand | | | | | | | |
| Sanitair producten | 0986803 | 80x185cm rechts | matzilv./helder | TXTWR080181AK | stuk | 520,00 | 284 1 |
| | 0986805 | 80x185cm rechts | glanszilv./helder | TXTWR08018VAK | stuk | 630,00 | 284 1 |
| | 0986804 | 80x185cm rechts m. KermiClean | matzilv./helder | TXTWR080181PK | stuk | 673,00 | 284 1 |
| | 0986806 | 80x185cm rechts m. KermiClean | glanszilv./helder | TXTWR08018VPK | stuk | 783,00 | 284 1 |
| Baden / douchebakken / stoomcabines | 0987041 | 80x185cm links | matzilv./helder | TXTWL080181AK | stuk | 520,00 | 284 1 |
| | 0987044 | 80x185cm links | glanszilv./helder | TXTWL08018VAK | stuk | 630,00 | 284 1 |
| | 0987043 | 80x185cm links m. KermiClean | matzilv./helder | TXTWL080181PK | stuk | 673,00 | 284 1 |
| | 0987045 | 80x185cm links m. KermiClean | glanszilv./helder | TXTWL08018VPK | stuk | 783,00 | 284 1 |
| Kranen | 0981171 | 80x200cm rechts | matzilv./helder | TXTWR080201AK | stuk | 555,00 | 284 1 |
| | 0981173 | 80x200cm rechts | glanszilv./helder | TXTWR08020VAK | stuk | 672,00 | 284 1 |
| | 0981172 | 80x200cm rechts m. KermiClean | matzilv./helder | TXTWR080201PK | stuk | 708,00 | 284 1 |
| | 0981174 | 80x200cm rechts m. KermiClean | glanszilv./helder | TXTWR08020VPK | stuk | 825,00 | 284 1 |
| Douchegarnituur | 0986934 | 80x200cm links | matzilv./helder | TXTWL080201AK | stuk | 555,00 | 284 1 |
| | 0986936 | 80x200cm links | glanszilv./helder | TXTWL08020VAK | stuk | 672,00 | 284 1 |
| | 0986935 | 80x200cm links m. KermiClean | matzilv./helder | TXTWL080201PK | stuk | 708,00 | 284 1 |
| | 0986937 | 80x200cm links m. KermiClean | glanszilv./helder | TXTWL08020VPK | stuk | 825,00 | 284 1 |
| Accessoires en spiegels | 0986807 | 90x185cm rechts | matzilv./helder | TXTWR090181AK | stuk | 520,00 | 284 1 |
| | 0986809 | 90x185cm rechts | glanszilv./helder | TXTWR09018VAK | stuk | 630,00 | 284 1 |
| | 0986808 | 90x185cm rechts m. KermiClean | matzilv./helder | TXTWR090181PK | stuk | 673,00 | 284 1 |
| | 0986810 | 90x185cm rechts m. KermiClean | glanszilv./helder | TXTWR09018VPK | stuk | 783,00 | 284 1 |
| Douchewanden | 0987046 | 90x185cm links | matzilv./helder | TXTWL090181AK | stuk | 520,00 | 284 1 |
| | 0987052 | 90x185cm links | glanszilv./helder | TXTWL09018VAK | stuk | 630,00 | 284 1 |
| | 0987047 | 90x185cm links m. KermiClean | matzilv./helder | TXTWL090181PK | stuk | 673,00 | 284 1 |
| | 0987053 | 90x185cm links m. KermiClean | glanszilv./helder | TXTWL09018VPK | stuk | 783,00 | 284 1 |
| Toebehoren & afvoeren | 0981175 | 90x200cm rechts | matzilv./helder | TXTWR090201AK | stuk | 572,00 | 284 1 |
| | 0981177 | 90x200cm rechts | glanszilv./helder | TXTWR09020VAK | stuk | 692,00 | 284 1 |
| | 0981176 | 90x200cm rechts m. KermiClean | matzilv./helder | TXTWR090201PK | stuk | 725,00 | 284 1 |
| | 0981178 | 90x200cm rechts m. KermiClean | glanszilv./helder | TXTWR09020VPK | stuk | 845,00 | 284 1 |
| Spoel- & installatiesystemen | 0986938 | 90x200cm links | matzilv./helder | TXTWL090201AK | stuk | 572,00 | 284 1 |
| | 0986940 | 90x200cm links | glanszilv./helder | TXTWL09020VAK | stuk | 692,00 | 284 1 |
| | 0986939 | 90x200cm links m. KermiClean | matzilv./helder | TXTWL090201PK | stuk | 725,00 | 284 1 |
| | 0986942 | 90x200cm links m. KermiClean | glanszilv./helder | TXTWL09020VPK | stuk | 845,00 | 284 1 |
| Badkamermeubelen en toiletkasten | 0986811 | 100x185cm rechts | matzilv./helder | TXTWR100181AK | stuk | 598,00 | 284 1 |
| | 0986813 | 100x185cm rechts | glanszilv./helder | TXTWR10018VAK | stuk | 724,00 | 284 1 |
| | 0986812 | 100x185cm rechts m. KermiClean | matzilv./helder | TXTWR100181PK | stuk | 751,00 | 284 1 |
| | 0986814 | 100x185cm rechts m. KermiClean | glanszilv./helder | TXTWR10018VPK | stuk | 877,00 | 284 1 |
| Gootstenen en wastroggen | 0987054 | 100x185cm links | matzilv./helder | TXTWL100181AK | stuk | 598,00 | 284 1 |
| | 0987056 | 100x185cm links | glanszilv./helder | TXTWL10018VAK | stuk | 724,00 | 284 1 |
| | 0987055 | 100x185cm links m. KermiClean | matzilv./helder | TXTWL100181PK | stuk | 751,00 | 284 1 |
| | 0987057 | 100x185cm links m. KermiClean | glanszilv./helder | TXTWL10018VPK | stuk | 877,00 | 284 1 |
| Utiliteit | 0981179 | 100x200cm rechts | matzilv./helder | TXTWR100201AK | stuk | 659,00 | 284 1 |
| | 0981181 | 100x200cm rechts | glanszilv./helder | TXTWR10020VAK | stuk | 796,00 | 284 1 |
| | 0981180 | 100x200cm rechts m. KermiClean | matzilv./helder | TXTWR100201PK | stuk | 811,00 | 284 1 |
| | 0981182 | 100x200cm rechts m. KermiClean | glanszilv./helder | TXTWR10020VPK | stuk | 949,00 | 284 1 |
| | 0986943 | 100x200cm links | matzilv./helder | TXTWL100201AK | stuk | 659,00 | 284 1 |
| | 0986946 | 100x200cm links | glanszilv./helder | TXTWL10020VAK | stuk | 796,00 | 284 1 |
| | 0986944 | 100x200cm links m. KermiClean | matzilv./helder | TXTWL100201PK | stuk | 811,00 | 284 1 |
| | 0986969 | 100x200cm links m. KermiClean | glanszilv./helder | TXTWL10020VPK | stuk | 949,00 | 284 1 |

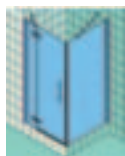

Kermi Vario 2000

| | | | | | | | |
|----------------------------|-----------|---------------|-----------------|--------------|------|--------|-------|
| badklapwand 2-delig | | | | | | | |
| 0985376 | 110x140cm | | matzilv./helder | V2FW2060141A | stuk | 543,00 | 284 1 |
| 0985384 | 110x140cm | | wit/helder | V2FW2060142A | stuk | 661,00 | 284 1 |
| 0985392 | 110x140cm | | perg./helder | V2FW206014FA | stuk | 661,00 | 284 1 |
| 0971391 | 110x140cm | m. KermiClean | matzilv./helder | V2FW2060141P | stuk | 688,00 | 284 1 |
| 0971405 | 110x140cm | m. KermiClean | wit/helder | V2FW2060142P | stuk | 806,00 | 284 1 |
| 0971413 | 110x140cm | m. KermiClean | perg./helder | V2FW206014FP | stuk | 806,00 | 284 1 |

badklapwand 3-delig

| | | | | | | | |
|---------|-----------|--|-----------------|--------------|------|--------|-------|
| 0985341 | 140x140cm | | matzilver/parel | V2FW30501412 | stuk | 518,00 | 284 1 |
| 0985368 | 140x140cm | | wit/parel | V2FW30501422 | stuk | 674,00 | 284 1 |

| Art.nr | Specificaties | Kleur | Lev.nr | Ehd | Prijs | Grp | CC | |
|----------------------------|---------------|---------------|------------------|--------------|--------|--------|-----|---|
| Kermi Vario 2000 | | | | | | | | |
| badklapwand 1-delig | | | | | | | | |
| 0996653 | 75cm | wit/helder | V2FW1065142A | stuk | 396,00 | 284 | 1 | |
| 0996661 | 75cm | zilver/helder | V2FW1065141A | stuk | 324,00 | 284 | 1 | |
| 0996688 | 75cm | wit/arena | V2FW1065142N | stuk | 396,00 | 284 | 1 | |
| 0996696 | 75cm | zilver/arena | V2FW1065141N | stuk | 324,00 | 284 | 1 | |
| 0971359 | 75cm | m. KermiClean | matzilver/helder | V2FW1065141P | stuk | 470,00 | 284 | 1 |
| 0971367 | 75cm | m. KermiClean | wit/helder | V2FW1065142P | stuk | 542,00 | 284 | 1 |
| 0996718 | 80cm | | wit/helder | V2FW1070142A | stuk | 400,00 | 284 | 1 |
| 0996726 | 80cm | | zilver/helder | V2FW1070141A | stuk | 327,00 | 284 | 1 |
| 0996734 | 80cm | | wit/arena | V2FW1070142N | stuk | 400,00 | 284 | 1 |
| 0996742 | 80cm | | zilver/arena | V2FW1070141N | stuk | 327,00 | 284 | 1 |
| 0971375 | 80cm | m. KermiClean | matzilver/helder | V2FW1070141P | stuk | 473,00 | 284 | 1 |
| 0971383 | 80cm | m. KermiClean | wit/helder glas | V2FW1070142P | stuk | 546,00 | 284 | 1 |



Sanitair producten

Baden /
douchebakken /
stoomcabines

Kranen

Douchegarnituur

Accessoires en
spiegels**Douchewanden**Toebehoren &
afvoerenSpoel- &
installatiesystemenBadkamermeubelen
en toiletkastenGootstenen en
wastroggen

Utiliteit



UW EIGEN -WALK-IN- DOUCHE SENSATIE.

De badkamer staat in het middelpunt van uw woongenot, vrijelijk douchen zonder belemmeringen geeft een heerlijk frisse start in de dag. Geen wonder dat u juist hier uw bijzondere en persoonlijke voorkeur wilt realiseren, dat kan met KERMI WALK-IN.

Geweldig transparant met glanzende profielen of uitgevoerd met decorglas, flexibel in haar maatvoering en eenvoudig te plaatsen. Vervaardigd uit hoogwaardige materialen met een fijne afwerking. Geheel vrij in de ruimte of als scheidingswand. Walk-In geeft de juiste majestueuze oplossing. Vraag uw groothandel naar de mogelijkheden of om de brochure met het complete programma doucheschermen. www.kermi.nl, info@kermi.com.



reddot design award
winner 2006



KERMI[®]



| Art.nr | Specificaties | Kleur | Lev.nr | Ehd | Prijs | Grp | CC |
|---|-------------------------|-------------------|---------------|------|---------|-----|----|
| Kermi Walk-In | | | | | | | |
| Free douchewand vrijstaand m. 2 plafondsteunen | | | | | | | |
| 0984834 | 99x200cm | matzilver/helder | XXWIF098201AK | stuk | 1161,00 | 284 | 1 |
| 0984835 | 99x200cm | hoogzilver/helder | XXWIF09820VAK | stuk | 1319,00 | 284 | 1 |
| 0984836 | 99x200cm m. KermiClean | matzilver/helder | XXWIF098201PK | stuk | 1314,00 | 284 | 1 |
| 0984837 | 99x200cm m. KermiClean | hoogzilver/helder | XXWIF09820VPK | stuk | 1471,00 | 284 | 1 |
| 0984838 | 109x200cm | matzilver/helder | XXWIF108201AK | stuk | 1187,00 | 284 | 1 |
| 0984839 | 109x200cm | hoogzilver/helder | XXWIF10820VAK | stuk | 1345,00 | 284 | 1 |
| 0984840 | 109x200cm m. KermiClean | matzilver/helder | XXWIF108201PK | stuk | 1340,00 | 284 | 1 |
| 0984842 | 109x200cm m. KermiClean | hoogzilver/helder | XXWIF10820VPK | stuk | 1498,00 | 284 | 1 |
| 0984843 | 119x200cm | matzilver/helder | XXWIF118201AK | stuk | 1213,00 | 284 | 1 |
| 0984844 | 119x200cm | hoogzilver/helder | XXWIF11820VAK | stuk | 1372,00 | 284 | 1 |
| 0984845 | 119x200cm m. KermiClean | matzilver/helder | XXWIF118201PK | stuk | 1366,00 | 284 | 1 |
| 0984846 | 119x200cm m. KermiClean | hoogzilver/helder | XXWIF11820VPK | stuk | 1525,00 | 284 | 1 |
| 0984847 | 129x200cm | matzilver/helder | XXWIF128201AK | stuk | 1240,00 | 284 | 1 |
| 0984848 | 129x200cm | hoogzilver/helder | XXWIF12820VAK | stuk | 1399,00 | 284 | 1 |
| 0984849 | 129x200cm m. KermiClean | matzilver/helder | XXWIF128201PK | stuk | 1392,00 | 284 | 1 |
| 0984850 | 129x200cm m. KermiClean | hoogzilver/helder | XXWIF12820VPK | stuk | 1551,00 | 284 | 1 |
| 0984851 | 139x200cm | matzilver/helder | XXWIF138201AK | stuk | 1266,00 | 284 | 1 |
| 0984852 | 139x200cm | hoogzilver/helder | XXWIF13820VAK | stuk | 1424,00 | 284 | 1 |
| 0984853 | 139x200cm m. KermiClean | matzilver/helder | XXWIF138201PK | stuk | 1419,00 | 284 | 1 |
| 0984854 | 139x200cm m. KermiClean | hoogzilver/helder | XXWIF13820VPK | stuk | 1577,00 | 284 | 1 |
| 0984855 | 149x200cm | matzilver/helder | XXWIF148201AK | stuk | 1293,00 | 284 | 1 |
| 0984856 | 149x200cm | hoogzilver/helder | XXWIF14820VAK | stuk | 1451,00 | 284 | 1 |
| 0984857 | 149x200cm m. KermiClean | matzilver/helder | XXWIF148201PK | stuk | 1446,00 | 284 | 1 |
| 0984858 | 149x200cm m. KermiClean | hoogzilver/helder | XXWIF14820VPK | stuk | 1604,00 | 284 | 1 |
| 0984859 | 159x200cm | matzilver/helder | XXWIF158201AK | stuk | 1319,00 | 284 | 1 |
| 0984860 | 159x200cm | hoogzilver/helder | XXWIF15820VAK | stuk | 1478,00 | 284 | 1 |
| 0984862 | 159x200cm m. KermiClean | matzilver/helder | XXWIF158201PK | stuk | 1471,00 | 284 | 1 |
| 0984863 | 159x200cm m. KermiClean | hoogzilver/helder | XXWIF15820VPK | stuk | 1630,00 | 284 | 1 |
| 0984864 | 169x200cm | matzilver/helder | XXWIF168201AK | stuk | 1345,00 | 284 | 1 |
| 0984865 | 169x200cm | hoogzilver/helder | XXWIF16820VAK | stuk | 1504,00 | 284 | 1 |
| 0984866 | 169x200cm m. KermiClean | matzilver/helder | XXWIF168201PK | stuk | 1498,00 | 284 | 1 |
| 0984870 | 169x200cm m. KermiClean | hoogzilver/helder | XXWIF16820VPK | stuk | 1657,00 | 284 | 1 |
| 0984871 | 179x200cm | matzilver/helder | XXWIF178201AK | stuk | 1372,00 | 284 | 1 |
| 0984872 | 179x200cm | hoogzilver/helder | XXWIF17820VAK | stuk | 1530,00 | 284 | 1 |
| 0984873 | 179x200cm m. KermiClean | matzilver/helder | XXWIF178201PK | stuk | 1525,00 | 284 | 1 |
| 0984874 | 179x200cm m. KermiClean | hoogzilver/helder | XXWIF17820VPK | stuk | 1683,00 | 284 | 1 |

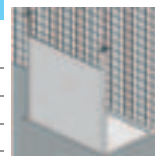

Sanitair producten

Baden /
douchebakken /
stoomcabines

Kranen

Douchegarnituur

Accessoires en
spiegels**Douchewanden**Toebehoren &
afvoerenSpoel- &
installatiesystemenBadkamermeubelen
en toiletkastenGootstenen en
wastroggen

Utiliteit

| | Art.nr | Specificaties | Kleur | Lev.nr | Ehd | Prijs | Grp | CC |
|---|--|-------------------------|-------------------|---------------|------|---------|-----|----|
| | Kermi Walk-In | | | | | | | |
| | Wall douchewand muurmontage m. plafondsteun | | | | | | | |
| Sanitair producten | 0984900 | 70x200cm | matzilver/helder | XXWIW068201AK | stuk | 977,00 | 284 | 1 |
| | 0984901 | 70x200cm | hoogzilver/helder | XXWIW06820VAK | stuk | 1071,00 | 284 | 1 |
| Baden / douchebakken / stoomcabines | 0984902 | 70x200cm m. KermiClean | matzilver/helder | XXWIW068201PK | stuk | 1130,00 | 284 | 1 |
| | 0984903 | 70x200cm m. KermiClean | hoogzilver/helder | XXWIW06820VPK | stuk | 1223,00 | 284 | 1 |
| | 0984904 | 75x200cm | matzilver/helder | XXWIW073201AK | stuk | 990,00 | 284 | 1 |
| | 0984905 | 75x200cm | hoogzilver/helder | XXWIW07320VAK | stuk | 1084,00 | 284 | 1 |
| Kranen | 0984937 | 75x200cm m. KermiClean | matzilver/helder | XXWIW073201PK | stuk | 1142,00 | 284 | 1 |
| | 0984938 | 75x200cm m. KermiClean | hoogzilver/helder | XXWIW07320VPK | stuk | 1237,00 | 284 | 1 |
| | 0984939 | 80x200cm | matzilver/helder | XXWIW078201AK | stuk | 1002,00 | 284 | 1 |
| | 0984940 | 80x200cm | hoogzilver/helder | XXWIW07820VAK | stuk | 1096,00 | 284 | 1 |
| Douchegarnituur | 0984941 | 80x200cm m. KermiClean | matzilver/helder | XXWIW078201PK | stuk | 1155,00 | 284 | 1 |
| | 0984942 | 80x200cm m. KermiClean | hoogzilver/helder | XXWIW07820VPK | stuk | 1249,00 | 284 | 1 |
| | 0984943 | 90x200cm | matzilver/helder | XXWIW088201AK | stuk | 1029,00 | 284 | 1 |
| | 0984944 | 90x200cm | hoogzilver/helder | XXWIW08820VAK | stuk | 1123,00 | 284 | 1 |
| Accessoires en spiegels | 0984945 | 90x200cm m. KermiClean | matzilver/helder | XXWIW088201PK | stuk | 1181,00 | 284 | 1 |
| | 0984946 | 90x200cm m. KermiClean | hoogzilver/helder | XXWIW08820VPK | stuk | 1276,00 | 284 | 1 |
| | 0984947 | 100x200cm | matzilver/helder | XXWIW098201AK | stuk | 1055,00 | 284 | 1 |
| | 0984948 | 100x200cm | hoogzilver/helder | XXWIW09820VAK | stuk | 1150,00 | 284 | 1 |
| Douchewanden | 0984950 | 100x200cm m. KermiClean | matzilver/helder | XXWIW098201PK | stuk | 1208,00 | 284 | 1 |
| | 0984951 | 100x200cm m. KermiClean | hoogzilver/helder | XXWIW09820VPK | stuk | 1302,00 | 284 | 1 |
| | 0984952 | 110x200cm | matzilver/helder | XXWIW108201AK | stuk | 1082,00 | 284 | 1 |
| | 0984953 | 110x200cm | hoogzilver/helder | XXWIW10820VAK | stuk | 1175,00 | 284 | 1 |
| | 0984954 | 110x200cm m. KermiClean | matzilver/helder | XXWIW108201PK | stuk | 1235,00 | 284 | 1 |
| | 0984955 | 110x200cm m. KermiClean | hoogzilver/helder | XXWIW10820VPK | stuk | 1328,00 | 284 | 1 |
| | 0984956 | 120x200cm | matzilver/helder | XXWIW118201AK | stuk | 1107,00 | 284 | 1 |
| | 0984957 | 120x200cm | hoogzilver/helder | XXWIW11820VAK | stuk | 1202,00 | 284 | 1 |
| | 0984958 | 120x200cm m. KermiClean | matzilver/helder | XXWIW118201PK | stuk | 1260,00 | 284 | 1 |
| | 0984959 | 120x200cm m. KermiClean | hoogzilver/helder | XXWIW11820VPK | stuk | 1355,00 | 284 | 1 |
| Toebehoren & afvoeren | 0984960 | 130x200cm | matzilver/helder | XXWIW128201AK | stuk | 1134,00 | 284 | 1 |
| | 0984961 | 130x200cm | hoogzilver/helder | XXWIW12820VAK | stuk | 1228,00 | 284 | 1 |
| Spoel- & installatiesystemen | 0984962 | 130x200cm m. KermiClean | matzilver/helder | XXWIW128201PK | stuk | 1287,00 | 284 | 1 |
| | 0984983 | 130x200cm m. KermiClean | hoogzilver/helder | XXWIW12820VPK | stuk | 1381,00 | 284 | 1 |
| | 0984984 | 140x200cm | matzilver/helder | XXWIW138201AK | stuk | 1161,00 | 284 | 1 |
| | 0984985 | 140x200cm | hoogzilver/helder | XXWIW13820VAK | stuk | 1255,00 | 284 | 1 |
| Badkamermeubelen en toiletkasten | 0984986 | 140x200cm m. KermiClean | matzilver/helder | XXWIW138201PK | stuk | 1314,00 | 284 | 1 |
| | 0984987 | 140x200cm m. KermiClean | hoogzilver/helder | XXWIW13820VPK | stuk | 1408,00 | 284 | 1 |
| | 0984988 | 150x200cm | matzilver/helder | XXWIW148201AK | stuk | 1187,00 | 284 | 1 |
| Gootstenen en wastroggen | 0984989 | 150x200cm | hoogzilver/helder | XXWIW14820VAK | stuk | 1281,00 | 284 | 1 |
| | 0984990 | 150x200cm m. KermiClean | matzilver/helder | XXWIW148201PK | stuk | 1340,00 | 284 | 1 |
| | 0984991 | 150x200cm m. KermiClean | hoogzilver/helder | XXWIW14820VPK | stuk | 1433,00 | 284 | 1 |
| | 0984994 | 160x200cm | matzilver/helder | XXWIW158201AK | stuk | 1213,00 | 284 | 1 |
| Utiliteit | 0984995 | 160x200cm | hoogzilver/helder | XXWIW15820VAK | stuk | 1307,00 | 284 | 1 |
| | 0984996 | 160x200cm m. KermiClean | matzilver/helder | XXWIW158201PK | stuk | 1366,00 | 284 | 1 |
| | 0984998 | 160x200cm m. KermiClean | hoogzilver/helder | XXWIW15820VPK | stuk | 1460,00 | 284 | 1 |
| | 0984999 | 170x200cm | matzilver/helder | XXWIW168201AK | stuk | 1240,00 | 284 | 1 |
| | 0985035 | 170x200cm | hoogzilver/helder | XXWIW16820VAK | stuk | 1334,00 | 284 | 1 |
| | 0985024 | 170x200cm m. KermiClean | matzilver/helder | XXWIW168201PK | stuk | 1392,00 | 284 | 1 |
| | 0985026 | 170x200cm m. KermiClean | hoogzilver/helder | XXWIW16820VPK | stuk | 1487,00 | 284 | 1 |
| | 0985027 | 180x200cm | matzilver/helder | XXWIW178201AK | stuk | 1266,00 | 284 | 1 |
| | 0985028 | 180x200cm | hoogzilver/helder | XXWIW17820VAK | stuk | 1361,00 | 284 | 1 |
| | 0985029 | 180x200cm m. KermiClean | matzilver/helder | XXWIW178201PK | stuk | 1419,00 | 284 | 1 |
| | 0985030 | 180x200cm m. KermiClean | hoogzilver/helder | XXWIW17820VPK | stuk | 1513,00 | 284 | 1 |

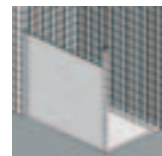

| Art.nr | Specificaties | Kleur | Lev.nr | Ehd | Prijs | Grp | CC |
|---|------------------------|-------------------|---------------|------|--------|-----|----|
| Kermi Walk-In | | | | | | | |
| Angle douchewand m. combiprofiel montage onder hoek 90°-270° | | | | | | | |
| 0984875 | 30x200cm | matzilver/helder | XXWIA030201AK | stuk | 431,00 | 284 | 1 |
| 0984877 | 30x200cm | hoogzilver/helder | XXWIA03020VAK | stuk | 446,00 | 284 | 1 |
| 0984878 | 30x200cm m. KermiClean | matzilver/helder | XXWIA030201PK | stuk | 552,00 | 284 | 1 |
| 0984879 | 30x200cm m. KermiClean | hoogzilver/helder | XXWIA03020VPK | stuk | 567,00 | 284 | 1 |
| 0984880 | 35x200cm | matzilver/helder | XXWIA035201AK | stuk | 444,00 | 284 | 1 |
| 0984881 | 35x200cm | hoogzilver/helder | XXWIA03520VAK | stuk | 459,00 | 284 | 1 |
| 0984882 | 35x200cm m. KermiClean | matzilver/helder | XXWIA035201PK | stuk | 565,00 | 284 | 1 |
| 0984883 | 35x200cm m. KermiClean | hoogzilver/helder | XXWIA03520VPK | stuk | 580,00 | 284 | 1 |
| 0984885 | 40x200cm | matzilver/helder | XXWIA040201AK | stuk | 458,00 | 284 | 1 |
| 0984886 | 40x200cm | hoogzilver/helder | XXWIA04020VAK | stuk | 472,00 | 284 | 1 |
| 0984887 | 40x200cm m. KermiClean | matzilver/helder | XXWIA040201PK | stuk | 579,00 | 284 | 1 |
| 0984888 | 40x200cm m. KermiClean | hoogzilver/helder | XXWIA04020VPK | stuk | 593,00 | 284 | 1 |
| 0984889 | 45x200cm | matzilver/helder | XXWIA045201AK | stuk | 470,00 | 284 | 1 |
| 0984893 | 45x200cm | hoogzilver/helder | XXWIA04520VAK | stuk | 485,00 | 284 | 1 |
| 0984894 | 45x200cm m. KermiClean | matzilver/helder | XXWIA045201PK | stuk | 591,00 | 284 | 1 |
| 0984895 | 45x200cm m. KermiClean | hoogzilver/helder | XXWIA04520VPK | stuk | 606,00 | 284 | 1 |
| 0984896 | 50x200cm | matzilver/helder | XXWIA050201AK | stuk | 484,00 | 284 | 1 |
| 0984897 | 50x200cm | hoogzilver/helder | XXWIA05020VAK | stuk | 499,00 | 284 | 1 |
| 0984898 | 50x200cm m. KermiClean | matzilver/helder | XXWIA050201PK | stuk | 605,00 | 284 | 1 |
| 0984899 | 50x200cm m. KermiClean | hoogzilver/helder | XXWIA05020VPK | stuk | 620,00 | 284 | 1 |

Sanitair producten

Baden /
douchebakken /
stoomcabines

Kranen

Douchegarnituur

Accessoires en
spiegels

Douchewanden

Toebehoren &
afvoerenSpoel- &
installatiesystemenBadkamermeubelen
en toiletkastenGootstenen en
wastroggen

Utiliteit

| | Art.nr | Specificaties | Kleur | Lev.nr | Ehd | Prijs | Grp | CC |
|---|----------------------------|------------------|----------------|-------------|------|--------|-----|----|
| | Novellini Aurora | | | | | | | |
| | badklapwand 1-delig | | | | | | | |
| Sanitair producten | 0981795 | 70x150cm | chroom/helder | AURORA1701B | stuk | 182,00 | 288 | 1 |
| | 0981884 | 70x150cm | wit/helder | AURORA1701A | stuk | 164,00 | 288 | 1 |
| | 0982168 | 70x150cm | perg./helder | AURORA1701C | stuk | 164,00 | 288 | 1 |
| Baden / douchebakken / stoomcabines | 0981826 | 75x150cm | chroom/helder | AURORA1751B | stuk | 190,00 | 288 | 1 |
| | 0981788 | 75x150cm | wit/helder | AURORA1751A | stuk | 172,00 | 288 | 1 |
| | 0981818 | 75x150cm | perg./helder | AURORA1751C | stuk | 172,00 | 288 | 1 |
| | 0321132 | 80x150cm | matchr./helder | AURORA1801B | stuk | 199,00 | 288 | 1 |
| | 0981555 | 85x150cm | chroom/helder | AURORA1851B | stuk | 206,00 | 288 | 1 |
| Kranen | 0981709 | 85x150cm | wit/helder | AURORA1851A | stuk | 188,00 | 288 | 1 |
| | 0983710 | 85x150cm | perg./helder | AURORA1851C | stuk | 188,00 | 288 | 1 |
| | badklapwand 2-delig | | | | | | | |
| Douchegarnituur | 0981791 | 120x150cm links | chroom/helder | AURORA2S1B | stuk | 275,00 | 288 | 1 |
| | 0981793 | 120x150cm links | chroom/satin | AURORA2S4B | stuk | 275,00 | 288 | 1 |
| | 0980728 | 120x150cm links | wit/helder | AURORA2S1A | stuk | 250,00 | 288 | 1 |
| | 0987914 | 120x150cm links | wit/satin | AURORA2S4A | stuk | 250,00 | 288 | 1 |
| | 0982019 | 120x150cm links | perg./helder | AURORA2S1C | stuk | 250,00 | 288 | 1 |
| | 0982020 | 120x150cm links | perg./satijn | AURORA2S4C | stuk | 250,00 | 288 | 1 |
| | 0981794 | 120x150cm rechts | chroom/satin | AURORA2D4B | stuk | 275,00 | 288 | 1 |
| | 0982018 | 120x150cm rechts | chroom/helder | AURORA2D1B | stuk | 275,00 | 288 | 1 |
| Accessoires en spiegels | 0987891 | 120x150cm rechts | wit/helder | AURORA2D1A | stuk | 250,00 | 288 | 1 |
| | 0987913 | 120x150cm rechts | wit/satin | AURORA2D4A | stuk | 250,00 | 288 | 1 |
| | 0987905 | 120x150cm rechts | perg./helder | AURORA2D1C | stuk | 250,00 | 288 | 1 |
| Douchewanden | 0987921 | 120x150cm rechts | perg./satin | AURORA2D4C | stuk | 250,00 | 288 | 1 |
| Toebehoren & afvoeren | | | | | | | | |
| Spoel- & installatiesystemen | | | | | | | | |
| Badkamermeubelen en toiletkasten | | | | | | | | |
| Gootstenen en wastroggen | | | | | | | | |
| Utiliteit | | | | | | | | |

Novellini



Novellini Diffusion Benelux B.V.
Antennestraat 90 · 1322 AS ALMERE

T: 036-5350444 · F: 036-5366242
I: www.novellini.nl · E: info@novellini.nl

| | Art.nr | Specificaties | Kleur | Lev.nr | Ehd | Prijs | Grp | CC | |
|---|--|--|--------------|---------------|------------|--------|--------|-----|---|
| | Novellini Giada | | | | | | | | |
| | draaideur voor nis 1B | | | | | | | | |
| Sanitair producten | 0988308 | 87/90x195cm rechts | chrom/satin | GIADA1B87D4B | stuk | 419,00 | 288 | 1 | |
| | 0988286 | 87/90x195cm rechts | chrom/helder | GIADA1B87D1B | stuk | 419,00 | 288 | 1 | |
| Baden / douchebakken / stoomcabines | 0988227 | 87/90x195cm rechts | wit/satin | GIADA1B87D4A | stuk | 382,00 | 288 | 1 | |
| | 0988200 | 87/90x195cm rechts | wit/helder | GIADA1B87D1A | stuk | 382,00 | 288 | 1 | |
| | 0982062 | 87/90x195cm rechts | perg./satin | GIADA1B87D4C | stuk | 382,00 | 288 | 1 | |
| | 0988235 | 87/90x195cm rechts | perg./helder | GIADA1B87D1C | stuk | 382,00 | 288 | 1 | |
| | 0988294 | 87/90x195cm links | chrom/satin | GIADA1B87S4B | stuk | 419,00 | 288 | 1 | |
| | 0988278 | 87/90x195cm links | chrom/helder | GIADA1B87S1B | stuk | 419,00 | 288 | 1 | |
| Kranen | 0988219 | 87/90x195cm links | wit/satin | GIADA1B87S4A | stuk | 382,00 | 288 | 1 | |
| | 0988197 | 87/90x195cm links | wit/helder | GIADA1B87S1A | stuk | 382,00 | 288 | 1 | |
| | 0988243 | 87/90x195cm links | perg./satin | GIADA1B87S4C | stuk | 382,00 | 288 | 1 | |
| | 0982151 | 87/90x195cm links | perg./helder | GIADA1B87S1C | stuk | 382,00 | 288 | 1 | |
| | draaideur G | | | | | | | | |
| Douchegarnituur | 0982009 | 84/87x195cm rechts | chrom/helder | GIADA2G84LD1B | stuk | 344,00 | 288 | 1 | |
| | 0982001 | 84/87x195cm rechts | wit/helder | GIADA2G84LD1A | stuk | 313,00 | 288 | 1 | |
| | 0982004 | 84/87x195cm rechts | perg./helder | GIADA2G84LD1C | stuk | 313,00 | 288 | 1 | |
| | 0982010 | 84/87x195cm links | chrom/helder | GIADA2G84LS1B | stuk | 344,00 | 288 | 1 | |
| Accessoires en spiegels | 0982003 | 84/87x195cm links | wit/helder | GIADA2G84LS1A | stuk | 313,00 | 288 | 1 | |
| | 0982007 | 84/87x195cm links | perg./helder | GIADA2G84LS1C | stuk | 313,00 | 288 | 1 | |
| | klapdeur 2B | | | | | | | | |
| Douchewanden | 0988359 | 78/84x195cm | chrom/helder | GIADA2B781B | stuk | 540,00 | 288 | 1 | |
| | 0988367 | 78/84x195cm | chrom/satin | GIADA2B784B | stuk | 540,00 | 288 | 1 | |
| | 0988316 | 78/84x195cm | wit/helder | GIADA2B781A | stuk | 492,00 | 288 | 1 | |
| | 0988324 | 78/84x195cm | wit/satin | GIADA2B784A | stuk | 492,00 | 288 | 1 | |
| | 0988332 | 78/84x195cm | perg./helder | GIADA2B781C | stuk | 492,00 | 288 | 1 | |
| | 0988340 | 78/84x195cm | perg./satin | GIADA2B784C | stuk | 492,00 | 288 | 1 | |
| | 0988360 | 84/90x195cm | chrom/satin | GIADA2B844B | stuk | 540,00 | 288 | 1 | |
| | 0988413 | 84/90x195cm | chrom/helder | GIADA2B841B | stuk | 540,00 | 288 | 1 | |
| | 0988383 | 84/90x195cm | wit/satin | GIADA2B844A | stuk | 492,00 | 288 | 1 | |
| | 0988375 | 84/90x195cm | wit/helder | GIADA2B841A | stuk | 492,00 | 288 | 1 | |
| Toebehoren & afvoeren | 0988391 | 84/90x195cm | perg./helder | GIADA2B841C | stuk | 492,00 | 288 | 1 | |
| | 0988405 | 84/90x195cm | perg./satin | GIADA2B844C | stuk | 492,00 | 288 | 1 | |
| | | vaste wand F | | | | | | | |
| Badkamermeubelen en toiletkasten | 0982017 | 84/87x195cm | chrom/helder | GIADAF841B | stuk | 297,00 | 288 | 1 | |
| | 0982012 | 84/87x195cm | wit/helder | GIADAF841A | stuk | 271,00 | 288 | 1 | |
| | 0982013 | 84/87x195cm | perg./helder | GIADAF841C | stuk | 271,00 | 288 | 1 | |
| | douchecabine hoekinstap 2G m. draaideuren | | | | | | | | |
| Gootstenen en wastroggen | 0988510 | 84/87x195cm | chrom/helder | GIADA2G841B | stuk | 687,00 | 288 | 1 | |
| | 0988529 | 84/87x195cm | chrom/satin | GIADA2G844B | stuk | 687,00 | 288 | 1 | |
| | 0982091 | 84/87x195cm | wit/helder | GIADA2G841A | stuk | 626,00 | 288 | 1 | |
| | 0988499 | 84/87x195cm | wit/satin | GIADA2G844A | stuk | 626,00 | 288 | 1 | |
| | 0982063 | 84/87x195cm | perg./helder | GIADA2G841C | stuk | 626,00 | 288 | 1 | |
| | 0988502 | 84/87x195cm | perg./satin | GIADA2G844C | stuk | 626,00 | 288 | 1 | |
| | douchecabine kwart rond m. draaideuren | | | | | | | | |
| Utiliteit | 0981480 | 84/87x195 R90 | chrom/helder | GIADAR901B | stuk | 946,00 | 288 | 1 | |
| | 0988480 | 84/87x195 R90 | chrom/satin | GIADAR904B | stuk | 946,00 | 288 | 1 | |
| | 0982075 | 84/87x195 R90 | wit/helder | GIADAR901A | stuk | 860,00 | 288 | 1 | |
| | 0988448 | 84/87x195 R90 | wit/satin | GIADAR904A | stuk | 860,00 | 288 | 1 | |
| | 0988456 | 84/87x195 R90 | perg./helder | GIADAR901C | stuk | 860,00 | 288 | 1 | |
| | 0988464 | 84/87x195 R90 | perg./satin | GIADAR904C | stuk | 860,00 | 288 | 1 | |
| | 0982072 | 94/97x195 R100 | chrom/helder | GIADAR1001B | stuk | 946,00 | 288 | 1 | |
| | 0982066 | 94/97x195 R100 | chrom/satin | GIADAR1004B | stuk | 946,00 | 288 | 1 | |
| | 0982070 | 94/97x195 R100 | wit/helder | GIADAR1001A | stuk | 860,00 | 288 | 1 | |
| | 0982065 | 94/97x195 R100 | wit/satin | GIADAR1004A | stuk | 860,00 | 288 | 1 | |
| | 0982068 | 94/97x195 R100 | perg./helder | GIADAR1001C | stuk | 860,00 | 288 | 1 | |
| | 0982064 | 94/97x195 R100 | perg./satin | GIADAR1004C | stuk | 860,00 | 288 | 1 | |
| | | douchecabine vijfhoekig Pentagono m. klapdeuren | | | | | | | |
| | | 0988104 | 84/87x195cm | chrom/helder | GIADAP901B | stuk | 946,00 | 288 | 1 |
| 0982076 | | 84/87x195cm | wit/helder | GIADAP901A | stuk | 860,00 | 288 | 1 | |
| 0982078 | | 84/87x195cm | perg./helder | GIADAP901C | stuk | 860,00 | 288 | 1 | |
| 0988170 | | 94x94x195cm | chrom/helder | GIADAP1001B | stuk | 946,00 | 288 | 1 | |
| 0988138 | | 94x94x195cm | wit/helder | GIADAP1001A | stuk | 860,00 | 288 | 1 | |
| 0988154 | | 94x94x195cm | perg./helder | GIADAP1001C | stuk | 860,00 | 288 | 1 | |

| Art.nr | Specificaties | Kleur | Lev.nr | Ehd | Prijs | Grp | CC |
|--------|---------------|-------|--------|-----|-------|-----|----|
|--------|---------------|-------|--------|-----|-------|-----|----|

Novellini Jolly 2

2 douchecabine voor bad

| | | | | | | | |
|---------|----------|--------|------------|-------------|------|--------|-------|
| 1000594 | 75x160cm | links | wit/helder | JOLLY275S1A | stuk | 732,00 | 288 1 |
| 1000632 | 80x160cm | links | wit/helder | JOLLY280S1A | stuk | 759,00 | 288 1 |
| 1000608 | 75x160cm | rechts | wit/helder | JOLLY275D1A | stuk | 732,00 | 288 1 |
| 1000640 | 80x160cm | rechts | wit/helder | JOLLY280D1A | stuk | 759,00 | 288 1 |

Novellini King

Walk-In inloepdouche m. kolom voor hoek

| | | | | | | | |
|---------|------------|--------|--------------|--------------|------|---------|-------|
| 0980822 | 140x90x195 | links | chrom/helder | KINGW140CS1B | stuk | 2320,00 | 288 1 |
| 0980832 | 170x90x195 | links | chrom/helder | KINGW170CS1B | stuk | 2446,00 | 288 1 |
| 0980821 | 140x90x195 | rechts | chrom/helder | KINGW140CD1B | stuk | 2320,00 | 288 1 |
| 0980831 | 170x90x195 | rechts | chrom/helder | KINGW170CD1B | stuk | 2446,00 | 288 1 |

**Walk-In inloepdouche voor hoek**

| | | | | | | | |
|---------|------------|--------|--------------|-------------|------|---------|-------|
| 0980818 | 140x90x195 | links | chrom/helder | KINGW140S1B | stuk | 972,00 | 288 1 |
| 0980828 | 170x90x195 | links | chrom/helder | KINGW170S1B | stuk | 1097,00 | 288 1 |
| 0980817 | 140x90x195 | rechts | chrom/helder | KINGW140D1B | stuk | 972,00 | 288 1 |
| 0980827 | 170x90x195 | rechts | chrom/helder | KINGW170D1B | stuk | 1097,00 | 288 1 |

Walk-In douchebak voor inloepdouche

| | | | | | | | |
|---------|-------|--------|----------|-------------|------|--------|-------|
| 0980826 | 140cm | links | wit/hout | KING140PS30 | stuk | 441,00 | 288 1 |
| 0980836 | 170cm | links | wit/hout | KING170PS30 | stuk | 540,00 | 288 1 |
| 0980825 | 140cm | rechts | wit/hout | KING140PD30 | stuk | 441,00 | 288 1 |
| 0980835 | 170cm | rechts | wit/hout | KING170PD30 | stuk | 540,00 | 288 1 |

2P schuifdeur

| | | | | | | | |
|---------|-------------|--------|--------------|--------------|------|--------|-------|
| 0980868 | 102/108x190 | rechts | chrom/helder | KING2P102D1B | stuk | 471,00 | 288 1 |
| 0980869 | 102/108x190 | links | chrom/helder | KING2P102S1B | stuk | 471,00 | 288 1 |
| 0980870 | 108/114x190 | rechts | chrom/helder | KING2P108D1B | stuk | 486,00 | 288 1 |
| 0980871 | 108/114x190 | links | chrom/helder | KING2P108S1B | stuk | 486,00 | 288 1 |
| 0980872 | 114/120x190 | rechts | chrom/helder | KING2P114D1B | stuk | 501,00 | 288 1 |
| 0980873 | 114/120x190 | links | chrom/helder | KING2P114S1B | stuk | 501,00 | 288 1 |
| 0980866 | 96/102x190 | rechts | chrom/helder | KING2P96D1B | stuk | 456,00 | 288 1 |
| 0980867 | 96/102x190 | links | chrom/helder | KING2P96S1B | stuk | 456,00 | 288 1 |

**A hoekinstap m. twee schuifdeuren**

| | | | | | | | |
|---------|-----------|--|--------------|-----------|------|--------|-------|
| 0980838 | 75/75x190 | | chrom/helder | KINGA721B | stuk | 685,00 | 288 1 |
| 0980839 | 78/81x190 | | chrom/helder | KINGA781B | stuk | 705,00 | 288 1 |
| 0980840 | 87/90x190 | | chrom/helder | KINGA871B | stuk | 725,00 | 288 1 |

**F vaste wand voor G / S / 2P**

| | | | | | | | |
|---------|-----------|--|--------------|-----------|------|--------|-------|
| 0980852 | 69/72x190 | | chrom/helder | KINGF691B | stuk | 270,00 | 288 1 |
| 0980853 | 72/75x190 | | chrom/helder | KINGF721B | stuk | 285,00 | 288 1 |
| 0980854 | 75/78x190 | | chrom/helder | KINGF751B | stuk | 300,00 | 288 1 |
| 0980855 | 78/81x190 | | chrom/helder | KINGF781B | stuk | 315,00 | 288 1 |
| 0980856 | 84/87x190 | | chrom/helder | KINGF841B | stuk | 330,00 | 288 1 |
| 0980857 | 87/90x190 | | chrom/helder | KINGF871B | stuk | 345,00 | 288 1 |

**G draaideur**

| | | | | | | | |
|---------|-----------|--------|--------------|------------|------|--------|-------|
| 0980844 | 67/71x190 | rechts | chrom/helder | KINGG67D1B | stuk | 460,00 | 288 1 |
| 0980845 | 67/71x190 | links | chrom/helder | KINGG67S1B | stuk | 460,00 | 288 1 |
| 0980846 | 72/76x190 | rechts | chrom/helder | KINGG72D1B | stuk | 480,00 | 288 1 |
| 0980847 | 72/76x190 | links | chrom/helder | KINGG72S1B | stuk | 480,00 | 288 1 |
| 0980848 | 77/81x190 | rechts | chrom/helder | KINGG77D1B | stuk | 500,00 | 288 1 |
| 0980849 | 77/81x190 | links | chrom/helder | KINGG77S1B | stuk | 500,00 | 288 1 |
| 0980850 | 87/91x190 | rechts | chrom/helder | KINGG87D1B | stuk | 520,00 | 288 1 |
| 0980851 | 87/91x190 | links | chrom/helder | KINGG87S1B | stuk | 520,00 | 288 1 |

R douchecabine kwartrond m. 2 deuren

| | | | | | | | |
|---------|----------------|--|--------------|------------|------|--------|-------|
| 0980843 | 98.5/101.5x190 | | chrom/helder | KINGR1001B | stuk | 940,00 | 288 1 |
| 0980841 | 78.5/81.5x190 | | chrom/helder | KINGR801B | stuk | 880,00 | 288 1 |
| 0980842 | 88.5/91.5x190 | | chrom/helder | KINGR901B | stuk | 920,00 | 288 1 |



Sanitair producten

Baden /
douchebakken /
stoomcabines

Kranen

Douchegarnituur

Accessoires en
spiegels

Douchewanden

Toebehoren &
afvoerenSpoel- &
installatiesystemenBadkamermeubelen
en toiletkastenGootstenen en
wastroggen

Utiliteit

| | Art.nr | Specificaties | Kleur | Lev.nr | Ehd | Prijs | Grp | CC | |
|---|----------------------|------------------|----------------|----------------|-----------|--------|--------|-----|---|
| Novellini King | | | | | | | | | |
| S vouwdeur | | | | | | | | | |
| Sanitair producten | 0980858 | 67/71x190 rechts | chroom/helder | KINGS67D1B | stuk | 485,00 | 288 | 1 | |
| | 0980859 | 67/71x190 links | chroom/helder | KINGS67S1B | stuk | 485,00 | 288 | 1 | |
| | 0980860 | 72/76x190 rechts | chroom/helder | KINGS72D1B | stuk | 505,00 | 288 | 1 | |
| | 0980861 | 72/76x190 links | chroom/helder | KINGS72S1B | stuk | 505,00 | 288 | 1 | |
| Baden / douchebakken / stoomcabines | 0980862 | 77/81x190 rechts | chroom/helder | KINGS77D1B | stuk | 525,00 | 288 | 1 | |
| | 0980863 | 77/81x190 links | chroom/helder | KINGS77S1B | stuk | 525,00 | 288 | 1 | |
| | 0980864 | 87/91x190 rechts | chroom/helder | KINGS87D1B | stuk | 545,00 | 288 | 1 | |
| | 0980865 | 87/91x190 links | chroom/helder | KINGS87S1B | stuk | 545,00 | 288 | 1 | |
| Novellini Peter | | | | | | | | | |
| badklapwand 3-delig | | | | | | | | | |
| Kranen | 0984760 | 138x138cm | wit/helder | PETER1381F | stuk | 330,00 | 288 | 1 | |
| | 0984779 | 138x138cm | perg./helder | PETER1381C | stuk | 330,00 | 288 | 1 | |
| Novellini Star | | | | | | | | | |
| zijwand F90 | | | | | | | | | |
| Douchegarnituur | 0982133 | 84/90x185cm | wit/helder | STARFC841F | stuk | 216,00 | 288 | 1 | |
| | 0465437 | 84/90x185cm | wit/satin | STARFC844F | stuk | 216,00 | 288 | 1 | |
| | 0988876 | 84/90x185cm | wit/geborsteld | STARFC843F | stuk | 216,00 | 288 | 1 | |
| | 0980333 | 84/90x185cm | wit/motief | STARFC849F | stuk | 216,00 | 288 | 1 | |
| Accessoires en spiegels | 0465445 | 84/90x185cm | perg./helder | STARFC841C | stuk | 216,00 | 288 | 1 | |
| | 0465453 | 84/90x185cm | perg./satin | STARFC844C | stuk | 216,00 | 288 | 1 | |
| | 0980719 | 84/90x185cm | perg./borstel | STARFC843C | stuk | 216,00 | 288 | 1 | |
| | 0465461 | 84/90x185cm | perg./motief | STARFC849C | stuk | 216,00 | 288 | 1 | |
| Douchewanden | 0465488 | 84/90x185cm | chroom/helder | STARFC841B | stuk | 235,00 | 288 | 1 | |
| | 0465496 | 84/90x185cm | chroom/satin | STARFC844B | stuk | 235,00 | 288 | 1 | |
| | 0465224 | 84/90x185cm | chr./borsteld | STARFC843B | stuk | 235,00 | 288 | 1 | |
| | 0465232 | 84/90x185cm | chroom/motief | STARFC849B | stuk | 235,00 | 288 | 1 | |
| schuifdeur 2P110 | | | | | | | | | |
| Toebehoren & afvoeren | 0981773 | 108/114x185 | wit/helder | STAR2P1081F | stuk | 394,00 | 288 | 1 | |
| | 0465240 | 108/114x185 | wit/satin | STAR2P1084F | stuk | 394,00 | 288 | 1 | |
| | 0981772 | 108/114x185 | wit/geborsteld | STAR2P1083F | stuk | 394,00 | 288 | 1 | |
| | 0465259 | 108/114x185 | wit/motief | STAR2P1089F | stuk | 394,00 | 288 | 1 | |
| Spoel- & installatiesystemen | 0465267 | 108/114x185 | perg./helder | STAR2P1081C | stuk | 394,00 | 288 | 1 | |
| | 0465275 | 108/114x185 | perg./satin | STAR2P1084C | stuk | 394,00 | 288 | 1 | |
| | 0465283 | 108/114x185 | perg./borstel | STAR2P1083C | stuk | 394,00 | 288 | 1 | |
| | 0465291 | 108/114x185 | perg./motief | STAR2P1089C | stuk | 394,00 | 288 | 1 | |
| Badkamermeubelen en toiletkasten | 0465305 | 108/114x185 | chroom/helder | STAR2P1081B | stuk | 429,00 | 288 | 1 | |
| | 0465313 | 108/114x185 | chroom/satin | STAR2P1084B | stuk | 429,00 | 288 | 1 | |
| | 0465321 | 108/114x185 | chr./borsteld | STAR2P1083B | stuk | 429,00 | 288 | 1 | |
| | 0465348 | 108/114x185 | chroom/motief | STAR2P1089B | stuk | 429,00 | 288 | 1 | |
| schuifdeur 2P120 | | | | | | | | | |
| Gootstenen en wastroggen | 0982036 | 114/120x185 | wit/borstel | STAR2P1143F | stuk | 407,00 | 288 | 1 | |
| | 0982037 | 114/120x185 | wit/helder | STAR2P1141F | stuk | 407,00 | 288 | 1 | |
| | 0982043 | 114/120x185 | wit/satin | STAR2P1144F | stuk | 407,00 | 288 | 1 | |
| | 0982047 | 114/120x185 | wit/motief | STAR2P1149F | stuk | 407,00 | 288 | 1 | |
| Utiliteit | 0982039 | 114/120x185 | perg./borstel | STAR2P1143C | stuk | 407,00 | 288 | 1 | |
| | 0982038 | 114/120x185 | perg./helder | STAR2P1141C | stuk | 407,00 | 288 | 1 | |
| | 0982046 | 114/120x185 | perg./motief | STAR2P1149C | stuk | 407,00 | 288 | 1 | |
| | 0982042 | 114/120x185 | chroom/satin | STAR2P1144C | stuk | 407,00 | 288 | 1 | |
| | 0982044 | 114/120x185 | chroom/satin | STAR2P1144B | stuk | 442,00 | 288 | 1 | |
| | 0982041 | 114/120x185 | chroom/borstel | STAR2P1143B | stuk | 442,00 | 288 | 1 | |
| | 0982045 | 114/120x185 | chroom/helder | STAR2P1141B | stuk | 442,00 | 288 | 1 | |
| | draaideur G90 | | | | | | | | |
| | | 0981743 | 84/90x185cm | wit/helder | STARG841F | stuk | 286,00 | 288 | 1 |
| | | 0465356 | 84/90x185cm | wit/satin | STARG844F | stuk | 286,00 | 288 | 1 |
| | | 0981738 | 84/90x185cm | wit/geborsteld | STARG843F | stuk | 286,00 | 288 | 1 |
| | | 0981744 | 84/90x185cm | wit/motief | STARG849F | stuk | 286,00 | 288 | 1 |
| 0465364 | | 84/90x185cm | perg./helder | STARG841C | stuk | 286,00 | 288 | 1 | |
| 0465372 | | 84/90x185cm | perg./satin | STARG844C | stuk | 286,00 | 288 | 1 | |
| 0981138 | | 84/90x185cm | perg./borstel | STARG843C | stuk | 286,00 | 288 | 1 | |
| 0465380 | | 84/90x185cm | perg./motief | STARG849C | stuk | 286,00 | 288 | 1 | |
| 0465399 | | 84/90x185cm | chroom/helder | STARG841B | stuk | 311,00 | 288 | 1 | |
| 0465402 | | 84/90x185cm | chroom/satin | STARG844B | stuk | 311,00 | 288 | 1 | |
| 0465410 | | 84/90x185cm | chr./borsteld | STARG843B | stuk | 311,00 | 288 | 1 | |
| 0465429 | | 84/90x185cm | chroom/motief | STARG849B | stuk | 311,00 | 288 | 1 | |

| Art.nr | Specificaties | Kleur | Lev.nr | Ehd | Prijs | Grp | CC |
|--|---------------|----------------|-------------|------|--------|-----|----|
| Novellini Star | | | | | | | |
| douchecabine vijfhoekig m. draaideur Pentagono G90 | | | | | | | |
| 0465462 | 90x90x185cm | wit/helder | STARPG901F | stuk | 567,00 | 288 | 1 |
| 0465489 | 90x90x185cm | wit/satin | STARPG904F | stuk | 567,00 | 288 | 1 |
| 0465497 | 90x90x185cm | wit/geborsteld | STARPG903F | stuk | 567,00 | 288 | 1 |
| 0465518 | 90x90x185cm | wit/motief | STARPG909F | stuk | 567,00 | 288 | 1 |
| 0465526 | 90x90x185cm | perg./helder | STARPG901C | stuk | 567,00 | 288 | 1 |
| 0465534 | 90x90x185cm | perg./satin | STARPG904C | stuk | 567,00 | 288 | 1 |
| 0465542 | 90x90x185cm | perg./borstel | STARPG903C | stuk | 567,00 | 288 | 1 |
| 0465550 | 90x90x185cm | perg./motief | STARPG909C | stuk | 567,00 | 288 | 1 |
| 0465569 | 90x90x185cm | chroom/helder | STARPG901B | stuk | 621,00 | 288 | 1 |
| 0465577 | 90x90x185cm | chroom/satin | STARPG904B | stuk | 621,00 | 288 | 1 |
| 0465585 | 90x90x185cm | chr./borsteld | STARPG903B | stuk | 621,00 | 288 | 1 |
| 0465593 | 90x90x185cm | chroom/motief | STARPG909B | stuk | 621,00 | 288 | 1 |
| douchecabine vijfhoekig m. draaideur Pentagono G100 | | | | | | | |
| 0465607 | 100x100x185 | wit/helder | STARPG1001F | stuk | 592,00 | 288 | 1 |
| 0465615 | 100x100x185 | wit/satin | STARPG1004F | stuk | 592,00 | 288 | 1 |
| 0465623 | 100x100x185 | wit/geborsteld | STARPG1003F | stuk | 592,00 | 288 | 1 |
| 0465631 | 100x100x185 | wit/motief | STARPG1009F | stuk | 592,00 | 288 | 1 |
| 0465658 | 100x100x185 | perg./helder | STARPG1001C | stuk | 592,00 | 288 | 1 |
| 0465666 | 100x100x185 | perg./satin | STARPG1004C | stuk | 592,00 | 288 | 1 |
| 0465674 | 100x100x185 | perg./borstel | STARPG1003C | stuk | 592,00 | 288 | 1 |
| 0465682 | 100x100x185 | perg./motief | STARPG1009C | stuk | 592,00 | 288 | 1 |
| 0465690 | 100x100x185 | chroom/helder | STARPG1001B | stuk | 646,00 | 288 | 1 |
| 0465704 | 100x100x185 | chroom/satin | STARPG1004B | stuk | 646,00 | 288 | 1 |
| 0465712 | 100x100x185 | chr./borsteld | STARPG1003B | stuk | 646,00 | 288 | 1 |
| 0465720 | 100x100x185 | chroom/motief | STARPG1009B | stuk | 646,00 | 288 | 1 |
| douchecabine kwartrond R90 | | | | | | | |
| 0465739 | 90x90x185cm | wit/helder | STARR901F | stuk | 670,00 | 288 | 1 |
| 0465747 | 90x90x185cm | wit/satin | STARR904F | stuk | 670,00 | 288 | 1 |
| 0465755 | 90x90x185cm | wit/geborsteld | STARR903F | stuk | 670,00 | 288 | 1 |
| 0465763 | 90x90x185cm | wit/motief | STARR909F | stuk | 670,00 | 288 | 1 |
| 0465771 | 90x90x185cm | perg./helder | STARR901C | stuk | 670,00 | 288 | 1 |
| 0465798 | 90x90x185cm | perg./satin | STARR904C | stuk | 670,00 | 288 | 1 |
| 0465801 | 90x90x185cm | perg./borstel | STARR903C | stuk | 670,00 | 288 | 1 |
| 0465828 | 90x90x185cm | perg./motief | STARR909C | stuk | 670,00 | 288 | 1 |
| 0465836 | 90x90x185cm | chroom/helder | STARR901B | stuk | 729,00 | 288 | 1 |
| 0465844 | 90x90x185cm | chroom/satin | STARR904B | stuk | 729,00 | 288 | 1 |
| 0465852 | 90x90x185cm | chr./borsteld | STARR903B | stuk | 729,00 | 288 | 1 |
| 0465860 | 90x90x185cm | chroom/motief | STARR909B | stuk | 729,00 | 288 | 1 |
| douchecabine kwartrond R100 | | | | | | | |
| 0465879 | 100x100x185 | wit/helder | STARR1001F | stuk | 702,00 | 288 | 1 |
| 0465887 | 100x100x185 | wit/satin | STARR1004F | stuk | 702,00 | 288 | 1 |
| 0465895 | 100x100x185 | wit/geborsteld | STARR1003F | stuk | 702,00 | 288 | 1 |
| 0465909 | 100x100x185 | wit/motief | STARR1009F | stuk | 702,00 | 288 | 1 |
| 0465917 | 100x100x185 | perg./helder | STARR1001C | stuk | 702,00 | 288 | 1 |
| 0465925 | 100x100x185 | perg./satin | STARR1004C | stuk | 702,00 | 288 | 1 |
| 0465933 | 100x100x185 | perg./borstel | STARR1003C | stuk | 702,00 | 288 | 1 |
| 0465941 | 100x100x185 | perg./motief | STARR1009C | stuk | 702,00 | 288 | 1 |
| 0465968 | 100x100x185 | chroom/helder | STARR1001B | stuk | 761,00 | 288 | 1 |
| 0465976 | 100x100x185 | chroom/satin | STARR1004B | stuk | 761,00 | 288 | 1 |
| 0465984 | 100x100x185 | chr./borsteld | STARR1003B | stuk | 761,00 | 288 | 1 |
| 0465992 | 100x100x185 | chroom/motief | STARR1009B | stuk | 761,00 | 288 | 1 |



Sanitair producten

Baden /
douchebakken /
stoomcabines

Kranen

Douchegarnituur

Accessoires en
spiegels

Douchewanden

Toebehoren &
afvoerenSpoel- &
installatiesystemenBadkamermeubelen
en toiletkastenGootstenen en
wastroggen

Utiliteit

| | Art.nr | Specificaties | Kleur | Lev.nr | Ehd | Prijs | Grp | CC |
|---|---------------------------------|--|---------------|-------------|-------------|--------|--------|-----|
| | | Novellini Young | | | | | | |
| | | R douhecabine kwartrond m. klapdeuren m. vast segment | | | | | | |
| Sanitair producten | 0334783 | 84/87x190cm | wit/helder | YOUNGR901A | stuk | 737,00 | 288 | 1 |
| | 0334784 | 84/87x190cm | wit/satin | YOUNGR904A | stuk | 737,00 | 288 | 1 |
| Baden / douchebakken / stoomcabines | 0334785 | 84/87x190cm | wit/gothic | YOUNGR902A | stuk | 737,00 | 288 | 1 |
| | 0334786 | 84/87x190cm | perg./helder | YOUNGR901C | stuk | 737,00 | 288 | 1 |
| | 0334787 | 84/87x190cm | perg./satin | YOUNGR904C | stuk | 737,00 | 288 | 1 |
| | 0334788 | 84/87x190cm | perg./gothic | YOUNGR902C | stuk | 737,00 | 288 | 1 |
| | 0334789 | 84/87x190cm | chroom/helder | YOUNGR901B | stuk | 811,00 | 288 | 1 |
| | 0334790 | 84/87x190cm | chroom/satin | YOUNGR904B | stuk | 811,00 | 288 | 1 |
| Kranen | 0334791 | 84/87x190cm | chroom/gothic | YOUNGR902B | stuk | 811,00 | 288 | 1 |
| | 0334792 | 94/97x190cm | wit/helder | YOUNGR1001A | stuk | 737,00 | 288 | 1 |
| | 0334793 | 94/97x190cm | wit/satin | YOUNGR1004A | stuk | 737,00 | 288 | 1 |
| Douchegarnituur | 0334794 | 94/97x190cm | wit/gothic | YOUNGR1002A | stuk | 737,00 | 288 | 1 |
| | 0334795 | 94/97x190cm | perg./helder | YOUNGR1001C | stuk | 737,00 | 288 | 1 |
| | 0334796 | 94/97x190cm | perg./satin | YOUNGR1004C | stuk | 737,00 | 288 | 1 |
| | 0334797 | 94/97x190cm | perg./gothic | YOUNGR1002C | stuk | 737,00 | 288 | 1 |
| | 0334798 | 94/97x190cm | chroom/helder | YOUNGR1001B | stuk | 811,00 | 288 | 1 |
| | 0334799 | 94/97x190cm | chroom/satin | YOUNGR1004B | stuk | 811,00 | 288 | 1 |
| Accessoires en spiegels | 0334800 | 94/97x190cm | chroom/gothic | YOUNGR1002B | stuk | 811,00 | 288 | 1 |
| | | 2G douhecabine hoekinstap m. draaideuren | | | | | | |
| Douchewanden | 0334801 | 78/81x190cm | wit/helder | YOUNG2G781A | stuk | 500,00 | 288 | 1 |
| | 0334802 | 78/81x190cm | wit/satin | YOUNG2G784A | stuk | 500,00 | 288 | 1 |
| Toebehoren & afvoeren | 0334803 | 78/81x190cm | wit/gothic | YOUNG2G782A | stuk | 500,00 | 288 | 1 |
| | 0334804 | 78/81x190cm | perg./helder | YOUNG2G781C | stuk | 500,00 | 288 | 1 |
| | 0334805 | 78/81x190cm | perg./satin | YOUNG2G784C | stuk | 500,00 | 288 | 1 |
| | 0334806 | 78/81x190cm | perg./gothic | YOUNG2G782C | stuk | 500,00 | 288 | 1 |
| | 0334807 | 78/81x190cm | chroom/helder | YOUNG2G781B | stuk | 550,00 | 288 | 1 |
| | 0334808 | 78/81x190cm | chroom/satin | YOUNG2G784B | stuk | 550,00 | 288 | 1 |
| | 0334809 | 78/81x190cm | chroom/gothic | YOUNG2G782B | stuk | 550,00 | 288 | 1 |
| | 0334810 | 81/84x190cm | wit/helder | YOUNG2G811A | stuk | 500,00 | 288 | 1 |
| | 0334811 | 81/84x190cm | wit/satin | YOUNG2G814A | stuk | 500,00 | 288 | 1 |
| | 0334812 | 81/84x190cm | wit/gothic | YOUNG2G812A | stuk | 500,00 | 288 | 1 |
| | 0334813 | 81/84x190cm | perg./helder | YOUNG2G811C | stuk | 500,00 | 288 | 1 |
| | Spool- & installatiesystemen | 0334814 | 81/84x190cm | perg./satin | YOUNG2G814C | stuk | 500,00 | 288 |
| 0334815 | | 81/84x190cm | perg./gothic | YOUNG2G812C | stuk | 500,00 | 288 | 1 |
| 0334816 | | 81/84x190cm | chroom/helder | YOUNG2G811B | stuk | 550,00 | 288 | 1 |
| 0334817 | | 81/84x190cm | chroom/satin | YOUNG2G814B | stuk | 550,00 | 288 | 1 |
| 0334818 | | 81/84x190cm | chroom/gothic | YOUNG2G812B | stuk | 550,00 | 288 | 1 |
| 0334819 | | 84/87x190cm | wit/helder | YOUNG2G841A | stuk | 528,00 | 288 | 1 |
| Badkamermeubelen en toiletkasten | 0334820 | 84/87x190cm | wit/satin | YOUNG2G844A | stuk | 528,00 | 288 | 1 |
| | 0334821 | 84/87x190cm | wit/gothic | YOUNG2G842A | stuk | 528,00 | 288 | 1 |
| | 0334822 | 84/87x190cm | perg./helder | YOUNG2G841C | stuk | 528,00 | 288 | 1 |
| | 0334823 | 84/87x190cm | perg./satin | YOUNG2G844C | stuk | 528,00 | 288 | 1 |
| | 0334824 | 84/87x190cm | perg./gothic | YOUNG2G842C | stuk | 528,00 | 288 | 1 |
| | 0334825 | 84/87x190cm | chroom/helder | YOUNG2G841B | stuk | 578,00 | 288 | 1 |
| Gootstenen en wastroggen | 0334826 | 84/87x190cm | chroom/satin | YOUNG2G844B | stuk | 578,00 | 288 | 1 |
| | 0334827 | 84/87x190cm | chroom/gothic | YOUNG2G842B | stuk | 578,00 | 288 | 1 |
| | 0334828 | 87/90x190cm | wit/helder | YOUNG2G871A | stuk | 528,00 | 288 | 1 |
| | 0334829 | 87/90x190cm | wit/satin | YOUNG2G874A | stuk | 528,00 | 288 | 1 |
| | 0334830 | 87/90x190cm | wit/gothic | YOUNG2G872A | stuk | 528,00 | 288 | 1 |
| | 0334831 | 87/90x190cm | perg./helder | YOUNG2G871C | stuk | 528,00 | 288 | 1 |
| | 0334832 | 87/90x190cm | perg./satin | YOUNG2G874C | stuk | 528,00 | 288 | 1 |
| | 0334833 | 87/90x190cm | perg./gothic | YOUNG2G872C | stuk | 528,00 | 288 | 1 |
| | 0334834 | 87/90x190cm | chroom/helder | YOUNG2G871B | stuk | 578,00 | 288 | 1 |
| | 0334835 | 87/90x190cm | chroom/satin | YOUNG2G874B | stuk | 578,00 | 288 | 1 |
| | 0334836 | 87/90x190cm | chroom/gothic | YOUNG2G872B | stuk | 578,00 | 288 | 1 |
| | Utiliteit | 0334837 | 90/93x190cm | wit/helder | YOUNG2G901A | stuk | 528,00 | 288 |
| 0334838 | | 90/93x190cm | wit/satin | YOUNG2G904A | stuk | 528,00 | 288 | 1 |
| 0334839 | | 90/93x190cm | wit/gothic | YOUNG2G902A | stuk | 528,00 | 288 | 1 |
| 0334840 | | 90/93x190cm | perg./helder | YOUNG2G901C | stuk | 528,00 | 288 | 1 |
| 0334841 | | 90/93x190cm | perg./satin | YOUNG2G904C | stuk | 528,00 | 288 | 1 |
| 0334842 | | 90/93x190cm | perg./gothic | YOUNG2G902C | stuk | 528,00 | 288 | 1 |
| 0334843 | | 90/93x190cm | chroom/helder | YOUNG2G901B | stuk | 578,00 | 288 | 1 |
| 0334844 | | 90/93x190cm | chroom/satin | YOUNG2G904B | stuk | 578,00 | 288 | 1 |
| 0334845 | | 90/93x190cm | chroom/gothic | YOUNG2G902B | stuk | 578,00 | 288 | 1 |

| Art.nr | Specificaties | Kleur | Lev.nr | Ehd | Prijs | Grp | CC |
|---|---------------|---------------|------------|------|--------|-----|----|
| Novellini Young | | | | | | | |
| A douchecabine hoekinstap m. draaideuren m. vast segment | | | | | | | |
| 0334846 | 78/81x190cm | wit/helder | YOUNGA781A | stuk | 526,00 | 288 | 1 |
| 0334847 | 78/81x190cm | wit/satin | YOUNGA784A | stuk | 526,00 | 288 | 1 |
| 0334848 | 78/81x190cm | wit/gothic | YOUNGA782A | stuk | 526,00 | 288 | 1 |
| 0334849 | 78/81x190cm | perg./helder | YOUNGA781C | stuk | 526,00 | 288 | 1 |
| 0334850 | 78/81x190cm | perg./satin | YOUNGA784C | stuk | 526,00 | 288 | 1 |
| 0334851 | 78/81x190cm | perg./gothic | YOUNGA782C | stuk | 526,00 | 288 | 1 |
| 0334852 | 78/81x190cm | chroom/helder | YOUNGA781B | stuk | 581,00 | 288 | 1 |
| 0334853 | 78/81x190cm | chroom/satin | YOUNGA784B | stuk | 581,00 | 288 | 1 |
| 0334854 | 78/81x190cm | chroom/gothic | YOUNGA782B | stuk | 581,00 | 288 | 1 |
| 0334855 | 81/84x190cm | wit/helder | YOUNGA811A | stuk | 526,00 | 288 | 1 |
| 0334856 | 81/84x190cm | wit/satin | YOUNGA814A | stuk | 526,00 | 288 | 1 |
| 0334857 | 81/84x190cm | wit/gothic | YOUNGA812A | stuk | 526,00 | 288 | 1 |
| 0334858 | 81/84x190cm | perg./helder | YOUNGA811C | stuk | 526,00 | 288 | 1 |
| 0334859 | 81/84x190cm | perg./satin | YOUNGA814C | stuk | 526,00 | 288 | 1 |
| 0334860 | 81/84x190cm | perg./gothic | YOUNGA812C | stuk | 526,00 | 288 | 1 |
| 0334861 | 81/84x190cm | chroom/helder | YOUNGA811B | stuk | 581,00 | 288 | 1 |
| 0334862 | 81/84x190cm | chroom/satin | YOUNGA814B | stuk | 581,00 | 288 | 1 |
| 0334863 | 81/84x190cm | chroom/gothic | YOUNGA812B | stuk | 581,00 | 288 | 1 |
| 0334864 | 84/87x190cm | wit/helder | YOUNGA841A | stuk | 558,00 | 288 | 1 |
| 0334865 | 84/87x190cm | wit/satin | YOUNGA844A | stuk | 558,00 | 288 | 1 |
| 0334866 | 84/87x190cm | wit/gothic | YOUNGA842A | stuk | 558,00 | 288 | 1 |
| 0334867 | 84/87x190cm | perg./helder | YOUNGA841C | stuk | 558,00 | 288 | 1 |
| 0334868 | 84/87x190cm | perg./satin | YOUNGA844C | stuk | 558,00 | 288 | 1 |
| 0334869 | 84/87x190cm | perg./gothic | YOUNGA842C | stuk | 558,00 | 288 | 1 |
| 0334870 | 84/87x190cm | chroom/helder | YOUNGA841B | stuk | 613,00 | 288 | 1 |
| 0334871 | 84/87x190cm | chroom/satin | YOUNGA844B | stuk | 613,00 | 288 | 1 |
| 0334872 | 84/87x190cm | chroom/gothic | YOUNGA842B | stuk | 613,00 | 288 | 1 |
| 0334873 | 87/90x190cm | wit/helder | YOUNGA871A | stuk | 558,00 | 288 | 1 |
| 0334874 | 87/90x190cm | wit/satin | YOUNGA874A | stuk | 558,00 | 288 | 1 |
| 0334875 | 87/90x190cm | wit/gothic | YOUNGA872A | stuk | 558,00 | 288 | 1 |
| 0334876 | 87/90x190cm | perg./helder | YOUNGA871C | stuk | 558,00 | 288 | 1 |
| 0334877 | 87/90x190cm | perg./satin | YOUNGA874C | stuk | 558,00 | 288 | 1 |
| 0334878 | 87/90x190cm | perg./gothic | YOUNGA872C | stuk | 558,00 | 288 | 1 |
| 0334879 | 87/90x190cm | chroom/helder | YOUNGA871B | stuk | 613,00 | 288 | 1 |
| 0334880 | 87/90x190cm | chroom/satin | YOUNGA874B | stuk | 613,00 | 288 | 1 |
| 0334881 | 87/90x190cm | chroom/gothic | YOUNGA872B | stuk | 613,00 | 288 | 1 |
| 0334882 | 90/93x190cm | wit/helder | YOUNGA901A | stuk | 558,00 | 288 | 1 |
| 0334883 | 90/93x190cm | wit/satin | YOUNGA904A | stuk | 558,00 | 288 | 1 |
| 0334884 | 90/93x190cm | wit/gothic | YOUNGA902A | stuk | 558,00 | 288 | 1 |
| 0334885 | 90/93x190cm | perg./helder | YOUNGA901C | stuk | 558,00 | 288 | 1 |
| 0334886 | 90/93x190cm | perg./satin | YOUNGA904C | stuk | 558,00 | 288 | 1 |
| 0334887 | 90/93x190cm | perg./gothic | YOUNGA902C | stuk | 558,00 | 288 | 1 |
| 0334888 | 90/93x190cm | chroom/helder | YOUNGA901B | stuk | 613,00 | 288 | 1 |
| 0334889 | 90/93x190cm | chroom/satin | YOUNGA904B | stuk | 613,00 | 288 | 1 |
| 0334890 | 90/93x190cm | chroom/gothic | YOUNGA902B | stuk | 613,00 | 288 | 1 |
| 0334891 | 93/96x190cm | wit/helder | YOUNGA931A | stuk | 558,00 | 288 | 1 |
| 0334892 | 93/96x190cm | wit/satin | YOUNGA934A | stuk | 558,00 | 288 | 1 |
| 0334893 | 93/96x190cm | wit/gothic | YOUNGA932A | stuk | 558,00 | 288 | 1 |
| 0334894 | 93/96x190cm | perg./helder | YOUNGA931C | stuk | 558,00 | 288 | 1 |
| 0334895 | 93/96x190cm | perg./satin | YOUNGA934C | stuk | 558,00 | 288 | 1 |
| 0334896 | 93/96x190cm | perg./gothic | YOUNGA932C | stuk | 558,00 | 288 | 1 |
| 0334897 | 93/96x190cm | chroom/helder | YOUNGA931B | stuk | 613,00 | 288 | 1 |
| 0334898 | 93/96x190cm | chroom/satin | YOUNGA934B | stuk | 613,00 | 288 | 1 |
| 0334899 | 93/96x190cm | chroom/gothic | YOUNGA932B | stuk | 613,00 | 288 | 1 |



Sanitair producten

Baden /
douchebakken /
stoomcabines

Kranen

Douchegarnituur

Accessoires en
spiegels

Douchewanden

Toebehoren &
afvoerenSpoel- &
installatiesystemenBadkamermeubelen
en toiletkastenGootstenen en
wastroggen

Utiliteit

| Art.nr | Specificaties | Kleur | Lev.nr | Ehd | Prijs | Grp | CC | |
|---|--|-------------|---------------|-------------|-------------|--------|--------|-------|
| Novellini Young | | | | | | | | |
| S vouwdeur voor nis of zijwand | | | | | | | | |
| Sanitair producten | 0334900 | 84/90x190cm | wit/helder | YOUNGS841A | stuk | 417,00 | 288 1 | |
| | 0334901 | 84/90x190cm | wit/satin | YOUNGS844A | stuk | 417,00 | 288 1 | |
| | 0334902 | 84/90x190cm | wit/gothic | YOUNGS842A | stuk | 417,00 | 288 1 | |
| | 0334903 | 84/90x190cm | perg./helder | YOUNGS841C | stuk | 417,00 | 288 1 | |
| | 0334904 | 84/90x190cm | perg./satin | YOUNGS844C | stuk | 417,00 | 288 1 | |
| | 0334905 | 84/90x190cm | perg./gothic | YOUNGS842C | stuk | 417,00 | 288 1 | |
| | 0334906 | 84/90x190cm | chroom/helder | YOUNGS841B | stuk | 459,00 | 288 1 | |
| | 0334907 | 84/90x190cm | chroom/satin | YOUNGS844B | stuk | 459,00 | 288 1 | |
| | 0334908 | 84/90x190cm | chroom/gothic | YOUNGS842B | stuk | 459,00 | 288 1 | |
| | 0334909 | 90/96x190cm | wit/helder | YOUNGS901A | stuk | 435,00 | 288 1 | |
| Kranen | 0334910 | 90/96x190cm | wit/satin | YOUNGS904A | stuk | 435,00 | 288 1 | |
| | 0334911 | 90/96x190cm | wit/gothic | YOUNGS902A | stuk | 435,00 | 288 1 | |
| | 0334912 | 90/96x190cm | perg./helder | YOUNGS901C | stuk | 435,00 | 288 1 | |
| Douchegarnituur | 0334913 | 90/96x190cm | perg./satin | YOUNGS904C | stuk | 435,00 | 288 1 | |
| | 0334914 | 90/96x190cm | perg./gothic | YOUNGS902C | stuk | 435,00 | 288 1 | |
| | 0334915 | 90/96x190cm | chroom/helder | YOUNGS901B | stuk | 477,00 | 288 1 | |
| | 0334916 | 90/96x190cm | chroom/satin | YOUNGS904B | stuk | 477,00 | 288 1 | |
| | 0334917 | 90/96x190cm | chroom/gothic | YOUNGS902B | stuk | 477,00 | 288 1 | |
| 1B draaideur voor nis of zijwand | | | | | | | | |
| Accessoires en spiegels | 0334918 | 84/90x190cm | wit/helder | YOUNG1B841A | stuk | 325,00 | 288 1 | |
| | 0334919 | 84/90x190cm | wit/satin | YOUNG1B844A | stuk | 325,00 | 288 1 | |
| | 0334920 | 84/90x190cm | wit/gothic | YOUNG1B842A | stuk | 325,00 | 288 1 | |
| | 0334921 | 84/90x190cm | perg./helder | YOUNG1B841C | stuk | 325,00 | 288 1 | |
| | 0334922 | 84/90x190cm | perg./satin | YOUNG1B844C | stuk | 325,00 | 288 1 | |
| | 0334923 | 84/90x190cm | perg./gothic | YOUNG1B842C | stuk | 325,00 | 288 1 | |
| | 0334924 | 84/90x190cm | chroom/helder | YOUNG1B841B | stuk | 356,00 | 288 1 | |
| | 0334925 | 84/90x190cm | chroom/satin | YOUNG1B844B | stuk | 356,00 | 288 1 | |
| | 0334926 | 84/90x190cm | chroom/gothic | YOUNG1B842B | stuk | 356,00 | 288 1 | |
| | 0334927 | 90/96x190cm | wit/helder | YOUNG1B901A | stuk | 325,00 | 288 1 | |
| Douchewanden | 0334928 | 90/96x190cm | wit/satin | YOUNG1B904A | stuk | 325,00 | 288 1 | |
| | 0334929 | 90/96x190cm | wit/gothic | YOUNG1B902A | stuk | 325,00 | 288 1 | |
| | 0334930 | 90/96x190cm | perg./helder | YOUNG1B901C | stuk | 325,00 | 288 1 | |
| | 0334931 | 90/96x190cm | perg./satin | YOUNG1B904C | stuk | 325,00 | 288 1 | |
| | 0334932 | 90/96x190cm | perg./gothic | YOUNG1B902C | stuk | 325,00 | 288 1 | |
| | 0334933 | 90/96x190cm | chroom/helder | YOUNG1B901B | stuk | 356,00 | 288 1 | |
| | 0334934 | 90/96x190cm | chroom/satin | YOUNG1B904B | stuk | 356,00 | 288 1 | |
| | 0334935 | 90/96x190cm | chroom/gothic | YOUNG1B902B | stuk | 356,00 | 288 1 | |
| | 2B klapdeur 2-delig voor nis of zijwand | | | | | | | |
| | Toebehoren & afvoeren | 0334936 | 84/90x190cm | wit/helder | YOUNG2B841A | stuk | 417,00 | 288 1 |
| 0334937 | | 84/90x190cm | wit/satin | YOUNG2B844A | stuk | 417,00 | 288 1 | |
| 0334938 | | 84/90x190cm | wit/gothic | YOUNG2B842A | stuk | 417,00 | 288 1 | |
| 0334939 | | 84/90x190cm | perg./helder | YOUNG2B841C | stuk | 417,00 | 288 1 | |
| 0334940 | | 84/90x190cm | perg./satin | YOUNG2B844C | stuk | 417,00 | 288 1 | |
| 0334941 | | 84/90x190cm | perg./gothic | YOUNG2B842C | stuk | 417,00 | 288 1 | |
| 0334942 | | 84/90x190cm | chroom/helder | YOUNG2B841B | stuk | 457,00 | 288 1 | |
| 0334943 | | 84/90x190cm | chroom/satin | YOUNG2B844B | stuk | 457,00 | 288 1 | |
| 0334944 | | 84/90x190cm | chroom/gothic | YOUNG2B842B | stuk | 457,00 | 288 1 | |
| 0334945 | | 90/96x190cm | wit/helder | YOUNG2B901A | stuk | 417,00 | 288 1 | |
| Spool- & installatiesystemen | 0334946 | 90/96x190cm | wit/satin | YOUNG2B904A | stuk | 417,00 | 288 1 | |
| | 0334947 | 90/96x190cm | wit/gothic | YOUNG2B902A | stuk | 417,00 | 288 1 | |
| | 0334948 | 90/96x190cm | perg./helder | YOUNG2B901C | stuk | 417,00 | 288 1 | |
| | 0334949 | 90/96x190cm | perg./satin | YOUNG2B904C | stuk | 417,00 | 288 1 | |
| | 0334950 | 90/96x190cm | perg./gothic | YOUNG2B902C | stuk | 417,00 | 288 1 | |
| | 0334951 | 90/96x190cm | chroom/helder | YOUNG2B901B | stuk | 457,00 | 288 1 | |
| | 0334952 | 90/96x190cm | chroom/satin | YOUNG2B904B | stuk | 457,00 | 288 1 | |
| | 0334953 | 90/96x190cm | chroom/gothic | YOUNG2B902B | stuk | 457,00 | 288 1 | |
| | 2B klapdeur 2-delig voor nis of zijwand | | | | | | | |
| | Badkamermeubelen en toiletkasten | 0334936 | 84/90x190cm | wit/helder | YOUNG2B841A | stuk | 417,00 | 288 1 |
| 0334937 | | 84/90x190cm | wit/satin | YOUNG2B844A | stuk | 417,00 | 288 1 | |
| 0334938 | | 84/90x190cm | wit/gothic | YOUNG2B842A | stuk | 417,00 | 288 1 | |
| 0334939 | | 84/90x190cm | perg./helder | YOUNG2B841C | stuk | 417,00 | 288 1 | |
| 0334940 | | 84/90x190cm | perg./satin | YOUNG2B844C | stuk | 417,00 | 288 1 | |
| 0334941 | | 84/90x190cm | perg./gothic | YOUNG2B842C | stuk | 417,00 | 288 1 | |
| 0334942 | | 84/90x190cm | chroom/helder | YOUNG2B841B | stuk | 457,00 | 288 1 | |
| 0334943 | | 84/90x190cm | chroom/satin | YOUNG2B844B | stuk | 457,00 | 288 1 | |
| 0334944 | | 84/90x190cm | chroom/gothic | YOUNG2B842B | stuk | 457,00 | 288 1 | |
| 0334945 | | 90/96x190cm | wit/helder | YOUNG2B901A | stuk | 417,00 | 288 1 | |
| Gootstenen en wastroggen | 0334946 | 90/96x190cm | wit/satin | YOUNG2B904A | stuk | 417,00 | 288 1 | |
| | 0334947 | 90/96x190cm | wit/gothic | YOUNG2B902A | stuk | 417,00 | 288 1 | |
| | 0334948 | 90/96x190cm | perg./helder | YOUNG2B901C | stuk | 417,00 | 288 1 | |
| | 0334949 | 90/96x190cm | perg./satin | YOUNG2B904C | stuk | 417,00 | 288 1 | |
| | 0334950 | 90/96x190cm | perg./gothic | YOUNG2B902C | stuk | 417,00 | 288 1 | |
| | 0334951 | 90/96x190cm | chroom/helder | YOUNG2B901B | stuk | 457,00 | 288 1 | |
| | 0334952 | 90/96x190cm | chroom/satin | YOUNG2B904B | stuk | 457,00 | 288 1 | |
| | 0334953 | 90/96x190cm | chroom/gothic | YOUNG2B902B | stuk | 457,00 | 288 1 | |
| | 2B klapdeur 2-delig voor nis of zijwand | | | | | | | |
| | Utiliteit | 0334936 | 84/90x190cm | wit/helder | YOUNG2B841A | stuk | 417,00 | 288 1 |
| 0334937 | | 84/90x190cm | wit/satin | YOUNG2B844A | stuk | 417,00 | 288 1 | |
| 0334938 | | 84/90x190cm | wit/gothic | YOUNG2B842A | stuk | 417,00 | 288 1 | |
| 0334939 | | 84/90x190cm | perg./helder | YOUNG2B841C | stuk | 417,00 | 288 1 | |
| 0334940 | | 84/90x190cm | perg./satin | YOUNG2B844C | stuk | 417,00 | 288 1 | |
| 0334941 | | 84/90x190cm | perg./gothic | YOUNG2B842C | stuk | 417,00 | 288 1 | |
| 0334942 | | 84/90x190cm | chroom/helder | YOUNG2B841B | stuk | 457,00 | 288 1 | |
| 0334943 | | 84/90x190cm | chroom/satin | YOUNG2B844B | stuk | 457,00 | 288 1 | |
| 0334944 | | 84/90x190cm | chroom/gothic | YOUNG2B842B | stuk | 457,00 | 288 1 | |
| 0334945 | | 90/96x190cm | wit/helder | YOUNG2B901A | stuk | 417,00 | 288 1 | |

| Art.nr | Specificaties | Kleur | Lev.nr | Ehd | Prijs | Grp | CC |
|-------------------------------|---------------|---------------|------------|------|--------|-----|----|
| Novellini Young | | | | | | | |
| F zijwand voor S-1B-2B | | | | | | | |
| 0334954 | 81/84x190cm | wit/helder | YOUNGF811A | stuk | 217,00 | 288 | 1 |
| 0334955 | 81/84x190cm | wit/satin | YOUNGF814A | stuk | 217,00 | 288 | 1 |
| 0334956 | 81/84x190cm | wit/gothic | YOUNGF812A | stuk | 217,00 | 288 | 1 |
| 0334957 | 81/84x190cm | perg./helder | YOUNGF811C | stuk | 217,00 | 288 | 1 |
| 0334958 | 81/84x190cm | perg./satin | YOUNGF814C | stuk | 217,00 | 288 | 1 |
| 0334959 | 81/84x190cm | perg./gothic | YOUNGF812C | stuk | 217,00 | 288 | 1 |
| 0334960 | 81/84x190cm | chroom/helder | YOUNGF811B | stuk | 239,00 | 288 | 1 |
| 0334961 | 81/84x190cm | chroom/satin | YOUNGF814B | stuk | 239,00 | 288 | 1 |
| 0334962 | 81/84x190cm | chroom/gothic | YOUNGF812B | stuk | 239,00 | 288 | 1 |
| 0334963 | 84/87x190cm | wit/helder | YOUNGF841A | stuk | 230,00 | 288 | 1 |
| 0334964 | 84/87x190cm | wit/satin | YOUNGF844A | stuk | 230,00 | 288 | 1 |
| 0334965 | 84/87x190cm | wit/gothic | YOUNGF842A | stuk | 230,00 | 288 | 1 |
| 0334966 | 84/87x190cm | perg./helder | YOUNGF841C | stuk | 230,00 | 288 | 1 |
| 0334967 | 84/87x190cm | perg./satin | YOUNGF844C | stuk | 230,00 | 288 | 1 |
| 0334968 | 84/87x190cm | perg./gothic | YOUNGF842C | stuk | 230,00 | 288 | 1 |
| 0334969 | 84/87x190cm | chroom/helder | YOUNGF841B | stuk | 252,00 | 288 | 1 |
| 0334970 | 84/87x190cm | chroom/satin | YOUNGF844B | stuk | 252,00 | 288 | 1 |
| 0334971 | 84/87x190cm | chroom/gothic | YOUNGF842B | stuk | 252,00 | 288 | 1 |
| 0334972 | 87/90x190cm | wit/helder | YOUNGF871A | stuk | 230,00 | 288 | 1 |
| 0334973 | 87/90x190cm | wit/satin | YOUNGF874A | stuk | 230,00 | 288 | 1 |
| 0334974 | 87/90x190cm | wit/gothic | YOUNGF872A | stuk | 230,00 | 288 | 1 |
| 0334975 | 87/90x190cm | perg./helder | YOUNGF871C | stuk | 230,00 | 288 | 1 |
| 0334976 | 87/90x190cm | perg./satin | YOUNGF874C | stuk | 230,00 | 288 | 1 |
| 0334977 | 87/90x190cm | perg./gothic | YOUNGF872C | stuk | 230,00 | 288 | 1 |
| 0334978 | 87/90x190cm | chroom/helder | YOUNGF871B | stuk | 252,00 | 288 | 1 |
| 0334979 | 87/90x190cm | chroom/satin | YOUNGF874B | stuk | 252,00 | 288 | 1 |
| 0334980 | 87/90x190cm | chroom/gothic | YOUNGF872B | stuk | 252,00 | 288 | 1 |
| 0334981 | 90/93x190cm | wit/helder | YOUNGF901A | stuk | 230,00 | 288 | 1 |
| 0334982 | 90/93x190cm | wit/satin | YOUNGF904A | stuk | 230,00 | 288 | 1 |
| 0334983 | 90/93x190cm | wit/gothic | YOUNGF902A | stuk | 230,00 | 288 | 1 |
| 0334984 | 90/93x190cm | perg./helder | YOUNGF901C | stuk | 230,00 | 288 | 1 |
| 0334985 | 90/93x190cm | perg./satin | YOUNGF904C | stuk | 230,00 | 288 | 1 |
| 0334986 | 90/93x190cm | perg./gothic | YOUNGF902C | stuk | 230,00 | 288 | 1 |
| 0334987 | 90/93x190cm | chroom/helder | YOUNGF901B | stuk | 252,00 | 288 | 1 |
| 0334988 | 90/93x190cm | chroom/satin | YOUNGF904B | stuk | 252,00 | 288 | 1 |
| 0334989 | 90/93x190cm | chroom/gothic | YOUNGF902B | stuk | 252,00 | 288 | 1 |
| 0334990 | 93/96x190cm | wit/helder | YOUNGF931A | stuk | 230,00 | 288 | 1 |
| 0334991 | 93/96x190cm | wit/satin | YOUNGF934A | stuk | 230,00 | 288 | 1 |
| 0334992 | 93/96x190cm | wit/gothic | YOUNGF932A | stuk | 230,00 | 288 | 1 |
| 0334993 | 93/96x190cm | perg./helder | YOUNGF931C | stuk | 230,00 | 288 | 1 |
| 0334994 | 93/96x190cm | perg./satin | YOUNGF934C | stuk | 230,00 | 288 | 1 |
| 0334995 | 93/96x190cm | perg./gothic | YOUNGF932C | stuk | 230,00 | 288 | 1 |
| 0334996 | 93/96x190cm | chroom/helder | YOUNGF931B | stuk | 252,00 | 288 | 1 |
| 0334997 | 93/96x190cm | chroom/satin | YOUNGF934B | stuk | 252,00 | 288 | 1 |
| 0334998 | 93/96x190cm | chroom/gothic | YOUNGF932B | stuk | 252,00 | 288 | 1 |

P douchecabine vijfhoekig m. draaideuren

| | | | | | | | |
|---------|-------------|---------------|-------------|------|--------|-----|---|
| 0334999 | 84/87x190cm | wit/helder | YOUNGP901A | stuk | 634,00 | 288 | 1 |
| 0335000 | 84/87x190cm | wit/satin | YOUNGP904A | stuk | 634,00 | 288 | 1 |
| 0335001 | 84/87x190cm | wit/gothic | YOUNGP902A | stuk | 634,00 | 288 | 1 |
| 0335002 | 84/87x190cm | perg./helder | YOUNGP901C | stuk | 634,00 | 288 | 1 |
| 0335003 | 84/87x190cm | perg./satin | YOUNGP904C | stuk | 634,00 | 288 | 1 |
| 0335004 | 84/87x190cm | perg./gothic | YOUNGP902C | stuk | 634,00 | 288 | 1 |
| 0335005 | 84/87x190cm | chroom/helder | YOUNGP901B | stuk | 698,00 | 288 | 1 |
| 0335006 | 84/87x190cm | chroom/satin | YOUNGP904B | stuk | 698,00 | 288 | 1 |
| 0335007 | 84/87x190cm | chroom/gothic | YOUNGP902B | stuk | 698,00 | 288 | 1 |
| 0335008 | 94/97x190cm | wit/helder | YOUNGP1001A | stuk | 634,00 | 288 | 1 |
| 0335009 | 94/97x190cm | wit/satin | YOUNGP1004A | stuk | 634,00 | 288 | 1 |
| 0335010 | 94/97x190cm | wit/gothic | YOUNGP1002A | stuk | 634,00 | 288 | 1 |
| 0335011 | 94/97x190cm | perg./helder | YOUNGP1001C | stuk | 634,00 | 288 | 1 |
| 0335012 | 94/97x190cm | perg./satin | YOUNGP1004C | stuk | 634,00 | 288 | 1 |
| 0335013 | 94/97x190cm | perg./gothic | YOUNGP1002C | stuk | 634,00 | 288 | 1 |
| 0335014 | 94/97x190cm | chroom/helder | YOUNGP1001B | stuk | 698,00 | 288 | 1 |
| 0335015 | 94/97x190cm | chroom/satin | YOUNGP1004B | stuk | 698,00 | 288 | 1 |
| 0335016 | 94/97x190cm | chroom/gothic | YOUNGP1002B | stuk | 698,00 | 288 | 1 |

| | Art.nr | Specificaties | Kleur | Lev.nr | Ehd | Prijs | Grp | CC |
|---|---|---------------|-----------|---------|------|--------|-----|----|
| Sanitair producten | Plieger Class douchewanden | | | | | | | |
| | douhecabine hoekinstap 3mm glas | | | | | | | |
| | 4283012 | 80/90x185cm | wit | 4283012 | stuk | 326,00 | 269 | 0 |
| | 4283014 | 80/90x185cm | aluminium | 4283014 | stuk | 326,00 | 269 | 0 |
| Baden / douchebakken / stoomcabines | douhecabine kwartrond 3mm glas | | | | | | | |
| | 4283016 | 88/92x185cm | wit | 4283016 | stuk | 462,00 | 269 | 0 |
| Kranen | 4283018 | 88/92x185cm | aluminium | 4283018 | stuk | 462,00 | 269 | 0 |
| | douhecabine vijfhoekig 3mm glas | | | | | | | |
| Douchegarnituur | 4283020 | 86/92x185cm | wit | 4283020 | stuk | 326,00 | 269 | 1 |
| | 4283022 | 86/92x185cm | aluminium | 4283022 | stuk | 326,00 | 269 | 1 |
| Accessoires en spiegels | | | | | | | | |
| Douchewanden | draaideur 3mm glas | | | | | | | |
| | 4283044 | 90x185cm | wit | 4283044 | stuk | 197,00 | 269 | 0 |
| Toebehoren & afvoeren | 4283046 | 90x185cm | aluminium | 4283046 | stuk | 197,00 | 269 | 0 |
| | zijwand 3mm glas | | | | | | | |
| Spoel- & installatiesystemen | 4283048 | 90x185cm | wit | 4283048 | stuk | 168,00 | 269 | 0 |
| | 4283050 | 90x185cm | aluminium | 4283050 | stuk | 168,00 | 269 | 0 |
| Badkamermeubelen en toiletkasten | | | | | | | | |
| Gootstenen en wastroggen | Plieger Economy douchewanden | | | | | | | |
| | douhecabine hoekinstap 2.2mm acryl | | | | | | | |
| | 4283000 | 80/90x185cm | aluminium | 4283000 | stuk | 163,00 | 269 | 0 |
| | 4283002 | 80/90x185cm | wit | 4283002 | stuk | 163,00 | 269 | 0 |
| Utiliteit | douhecabine kwartrond 2.2mm acryl | | | | | | | |
| | 4283006 | 88/92x185cm | aluminium | 4283006 | stuk | 329,00 | 269 | 0 |
| | 4283004 | 88/92x185cm | wit | 4283004 | stuk | 329,00 | 269 | 0 |
| | schuifdeur 3-delig 2.2mm acryl | | | | | | | |
| | 4283010 | 88/94x185cm | aluminium | 4283010 | stuk | 257,00 | 269 | 0 |
| | 4283008 | 88/94x185cm | wit | 4283008 | stuk | 257,00 | 269 | 0 |
| | Plieger Royal douchewanden | | | | | | | |
| | hoekinstap 2-delig 6mm glas | | | | | | | |
| | 4283024 | 88/90x185cm | chrom | 4283024 | stuk | 484,00 | 269 | 0 |

| Art.nr | Specificaties | Kleur | Lev.nr | Ehd | Prijs | Grp | CC |
|--------|---------------|-------|--------|-----|-------|-----|----|
|--------|---------------|-------|--------|-----|-------|-----|----|

Plieger Royal douchewanden

hoekinstap 1/4 rond 6mm glas
4283026 90x185cm

chroom 4283026 stuk 691,00 269 0



Sanitair producten

Baden /
douchebakken /
stoomcabines

draaideur 6mm glas
4283030 88/92x185cm

chroom 4283030 stuk 332,00 269 0



Kranen

Douchegarnituur

hoekinstap m. vaste zijwand 6mm glas
4283034 88/90x185cm

chroom 4283034 stuk 587,00 269 0



Accessoires en
spiegels

pendeldeur 6mm glas
4283036 88/90x185cm

chroom 4283036 stuk 358,00 269 0

Douchewanden

Plieger badklapwanden

badklapwand 2.2mm acryl
4283042 120x140cm

wit 4283042 stuk 124,00 269 0



Toebehoren &
afvoeren

Spoel- &
installatiesystemen

badklapwand 6mm glas
4283038 68x140cm

chroom 4283038 stuk 191,00 269 0



Badkamermeubelen
en toiletkasten

Gootstenen en
wastroggen

4283040 70/40x140cm

chroom 4283040 stuk 289,00 269 0



Utiliteit

| | Art.nr | Specificaties | Kleur | Lev.nr | Ehd | Prijs | Grp | CC |
|---|---|---------------|-----------------|---------|------|--------|-----|----|
| Sanitair producten | Riho Nordica | | | | | | | |
| | hoekinstap 2-delig | | | | | | | |
| | 0311155 | 90x90x195cm | wit/magicglass | GN11200 | stuk | 675,00 | 291 | 1 |
| | 0311156 | 90x90x195cm | alu./magicglass | GN12200 | stuk | 775,00 | 291 | 1 |
| Baden / douchebakken / stoomcabines | douchecabine kwarttrond m. draaideuren | | | | | | | |
| | 0311157 | 90x90x195cm | wit/magicglass | GN01200 | stuk | 725,00 | 291 | 1 |
| | 0311158 | 90x90x195cm | alu./magicglass | GN02200 | stuk | 825,00 | 291 | 1 |
| Kranen | douchecabine vijfhoekig m. draaideuren | | | | | | | |
| | 0311159 | 90x90x195cm | wit/magicglass | GN41200 | stuk | 725,00 | 291 | 1 |
| | 0311160 | 90x90x195cm | alu./magicglass | GN42200 | stuk | 825,00 | 291 | 1 |
| Douchegarnituur | badklapwand 1-delig | | | | | | | |
| | 0311164 | 75x140cm | wit/magicglass | GN31200 | stuk | 295,00 | 291 | 1 |
| | 0311165 | 75x140cm | alu./magicglass | GN32200 | stuk | 325,00 | 291 | 1 |
| Accessoires en spiegels | badkamermeubelen en toiletkasten | | | | | | | |
| | Gootstenen en wastroggen | | | | | | | |
| | Utiliteit | | | | | | | |

| Art.nr | Specificaties | Kleur | Lev.nr | Ehd | Prijs | Grp | CC |
|--------|---------------|-------|--------|-----|-------|-----|----|
|--------|---------------|-------|--------|-----|-------|-----|----|

Shower Collection Adelaide

glasplaat combinatie

| | | | | | | | |
|---------|-------------|--|-------------|------|---------|-----|---|
| 2301302 | 60x50x50cm | | ADELAIDE60 | stuk | 1499,00 | 294 | 1 |
| 2301256 | 70x50x50cm | | ADELAIDE70 | stuk | 1499,00 | 294 | 1 |
| 2301303 | 80x50x50cm | | ADELAIDE80 | stuk | 1549,00 | 294 | 1 |
| 2301257 | 90x50x50cm | | ADELAIDE90 | stuk | 1549,00 | 294 | 1 |
| 2301258 | 100x50x50cm | | ADELAIDE100 | stuk | 1599,00 | 294 | 1 |

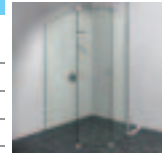

Sanitair producten

Baden /
douchebakken /
stoomcabines

Shower Collection Auckland

glasplaat combinatie

| | | | | | | | |
|---------|---------|--|-------------|------|---------|-----|---|
| 2301285 | 40xR50 | | AUCKLAND40 | stuk | 1499,00 | 294 | 1 |
| 2301247 | 50xR50 | | AUCKLAND50 | stuk | 1499,00 | 294 | 1 |
| 2301286 | 60xR50 | | AUCKLAND60 | stuk | 1549,00 | 294 | 1 |
| 2301248 | 70xR50 | | AUCKLAND70 | stuk | 1549,00 | 294 | 1 |
| 2301287 | 80xR50 | | AUCKLAND80 | stuk | 1599,00 | 294 | 1 |
| 2301249 | 90xR50 | | AUCKLAND90 | stuk | 1599,00 | 294 | 1 |
| 2301250 | 100xR50 | | AUCKLAND100 | stuk | 1629,00 | 294 | 1 |

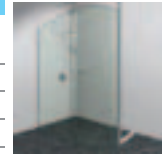

Kranen

Douchegarnituur

glasplaat combinatie m. Preston 50

| | | | | | | | |
|---------|---------|--|------------------|------|---------|-----|---|
| 2301304 | 40xR50 | | AUCKLAND PLUS40 | stuk | 2328,00 | 294 | 1 |
| 2301251 | 50xR50 | | AUCKLAND PLUS50 | stuk | 2328,00 | 294 | 1 |
| 2301305 | 60xR50 | | AUCKLAND PLUS60 | stuk | 2378,00 | 294 | 1 |
| 2301252 | 70xR50 | | AUCKLAND PLUS70 | stuk | 2378,00 | 294 | 1 |
| 2301306 | 80xR50 | | AUCKLAND PLUS80 | stuk | 2428,00 | 294 | 1 |
| 2301254 | 90xR50 | | AUCKLAND PLUS90 | stuk | 2428,00 | 294 | 1 |
| 2301255 | 100xR50 | | AUCKLAND PLUS100 | stuk | 2458,00 | 294 | 1 |

Accessoires en
spiegels

Douchewanden

Shower Collection Brisbane

glasplaat combinatie

| | | | | | | | |
|---------|-------------|--|-------------|------|---------|-----|---|
| 2301291 | 50x40x50cm | | BRISBANE40 | stuk | 1499,00 | 294 | 1 |
| 2301238 | 50x50x50cm | | BRISBANE50 | stuk | 1499,00 | 294 | 1 |
| 2301292 | 50x60x50cm | | BRISBANE60 | stuk | 1559,00 | 294 | 1 |
| 2301239 | 50x70x50cm | | BRISBANE70 | stuk | 1559,00 | 294 | 1 |
| 2301293 | 50x80x50cm | | BRISBANE80 | stuk | 1599,00 | 294 | 1 |
| 2301240 | 50x90x50cm | | BRISBANE90 | stuk | 1599,00 | 294 | 1 |
| 2301241 | 50x100x50cm | | BRISBANE100 | stuk | 1649,00 | 294 | 1 |

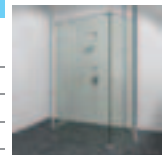
Toebehoren &
afvoerenSpoel- &
installatiesystemen

Shower Collection Canberra

glasplaat combinatie

| | | | | | | | |
|---------|----------|--|-------------|------|---------|-----|---|
| 2301264 | 70x50cm | | CANBERRA70 | stuk | 1219,00 | 294 | 1 |
| 2301284 | 80x50cm | | CANBERRA80 | stuk | 1249,00 | 294 | 1 |
| 2301265 | 90x50cm | | CANBERRA90 | stuk | 1249,00 | 294 | 1 |
| 2301266 | 100x50cm | | CANBERRA100 | stuk | 1299,00 | 294 | 1 |

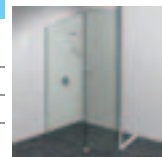
Badkamermeubelen
en toiletkastenGootstenen en
wastroggen

glasplaat combinatie m. Preston 50

| | | | | | | | |
|---------|----------|--|------------------|------|---------|-----|---|
| 2301267 | 70x50cm | | CANBERRA PLUS70 | stuk | 2048,00 | 294 | 1 |
| 2301308 | 80x50cm | | CANBERRA PLUS80 | stuk | 2078,00 | 294 | 1 |
| 2301268 | 90x50cm | | CANBERRA PLUS90 | stuk | 2078,00 | 294 | 1 |
| 2301269 | 100x50cm | | CANBERRA PLUS100 | stuk | 2128,00 | 294 | 1 |

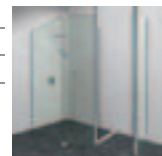

Utiliteit

Shower Collection Melbourne

glasplaat combinatie

| | | | | | | | |
|---------|-------------|--|--------------|------|---------|-----|---|
| 2301294 | R50x40xR50 | | MELBOURNE40 | stuk | 2299,00 | 294 | 1 |
| 2301242 | R50x50xR50 | | MELBOURNE50 | stuk | 2299,00 | 294 | 1 |
| 2301295 | R50x60xR50 | | MELBOURNE60 | stuk | 2349,00 | 294 | 1 |
| 2301243 | R50x70xR50 | | MELBOURNE70 | stuk | 2349,00 | 294 | 1 |
| 2301297 | R50x80xR50 | | MELBOURNE80 | stuk | 2399,00 | 294 | 1 |
| 2301244 | R50x90xR50 | | MELBOURNE90 | stuk | 2399,00 | 294 | 1 |
| 2301246 | R50x100xR50 | | MELBOURNE100 | stuk | 2449,00 | 294 | 1 |

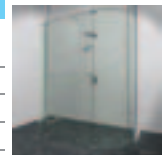

Shower Collection Portland

glasplaat combinatie

| | | | | | | | |
|---------|-------------|--|-------------|------|---------|-----|---|
| 2301300 | 50x60x50cm | | PORTLAND60 | stuk | 1499,00 | 294 | 1 |
| 2301270 | 50x70x50cm | | PORTLAND70 | stuk | 1499,00 | 294 | 1 |
| 2301301 | 50x80x50cm | | PORTLAND80 | stuk | 1549,00 | 294 | 1 |
| 2301271 | 50x90x50cm | | PORTLAND90 | stuk | 1549,00 | 294 | 1 |
| 2301272 | 50x100x50cm | | PORTLAND100 | stuk | 1599,00 | 294 | 1 |

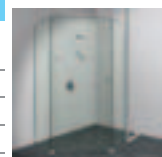

| | Art.nr | Specificaties | Kleur | Lev.nr | Ehd | Prijs | Grp | CC |
|---|--|---------------|-------|------------------|------|---------|-----|----|
| | Shower Collection Preston | | | | | | | |
| Sanitair producten | glasplaat | | | | | | | |
| | 2301273 | 50cm | | PRESTON50 | stuk | 829,00 | 294 | 1 |
| | 2301289 | 60cm | | PRESTON60 | stuk | 879,00 | 294 | 1 |
| | 2301274 | 70cm | | PRESTON70 | stuk | 879,00 | 294 | 1 |
| | 2301290 | 80cm | | PRESTON80 | stuk | 927,00 | 294 | 1 |
| | 2301275 | 90cm | | PRESTON90 | stuk | 927,00 | 294 | 1 |
| | 2301276 | 100cm | | PRESTON100 | stuk | 987,00 | 294 | 1 |
| Baden / douchebakken / stoomcabines | 2301277 | 120cm | | PRESTON120 | stuk | 999,00 | 294 | 1 |
| | Shower Collection Round Innovation | | | | | | | |
| Kranen | ronde douchedeure m. 3 scharnieren en aanslag profiel | | | | | | | |
| | 2301281 | | | ROUND INNOVATION | stuk | 1599,00 | 294 | 1 |
| | Shower Collection Sydney | | | | | | | |
| Douchegarnituur | glasplaat combinatie | | | | | | | |
| | 2301283 | 80x50cm | | SYDNEY80 | stuk | 1249,00 | 294 | 1 |
| | 2301259 | 90x50cm | | SYDNEY90 | stuk | 1249,00 | 294 | 1 |
| | 2301260 | 100x50cm | | SYDNEY100 | stuk | 1299,00 | 294 | 1 |
| Accessoires en spiegels | glasplaat combinatie m. Preston 50 | | | | | | | |
| | 2301307 | 80x50cm | | SYDNEY PLUS80 | stuk | 2078,00 | 294 | 1 |
| | 2301262 | 90x50cm | | SYDNEY PLUS90 | stuk | 2078,00 | 294 | 1 |
| Douchewanden | 2301263 | 100x50cm | | SYDNEY PLUS100 | stuk | 2128,00 | 294 | 1 |
| | Shower Collection Wellington | | | | | | | |
| Toebehoren & afvoeren | glasplaat | | | | | | | |
| | 2301298 | 70cm | | WELLINGTON70 | stuk | 979,00 | 294 | 1 |
| Spoel- & installatiesystemen | 2301299 | 80cm | | WELLINGTON80 | stuk | 999,00 | 294 | 1 |
| | 2301278 | 90cm | | WELLINGTON90 | stuk | 999,00 | 294 | 1 |
| | 2301279 | 100cm | | WELLINGTON100 | stuk | 1059,00 | 294 | 1 |
| | 2301280 | 120cm | | WELLINGTON120 | stuk | 1099,00 | 294 | 1 |
| | Badkamermeubelen en toiletkasten | | | | | | | |
| Gootstenen en wastroggen | | | | | | | | |
| Utiliteit | | | | | | | | |

| Art.nr | Specificaties | Kleur | Lev.nr | Ehd | Prijs | Grp | CC |
|--------|---------------|-------|--------|-----|-------|-----|----|
|--------|---------------|-------|--------|-----|-------|-----|----|

Sphinx Atlanta

| | | | | | | | |
|----------------------------|-----------|--------------------|---------------|---------------|------|---------|-------|
| badklapwand | | | | | | | |
| 0331342 | 70x140cm | links | helder/chroom | S8AT91916301L | stuk | 482,00 | 276 1 |
| 0331344 | 70x140cm | links m. glasPlus | helder/chroom | S8AT91916321L | stuk | 595,00 | 276 1 |
| 0331343 | 70x140cm | rechts | helder/chroom | S8AT91916301R | stuk | 482,00 | 276 1 |
| 0331345 | 70x140cm | rechts m. glasPlus | helder/chroom | S8AT91916321R | stuk | 595,00 | 276 1 |
| badklapwand 2-delig | | | | | | | |
| 0331346 | 95x140cm | links | helder/chroom | S8AT92946301L | stuk | 803,00 | 276 1 |
| 0331348 | 95x140cm | links m. glasPlus | helder/chroom | S8AT92946321L | stuk | 916,00 | 276 1 |
| 0331347 | 95x140cm | rechts | helder/chroom | S8AT92946301R | stuk | 803,00 | 276 1 |
| 0331349 | 95x140cm | rechts m. glasPlus | helder/chroom | S8AT92946321R | stuk | 916,00 | 276 1 |
| badklapwand 3-delig | | | | | | | |
| 0331350 | 140x140cm | links | helder/chroom | S8AT93956301L | stuk | 1151,00 | 276 1 |
| 0331352 | 140x140cm | links m. glasPlus | helder/chroom | S8AT93956321L | stuk | 1264,00 | 276 1 |
| 0331351 | 140x140cm | rechts | helder/chroom | S8AT93956301R | stuk | 1151,00 | 276 1 |
| 0331353 | 140x140cm | rechts m. glasPlus | helder/chroom | S8AT93956321R | stuk | 1264,00 | 276 1 |

Sphinx Avant

| | | | | | | | |
|------------------------------|-----------|-------------|-------------|--------------|------|--------|-------|
| DF95 badwand 2-delig | | | | | | | |
| 0333182 | 95x140cm | | wit/helder | S8AV92940201 | stuk | 527,00 | 276 0 |
| 0333190 | 95x140cm | | alu./helder | S8AV92940101 | stuk | 527,00 | 276 1 |
| 0333948 | 95x140cm | m. glasPlus | wit/helder | S8AV92940221 | stuk | 640,00 | 276 1 |
| 0333956 | 95x140cm | m. glasPlus | alu./helder | S8AV92940121 | stuk | 640,00 | 276 1 |
| DF140 badwand 3-delig | | | | | | | |
| 0333204 | 140x140cm | | wit/helder | S8AV93950201 | stuk | 600,00 | 276 1 |
| 0333212 | 140x140cm | | alu./helder | S8AV93950101 | stuk | 600,00 | 276 1 |
| 0333964 | 140x140cm | m. glasPlus | wit/helder | S8AV93950221 | stuk | 593,00 | 276 1 |
| 0333972 | 140x140cm | m. glasPlus | alu./helder | S8AV93950121 | stuk | 713,00 | 276 1 |

Sphinx Supratop

| | | | | | | | |
|-------------------------------|-------------|-------------|-------------|--------------|------|--------|-------|
| FTWST draaideur links | | | | | | | |
| 0988987 | 86.4/90x185 | | wit/helder | S8ST31150201 | stuk | 556,00 | 276 1 |
| 0333271 | 86.4/90x185 | | alu./helder | S8ST31150101 | stuk | 556,00 | 276 0 |
| 0334251 | 86.4/90x185 | m. glasPlus | wit/helder | S8ST31150221 | stuk | 669,00 | 276 1 |
| 0334189 | 86.4/90x185 | m. glasPlus | alu./helder | S8ST31150121 | stuk | 669,00 | 276 1 |
| FTWST draaideur rechts | | | | | | | |
| 0996750 | 86.4/90x185 | | wit/helder | S8ST21150201 | stuk | 556,00 | 276 1 |
| 0333298 | 86.4/90x185 | | alu./helder | S8ST21150101 | stuk | 556,00 | 276 0 |
| 0334383 | 86.4/90x185 | m. glasPlus | wit/helder | S8ST21150221 | stuk | 669,00 | 276 1 |
| 0334197 | 86.4/90x185 | m. glasPlus | alu./helder | S8ST21150121 | stuk | 669,00 | 276 1 |
| PTST klapdeur | | | | | | | |
| 0989010 | 86.4/90x185 | | wit/helder | S8ST28150201 | stuk | 613,00 | 276 1 |
| 0989002 | 86.4/90x185 | | alu./helder | S8ST28150101 | stuk | 613,00 | 276 1 |
| 0334294 | 86.4/90x185 | m. glasPlus | wit/helder | S8ST28150221 | stuk | 726,00 | 276 1 |
| 0334286 | 86.4/90x185 | m. glasPlus | alu./helder | S8ST28150121 | stuk | 726,00 | 276 1 |

| | | | | | | | |
|----------------------------------|----------|-------------|-------------|--------------|------|---------|-------|
| VKPST draaideur kwartrond | | | | | | | |
| 0989037 | 90x185cm | | wit/helder | S8ST63320201 | stuk | 944,00 | 276 1 |
| 0989029 | 90x185cm | | alu./helder | S8ST63320101 | stuk | 944,00 | 276 0 |
| 0334316 | 90x185cm | m. glasPlus | wit/helder | S8ST63320221 | stuk | 1171,00 | 276 1 |
| 0334308 | 90x185cm | m. glasPlus | alu./helder | S8ST63320121 | stuk | 1171,00 | 276 1 |

Sphinx Terrashower

| | | | | | | | |
|---------------------|-----------|----------------------|---------------|--------------|------|---------|-------|
| douchescherf | | | | | | | |
| 0333183 | 188x191cm | m. frame m. glasPlus | chroom/helder | S8TR81976321 | stuk | 4293,00 | 276 1 |

Sphinx Twiggytop

| | | | | | | | |
|--|----------|--|-------------|--------------|------|--------|-------|
| EDSTT2 hoekinstap 2-delig m. schuifdeuren | | | | | | | |
| 0332933 | 90x185cm | | wit/helder | S8TW02440201 | stuk | 494,00 | 276 1 |
| 0333042 | 90x185cm | | alu./helder | S8TW02440401 | stuk | 494,00 | 276 1 |

Sanitair producten

Baden /
douchebakken /
stoomcabines

Kranen

Douchegarnituur

Accessoires en
spiegels

Douchewanden

Toebehoren &
afvoerenSpoel- &
installatiesystemenBadkamermeubelen
en toiletkastenGootstenen en
wastroggen

Utiliteit

| | Art.nr | Specificaties | Kleur | Lev.nr | Ehd | Prijs | Grp | CC | |
|--|--|------------------------|--------------|--------------|--------------|---------|--------|-----|---|
| | Sphinx Twiggytop | | | | | | | | |
| Sanitair producten | EDPTT2 hoekinstap 2-delig m. draaideuren | | | | | | | | |
| | 0332941 | 90x185cm | wit/helder | S8TW03440201 | stuk | 494,00 | 276 | 1 | |
| | 0333050 | 90x185cm | alu./helder | S8TW03440401 | stuk | 494,00 | 276 | 1 | |
| Baden / douchebakken / stoomcabines | DSTT schuifdeur 3-delig | | | | | | | | |
| | 0332968 | 90x185cm | wit/helder | S8TW11150201 | stuk | 465,00 | 276 | 1 | |
| | 0333069 | 90x185cm | alu./helder | S8TW11150401 | stuk | 465,00 | 276 | 1 | |
| Kranen | DPTT pendeldeur | | | | | | | | |
| | 0332976 | 90x185cm | wit/helder | S8TW28150201 | stuk | 465,00 | 276 | 1 | |
| | 0333077 | 90x185cm | alu./helder | S8TW28150401 | stuk | 465,00 | 276 | 1 | |
| Douchegarnituur | | | | | | | | | |
| Accessoires en spiegels | draaideur | | | | | | | | |
| | 0332934 | 75x185cm | wit/helder | S8TW38120201 | stuk | 387,00 | 276 | 1 | |
| | 0332935 | 75x185cm | alu./helder | S8TW38120401 | stuk | 387,00 | 276 | 1 | |
| Douchewanden | | 0332936 | 80x185cm | wit/helder | S8TW38130201 | stuk | 399,00 | 276 | 1 |
| | | 0332937 | 80x185cm | alu./helder | S8TW38130401 | stuk | 399,00 | 276 | 1 |
| | | 0332938 | 90x185cm | wit/helder | S8TW38150201 | stuk | 399,00 | 276 | 1 |
| | | 0332939 | 90x185cm | alu./helder | S8TW38150401 | stuk | 399,00 | 276 | 1 |
| | | TDTT vaste wand | | | | | | | |
| Toebehoren & afvoeren | 0333034 | 90x185cm | wit/helder | S8TW51150201 | stuk | 219,00 | 276 | 1 | |
| | 0333123 | 90x185cm | alu./helder | S8TW51150401 | stuk | 219,00 | 276 | 1 | |
| Spoel- & installatiesystemen | VKSTT douhecabine kwartrond m. schuifdeuren | | | | | | | | |
| | 0332984 | 90x185cm | wit/helder | S8TW61320201 | stuk | 751,00 | 276 | 1 | |
| | 0333085 | 90x185cm | alu./helder | S8TW61320401 | stuk | 751,00 | 276 | 0 | |
| Badkamermeubelen en toiletkasten | | | | | | | | | |
| Gootstenen en wastroggen | VKPTT douhecabine kwartrond m. draaideuren | | | | | | | | |
| | 0332992 | 90x185cm | wit/helder | S8TW63320201 | stuk | 751,00 | 276 | 1 | |
| | 0333093 | 90x185cm | alu./helder | S8TW63320401 | stuk | 751,00 | 276 | 1 | |
| Utiliteit | FEPTT douhecabine vijfhoekig m. draaideuren | | | | | | | | |
| | 0333018 | 90x185cm | wit/helder | S8TW72340201 | stuk | 630,00 | 276 | 1 | |
| | 0333107 | 90x185cm | alu./helder | S8TW72340401 | stuk | 630,00 | 276 | 1 | |
| | 0333026 | 100x185cm | wit/helder | S8TW72570201 | stuk | 664,00 | 276 | 1 | |
| | 0333115 | 100x185cm | alu./helder | S8TW72570401 | stuk | 664,00 | 276 | 1 | |
| Sphinx Vision-A | | | | | | | | | |
| douhecabine hoekinstap 2-delig | | | | | | | | | |
| | 0333119 | 90x195cm | chrom/helder | S8VA03346301 | stuk | 1845,00 | 276 | 1 | |
| | 0333120 | 100x195cm | chrom/helder | S8VA03726301 | stuk | 1874,00 | 276 | 1 | |
| douhecabine vijfhoekig m. draaideuren | | | | | | | | | |
| | 0333130 | 90x195cm | chrom/helder | S8VA72046301 | stuk | 1874,00 | 276 | 1 | |
| | 0333132 | 100x195cm | chrom/helder | S8VA72276301 | stuk | 1902,00 | 276 | 1 | |
| douhecabine vijfhoekig m. 2 deuren | | | | | | | | | |
| | 0333138 | 100x195cm | chrom/helder | S8VA72286301 | stuk | 1902,00 | 276 | 1 | |
| draaideur | | | | | | | | | |
| | 0333121 | 80x195cm | chrom/helder | S8VA38376301 | stuk | 909,00 | 276 | 1 | |
| | 0333122 | 90x195cm | chrom/helder | S8VA38396301 | stuk | 938,00 | 276 | 0 | |
| | 0333124 | 100x195cm | chrom/helder | S8VA38406301 | stuk | 966,00 | 276 | 1 | |

| Art.nr | Specificaties | Kleur | Lev.nr | Ehd | Prijs | Grp | CC |
|--|------------------|---------------|---------------|------|---------|-----|----|
| Sphinx Vision-A | | | | | | | |
| vaste wand | | | | | | | |
| 0333125 | 80x195cm rechts | chroom/helder | S8VA51376301R | stuk | 739,00 | 276 | 1 |
| 0333133 | 80x195cm links | chroom/helder | S8VA51376301L | stuk | 739,00 | 276 | 1 |
| 0333126 | 90x195cm rechts | chroom/helder | S8VA51396301R | stuk | 767,00 | 276 | 0 |
| 0333134 | 90x195cm links | chroom/helder | S8VA51396301L | stuk | 767,00 | 276 | 1 |
| 0333127 | 100x195cm rechts | chroom/helder | S8VA51406301R | stuk | 796,00 | 276 | 1 |
| 0333135 | 100x195cm links | chroom/helder | S8VA51406301L | stuk | 796,00 | 276 | 1 |
| douchecabine kwartrond m. draaideuren | | | | | | | |
| 0333128 | 90x195cm | chroom/helder | S8VA63016301 | stuk | 1874,00 | 276 | 1 |
| 0333129 | 100x195cm | chroom/helder | S8VA63736301 | stuk | 1902,00 | 276 | 1 |
| douchecabine kwartrond m. 2 deuren | | | | | | | |
| 0333136 | 90x195cm | chroom/helder | S8VA63026301 | stuk | 1874,00 | 276 | 1 |
| 0333137 | 90x195cm | chroom/helder | S8VA63076301 | stuk | 1874,00 | 276 | 1 |

Sanitair producten

Baden /
douchebakken /
stoomcabines

Kranen

Douchegarnituur

Accessoires en
spiegels**Douchewanden**Toebehoren &
afvoerenSpoel- &
installatiesystemenBadkamermeubelen
en toiletkastenGootstenen en
wastroggen

Utiliteit

| | Art.nr | Specificaties | Kleur | Lev.nr | Ehd | Prijs | Grp | CC |
|---|---|-------------------------------------|--------|-------------------|------|---------|-----|----|
| | Ucosan Vitoria | | | | | | | |
| | douchecabine hoekuitvoering m. 2 draaideuren | | | | | | | |
| Sanitair producten | 0949655 | 90x190cm | wit | DW0090VIT120U01 | stuk | 1040,00 | 279 | 1 |
| | 0933481 | 90x190cm | chroom | DW0090VIT120U61 | stuk | 1248,00 | 279 | 1 |
| | 0949809 | 100x190cm | wit | DW0100VIT120U01 | stuk | 1109,00 | 279 | 1 |
| | 0933635 | 100x190cm | chroom | DW0100VIT120U61 | stuk | 1331,00 | 279 | 1 |
| | douchecabine m. vaste wand m. draaideur | | | | | | | |
| Baden / douchebakken / stoomcabines | 0949663 | 90x190cm | wit | DW0090VIT130U01 | stuk | 939,00 | 279 | 1 |
| | 0933503 | 90x190cm | chroom | DW0090VIT130U61 | stuk | 1127,00 | 279 | 1 |
| | 0949817 | 100x190cm | wit | DW0100VIT130U01 | stuk | 985,00 | 279 | 1 |
| | 0933643 | 100x190cm | chroom | DW0100VIT130U61 | stuk | 1182,00 | 279 | 1 |
| Kranen | 0949671 | 120x90x190cm | wit | DW1209VIT140U01 | stuk | 1109,00 | 279 | 1 |
| | 0933511 | 120x90x190cm | chroom | DW1209VIT140U61 | stuk | 1331,00 | 279 | 1 |
| | | vaste wand voor inloofdouche | | | | | | |
| Douchegarnituur | 0949698 | 90x190cm | wit | DW0090VIT182U01 | stuk | 418,00 | 279 | 1 |
| | 0933538 | 90x190cm | chroom | DW0090VIT182U61 | stuk | 502,00 | 279 | 1 |
| | 0949825 | 100x190cm | wit | DW0100VIT182U01 | stuk | 431,00 | 279 | 1 |
| | 0933651 | 100x190cm | chroom | DW0100VIT182U61 | stuk | 517,00 | 279 | 1 |
| | klapdeur dubbel voor nis | | | | | | | |
| Accessoires en spiegels | 0949701 | 90x190cm | wit | DW0090VIT106U01 | stuk | 656,00 | 279 | 1 |
| | 0933546 | 90x190cm | chroom | DW0090VIT106U61 | stuk | 787,00 | 279 | 1 |
| | draaideur voor nis | | | | | | | |
| Douchewanden | 0949728 | 90x190cm | wit | DW0090VIT100U01 | stuk | 612,00 | 279 | 1 |
| | 0933554 | 90x190cm | chroom | DW0090VIT100U61 | stuk | 734,00 | 279 | 1 |
| | 0949833 | 100x190cm | wit | DW0100VIT100U01 | stuk | 668,00 | 279 | 1 |
| | 0933678 | 100x190cm | chroom | DW0100VIT100U61 | stuk | 802,00 | 279 | 1 |
| | draaideur voor nis m. vaste wand | | | | | | | |
| Toebehoren & afvoeren | 0949736 | 120x190cm | wit | DW0120VIT110U01 | stuk | 668,00 | 279 | 1 |
| | 0933562 | 120x190cm | chroom | DW0120VIT110U61 | stuk | 802,00 | 279 | 1 |
| | offset links m. 2 draaideuren | | | | | | | |
| Spoel- & installatiesystemen | 0949744 | 80x100x190cm | wit | DW1008VIT160LIU01 | stuk | 1471,00 | 279 | 1 |
| | 0933570 | 80x100x190cm | chroom | DW1008VIT160LIU61 | stuk | 1765,00 | 279 | 1 |
| | offset rechts m. 2 draaideuren | | | | | | | |
| | 0949752 | 80x100x190cm | wit | DW1008VIT160REU01 | stuk | 1471,00 | 279 | 1 |
| | 0933589 | 80x100x190cm | chroom | DW1008VIT160REU61 | stuk | 1765,00 | 279 | 1 |
| | douchecabine kwartrond m. 2 draaideuren | | | | | | | |
| Badkamermeubelen en toiletkasten | 0949760 | 90x190cm | wit | DW0090VIT160U01 | stuk | 1471,00 | 279 | 1 |
| | 0933597 | 90x190cm | chroom | DW0090VIT160U61 | stuk | 1765,00 | 279 | 1 |
| | 0949841 | 100x190cm | wit | DW0100VIT160U01 | stuk | 1583,00 | 279 | 1 |
| | 0933686 | 100x190cm | chroom | DW0100VIT160U61 | stuk | 1900,00 | 279 | 1 |
| | douchecabine vijfhoekig m. 2 draaideuren | | | | | | | |
| Gootstenen en wastroggen | 0949779 | 90x190cm | wit | DW0090VIT150U01 | stuk | 1471,00 | 279 | 1 |
| | 0933600 | 90x190cm | chroom | DW0090VIT150U61 | stuk | 1765,00 | 279 | 1 |
| | 0949868 | 100x190cm | wit | DW0100VIT150U01 | stuk | 1583,00 | 279 | 1 |
| | 0933694 | 100x190cm | chroom | DW0100VIT150U61 | stuk | 1900,00 | 279 | 1 |
| | badklapwand | | | | | | | |
| Utiliteit | 0949787 | 80x140cm | wit | DW0080VIT170U01 | stuk | 407,00 | 279 | 1 |
| | 0933619 | 80x140cm | chroom | DW0080VIT170U61 | stuk | 488,00 | 279 | 1 |
| | badklapwand m. vaste wand | | | | | | | |
| | 0949795 | 97x140cm | wit | DW5245VIT171U01 | stuk | 509,00 | 279 | 1 |
| | 0933627 | 97x140cm | chroom | DW5245VIT171U61 | stuk | 611,00 | 279 | 1 |

| Art.nr | Specificaties | Kleur | Lev.nr | Ehd | Prijs | Grp | CC |
|--|--------------------|----------|------------------|------|---------|-----|----|
| Villeroy & Boch Quafit | | | | | | | |
| douchecabine m. draaideur m. douchebak quaryl voor nis | | | | | | | |
| 0949450 | 90x90x220cm links | wit | DC0906QFL00L8V01 | stuk | 1253,00 | 108 | 1 |
| 0949469 | 90x90x220cm links | pergamon | DC0906QFL00L8V09 | stuk | 1253,00 | 108 | 1 |
| 0947830 | 90x90x220cm rechts | wit | DC0906QFR00L8V01 | stuk | 1253,00 | 108 | 1 |
| 0949477 | 90x90x220cm rechts | pergamon | DC0906QFR00L8V09 | stuk | 1253,00 | 108 | 1 |
| 0947806 | 100x100x220 links | wit | DC1006QFL00L8V01 | stuk | 1383,00 | 108 | 1 |
| 0947814 | 100x100x220 links | pergamon | DC1006QFL00L8V09 | stuk | 1383,00 | 108 | 1 |
| 0947911 | 100x100x220 rechts | wit | DC1006QFR00L8V01 | stuk | 1383,00 | 108 | 1 |
| 0949280 | 100x100x200 rechts | pergamon | DC1006QFR00L8V09 | stuk | 1383,00 | 108 | 1 |
| douchecabine m. draaideur m. douchebak quaryl voor hoek | | | | | | | |
| 0949485 | 90x90x220cm links | wit | DC0906QFL30L8V01 | stuk | 1669,00 | 108 | 1 |
| 0949442 | 90x90x220cm links | pergamon | DC0906QFL30L8V09 | stuk | 1669,00 | 108 | 1 |
| 0949493 | 90x90x220cm rechts | wit | DC0906QFR30L8V01 | stuk | 1669,00 | 108 | 1 |
| 0949434 | 90x90x220cm rechts | pergamon | DC0906QFR30L8V09 | stuk | 1669,00 | 108 | 1 |
| 0949299 | 100x100x220 links | wit | DC1006QFL30L8V01 | stuk | 1854,00 | 108 | 1 |
| 0949302 | 100x100x220 links | pergamon | DC1006QFL30L8V09 | stuk | 1854,00 | 108 | 1 |
| 0949310 | 100x100x220 rechts | wit | DC1006QFR30L8V01 | stuk | 1854,00 | 108 | 1 |
| 0949329 | 100x100x220 rechts | pergamon | DC1006QFR30L8V09 | stuk | 1854,00 | 108 | 1 |
| douchecabine m. douchebak quaryl kwartrond | | | | | | | |
| 0940035 | 90x90x220cm | wit | DC0906QF60L8V01 | stuk | 2180,00 | 108 | 1 |
| 0940259 | 90x90x220cm | pergamon | DC0906QF60L8V09 | stuk | 2180,00 | 108 | 1 |
| 0949337 | 100x100x220 | wit | DC1006QF60L8V01 | stuk | 2408,00 | 108 | 1 |
| 0949345 | 100x100x220 | pergamon | DC1006QF60L8V09 | stuk | 2408,00 | 108 | 1 |
| douchecabine m. douchebak quaryl vijfhoekig | | | | | | | |
| 0947792 | 100x100x220 | wit | DC1006QF50L8V01 | stuk | 2408,00 | 108 | 1 |



Sanitair producten

Baden /
douchebakken /
stoomcabines

Kranen

Douchegarnituur

Accessoires en
spiegels

Douchewanden

Toebehoren &
afvoeren

Spoel- &
installatiesystemen

Badkamermeubelen
en toiletkasten

Gootstenen en
wastroggen

Utiliteit

| Art.nr | Specificaties | Kleur | Lev.nr | Ehd | Prijs | Grp | CC |
|---|---------------|-------|--------|------|--------|-----|----|
| Sanishield | | | | | | | |
| oppervlaktebeschermer flacon 300ml per display à 12stuks | | | | | | | |
| 0999800 | | | SR510 | stuk | 177,00 | 281 | 0 |
| preclean reinigingspasta 300ml per display à 12stuks | | | | | | | |
| 0999805 | | | SR515 | stuk | 118,00 | 281 | 0 |

Sanitair producten

Baden /
douchebakken /
stoomcabines

Kranen

Douchegarnituur

Accessoires en
spiegels**Douchewanden**Toebehoren &
afvoerenSpoel- &
installatiesystemenBadkamermeubelen
en toiletkastenGootstenen en
wastroggen

Utiliteit

Toebehoren & afvoeren

| | |
|---------------------------------------|------|
| Toebehoren fontein | 1120 |
| Toebehoren wastafel | 1121 |
| Toebehoren bad | 1134 |
| Afvoeren bad | 1136 |
| Afvoeren douchebak | 1141 |
| Afvoergoten Easy Drain | 1144 |
| v.d. Berg afvoergoten en designputten | 1151 |
| Toebehoren douchebak | 1152 |
| Toebehoren reservoir | 1154 |
| Toebehoren closet | 1156 |
| Toebehoren urinoir | 1159 |
| Toebehoren bidet | 1161 |



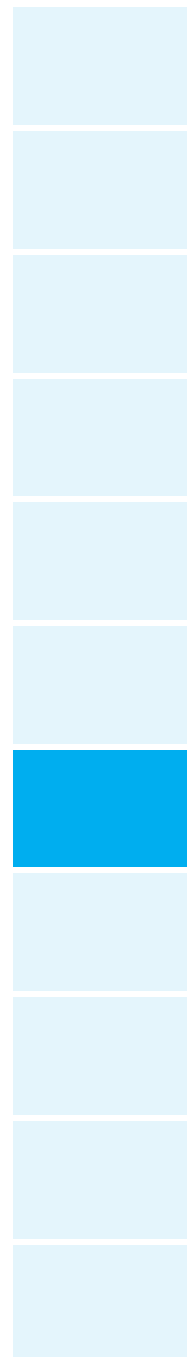



Toebehoren & afvoeren



| | Art.nr | Specificaties | Kleur | Lev.nr | Ehd | Prijs | Grp | CC |
|---|---|---------------|-------|-----------|------|-------|-----|----|
| Sanitair producten | Fontein bevestigingssets Plieger | | | | | | | |
| | plugbouten compleet voor fontein | | | | | | | |
| | 0830348 | M6x80mm | | 0830348 | paar | 1,07 | 362 | 0 |
| Baden / douchebakken / stoomcabines | bevestigingsset voor fontein | | | | | | | |
| | 0830240 | M8x90mm | | 0830240 | stuk | 0,85 | 362 | 0 |
| Kranen | Fontein bevestigingssets Keramag | | | | | | | |
| | kerafix Virto bevestigingsbeugel | | | | | | | |
| | 0082759 | | | 551064000 | stuk | 42,00 | 034 | 1 |
| Douchegarnituur | | | | | | | | |
| Accessoires en spiegels | | | | | | | | |
| Douchewanden | | | | | | | | |
| Toebehoren & afvoeren | | | | | | | | |
| Spoel- & installatiesystemen | | | | | | | | |
| Badkamermeubelen en toiletkasten | | | | | | | | |
| Gootstenen en wastroggen | | | | | | | | |
| Utiliteit | | | | | | | | |

| Art.nr | Specificaties | Kleur | Lev.nr | Ehd | Prijs | Grp | CC | |
|---|---|------------------------------------|------------|------|-------|-----|----|---|
| Wastafel bevestigingssets Plieger | | | | | | | | |
| bevestigingsset | | | | | | | | |
| 0830097 | M10x110mm | | 0830097 | paar | 1,09 | 362 | 0 | Sanitair producten |
| bevestigingsset compleet m. sierkappen | | | | | | | | |
| 0300748 | M10 | chroom | 0300748 | stuk | 3,56 | 362 | 0 | |
| set potschroeven zeskant compleet | | | | | | | | |
| 0830534 | 6x70mm | | 0830534 | stuk | 0,88 | 362 | 0 | Baden / douchebakken / stoomcabines |
| Brussel New bevestigingsset voor sifonkap | | | | | | | | |
| 0190690 | | chroom | 0190690 | stuk | 6,00 | 362 | 0 | Kranen |
| Wastafel bevestigingssets Duravit | | | | | | | | |
| snelbevestigingsset voor sifonkap | | | | | | | | |
| 0290963 | | | 0055030000 | stuk | 25,00 | 016 | 0 | |
| 0290970 | | | 0055040000 | stuk | 25,00 | 016 | 0 | Douchegarnituur |
| bevestigingsset voor sifonkap Philippe Starck | | | | | | | | |
| 0299856 | | chroom | 0067041000 | paar | 6,00 | 015 | 0 | |
| bevestigingsset m. sierknop per paar | | | | | | | | |
| 0299855 | | chroom | 0067001000 | paar | 13,00 | 017 | 1 | Accessoires en spiegels |
| verbodingsset voor stopkranen dubbele wastafel | | | | | | | | |
| 0297011 | | | 0014250000 | stuk | 47,00 | 016 | 1 | Douchewanden |
| kniehevelventiel | | | | | | | | |
| 0290509 | | chroom | 0050311000 | stuk | 55,00 | 016 | 0 | |
| 0304875 | | satinox | 50316500 | stuk | 73,00 | 016 | 1 | Toebehoren & afvoeren |
| Wastafel bevestigingssets Keramag | | | | | | | | |
| kerafix bevestigingsbeugel voor sifonkap | | | | | | | | |
| 0083003 | | | 551066000 | stuk | 42,00 | 034 | 0 | |
| 0082945 | | | 551065000 | stuk | 42,00 | 034 | 0 | |
| 0082546 | | | 551061000 | stuk | 42,00 | 034 | 1 | |
| 0080454 | | | 551067000 | stuk | 42,00 | 034 | 0 | |
| 0082686 | Virto | | 551063000 | stuk | 42,00 | 034 | 0 | |
| 0085928 | Cotta | | 551081000 | stuk | 42,00 | 034 | 1 | Badkamermeubelen en toiletkasten |
| Wastafel consoles Plieger | | | | | | | | |
| paar wastafelconsoles geplastificeerd | | | | | | | | |
| 0830011 | 24cm | | 0830011 | paar | 18,75 | 362 | 0 | |
| 0830038 | 27cm | | 0830038 | paar | 19,25 | 362 | 0 | |
| 0830046 | 35cm | | 0830046 | paar | 19,50 | 362 | 0 | |
| 0830186 | 24cm | m. 2 boutjes, rubbers en schroeven | 0830186 | paar | 21,79 | 362 | 0 | |
| 0830194 | 27cm | m. 2 boutjes, rubbers en schroeven | 0830194 | paar | 22,29 | 362 | 0 | |
| 0830216 | 24cm | m. 4 boutjes, rubbers en schroeven | 0830216 | paar | 24,37 | 362 | 1 | |
| 0830224 | 27cm | m. 4 boutjes, rubbers en schroeven | 0830224 | paar | 23,51 | 362 | 1 | |
| Wastafel consoles Toebehoren | | | | | | | | |
| 0830496 | set schroeven, rubbers en boutjes v. wastafelconsoles | | 220040025 | stuk | 3,15 | 362 | 0 | |
| 0830100 | consoleband 2 blokjes 3cm | | 120040001 | paar | 0,34 | 362 | 0 | |
| 0830119 | hamerkopboutje m. nylon stift | | 320420001 | stuk | 0,78 | 362 | 0 | |
| Wastafel ophanghaken de Beer | | | | | | | | |
| paar ophanghaken 1/2" | | | | | | | | |
| 0830089 | | zwart | 0830089 | paar | 2,70 | 362 | 0 | |
| Wastafel ophanghaken Plieger | | | | | | | | |
| paar ophanghaken 1/2" | | | | | | | | |
| 0830267 | m. 6 schroeven | zwart | 0830267 | paar | 3,84 | 362 | 0 | |
| 0830291 | | gegalvaniseerd | 0830291 | paar | 3,29 | 362 | 0 | |
| 0830305 | m. 6 schroeven | gegalvaniseerd | 0830305 | paar | 4,43 | 362 | 0 | |
| Wastafel/fontein pluggen de Beer | | | | | | | | |
| kraangatstop 40mm | | | | | | | | |
| 0850152 | | RVS | 355000001 | stuk | 3,60 | 362 | 0 | |
| roosterplaatje 50mm m. veer | | | | | | | | |
| 0560332 | | RVS | 320510100 | stuk | 1,06 | 350 | 0 | |

| | Art.nr | Specificaties | Kleur | Lev.nr | Ehd | Prijs | Grp | CC |
|---|--|----------------------------------|-----------------|---------------|--------|-------|-----|----|
| Sanitair producten | Wastafel/fontein pluggen Dornbracht | | | | | | | |
| | | afvoerplug 5/4" | | | | | | |
| | | 0470061 | chroom | 1010097000 | stuk | 22,00 | 172 | 1 |
| | | 0470322 | platina-mat | 1010097006 | stuk | 43,50 | 172 | 1 |
| Baden / douchebakken / stoomcabines | | 0470323 | chroom | 1010597000 | stuk | 29,10 | 172 | 1 |
| | | 0470324 | chroom | 1011097000 | stuk | 29,10 | 172 | 1 |
| | afvoergarnituur 5/4" compleet | | | | | | | |
| | | 0472824 | chroom | 0411010010100 | stuk | 39,25 | 172 | 1 |
| Kranen | | 0470027 | messing | 0411010010009 | stuk | 87,50 | 172 | 1 |
| | afvoergarnituur 5/4" m. kniehandel | | | | | | | |
| | | 0475181 | chroom | 1030097000 | stuk | 39,25 | 172 | 1 |
| | | 0475203 | platina-mat | 1030097006 | stuk | 79,00 | 172 | 1 |
| Douchegarnituur | | 0475211 | platina | 1030097008 | stuk | 79,00 | 172 | 1 |
| | waste 5/4" m. knop | | | | | | | |
| | | 0470192 | platina-mat | 1020597006 | stuk | 91,50 | 172 | 1 |
| Accessoires en spiegels | | 0475173 | chroom | 1020597000 | stuk | 61,00 | 172 | 1 |
| | Wastafel/fontein pluggen Duravit | | | | | | | |
| Douchewanden | | Architec afvoerplug Ø75mm | | | | | | |
| | | 0299472 | chroom | 0050241000 | stuk | 50,00 | 016 | 0 |
| | | 0305294 | satinox | 0050246500 | stuk | 69,00 | 016 | 1 |
| Toebehoren & afvoeren | overloopclip | | | | | | | |
| | | 0290202 | chroom | 1001070000 | stuk | 2,75 | 362 | 1 |
| | | 0290204 | satinox | 1001076500 | stuk | 5,00 | 362 | 0 |
| Spoel- & installatiesystemen | ruimtebesparende sifon v. meubel | | | | | | | |
| | | 0291295 5/4"x40mm | | 50070000 | stuk | 26,50 | 016 | 1 |
| Badkamermeubelen en toiletkasten | Wastafel/fontein pluggen Hansgrohe | | | | | | | |
| | | afvoerplug 5/4" | | | | | | |
| | | 0450406 | chroom | 94139000 | stuk | 46,50 | 176 | 1 |
| | | 0450407 | RVS look | 94139800 | stuk | 67,00 | 176 | 1 |
| Gootstenen en wastroggen | | 0450408 | satinox | 94139810 | stuk | 67,00 | 176 | 1 |
| | afvoerplug voor wastafel 5/4" | | | | | | | |
| Utiliteit | | 0459321 | RVS | 50001800 | stuk | 41,50 | 176 | 0 |
| | | 0453324 | chroom | 50001000 | stuk | 26,75 | 350 | 0 |
| | | 0450409 | satinox | 50001810 | stuk | 41,50 | 176 | 1 |
| | | trekknopplug 5/4" | | | | | | |
| | 0600058 | chroom | 50101000 | stuk | 35,00 | 350 | 0 | |
| | afvoerplug m. stopbediening 5/4" | | | | | | | |
| | | 0459380 | chroom | 50100000 | stuk | 44,25 | 350 | 0 |
| | | 0459399 | RVS | 50100800 | stuk | 62,00 | 350 | 0 |
| | | 0450410 | satinox | 50100810 | stuk | 58,00 | 350 | 1 |
| | | 0510480 | brushed nikkel | 50100820 | stuk | 62,00 | 350 | 1 |
| | | 0510481 | polished nikkel | 50100830 | stuk | 54,00 | 350 | 1 |
| Wastafel/fontein pluggen Keramag | | | | | | | | |
| Joly afvoerplug voor wastafel | | | | | | | | |
| | 0083283 | chroom | 521070000 | stuk | 55,00 | 034 | 1 | |
| afvoergarnituur m. inbouwsifon | | | | | | | | |
| | 0080049 | | 521323000 | stuk | 105,00 | 350 | 1 | |

| Art.nr | Specificaties | Kleur | Lev.nr | Ehd | Prijs | Grp | CC | | |
|--|---------------|-------|------------|------|-------|-----|----|---|---|
| | | | | | | | | Wastafel/fontein pluggen Kludi | |
| afvoerplug afsluitbaar m. overloop 0409405 | | chrom | 104210500 | stuk | 86,00 | 187 | 1 |  | Sanitair producten |
| afvoerplug afsluitbaar z. overloop 0409413 | | chrom | 104220500 | stuk | 74,50 | 187 | 0 |  | Baden / douchebakken / stoomcabines |
| | | | | | | | | Wastafel/fontein pluggen Plieger | |
| hostaleen plug 6/4" 70mm m. stop voor RVS aanrecht 0520586 | | | 0520586 | stuk | 2,54 | 350 | 0 |  | Douchegarnituur |
| wastafeladapter v. bevestiging wastafelkraan m. waste op wastafel z. overloop 0500170 | | chrom | 1206810001 | stuk | 2,31 | 350 | 0 | | Accessoires en spiegels |
| afvoerplug 65x5/4" z. overloop 70mm m. drukafsluiting 0500162 | | | 0500162 | stuk | 13,50 | 350 | 0 |  | Douchewanden |
| afvoerplug 65x5/4" m. overloop 70mm m. drukafsluiting 0500164 | | | 0500164 | stuk | 13,50 | 350 | 0 |  | Toebehoren & afvoeren |
| designplug z. overloop | | | | | | | | | Spoel- & installatiesystemen |
| 0500160 63mmx5/4" v. bodemdikte 15-30mm | | chrom | 0500160 | stuk | 12,75 | 350 | 0 |  | Badkamermeubelen en toiletkasten |
| 0500158 63mmx5/4" v. bodemdikte 30-45mm | | chrom | 0500158 | stuk | 12,75 | 350 | 0 | | Gootstenen en wastroggen |
| 0500156 63mmx5/4" v. bodemdikte 45-60mm | | chrom | 0500156 | stuk | 12,75 | 350 | 0 | | Utiliteit |
| afdekkap v. designplug 0500155 63x40mm | | chrom | 0500155 | stuk | 7,50 | 350 | 0 | | |
| Design afvoerplug pop-up | | | | | | | |  | |
| 4058008 5/4" vierkant | | chrom | 4058008 | stuk | 16,00 | 350 | 0 | | |
| 4058010 5/4" vierkant | | inox | 4058010 | stuk | 18,25 | 350 | 0 | | |
| 4058026 5/4" rond vlak | | chrom | 4058026 | stuk | 13,05 | 350 | 0 | | |
| 4058028 5/4" rond vlak | | inox | 4058028 | stuk | 15,23 | 350 | 0 | | |
| | | | | | | | | Wastafel/fontein pluggen Sphinx | |
| Milano / Lotus / Eurobase / Palma Bianca / Linate overloopprozet voor wastafel 0221015 | | | S8H734C00 | stuk | 5,50 | 043 | 0 | | |

| | Art.nr | Specificaties | Kleur | Lev.nr | Ehd | Prijs | Grp | CC | |
|---|---|---------------|-------------------|-------------|---------------|-------|--------|-----|---|
| Sanitair producten | Wastafel/fontein pluggen Viega | | | | | | | | |
| | simplexplug m. stop | | | | | | | | |
| | | 0500828 | 5/4" z. koppeling | chroom | 100261 | stuk | 4,75 | 350 | 0 |
| | | 0500308 | 5/4" z. koppeling | edelmessing | 129286 | stuk | 52,50 | 350 | 1 |
| | | 0500836 | 6/4" z. koppeling | chroom | 103385 | stuk | 8,50 | 350 | 0 |
| | | 0500771 | 5/4" m. koppeling | chroom | 100261+110482 | stuk | 7,58 | 350 | 0 |
| Baden / douchebakken / stoomcabines | | 0500798 | 6/4" m. koppeling | chroom | 103385 | stuk | 11,92 | 350 | 0 |
| | simplexplug m. vlak rooster | | | | | | | | |
| | | 0500879 | 5/4" z. koppeling | chroom | 104337 | stuk | 4,75 | 350 | 0 |
| Kranen | | 0500887 | 6/4" z. koppeling | chroom | 107673 | stuk | 8,70 | 350 | 0 |
| | | 0500852 | 5/4" m. koppeling | chroom | 104337+110482 | stuk | 7,58 | 350 | 0 |
| | | 0500860 | 6/4" m. koppeling | chroom | 107673+114053 | stuk | 12,12 | 350 | 0 |
| Douchegarnituur |  | | | | | | | | |
| Accessoires en spiegels | | | | | | | | | |
| Douchewanden | wastafelplug 70mm m. stop m. overloop | | | | | | | | |
| | | 0500445 | 5/4" | wit | 129040 | stuk | 24,25 | 350 | 1 |
| Toebehoren & afvoeren | afvoerplug universeel niet afsluitbaar | | | | | | | | |
| | | 0500128 | | | 492670 | stuk | 48,94 | 350 | 1 |
| Spoel- & installatiesystemen | afvoerplug universeel m. kliksluiting | | | | | | | | |
| | | 0500129 | | | 492687 | stuk | 58,80 | 350 | 1 |
| Badkamermeubelen en toiletkasten | roosterplug m. schacht | | | | | | | | |
| | | 0501417 | 5/4" z. overloop | | 112936 | stuk | 22,00 | 350 | 1 |
| | | 0300783 | 6/4" z. overloop | | 139179 | stuk | 110,00 | 350 | 1 |
| | | 0300799 | 5/4" m. overloop | | 116637 | stuk | 19,00 | 350 | 1 |
| Gootstenen en wastroggen | schachtplug v. wastafel z. overloop | | | | | | | | |
| | | 0520454 | 5/4"x60x50mm | chroom | 433703 | stuk | 38,75 | 350 | 1 |
| | | 0520527 | 5/4"x60x80mm | chroom | 433710 | stuk | 40,00 | 350 | 1 |
| Utiliteit | schachtplug z. overloop niet afsluitbaar | | | | | | | | |
| | | 0520537 | 5/4"x63x50mm | chroom | 492571 | stuk | 48,75 | 350 | 1 |
| | | 0520539 | 5/4"x63x75mm | chroom | 492557 | stuk | 53,50 | 350 | 1 |
| | plug 5/4" messing | | | | | | | | |
| | | 0520535 | | chroom | 439040 | stuk | 54,00 | 350 | 1 |
| | gootsteenplug 6/4" 70mm m. stop m. dikke ring | | | | | | | | |
| | 0500321 | | chroom | 113049 | stuk | 8,00 | 350 | 0 | |
| | gootsteenplug 6/4" voor standpijp m. stop | | | | | | | | |
| | | 0500984 | | chroom | 116910 | stuk | 12,50 | 350 | 0 |
| simplexplug m. stop m. ketting 6/4"x70mm | | | | | | | | | |
| | 0500144 | | | 106140 | stuk | 3,76 | 350 | 1 | |

| Art.nr | Specificaties | Kleur | Lev.nr | Ehd | Prijs | Grp | CC |
|--------|---------------|-------|--------|-----|-------|-----|----|
|--------|---------------|-------|--------|-----|-------|-----|----|

Inbouw afvoerbuis RM&CO

Slim Tube inbouw afvoerbuis 90°

| | | | | | | | |
|---------|-------|--|----------|--------|------|--------|-------|
| 2301400 | 750mm | | 10 stuks | STA-10 | stuk | 160,00 | 369 0 |
| 2301410 | 750mm | | per stuk | STE-01 | stuk | 19,99 | 369 0 |



Sanitair producten

Inbouwsifons Viega

inbouw afvoerset 5/4"x50/40mm

| | | | | | | | |
|---------|--|--------|--------|--|------|-------|-------|
| 0080064 | | chroom | 364465 | | stuk | 35,25 | 350 1 |
|---------|--|--------|--------|--|------|-------|-------|

Baden /
douchebakken /
stoomcabines

Sifons Geberit

inbouwsifon voor wastafel

| | | | | | | | |
|---------|-----------|-----|-----------|--|------|-------|-------|
| 0710556 | 182x335mm | wit | 151110111 | | stuk | 51,50 | 328 1 |
|---------|-----------|-----|-----------|--|------|-------|-------|

Kranen

overloopsysteem Clou

| | | | | | | | |
|---------|--|--|-----------|--|------|-------|-------|
| 0700108 | | | 152087111 | | stuk | 58,50 | 329 1 |
|---------|--|--|-----------|--|------|-------|-------|

Douchegarnituur

kunststof wastafelsifon

| | | | | | | | |
|---------|------|------------|-----------|--|------|-------|-------|
| 0710278 | 32mm | wit | 151034111 | | stuk | 21,25 | 328 1 |
| 0710279 | 32mm | verchroomd | 151034211 | | stuk | 36,25 | 328 0 |
| 0710280 | 40mm | wit | 151035111 | | stuk | 21,25 | 328 1 |
| 0710281 | 40mm | verchroomd | 151035211 | | stuk | 36,25 | 328 1 |

Accessoires en
spiegels

Toebehoren sifons Geberit

| | | | | | | | |
|---------|---------------------------------------|--|-----------|--|------|-------|-------|
| 0711006 | vloerbuis 40mm 60cm | | 152230111 | | stuk | 6,80 | 350 1 |
| 0711009 | sifon voor was-/vaatmachine 6/4"x40mm | | 152704111 | | stuk | 15,25 | 350 1 |
| 0711013 | inbouwsifon 50/56mm | | 152769001 | | stuk | 66,50 | 350 1 |
| 0711014 | wandinbouwsifon voor vaatwasser | | 152911211 | | stuk | 37,50 | 350 1 |

Douchewanden

Designsifons Dornbracht

designsifon 5/4"

| | | | | | | | |
|---------|--|-------------|------------|--|------|--------|-------|
| 0472551 | | chroom | 1004097000 | | stuk | 244,00 | 172 1 |
| 0470034 | | platina-mat | 1004097006 | | stuk | 365,00 | 172 1 |

Toebehoren &
afvoerenSpoel- &
installatiesystemen

bekersifon 5/4"

| | | | | | | | |
|---------|--|-------------|------------|--|------|--------|-------|
| 0475157 | | chroom | 1006097000 | | stuk | 169,00 | 172 0 |
| 0475165 | | platina-mat | 1006097006 | | stuk | 254,00 | 172 1 |

Badkamermeubelen
en toiletkastenGootstenen en
wastroggen

Designsifons Gessi

designsifon

| | | | | | | | | |
|---------|------|---------------------------|--------|---------|--|------|--------|-------|
| 0464287 | 5/4" | m. muurbuis 25cm m. rozet | chroom | 1377031 | | stuk | 104,00 | 169 1 |
| 0464295 | 5/4" | m. muurbuis 25cm m. rozet | inox | 1377142 | | stuk | 208,00 | 169 1 |



Utiliteit

Designsifons Hansgrohe

Flowstar Premium verstelbare designbekersifon







| | | | | | | | | |
|---------|------|----------------------|----------|----------|--|------|--------|-------|
| 0457345 | 5/4" | m. muurbuis m. rozet | chroom | 52100000 | | stuk | 103,00 | 350 0 |
| 0606200 | 5/4" | m. muurbuis m. rozet | RVS-look | 52100800 | | stuk | 144,00 | 350 0 |
| 0606219 | 5/4" | m. muurbuis m. rozet | satinox | 52100810 | | stuk | 134,00 | 350 1 |



Flowstar S Premium designbekersifon

| | | | | | | | | |
|---------|------|----------------------|--------|----------|--|------|-------|-------|
| 0452098 | 5/4" | m. muurbuis m. rozet | chroom | 52105000 | | stuk | 59,00 | 350 0 |
|---------|------|----------------------|--------|----------|--|------|-------|-------|



| | Art.nr | Specificaties | Kleur | Lev.nr | Ehd | Prijs | Grp | CC |
|---|---|------------------------------------|--------|-----------|------|--------|-----|----|
| Sanitair producten | Designsifons Hansgrohe | | | | | | | |
| | Flowstar set, designsifon m. muurbuis m. rozet | | | | | | | |
| | 0457346 | m. 2 hoekstopkranen + hulzen | chroom | 52120000 | stuk | 150,00 | 350 | 0 |
| Baden / douchebakken / stoomcabines |  | | | | | | | |
| Kranen | bekersifon | | | | | | | |
| | 0510296 | 5/4" m. muurbuis m. rozet | chroom | 52053000 | stuk | 16,75 | 350 | 0 |
| Douchegarnituur | bidetbekersifon | | | | | | | |
| | 0510295 | 5/4" m. muurbuis m. rozet | chroom | 55213000 | stuk | 20,75 | 350 | 1 |
| Accessoires en spiegels | Designsifons Kludi | | | | | | | |
| | designsifon | | | | | | | |
| | 0300762 | 5/4" m. muurbuis m. rozet | chroom | 100100500 | stuk | 46,75 | 187 | 1 |
| Douchewanden |  | | | | | | | |
| Toebehoren & afvoeren | Designsifons Plieger | | | | | | | |
| | designsifon | | | | | | | |
| | 0520065 | 5/4" m. muurbuis m. rozet | chroom | 0520065 | stuk | 58,00 | 350 | 0 |
| Douchewanden |  | | | | | | | |
| Spool- & installatiesystemen | design fonteinbekersifon rond | | | | | | | |
| | 4058024 | 5/4" m. muurbuis m. rozet | chroom | 4058024 | stuk | 39,95 | 350 | 0 |
| Badkamermeubelen en toiletkasten |  | | | | | | | |
| Gootstenen en wastroggen | Square designsifon | | | | | | | |
| | 0520068 | 5/4" m. muurbuis 35cm m. rozet | chroom | 0520068 | stuk | 104,00 | 350 | 0 |
| Utiliteit |  | | | | | | | |
| Badkamermeubelen en toiletkasten | designbekersifon | | | | | | | |
| | 4058000 | 5/4" rond m. muurbuis m. rozet | chroom | 4058000 | stuk | 34,25 | 350 | 0 |
| | 4058002 | 5/4" rond m. muurbuis m. rozet | inox | 4058002 | stuk | 38,25 | 350 | 0 |
| | 4058004 | 5/4" vierkant m. muurbuis m. rozet | chroom | 4058004 | stuk | 46,00 | 350 | 0 |
| | 4058006 | 5/4" vierkant m. muurbuis m. rozet | inox | 4058006 | stuk | 50,00 | 350 | 0 |
| Utiliteit |  | | | | | | | |
| Badkamermeubelen en toiletkasten | Designsifons Viega | | | | | | | |
| | Eleganta designbekersifon | | | | | | | |
| | 0520543 | 5/4" m. muurbuis m. rozet | chroom | 440190 | stuk | 135,00 | 350 | 1 |
| Badkamermeubelen en toiletkasten | Bekersifons Kludi | | | | | | | |
| | bekersifon | | | | | | | |
| | 0408174 | 5/4" m. muurbuis m. rozet | chroom | 101050500 | stuk | 15,50 | 350 | 1 |
| Badkamermeubelen en toiletkasten | plugbeker-flessifon | | | | | | | |
| | 0408166 | 5/4" m. muurbuis m. rozet | chroom | 100120500 | stuk | 50,50 | 350 | 0 |
| Utiliteit |  | | | | | | | |

| Art.nr | Specificaties | Kleur | Lev.nr | Ehd | Prijs | Grp | CC |
|--------|---------------|-------|--------|-----|-------|-----|----|
|--------|---------------|-------|--------|-----|-------|-----|----|

Bekersifons Kludi

Newwaves bekertion m. muurbuis 25cm

| | | | | | | | |
|---------|--|-------|-----------|------|--------|-----|---|
| 0409553 | | chrom | 570100500 | stuk | 128,00 | 187 | 1 |
|---------|--|-------|-----------|------|--------|-----|---|



Sanitair producten

Baden /
douchebakken /
stoomcabines

Bekersifons Viega

bekersifon m. muurbuis

| | | | | | | | | |
|---------|------|----------|-------|--------|------|-------|-----|---|
| 0500038 | 5/4" | m. rozet | chrom | 100674 | stuk | 15,25 | 350 | 0 |
|---------|------|----------|-------|--------|------|-------|-----|---|



Kranen

| | | | | | | | | |
|---------|------|----------|-------------|--------|------|--------|-----|---|
| 0500183 | 5/4" | m. rozet | edelmessing | 134990 | stuk | 164,00 | 350 | 1 |
|---------|------|----------|-------------|--------|------|--------|-----|---|

| | | | | | | | | |
|---------|------|----------|-----|--------|------|-------|-----|---|
| 0501476 | 5/4" | m. rozet | wit | 116255 | stuk | 66,00 | 350 | 0 |
|---------|------|----------|-----|--------|------|-------|-----|---|

| | | | | | | | | |
|---------|------|----------|-------|--------|------|-------|-----|---|
| 0500062 | 6/4" | m. rozet | chrom | 125844 | stuk | 39,75 | 350 | 0 |
|---------|------|----------|-------|--------|------|-------|-----|---|



Douchegarnituur

Accessoires en
spiegels

bekersifon m. vloerbuis 68cm

| | | | | | | | | |
|---------|------|----------|-------|---------------|------|-------|-----|---|
| 0501344 | 5/4" | m. rozet | chrom | 106164+102654 | stuk | 35,74 | 350 | 0 |
|---------|------|----------|-------|---------------|------|-------|-----|---|



Douchewanden

bekersifon z. muurbuis

| | | | | | | | | |
|---------|------|----------|-------|--------|------|-------|-----|---|
| 0500569 | 5/4" | m. rozet | chrom | 106164 | stuk | 13,25 | 350 | 0 |
|---------|------|----------|-------|--------|------|-------|-----|---|

| | | | | | | | | |
|---------|------|----------|-------|--------|------|-------|-----|---|
| 0500097 | 5/4" | z. rozet | chrom | 105082 | stuk | 12,50 | 350 | 0 |
|---------|------|----------|-------|--------|------|-------|-----|---|

| | | | | | | | | |
|---------|------|----------|-------|--------|------|-------|-----|---|
| 0500127 | 6/4" | z. rozet | chrom | 133122 | stuk | 35,50 | 350 | 0 |
|---------|------|----------|-------|--------|------|-------|-----|---|

Kunststof buissifons ABS

universeel sifon speciale verpakking

| | | | | | | | | |
|---------|------|--|--|---------|------|------|-----|---|
| 0521132 | 32mm | | | 0521132 | stuk | 1,78 | 350 | 0 |
|---------|------|--|--|---------|------|------|-----|---|

| | | | | | | | | |
|---------|------|--|--|---------|------|------|-----|---|
| 0521124 | 40mm | | | 0521124 | stuk | 1,78 | 350 | 0 |
|---------|------|--|--|---------|------|------|-----|---|

| | | | | | | | | |
|---------|------|--|--|---------|------|------|-----|---|
| 0521126 | 50mm | | | 0521126 | stuk | 4,58 | 350 | 0 |
|---------|------|--|--|---------|------|------|-----|---|

Kunststof bekertions Viega

kunststof bekertion m. muurbuis

| | | | | | | | | |
|---------|------|----------|--|--------|------|------|-----|---|
| 0520144 | 5/4" | m. rozet | | 108694 | stuk | 3,58 | 350 | 0 |
|---------|------|----------|--|--------|------|------|-----|---|

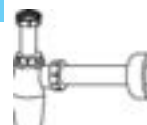
Toebehoren &
afvoerenSpoel- &
installatiesystemenBadkamermeubelen
en toiletkastenGootstenen en
wastroggen

kunststof bekertion z. muurbuis

| | | | | | | | | |
|---------|------|----------|--|--------|------|------|-----|---|
| 0520942 | 5/4" | m. rozet | | 120764 | stuk | 3,13 | 350 | 1 |
|---------|------|----------|--|--------|------|------|-----|---|

| | | | | | | | | |
|---------|------|----------|--|--------|------|------|-----|---|
| 0520161 | 5/4" | z. rozet | | 137755 | stuk | 3,05 | 350 | 1 |
|---------|------|----------|--|--------|------|------|-----|---|

| | | | | | | | | |
|---------|------|----------|--|--------|------|------|-----|---|
| 0520160 | 6/4" | z. rozet | | 103149 | stuk | 3,05 | 350 | 0 |
|---------|------|----------|--|--------|------|------|-----|---|



Utiliteit

kunststof uittrekbare sifon m. muurbuis

| | | | | | | | | |
|---------|------|----------|--|--------|------|-------|-----|---|
| 0520129 | 5/4" | m. rozet | | 470081 | stuk | 49,25 | 350 | 0 |
|---------|------|----------|--|--------|------|-------|-----|---|

Kunststof bekertions McALPINE

kunststof bekertion groot m. beluchter





| | | | | | | | | |
|---------|--|--|-----------|---------|------|-------|-----|---|
| 0520101 | | | 5/4"x32mm | 0051300 | stuk | 14,00 | 350 | 0 |
|---------|--|--|-----------|---------|------|-------|-----|---|



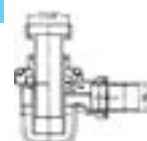

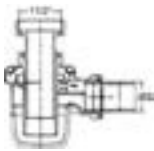

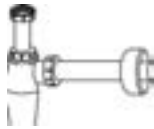
Kunststof bekertions Wisa

kunststof combisifon 5/4' m. beluchter







| | | | | | | | | |
|---------|--|--|--|------------|------|-------|-----|---|
| 0520047 | | | | 7401218880 | stuk | 34,00 | 350 | 0 |
|---------|--|--|--|------------|------|-------|-----|---|

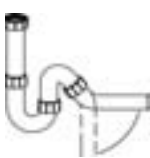

| | Art.nr | Specificaties | Kleur | Lev.nr | Ehd | Prijs | Grp | CC |
|---|---|---|-------|---------------|------|-------|-----|----|
| Sanitair producten | Kunststof bekersistons Wisa | | | | | | | |
| | | kunststof combisifon 6/4" m. beluchter | | | | | | |
| | 0520055 | | | 7401218980 | stuk | 34,00 | 350 | 1 |
| Baden / douchebakken / stoomcabines |  | | | | | | | |
| Kranen | Plugbekersifons Viega | | | | | | | |
| | | plugbekersifon m. muurbuis | | | | | | |
| | 0500216 | 5/4" m. rozet | chrom | 102845 | stuk | 18,25 | 350 | 0 |
| | 0500224 | 6/4" m. rozet | chrom | 127619 | stuk | 53,05 | 350 | 0 |
| Douchegarnituur |  | | | | | | | |
| Accessoires en spiegels | universele plugbekersifon m. muurbuis | | | | | | | |
| | 0500577 | 5/4" m. rozet | chrom | 366681 | stuk | 18,25 | 350 | 1 |
| Douchewanden | plugbekersifon m. vloerbuis 68cm | | | | | | | |
| | 0501360 | 5/4" m. rozet | chrom | 102555+102654 | stuk | 39,00 | 350 | 0 |
| Toebehoren & afvoeren | plugbekersifon m. vloerbuis 58cm | | | | | | | |
| | 0501379 | 6/4" m. rozet | chrom | 127619+125424 | stuk | 79,75 | 350 | 0 |
| Spoel- & installatiesystemen | plugbekersifon z. muurbuis | | | | | | | |
| | 0500135 | 5/4" m. rozet | chrom | 102555 | stuk | 16,25 | 350 | 0 |
| | 0500240 | 6/4" m. rozet | chrom | 127619 | stuk | 44,75 | 350 | 0 |
| Badkamermeubelen en toiletkasten |  | | | | | | | |
| Gootstenen en wastroggen | Plugbekersifons Plieger | | | | | | | |
| | | plugbekersifon m. muurbuis | | | | | | |
| | 0500054 | 5/4" m. rozet | chrom | 0500054 | stuk | 11,00 | 350 | 0 |
| | | plugbekersifon m. vloerbuis 68cm | | | | | | |
| | 0501557 | 5/4" m. rozet | chrom | 0501557 | stuk | 23,25 | 350 | 0 |
| Utiliteit | plugbekersifon z. muurbuis | | | | | | | |
| | 0500100 | 5/4" m. rozet | chrom | 0500100 | stuk | 10,50 | 350 | 0 |
| | Kunststof plugbekersifons Plieger | | | | | | | |
| | | kunststof plugbekersifon m. muurbuis | | | | | | |
| | 0520071 | 5/4" m. rozet | wit | 0520071 | stuk | 3,14 | 350 | 0 |
| | 0520063 | 5/4" m. rozet | camee | 0520063 | stuk | 3,14 | 350 | 0 |
| | 0520551 | 5/4" m. rozet | grijs | 0520551 | stuk | 4,34 | 350 | 1 |
| |  | | | | | | | |
| | Kunststof plugbekersifons Viega | | | | | | | |
| | | kunststof plugbekersifon m. muurbuis | | | | | | |
| | 0520128 | 5/4" m. rozet | | 103927 | stuk | 4,90 | 350 | 0 |
| | 0521140 | 6/4" m. rozet | | 137182 | stuk | 6,20 | 350 | 0 |
| |  | | | | | | | |
| | | kunststof plugbekersifon m. vloerbuis 68cm | | | | | | |
| | 0520500 | 5/4" m. rozet | | 102531+102579 | stuk | 7,01 | 350 | 0 |
| | | kunststof plugbekersifon 5/4" z. muurbuis m. rozet | | | | | | |
| | 0520934 | | | 102531 | stuk | 4,45 | 350 | 0 |

| Art.nr | Specificaties | Kleur | Lev.nr | Ehd | Prijs | Grp | CC | |
|--|---------------|-------------|---------------|------|--------|-----|----|---|
| Kunststof plugbekersifons Viega | | | | | | | | |
| kunststof plugbekersifon z. muurbuis | | | | | | | | |
| 0520136 | 5/4" z. rozet | | 108014 | stuk | 4,22 | 350 | 0 | Sanitair producten |
| Meubelsifons Viega | | | | | | | | |
| kunststof meubelbekersifon z. muurbuis | | | | | | | | |
| 0520322 | 5/4" m. rozet | | 128913 | stuk | 9,50 | 350 | 0 | Baden / douchebakken / stoomcabines |
| Buissifons Dornbracht | | | | | | | | |
| buissifon m. muurbuis | | | | | | | |  |
| 0470063 | 5/4" m. rozet | chroom | 1003097000 | stuk | 43,50 | 172 | 1 | |
| 0470299 | 5/4" m. rozet | platina-mat | 1003097006 | stuk | 217,00 | 172 | 1 | Kranen |
| Buissifons McALPINE | | | | | | | | |
| kunststof buissifon model P m. Komo keur | | | | | | | |  |
| 0520616 | 5/4"x32mm | | 0052300 | stuk | 4,56 | 350 | 0 | |
| 0520675 | 5/4"x40mm | | 0052350 | stuk | 4,56 | 350 | 0 | |
| 0520624 | 6/4"x40mm | | 0052450 | stuk | 4,56 | 350 | 0 | Douchegarnituur |
| kunststof buissifon model P m. Komo keur 2xklemverbinding | | | | | | | | |
| 0521264 | 40x40mm | | 0052550 | stuk | 4,56 | 350 | 0 | Accessoires en spiegels |
| kunststof buissifon model S m. Komo keur | | | | | | | |  |
| 0520594 | 5/4"x32mm | | 0052000 | stuk | 4,56 | 350 | 0 | |
| 0520608 | 6/4"x40mm | | 0052150 | stuk | 4,56 | 350 | 0 | |
| kunststof buissifon model S m. Komo keur 2xklemverbinding | | | | | | | | |
| 0520667 | 40x40mm | | 0052250 | stuk | 4,56 | 350 | 0 | Douchewanden |
| Buissifons Viega | | | | | | | | |
| buissifon m. muurbuis m. rozet | | | | | | | |  |
| 0500143 | 5/4" | chroom | 305611 | stuk | 11,75 | 350 | 0 | |
| buissifon m. muurbuis 30cm | | | | | | | | |
| 0299854 | 5/4" m. rozet | | 350246 | stuk | 14,50 | 350 | 0 | Badkamermeubelen en toiletkasten |
| buissifon m. muurbuis m. rozet | | | | | | | | |
| 0500151 | 6/4" | chroom | 122515 | stuk | 54,00 | 350 | 0 | Gootstenen en wastroggen |
| buissifon m. vloerbuis 68cm | | | | | | | |  |
| 0500194 | 5/4" m. rozet | chroom | 267015+116149 | stuk | 45,50 | 350 | 0 | |
| buissifon m. bocht | | | | | | | | |
| 0509999 | 5/4" m. rozet | chroom | 138295 | stuk | 19,50 | 350 | 1 | Utiliteit |
| buissifon z. muurbuis | | | | | | | |  |
| 0500178 | 5/4" m. rozet | chroom | 267015 | stuk | 11,00 | 350 | 0 | |
| 0500186 | 6/4" m. rozet | chroom | 121549 | stuk | 40,25 | 350 | 0 | |

| | Art.nr | Specificaties | Kleur | Lev.nr | Ehd | Prijs | Grp | CC | |
|---|--|------------------------------------|---------------|---------------|--------|-------|-------|-----|---|
| Sanitair producten | Plugbuissifons Viega | | | | | | | | |
| | plugbuissifon m. muurbuis | | | | | | | | |
| | 0500277 | 5/4" m. rozet | chroom | 111298 | stuk | 22,00 | 350 | 0 | |
| | 0500259 | 5/4" m. rozet m. verstelpijp 120mm | chroom | 124823 | stuk | 22,00 | 350 | 0 | |
| Baden / douchebakken / stoomcabines | plugbuissifon m. vloerbuis 68cm | | | | | | | | |
| | 0501387 | 5/4" m. rozet | chroom | 120696+116149 | stuk | 52,25 | 350 | 0 | |
| Kranen | plugbuissifon z. muurbuis | | | | | | | | |
| | 0500275 | 5/4" m. rozet | chroom | 120696 | stuk | 17,75 | 350 | 0 | |
| Douchegarnituur | Bidetbekersifons Viega | | | | | | | | |
| | bidetbekersifon m. muurbuis 20cm | | | | | | | | |
| | 0510246 | 5/4" m. rozet | chroom | 114619 | stuk | 21,50 | 350 | 0 | |
| Accessoires en spiegels | Bidetbuissifons Duravit | | | | | | | | |
| | bidetbuissifon m. muurbuis 215mm | | | | | | | | |
| | 0299857 | 5/4" m. rozet | | 0050270000 | stuk | 22,00 | 015 | 1 | |
| Douchewanden | Bidetbuissifons Hansgrohe | | | | | | | | |
| | bidetbuissifon m. muurbuis | | | | | | | | |
| | 0510145 | 5/4" m. rozet | satinox | 55237810 | stuk | 54,00 | 350 | 1 | |
| | 0510150 | 5/4" m. rozet | RVS | 55237800 | stuk | 54,00 | 350 | 1 | |
| Toebehoren & afvoeren | Bidetbuissifons Viega | | | | | | | | |
| | bidetbuissifon m. muurbuis | | | | | | | | |
| | 0510254 | 5/4" m. rozet | chroom | 103781 | stuk | 21,25 | 350 | 0 | |
| Spoel- & installatiesystemen | | 0510491 | 5/4" m. rozet | wit | 120351 | stuk | 53,00 | 350 | 1 |
| | kunststof bidetsifon m. muurbuis | | | | | | | | |
| | 0510253 | 5/4" m. rozet | | 120337 | stuk | 3,58 | 350 | 1 | |
| Badkamermeubelen en toiletkasten | Universeel sifons McALPINE | | | | | | | | |
| | kunststof universeel sifon m. Komo keur z. beluchter | | | | | | | | |
| | 0520691 | | 6/4"x40mm | 0053550 | stuk | 7,10 | 350 | 0 | |
| Gootstenen en wastroggen | kunststof universeel sifon m. beluchter | | | | | | | | |
| | 0521167 | | 6/4"x40mm | 0053750 | stuk | 13,50 | 350 | 0 | |
| Utiliteit | kunststof universeel sifon m. komo keur m. wasmachine-aansluiting | | | | | | | | |
| | 0520578 | | 6/4"x40mm | 0053570 | stuk | 7,50 | 350 | 0 | |
| | kunststof universeel sifon m. beluchter m. wasmachineaansluiting | | | | | | | | |
| | 0520381 | | 6/4"x40mm | 0053770 | stuk | 14,50 | 350 | 1 | |

| Art.nr | Specificaties | Kleur | Lev.nr | Ehd | Prijs | Grp | CC | | |
|---|--------------------|---------------------------------------|-----------|---------|--------|-------|-----|---|---|
| | | | | | | | | Universeel sifons Viega | |
| hostaleen universeel sifon | | | | | | | | | |
| 0520211 | 5/4"x40mm | | 113957 | stuk | 9,20 | 350 | 1 |  | Sanitair producten |
| 0520209 | 6/4"x40mm | | 104634 | stuk | 4,67 | 350 | 0 | | |
| 0500492 | 6/4"x50mm | | 102821 | stuk | 4,67 | 350 | 1 | | |
| 0520217 | 6/4"x40mm | m. wasmachineaansl. | 101800 | stuk | 5,30 | 350 | 1 | | |
| 0520225 | 6/4"x40mm | m. klemverbinding | 279394 | stuk | 5,40 | 350 | 0 | | |
| hostaleen universeel sifon 6/4"x40mm m. klemverbinding | | | | | | | | | |
| 0520219 | | | 121365 | stuk | 11,00 | 350 | 0 | | Baden / douchebakken / stoomcabines |
| hostaleen universeel sifon | | | | | | | | | |
| 0520497 | 6/4"x40mm | m.wasmachine aansl. m. klemverbinding | | 279387 | stuk | 5,90 | 350 |  | Kranen |
| 0 | | | | | | | | | Douchegarnituur |
| | | | | | | | | Centrisch duplex sifoncombinaties McAlpine | |
| duplex sifoncombinatie in hoogte verstelbaar m. Komo keur | | | | | | | | | |
| 0520713 | | 6/4"x40mm | 0055350 | stuk | 14,50 | 350 | 0 |  | Accessoires en spiegels |
| 0520969 | | m. wasmachineaansl. | 6/4"x40mm | 0055370 | stuk | 15,75 | 350 | | |
| | | | | | | | | Excentrisch duplex sifoncombinaties McAlpine | |
| duplex sifoncombinatie in hoogte verstelbaar m. wasmachine aansluiting | | | | | | | | | |
| 0520403 | | 6/4"x6/4" | 0055470 | stuk | 6,60 | 350 | 1 |  | Douchewanden |
| | | | | | | | | Gootsteen sifons Geberit | |
| ruimtebesparend spoelbaksifon | | | | | | | | | |
| 0712469 | voor 1 spoelbak | | 152957111 | stuk | 24,50 | 328 | 1 | | Toebehoren & afvoeren |
| 0712477 | voor 2 spoelbakken | | 152958111 | stuk | 35,75 | 328 | 1 | | |
| sifon voor gootsteen m. slangtule m. pakking | | | | | | | | | |
| 0711008 | 6/4"x40mm | enkel | 152723111 | stuk | 9,70 | 350 | 1 | | Spoel- & installatiesystemen |
| 0710007 | 6/4"x40mm | dubbel | 152724111 | stuk | 14,25 | 350 | 1 | | |
| | | | | | | | | Gootsteen- en wasmachineafvoeren Viega | |
| afvoer-/overloop garnituur 6/4" 70mm m. stop m. ketting | | | | | | | | | |
| 0521183 | | | 100834 | stuk | 5,10 | 350 | 0 |  | Badkamermeubelen en toiletkasten |
| gootsteen- afvoer- en overloopgarnituur m. overloop | | | | | | | | | |
| 0500500 | 6/4"x70 | messing | 125486 | stuk | 13,75 | 350 | 1 | | Gootstenen en wastroggen |
| afvoerbocht | | | | | | | | | |
| 0500715 | 6/4" | | 105785 | stuk | 5,30 | 350 | 1 | | Utiliteit |
| hostaleen sifon m. muurbuis | | | | | | | | | |
| 0520155 | 6/4"x40mm | | 105716 | stuk | 4,20 | 350 | 1 | | |
| afvoer- en overloopgarnituur voor gipsvangers | | | | | | | | | |
| 0520181 | 6/4"x40mm | chrom | 140793 | stuk | 167,00 | 350 | 1 | | |
| afvoer voor gipsvang onderbak | | | | | | | | | |
| 0520210 | | | 151423 | stuk | 92,50 | 350 | 1 | | |
| hostaleen universeel sifon | | | | | | | | | |
| 0520218 | 6/4"x50mm | m. wasmachineaansl. | 101206 | stuk | 5,30 | 350 | 1 | | |
| 0520220 | 5/4"x40mm | m. wasmachineaansl. | 114596 | stuk | 9,90 | 350 | 1 | | |
| hostaleen universeel duplosifon | | | | | | | | | |
| 0520504 | 6/4"x40mm | m. wasmachineaansl. m. klemverbinding | | 116095 | stuk | 15,00 | 350 | | |
| 1 | | | | | | | | | |
| hostaleen duploafvoer 6/4" z. plug z. sifon | | | | | | | | | |
| 0520179 | | | 113063 | stuk | 9,30 | 350 | 0 |  | |

| | Art.nr | Specificaties | Kleur | Lev.nr | Ehd | Prijs | Grp | CC |
|---|--|--|-------|------------|------|-------|-----|----|
| Utiliteit Plieger | | | | | | | | |
| Sanitair producten | wastafelafvoerset voor wandmontage | | | | | | | |
| | 0300756 | | | 0300756 | stuk | 94,50 | 369 | 1 |
| flexibele aan/afvoerset voor hoog/laag montage | | | | | | | | |
| | 0304085 | | | 0304085 | stuk | 89,00 | 369 | 1 |
| Utiliteit Viega | | | | | | | | |
| Baden / douchebakken / stoomcabines | afvoerset kunststof Paracelsus (6932-495) | | | | | | | |
| | 0080063 | | | 133207 | stuk | 74,50 | 350 | 0 |
| Kranen | plugbeksifon ruimtebesparend ergonomisch m. standpijp | | | | | | | |
| | 0080055 | | chrom | 132675 | stuk | 75,50 | 350 | 0 |
| Douchegarnituur | plugbeksifon ergonomisch | | | | | | | |
| | 0220167 | | | 148355 | stuk | 48,75 | 350 | 0 |
| Onderdelen de Beer | | | | | | | | |
| Accessoires en spiegels | 0560456 | rubber plugflens plat 5/4" | | 120250100 | stuk | 0,53 | 350 | 0 |
| | 0560464 | rubber plugflens plat 6/4" | | 120260100 | stuk | 0,47 | 350 | 0 |
| | 0850004 | kogelketting 30cm m. bevestigingsplaatje onder mengkraan | | 351210050 | stuk | 1,34 | 362 | 0 |
| | 0850063 | patentketting 30cm | | 351330050 | stuk | 1,38 | 362 | 0 |
| | 0400002 | kraanbovendeel M19 koud | | 362320010 | stuk | 6,89 | 187 | 0 |
| Douchewanden | 0400003 | kraanbovendeel M19 warm | | 362310010 | stuk | 6,89 | 187 | 0 |
| | Onderdelen Duravit | | | | | | | |
| | 0299480 | Architec muurbuis chrom 5/4" m. bocht 32mm | | 0050251000 | stuk | 9,00 | 016 | 1 |
| Onderdelen McALPINE | | | | | | | | |
| Toebehoren & afvoeren | 0520756 | overgangskopp. lood/kunstst. 2xklem m. rubberring 5/4"x32mm | | 0059100 | stuk | 4,77 | 350 | 0 |
| | 0520764 | overgangskopp. lood/kunstst. 2xklem m. rubberring 5/4"x40mm | | 0059120 | stuk | 5,10 | 350 | 0 |
| | 0520772 | overgangskopp. lood/kunstst. 2xklem m. rubberring 6/4x40mm | | 0059150 | stuk | 5,30 | 350 | 0 |
| | 0520802 | verloopring 6/4"x5/4 | | 0059550 | stuk | 0,95 | 350 | 0 |
| | 0520705 | T-stuk voor was- en vaatwasmachine 1xslangtule | | 0055050 | stuk | 2,27 | 350 | 0 |
| | 0520411 | ruimtebesparende bocht 110-300mm 6/4"x6/4" | | 0052850 | stuk | 4,09 | 350 | 1 |
| | 0520683 | wasmachine-afvoerset m. komo keur 40x40mm | | 0052950 | stuk | 11,00 | 350 | 0 |
| | 0520438 | keukenafvoerset SSK2 m. 1x (vaat)wasmachine aansl. 6/4"x40mm | | 0055750 | stuk | 31,25 | 350 | 1 |
| | 0520314 | ventapipe J8 toestelbeluchter m. verloopring 32x40mm grijs | | 0055100 | stuk | 4,39 | 350 | 0 |
| | 0520162 | ventapipe J8 toestelbeluchter m. verloopring 50mm wit | | 0055110 | stuk | 4,34 | 350 | 0 |
| Badkamermeubelen en toiletkasten | 0520330 | PE buis 40x600mm wit | | 0059060 | stuk | 2,37 | 350 | 1 |
| | Onderdelen Plieger | | | | | | | |
| Gootstenen en wastroggen | 0501255 | kunststof stop z. ketting 38.5mm | | 130540001 | stuk | 0,37 | 350 | 0 |
| | 0520235 | kunststof muurbuis 5/4"x25cm wit | | 0520235 | stuk | 0,70 | 350 | 0 |
| | 0520276 | kunststof vloerbuis 5/4"x68cm wit | | 0520276 | stuk | 2,56 | 350 | 0 |
| | 0520098 | kunststof vloerbuis 5/4"x68cm camee | | 0520098 | stuk | 3,84 | 350 | 0 |
| | 0501638 | vloerbuis 5/4"x68cm chrom | | 0501638 | stuk | 12,75 | 350 | 0 |
| Utiliteit | 0850071 | kogelketting 30cm chrom | | 0850071 | stuk | 0,64 | 362 | 0 |
| | 0600598 | kogelketting 50cm chrom | | 0600598 | stuk | 0,89 | 362 | 0 |
| Onderdelen Viega | | | | | | | | |
| | 0501263 | kunststof stop z. ketting 50.5mm | | 130570001 | stuk | 0,56 | 350 | 0 |
| | 0501271 | kunststof stop z. ketting 45mm voor RVS gootsteen | | 130560001 | stuk | 0,39 | 350 | 0 |
| | 0501115 | schroef voor simplexplug M6x80mm | | 282509 | stuk | 1,72 | 350 | 0 |
| | 0500909 | plugkoppeling 5/4" recht messing | | 110482 | stuk | 2,83 | 350 | 0 |
| | 0500917 | plugkoppeling 6/4" recht messing | | 114053 | stuk | 3,42 | 350 | 0 |
| | 0520918 | kraagstuk 5/4"x32mm m. wartelmoer | | 123048 | stuk | 1,37 | 350 | 0 |
| | 0520926 | kraagstuk 6/4"x40mm m. wartelmoer | | 113162 | stuk | 1,67 | 350 | 0 |
| | 0501425 | overgangskoppeling lood 5/4" 32mm klem chrom | | 113681 | stuk | 6,00 | 350 | 0 |
| | 0501433 | overgangskoppeling lood 6/4" 42mm klem chrom | | 113315 | stuk | 8,80 | 350 | 0 |
| | 0501604 | chrom T-stuk 5/4x32x6/4x40 | | 134914 | stuk | 28,25 | 350 | 1 |
| | 0501484 | wartelmoer verhoogd model z. tule 5/4" messing | | 118563 | stuk | 2,52 | 350 | 0 |
| | 0501530 | wartelmoer verhoogd model z. tule 6/4" messing | | 113292 | stuk | 2,59 | 350 | 0 |
| | 0500314 | wartelmoer verhoogd model z. tule 5/4" chrom | | 123437 | stuk | 2,74 | 350 | 1 |
| | 0500313 | wartelmoer verhoogd model z. tule 6/4" chrom | | 122089 | stuk | 2,80 | 350 | 1 |
| | 0521191 | hostaleen wartelmoer los 5/4" | | 104900 | stuk | 0,51 | 350 | 0 |
| | 0521205 | hostaleen wartelmoer los 6/4" | | 102029 | stuk | 0,62 | 350 | 0 |
| | 0501603 | verlengpijp m. O-ring 32x125mm chrom | | 102647 | stuk | 6,80 | 350 | 0 |
| | 0500291 | verlengpijp m. beluchter 32x125mm chrom | | 115524 | stuk | 25,75 | 350 | 0 |
| | 0501611 | sok m. 2 O-ringen 32mm chrom | | 102371 | stuk | 4,76 | 350 | 0 |
| | 0500755 | klem koppeling lood 5/4" 32mm klem nikkel | | 117788 | stuk | 7,30 | 350 | 0 |
| | 0500763 | klem koppeling lood 6/4" 40mm klem nikkel | | 119379 | stuk | 9,20 | 350 | 0 |

| Art.nr | Specificaties | Kleur | Lev.nr | Ehd | Prijs | Grp | CC |
|-------------------------|--|-------|---------------|------|-------|-----|----|
| Onderdelen Viega | | | | | | | |
| 0520560 | muurbuis m. kraag z. rozet 5/4"x 20cm | chrom | 100599 | stuk | 4,39 | 350 | 1 |
| 0501322 | muurbuis m. kraag z. rozet 5/4"x25cm | chrom | 101480 | stuk | 5,70 | 350 | 0 |
| 0500348 | muurbuis 5/4"x20cm z. rozet | chrom | 02773810001 | stuk | 3,39 | 350 | 0 |
| 0501328 | muurbuis 6/4"x20cm z. rozet | chrom | 126391 | stuk | 8,30 | 350 | 0 |
| 0500364 | muurbuis 5/4"x20cm m. rozet | chrom | 104627+104245 | stuk | 3,88 | 350 | 0 |
| 0500356 | muurbuis 5/4"x25cm z. rozet | chrom | 112240 | stuk | 6,80 | 350 | 0 |
| 0500372 | muurbuis 5/4"x25cm m. rozet | chrom | 112240+104245 | stuk | 7,29 | 350 | 0 |
| 0500714 | muurbuis 5/4"x30cm z. rozet | chrom | 111113 | stuk | 8,30 | 350 | 0 |
| 0500429 | muurbuis 5/4"x20cm z. rozet m. beluchter | chrom | 117764 | stuk | 26,75 | 350 | 1 |
| 0520233 | muurbuis 5/4"x20cm kunststof | wit | 02226000001 | stuk | 0,54 | 350 | 0 |
| 0520268 | muurbuis 6/4"x20cm kunststof | wit | 133894 | stuk | 0,89 | 350 | 1 |
| 0500380 | gebogen muurbuis v. buissifon m. rozet 5/4"x175mm | chrom | 116828+104245 | stuk | 5,79 | 350 | 0 |
| 0500405 | gebogen muurbuis z. rozet 5/4"x250mm | chrom | 105860 | stuk | 11,00 | 350 | 1 |
| 0500400 | gebogen muurbuis z. rozet 5/4"x300mm | chrom | 105594 | stuk | 13,50 | 350 | 1 |
| 0500410 | gebogen muurbuis z. rozet 6/4"x200mm | chrom | 126681 | stuk | 17,00 | 350 | 0 |
| 0500399 | gebogen muurbuis z. rozet 5/4"x175mm | chrom | 1871905 | stuk | 5,30 | 350 | 0 |
| 0500526 | vloerbuis lange bocht v. bekersiston 6/4"x58cm z. rozet | chrom | 125424 | stuk | 35,00 | 350 | 0 |
| 0500496 | vloerbuis lange bocht v. bekersiston 5/4"x68cm z. rozet | chrom | 102654 | stuk | 22,75 | 350 | 0 |
| 0500542 | vloerbuis lange bocht v. bekersiston 6/4"x68cm z. rozet | chrom | 136376 | stuk | 38,75 | 350 | 0 |
| 0500518 | vloerbuis lange bocht v. bekersiston 5/4"x68cm m. rozet | chrom | 102654+104245 | stuk | 23,24 | 350 | 0 |
| 0500550 | vloerbuis lange bocht v. bekersiston 6/4"x68cm m. rozet | chrom | 136376+127787 | stuk | 41,16 | 350 | 0 |
| 0500498 | vloerbuis lange bocht v. bekersiston 5/4"x75mm z. rozet | chrom | 335199 | stuk | 32,00 | 350 | 0 |
| 0520950 | kunststof vloerbuis 5/4"x75cm | wit | 132774 | stuk | 4,82 | 350 | 0 |
| 0520284 | kunststof vloerbuis 6/4"x68cm | wit | 123901 | stuk | 5,70 | 350 | 0 |
| 0500585 | vloerbuis korte bocht v. bekersiston 5/4"x68 m.knie z. rozet | chr. | 131104 | stuk | 28,50 | 350 | 0 |
| 0500607 | vloerbuis korte bocht v. bekersiston 6/4"x58 m.knie z. rozet | chr. | 140465 | stuk | 32,25 | 350 | 1 |
| 0500593 | vloerbuis korte bocht v. bekersiston 5/4"x68 m.knie m. rozet | chr. | 131104+104245 | stuk | 28,99 | 350 | 0 |
| 0501573 | vloerbuis voor buissifon 5/4"x68cm z. rozet | chrom | 116149 | stuk | 34,50 | 350 | 0 |
| 0500690 | vloerbuis voor buissifon 6/4"x68cm z. rozet | chrom | 130978 | stuk | 67,50 | 350 | 1 |
| 0501018 | standpijp 6/4"x120mm | chrom | 1394006 | stuk | 6,80 | 350 | 0 |
| 0501026 | standpijp 6/4"x140mm | chrom | 142193 | stuk | 7,80 | 350 | 1 |
| 0501034 | standpijp 6/4"x175mm | chrom | 145484 | stuk | 17,75 | 350 | 1 |
| 0500739 | sifonrozet hoog 5/4"x35mm | chrom | 104962 | stuk | 5,30 | 350 | 0 |
| 0500305 | sifonrozet hoog 5/4"x50mm | chrom | 111380 | stuk | 7,50 | 350 | 0 |
| 0520292 | kunststof sifonrozet 5/4" | wit | 553555 | stuk | 0,33 | 350 | 0 |
| 0520306 | kunststof sifonrozet 6/4" | wit | 282530 | stuk | 0,40 | 350 | 0 |
| 0500712 | sifonrozet 5/4" vlak | chrom | 0500712 | stuk | 0,49 | 350 | 0 |
| 0500720 | sifonrozet 6/4" vlak | chrom | 127787 | stuk | 2,41 | 350 | 0 |
| 0500747 | sifonrozet 6/4"x50mm | chrom | 128722 | stuk | 7,50 | 350 | 0 |
| 0501565 | beluchter voor muurbuis | chrom | 116248 | stuk | 13,25 | 350 | 1 |
| 0501212 | afdichtring 5/4" voor bekersiston | | 104313 | stuk | 0,32 | 350 | 0 |
| 0501220 | afdichtring 6/4" voor bekersiston | | 108908 | stuk | 0,58 | 350 | 0 |
| 0501298 | nylon konische klemring 5/4" voor sifon | | 193522 | stuk | 0,22 | 350 | 0 |
| 0501301 | nylon konische klemring 6/4" voor sifon | | 193515 | stuk | 0,17 | 350 | 0 |
| 0501239 | O-ring 5/4" voor simplexplug | | 108960 | stuk | 0,92 | 350 | 0 |
| 0501247 | O-ring 6/4" voor simplexplug | | 119072 | stuk | 0,42 | 350 | 0 |
| 0500070 | afdichtring 70mm voor gootsteenplug | | 282578 | stuk | 0,74 | 350 | 1 |
| 0520470 | losse tule voor sifon 32mm | | 364069 | stuk | 0,40 | 350 | 0 |
| 0520489 | losse tule voor sifon 40mm | | 364076 | stuk | 0,47 | 350 | 0 |
| 0080074 | PVC slangtule 45° | | 102999 | stuk | 0,82 | 350 | 1 |
| 0772569 | kunststof buis 50x250mm | | 129514 | stuk | 8,00 | 350 | 1 |
| 0501330 | kunststof buis 50x500mm | | 125691 | stuk | 10,50 | 350 | 1 |
| 0510002 | bocht 90gr. 40x245mm | | 111922 | stuk | 3,00 | 350 | 1 |
| 0500499 | afvoerbocht 90gr. 40x250mm | | 109479 | stuk | 2,98 | 350 | 1 |
| 0500307 | kunststof verloopstuk binnen- x buitendraad 2"x6/4" | | 111571 | stuk | 2,16 | 350 | 1 |
| 0500309 | rozet voor Multiplex badafvoer oud model | | 136314 | stuk | 24,75 | 350 | 1 |
| 0510647 | messaging contraoer 64"x70mm | | 106034 | stuk | 3,86 | 479 | 1 |

Sanitair producten

Baden /
douchebakken /
stoomcabines

Kranen



Douchegarnituur

Accessoires en
spiegels

Douchewanden

Toebehoren &
afvoerenSpoel- &
installatiesystemenBadkamermeubelen
en toiletkastenGootstenen en
wastroggen

Utiliteit

| | Art.nr | Specificaties | Kleur | Lev.nr | Ehd | Prijs | Grp | CC | |
|---|---|--|---|-----------------|-----------|---------|--------|-------|---|
| Sanitair producten | Inspectieluiken Alpro | | | | | | | | |
| | 0610046 | Alpro2000 whirlpool-set compleet tegelluik m. rooster | chroom | 0601001 | stuk | 124,00 | 250 | 0 | |
| Baden / douchebakken / stoomcabines |  | 0610013 | Alpro2000 set compleet tegelluik | chroom | 0600000 | stuk | 31,50 | 250 0 | |
| | Luchtroosters | | | | | | | | |
| Kranen | 0940412 | Ucosan luchtrooster 19.8x18.8cm | | 0940412 | stuk | 56,00 | 108 | 1 | |
| Douchegarnituur | Baddragers en tegelramen de Beer | | | | | | | | |
| |  | 0610011 | tegelraam lichtmodel 30x30cm | chroom | 383790001 | stuk | 4,82 | 250 0 | |
| Accessoires en spiegels | Baddragers en tegelramen Illbruck | | | | | | | | |
| Douchewanden | 0340367 | 180x80cm | Bette Darling | 17051434 | stuk | 285,00 | 082 | 1 | |
| | 0340343 | 170x80cm | Bette Duett | 17029462 | stuk | 275,00 | 082 | 1 | |
| | 0340366 | 180x80cm | Bette Duo | 17051276 | stuk | 285,00 | 082 | 1 | |
| | 0341002 | 180x80cm | Bette Form/Kaldewei Sanif. | 17029678 | stuk | 272,00 | 082 | 1 | |
| | 0340357 | 190x80cm | Bette Form | 17029884 | stuk | 297,00 | 082 | 1 | |
| | 0340368 | 108x73cm | Bette LaBette | 17051641 | stuk | 236,00 | 082 | 1 | |
| | 0340353 | 170x80cm | Bette Set | 17029605 | stuk | 265,00 | 082 | 1 | |
| | 0340369 | 185x85cm | Bette Starlet Oval | 17051780 | stuk | 592,00 | 082 | 1 | |
| | Toebehoren & afvoeren | baddrager Original | | | | | | | |
| | | 0340529 | 170x73cm | Bette BetteForm | 17029246 | stuk | 222,00 | 082 | 1 |
| 0340340 | | 170x75cm | BetteForm/Kaldewei Saniform | 17029560 | stuk | 175,00 | 082 | 1 | |
| 0340362 | | 175x75cm | Bette Form | 17030054 | stuk | 275,00 | 082 | 1 | |
| Spoel- & installatiesystemen | baddrager Vario | | | | | | | | |
| | 0340351 | 140x70cm | Bette Form | 17029562 | stuk | 186,00 | 082 | 1 | |
| | 0340352 | 150x70cm | Bette Form | 17029563 | stuk | 190,00 | 082 | 1 | |
| | 0340341 | 160x71cm | Bette Form | 17029425 | stuk | 181,00 | 082 | 1 | |
| | 0340342 | 160x75cm | Bette Form | 17029431 | stuk | 156,00 | 082 | 1 | |
| | 0341843 | 170x70cm | Bette Form | 17029412 | stuk | 170,00 | 082 | 1 | |
| Badkamermeubelen en toiletkasten | 0340510 | 170x75cm | Bette Form / Kaldewei Saniform | 17029405 | stuk | 179,00 | 082 | 1 | |
| | baddrager Compact | | | | | | | | |
| Gootstenen en wastroggen | 0340434 | 170x75cm | Kaldewei RondoForm | 17151323 | stuk | 267,00 | 082 | 1 | |
| | 0340378 | | Duscholux Ancona 112 | 17152029 | stuk | 285,00 | 082 | 1 | |
| | 0340379 | | Duscholux Ancona 225 | 17153558 | stuk | 285,00 | 082 | 1 | |
| | 0340435 | | Duscholux Ancona 226 | 17153780 | stuk | 325,00 | 082 | 1 | |
| | 0340372 | | Duscholux Ancona 242 | 17052608 | stuk | 285,00 | 082 | 1 | |
| | 0340374 | | Duscholux BlueLine 12 | 17151077 | stuk | 301,00 | 082 | 1 | |
| | 0340376 | | Duscholux BlueLine 13 | 17151078 | stuk | 301,00 | 082 | 1 | |
| | 0340377 | | Duscholux BlueLine 14 | 17151705 | stuk | 285,00 | 082 | 1 | |
| | 0340373 | | Duscholux Portofino 115 | 17052949 | stuk | 605,00 | 082 | 1 | |
| | 0340260 | | Duscholux Smartline 37 | 17154046 | stuk | 254,00 | 082 | 1 | |
| Utiliteit | 0340262 | | Duscholux Smartline 38 | 17154042 | stuk | 278,00 | 082 | 1 | |
| | 0342010 | 170x75cm | Hoesch Capri | 17151015 | stuk | 267,00 | 082 | 1 | |
| | 0340429 | 190x80cm | Riho Alberta | 17053184 | stuk | 462,00 | 082 | 1 | |
| | 0340419 | 175x80cm | Riho Colombia | 17053165 | stuk | 336,00 | 082 | 1 | |
| | 0340420 | 153x100.5cm | Riho Lyra rechts | 17053168 | stuk | 539,00 | 082 | 1 | |
| | 0340427 | 180x90cm | Riho Montreal | 17053179 | stuk | 347,00 | 082 | 1 | |
| | 0340428 | 180x80cm | Riho Ontario | 17053182 | stuk | 329,00 | 082 | 1 | |
| | 0340432 | 180x80cm | Riho Tofield | 17053190 | stuk | 323,00 | 082 | 1 | |
| | 0340425 | 180x80cm | Riho Victoria | 17053175 | stuk | 323,00 | 082 | 1 | |
| | 0340426 | 190x80cm | Riho Victoria | 17053176 | stuk | 323,00 | 082 | 1 | |
| | 0340424 | 145x145cm | Riho Winnepeg | 17053174 | stuk | 1076,00 | 082 | 1 | |
| | 0340430 | 160x90cm | Riho Yukon links | 17053186 | stuk | 336,00 | 082 | 1 | |
| | 0340431 | 160x90cm | Riho Yukon rechts | 17053188 | stuk | 336,00 | 082 | 1 | |
| | 0340439 | 170x70cm | Ucosan Cassandra | 17153797 | stuk | 261,00 | 082 | 1 | |
| | 0340440 | 180x80cm | Ucosan Cassandra | 17153799 | stuk | 285,00 | 082 | 1 | |
| | 0340441 | 190x90cm | Ucosan Cassandra | 17153800 | stuk | 326,00 | 082 | 1 | |

| Art.nr | Specificaties | Kleur | Lev.nr | Ehd | Prijs | Grp | CC |
|--|---------------|-------------------------------|----------|------|--------|-----|----|
| Baddragers en tegelramen Illbruck | | | | | | | |
| baddrager | | | | | | | |
| 0341967 | 180x80cm | Liberty rechthoekig | 17153691 | stuk | 298,00 | 082 | 1 |
| 0341924 | 180x80cm | Liberty ovaal | 17053227 | stuk | 395,00 | 082 | 1 |
| 0341916 | 135x135cm | Liberty hoekbad | 17053226 | stuk | 858,00 | 082 | 1 |
| 0341940 | 170x75cm | Spring | 17153622 | stuk | 201,00 | 082 | 1 |
| 0341959 | 180x80cm | Spring | 17153623 | stuk | 219,00 | 082 | 1 |
| baddrager Cam | | | | | | | |
| 0340394 | 175x75cm | Villeroy & Boch Cetus | 17052086 | stuk | 915,00 | 082 | 1 |
| 0340398 | 190x80cm | Villeroy & Boch Cetus | 17052644 | stuk | 915,00 | 082 | 1 |
| baddrager Compact | | | | | | | |
| 0340407 | 180x80cm | Villeroy & Boch Epura | 17153580 | stuk | 285,00 | 082 | 1 |
| 0340403 | 170x75cm | Villeroy & Boch Leante | 17151058 | stuk | 267,00 | 082 | 1 |
| 0340406 | 180x80cm | Villeroy & Boch Leante | 17151237 | stuk | 285,00 | 082 | 1 |
| 0340399 | 180x80cm | Villeroy & Boch Libra | 17052783 | stuk | 285,00 | 082 | 1 |
| 0340396 | 170x75cm | Villeroy & Boch Oberon | 17052270 | stuk | 267,00 | 082 | 1 |
| 0340412 | 180x80cm | Villeroy & Boch Oberon | 17153637 | stuk | 285,00 | 082 | 1 |
| 0340397 | 180x80cm | Villeroy & Boch Omain | 17052583 | stuk | 416,00 | 082 | 1 |
| 0340408 | 170x75cm | Villeroy & Boch Parana | 17153627 | stuk | 267,00 | 082 | 1 |
| 0340409 | 180x80cm | Villeroy & Boch Parana | 17153628 | stuk | 285,00 | 082 | 1 |
| 0340400 | 190x80cm | Villeroy & Boch Parana | 17052960 | stuk | 416,00 | 082 | 1 |
| 0340410 | 190x90cm | Villeroy & Boch Parana | 17153629 | stuk | 326,00 | 082 | 1 |
| 0340395 | 170x75cm | Villeroy & Boch Pavia | 17052236 | stuk | 267,00 | 082 | 1 |
| 0340411 | 180x80cm | Villeroy & Boch Pavia | 17153631 | stuk | 285,00 | 082 | 1 |
| 0340404 | 180x80cm | Villeroy & Boch Spica | 17151192 | stuk | 285,00 | 082 | 1 |
| 0340393 | 180x80cm | Villeroy & Boch Taurus | 17052078 | stuk | 283,00 | 082 | 1 |
| 0340402 | 160x75cm | Villeroy & Boch Tucana links | 17151057 | stuk | 301,00 | 082 | 1 |
| 0340401 | 160x75cm | Villeroy & Boch Tucana rechts | 17151056 | stuk | 301,00 | 082 | 1 |
| 2-componenten montageschuim 400ml | | | | | | | |
| 0342351 | | | 18200094 | stuk | 19,00 | 082 | 0 |

Sanitair producten

Baden /
douchebakken /
stoomcabines

Kranen

Douchegarnituur

Accessoires en
spiegels

Douchewanden

Toebehoren &
afvoeren

Spoel- &
installatiesystemen

Badkamermeubelen
en toiletkasten

Gootstenen en
wastroggen

Utiliteit

| | Art.nr | Specificaties | Kleur | Lev.nr | Ehd | Prijs | Grp | CC |
|---|--|--|-------------|-----------------|------|--------|-----|----|
| Sanitair producten | Badoverloopcombinatie Hansgrohe | | | | | | | |
| | | badplug- en overloopcombinatie m. stop en ketting m. sifon 0510467 | chrom | 59260000 | stuk | 29,25 | 350 | 0 |
| Baden / douchebakken / stoomcabines | Badoverloopcombinatie Plieger | | | | | | | |
| | | badoverloopcombinatie 40mm m. sifon klem 0510726 | | 0510726 | stuk | 7,30 | 350 | 0 |
| Kranen | Badoverloopcombinatie Viega | | | | | | | |
| | | badplug- en overloopcombinatie m. stop en ketting 0500315 40mm | | 109240 | stuk | 17,00 | 350 | 0 |
| Douchegarnituur | | 0510033 40mm | chrom | 106812 | stuk | 16,00 | 350 | 0 |
| | badplug- en overloopcombinatie z. sifon 0501327 6/4" | | | | | | | |
| Accessoires en spiegels | | | chrom | 124052 | stuk | 19,75 | 350 | 1 |
| Douchewanden | Badwaste McALPINE | | | | | | | |
| | | badafvoer- en overloopcombinatie m. waste v. normaal bad 0520241 40mm | chrom | 0056505 | stuk | 37,25 | 350 | 0 |
| Toebehoren & afvoeren | Badwaste Dornbracht | | | | | | | |
| | | badafvoer- en overloopcombinatie m. waste basisgarnituur voor speciaal bad 0472789 | | 3522197090 | stuk | 92,00 | 172 | 1 |
| Spoel- & installatiesystemen | | | | | | | | |
| Badkamermeubelen en toiletkasten | badafvoer-, overloop- en vulcombinatie m. waste basisgarnituur v. speciaal bad 0470628 | | | | | | | |
| | | | | 3522597090 | stuk | 254,00 | 172 | 0 |
| Gootstenen en wastroggen | | | | | | | | |
| Utiliteit | kleurset voor badafvoer- en overloopcombinatie 0472781 | | | | | | | |
| | | | platina-mat | 3622197006 | stuk | 182,00 | 172 | 1 |
| Badwaste Duravit | | | | | | | | |
| | badafvoer- en overloopcombinatie m. waste 0290560 | | chrom | 790217000001000 | stuk | 132,00 | 092 | 1 |
| | badafvoer-, overloop- en vulcombinatie m. waste 0290562 | | chrom | 790218000001000 | stuk | 368,00 | 092 | 1 |
| Badwaste Geberit | | | | | | | | |
| | badafvoer- en overloopcombinatie m. waste v. normaalbad m. tegenstroomprincipe 0710911 | | chrom | 150824211 | stuk | 61,50 | 328 | 0 |
| | badafvoer- en overloopcombinatie m. waste v. normaalbad 0710017 | | chrom | 150503211 | stuk | 51,00 | 328 | 1 |

| Art.nr | Specificaties | Kleur | Lev.nr | Ehd | Prijs | Grp | CC |
|--------|---------------|-------|--------|-----|-------|-----|----|
|--------|---------------|-------|--------|-----|-------|-----|----|

Badwaste Geberit

| | | | | | | | |
|---|--|-------|-----------|------|-------|-----|---|
| badafvoer- en overloopcombinatie m. waste v. speciaal bad 0711721 | | chrom | 150506211 | stuk | 57,00 | 328 | 0 |
|---|--|-------|-----------|------|-------|-----|---|



Sanitair producten

Baden /
douchebakken /
stoomcabines

| | | | | | | | |
|--|--|---------------|-----------|------|-------|-----|---|
| kleurset voor badafvoer- en overloopcombinatie 0711675 | | chrom struct. | 150221211 | stuk | 17,75 | 328 | 0 |
|--|--|---------------|-----------|------|-------|-----|---|

| | | | | | | | |
|---------|--|-----|-----------|------|-------|-----|---|
| 0711020 | | wit | 150220BM1 | stuk | 21,50 | 328 | 1 |
|---------|--|-----|-----------|------|-------|-----|---|

Kranen

| | | | | | | | |
|--|------------------------|--|-----------|------|--------|-----|---|
| badafvoer-, overloop- en vulcombinatie m. waste basisgarnituur v. speciaal bad 0700060 | m. tegenstroomprincipe | | 150707001 | stuk | 252,00 | 329 | 1 |
|--|------------------------|--|-----------|------|--------|-----|---|

| | | | | | | | |
|--|--|-------|-----------|------|-------|-----|---|
| kleurset voor badafvoer-, overloop- en vulcombinatie 0700059 | | chrom | 150424211 | stuk | 35,75 | 329 | 1 |
|--|--|-------|-----------|------|-------|-----|---|

Douchegarnituur

Badwaste Gessi

| | | | | | | | |
|---|--|-------|---------|------|--------|-----|---|
| badafvoer-, overloop- en vulcombinatie m. waste 0465216 | | chrom | 1080031 | stuk | 222,00 | 169 | 1 |
|---|--|-------|---------|------|--------|-----|---|



Accessoires en
spiegels

Douchewanden

| | | | | | | | |
|---|--|------|---------|------|--------|-----|---|
| badafvoer-, overloop- en vulcombinatie m. waste 0460109 | | inox | 1080142 | stuk | 235,00 | 169 | 1 |
|---|--|------|---------|------|--------|-----|---|

**Toebehoren &
afvoeren**

Badwaste Grohe

| | | | | | | | |
|--|--|-------|----------|------|-------|-----|---|
| badafvoer- en overloopcombinatie m. waste v. normaal en speciaal bad 0443115 | | chrom | 28943000 | stuk | 57,50 | 162 | 1 |
|--|--|-------|----------|------|-------|-----|---|

| | | | | | | | |
|--|--|-------|----------|------|-------|-----|---|
| kleurset voor badafvoer- en overloopcombinatie 0443107 | | chrom | 19020000 | stuk | 42,25 | 162 | 1 |
|--|--|-------|----------|------|-------|-----|---|

| | | | | | | | |
|---------|--------------|-------|----------|------|-------|-----|---|
| 0442009 | voor Sentosa | chrom | 19025000 | stuk | 46,25 | 241 | 1 |
|---------|--------------|-------|----------|------|-------|-----|---|

Spoel- &
installatiesystemen

| | | | | | | | |
|--|--|-------|----------|------|--------|-----|---|
| badafvoer- en overloopcombinatie m. waste 0442012 6/4" | | chrom | 28953000 | stuk | 151,00 | 241 | 1 |
|--|--|-------|----------|------|--------|-----|---|

Badkamermeubelen
en toiletkasten

| | | | | | | | |
|--|-----------------------------|--|----------|------|--------|-----|---|
| badafvoer-, overloop- en vulcombinatie m. waste basisgarnituur v. speciaal bad 0442591 | m. buisonderbreker z. rozet | | 28997000 | stuk | 254,00 | 241 | 0 |
|--|-----------------------------|--|----------|------|--------|-----|---|

| | | | | | | | |
|--|--------------|-------|----------|------|--------|-----|---|
| kleurset voor badafvoer-, overloop- en vulcombinatie 0434092 | voor Sentosa | chrom | 19952000 | stuk | 110,00 | 241 | 1 |
|--|--------------|-------|----------|------|--------|-----|---|

Gootstenen en
wastroggen

| | | | | | | | |
|--|----------|--|----------|------|--------|-----|---|
| aansluitset m. inbouw buisonderbreker m. 3.5m flexibele aansluitpijp 2-delig 0442007 | z. rozet | | 28995000 | stuk | 149,00 | 241 | 1 |
|--|----------|--|----------|------|--------|-----|---|

Utiliteit

| | | | | | | | |
|---|--|-------|----------|------|-------|-----|---|
| rozet voor inbouw buisonderbreker 0434098 | | chrom | 19954000 | stuk | 10,25 | 210 | 1 |
|---|--|-------|----------|------|-------|-----|---|

Badwaste Hansgrohe



| | | | | | | | |
|---|--|--|----------|------|-------|-----|---|
| badafvoer-, overloop- en vulcombinatie m. waste basisgarnituur v. normaal bad 0510297 | | | 58125180 | stuk | 91,00 | 350 | 0 |
|---|--|--|----------|------|-------|-----|---|



| | | | | | | | |
|--|--|--|----------|------|--------|-----|---|
| badafvoer-, overloop- en vulcombinatie m. waste basisgarnituur v. speciaal bad 0510319 | | | 58126180 | stuk | 132,00 | 350 | 0 |
|--|--|--|----------|------|--------|-----|---|



| | Art.nr | Specificaties | Kleur | Lev.nr | Ehd | Prijs | Grp | CC |
|---|---|---|-------------|----------|------|--------|-----|----|
| | Badwaste Hansgrohe | | | | | | | |
| Sanitair producten | kleurset voor badafvoer-, overloop- en vulcombinatie vlakke uitvoering | | | | | | | |
| | 0510378 | | chroom | 58127000 | stuk | 139,00 | 350 | 0 |
| | 0510416 | | chroom/goud | 58127090 | stuk | 197,00 | 350 | 1 |
| | 0510385 | | satinox | 58127810 | stuk | 190,00 | 350 | 1 |
| | kleurset voor badafvoer-, overloop- en vulcombinatie hoge uitvoering | | | | | | | |
| Baden / douchebakken / stoomcabines | 0510424 | | chroom | 58128000 | stuk | 161,00 | 350 | 0 |
| | 0457161 | | chroom/goud | 58128090 | stuk | 220,00 | 176 | 1 |
| | 0510450 | | satinox | 58128810 | stuk | 222,00 | 350 | 1 |
| | flexibele aansluitslang | | | | | | | |
| Douchegarnituur | 0510432 | | | 58191000 | stuk | 71,50 | 350 | 0 |
| | Exafill-S badvulinrichting compleet | | | | | | | |
| Accessoires en spiegels | 0450291 | | chroom | 58113000 | stuk | 178,00 | 176 | 1 |
| | Exafill-S basisgarnituur badvulinrichting | | | | | | | |
| | 0450295 | voor normale baden | | 58115180 | stuk | 81,00 | 176 | 1 |
| | 0450296 | voor speciale baden | | 58116180 | stuk | 114,00 | 176 | 0 |
| | Exafill-S kleurset | | | | | | | |
| Douchewanden | 0450284 | | chroom | 58117000 | stuk | 139,00 | 176 | 0 |
| | 0450285 | | chroom/goud | 58117090 | stuk | 197,00 | 176 | 1 |
| | 0450287 | | wit | 58117450 | stuk | 174,00 | 176 | 1 |
| | 0450288 | | RVS | 58117800 | stuk | 190,00 | 176 | 1 |
| | 0450289 | | satinox | 58117810 | stuk | 190,00 | 176 | 1 |
| | 0450290 | | matchroom | 58117880 | stuk | 180,00 | 176 | 1 |
| | Flexaplust badafvoer/overloop compleet | | | | | | | |
| Spoel- & installatiesystemen | 0450560 | m. flexibele buis | | 58150000 | stuk | 65,50 | 350 | 1 |
| | 0450561 | m. starre buis | | 58155000 | stuk | 65,50 | 350 | 1 |
| | badafvoer- en overloopcombi m. waste basisgarn. normaal bad | | | | | | | |
| Badkamermeubelen en toiletkasten | 0510426 | | | 58140180 | stuk | 36,25 | 350 | 0 |
| | | badafvoer- en overloopcombinatie m. waste basisgarnituur voor speciaal bad | | | | | | |
| Gootstenen en wastroggen | 0510430 | | | 58141180 | stuk | 57,00 | 350 | 0 |
| | | kleurset voor badafvoer- en overloopcombinatie 58140/58141 | | | | | | |
| Utiliteit | 0510428 | | chroom | 58185000 | stuk | 15,50 | 350 | 0 |
| | 0510429 | | chroom/goud | 58185090 | stuk | 71,00 | 350 | 1 |
| | 0510431 | | satinox | 58185810 | stuk | 23,50 | 350 | 1 |
| | 0510419 | | RVS | 58185800 | stuk | 23,50 | 350 | 1 |
| | Flexaplust kleurset | | | | | | | |
| Utiliteit | 0452101 | | chroom | 58186000 | stuk | 24,00 | 176 | 0 |
| | 0452099 | | RVS | 58186800 | stuk | 101,00 | 176 | 1 |
| | 0452103 | | satinox | 58186810 | stuk | 101,00 | 176 | 1 |
| | 0452104 | | matchroom | 58186880 | stuk | 31,75 | 176 | 1 |
| | Badwaste Hoesch | | | | | | | |
| | afvoer- /overloopcombinatie | | | | | | | |
| | 0382590 | | chroom | 69062305 | stuk | 137,00 | 087 | 1 |
| | afvoer- / overloopcombinatie | | | | | | | |
| | 0382604 | | chroom | 6925305 | stuk | 137,00 | 087 | 1 |

| Art.nr | Specificaties | Kleur | Lev.nr | Ehd | Prijs | Grp | CC | |
|--|---------------|-------------|-------------|------|--------|-----|----|---|
| Badwaste Hoesch | | | | | | | | |
| afvoer- /overloop- / vulcombinatie 0380279 | | chroom | 69271305 | stuk | 391,00 | 086 | 1 | |
| Badwaste Kludi | | | | | | | | |
| Rotexa 2000 badwaste 0510361 | | chroom | 213030500 | stuk | 49,75 | 350 | 0 |  |
| Rotexamulti badafvoer voor badvul/overloopcombinatie 0510580 | | chroom | 213150000 | stuk | 79,50 | 350 | 1 |  |
| Rotexamulti afbouwdeel voor badafvoer 0510599 | | chroom | 718200500 | stuk | 117,00 | 350 | 1 |  |
| Rotexamulti afbouwdeel voor badafvoer verlengd 0510610 | | chroom | 708550500 | stuk | 141,00 | 350 | 1 |  |
| 0510629 | | chroom/goud | 708558100 | stuk | 192,00 | 350 | 1 | |
| Newwaves afbouwset v. badwaste 0409626 | | chroom | 570560500 | stuk | 38,00 | 187 | 1 |  |
| Badwaste Viega | | | | | | | | |
| badafvoer- en overloopcombinatie m. waste v. normaal bad 0510661 | | chroom | 3504200S010 | stuk | 16,75 | 350 | 0 | |
| badafvoer- en overloopcombi m. waste normaal bad 0510505 | | chroom | 110031 | stuk | 41,25 | 350 | 0 | |
| badafvoer- en overloopcombinatie m. waste voor speciaal bad 0510572 | | chroom | 364182 | stuk | 41,25 | 350 | 0 | |
| badafvoer- en overloopcombinatie m. waste basisgarnituur voor normaal bad 0510122 | | | 260668 | stuk | 30,75 | 350 | 0 |  |
| badafvoer- en overloopcombinatie m. waste basisgarnituur voor speciaal bad 0510068 | | | 111069 | stuk | 34,75 | 350 | 0 | |
| badafvoer- en overloopcombinatie m. waste basisgarnituur voor normaal bad 0080185 v. afvoer 90mm | | | 488659 | stuk | 97,50 | 350 | 1 | |

Sanitair producten

Baden /
douchebakken /
stoomcabines

Kranen

Douchegarnituur

Accessoires en
spiegels

Douchewanden

Toebehoren &
afvoeren







Spoel- &
installatiesystemen

Badkamermeubelen
en toiletkasten

Gootstenen en
wastroggen

Utiliteit

| | Art.nr | Specificaties | Kleur | Lev.nr | Ehd | Prijs | Grp | CC |
|---|---|--|-------------|---------|------|--------|-----|----|
| | Badwaste Viega | | | | | | | |
| Sanitair producten | kleurset voor badafvoer- en overloopcombinatie | | | | | | | |
| | 0510084 | | chrom | 103378 | stuk | 10,50 | 350 | 0 |
| | 0510548 | | chrom/goud | 174804 | stuk | 73,00 | 350 | 1 |
| | 0510092 | | wit | 110673 | stuk | 38,75 | 350 | 1 |
| | 0082195 | | edelmessing | 124175 | stuk | 92,00 | 350 | 1 |
| Baden / douchebakken / stoomcabines | badafvoer-, overloop- en vulcombinatie m. waste basisgarnituur v. normaal bad | | | | | | | |
| | 0510181 | m. buisonderbreker | | 309374 | stuk | 241,00 | 350 | 0 |
| Kranen | badafvoer-, overloop- en vulcombinatie m. waste basisgarnituur v. speciaal bad | | | | | | | |
| | 0510115 | m. buisonderbreker | | 320881 | stuk | 255,00 | 350 | 0 |
| Douchegarnituur | kleurset voor badafvoer-, overloop- en vulcombinatie | | | | | | | |
| | 0510238 | | chrom | 306847 | stuk | 110,00 | 350 | 0 |
| | 0510289 | | wit | 306922 | stuk | 185,00 | 350 | 1 |
| | 0510290 | | chrom/goud | 311698 | stuk | 211,00 | 350 | 1 |
| Accessoires en spiegels | kleurset voor badafvoer- en overloopcombinatie | | | | | | | |
| | 0080322 | | chrom | 372026 | stuk | 18,00 | 350 | 1 |
| | afdekrozet v. buisonderbreker | | | | | | | |
| | 0510173 | | chrom | 273569 | stuk | 8,30 | 350 | 0 |
| Douchewanden | aansluitgarnituur m. 1,5m flexibele buis | | | | | | | |
| | 0080051 | | | 106010 | stuk | 52,50 | 350 | 0 |
| Toebehoren & afvoeren | buisonderbreker voor inbouw zonder rozet | | | | | | | |
| | 0510149 | 3/4" | | 274528 | stuk | 86,50 | 350 | 1 |
| | aansluitgarnituur compleet m. buizen en inbouw buisonderbreker | | | | | | | |
| | 0500992 | | | 273583 | stuk | 142,00 | 350 | 1 |
| Spoel- & installatiesystemen | Badwaste Onderdelen | | | | | | | |
| | 0510017 | stop voor badplug- en overloopcombinatie | chrom | 103804 | stuk | 11,00 | 350 | 0 |
| | 0510211 | overlooppijpje voor badplug- en overloopcombinatie | tileen | 107130 | stuk | 3,78 | 350 | 1 |
| Badkamermeubelen en toiletkasten | 0510645 | magneetstop voor badplug- en overloopcombinatie | 45.5mm | 111205 | stuk | 6,20 | 350 | 1 |
| Gootstenen en wastroggen | Badsifons McALPINE | | | | | | | |
| | badsifon 5/4"x40mm | | | | | | | |
| | 0520721 | | | 0056050 | stuk | 4,78 | 350 | 1 |
| Utiliteit | badsifon 6/4"x40mm | | | | | | | |
| | 0520748 | | | 0056150 | stuk | 4,78 | 350 | 0 |
| | Badsifons Viega | | | | | | | |
| | badsifon messing m. kunststof koppeling | | | | | | | |
| | 0510477 | 6/4"x40mm | | 124793 | stuk | 18,00 | 350 | 1 |
| | badsifon kunststof klemaansluiting | | | | | | | |
| | 0500274 | 6/4"x40mm | | 120719 | stuk | 6,70 | 350 | 1 |

| Art.nr | Specificaties | Kleur | Lev.nr | Ehd | Prijs | Grp | CC | | |
|--|---------------|-----------------|------------|------|-------|-----|----|---|---|
| | | | | | | | | Douchepluggen Geberit | |
| douchebakafvoer compleet voor douchebak m. gat 52mm | | | | | | | | | |
| 0710652 | z. afdekrozet | chrom | 150125001 | stuk | 13,50 | 328 | 0 |  | Sanitair producten |
| afdekrozet voor douchebakafvoer 150125 | | | | | | | | | |
| 0711764 | | chrom structuur | 150242211 | stuk | 12,00 | 328 | 1 | | Baden / douchebakken / stoomcabines |
| afdekrozet voor doucheafvoer 90mm | | | | | | | | | |
| 0711234 | | chrom/structuur | 150271211 | stuk | 11,25 | 328 | 1 | | Kranen |
| | | | | | | | | Douchepluggen Hansgrohe | |
| douchebakafvoer basisgarnituur voor douchebak m. gat 90mm | | | | | | | | | |
| 0510474 | | | 60054180 | stuk | 34,00 | 350 | 0 |  | Douchegarnituur |
| kleurset voor douchebakafvoer 90mm | | | | | | | | | |
| 0510476 | | chrom | 60055000 | stuk | 12,50 | 350 | 0 |  | Accessoires en spiegels |
| 0607029 | | RVS | 60055800 | stuk | 17,75 | 350 | 1 | | |
| 0510478 | | satinox | 60055810 | stuk | 17,75 | 350 | 1 | | |
| 0510470 | | brushed nikkel | 60055820 | stuk | 49,75 | 350 | 1 | | |
| 0510471 | | polished nikkel | 60055830 | stuk | 43,00 | 350 | 1 | | |
| douchebakafvoer basisgarnituur voor douchebak m. gat 52mm | | | | | | | | | |
| 0510469 | | | 60052180 | stuk | 16,25 | 350 | 1 |  | Toebehoren & afvoeren |
| kleurset m. telescoop standpijp voor douchebakafvoer 52mm | | | | | | | | | |
| 0510468 | | chrom | 60053000 | stuk | 11,00 | 350 | 1 |  | Badkamermeubelen en toiletkasten |
| 0510472 | | satinox | 60053810 | stuk | 15,50 | 350 | 1 | | |
| 0510417 | | RVS | 60053800 | stuk | 15,50 | 350 | 1 | | |
| 0510473 | | brushed nikkel | 60053820 | stuk | 39,25 | 350 | 1 | | |
| 0510479 | | polished nikkel | 60053830 | stuk | 34,25 | 350 | 1 | | |
| | | | | | | | | Douchepluggen Kludi | |
| Tasso douchebakafvoer compleet voor douchebak met gat 52mm | | | | | | | | | |
| 0510045 | | chrom | 210540500 | stuk | 19,50 | 350 | 0 |  | Utiliteit |
| Tasso New douchebakafvoer compleet voor douchebak m. gat 90mm | | | | | | | | | |
| 0510125 | | chrom | 2109705N00 | stuk | 37,25 | 350 | 0 | | |
| Tassoplus douchebakafvoer basisgarnituur voor douchebak m. gat 52mm | | | | | | | | | |
| 0400292 | | | 216200000 | stuk | 15,00 | 350 | 1 |  | Gootstenen en wastroggen |
| kleurset m. uitneembare standpijp voor douchebakafvoer 52mm | | | | | | | | | |
| 0401245 | | chrom | 716200500 | stuk | 14,00 | 187 | 1 | | |
| Tasso douchebakafvoer basisgarnituur voor douchebak m. gat 90mm | | | | | | | | | |
| 0400121 | | | 210910000 | stuk | 34,25 | 350 | 1 | | |
| kleurset voor douchebakafvoer 90mm | | | | | | | | | |
| 0400132 | | chrom | 713700500 | stuk | 15,00 | 350 | 1 | | |

Afvoeren douchebak

| | Art.nr | Specificaties | Kleur | Lev.nr | Ehd | Prijs | Grp | CC |
|---|---|----------------|-------------|---------|------|-------|-----|----|
| Sanitair producten | Douchepluggen Viega | | | | | | | |
| | douchebakafvoer compleet voor douchebak m. gat 52mm | | | | | | | |
| | 0510475 | | chrom | 104030 | stuk | 10,50 | 350 | 0 |
| | douchebakafvoer compleet voor douchebak m. gat 52mm m. hoge sifon | | | | | | | |
| | 0520272 | | chrom | 294717 | stuk | 10,75 | 350 | 1 |
| Baden / douchebakken / stoomcabines | douchebakafvoer compleet voor douchebak m. gat 52mm | | | | | | | |
| | 0510041 | | chrom | 129583 | stuk | 22,50 | 350 | 0 |
| Kranen | douchebakafvoer basisgarnituur voor douchebak m. gat 52mm afvoer verticaal | | | | | | | |
| | 0082193 | | | 279219 | stuk | 18,50 | 350 | 1 |
| Douchegarnituur | kleurset voor douchebakafvoer 52mm | | | | | | | |
| | 0500311 | | chrom | 141509 | stuk | 7,40 | 350 | 1 |
| | 0082192 | | edelmessing | 166656 | stuk | 63,50 | 350 | 1 |
| | 0082196 | | wit | 140342 | stuk | 20,00 | 350 | 1 |
| Accessoires en spiegels | douchebakafvoer compleet m. uittrekbare standpijp voor douchebak m. gat 52mm | | | | | | | |
| | 0510521 | | chrom | 327460 | stuk | 29,00 | 350 | 0 |
| Douchewanden | douchebakafvoer compleet voor douchebak m. gat 90mm | | | | | | | |
| | 0510133 | | chrom | 575618 | stuk | 54,37 | 350 | 0 |
| Toebehoren & afvoeren | doucheplug basisgarnituur | | | | | | | |
| | 0510132 | | | 575632 | stuk | 33,35 | 350 | 0 |
| Spoel- & installatiesystemen | kleurset voor douchebakafvoer 90mm | | | | | | | |
| | 0510134 | | chrom | 560799 | stuk | 22,31 | 350 | 0 |
| | kleurset voor douchebakafvoer 90mm (oud model 445386) | | | | | | | |
| | 0510118 | | chrom | 442330 | stuk | 19,50 | 350 | 1 |
| | 0510123 | | chrom/goud | 266844 | stuk | 74,00 | 350 | 1 |
| | 0510128 | | edelmessing | 442354 | stuk | 60,50 | 350 | 1 |
| Badkamermeubelen en toiletkasten | douchebaksifon kunststof | | | | | | | |
| | 0201198 | 6/4"x40mm klem | | 118662 | stuk | 5,40 | 350 | 0 |
| Gootstenen en wastroggen | Vloerpluggen VSH | | | | | | | |
| | eurekaplug RVS vierkant glad 10cm | | | | | | | |
| | 0560022 | | 32mm | 0550154 | stuk | 33,25 | 350 | 0 |
| | 0560065 | | 40mm | 0550198 | stuk | 28,00 | 350 | 0 |
| Utiliteit | eurekaplug RVS vierkant glad 15cm | | | | | | | |
| | 0560111 | | 40mm | 0550231 | stuk | 66,50 | 350 | 0 |
| | deksel RVS voor eurekaplug | | | | | | | |
| | 0560235 | | 10cm | 0550352 | stuk | 26,50 | 350 | 0 |
| | 0560561 | | 15cm | 0550363 | stuk | 38,00 | 350 | 1 |
| | Vloerpluggen ABS | | | | | | | |
| | Vloersifon ABS 40mm 90° | | | | | | | |
| | 2120445 | | grijs | 2120445 | stuk | 3,12 | 454 | 0 |
| | Vloersifon ABS 40mm 180° | | | | | | | |
| 2120453 | | grijs | SA020110119 | stuk | 3,45 | 454 | 0 | |
| Vloersifondeksel ABS los | | | | | | | | |
| 2120003 | | grijs | SA900400101 | stuk | 2,21 | 454 | 0 | |



Slim Tube: De geniale afvoerbuīs

Nieuwbouw volgens NEN 3215

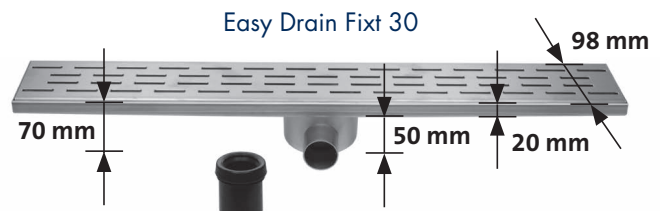
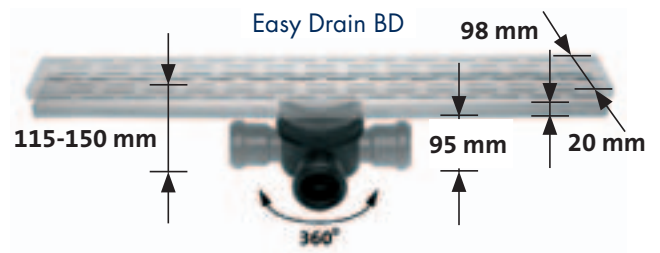

of Renovatie met lage inbouwhoogte

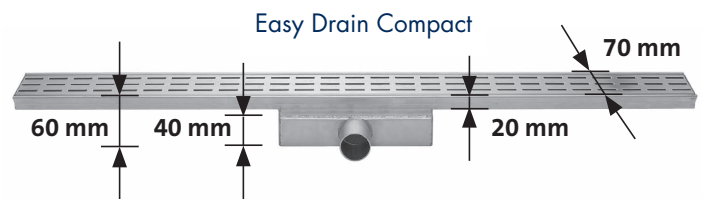
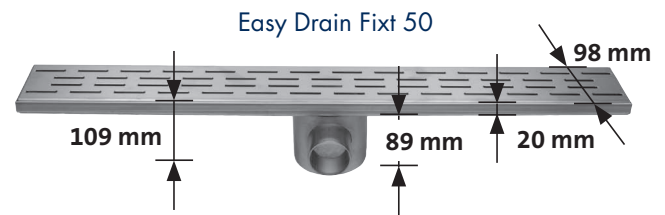

Easy Drain® Collection
made by ess

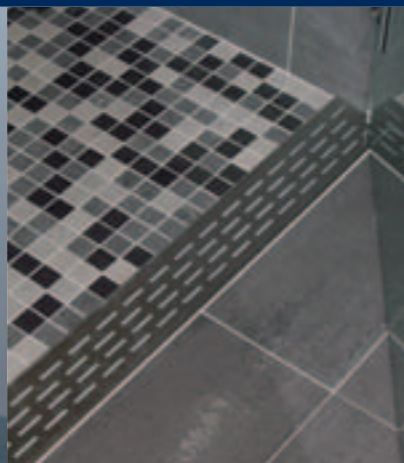

| | Art.nr | Specificaties | Kleur | Lev.nr | Ehd | Prijs | Grp | CC | |
|--|---|-----------------|------------------|------------------|-------------|--------|--------|--------|-----|
| | Easy Drain Class | | | | | | | | |
| | RVS afvoergoot enkele plaat m. sifon | | | | | | | | |
| Sanitair producten | 2301237 | 7x50cm | | ED500 | stuk | 214,00 | 369 | 0 | |
| | 2301245 | 7x60cm | | ED600 | stuk | 219,00 | 369 | 0 | |
| | 2301253 | 7x70cm | | ED700 | stuk | 227,00 | 369 | 0 | |
| | 2301261 | 7x80cm | | ED800 | stuk | 235,00 | 369 | 0 | |
| | 2301288 | 7x90cm | | ED900 | stuk | 245,00 | 369 | 0 | |
| | 2301296 | 7x100cm | | ED1000 | stuk | 249,00 | 369 | 0 | |
| | 2301411 | 7x110cm | | ED1100 | stuk | 254,00 | 369 | 1 | |
| Baden / douchebakken / stoomcabines | 2301318 | 7x120cm | | ED1200 | stuk | 257,00 | 369 | 0 | |
| | RVS afvoergoot dubbele plaat m. sifon | | | | | | | | |
| | Kranen | 2301412 | 7x50cm | | ED500D | stuk | 247,00 | 369 | 1 |
| | | 2301326 | 7x60cm | | ED600D | stuk | 253,00 | 369 | 1 |
| | | 2301334 | 7x70cm | | ED700D | stuk | 263,00 | 369 | 0 |
| | | 2301338 | 7x78.5cm | | ED785D | stuk | 289,00 | 369 | 1 |
| | | Douchegarnituur | 2301342 | 7x80cm | | ED800D | stuk | 275,00 | 369 |
| 2301345 | | | 7x88.5cm | | ED885D | stuk | 299,00 | 369 | 0 |
| 2301350 | | | 7x90cm | | ED900D | stuk | 285,00 | 369 | 0 |
| 2301369 | 7x100cm | | | ED1000D | stuk | 290,00 | 369 | 0 | |
| Accessoires en spiegels | 2301413 | | 70x110cm | | ED1100D | stuk | 296,00 | 369 | 1 |
| | 2301377 | | 7x120cm | | ED1200D | stuk | 299,00 | 369 | 1 |
| Easy Drain Fixt | | | | | | | | | |
| RVS afvoergoot enkele plaat m. sifon | | | | | | | | | |
| Douchewanden | 2301414 | 9.8x50cm | | EDFT50030 | stuk | 214,00 | 369 | 1 | |
| | 2301415 | 9.8x60cm | zij-uitloop 30mm | EDFT60030 | stuk | 219,00 | 369 | 1 | |
| | 2301416 | 9.8x70cm | zij-uitloop 30mm | EDFT70030 | stuk | 227,00 | 369 | 1 | |
| | 2301417 | 9.8x80cm | zij-uitloop 30mm | EDFT80030 | stuk | 235,00 | 369 | 1 | |
| | Toebehoren & afvoeren | 2301418 | 9.8x90cm | zij-uitloop 30mm | EDFT90030 | stuk | 245,00 | 369 | 1 |
| | | 2301419 | 9.8x100cm | zij-uitloop 30mm | EDFT100030 | stuk | 249,00 | 369 | 1 |
| | | 2301420 | 9.8x110cm | zij-uitloop 30mm | EDFT110030 | stuk | 254,00 | 369 | 1 |
| 2301421 | | 9.8x120cm | zij-uitloop 30mm | EDFT120030 | stuk | 257,00 | 369 | 1 | |
| RVS afvoergoot dubbele plaat m. sifon | | | | | | | | | |
| Spoel- & installatiesystemen | | 2301422 | 9.8x50cm | zij-uitloop 30mm | EDFT50030D | stuk | 247,00 | 369 | 1 |
| | | 2301423 | 9.8x60cm | zij-uitloop 30mm | EDFT60030D | stuk | 253,00 | 369 | 1 |
| | 2301424 | 9.8x70cm | zij-uitloop 30mm | EDFT70030D | stuk | 253,00 | 369 | 1 | |
| | 2301425 | 9.8x78.5cm | zij-uitloop 30mm | EDFT78530D | stuk | 289,00 | 369 | 1 | |
| | Badkamermeubelen en toiletkasten | 2301426 | 9.8x80cm | zij-uitloop 30mm | EDFT80030D | stuk | 275,00 | 369 | 1 |
| | | 2301427 | 9.8x88.5cm | zij-uitloop 30mm | EDFT88530D | stuk | 299,00 | 369 | 1 |
| | | 2301428 | 9.8x90cm | zij-uitloop 30mm | EDFT90030D | stuk | 285,00 | 369 | 1 |
| 2301429 | | 9.8x100cm | zij-uitloop 30mm | EDFT100030D | stuk | 290,00 | 369 | 1 | |
| Gootstenen en wastroggen | | 2301430 | 9.8x110cm | zij-uitloop 30mm | EDFT110030D | stuk | 296,00 | 369 | 1 |
| | | 2301431 | 9.8x120cm | zij-uitloop 30mm | EDFT120030D | stuk | 299,00 | 369 | 1 |
| RVS afvoergoot enkele plaat m. sifon m. waterslot 3.5cm | | | | | | | | | |
| Utiliteit | 2301041 | 9.5x50cm | | EDFT50035 | stuk | 214,00 | 369 | 0 | |
| | 2301042 | 9.5x60cm | | EDFT60035 | stuk | 219,00 | 369 | 0 | |
| | 2301043 | 9.5x70cm | | EDFT70035 | stuk | 227,00 | 369 | 0 | |
| | 2301044 | 9.8x80cm | | EDFT80035 | stuk | 235,00 | 369 | 0 | |
| | 2301045 | 9.5x90cm | | EDFT90035 | stuk | 245,00 | 369 | 0 | |
| | 2301046 | 9.5x100cm | | EDFT100035 | stuk | 249,00 | 369 | 0 | |
| | 2301047 | 9.5x110cm | | EDFT110035 | stuk | 254,00 | 369 | 1 | |
| | 2301048 | 9.5x120cm | | EDFT120035 | stuk | 257,00 | 369 | 1 | |
| | RVS afvoergoot dubbele plaat m. sifon m. waterslot 3.5cm | | | | | | | | |
| | 2301049 | 9.5x50cm | | EDFT50035D | stuk | 247,00 | 369 | 1 | |
| | 2301050 | 9.5x60cm | | EDFT60035D | stuk | 253,00 | 369 | 1 | |
| | 2301051 | 9.5x70cm | | EDFT70035D | stuk | 263,00 | 369 | 0 | |
| | 2301052 | 9.5x78.5cm | | EDFT78535D | stuk | 289,00 | 369 | 1 | |
| | 2301053 | 9.5x80cm | | EDFT80035D | stuk | 275,00 | 369 | 0 | |
| | 2301054 | 9.5x88.5cm | | EDFT88535D | stuk | 299,00 | 369 | 1 | |
| | 2301055 | 9.5x90cm | | EDFT90035D | stuk | 285,00 | 369 | 0 | |
| | 2301056 | 9.5x100cm | | EDFT100035D | stuk | 290,00 | 369 | 0 | |
| | 2301057 | 9.5x110cm | | EDFT110035D | stuk | 296,00 | 369 | 1 | |
| | 2301058 | 9.5x120cm | | EDFT120035D | stuk | 299,00 | 369 | 1 | |

| Art.nr | Specificaties | Kleur | Lev.nr | Ehd | Prijs | Grp | CC |
|--------|---------------|-------|--------|-----|-------|-----|----|
|--------|---------------|-------|--------|-----|-------|-----|----|

Easy Drain Fixt

RVS afvoergoot enkel plaat m. sifon m. waterslot 5cm

| | | | | | | | |
|---------|-----------|--|------------|------|--------|-----|---|
| 2301022 | 9.5x50cm | | EDFT50050 | stuk | 214,00 | 369 | 1 |
| 2301023 | 9.5x60cm | | EDFT60050 | stuk | 219,00 | 369 | 0 |
| 2301025 | 9.5x70cm | | EDFT70050 | stuk | 227,00 | 369 | 0 |
| 2301026 | 9.5x80cm | | EDFT80050 | stuk | 235,00 | 369 | 0 |
| 2301027 | 9.5x90cm | | EDFT90050 | stuk | 245,00 | 369 | 0 |
| 2301028 | 9.5x100cm | | EDFT100050 | stuk | 249,00 | 369 | 0 |
| 2301029 | 9.5x110cm | | EDFT110050 | stuk | 254,00 | 369 | 1 |
| 2301030 | 9.5x120cm | | EDFT120050 | stuk | 257,00 | 369 | 1 |

Sanitair producten

Baden /
douchebakken /
stoomcabines

Kranen

Douchegarnituur

Accessoires en
spiegels

RVS afvoergoot dubbele plaat m. sifon m. waterslot 5cm

| | | | | | | | |
|---------|------------|--|-------------|------|--------|-----|---|
| 2301031 | 9.5x50cm | | EDFT50050D | stuk | 247,00 | 369 | 1 |
| 2301032 | 9.5x60cm | | EDFT60050D | stuk | 253,00 | 369 | 1 |
| 2301033 | 9.5x70cm | | EDFT70050D | stuk | 263,00 | 369 | 1 |
| 2301034 | 9.5x78.5cm | | EDFT78550D | stuk | 289,00 | 369 | 1 |
| 2301035 | 9.5x80cm | | EDFT80050D | stuk | 275,00 | 369 | 1 |
| 2301036 | 9.5x88.5cm | | EDFT88550D | stuk | 299,00 | 369 | 1 |
| 2301037 | 9.5x90cm | | EDFT90050D | stuk | 285,00 | 369 | 1 |
| 2301038 | 9.5x100cm | | EDFT100050D | stuk | 290,00 | 369 | 1 |
| 2301039 | 9.5x110cm | | EDFT110050D | stuk | 296,00 | 369 | 1 |
| 2301040 | 9.5x120cm | | EDFT120050D | stuk | 299,00 | 369 | 1 |

Easy Drain Flex

RVS afvoergoot enkele plaat z. sifon

| | | | | | | | |
|---------|---------|--|----------|------|--------|-----|---|
| 2301432 | 7x50cm | | EDFL500 | stuk | 214,00 | 369 | 1 |
| 2301433 | 7x60cm | | EDFL600 | stuk | 219,00 | 369 | 1 |
| 2301434 | 7x70cm | | EDFL700 | stuk | 227,00 | 369 | 1 |
| 2301435 | 7x80cm | | EDFL800 | stuk | 235,00 | 369 | 1 |
| 2301436 | 7x90cm | | EDFL900 | stuk | 245,00 | 369 | 1 |
| 2301437 | 7x100cm | | EDFL1000 | stuk | 249,00 | 369 | 1 |
| 2301438 | 7x110cm | | EDFL1100 | stuk | 254,00 | 369 | 1 |
| 2301439 | 7x120cm | | EDFL1200 | stuk | 257,00 | 369 | 1 |

Douchewanden

Toebehoren &
afvoeren

RVS afvoergoot dubbele plaat z. sifon

| | | | | | | | |
|---------|----------|--|-----------|------|--------|-----|---|
| 2301440 | 7x50cm | | EDFL500D | stuk | 247,00 | 369 | 1 |
| 2301441 | 7x60cm | | EDFL600D | stuk | 253,00 | 369 | 1 |
| 2301442 | 7x70cm | | EDFL700D | stuk | 263,00 | 369 | 1 |
| 2301443 | 7x78.5cm | | EDFL785D | stuk | 289,00 | 369 | 1 |
| 2301444 | 7x80cm | | EDFL800D | stuk | 275,00 | 369 | 1 |
| 2301445 | 7x88.5cm | | EDFL885D | stuk | 299,00 | 369 | 1 |
| 2301446 | 7x90cm | | EDFL900D | stuk | 285,00 | 369 | 1 |
| 2301447 | 7x100cm | | EDFL1000D | stuk | 290,00 | 369 | 1 |
| 2301448 | 7x110cm | | EDFL1100D | stuk | 296,00 | 369 | 1 |
| 2301449 | 7x120cm | | EDFL1200D | stuk | 299,00 | 369 | 1 |

Spoel- &
installatiesystemenBadkamermeubelen
en toiletkastenGootstenen en
wastroggen

Easy Drain Pro

RVS afvoergoot enkele plaat z. sifon

| | | | | | | | |
|---------|----------|--|---------|------|--------|-----|---|
| 2301003 | 12x50cm | | EDP500 | stuk | 214,00 | 369 | 1 |
| 2301004 | 12x60cm | | EDP600 | stuk | 219,00 | 369 | 1 |
| 2301005 | 12x70cm | | EDP700 | stuk | 227,00 | 369 | 1 |
| 2301006 | 12x80cm | | EDP800 | stuk | 235,00 | 369 | 1 |
| 2301007 | 12x90cm | | EDP900 | stuk | 245,00 | 369 | 1 |
| 2301008 | 12x100cm | | EDP1000 | stuk | 249,00 | 369 | 1 |
| 2301009 | 12x110cm | | EDP1100 | stuk | 254,00 | 369 | 1 |
| 2301010 | 12x120cm | | EDP1200 | stuk | 257,00 | 369 | 1 |

Utiliteit

RVS afvoergoot dubbele plaat z. sifon

| | | | | | | | |
|---------|-----------|--|----------|------|--------|-----|---|
| 2301011 | 12x50cm | | EDP500D | stuk | 247,00 | 369 | 1 |
| 2301012 | 12x60cm | | EDP600D | stuk | 253,00 | 369 | 1 |
| 2301013 | 12x70cm | | EDP700D | stuk | 263,00 | 369 | 1 |
| 2301014 | 12x78.5cm | | EDP785D | stuk | 289,00 | 369 | 1 |
| 2301015 | 12x80cm | | EDP800D | stuk | 275,00 | 369 | 1 |
| 2301017 | 12x88.5cm | | EDP885D | stuk | 299,00 | 369 | 1 |
| 2301018 | 12x90cm | | EDP900D | stuk | 285,00 | 369 | 1 |
| 2301019 | 12x100cm | | EDP1000D | stuk | 290,00 | 369 | 1 |
| 2301020 | 12x110cm | | EDP1100D | stuk | 296,00 | 369 | 1 |
| 2301021 | 12x120cm | | EDP1200D | stuk | 299,00 | 369 | 1 |

| | Art.nr | Specificaties | Kleur | Lev.nr | Ehd | Prijs | Grp | CC | |
|---|--|---------------|-------|------------|------|--------|-----|----|--|
| Easy Drain Class Wall | | | | | | | | | |
| RVS afvoergoot enkele plaat m. sifon | | | | | | | | | |
| Sanitair producten | 2301450 | 7x80cm | | EDW800 | stuk | 235,00 | 369 | 1 | |
| | 2301451 | 7x90cm | | EDW900 | stuk | 245,00 | 369 | 1 | |
| | 2301452 | 7x100cm | | EDW1000 | stuk | 249,00 | 369 | 1 | |
| | 2301453 | 7x110cm | | EDW1100 | stuk | 254,00 | 369 | 1 | |
| Baden / douchebakken / stoomcabines | 2301454 | 7x120cm | | EDW1200 | stuk | 257,00 | 369 | 1 | |
| | Easy Drain Flex Wall | | | | | | | | |
| RVS afvoergoot enkele plaat z. sifon | | | | | | | | | |
| Kranen | 2301455 | 7x80cm | | EDFLW800 | stuk | 235,00 | 369 | 1 | |
| | 2301456 | 7x90cm | | EDFLW900 | stuk | 245,00 | 369 | 1 | |
| | 2301457 | 7x100cm | | EDFLW1000 | stuk | 249,00 | 369 | 1 | |
| | 2301458 | 7x110cm | | EDFLW1100 | stuk | 254,00 | 369 | 1 | |
| | 2301459 | 7x120cm | | EDFLW1200 | stuk | 257,00 | 369 | 1 | |
| Easy Drain Class Move | | | | | | | | | |
| RVS afvoergoot enkele plaat m. sifon | | | | | | | | | |
| Douchegarnituur | 2301460 | 7x50cm | | EDCLM500 | stuk | 214,00 | 369 | 1 | |
| | 2301461 | 7x60cm | | EDCLM600 | stuk | 219,00 | 369 | 1 | |
| Accessoires en spiegels | 2301462 | 7x70cm | | EDCLM700 | stuk | 227,00 | 369 | 1 | |
| | 2301463 | 7x80cm | | EDCLM800 | stuk | 235,00 | 369 | 1 | |
| | 2301464 | 7x90cm | | EDCLM900 | stuk | 245,00 | 369 | 1 | |
| | 2301465 | 7x100cm | | EDCLM1000 | stuk | 249,00 | 369 | 1 | |
| | 2301466 | 7x110cm | | EDCLM1100 | stuk | 254,00 | 369 | 1 | |
| Douchewanden | 2301467 | 7x120cm | | EDCLM1200 | stuk | 257,00 | 369 | 1 | |
| | RVS afvoergoot dubbele plaat m. sifon | | | | | | | | |
| Toebehoren & afvoeren | 2301468 | 7x50cm | | EDCLM500D | stuk | 247,00 | 369 | 1 | |
| | 2301469 | 7x60cm | | EDCLM600D | stuk | 253,00 | 369 | 1 | |
| | 2301470 | 7x70cm | | EDCLM700D | stuk | 263,00 | 369 | 1 | |
| | 2301471 | 7x78.5cm | | EDCLM785D | stuk | 289,00 | 369 | 1 | |
| | 2301472 | 7x80cm | | EDCLM800D | stuk | 275,00 | 369 | 1 | |
| | 2301473 | 7x88.5cm | | EDCLM885D | stuk | 299,00 | 369 | 1 | |
| | 2301474 | 7x90cm | | EDCLM900D | stuk | 285,00 | 369 | 1 | |
| | 2301475 | 7x100cm | | EDCLM1000D | stuk | 290,00 | 369 | 1 | |
| Spoel- & installatiesystemen | 2301476 | 7x110cm | | EDCLM1100D | stuk | 296,00 | 369 | 1 | |
| | 2301477 | 7x120cm | | EDCLM1200D | stuk | 299,00 | 369 | 1 | |
| Easy Drain Flex Move | | | | | | | | | |
| RVS afvoergoot enkele plaat z. sifon | | | | | | | | | |
| Badkamermeubelen en toiletkasten | 2301478 | 7x50cm | | EDFLM500 | stuk | 214,00 | 369 | 1 | |
| | 2301479 | 7x60cm | | EDFLM600 | stuk | 219,00 | 369 | 1 | |
| Gootstenen en wastroggen | 2301480 | 7x70cm | | EDFLM700 | stuk | 227,00 | 369 | 1 | |
| | 2301481 | 7x80cm | | EDFLM800 | stuk | 235,00 | 369 | 1 | |
| | 2301482 | 7x90cm | | EDFLM900 | stuk | 245,00 | 369 | 1 | |
| | 2301483 | 7x100cm | | EDFLM1000 | stuk | 249,00 | 369 | 1 | |
| | 2301484 | 7x110cm | | EDFLM1100 | stuk | 254,00 | 369 | 1 | |
| Utiliteit | 2301485 | 7x120cm | | EDFLM1200 | stuk | 257,00 | 369 | 1 | |
| | RVS afvoergoot dubbele plaat z. sifon | | | | | | | | |
| | 2301486 | 7x50cm | | EDFLM500D | stuk | 247,00 | 369 | 1 | |
| | 2301487 | 7x60cm | | EDFLM600D | stuk | 253,00 | 369 | 1 | |
| | 2301488 | 7x70cm | | EDFLM700D | stuk | 263,00 | 369 | 1 | |
| | 2301489 | 7x78.5cm | | EDFLM785D | stuk | 289,00 | 369 | 1 | |
| | 2301490 | 7x80cm | | EDFLM800D | stuk | 275,00 | 369 | 1 | |
| | 2301491 | 7x88.5cm | | EDFLM885D | stuk | 299,00 | 369 | 1 | |
| | 2301492 | 7x90cm | | EDFLM900D | stuk | 285,00 | 369 | 1 | |
| | 2301493 | 7x100cm | | EDFLM1000D | stuk | 290,00 | 369 | 1 | |
| | 2301494 | 7x110cm | | EDFLM1100D | stuk | 296,00 | 369 | 1 | |
| | 2301495 | 7x120cm | | EDFLM1200D | stuk | 299,00 | 369 | 1 | |
| Easy Drain Class Polished | | | | | | | | | |
| RVS afvoergoot enkele plaat m. sifon | | | | | | | | | |
| | 2301496 | 7x50cm | | EDCLP500 | stuk | 214,00 | 369 | 1 | |
| | 2301497 | 7x60cm | | EDCLP600 | stuk | 219,00 | 369 | 1 | |
| | 2301498 | 7x70cm | | EDCLP700 | stuk | 227,00 | 369 | 1 | |
| | 2301499 | 7x80cm | | EDCLP800 | stuk | 235,00 | 369 | 1 | |
| | 2301500 | 7x90cm | | EDCLP900 | stuk | 245,00 | 369 | 1 | |
| | 2301501 | 7x100cm | | EDCLP1000 | stuk | 0,00 | 369 | 1 | |
| | 2301502 | 7x110cm | | EDCLP1100 | stuk | 254,00 | 369 | 1 | |
| | 2301503 | 7x120cm | | EDCLP1200 | stuk | 257,00 | 369 | 1 | |

| Art.nr | Specificaties | Kleur | Lev.nr | Ehd | Prijs | Grp | CC |
|--------|---------------|-------|--------|-----|-------|-----|----|
|--------|---------------|-------|--------|-----|-------|-----|----|

Easy Drain Class Polished

RVS afvoergoot dubbele plaat m. sifon

| | | | | | | | |
|---------|----------|--|------------|------|--------|-----|---|
| 2301504 | 7x50cm | | EDCLP500D | stuk | 247,00 | 369 | 1 |
| 2301505 | 7x60cm | | EDCLP600D | stuk | 253,00 | 369 | 1 |
| 2301506 | 7x70cm | | EDCLP700D | stuk | 263,00 | 369 | 1 |
| 2301507 | 7x78.5cm | | EDCLP785D | stuk | 289,00 | 369 | 1 |
| 2301508 | 7x80cm | | EDCLP800D | stuk | 275,00 | 369 | 1 |
| 2301509 | 7x88.5cm | | EDCLP885D | stuk | 299,00 | 369 | 1 |
| 2301510 | 7x90cm | | EDCLP900D | stuk | 285,00 | 369 | 1 |
| 2301511 | 7x100cm | | EDCLP1000D | stuk | 290,00 | 369 | 1 |
| 2301512 | 7x110cm | | EDCLP1100D | stuk | 296,00 | 369 | 1 |
| 2301513 | 7x120cm | | EDCLP1200D | stuk | 299,00 | 369 | 1 |

Sanitair producten

Baden /
douchebakken /
stoomcabines

Kranen

Easy Drain Fixt Polished

RVS afvoergoot enkele plaat m. sifon

| | | | | | | | |
|---------|-----------|------------------|-------------|------|--------|-----|---|
| 2301514 | 9.8x50cm | zij-uitloop 30mm | EDFTP50030 | stuk | 214,00 | 369 | 1 |
| 2301515 | 9.8x60cm | zij-uitloop 30mm | EDFTP60030 | stuk | 219,00 | 369 | 1 |
| 2301516 | 9.8x70cm | | EDFTP70030 | stuk | 227,00 | 369 | 1 |
| 2301517 | 9.8x80cm | zij-uitloop 30mm | EDFTP80030 | stuk | 235,00 | 369 | 1 |
| 2301518 | 9.8x90cm | zij-uitloop 30mm | EDFTP90030 | stuk | 245,00 | 369 | 1 |
| 2301519 | 9.8x100cm | zij-uitloop 30mm | EDFTP100030 | stuk | 249,00 | 369 | 1 |
| 2301520 | 9.8x110cm | zij-uitloop 30mm | EDFTP110030 | stuk | 254,00 | 369 | 1 |
| 2301521 | 9.8x120cm | zij-uitloop 30mm | EDFTP120030 | stuk | 257,00 | 369 | 1 |

Douchegarnituur

Accessoires en
spiegels

RVS afvoergoot dubbele plaat m. sifon

| | | | | | | | |
|---------|------------|------------------|--------------|------|--------|-----|---|
| 2301522 | 9.8x50cm | | EDFTP50030D | stuk | 247,00 | 369 | 1 |
| 2301523 | 9.8x60cm | zij-uitloop 30mm | EDFTP60030D | stuk | 253,00 | 369 | 1 |
| 2301524 | 9.8x70cm | zij-uitloop 30mm | EDFTP70030D | stuk | 263,00 | 369 | 1 |
| 2301525 | 9.8x78.5cm | zij-uitloop 30mm | EDFTP78530D | stuk | 289,00 | 369 | 1 |
| 2301526 | 9.8x80cm | zij-uitloop 30mm | EDFTP80030D | stuk | 275,00 | 369 | 1 |
| 2301527 | 9.8x88.5cm | zij-uitloop 30mm | EDFTP88530D | stuk | 299,00 | 369 | 1 |
| 2301528 | 9.8x90cm | zij-uitloop 30mm | EDFTP90030D | stuk | 285,00 | 369 | 1 |
| 2301529 | 9.8x100cm | zij-uitloop 30mm | EDFTP100030D | stuk | 290,00 | 369 | 1 |
| 2301530 | 9.8x110cm | zij-uitloop 30mm | EDFTP110030D | stuk | 296,00 | 369 | 1 |
| 2301531 | 9.8x120cm | zij-uitloop 30mm | EDFTP120030D | stuk | 299,00 | 369 | 1 |

Douchewanden

Toebehoren &
afvoeren

Spoel- &
installatiesystemen

RVS afvoergoot enkele plaat m. sifon

| | | | | | | | |
|---------|-----------|------------------|-------------|------|--------|-----|---|
| 2301532 | 9.8x50cm | zij-uitloop 35mm | EDFTP50035 | stuk | 214,00 | 369 | 1 |
| 2301533 | 9.8x60cm | zij-uitloop 35mm | EDFTP60035 | stuk | 219,00 | 369 | 1 |
| 2301534 | 9.8x70cm | zij-uitloop 35mm | EDFTP70035 | stuk | 227,00 | 369 | 1 |
| 2301535 | 9.8x80cm | zij-uitloop 35mm | EDFTP80035 | stuk | 235,00 | 369 | 1 |
| 2301536 | 9.8x90cm | zij-uitloop 35mm | EDFTP90035 | stuk | 245,00 | 369 | 1 |
| 2301537 | 9.8x100cm | zij-uitloop 35mm | EDFTP100035 | stuk | 249,00 | 369 | 1 |
| 2301538 | 9.8x110cm | zij-uitloop 35mm | EDFTP110035 | stuk | 254,00 | 369 | 1 |
| 2301539 | 9.8x120cm | zij-uitloop 35mm | EDFTP120035 | stuk | 257,00 | 369 | 1 |

Badkamermeubelen
en toiletkasten

Gootstenen en
wastroggen

RVS afvoergoot dubbele plaat m. sifon

| | | | | | | | |
|---------|------------|------------------|--------------|------|--------|-----|---|
| 2301540 | 9.8x50cm | zij-uitloop 35mm | EDFTP50035D | stuk | 247,00 | 369 | 1 |
| 2301541 | 9.8x60cm | zij-uitloop 35mm | EDFTP60035D | stuk | 253,00 | 369 | 1 |
| 2301542 | 9.8x70cm | zij-uitloop 35mm | EDFTP70035D | stuk | 263,00 | 369 | 1 |
| 2301543 | 9.8x78.5cm | zij-uitloop 35mm | EDFTP78535D | stuk | 289,00 | 369 | 1 |
| 2301544 | 9.8x80cm | zij-uitloop 35mm | EDFTP80035D | stuk | 275,00 | 369 | 1 |
| 2301545 | 9.8x88.5cm | zij-uitloop 35mm | EDFTP88535D | stuk | 299,00 | 369 | 1 |
| 2301546 | 9.8x90cm | zij-uitloop 35mm | EDFTP90035D | stuk | 285,00 | 369 | 1 |
| 2301547 | 9.8x100cm | zij-uitloop 35mm | EDFTP100035D | stuk | 290,00 | 369 | 1 |
| 2301548 | 9.8x110cm | zij-uitloop 35mm | EDFTP110035D | stuk | 296,00 | 369 | 1 |
| 2301549 | 9.8x120cm | zij-uitloop 35mm | EDFTP120035D | stuk | 299,00 | 369 | 1 |

Utiliteit

| Art.nr | Specificaties | Kleur | Lev.nr | Ehd | Prijs | Grp | CC |
|--------|---------------|-------|--------|-----|-------|-----|----|
|--------|---------------|-------|--------|-----|-------|-----|----|

Easy Drain Fixt Polished

RVS afvoergoot enkele plaat m. sifon

| | | | | | | | | |
|---|---------|------------|------------------|--------------|------|--------|-----|---|
| Sanitair producten | 2301550 | 9.8x50cm | zij-uitloop 50mm | EDFTP50050 | stuk | 214,00 | 369 | 1 |
| | 2301551 | 9.8x60cm | zij-uitloop 50mm | EDFTP60050 | stuk | 219,00 | 369 | 1 |
| | 2301552 | 9.8x70cm | zij-uitloop 50mm | EDFTP70050 | stuk | 227,00 | 369 | 1 |
| Baden / douchebakken / stoomcabines | 2301553 | 9.8x80cm | zij-uitloop 50mm | EDFTP80050 | stuk | 235,00 | 369 | 1 |
| | 2301554 | 9.8x90cm | zij-uitloop 50mm | EDFTP90050 | stuk | 245,00 | 369 | 1 |
| | 2301555 | 9.8x100cm | zij-uitloop 50mm | EDFTP100050 | stuk | 249,00 | 369 | 1 |
| | 2301556 | 9.8x110cm | zij-uitloop 50mm | EDFTP110050 | stuk | 254,00 | 369 | 1 |
| | 2301557 | 9.8x120cm | zij-uitloop 50mm | EDFTP120050 | stuk | 257,00 | 369 | 1 |
| Kranen | 2301558 | 9.8x50cm | zij-uitloop 50mm | EDFTP50050D | stuk | 247,00 | 369 | 1 |
| | 2301559 | 9.8x60cm | zij-uitloop 50mm | EDFTP60050D | stuk | 253,00 | 369 | 1 |
| | 2301560 | 9.8x70cm | zij-uitloop 50mm | EDFTP70050D | stuk | 263,00 | 369 | 1 |
| | 2301561 | 9.8x78.5cm | zij-uitloop 50mm | EDFTP78550D | stuk | 289,00 | 369 | 1 |
| Douchegarnituur | 2301562 | 9.8x80cm | zij-uitloop 50mm | EDFTP80050D | stuk | 275,00 | 369 | 1 |
| | 2301563 | 9.8x88.5cm | zij-uitloop 50mm | EDFTP88550D | stuk | 299,00 | 369 | 1 |
| | 2301564 | 9.8x90cm | zij-uitloop 50mm | EDFTP90050D | stuk | 285,00 | 369 | 1 |
| | 2301565 | 9.8x100cm | zij-uitloop 50mm | EDFTP100050D | stuk | 290,00 | 369 | 1 |
| | 2301566 | 9.8x110cm | zij-uitloop 50mm | EDFTP110050D | stuk | 296,00 | 369 | 1 |
| Accessoires en spiegels | 2301567 | 9.8x120cm | zij-uitloop 50mm | EDFTP120050D | stuk | 299,00 | 369 | 1 |

Easy Drain Class Zero

RVS afvoergoot enkele plaat m. sifon

| | | | | | | | | |
|--------------------------|---------|---------|--|-----------|------|--------|-----|---|
| Douchewanden | 2301568 | 7x50cm | | EDCLZ500 | stuk | 268,00 | 369 | 1 |
| | 2301569 | 7x60cm | | EDCLZ600 | stuk | 274,00 | 369 | 1 |
| | 2301570 | 7x70cm | | EDCLZ700 | stuk | 284,00 | 369 | 1 |
| | 2301571 | 7x80cm | | EDCLZ800 | stuk | 294,00 | 369 | 1 |
| | 2301572 | 7x90cm | | EDCLZ900 | stuk | 306,00 | 369 | 1 |
| | 2301573 | 7x100cm | | EDCLZ1000 | stuk | 311,00 | 369 | 1 |
| Toebehoren & afvoeren | 2301574 | 7x110cm | | EDCLZ1100 | stuk | 318,00 | 369 | 1 |
| | 2301575 | 7x120cm | | EDCLZ1200 | stuk | 321,00 | 369 | 1 |

Easy Drain Fixt Zero

RVS afvoergoot enkele plaat m. sifon

| | | | | | | | | |
|-------------------------------------|---------|-----------|------------------|-------------|------|--------|-----|---|
| Spoel- & installatiesystemen | 2301576 | 9.8x50cm | zij-uitloop 30mm | EDFTZ50030 | stuk | 268,00 | 369 | 1 |
| | 2301577 | 9.8x60cm | zij-uitloop 30mm | EDFTZ60030 | stuk | 274,00 | 369 | 1 |
| | 2301578 | 9.8x70cm | zij-uitloop 30mm | EDFTZ70030 | stuk | 284,00 | 369 | 1 |
| Badkamermeubelen en toiletkasten | 2301579 | 9.8x80cm | zij-uitloop 30mm | EDFTZ80030 | stuk | 294,00 | 369 | 1 |
| | 2301580 | 9.8x90cm | zij-uitloop 30mm | EDFTZ90030 | stuk | 306,00 | 369 | 1 |
| | 2301581 | 9.8x100cm | zij-uitloop 30mm | EDFTZ100030 | stuk | 311,00 | 369 | 1 |
| | 2301582 | 9.8x110cm | zij-uitloop 30mm | EDFTZ110030 | stuk | 318,00 | 369 | 1 |
| | 2301583 | 9.8x120cm | zij-uitloop 30mm | EDFTZ120030 | stuk | 321,00 | 369 | 1 |
| | 2301584 | 9.8x50cm | zij-uitloop 35mm | EDFTZ50035 | stuk | 268,00 | 369 | 1 |
| Gootstenen en wastroggen | 2301585 | 9.8x60cm | zij-uitloop 35mm | EDFTZ60035 | stuk | 274,00 | 369 | 1 |
| | 2301586 | 9.8x70cm | zij-uitloop 35mm | EDFTZ70035 | stuk | 284,00 | 369 | 1 |
| | 2301587 | 9.8x80cm | zij-uitloop 35mm | EDFTZ80035 | stuk | 294,00 | 369 | 1 |
| | 2301588 | 9.8x90cm | zij-uitloop 35mm | EDFTZ90035 | stuk | 306,00 | 369 | 1 |
| | 2301589 | 9.8x100cm | zij-uitloop 35mm | EDFTZ100035 | stuk | 311,00 | 369 | 1 |
| Utiliteit | 2301590 | 9.8x110cm | zij-uitloop 35mm | EDFTZ110035 | stuk | 318,00 | 369 | 1 |
| | 2301591 | 9.8x120cm | zij-uitloop 35mm | EDFTZ120035 | stuk | 321,00 | 369 | 1 |
| | 2301592 | 9.8x50cm | zij-uitloop 50mm | EDFTZ50050 | stuk | 268,00 | 369 | 1 |
| | 2301593 | 9.8x60cm | zij-uitloop 50mm | EDFTZ60050 | stuk | 274,00 | 369 | 1 |
| | 2301594 | 9.8x70cm | zij-uitloop 50mm | EDFTZ70050 | stuk | 284,00 | 369 | 1 |
| | 2301595 | 9.8x80cm | zij-uitloop 50mm | EDFTZ80050 | stuk | 284,00 | 369 | 1 |
| | 2301596 | 9.8x90cm | zij-uitloop 50mm | EDFTZ90050 | stuk | 306,00 | 369 | 1 |
| | 2301597 | 9.8x100cm | zij-uitloop 50mm | EDFTZ100050 | stuk | 311,00 | 369 | 1 |
| | 2301598 | 9.8x110cm | zij-uitloop 50mm | EDFTZ110050 | stuk | 318,00 | 369 | 1 |
| | 2301599 | 9.8x120cm | zij-uitloop 50mm | EDFTZ120050 | stuk | 321,00 | 369 | 1 |

Easy Drain Trapezium Class

RVS afvoergoot enkele plaat m. sifon

| | | | | | | | | |
|--|---------|-----------|--|-----------|------|--------|-----|---|
| | 2301001 | 7x30x44cm | | EDTRAP300 | stuk | 269,00 | 369 | 0 |
| | 2301002 | 7x70x84cm | | EDTRAP700 | stuk | 289,00 | 369 | 1 |

Easy Drain Delta Class

RVS afvoergoot driehoekig

| | | | | | | | | |
|--|---------|------|----------------|------|------|--------|-----|---|
| | 2301059 | 24cm | m. Viega sifon | EDDE | stuk | 269,00 | 369 | 1 |
|--|---------|------|----------------|------|------|--------|-----|---|

| Art.nr | Specificaties | Kleur | Lev.nr | Ehd | Prijs | Grp | CC |
|----------------------------------|--|-------|-----------|------|--------|-----|----|
| Easy Drain Round Class | | | | | | | |
| RVS afvoergoot m. sifon | | | | | | | |
| 2301282 | radius 55 | | EDROUND55 | stuk | 499,00 | 369 | 1 |
| Easy Drain Delta Fixt | | | | | | | |
| RVS afvoergoot driehoekig | | | | | | | |
| 2301600 | 24cm m. zijuitlaat 3cm | | EDFTDE30 | stuk | 269,00 | 369 | 1 |
| 2301060 | 24cm m. zijuitlaat 3.5cm | | EDFTDE35 | stuk | 269,00 | 369 | 1 |
| 2301061 | 24cm m. zijuitlaat 5cm | | EDFTDE50 | stuk | 269,00 | 369 | 1 |
| 2301062 | 24cm m. onderuitlaat | | EDFTDE500 | stuk | 269,00 | 369 | 1 |
| Easy Drain toebehoren | | | | | | | |
| 2301380 | Easy2Fix montageset voor Classic 500-600-700-delta-trap300 90x25cm | | E2F-CL-9 | stuk | 35,00 | 369 | 0 |
| 2301381 | Easy2Fix montageset voor Classic 785-800-885-900-trap700 110x25cm | | E2F-CL-11 | stuk | 35,00 | 369 | 0 |
| 2301382 | Easy2Fix montageset voor Classic 140x25cm model 1000-1100-1200 | | E2F-CL-14 | stuk | 35,00 | 369 | 0 |
| 2301383 | Easy2Fix montageset voor Fixt 90x33cm 500-600-700-delta-trap300- | | E2F-FT-9 | stuk | 37,70 | 369 | 0 |
| 2301384 | Easy2Fix montageset voor Fixt 110x33cm 785-800-885-900 | | E2F-FT-11 | stuk | 37,70 | 369 | 0 |
| 2301385 | Easy2Fix montageset voor Fixt 140x33cm model 1000-1100-1200 | | E2F-FT-14 | stuk | 37,70 | 369 | 0 |
| 2301386 | Easy2Seal set=pasta+schuurpapier+spachtel | | E2S | stuk | 17,50 | 369 | 0 |

Sanitair producten

Baden /
douchebakken /
stoomcabines

Kranen

Douchegarnituur

Accessoires en
spiegels

Douchewanden

**Toebehoren &
afvoeren**

Spoel- &
installatiesystemen

Badkamermeubelen
en toiletkasten

Gootstenen en
wastroggen

Utiliteit

VAN DEN BERG

afvoerprogramma *Sign*

RVS doucheputten

- lage inbouw
- hoge afvoercapaciteit
- hoogglans gepolijst oppervlak
- verlijmbare aansluitadapter
- ook met vastzetbaar rooster en- of flens



RVS rechte douchegoten

- lengten van 300 tot 1000 mm, oplopend per 100 mm
- uitneembaar kunststof waterslot van 50 mm
- onder- zijuitlaat Ø 50 mm, voorzien van EPDM mancheting
- inbouwhoogte 92 mm
- afvoercapaciteit 35 liter per minuut
- rondom lekkageflens

Kwartronde RVS douchegoten

- zijuitlaat Ø 50 mm, voorzien van EPDM mancheting
- afvoercapaciteit 25 liter per minuut
- afmetingen 800 - 900 en 1000 mm

Tegelput- goten

- een fraai geheel met tegelvloer
- waterafvoer langs put- gootrand, dus geen rooster zichtbaar
- leverbaar in diverse afmetingen
- zijuitlaat van Ø 50 mm
- afvoercapaciteit 25 liter per minuut.

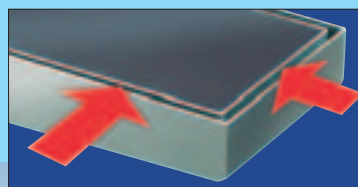
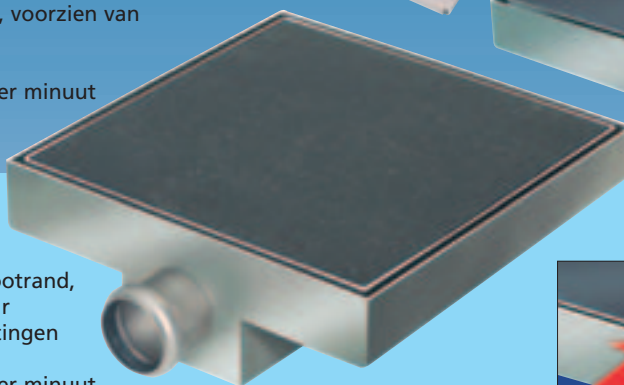

Waterafvoer langs put- gootrand, dus geen rooster zichtbaar in tegelvloer

RVS doucheplaat met ingebouwde afvoer

- aflopende bodem begint bij een hoogte van 40 mm
- sifongedeelte (met ontstopping)
- rooster uit twee delen, voorzien van *Sign* oppervlak
- stelschroeven voor het makkelijk plaatsen
- standaard met Ø 50 mm zijuitlaat
- waterdichte overgang d.m.v. integelranden
- leverbaar in de afm. 800x800 - 900x900 en 1000x1000 mm.

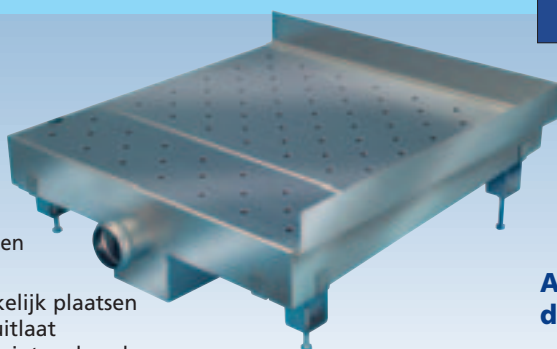

ABS kunststof - douchegoten met RVS roosters

- standaard breedte van 100 mm
- lengten van 300-400-500-600-700-800-900 en 1000 mm



VAN DEN BERG
AFVOERPUTTEN BV

Koperstraat 19 • 8211 AK Lelystad
Postbus 74 • 8200 AB Lelystad • Fax: 0320-24 40 39 • Tel: 0320-22 61 57
Internet: www.vandenbergafoerputten.nl
E-mail: info@vandenbergafoerputten.nl

| Art.nr | Specificaties | Kleur | Lev.nr | Ehd | Prijs | Grp | CC |
|--------|---------------|-------|--------|-----|-------|-----|----|
|--------|---------------|-------|--------|-----|-------|-----|----|

v.d. Berg douchegoten

RVS standaard douchegoot

| | | | | | | | |
|---------|-------|-----------------|----------|------|--------|-----|---|
| 2300315 | 50cm | m. onderuitloop | ST500OU | stuk | 225,00 | 369 | 1 |
| 2300316 | 50cm | m. zijuitloop | ST500ZU | stuk | 225,00 | 369 | 1 |
| 2300317 | 60cm | m. onderuitloop | ST600OU | stuk | 235,00 | 369 | 1 |
| 2300318 | 60cm | m. zijuitloop | ST600ZU | stuk | 235,00 | 369 | 1 |
| 2300319 | 70cm | m. onderuitloop | ST700OU | stuk | 245,00 | 369 | 1 |
| 2300320 | 70cm | m. zijuitloop | ST700ZU | stuk | 245,00 | 369 | 1 |
| 2300321 | 80cm | m. onderuitloop | ST800OU | stuk | 255,00 | 369 | 1 |
| 2300322 | 80cm | m. zijuitloop | ST800ZU | stuk | 255,00 | 369 | 1 |
| 2300323 | 90cm | m. onderuitloop | ST900OU | stuk | 264,00 | 369 | 1 |
| 2300324 | 90cm | m. zijuitloop | ST900ZU | stuk | 264,00 | 369 | 1 |
| 2300325 | 100cm | m. onderuitloop | ST1000OU | stuk | 274,00 | 369 | 1 |
| 2300326 | 100cm | m. zijuitloop | ST1000ZU | stuk | 274,00 | 369 | 1 |

Sanitair producten

Baden /
douchebakken /
stoomcabines

Kranen

RVS U-douchegoot

| | | | | | | | |
|---------|-------|-----------------|---------|------|--------|-----|---|
| 2300327 | 60cm | m. onderuitloop | U600OU | stuk | 245,00 | 369 | 1 |
| 2300328 | 60cm | m. zijuitloop | U600ZU | stuk | 245,00 | 369 | 1 |
| 2300329 | 70cm | m. onderuitloop | U700OU | stuk | 255,00 | 369 | 1 |
| 2300330 | 70cm | m. zijuitloop | U700ZU | stuk | 255,00 | 369 | 1 |
| 2300331 | 80cm | m. onderuitloop | U800OU | stuk | 264,00 | 369 | 1 |
| 2300332 | 80cm | m. zijuitloop | U800ZU | stuk | 264,00 | 369 | 1 |
| 2300333 | 90cm | m. onderuitloop | U900OU | stuk | 274,00 | 369 | 1 |
| 2300334 | 90cm | m. zijuitloop | U900ZU | stuk | 274,00 | 369 | 1 |
| 2300335 | 100cm | m. onderuitloop | U1000OU | stuk | 284,00 | 369 | 1 |
| 2300336 | 100cm | m. zijuitloop | U1000ZU | stuk | 284,00 | 369 | 1 |

Douchegarnituur

Accessoires en
spiegels

Douchewanden

v.d. Berg tegelgoten

RVS tegelgoot m. ingebouwde afvoer

| | | | | | | | |
|---------|-----------|--|-----------|------|--------|-----|---|
| 2300067 | 81.5x20cm | | 815200ZU | stuk | 432,00 | 369 | 1 |
| 2300068 | 91x30cm | | 910300ZU | stuk | 432,00 | 369 | 1 |
| 2300069 | 102x20cm | | 1020200ZU | stuk | 471,00 | 369 | 1 |

Toebehoren &
afvoeren

v.d. Berg design doucheputten

RVS vloerput zij- en onderuitlaat 40mm

| | | | | | | | |
|---------|----------|---------------------------|-------|------|-------|-----|---|
| 2300306 | 10x10 cm | | 2910 | stuk | 26,00 | 433 | 0 |
| 2300307 | 10x10 cm | m. vastgeschroefd rooster | 2910V | stuk | 36,75 | 433 | 1 |

Spoel- &
installatiesystemen

RVS vloerput zij- en onderuitlaat 50mm

| | | | | | | | |
|---------|----------|---------------------------|-------|------|-------|-----|---|
| 2300308 | 15x15 cm | | 2915 | stuk | 34,00 | 433 | 0 |
| 2300309 | 20x20 cm | m. vastgeschroefd rooster | 2920V | stuk | 71,00 | 433 | 1 |

Badkamermeubelen
en toiletkasten

v.d. Berg exclusieve doucheputten

RVS vloerput met onderuitlaat zonder emmer

| | | | | | | | |
|---------|----------|--|-------|------|--------|-----|---|
| 2300305 | 15x15 cm | | 15075 | stuk | 104,00 | 433 | 1 |
|---------|----------|--|-------|------|--------|-----|---|

Gootstenen en
wastroggen

RVS vloerput met zijuitlaat zonder emmer

| | | | | | | | |
|---------|----------|--|-------|------|--------|-----|---|
| 2300710 | 15x15 cm | | 11075 | stuk | 104,00 | 433 | 1 |
| 2300524 | 15x15 cm | | 11050 | stuk | 111,00 | 433 | 1 |

Utiliteit

v.d. Berg tegelputten

RVS tegelput m. ingebouwde afvoer

| | | | | | | | |
|---------|---------|--|---------|------|--------|-----|---|
| 2300062 | 10x10cm | | TG100ZU | stuk | 265,00 | 369 | 1 |
| 2300063 | 15x15cm | | TG150ZU | stuk | 275,00 | 369 | 1 |
| 2300064 | 20x20cm | | TG200ZU | stuk | 285,00 | 369 | 1 |
| 2300065 | 30x30cm | | TG300ZU | stuk | 295,00 | 369 | 1 |
| 2300066 | 45x45cm | | TG450ZU | stuk | 305,00 | 369 | 1 |



| | Art.nr | Specificaties | Kleur | Lev.nr | Ehd | Prijs | Grp | CC | |
|--|--|------------------------|----------------------------|----------|------|--------|-----|----|--|
| Douchebakdragers en -poten Illbruck | | | | | | | | | |
| douchebakdrager Expert | | | | | | | | | |
| Sanitair producten | 0340356 | 80x80x6.5cm | Bette | 17029883 | stuk | 136,00 | 082 | 1 | |
| | 0340354 | 90x80x6.5cm | Bette | 17029850 | stuk | 136,00 | 082 | 1 | |
| | 0360008 | 90x80x15cm | Bette | 17029594 | stuk | 121,00 | 082 | 1 | |
| Baden / douchebakken / stoomcabines | 0340358 | 90x90x3.5cm | Bette | 17029979 | stuk | 145,00 | 082 | 1 | |
| | 0340355 | 90x90x6.5cm | Bette | 17029855 | stuk | 136,00 | 082 | 1 | |
| | 0340350 | 100x80x15cm | Bette | 17029543 | stuk | 159,00 | 082 | 1 | |
| | 0340363 | 100x90x6.5 | Bette | 17030811 | stuk | 175,00 | 082 | 1 | |
| | 0340364 | 120x90x15 | Bette | 17031028 | stuk | 184,00 | 082 | 1 | |
| Kranen | 0340365 | 120x100x6.5 | Bette | 17031433 | stuk | 208,00 | 082 | 1 | |
| | douchebakdrager Profi | | | | | | | | |
| | 0340347 | 80x75x15cm | Bette | 17029478 | stuk | 81,00 | 082 | 1 | |
| Douchegarnituur | 0340344 | 80x80x15cm | Bette | 17029467 | stuk | 69,00 | 082 | 1 | |
| | 0340348 | 90x75x15cm | Bette | 17029479 | stuk | 81,00 | 082 | 1 | |
| | 0340346 | 90x90x15cm | Kaldewei / Bette / Plieger | 17029468 | stuk | 75,00 | 082 | 1 | |
| | 0340349 | 90x90x28cm | Bette | 17029482 | stuk | 94,00 | 082 | 1 | |
| | douchebakdrager Prosan | | | | | | | | |
| Accessoires en spiegels | 0341851 | 80x75x15cm | Bette / Kaldewei | 17029646 | stuk | 61,00 | 082 | 1 | |
| | 0360368 | 90x75x15cm | Bette / Kaldewei | 17029644 | stuk | 55,00 | 082 | 1 | |
| douchebakdrager Expert | | | | | | | | | |
| Douchewanden | 0340370 | Duscholux Ancona 627 | | 17030278 | stuk | 175,00 | 082 | 1 | |
| | 0340371 | Duscholux Ancona 831 | | 17031756 | stuk | 136,00 | 082 | 1 | |
| | 0340361 | Duscholux BlueLine 22 | | 17030032 | stuk | 127,00 | 082 | 1 | |
| | 0340264 | Duscholux Smartline 36 | | 17036850 | stuk | 132,00 | 082 | 1 | |
| | 0360157 | 90x90x15cm | Hoesch Temucu | 17029683 | stuk | 127,00 | 082 | 1 | |
| | 0340360 | 90x90x6.5cm | Kaldewei Duschplan | 17030003 | stuk | 124,00 | 082 | 1 | |
| douchebakdrager | | | | | | | | | |
| Toebehoren & afvoeren | 0341908 | 90x90cm | Plieger Liberty vierkant | 17034356 | stuk | 152,00 | 082 | 1 | |
| | 0341926 | 100x100cm | Plieger Liberty vierkant | 17037773 | stuk | 135,00 | 082 | 1 | |
| | 0341886 | 90x90cm | Plieger Liberty kwartrond | 17034354 | stuk | 152,00 | 082 | 1 | |
| | 0341925 | 100x100cm | Plieger Liberty kwartrond | 17037772 | stuk | 153,00 | 082 | 1 | |
| | 0341894 | 90x90cm | Plieger Liberty vijfhoekig | 17034355 | stuk | 152,00 | 082 | 1 | |
| | 0341927 | 100x100cm | Plieger Liberty vijfhoekig | 17037774 | stuk | 153,00 | 082 | 1 | |
| | 0341878 | 90x90x6.5cm | Plieger Spring | 17033314 | stuk | 128,00 | 082 | 1 | |
| | douchebakdrager Expert | | | | | | | | |
| Badkamermeubelen en toiletkasten | 0340414 | 90x90x16cm | Riho 202 | 17034273 | stuk | 144,00 | 082 | 1 | |
| | 0340417 | 90x90x4.5cm | Riho 212 | 17034286 | stuk | 180,00 | 082 | 1 | |
| | 0340418 | 100x100x4.5 | Riho 214 | 17034287 | stuk | 216,00 | 082 | 1 | |
| | 0340436 | 90x90x6cm | Ucosan Denia | 17034998 | stuk | 136,00 | 082 | 1 | |
| Gootstenen en wastroggen | 0340437 | 100x80x6cm | Ucosan Denia | 17035001 | stuk | 161,00 | 082 | 1 | |
| | 0340438 | 120x90x6cm | Ucosan Denia | 17035002 | stuk | 177,00 | 082 | 1 | |
| | 0340386 | 80x80x6cm | Villeroy & Boch Futurion | 17033324 | stuk | 136,00 | 082 | 1 | |
| | 0340390 | 90x80x6cm | Villeroy & Boch Futurion | 17033328 | stuk | 136,00 | 082 | 1 | |
| | 0340387 | 90x90x6cm | Villeroy & Boch Futurion | 17033325 | stuk | 136,00 | 082 | 1 | |
| Utiliteit | 0340389 | 100x100x6 | Villeroy & Boch Futurion | 17033326 | stuk | 193,00 | 082 | 1 | |
| | 0340391 | 120x90x6cm | Villeroy & Boch Futurion | 17033329 | stuk | 193,00 | 082 | 1 | |
| | 0340384 | 90x90x6cm | Villeroy & Boch Geos | 17032411 | stuk | 151,00 | 082 | 1 | |
| | 0340392 | 90x90x6cm | Villeroy & Boch Geos | 17033338 | stuk | 136,00 | 082 | 1 | |
| | 0340385 | 100x100x6 | Villeroy & Boch Geos | 17032414 | stuk | 193,00 | 082 | 1 | |
| | 0340383 | 80x80x15cm | Villeroy & Boch Sensis | 17031177 | stuk | 127,00 | 082 | 1 | |
| | 0340381 | 90x90x10cm | Villeroy & Boch Sensis | 17030576 | stuk | 136,00 | 082 | 1 | |
| | 0340380 | 90x90x15cm | Villeroy & Boch Sensis | 17030365 | stuk | 127,00 | 082 | 1 | |
| | 0340382 | 120x100x15 | Villeroy & Boch Tunis | 17030666 | stuk | 224,00 | 082 | 1 | |
| | 2-componenten montageschuim 400ml | | | | | | | | |
| | 0342351 | | | 18200094 | stuk | 19,00 | 082 | 0 | |
| Douchebakdragers en -poten Mepa | | | | | | | | | |
| douchebaksteun m. 5 verstelbare poten 125-180mm | | | | | | | | | |
| | 0364580 | | | 150150 | stuk | 19,00 | 062 | 0 | |
| douchebaksteun m. 5 verstelbare poten 85-105mm m. ADS geluidsisolatie | | | | | | | | | |
| | 0361755 | | | 150140 | stuk | 46,25 | 062 | 0 | |
| Douchebakdragers en -poten Plieger | | | | | | | | | |
| douchebakdrager | | | | | | | | | |
| | 0360155 | 80x80x15cm | voor Bette en Kaldewei | 0360155 | stuk | 42,00 | 082 | 1 | |
| | 0360147 | 90x90x15cm | voor Bette en Kaldewei | 0360147 | stuk | 45,00 | 082 | 1 | |

| Art.nr | Specificaties | Kleur | Lev.nr | Ehd | Prijs | Grp | CC |
|---|---------------|-------|--------------|------|-------|-----|----|
| Douchebakdragers en -poten Plieger | | | | | | | |
| douchebaksteun m. 3 verstelbare poten 125-195mm 0360309 | | | 3SGS | stuk | 12,25 | 062 | 0 |
| douchebaksteun m. 5 verstelbare poten 125-195mm 0360635 | | | 5SGS | stuk | 33,00 | 062 | 0 |
| douchebaksteun m. 5 verstelbare poten 87-115mm 0360618 | | | R 5 SGS MINI | stuk | 33,00 | 062 | 0 |
| douchebaksteun m. 3 verstelbare poten in doos 0360012 | | | R3LIGHT | stuk | 8,90 | 082 | 0 |

Sanitair producten

Baden /
douchebakken /
stoomcabines

Kranen

Doucheapparatuur

Accessoires en
spiegels

Douchewanden

**Toebehoren &
afvoeren**

Spoel- &
installatiesystemen

Badkamermeubelen
en toiletkasten

Gootstenen en
wastroggen

Utiliteit

| | Art.nr | Specificaties | Kleur | Lev.nr | Ehd | Prijs | Grp | CC |
|---|---|---|--------------|------------|------|-------|-----|----|
| | Valpijp Plieger | | | | | | | |
| | Valpijp kunststof z. bocht 90 | | | | | | | |
| Sanitair producten | 0730513 | sprong 65 m. kraag voor Abu | | 0730513 | stuk | 3,26 | 353 | 0 |
| | 0730521 | sprong 65 z. kraag voor Geberit | | 0730521 | stuk | 3,14 | 353 | 0 |
| | 0730548 | sprong 105 m. kraag voor Rezi | | 0730548 | stuk | 3,35 | 353 | 0 |
| | 0730599 | sprong 120 m. kraag voor Royal | | 0730599 | stuk | 3,44 | 353 | 0 |
| Baden / douchebakken / stoomcabines | 0730602 | m. kraag extra lang | | 0730602 | stuk | 3,69 | 353 | 0 |
| | Valpijp voor 3-delig z. bochten 90+45 | | | | | | | |
| | 0730610 | | | 0730610 | stuk | 5,30 | 353 | 0 |
| | Valpijpverbinders Mulet | | | | | | | |
| | valpijpverbinding | | | | | | | |
| Kranen | 0730467 | 32x48mm | m. chr rozet | 113611014 | stuk | 2,53 | 353 | 0 |
| | 0730475 | 32x48mm | zwart | 113610014 | stuk | 1,41 | 353 | 0 |
| | 0730564 | 32x55mm | m. chr rozet | 114621012 | stuk | 2,53 | 353 | 0 |
| Douchegarnituur | 0730483 | 32x55mm | zwart | 114620012 | stuk | 1,28 | 353 | 0 |
| | 0730114 | 44x48mm | wit | 113662020 | stuk | 3,23 | 353 | 0 |
| | 0730254 | 44x55mm | m. chr rozet | 115951010 | stuk | 3,07 | 353 | 0 |
| | 0730262 | 44x55mm | zwart | 115950010 | stuk | 2,20 | 353 | 0 |
| | Valpijpverbinders NKS | | | | | | | |
| | valpijpverbinder voor laaghangend reservoir | | | | | | | |
| Accessoires en spiegels | 0770671 | NKS-101 | | 8050985530 | stuk | 2,64 | 353 | 0 |
| | valpijpverbinder voor hooghangend reservoir | | | | | | | |
| Douchewanden | 0770698 | NKS-102 | | 7023120850 | stuk | 0,88 | 353 | 0 |
| | Valpijpsok de Beer | | | | | | | |
| | valpijpsok 1" | | | | | | | |
| Toebehoren & afvoeren | 0730416 | para-rubber | | 110060010 | stuk | 2,08 | 353 | 0 |
| | 0730445 | haaks model rubber | wit | 1100800010 | stuk | 2,11 | 353 | 0 |
| | Valpijpbocht Plieger | | | | | | | |
| | valpijpbocht kunststof universeel voor laaghangende reservoirs | | | | | | | |
| Spool- & installatiesystemen | 0710016 | | wit | 0710016 | stuk | 4,82 | 353 | 0 |
| | 0710726 | | pergamon | 0710726 | stuk | 6,04 | 353 | 1 |
| | 0710032 | | beige | 0710032 | stuk | 6,40 | 353 | 1 |
| | valpijpbocht plastic | | | | | | | |
| Badkamermeubelen en toiletkasten | 0730084 | 90° | | 0730084 | stuk | 1,74 | 353 | 0 |
| | 0730076 | 45° | | 0730076 | stuk | 1,80 | 353 | 0 |
| | Valpijpbeugels de Beer | | | | | | | |
| | valpijpbeugel | | | | | | | |
| Gootstenen en wastroggen | 0730327 | plastic per stuk | z. dop | 311110050 | stuk | 0,19 | 353 | 0 |
| | 0730335 | plastic per stuk | m. dop | 311120050 | stuk | 0,21 | 353 | 0 |
| | valpijpbeugels | | | | | | | |
| Utiliteit | 0730319 | plastic per paar | | 311100050 | paar | 0,40 | 353 | 0 |
| | valpijpbeugel | | | | | | | |
| | 0730351 | z. dop per stuk | chrom | 311010010 | stuk | 0,98 | 353 | 1 |
| | 0730378 | m. dop per stuk | chrom | 311020010 | stuk | 1,39 | 353 | 1 |
| | klemvalpijpbeugel | | | | | | | |
| | 0730386 | m. dop per stuk | chrom | 311090030 | stuk | 1,39 | 353 | 0 |
| | Reservoir Onderdelen de Beer | | | | | | | |
| | 0770159 | closettrekker m. nylon koord wit | | F.PLIE26 | stuk | 1,62 | 353 | 0 |
| | 0770183 | closettrekker m. kogelketting wit | | F.PLIE34 | stuk | 2,26 | 353 | 0 |
| | 0710709 | rubberbal voor drukknoopinrichting Ø57mm | | 123710025 | stuk | 2,80 | 353 | 0 |
| | 0712221 | rubberbal voor drukknoopinrichting Ø57mm verhoogd model | | 123730025 | stuk | 2,95 | 353 | 0 |
| | 0710717 | rubberbal voor drukknoopinrichting Ø60mm | | 123720025 | stuk | 2,80 | 353 | 0 |
| | 0770086 | flotteurkraandop rubber 9x4.5mm | | 145090100 | stuk | 0,13 | 353 | 1 |
| | 0202215 | kogelstang voor uitstroomechisme nr. 4-5-7-9-11 | | 12205001 | stuk | 3,00 | 043 | 0 |
| | 0202894 | rubber bal nr. 4-5-7-9-11 | | 122060025 | stuk | 6,08 | 043 | 0 |
| | Reservoir Onderdelen Fluidmaster | | | | | | | |
| | 0711543 | flotteurkraan m. onderaansluiting universeel | | 400E | stuk | 15,75 | 043 | 0 |
| | 0711594 | flotteurkraan m. zij aansluiting universeel | | 747E | stuk | 15,75 | 043 | 0 |

| Art.nr | Specificaties | Kleur | Lev.nr | Ehd | Prijs | Grp | CC |
|------------------------------------|---|-------|-----------|------|--------|-----|----|
| Reservoir Onderdelen Sphinx | | | | | | | |
| 0201189 | flotteurkraan 60K1 voor reservoir P/PX | | S8H920000 | stuk | 51,00 | 043 | 0 |
| 0202908 | flotteurkraan nr.85 compleet | | S8H716001 | stuk | 51,00 | 043 | 0 |
| 0201190 | vlotterkraan S1 | | S8H888000 | stuk | 52,00 | 043 | 1 |
| 0201191 | vlotterkraan S2 | | S8H900012 | stuk | 52,00 | 043 | 1 |
| 0201192 | vlotterkraan S3 | | S8H922000 | stuk | 52,00 | 043 | 1 |
| 0201146 | uitstroommechanisme nr.4 | | S8H703000 | stuk | 48,50 | 043 | 0 |
| 0201154 | uitstroommechanisme nr.5 | | S8H704000 | stuk | 48,50 | 043 | 0 |
| 0200808 | uitstroommechanisme m. trekknop nr.13 | | S8H705000 | stuk | 48,50 | 043 | 1 |
| 0200840 | uitstroommechanisme m. drukknop m. spoelonderbreker nr. 14S | | S8H706000 | stuk | 48,50 | 043 | 0 |
| 0221036 | uitstroommechanisme 18S (59/215 kort) m. spoelonderbr. | | S8H741000 | stuk | 48,50 | 043 | 0 |
| 0200809 | uitstroommechanisme DF1 | | S8H881000 | stuk | 52,00 | 043 | 1 |
| 0200810 | uitstroommechanisme DF2 | | S8H889000 | stuk | 52,00 | 043 | 1 |
| 0200811 | uitstroommechanisme DF3 | | S8H825000 | stuk | 52,00 | 043 | 1 |
| 0200812 | uitstroommechanisme DF4 | | S8H900011 | stuk | 52,00 | 043 | 1 |
| 0200813 | uitstroommechanisme DF5 | | S8H900000 | stuk | 52,00 | 043 | 1 |
| 0201368 | zittingring + 25cm butylband | | S8H727000 | stuk | 7,90 | 043 | 1 |
| 0201367 | afdichtingsprofiel voor mechanisme 4-12-13-14-16 | | S8H728000 | stuk | 12,50 | 043 | 0 |
| 0202789 | afdichtingsprofiel voor Eurobase | | S8H842001 | stuk | 6,80 | 043 | 0 |
| 0200018 | bodemklep voor uitstroommechanisme 12-13-14-16 | | S8H710000 | stuk | 5,70 | 043 | 0 |
| 0202541 | overlooppijp voor uitstroommechanisme 200mm nr.7 | | S8H730000 | stuk | 10,25 | 043 | 1 |
| 0201421 | overlooppijp voor uitstroommechanisme 228mm nr.4 | | S8H731000 | stuk | 10,25 | 043 | 0 |
| 0202533 | overlooppijp voor uitstroommechanisme 242mm nr.5-9 | | S8H732000 | stuk | 11,25 | 043 | 1 |
| 0239876 | bevestigingsbouten M8x68.5 | | S8H733000 | stuk | 5,70 | 043 | 0 |
| Reservoir Onderdelen Venlo | | | | | | | |
| 0201065 | drukknopdoos Royal voor drukreservoir chroom | | H6320001 | stuk | 51,00 | 210 | 0 |
| 0201073 | stijgbuis Royal voor drukknopdoos drukreservoir chroom | | H1060969 | stuk | 27,25 | 210 | 1 |
| Reservoir Onderdelen VSH | | | | | | | |
| 0770574 | V2410 messing flotteurkraan kort m. stang z. bal z. pijpje | | 0493625 | stuk | 12,50 | 353 | 0 |
| 0770353 | V2410 messing flotteurkraan kort m. bal m. pijpje | | 0493570 | stuk | 22,75 | 353 | 1 |
| 0770043 | flotteurbal 2425 plastic | | 0493834 | stuk | 2,94 | 353 | 0 |
| 0770078 | flotteurvulpijpje 2425 plastic | | 0493845 | stuk | 1,01 | 353 | 0 |
| 0770388 | W2910 watermeterbeugel m. koppeling 3/4"x3/4" | | 1434961 | stuk | 68,50 | 353 | 1 |
| 0770396 | W2911 watermeterbeugel m. koppeling 1"x1" | | 1434972 | stuk | 104,00 | 353 | 1 |

Sanitair producten

Baden /
douchebakken /
stoomcabines

Kranen

Douchegarnituur

Accessoires en
spiegels

Douchewanden





Toebehoren &
afvoeren

Spoel- &
installatiesystemen

Badkamermeubelen
en toiletkasten

Gootstenen en
wastroggen

Utiliteit

| | Art.nr | Specificaties | Kleur | Lev.nr | Ehd | Prijs | Grp | CC | |
|---|---|---------------------------------|-------------------------|------------|------------|-------|-------|-----|---|
| | Bevestigingen | | | | | | | | |
| Sanitair producten | set potschroeven m. kap m. rozet | | | | | | | | |
| | 0830275 | 6x60mm | wit/messing | 0830275 | stuk | 0,61 | 362 | 0 | |
| | 0830429 | 6x60mm | wit/RVS | 0830429 | stuk | 1,18 | 362 | 0 | |
| | 0830259 | 6x70mm | wit/messing | 0830259 | stuk | 0,97 | 362 | 0 | |
| Baden / douchebakken / stoomcabines | set potschroeven | | | | | | | | |
| | 0830453 | 5.5x60mm | chrom | 0830453 | stuk | 2,28 | 362 | 0 | |
| | 0830410 | 5.5x60mm | wit | 0830410 | stuk | 0,84 | 362 | 0 | |
| | 0830143 | 5.5x60mm | pergamon | 0830143 | stuk | 1,10 | 362 | 0 | |
| | 0830461 | 5.5x70mm | wit | 0830461 | stuk | 0,82 | 362 | 0 | |
| Kranen | set 2-potschroeven lenskop m. rozet | | | | | | | | |
| | 0830356 | 5.5x50mm | nikkel | 0830356 | stuk | 0,90 | 362 | 0 | |
| Douchegarnituur | Haro secur-strip | | | | | | | | |
| | 0771996 | per 50cm | wit | 111010030 | stuk | 2,06 | 353 | 0 | |
| | Bevestigingen Viega | | | | | | | | |
| Accessoires en spiegels | set sierdoppen voor wandduoblok | | | | | | | | |
| | 0830062 | | chrom | 107505 | stuk | 4,22 | 350 | 0 | |
| | Bevestigingssets Duravit | | | | | | | | |
| Douchewanden | vario aansluitset verstelbaar 7-18cm | | | | | | | | |
| | 0293709 | | | 0014220000 | stuk | 46,00 | 016 | 0 | |
| | vario aansluitset verstelbaar 20.5-24.5cm | | | | | | | | |
| | 0290058 | | | 8990250006 | stuk | 44,00 | 016 | 0 | |
| Toebehoren & afvoeren | bevestigingsset | | | | | | | | |
| |  | 0299858 | v. wandbidet / -closet | chrom | 0065001000 | stuk | 14,00 | 017 | 0 |
| | | 0299853 | v. bidet/urinoir/closet | chrom | 0067011000 | stuk | 5,00 | 017 | 0 |
| Spoel- & installatiesystemen |  | | | | | | | | |
| | | geluiddempingset | | | | | | | |
| Badkamermeubelen en toiletkasten | 0295560 | | | 0050200000 | stuk | 31,00 | 016 | 0 | |
| | | Bevestigingssets Keramag | | | | | | | |
| Gootstenen en wastroggen | montageset v. wateraansluiting achter | | | | | | | | |
| | 0080610 | | | 522065000 | stuk | 19,00 | 034 | 1 | |
| | vloerbevestiging Kerafix | | | | | | | | |
| | 0083208 | voor bidet/duoblok | | 551060000 | stuk | 33,00 | 034 | 1 | |
| Utiliteit | Bevestigingssets Viega | | | | | | | | |
| | aansluitgarnituur | | | | | | | | |
| | 0770868 | voor wandduoblok | | 263812 | stuk | 15,50 | 353 | 1 | |
| | Isolatieset | | | | | | | | |
| | isolatieset | | | | | | | | |
| | 0711330 | voor wandcloset | | 0711330 | stuk | 9,50 | 328 | 0 | |
| | Closetafvoeren ABU | | | | | | | | |
|  | closetaansluiting recht | | | | | | | | |
| | 0771058 | 110x150mm | wit | 750101 | stuk | 3,52 | 353 | 1 | |
| | 0771066 | 110x250mm | wit | 750201 | stuk | 3,63 | 353 | 0 | |
| | 0771074 | 110x400mm | wit | 750301 | stuk | 5,40 | 353 | 0 | |
| | 0770132 | 110x400mm | camee | 750305 | stuk | 6,70 | 353 | 0 | |
|  | closetaansluiting | | | | | | | | |
| | 0771848 | 110x400mm m. aansluiting 40/50 | wit | 750501 | stuk | 19,00 | 353 | 1 | |

Art.nr Specificaties Kleur Lev.nr Ehd Prijs Grp CC

Closetafvoeren ABU

| | | | | | | | |
|--------------------------|-----|----------------------|-------|--------|------|-------|-------|
| closetbocht 110mm | | | | | | | |
| 0770272 | 90° | | wit | 752201 | stuk | 3,15 | 353 0 |
| 0770167 | 90° | | camee | 752205 | stuk | 4,52 | 353 0 |
| 0770299 | 90° | | beige | 752203 | stuk | 4,53 | 353 0 |
| 0770345 | 45° | | wit | 752101 | stuk | 3,63 | 353 0 |
| 0770663 | 90° | m. aansluiting 40/50 | wit | 752401 | stuk | 17,50 | 353 0 |



Sanitair producten

Baden /
douchebakken /
stoomcabines

Kranen

Douchegarnituur

Accessoires en
spiegels

Douchewanden

Toebehoren &
afvoeren

Spoel- &
installatiesystemen

Badkamermeubelen
en toiletkasten

Gootstenen en
wastroggen

Utiliteit

rozet klik

| | | | | | | | |
|---------|--|--|----------|--------|------|------|-------|
| 0770973 | | | wit | 754101 | stuk | 2,68 | 353 0 |
| 0770975 | | | pergamon | 754105 | stuk | 3,47 | 353 1 |



Closetafvoeren de Beer

| | | | | | | | |
|-----------------------------|-------------------------|--|-----|-----------|------|------|-------|
| kunststof potmanchet | | | | | | | |
| 0770205 | sprong 40mm excentrisch | | wit | 110232001 | stuk | 3,91 | 353 0 |

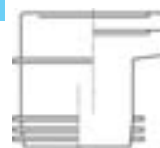

Closetafvoeren Keramag

| | | | | | | | |
|--|-------------|--|--|-----------|------|-------|-------|
| afvoerset voor closetcombinatie | | | | | | | |
| 0082171 | multi AO | | | 521170000 | stuk | 74,00 | 034 1 |
| 0082821 | multi SV/PK | | | 521180000 | stuk | 64,00 | 034 1 |

Closetafvoeren NKS

| | | | | | | | |
|--------------------------------------|-------|-----------|----------|------------|------|------|-------|
| kunststof potmanchet NKS nr.2 | | | | | | | |
| 0771180 | | | wit | 7000120210 | stuk | 6,10 | 353 1 |
| kunststof potmanchet | | | | | | | |
| 0771163 | nr. 3 | 100-110mm | wit | 7000119926 | stuk | 6,10 | 353 0 |
| 0770175 | nr. 3 | 100-110mm | pergamon | 7000119927 | stuk | 6,10 | 353 0 |
| 0770256 | nr. 4 | 120x125mm | wit | 7000120201 | stuk | 6,10 | 353 0 |
| kunststof potmanchet NKS nr.6 | | | | | | | |
| 0770310 | | 100-110mm | wit | 7000121580 | stuk | 6,10 | 353 0 |

kunststof potmanchet

| | | | | | | | |
|---------|-------|-----------------------|-----|------------|------|------|-------|
| 0771937 | nr. 7 | 100-110mm excentrisch | wit | 7000119912 | stuk | 6,10 | 353 0 |
|---------|-------|-----------------------|-----|------------|------|------|-------|

manchet nr. 7

| | | | | | | | |
|---------|--|--|-----|------------|------|------|-------|
| 0710825 | | | wit | 8040301007 | stuk | 6,10 | 353 1 |
|---------|--|--|-----|------------|------|------|-------|

Closetafvoeren Plieger

| | | | | | | | |
|-----------------------------|--|-------------|-----|---------|------|------|-------|
| kunststof potmanchet | | | | | | | |
| 0772003 | | recht | wit | 0772003 | stuk | 4,67 | 353 0 |
| 0772011 | | excentrisch | wit | 0772011 | stuk | 4,37 | 353 0 |

rozet vlak

| | | | | | | | |
|---------|--|--|-----|--------|------|------|-------|
| 0771481 | | | wit | 754001 | stuk | 1,33 | 353 0 |
|---------|--|--|-----|--------|------|------|-------|

Closetafvoeren Sphinx

| | | | | | | | |
|-----------------------------------|--|------------|--|-----------|------|-------|-------|
| bocht kunststof universeel | | | | | | | |
| 0202223 | | AO-uitlaat | | S8H782000 | stuk | 21,50 | 042 0 |
| 0202622 | | SV-uitlaat | | S8H865000 | stuk | 21,50 | 042 1 |
| 0202614 | | S-uitlaat | | S8H864000 | stuk | 21,50 | 042 1 |

Closetafvoeren Villeroy & Boch

| | | | | | | | |
|------------------------------------|--|-----------|--|----------|------|-------|-------|
| vario afvoerbocht verticaal | | | | | | | |
| 0102225 | | 70-160mm | | 87110000 | stuk | 68,00 | 052 1 |
| 0102221 | | 160-250mm | | 87010000 | stuk | 68,00 | 052 0 |

| | Art.nr | Specificaties | Kleur | Lev.nr | Ehd | Prijs | Grp | CC |
|---|--|---------------------|--------|------------|------|-------|-----|----|
| Sanitair producten | Closetafvoeren Viega | | | | | | | |
| | afvoerset voor closetcombinatie | | | | | | | |
| | 0082198 | multi SV/PK | | 131777 | stuk | 38,00 | 350 | 1 |
| Baden / douchebakken / stoomcabines | Closetafvoeren Wisa | | | | | | | |
| | flexibele afvoerslang | | | | | | | |
| | 0770650 | 110mm | | 1409986087 | stuk | 28,50 | 353 | 0 |
| Kranen | Hoekstopkranen Schell | | | | | | | |
| | hoekstopkraan m. pijpje | | | | | | | |
| | 0440264 | 3/8"x10mm klem | chroom | 050200699 | stuk | 17,75 | 210 | 0 |
| Douchegarnituur | duoblokstopkraan | | | | | | | |
| | 0440213 | 10x12mm klem | chroom | 059310699 | stuk | 10,50 | 210 | 0 |
| | 1510007 | 1/2"x15mm | chroom | 059130699 | stuk | 11,75 | 409 | 0 |
| Accessoires en spiegels | Hoekstopkranen VSH | | | | | | | |
| | hoekstopkraan | | | | | | | |
| | 1510584 | 3/8"x12mm capillair | nikkel | 0492976 | stuk | 6,10 | 409 | 0 |
| | 1511084 | 3/8"x12mm klem | chroom | 0492129 | stuk | 9,50 | 409 | 0 |
| Douchewanden | | | | | | | | |
| Toebehoren & afvoeren | | | | | | | | |
| Spoel- & installatiesystemen | | | | | | | | |
| Badkamermeubelen en toiletkasten | | | | | | | | |
| Gootstenen en wastroggen | | | | | | | | |
| Utiliteit | | | | | | | | |

| Art.nr | Specificaties | Kleur | Lev.nr | Ehd | Prijs | Grp | CC |
|--|---|-------|------------|------|-------|-----|----|
| 0770302 | bioblok m. enzymen voor urinoir pot = 500gram | | 125990001 | stuk | 61,90 | 353 | 1 |
| Toebehoren Uridan | | | | | | | |
| 0160105 | reinigingsmiddel 50ml | | 618728050 | stuk | 8,70 | 369 | 0 |
| 0160113 | reinigingsdoekjes 50stuks | | 618728630 | stuk | 31,00 | 369 | 1 |
| Spoelerpijp Gelmo | | | | | | | |
| spoelerpijp 3/4" m. bocht | | | | | | | |
| 0730149 | m. kraag sprong 4cm | chrom | CSP035 | stuk | 64,00 | 353 | 0 |
| 0730130 | m. kraag sprong 7cm | chrom | CSP037 | stuk | 64,00 | 353 | 0 |
| 0730165 | z. kraag sprong 4cm | chrom | CSP040 | stuk | 60,00 | 353 | 0 |
| 0730157 | z. kraag sprong 7cm | chrom | CSP042 | stuk | 60,00 | 353 | 0 |
| Bevestigingssets Keramag | | | | | | | |
| kerafix bevestigingsset voor urinoir | | | | | | | |
| 0080401 | | chrom | 551070000 | stuk | 42,00 | 034 | 1 |
| Bevestigingssets Villeroy & Boch | | | | | | | |
| bevestigingsset universeel | | | | | | | |
| 0100897 | | | 99610000 | stuk | 21,00 | 053 | 1 |
| bevestigingsset | | | | | | | |
| 0101796 | urinoir Esta/Magnum-Neu | | 99700000 | stuk | 21,00 | 053 | 1 |
| inlaatfitting | | | | | | | |
| 0100595 | urinoir Ebra/Esta/Magnum-Neu | | 99320000 | stuk | 19,00 | 053 | 1 |
| 0100951 | urinoir Esta/Magnum/Stratos | | 99330000 | stuk | 27,00 | 053 | 1 |
| aansluitgarnituur | | | | | | | |
| 0104612 | urinoir Magnum-Neu | | 93190000 | stuk | 70,00 | 053 | 1 |
| Urinoirsifon Duravit | | | | | | | |
| urinoirsifon | | | | | | | |
| 0293253 | horizontaal | | 0050120000 | stuk | 25,50 | 017 | 0 |
| 0293261 | verticaal | | 0050110000 | stuk | 25,50 | 017 | 0 |
| Urinoirsifon Geberit | | | | | | | |
| urinoirsifon | | | | | | | |
| 0710997 | horizontaal | | 152983001 | stuk | 24,00 | 328 | 0 |
| 0711004 | verticaal | | 152984001 | stuk | 24,00 | 328 | 0 |
| spoelbocht voor universele inbouwunit | | | | | | | |
| 0700026 | 32mm | wit | 119704161 | stuk | 26,50 | 329 | 0 |
| inlaatgarnituur voor urinoir | | | | | | | |
| 0700009 | | | 152489161 | stuk | 8,30 | 328 | 0 |
| Urinoirsifon Viega | | | | | | | |
| urinoirsifon 70/75/80/85 | | | | | | | |
| 0201197 | horizontaal | | 492465 | stuk | 25,50 | 350 | 0 |
| 0201200 | verticaal | | 492458 | stuk | 25,50 | 350 | 0 |
| Urinoirsifon Villeroy & Boch | | | | | | | |
| urinoirsifon | | | | | | | |
| 0104590 | horizontaal | | 93090000 | stuk | 25,50 | 053 | 0 |
| 0104604 | verticaal | | 93080000 | stuk | 25,50 | 053 | 1 |
| Aansluitmateriaal Viega | | | | | | | |
| urinoir uitlaatfitting z. buis z. rozet | | | | | | | |
| 0510327 | 5/4" 50x32mm | chrom | 108878 | stuk | 12,75 | 350 | 0 |
| 0510335 | 6/4" 65x37mm | chrom | 132002 | stuk | 13,00 | 350 | 1 |
| buis en rozet voor uitlaatfitting | | | | | | | |
| 0510351 | 5/4"x50cm | chrom | 114794 | stuk | 19,75 | 350 | 0 |



Sanitair producten

Baden /
douchebakken /
stoomcabines

Kranen

Douchegarnituur

Accessoires en
spiegels

Douchewanden

Toebehoren &
afvoeren

Spoel- &
installatiesystemen

Badkamermeubelen
en toiletkasten

Gootstenen en
wastroggen

Utiliteit

Toebehoren urinoir

| | Art.nr | Specificaties | Kleur | Lev.nr | Ehd | Prijs | Grp | CC |
|---|--|-----------------------|----------|-----------|------|--------|-----|----|
| Sanitair producten | Aansluitmateriaal Viega | | | | | | | |
| | urinoir afvoerbocht | | | | | | | |
| | 0510394 | m. rozet 5/4" | chrom | 120627 | stuk | 10,25 | 350 | 0 |
| Baden / douchebakken / stoomcabines | rubber ring voor urinoir 50mm | | | | | | | |
| | 0500933 | | | 127626 | stuk | 2,54 | 350 | 0 |
| Kranen | Aansluitmateriaal Mulet | | | | | | | |
| | urinoir inlaatverbinding m. chroom rand | | | | | | | |
| | 0730424 | 81R voor Sphinx 55 | | 112811030 | stuk | 2,13 | 353 | 0 |
| | 0730629 | 68R voor Sphinx 52-53 | | 112681012 | stuk | 5,68 | 353 | 0 |
| Douchegarnituur | Aansluitmateriaal Villeroy & Boch | | | | | | | |
| | afvoermanchet | | | | | | | |
| | 0100978 | voor urinoir Ebra | | 99820000 | stuk | 19,00 | 053 | 1 |
| Accessoires en spiegels | Urinoirschot Geberit | | | | | | | |
| | urinoirschot | | | | | | | |
| | 0700851 | | wit | 115200111 | stuk | 221,00 | 328 | 0 |
| | 0700854 | | pergamon | 115200EP1 | stuk | 272,00 | 328 | 1 |
| Douchewanden | Satinato urinoirschot ovaal | | | | | | | |
| | 0710248 | | grijs | 115210CD1 | stuk | 406,00 | 328 | 1 |
| | 0710249 | | groen | 115210GT1 | stuk | 406,00 | 328 | 1 |
| Toebehoren & afvoeren | Satinato urinoirschot rechthoekig | | | | | | | |
| | 0710250 | | grijs | 115214CD1 | stuk | 406,00 | 328 | 1 |
| | 0710251 | | groen | 115214GT1 | stuk | 406,00 | 328 | 1 |
| Spoel- & installatiesystemen | Urinoirschot Geesa | | | | | | | |
| | urinoirschot m. 2-houders | | | | | | | |
| | 0650110 | | wit | 5671 | stuk | 175,00 | 241 | 0 |
| | 0650013 | | zwart | 5670 | stuk | 175,00 | 241 | 1 |
| Badkamermeubelen en toiletkasten | urinoirschot trespa m. 2-houders | | | | | | | |
| | 0650115 | | wit | 5676 | stuk | 183,00 | 241 | 1 |
| Gootstenen en wastroggen | urinoirschothouder 2-stuks | | | | | | | |
| | 0650113 | | chrom | 5674 | stuk | 114,00 | 241 | 1 |
| Utiliteit | | | | | | | | |

| Art.nr | Specificaties | Kleur | Lev.nr | Ehd | Prijs | Grp | CC |
|---|---------------|--------|----------|------|--------|-----|----|
| Bevestigingssets Plieger | | | | | | | |
| montagestoel universeel | | | | | | | |
| 0830321 | | | 0830321 | stuk | 20,50 | 362 | 0 |
| Bevestigingssets Villeroy & Boch | | | | | | | |
| montageset voor staand bidet voor montage tegen de wand | | | | | | | |
| 0112798 | | | 92083100 | stuk | 86,00 | 052 | 1 |
| Bidetsifon Gessi | | | | | | | |
| designsifon 5/4" voor bidet m. verstelbare muurbuis 80-120mm | | | | | | | |
| 0464309 | | chroom | 1375031 | stuk | 104,00 | 169 | 1 |
| 0464317 | | inox | 1375142 | stuk | 208,00 | 169 | 1 |



Sanitair producten

Baden /
douchebakken /
stoomcabines

Kranen

Douchegarnituur

Accessoires en
spiegels

Douchewanden

**Toebehoren &
afvoeren**

Spoel- &
installatiesystemen

Badkamermeubelen
en toiletkasten

Gootstenen en
wastroggen

Utiliteit

Sanitair producten

Baden /
douchebakken /
stoomcabines

Kranen

Douchegarnituur

Accessoires en
spiegels

Douchewanden

Toebehoren &
afvoeren

Spoel- &
installatiesystemen

Badkamermeubelen
en toiletkasten

Gootstenen en
wastroggen

Utiliteit

Spoel- & installatiesystemen

| | |
|---------------------------------|------|
| Closetzittingen ABU | 1164 |
| Closetzittingen Cararra & Matta | 1165 |
| Closetzittingen Celmac | 1166 |
| Closetzittingen Haro | 1168 |
| Closetzittingen Pagette | 1169 |
| Closetzittingen Plieger | 1171 |
| Closetzittingen Pressalit | 1173 |
| Closetzittingen Rezi | 1176 |
| Douche WC | 1177 |
| Reservoirs ABU | 1179 |
| Reservoirs Geberit | 1180 |
| Installatiesystemen Geberit Gis | 1187 |
| Reservoirs Grohedal | 1189 |
| Reservoirs Pagette | 1193 |
| Reservoirs Plieger | 1194 |
| Reservoirs Rezi | 1199 |
| Reservoirs Schwab | 1200 |
| Reservoirs Wisa | 1202 |
| Installatiesystemen Burda | 1206 |
| Installatiesystemen Viega | 1207 |
| Faecaliënvermalers | 1210 |
| Spoelers Aqua | 1214 |
| Spoelers Geberit | 1215 |
| Spoelers Grohedal | 1216 |
| Spoelers Schell | 1218 |

Spoel- & installatiesystemen



| Art.nr | Specificaties | Kleur | Lev.nr | Ehd | Prijs | Grp | CC |
|--|---------------|----------|--------|------|-------|-----|----|
| ABU City | | | | | | | |
| closetzitting dubbel m. RVS garnituur | | | | | | | |
| 0750239 | | wit | 652101 | stuk | 25,75 | 344 | 0 |
| 0751537 | | pergamon | 652105 | stuk | 29,75 | 344 | 0 |

Sanitair producten

Baden /
douchebakken /
stoomcabines

Kranen

Douchegarnituur

Accessoires en
spiegels

Douchewanden

Toebehoren &
afvoeren

Spoel- &
installatiesystemen

Badkamermeubelen
en toiletkasten

Gootstenen en
wastroggen

Utiliteit

| Art.nr | Specificaties | Kleur | Lev.nr | Ehd | Prijs | Grp | CC |
|-----------------------------------|---------------|-------|-----------|-----------------------------------|-------|-----|----|
| | | | | Cararra & Matta Nord | | | |
| closetzitting enkel | | | | | | | |
| 0751901 | | wit | 100453000 | stuk | 23,00 | 337 | 0 |
| 0751898 | | zwart | 100453047 | stuk | 19,50 | 337 | 1 |
| <hr/> | | | | | | | |
| closetzitting dubbel | | | | | | | |
| 0751936 | | wit | 100452000 | stuk | 35,50 | 337 | 0 |
| 0751928 | | zwart | 100452047 | stuk | 28,75 | 337 | 0 |
| | | | | Cararra & Matta Rimini | | | |
| closetzitting dubbel K1Eco | | | | | | | |
| 0751902 | | wit | 100493000 | stuk | 25,00 | 337 | 1 |



Sanitair producten

Baden /
douchebakken /
stoomcabines

Kranen

Doucheapparatuur

Accessoires en
spiegels

Douchewanden

Toebehoren &
afvoeren

Spoel- &
installatiesystemen

Badkamermeubelen
en toiletkasten

Gootstenen en
wastroggen

Utiliteit

| | Art.nr | Specificaties | Kleur | Lev.nr | Ehd | Prijs | Grp | CC |
|---|---|---------------------------------|--------------------|-----------|---------|-------|------|-----|
| Sanitair producten | Celmac zitting 25 | | | | | | | |
| | closetzitting enkel | | | | | | | |
| | 0750379 | m. RVS garnituur BCPC | wit | SS05QWH | stuk | 56,50 | 344 | 0 |
| | 0750360 | m. RVS garnituur BCPC | zwart | SS05QBL | stuk | 41,50 | 344 | 0 |
| Baden / douchebakken / stoomcabines | closetzitting dubbel | | | | | | | |
| | 0750395 | m. RVS garnituur BCPC | wit | SS01QWH | stuk | 75,00 | 344 | 0 |
| | 0750387 | m. RVS garnituur BCPC | zwart | SS01QBL | stuk | 58,50 | 344 | 1 |
| Kranen | Celmac zitting 38 | | | | | | | |
| | kinderclosetzitting enkel | | | | | | | |
| | 0750221 | m. RVS garnituur BCPC | wit | SCJ53WH | stuk | 60,50 | 344 | 1 |
| | 0750220 | m. RVS garnituur BCPC | zwart | SCJ53BL | stuk | 53,50 | 344 | 0 |
| Douchegarnituur | | | | | | | | |
| Accessoires en spiegels | Celmac zitting 42 | | | | | | | |
| | closetzitting non-contact enkel | | | | | | | |
| | 0750417 | m. kunststof garnituur DPP | wit | SCR51WH | stuk | 40,25 | 344 | 1 |
| | 0752878 | m. RVS garnituur BCPC | wit | SCR5QWH | stuk | 58,00 | 344 | 0 |
| | 0752851 | m. RVS garnituur BCPC | zwart | SCR5QBL | stuk | 49,75 | 344 | 0 |
| Douchewanden | | | | | | | | |
| Toebehoren & afvoeren | closetzitting non-contact dubbel | | | | | | | |
| | 0750425 | m. kunststof garnituur DPP | wit | SCR11WH | stuk | 55,00 | 344 | 1 |
| | 0752894 | m. RVS garnituur BCPC | wit | SCR1QWH | stuk | 72,00 | 344 | 1 |
| | 0752886 | m. RVS garnituur BCPC | zwart | SCR1QBL | stuk | 61,50 | 344 | 1 |
| Spoel- & installatiesystemen | Celmac zitting 170 | | | | | | | |
| | closetzitting enkel | | | | | | | |
| | 0752789 | m. kunststof garnituur DPP | wit | STA51WH | stuk | 14,25 | 337 | 0 |
| | 0752770 | m. kunststof garnituur DPP | zwart | STA15BL | stuk | 12,00 | 337 | 0 |
| | 0752746 | m. RVS garnituur BCPC/2C | wit | STA54WH | stuk | 28,00 | 337 | 1 |
| | 0752738 | m. RVS garnituur BCPC/2C | zwart | STA54BL | stuk | 26,25 | 337 | 1 |
| Badkamermeubelen en toiletkasten | closetzitting dubbel | | | | | | | |
| | 0752800 | m. kunststof garnituur DPP | wit | STA11WH | stuk | 20,00 | 337 | 0 |
| | 0752797 | m. kunststof garnituur DPP | zwart | STA11BL | stuk | 16,00 | 337 | 0 |
| | 0752762 | m. RVS garnituur BCPC/2C | wit | STA14WH | stuk | 35,25 | 337 | 1 |
| | 0752754 | m. RVS garnituur BCPC/2C | zwart | STA14BL | stuk | 30,75 | 344 | 1 |
| Gootstenen en wastroggen | Celmac Annan | | | | | | | |
| | closetzitting dubbel | | | | | | | |
| | 0751952 | m. RVS garnituur | wit | SRX18WH | stuk | 41,25 | 337 | 1 |
| Utiliteit | Celmac zitting LWF | | | | | | | |
| | closetzitting enkel | | | | | | | |
| | 0750336 | m. kunststof garnituur DPP | wit | SC051WH | stuk | 27,00 | 344 | 0 |
| | 0750328 | m. kunststof garnituur DPP | zwart | SC051BL | stuk | 20,00 | 344 | 0 |
| | 0752827 | m. RVS garnituur BCPC/2C | wit | SC05VWH | stuk | 36,75 | 344 | 1 |
| | 0752819 | m. RVS garnituur BCPC/2C | zwart | SC05VBL | stuk | 29,75 | 344 | 1 |
| | closetzitting dubbel | | | | | | | |
| | 0750352 | m. kunststof garnituur DPP | wit | SC011WH | stuk | 39,50 | 344 | 0 |
| | 0750344 | m. kunststof garnituur DPP | zwart | SC011BL | stuk | 26,75 | 344 | 1 |
| | 0752843 | m. RVS garnituur BCPC/2C | wit | SC01VWH | stuk | 49,00 | 344 | 1 |
| | 0752835 | m. RVS garnituur BCPC/2C | zwart | SC01VBL | stuk | 36,25 | 344 | 1 |
| | Celmac bevestigingsgarnituur | | | | | | | |
| | bevestigingsgarnituur | | | | | | | |
| | | 0750883 | per paar kunststof | wit | DPP WIT | paar | 6,90 | 344 |
| | 0750980 | per paar kunststof | zwart | DPP ZWART | paar | 6,90 | 344 | 0 |
| bevestigingsgarnituur BCPC | | | | | | | | |
| | 0750891 | per paar (niet voor 170 en LWF) | RVS | FD211SS | paar | 16,25 | 344 | 0 |

HARO
SANITARY

HARO® TOILETZITTINGEN – DE IDEALE COMBINATIE VAN KWALITEIT EN DESIGN



HARO® is veelzijdig



Wij hebben drie collecties toiletzittingen. **HomeLine®** voor thuisgebruik, **CommercialLine®** voor de bedrijfssector en **CareLine®** voor de hoogste hygiënische eisen. Wij combineren designexpertise met uiterste doelmatigheid en comfort.

HARO® is compatibel



Onze toiletzittingen voldoen aan internationale standaards en passen op 90% van alle door keramiekfabrikanten vervaardigde modellen.



Zijn er speciale wensen? Geen probleem: onze flexibiliteit is ongeëvenaard dankzij ons grote aantal vormen en scharnieroplossingen.

HARO® is innovatief



Details zijn onze grote liefde: verstelbare universele excentrische scharnieren, het automatische sluitmechanisme SoftClose®, of bovenbevestiging voor eenvoudige installatie – HARO® is wezenlijk innovatief en designbewust.

HARO® is veilig



Onze CareLine® producten garanderen een absolute hygiëne. Met zijn grote assortiment modellen biedt HARO® de ideale toiletzitting,

zowel voor nieuwe installaties als voor renovaties. Onze hoge standaards op alle gebieden worden bevestigd door de vele onderscheidingen en prijzen die ons werden toegekend.













HARO® is er altijd voor u

Tel. 013-5113545
Fax 013-5112068





e-mail: san@hamberger.de
Bezoek onze homepage: www.haro-sanitary.de

HARO
SANITARY

| | Art.nr | Specificaties | Kleur | Lev.nr | Ehd | Prijs | Grp | CC |
|---|--|------------------|----------|--------------|------|--------|-----|----|
| Sanitair producten |  Haro Costa closezitting dubbel | | | | | | | |
| | 0753084 | scharnier-chroom | wit | 94A101B0302Y | stuk | 23,75 | 341 | 1 |
| | 0753092 | scharnier-chroom | pergamon | 94A204B0302Y | stuk | 28,75 | 341 | 1 |
| Baden / douchebakken / stoomcabines | Haro Passat closezitting dubbel | | | | | | | |
| | 0753095 | softclose | wit | 34G101C0202Y | stuk | 102,69 | 341 | 1 |
| | 0753096 | softclose | pergamon | 34G204C0202Y | stuk | 108,84 | 341 | 1 |
| | 0753097 | | wit | 34A101T0102Y | stuk | 51,45 | 341 | 1 |
| | 0753098 | | pergamon | 34A204T0102Y | stuk | 57,60 | 341 | 1 |
| Kranen | | | | | | | | |
| |  Haro Pool Aktiv closezitting dubbel | | | | | | | |
| | 0753033 | scharnier-chroom | wit | 99A101B0302Y | stuk | 31,00 | 341 | 1 |
| Douchegarnituur | 0753041 | scharnier-chroom | pergamon | 99A204B0302Y | stuk | 36,00 | 341 | 1 |
| Accessoires en spiegels | | | | | | | | |
| Douchewanden | | | | | | | | |
| Toebehoren & afvoeren | | | | | | | | |
| Spoel- & installatiesystemen | | | | | | | | |
| Badkamermeubelen en toiletkasten | | | | | | | | |
| Gootstenen en wastroggen | | | | | | | | |
| Utiliteit | | | | | | | | |

| Art.nr | Specificaties | Kleur | Lev.nr | Ehd | Prijs | Grp | CC | | |
|--|---------------------------|-----------|-----------|------|--------|-----|----|---|---|
| Pagette Athena | | | | | | | |  | Sanitair producten |
| clouzetzitting dubbel | | | | | | | | | |
| 0750908 | | wit | 794490302 | stuk | 86,50 | 341 | 1 | | |
| 0752940 | | pergamon | 794490372 | stuk | 86,50 | 341 | 1 | | |
| Pagette Exklusiv Highline | | | | | | | |  | Baden / douchebakken / stoomcabines |
| clouzetzitting dubbel m. softclose | | | | | | | | | |
| 0750035 | | wit | 790830402 | stuk | 71,00 | 341 | 1 | | |
| 0750036 | | pergamon | 790830472 | stuk | 71,00 | 341 | 1 | | Kranen |
| clouzetzitting dubbel m. afneembare RVS bevestiging | | | | | | | | | |
| 0750037 | | wit | 790830302 | stuk | 51,50 | 341 | 1 | | |
| 0750038 | | pergamon | 790830372 | stuk | 51,50 | 341 | 1 | | Douchegarnituur |
| Pagette Kadett | | | | | | | |  | Accessoires en spiegels |
| clouzetzitting enkel | | | | | | | | | |
| 0750026 | | wit | 790890102 | stuk | 14,50 | 341 | 0 | | |
| 0750018 | | zwart | 790890101 | stuk | 14,50 | 341 | 0 | | |
| clouzetzitting dubbel | | | | | | | | | |
| 0750042 | | wit | 790880102 | stuk | 22,75 | 341 | 0 | | |
| 0750034 | | zwart | 790880101 | stuk | 22,75 | 341 | 0 | | |
| 0751529 | | pergamon | 790880172 | stuk | 24,25 | 341 | 0 | | Douchewanden |
| 0750085 | | manhattan | 790880110 | stuk | 24,25 | 341 | 1 | | |
| bevestigingsgarnituur | | | | | | | | | |
| 0750735 | per paar kunststof | | 7908401 | paar | 5,30 | 344 | 0 | | Toebehoren & afvoeren |
| Pagette Kadett 300S | | | | | | | |  | Spoel- & installatiesystemen |
| clouzetzitting dubbel | | | | | | | | | |
| 0750039 | m. RVS bevestiging | wit | 791880202 | stuk | 30,00 | 341 | 0 | | |
| 0750043 | m. RVS bevestiging | pergamon | 791880272 | stuk | 32,25 | 341 | 0 | | |
| 0750044 | m. afneembare bevestiging | wit | 791880302 | stuk | 33,00 | 341 | 1 | | |
| 0750045 | m. afneembare bevestiging | pergamon | 791880372 | stuk | 35,25 | 341 | 1 | | |
| 0750046 | m. softclose | wit | 791880402 | stuk | 60,00 | 341 | 0 | | Badkamermeubelen en toiletkasten |
| 0750047 | m. softclose | pergamon | 791880472 | stuk | 64,50 | 341 | 0 | | |
| clouzetzitting enkel | | | | | | | | | |
| 0750048 | m. RVS bevestiging | wit | 791890202 | stuk | 24,25 | 341 | 0 | | |
| 0750049 | m. RVS bevestiging | pergamon | 791890272 | stuk | 25,75 | 341 | 0 | | Gootstenen en wastroggen |
| Pagette Nordica | | | | | | | |  | Utiliteit |
| clouzetzitting dubbel | | | | | | | | | |
| 0750907 | | wit | 794330102 | stuk | 63,00 | 341 | 1 | | |
| 0750910 | | pergamon | 794330172 | stuk | 63,00 | 341 | 1 | | |
| Pagette Nova | | | | | | | |  | |
| clouzetzitting dubbel | | | | | | | | | |
| 0750912 | | wit | 792500102 | stuk | 145,00 | 337 | 1 | | |
| 0750913 | | pergamon | 792500172 | stuk | 145,00 | 337 | 1 | | |
| Pagette Maxime | | | | | | | |  | |
| clouzetzitting dubbel | | | | | | | | | |
| 0752924 | | wit | 795290102 | stuk | 92,00 | 341 | 1 | | |
| 0752932 | | pergamon | 795290172 | stuk | 92,00 | 341 | 1 | | |
| Pagette Orenda | | | | | | | |  | |
| clouzetzitting dubbel | | | | | | | | | |
| 0750914 | | wit | 795470102 | stuk | 72,50 | 337 | 1 | | |
| 0750915 | | pergamon | 795470172 | stuk | 72,50 | 337 | 1 | | |

| | Art.nr | Specificaties | Kleur | Lev.nr | Ehd | Prijs | Grp | CC |
|---|--|---------------|----------|-----------|------|-------|-----|----|
| Sanitair producten | Pagette Primat closetzitting dubbel | | | | | | | |
| | 0750905 | | wit | 791730102 | stuk | 30,50 | 341 | 0 |
| | 0750719 | | pergamon | 791730172 | stuk | 33,75 | 341 | 0 |
| Baden / douchebakken / stoomcabines | Pagette VIP closetzitting dubbel | | | | | | | |
| | 0752703 | | wit | 794980102 | stuk | 49,75 | 341 | 0 |
| | 0752916 | | pergamon | 794980172 | stuk | 49,75 | 341 | 0 |
| Kranen | | | | | | | | |
| Douchegarnituur | | | | | | | | |
| Accessoires en spiegels | | | | | | | | |
| Douchewanden | | | | | | | | |
| Toebehoren & afvoeren | | | | | | | | |
| Spoel- & installatiesystemen | | | | | | | | |
| Badkamermeubelen en toiletkasten | | | | | | | | |
| Gootstenen en wastroggen | | | | | | | | |
| Utiliteit | | | | | | | | |

| Art.nr | Specificaties | Kleur | Lev.nr | Ehd | Prijs | Grp | CC | |
|---|-----------------------------------|----------|---------|------|-------|-----|----|---|
| | | | | | | | | Plieger Brussel |
| closezitting dubbel | | | | | | | | |
| 0752177 | | wit | 0752177 | stuk | 46,25 | 009 | 0 |  |
| 0752185 | | pergamon | 0752185 | stuk | 46,25 | 009 | 0 | |
| <hr/> | | | | | | | | |
| | | | | | | | | Plieger Softclose |
| closezitting "Brussel 1001" m. deksel m. rvs scharnieren | | | | | | | | |
| 4345102 | | wit | 4345102 | stuk | 19,75 | 009 | 0 |  |
| 4345104 | | pergamon | 4345104 | stuk | 20,50 | 009 | 0 | |
| <hr/> | | | | | | | | |
| | | | | | | | | Onderdelen Plieger Softclose |
| closezitting universeel m. softclose | | | | | | | | |
| 0752370 | | wit | 0752370 | stuk | 81,00 | 009 | 0 |  |
| 0752375 | | pergamon | 0752375 | stuk | 81,00 | 009 | 0 | |
| <hr/> | | | | | | | | |
| | | | | | | | | Onderdelen Liberty |
| 0752372 | buffer voor toiletzitting | | 0752372 | stuk | 0,44 | 009 | 0 |  |
| 0752373 | buffer voor deksel | | 0752373 | stuk | 0,33 | 009 | 0 | |
| 0752374 | bevestigingsset en vertrager | | 0752374 | stuk | 38,75 | 009 | 0 | |
| <hr/> | | | | | | | | |
| | | | | | | | | Onderdelen Spring |
| 0752339 | scharnierpaar compleet | | 0752339 | stuk | 13,00 | 009 | 0 |  |
| 0752363 | buffer voor closezitting per stuk | | 0752363 | stuk | 0,84 | 009 | 0 | |
| 0752428 | buffer voor deksel per stuk | | 0752428 | stuk | 0,56 | 009 | 0 | |

Sanitair producten

Baden /
douchebakken /
stoomcabines

Kranen

Douchegarnituur

Accessoires en
spiegels

Douchewanden

Toebehoren &
afvoeren

Spoel- &
installatiesystemen

Badkamermeubelen
en toiletkasten

Gootstenen en
wastroggen

Utiliteit

Pressalit Privilege en Pressalit Projecta

- twee duidelijke keuzes voor de projectmarkt

Pressalit Privilege

Pressalit Privilege is een versterkte zitting. De zitting is verkrijgbaar in drie verschillende versies – met een universeel scharnier, een scharnier met doorlopende pen en in een verhoogde uitvoering. De zitting ligt stabiel op het closet door de stabilisatieknoppen, die de zitting goed tegen het closet klemmen. Dit maakt het dagelijks gebruik nog iets veiliger.



Het nieuwe flexibele universele scharnier is elegant in vorm en functie. En eenvoudiger te reinigen.



Voor een extra sterke en stabiele montage van de zitting is het projectscharnier met tussenstang de juiste keus.



De verhoogde zitting helpt mensen met beperkte bewegingsmogelijkheden.

Pressalit Projecta

Pressalit Projecta is, zoals de naam al zegt, geschikt voor projecten. Projecta heeft een extra sterke en stabiele bevestiging, door de nieuwe, verbeterde vaste en universele projectscharnieren met doorlopende pen. Het resultaat: grotere stabiliteit, eenvoudigere montage en een strakke vormgeving.



Een vast projectscharnier garandeert een stabiele bevestiging - door de tussenstang en de ononderbroken bevestigingsbouten voor de montage op het keramiek - op alle closettypen.



Bij het universele projectscharnier hebben de bevestigingsbouten een grote verstelbaarheid door de 360° draaibare scharnierbases.



Voor risicovolle plaatsen kan een universeel projectscharnier met anti-diefstalbevestiging (met speciale sleutel) worden gemonteerd.



Seats for your senses

| Art.nr | Specificaties | Kleur | Lev.nr | Ehd | Prijs | Grp | CC |
|--------|---------------|-------|--------|-----|-------|-----|----|
|--------|---------------|-------|--------|-----|-------|-----|----|

Pressalit 300

| closezitting | | | | | | | |
|--------------|-----------|----------|--------------|------|-------|-----|---|
| 0604563 | z. deksel | wit | 103000BT8999 | stuk | 54,00 | 340 | 1 |
| 0604564 | z. deksel | pergamon | 103273BT8999 | stuk | 54,00 | 340 | 1 |
| 0604565 | m. deksel | wit | 548000BT8999 | stuk | 77,00 | 340 | 0 |
| 0604566 | m. deksel | pergamon | 548273BT8999 | stuk | 77,00 | 340 | 0 |

Sanitair producten

Pressalit 2000

| closezitting | | | | | | | |
|--------------|------------------------|-----------|--------------|------|-------|-----|---|
| 0752460 | m. deksel | wit | 124000B13999 | stuk | 67,00 | 340 | 0 |
| 0752479 | m. deksel | zwart | 124001B13999 | stuk | 71,50 | 340 | 0 |
| 0750727 | m. deksel | pergamon | 124273B13999 | stuk | 67,00 | 340 | 0 |
| 0752975 | m. deksel | manhattan | 124052B13999 | stuk | 71,50 | 340 | 1 |
| 0752258 | m. deksel v. Sphinx 48 | wit | 124000BL2999 | stuk | 67,00 | 340 | 1 |
| 0752266 | m. deksel v. Sphinx 48 | pergamon | 124273BL2999 | stuk | 67,00 | 340 | 1 |

Baden /
douchebakken /
stoomcabines

Kranen

Pressalit Amadea

| closezitting | | | | | | | |
|--------------|-----------|----------|--------------|------|--------|-----|---|
| 0751800 | m. deksel | wit | 192000BA4999 | stuk | 145,00 | 340 | 1 |
| 0751805 | m. deksel | pergamon | 192273BA4999 | stuk | 145,00 | 340 | 1 |



Douchegarnituur

Accessoires en
spiegels

Pressalit Chess Uni

| closezitting | | | | | | | |
|--------------|-----------|-------------|----------------|------|--------|-----|---|
| 0753266 | m. deksel | lichthout | 416617BG699958 | stuk | 364,00 | 340 | 1 |
| 0753267 | m. deksel | donker hout | 416618BG699958 | stuk | 364,00 | 340 | 1 |



Douchewanden

Pressalit Comprimo 2000

| closezitting | | | | | | | |
|--------------|-----------|----------|--------------|------|-------|-----|---|
| 0751693 | m. deksel | wit | 124000BF5999 | stuk | 67,00 | 340 | 0 |
| 0751707 | m. deksel | pergamon | 124273BF5999 | stuk | 67,00 | 340 | 0 |



Toebehoren &
afvoeren

Spoel- &
installatiesystemen

Pressalit Dania

| closezitting non-kontakt | | | | | | | |
|--------------------------|-----------|----------|--------------|------|--------|-----|---|
| 0751022 | z. deksel | wit | 72000B13999 | stuk | 87,00 | 340 | 0 |
| closezitting | | | | | | | |
| 0751715 | m. deksel | wit | 982000B47999 | stuk | 111,00 | 340 | 0 |
| 0751723 | m. deksel | pergamon | 982273B47999 | stuk | 111,00 | 340 | 0 |



Badkamermeubelen
en toiletkasten

Gootstenen en
wastroggen

Utiliteit

Pressalit Dania Rehab

| closezitting +5cm | | | | | | | |
|-------------------|-----------|----------|--------|------|--------|-----|---|
| 0751758 | z. deksel | wit | R23000 | stuk | 151,00 | 384 | 1 |
| 0751766 | z. deksel | pergamon | R23273 | stuk | 151,00 | 384 | 1 |
| 0751774 | z. deksel | rood | R23035 | stuk | 151,00 | 384 | 1 |
| 0751782 | z. deksel | blauw | R23108 | stuk | 151,00 | 384 | 1 |
| 0751804 | m. deksel | wit | R33000 | stuk | 190,00 | 384 | 1 |
| 0751847 | m. deksel | blauw | R33108 | stuk | 190,00 | 384 | 1 |

Pressalit Ergosit Rehab

| closezitting +5cm | | | | | | | |
|-------------------|-----------|-----|--------------|------|--------|-----|---|
| 0751863 | z. deksel | wit | R29000B84999 | stuk | 132,00 | 384 | 1 |
| closezitting | | | | | | | |
| 0751871 | m. deksel | wit | R30000B84999 | stuk | 170,00 | 384 | 1 |

Pressalit Evidente

| closezitting | | | | | | | |
|--------------|-----------|-----|--------------|------|-------|-----|---|
| 0753276 | m. deksel | wit | 172000BR7999 | stuk | 88,50 | 340 | 0 |
| 0753278 | m. deksel | wit | 172000BQ6999 | stuk | 88,50 | 340 | 0 |



| | Art.nr | Specificaties | Kleur | Lev.nr | Ehd | Prijs | Grp | CC |
|---|---------------------------------------|--------------------------------------|-----------|---------------|------|--------|-----|----|
| | Pressalit Magnum | | | | | | | |
| | closetzitting | | | | | | | |
| Sanitair producten | 0750247 | m. deksel | wit | 104000B33999 | stuk | 88,00 | 340 | 0 |
| | 0750778 | m. deksel | pergamon | 104273B33999 | stuk | 88,00 | 340 | 0 |
| | 0750492 | m. deksel | manhattan | 104052B33999 | stuk | 88,00 | 340 | 1 |
| | 0750557 | m. deksel | jasmijn | 104050B33999M | stuk | 114,00 | 340 | 1 |
| | 0750530 | m. deksel | edelweiss | 104030B33999M | stuk | 114,00 | 340 | 0 |
| Baden / douchebakken / stoomcabines | Pressalit Objecta | | | | | | | |
| | closetzitting | | | | | | | |
| Kranen | 0752991 | z. deksel | wit | 53000BA1999 | stuk | 37,50 | 340 | 0 |
| | 0752592 | m. deksel | wit | 54000BA1999 | stuk | 55,50 | 340 | 0 |
| Douchegarnituur | Pressalit Privilege | | | | | | | |
| | closetzitting z. deksel m. RVS | | | | | | | |
| Accessoires en spiegels | 0604570 | uni scharnier BN3 | wit | 531000BN3999 | stuk | 90,50 | 384 | 1 |
| | 0604571 | uni scharn. m. doorl. pen BV7 | wit | 531000BV5999 | stuk | 102,00 | 384 | 1 |
| | 0604574 | vaste scharn. m.doorl. pen BY5 | wit | 531000BY3999 | stuk | 102,00 | 384 | 1 |
| | 0604558 | verhoogd scharnier +5cm BK1 | wit | 531000BK1000 | stuk | 178,00 | 384 | 1 |
| Douchewanden | closetzitting m. deksel m. RVS | | | | | | | |
| | 0604572 | uni scharnier BN3 | wit | 532000BN3999 | stuk | 103,00 | 384 | 1 |
| | 0604573 | uni scharn. m. doorl. pen BV7 | wit | 532000BV7999 | stuk | 114,00 | 384 | 1 |
| | 0604575 | vaste scharn. m.doorl. pen BY5 | wit | 532000BY5999 | stuk | 114,00 | 384 | 1 |
| | 0604561 | verhoogd scharnier +5cm BK1 | wit | 532000BK1000 | stuk | 191,00 | 384 | 1 |
| Toebehoren & afvoeren | Pressalit Projecta | | | | | | | |
| | closetzitting z. deksel | | | | | | | |
| | 0750826 | m. scharnier m. doorlopende pen BY39 | wit | 53000BY3999 | stuk | 46,85 | 340 | 0 |
| Spoel- & installatiesystemen | closetzitting m. deksel | | | | | | | |
| | 0750828 | m. scharnier m. doorlopende pen BY39 | wit | 54000BY3999 | stuk | 64,50 | 340 | 0 |
| Badkamermeubelen en toiletkasten | Pressalit Raja | | | | | | | |
| | closetzitting | | | | | | | |
| | 0753260 | m. deksel en demper | wit | 410000BL5999 | stuk | 175,00 | 340 | 1 |
| | 0753261 | m. deksel en demper | pergamon | 410273BL5999 | stuk | 175,00 | 340 | 1 |
| Gootstenen en wastroggen | wandafvallemmer | | | | | | | |
| | 0753269 | | wit | 411000 | stuk | 165,00 | 340 | 1 |
| | 0753263 | | pergamon | 411273 | stuk | 165,00 | 340 | 1 |
| | opklapzitting met demper | | | | | | | |
| | 0753264 | | wit | 412000 | stuk | 370,00 | 340 | 1 |
| | 0753265 | | pergamon | 412273 | stuk | 370,00 | 340 | 1 |
| Utiliteit | closetrolhouder | | | | | | | |
| | 0604501 | | wit | 480000 | stuk | 68,00 | 340 | 1 |
| | 0604502 | | pergamon | 480273 | stuk | 68,00 | 340 | 1 |
| | Pressalit Scandinavia | | | | | | | |
| | closetzitting | | | | | | | |
| | 0750999 | z. deksel | wit | 74000B13999 | stuk | 73,50 | 340 | 1 |
| | 0751006 | m. deksel | wit | 75000B13999 | stuk | 92,50 | 340 | 0 |
| | 0604493 | m. deksel en demping | wit | 472000BP9999 | stuk | 131,00 | 340 | 0 |
| | 0604494 | m. deksel en demping | pergamon | 472273BP9999 | stuk | 131,00 | 340 | 1 |
| | Pressalit Tivoli-2 | | | | | | | |
| | closetzitting | | | | | | | |
| | 0752673 | m. deksel | wit | 316000BN3999 | stuk | 67,00 | 340 | 0 |
| | 0752436 | m. deksel | pergamon | 316273BN3999 | stuk | 67,00 | 340 | 0 |
| | 0752487 | m. deksel | zwart | 316001BN3999 | stuk | 71,50 | 340 | 0 |
| | 0752509 | z. deksel | wit | 315000BU3999 | stuk | 53,00 | 340 | 0 |
| | 0752517 | z. deksel | zwart | 315001BU3999 | stuk | 56,50 | 340 | 0 |
| | 0752525 | m. deksel v. Sphinx 48 | wit | 316000BL2999 | stuk | 67,00 | 340 | 1 |
| | 0752533 | m. deksel v. Sphinx 48 | pergamon | 316273BL2999 | stuk | 67,00 | 340 | 1 |
| | 0752576 | m. deksel v. Keramag Renova Comprimo | wit | 316000BF5999 | stuk | 67,00 | 340 | 0 |
| | 0752614 | m. deksel v. Keramag Renova Comprimo | pergamon | 316273BF5999 | stuk | 67,00 | 340 | 0 |

| Art.nr | Specificaties | Kleur | Lev.nr | Ehd | Prijs | Grp | CC |
|--------|---------------|-------|--------|-----|-------|-----|----|
|--------|---------------|-------|--------|-----|-------|-----|----|

Pressalit Uni Monsoon

| closetzitting | | | | | | | |
|---------------|----------|-------------|--------------|------|--------|-----|---|
| 0753268 | m. greep | teak natuur | 394604B47999 | stuk | 247,00 | 340 | 1 |
| 0753277 | m. greep | bamboe | 394619B47999 | stuk | 247,00 | 340 | 1 |



Sanitair producten

Baden /
douchebakken /
stoomcabines

Pressalit Viala

| closetzitting | | | | | | | |
|---------------|-----------|----------|--------------|------|-------|-----|---|
| 0751626 | m. deksel | wit | 204000BA3999 | stuk | 88,00 | 340 | 0 |
| 0751634 | m. deksel | pergamon | 204273BA3999 | stuk | 88,00 | 340 | 0 |



Kranen

Pressalit Zaga

| closetzitting | | | | | | | |
|---------------|--------------------------|----------|--------------|------|--------|-----|---|
| 0752622 | m. deksel | wit | 314000BH9999 | stuk | 92,50 | 340 | 0 |
| 0752630 | m. deksel | pergamon | 314273BH9999 | stuk | 92,50 | 340 | 0 |
| 0752649 | m. deksel | zwart | 314001BH9999 | stuk | 98,50 | 340 | 0 |
| 0752657 | m. deksel antibacterieel | wit | 314011BN9999 | stuk | 106,00 | 340 | 1 |



Douchegarnituur

Accessoires en
spiegels

| | | | | | | | |
|----------------------------|--|--|--------|------|-------|-----|---|
| Zaga steekscharnier | | | | | | | |
| 0753157 | | | BH7999 | stuk | 19,50 | 340 | 1 |

Douchewanden

| | | | | | | | |
|----------------------------------|--|--|--------|------|-------|-----|---|
| Zaga universele scharnier | | | | | | | |
| 0753165 | | | BN9999 | stuk | 19,50 | 340 | 0 |

Pressalit Zenit

| closetzitting m. deksel | | | | | | | |
|-------------------------|--|---------------|--------------|------|-------|-----|---|
| 0604553 | | berken natuur | 522607B47999 | stuk | 89,00 | 384 | 1 |
| 0604552 | | kersenhout | 522456B47999 | stuk | 89,00 | 384 | 1 |
| 0604551 | | mahonie | 522455B47999 | stuk | 89,00 | 384 | 1 |

Toebehoren &
afvoeren

Spoel- &
installatiesystemen

Pressalit wandafvalemers

| wandafvalemmer m. demping | | | | | | | |
|---------------------------|--|-----------|--------|------|--------|-----|---|
| 0604554 | | eiken wit | 411612 | stuk | 258,00 | 384 | 1 |
| 0604556 | | kersen | 411616 | stuk | 258,00 | 384 | 1 |
| 0604555 | | mahonie | 411615 | stuk | 258,00 | 384 | 1 |

Badkamermeubelen
en toiletkasten

Pressalit bevestigingsgarnituur

| Pressalit bevestigingsgarnituur | | | | | | | |
|---------------------------------|---------------------|-----|---------|------|-------|-----|---|
| 0753017 | universeel per paar | RVS | B13P999 | paar | 19,50 | 340 | 0 |
| 0750009 | universeel per paar | RVS | B03P999 | stuk | 19,50 | 340 | 1 |
| 0750054 | voor Objecta | RVS | BA1P999 | stuk | 19,50 | 340 | 1 |
| 0750527 | voor Comprimo | RVS | BF5P999 | stuk | 19,50 | 340 | 1 |



Gootstenen en
wastroggen

| | | | | | | | |
|---|--|--|-------|------|------|-----|---|
| Pressalit kunststof scharnierbus geribbeld | | | | | | | |
| 4502013 | | | A7222 | stuk | 0,60 | 340 | 0 |



Utiliteit

| | | | | | | | |
|------------------------------------|-----------------|--|---------|------|-------|-----|---|
| Quick Release uni scharnier | | | | | | | |
| 0604504 | Zaga | | BP3P999 | stuk | 33,25 | 340 | 1 |
| 0604505 | Dania | | BP5P999 | stuk | 33,25 | 340 | 1 |
| 0604506 | New Scandinavia | | BP9P999 | stuk | 33,25 | 340 | 1 |

| | | | | | | | |
|---|-----------------|--|---------|------|-------|-----|---|
| Quick Release uni scharnier m. kantelbevestiging | | | | | | | |
| 0604507 | New Scandinavia | | BQ7P999 | stuk | 19,50 | 340 | 1 |
| 0604508 | Dania | | BQ8P999 | stuk | 33,25 | 340 | 1 |
| 0604509 | Zaga | | BQ9P999 | stuk | 33,25 | 340 | 1 |

Pressalit Onderdelen

| | | | | | | | |
|---------|---|--|-------|------|------|-----|---|
| 0753314 | scharnieronderdelen universeel per 10 doosjes | | A7995 | stuk | 5,90 | 340 | 0 |
|---------|---|--|-------|------|------|-----|---|

| | Art.nr | Specificaties | Kleur | Lev.nr | Ehd | Prijs | Grp | CC |
|---|-------------------------------------|---------------------|------------|-------------|------|-------|-----|----|
| Sanitair producten | Rezi Envoy | | | | | | | |
| | closetzitting enkel | | | | | | | |
| | 0752126 | | wit/chroom | BA3035NCHR | stuk | 47,25 | 344 | 0 |
| | deksel voor closetzitting | | | | | | | |
| | 0752134 | | wit | BA3235N | stuk | 20,25 | 344 | 0 |
| Baden / douchebakken / stoomcabines | Rezi Populair | | | | | | | |
| | closetzitting enkel | | | | | | | |
| | 0750212 | | wit | BA3040 | stuk | 22,00 | 337 | 0 |
| Kranen | 0750204 | | zwart | BA3040 | stuk | 18,50 | 337 | 0 |
| | deksel voor closetzitting | | | | | | | |
| | 0750301 | | wit | BA3240 | stuk | 17,25 | 337 | 0 |
| Douchegarnituur | 0750298 | | zwart | BA3240 | stuk | 14,75 | 337 | 1 |
| | Rezi Modernline | | | | | | | |
| Accessoires en spiegels | closetzitting | | | | | | | |
| | 0752150 | enkel m. garnituur | wit | BA3060NCHR | stuk | 33,00 | 344 | 1 |
| | 0752142 | dubbel m. garnituur | wit | BA3060NDCHR | stuk | 43,50 | 344 | 1 |
| Douchewanden | Rezi Mercia | | | | | | | |
| | closetzitting enkel | | | | | | | |
| | 0753173 | m. RVS garnituur | wit | BA3070NMRVS | stuk | 39,50 | 344 | 0 |
| | 0753181 | m. RVS garnituur | zwart | BA3070NMRVS | stuk | 36,00 | 344 | 1 |
| Toebehoren & afvoeren | 0753203 | | wit | BA3070NM | stuk | 28,00 | 344 | 0 |
| | 0753211 | | zwart | BA3070NM | stuk | 23,50 | 344 | 1 |
| | deksel voor zitting BA3070NM | | | | | | | |
| | 0753270 | | wit | BA3270NM | stuk | 17,25 | 344 | 0 |
| | 0753289 | | zwart | BA3270NM | stuk | 14,25 | 344 | 1 |
| Spoel- & installatiesystemen | closetzitting dubbel | | | | | | | |
| | 0753238 | m. RVS garnituur | wit | BA3170NMRVS | stuk | 48,00 | 344 | 0 |
| | 0753246 | m. RVS garnituur | zwart | BA3170NMRVS | stuk | 41,00 | 344 | 1 |
| | 0753254 | | wit | BA3170NM | stuk | 44,25 | 344 | 1 |
| | 0753262 | | zwart | BA3170NM | stuk | 38,75 | 344 | 1 |
| Badkamermeubelen en toiletkasten | Rezi Variant | | | | | | | |
| | closetzitting | | | | | | | |
| | 0751162 | enkel | wit | BA3080 | stuk | 18,50 | 344 | 1 |
| | 0751332 | dubbel | wit | BA3180 | stuk | 29,00 | 344 | 1 |
| Utiliteit | Rezi bevestigingsgarnituur | | | | | | | |
| | bevestigingsgarnituur | | | | | | | |
| | 0750840 | per paar kunststof | | BA3310 | paar | 6,00 | 344 | 1 |
| | 0750859 | per paar kunststof | | BA3311 | paar | 6,50 | 344 | 1 |
| | 0751146 | per paar | chroom | BA3369NCHR | paar | 18,75 | 344 | 1 |

| Art.nr | Specificaties | Kleur | Lev.nr | Ehd | Prijs | Grp | CC |
|---|------------------------------|----------|-----------|------|---------|-----|----|
| Douche WC Geberit | | | | | | | |
| doucheWC 4000 zitting m. deksel | | | | | | | |
| 0703435 | m. geïntegreerde onderdouche | wit | 141100111 | stuk | 786,00 | 383 | 1 |
| 0703443 | m. geïntegreerde onderdouche | pergamon | 141100EP1 | stuk | 906,00 | 383 | 1 |
| doucheWC 8000 wandcloset m. zitting m. deksel m. onderdouche, lady douche, | | | | | | | |
| 0712507 | geurafzuiging en föhn | wit | 180100111 | stuk | 3126,00 | 383 | 1 |
| 0712515 | geurafzuiging en föhn | pergamon | 180100EP1 | stuk | 3126,00 | 383 | 1 |
| wateraanluitset voor douchewc 4000 | | | | | | | |
| 0702800 | | | 249801001 | stuk | 89,00 | 329 | 1 |
| mantelbuis voor wateraanluitset doucheWC | | | | | | | |
| 0700122 | | | 242011001 | stuk | 8,90 | 329 | 1 |
| reinigingsmiddel Jetclean v. Balena doucheWC 8000 (400ml) | | | | | | | |
| 0712523 | | | 250028001 | stuk | 15,75 | 383 | 1 |
| koolstoffilter voor Balena doucheWC 8000 | | | | | | | |
| 0712531 | | | 250022001 | stuk | 22,75 | 383 | 1 |
| douche- en föhnkop voor Balena doucheWC 8000 | | | | | | | |
| 0712558 | | | 250031001 | stuk | 26,50 | 383 | 1 |

Sanitair producten

Baden /
douchebakken /
stoomcabines

Kranen

Douchegarnituur

Accessoires en
spiegels

Douchewanden

Toebehoren &
afvoeren

Spoel- &
installatiesystemen

Badkamermeubelen
en toiletkasten

Gootstenen en
wastroggen

Utiliteit

Ons leverprogramma

abusanitair

Kompleet programma beluchters

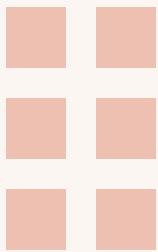

Reservoirs



met dubbele spoeltechniek



met start-stop techniek



WC-zittingen

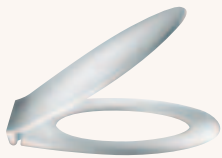

uit thermoplast

met
10 jaar
garantie
op breuk



uit duroplast

Zitje voor bad, douche en wellness

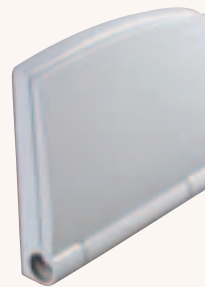

met automatische
tilmogelijkheid

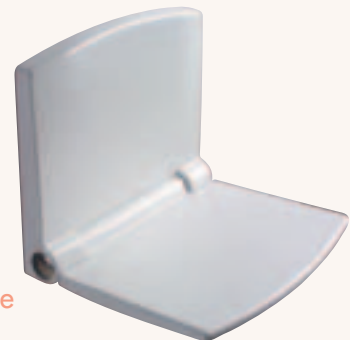

Uitstortgootstenen

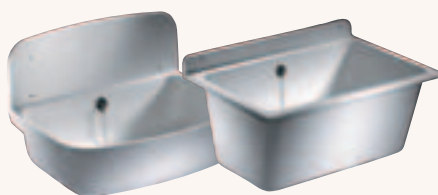

met
10 jaar
garantie
op breuk

WC-aansluitukken

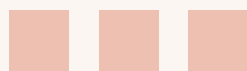

Abu-plast

Kunststoffbetriebe GmbH

www.abu.eu

www.abu.de

| Art.nr | Specificaties | Kleur | Lev.nr | Ehd | Prijs | Grp | CC |
|--|---|----------|-----------|------|--------|-----|----|
| ABU Primus laaghangend reservoir | | | | | | | |
| laaghangend reservoir | | | | | | | |
| 0702161 | | wit | 603901 | stuk | 42,00 | 333 | 1 |
| 0702188 | | pergamon | 603905 | stuk | 54,50 | 333 | 1 |
| ABU Starlet laaghangend reservoir | | | | | | | |
| laaghangend reservoir | | | | | | | |
| 0700770 | 6-9 liter instelbaar | wit | 0700770 | stuk | 38,25 | 333 | 0 |
| 0701211 | 6-9 liter instelbaar | pergamon | 0701211 | stuk | 43,25 | 333 | 0 |
| ABU Delta hoekreservoir | | | | | | | |
| reservoir hoekmodel | | | | | | | |
| 0702056 | | wit | 602401 | stuk | 121,00 | 333 | 0 |
| ABU Onderdelen reservoirs | | | | | | | |
| 0711624 | afdichtring | | 045 | stuk | 0,19 | 353 | 1 |
| 0711640 | bodemventiel compleet Star-Starlet | | 610003 | stuk | 9,90 | 353 | 0 |
| 0711659 | bodemventiel compleet hooghangend reservoir | | 610005 | stuk | 8,60 | 353 | 1 |
| 0710733 | bodemventiel reservoir Star-Starlet | | 610003 | stuk | 8,50 | 353 | 1 |
| 0711349 | deksel m. druktoets nieuw wit | | 610201 | stuk | 15,50 | 353 | 0 |
| 0711403 | deksel m. druktoets oud wit | | 610701 | stuk | 15,50 | 353 | 0 |
| 0711490 | deksel m. druktoets wit | | 610901 | stuk | 21,00 | 353 | 0 |
| 0711462 | druktoets voor Delta/Duo/Star chroom | | 611897 | stuk | 3,43 | 353 | 0 |
| 0711456 | druktoets voor Starlet / Moesel wit | | 611901 | stuk | 3,73 | 353 | 0 |
| 0710202 | druktoets voor Topstar wit | | 612001 | stuk | 4,09 | 353 | 1 |
| 0711519 | glijring voor spoelbocht voor alle reservoirs | | 612804 | stuk | 0,88 | 353 | 1 |
| 0711551 | membraan voor alle reservoirs | | 612808 | stuk | 1,12 | 353 | 0 |
| 0711683 | membraanknop | | 037 | stuk | 0,66 | 353 | 1 |
| 0711705 | ophanggarnituur compleet per paar | | 051052053 | paar | 3,37 | 353 | 0 |
| 0711489 | ring voor bodemventiel voor alle reservoirs | | 612802 | stuk | 1,38 | 353 | 0 |
| 0711527 | rozet voor spoelbocht wit | | 612301 | stuk | 2,94 | 353 | 0 |
| 0711535 | rozet voor spoelbocht kleur | | 612305 | stuk | 3,67 | 353 | 1 |
| 0711500 | spoelbochtring voor laaghangend reservoir | | 612803 | stuk | 1,23 | 353 | 0 |
| 0711365 | flotteurkraan mechanisch Delta/Star | | 610006 | stuk | 7,40 | 353 | 0 |
| 0261211 | flotteur voor Heerlen/Alkmaar | | 794001 | stuk | 13,25 | 353 | 1 |
| 0560006 | beluchter 32mm voor binnenriolering | | 761099 | stuk | 10,50 | 350 | 0 |
| 0560391 | beluchter 40mm voor binnenriolering | | 761199 | stuk | 10,50 | 350 | 0 |



Sanitair producten

Baden /
douchebakken /
stoomcabines

Kranen

Douchegarnituur

Accessoires en
spiegels

Douchewanden

Toebehoren &
afvoerenSpoel- &
installatiesystemenBadkamermeubelen
en toiletkastenGootstenen en
wastroggen

Utiliteit

| | Art.nr | Specificaties | Kleur | Lev.nr | Ehd | Prijs | Grp | CC | |
|---|--|---|---|-----------|-----------|--------|-------|-----|---|
| Sanitair producten | Geberit hooghangend reservoir | | | | | | | | |
| | | hooghangend reservoir m. deksel | | | | | | | |
| | 0701718 | | wit | 123700111 | stuk | 85,00 | 328 | 0 | |
| Baden / douchebakken / stoomcabines | Geberit Project laaghangend reservoir | | | | | | | | |
| | | laaghangend reservoir | | | | | | | |
| | 0701459 | | wit | 123105111 | stuk | 70,50 | 328 | 0 | |
| Kranen | Geberit Jadi | | | | | | | | |
| | | laaghangend reservoir 6liter | | | | | | | |
| | 0701460 | | | 136455111 | stuk | 46,50 | 328 | 1 | |
| Douchegarnituur | Geberit Twico | | | | | | | | |
| | | laaghangend reservoir m. 2-delige bedieningsknop | | | | | | | |
| | 0702994 | | wit | 140317111 | stuk | 80,50 | 328 | 0 | |
| | 0702996 | | pergamon | 140317EP1 | stuk | 98,00 | 328 | 0 | |
| | 0703025 | | beige | 140317101 | stuk | 98,00 | 328 | 1 | |
| Toebehoren & afvoeren | laaghangend reservoir m. 2-delige bedieningsknop m. dekselbeveiliging | | | | | | | | |
| | | | | | | | | | |
| | 0703087 | | wit | 140314112 | stuk | 94,00 | 328 | 0 | |
| Spoel- & installatiesystemen | Geberit Toebehoren hangend reservoir | | | | | | | | |
| | | | | | | | | | |
| | 0711150 | spoelbocht 44 m. lijmmof 90° | wit | 118011111 | stuk | 12,75 | 329 | 1 | |
| | 0711153 | spoelbocht 44 m. lijmmof 45° | wit | 118020111 | stuk | 17,00 | 329 | 1 | |
| Badkamermeubelen en toiletkasten | | 0711155 | spoelbocht 44 m. lijmmof 135° | wit | 118021111 | stuk | 17,00 | 329 | 1 |
| | | 0711160 | spoelbocht 50x44mm 90° | wit | 118003111 | stuk | 8,10 | 353 | 0 |
| | 0700297 | spoelbocht 50x44mm 90° | pergamon | 118003EP1 | stuk | 10,50 | 328 | 1 | |
| Gootstenen en wastroggen | | 0711179 | spoelbocht laaghangend reservoir 50x44mm 90° | lang wit | 118006111 | stuk | 17,75 | 353 | 0 |
| | | 0710296 | spoelbocht kunststof m. sprong | wit | 118005111 | stuk | 18,25 | 328 | 1 |
| Utiliteit | | 0710466 | aansluitgarnituur | wit | 118026111 | stuk | 12,25 | 328 | 1 |
| | | 0711780 | spoelbocht 90° halfhoge reservoirs 123/140 m. bevest. | wit | 118100111 | stuk | 39,75 | 353 | 0 |
| | 0710468 | spoelbocht 90 m. sprong rechts | wit | 118114111 | stuk | 16,00 | 353 | 1 | |
| | 0705529 | spoelbocht verlengbuis | wit | 118133111 | stuk | 12,75 | 328 | 1 | |
| | 0705564 | spoelbocht PE 50/45 | | 118210161 | stuk | 25,25 | 329 | 1 | |
| | 0705562 | spoelbocht 90° | wit | 119610111 | stuk | 9,70 | 329 | 1 | |
| | 0705565 | spoelbocht PE inbouw | | 119611161 | stuk | 72,50 | 329 | 1 | |
| | 0711499 | wandclosetaansluiting | horizontaal 90/90 | 366887161 | stuk | 18,50 | 328 | 0 | |
| | 2200563 | wandclosetaansluiting | horizontaal 110/90 | 367887161 | stuk | 19,50 | 328 | 0 | |
| | 2200452 | gummidichting manchet | 90mm | 387282001 | stuk | 1,67 | 329 | 1 | |
| | 2200451 | speciaal verhogingsset | | 405116001 | stuk | 104,00 | 329 | 0 | |
| | 0710870 | steekverbinder Euronorm | | 119668001 | stuk | 4,37 | 328 | 0 | |
| | 0710244 | ombouwset voor wateraansluiting middenachter | voor reservoir 123.xxx | | 115427001 | stuk | 19,25 | 328 | 1 |
| Geberit inbouwreservoir | inbouwreservoir 6/3 liter | | | | | | | | |
| | | | | | | | | | |
| | 0703966 | | | 109300001 | stuk | 146,00 | 329 | 1 | |

| Art.nr | Specificaties | Kleur | Lev.nr | Ehd | Prijs | Grp | CC |
|--------|---------------|-------|--------|-----|-------|-----|----|
|--------|---------------|-------|--------|-----|-------|-----|----|

Geberit Kombifix inbouwreservoir

wc-element Project H108

| | | | | | | | |
|---------|-----------------------------------|--|-----------|------|--------|-----|---|
| 0703974 | m. reservoir UP300 frontbediening | | 110355001 | stuk | 175,00 | 329 | 0 |
|---------|-----------------------------------|--|-----------|------|--------|-----|---|



Sanitair producten

wc-element Super H108

| | | | | | | | |
|---------|-----------------------------------|--|-----------|------|--------|-----|---|
| 0703605 | m. reservoir UP300 frontbediening | | 110373001 | stuk | 183,00 | 329 | 0 |
|---------|-----------------------------------|--|-----------|------|--------|-----|---|

Baden /
douchebakken /
stoomcabines

Kranen

wc-element H98

| | | | | | | | |
|---------|--|--|-----------|------|--------|-----|--|
| 0700112 | m. reservoir UP200 planchet- of frontbediening | | 110257001 | stuk | 246,00 | 329 | |
|---------|--|--|-----------|------|--------|-----|--|

Douchegarnituur

urinoir element z. sturing

| | | | | | | | |
|---------|--|--|-----------|------|--------|-----|---|
| 0710273 | | | 457685001 | stuk | 209,00 | 328 | 1 |
|---------|--|--|-----------|------|--------|-----|---|

Accessoires en
spiegels**bidet-element**

| | | | | | | | |
|---------|--|--|-----------|------|--------|-----|---|
| 0700673 | | | 457893001 | stuk | 117,00 | 329 | 1 |
|---------|--|--|-----------|------|--------|-----|---|

Douchewanden

wastafelement

| | | | | | | | |
|---------|--|--|-----------|------|--------|-----|---|
| 0700077 | | | 457410001 | stuk | 102,00 | 329 | 1 |
|---------|--|--|-----------|------|--------|-----|---|

stelpoten voor inbouwreservoir licht model per paar

| | | | | | | | |
|---------|--|--|-----------|------|-------|-----|---|
| 0701335 | | | 457888261 | paar | 25,00 | 329 | 0 |
|---------|--|--|-----------|------|-------|-----|---|

Toebehoren &
afvoeren**stelpoten voor inbouwreservoir zwaar model per paar**

| | | | | | | | |
|---------|--|--|-----------|------|-------|-----|---|
| 0703141 | | | 457872261 | paar | 45,75 | 329 | 0 |
|---------|--|--|-----------|------|-------|-----|---|

verlenggarnituur

| | | | | | | | |
|---------|--|--|-----------|------|-------|-----|---|
| 0701831 | | | 240058001 | stuk | 15,75 | 328 | 0 |
|---------|--|--|-----------|------|-------|-----|---|

Spoel- &
installatiesystemen

Geberit Sanbloc inbouwreservoir

wc-element H110

| | | | | | | | |
|---------|-----------------------------------|--|-----------|------|--------|-----|---|
| 0710231 | m. reservoir UP300 frontbediening | | 440305001 | stuk | 354,00 | 328 | 1 |
|---------|-----------------------------------|--|-----------|------|--------|-----|---|

wc-element H110 m. vloersteunen

| | | | | | | | |
|---------|-----------------------------------|--|-----------|------|--------|-----|---|
| 0703656 | m. reservoir UP300 frontbediening | | 440309001 | stuk | 374,00 | 329 | 0 |
|---------|-----------------------------------|--|-----------|------|--------|-----|---|

Badkamermeubelen
en toiletkastenGootstenen en
wastroggen

Utiliteit

wc-element H110 m. vloersteunen voor Balena doucheWC

| | | | | | | | |
|---------|-----------------------------------|--|-----------|------|--------|-----|---|
| 0703340 | m. reservoir UP300 frontbediening | | 440302001 | stuk | 374,00 | 329 | 1 |
|---------|-----------------------------------|--|-----------|------|--------|-----|---|

wc-element H114 m. vloersteunen uitvoering FS90

| | | | | | | | |
|---------|-----------------------------------|--|-----------|------|--------|-----|---|
| 0710232 | m. reservoir UP300 frontbediening | | 440312001 | stuk | 600,00 | 328 | 1 |
|---------|-----------------------------------|--|-----------|------|--------|-----|---|

wc-element H83 m. reservoir UP200

| | | | | | | | |
|---------|--------------------------------|--|-----------|------|--------|-----|---|
| 0700113 | m. planchet- of frontbediening | | 440242001 | stuk | 414,00 | 329 | 1 |
|---------|--------------------------------|--|-----------|------|--------|-----|---|

urinoir-element H122 m. vloersteunen universeel z. urinoirsturing

| | | | | | | | |
|---------|--|--|-----------|------|--------|-----|---|
| 0703148 | | | 440650001 | stuk | 590,00 | 329 | 1 |
|---------|--|--|-----------|------|--------|-----|---|

urinoir-element H122 m. vloersteunen universeel 2 z. urinoirsturing

| | | | | | | | |
|---------|---------------------|--|-----------|------|--------|-----|---|
| 0700065 | v. V&B urinoir Ebra | | 440660001 | stuk | 590,00 | 329 | 1 |
|---------|---------------------|--|-----------|------|--------|-----|---|



bidet-element m. vloersteunen

| | | | | | | | |
|---------|--|--|-----------|------|--------|-----|---|
| 0703151 | | | 440500001 | stuk | 478,00 | 329 | 1 |
|---------|--|--|-----------|------|--------|-----|---|

wastafel-element H110 m. vloersteunen voor 1-gatsmengkraan

| | | | | | | | |
|---------|--|--|-----------|------|--------|-----|---|
| 0700063 | | | 440400001 | stuk | 370,00 | 329 | 1 |
|---------|--|--|-----------|------|--------|-----|---|



| | Art.nr | Specificaties | Kleur | Lev.nr | Ehd | Prijs | Grp | CC |
|---|---|---|-------|-----------|------|--------|-----|----|
| | Geberit Sanbloc inbouwreservoir | | | | | | | |
| Sanitair producten | 0700064 | wastafel-element H110 m. vloersteunen voor 1-gats mengkraan m. inbouwsifon | | 440410001 | stuk | 438,00 | 329 | 1 |
| | 0703344 | bevestigingsset voor armsteunen, handgrepen en douchezitjes | | 440800001 | stuk | 88,00 | 329 | 1 |
| Baden / douchebakken / stoomcabines | 0710247 | beugel voor afvoerbocht | | 240540001 | stuk | 6,80 | 328 | 1 |
| | Geberit Toebehoren inbouwreservoir | | | | | | | |
| Kranen | 0703210 | infraroodsturing voor inbouwreservoir | | 115516001 | stuk | 801,00 | 383 | 1 |
| | 0700738 | geluids-isolatieset voor wandbidet en wandcloset | | 156050001 | stuk | 12,25 | 328 | 0 |
| | 0711225 | aansluitgarnituur PE m. afdichtrubber 90mm 10cm | | 152441461 | stuk | 35,25 | 328 | 0 |
| Douchegarnituur | 0710989 | aansluitgarnituur PE 90mm | | 152426461 | stuk | 26,25 | 328 | 0 |
| | 0710448 | aansluitgarnituur wandcloset 110mm | | 152439461 | stuk | 35,25 | 328 | 1 |
| | 0710458 | overgangsstuk PE/PVC 90x110mm | | 152465001 | stuk | 9,50 | 328 | 0 |
| | 0710512 | aansluitgarnituur PE m. afdichtrubber 90mm | | 152487461 | stuk | 15,25 | 328 | 0 |
| Accessoires en spiegels | 0712620 | aansluitgarnituur PE | | 152404461 | stuk | 30,75 | 328 | 1 |
| | 0705567 | gummimanchet | | 152424001 | stuk | 4,99 | 329 | 1 |
| | 0705568 | O-ring voor inbouwreservoir 45mm | | 362771001 | stuk | 1,95 | 329 | 0 |
| | 0705569 | O-ring voor inbouwreservoir 32mm | | 362790001 | stuk | 1,95 | 329 | 1 |
| | Geberit Duofix elementen | | | | | | | |
| Douchewanden | 0703613 | wc-element H112 m. reservoir UP300 frontbediening | | 111304001 | stuk | 222,00 | 329 | 0 |
| Toebehoren & afvoeren |  | wc-element H112 v. systeemwanden m. reservoir UP300 frontbediening | | 111308001 | stuk | 248,00 | 329 | 0 |
| Spoel- & installatiesystemen | | wc-hoekelement H112 m. reservoir UP300 frontbediening | | 111393001 | stuk | 417,00 | 329 | 0 |
| Badkamermeubelen en toiletkasten | 0703990 | wc-element H112 verstelbare closet hoogte m. reservoir UP300 frontbediening | | 111350001 | stuk | 301,00 | 329 | 0 |
| Gootstenen en wastroggen | 0700119 | wc-element verstelbare closet hoogte m. reservoir UP300 frontbediening | | 111396001 | stuk | 353,00 | 329 | 0 |
| Utiliteit | 0704180 | wc-element H112 v. Balena doucheWC m. reservoir UP300 frontbediening | | 111325001 | stuk | 252,00 | 329 | 1 |
| | 0700118 | wc-element H112 v. systeemwanden m. Powerflush reservoir frontbediening | | 111165001 | stuk | 508,00 | 329 | 0 |
| | 0700121 | afdekplaat v. Powerflush | rvs | 115396001 | stuk | 60,00 | 329 | 0 |
| | 0703986 | wc-element H98 m. reservoir U0200 m. planchet- of frontbediening | | 111293001 | stuk | 287,00 | 329 | 0 |
| | 0703985 | wc-element H82 m. reservoir UP200 m. planchet- of frontbediening | | 111244001 | stuk | 287,00 | 329 | 0 |
| |  | wc-element ruimtebesparend H112 + UP700 | | 111765001 | stuk | 407,00 | 329 | 0 |

| Art.nr | Specificaties | Kleur | Lev.nr | Ehd | Prijs | Grp | CC | |
|---------------------------------|--------------------------------------|-------|-----------|-----------|--------|--------|-----|---|
| Geberit Duofix elementen | | | | | | | | |
| urinoir-element H112 | | | | | | | | |
| 0710282 | v. pneumatisch / infrarood sturing | | 111685001 | stuk | 230,00 | 329 | 0 | Sanitair producten |
| 0704873 | v. Joly / Visit | | 111637001 | stuk | 264,00 | 329 | 1 | |
| bidet-element H112 | | | | | | | | |
| 0704016 | | | 111511001 | stuk | 167,00 | 329 | 0 | Baden / douchebakken / stoomcabines |
| bidet-element H98 | | | | | | | | |
| 0700116 | | | 111538001 | stuk | 141,00 | 329 | 1 | |
| bidet-element H82 | | | | | | | | |
| 0700044 | | | 111517001 | stuk | 137,00 | 329 | 1 | Kranen |
| wastafel-element H130 | | | | | | | | |
| 0700042 | v. wandarmatuur | | 111422001 | stuk | 137,00 | 329 | 1 | Douchegarnituur |
| wastafel-element H112 | | | | | | | | |
| 0710230 | v. opbouw wastafelkraan | | 111434001 | stuk | 110,00 | 328 | 1 | |
| wastafelement H112 | | | | | | | | |
| 0700043 | v. inbouwsifon | | 111460001 | stuk | 180,00 | 329 | 1 | Accessoires en spiegels |
| bad/douche-element H112 | | | | | | | | |
| 0704024 | v. inbouw bad-/douchekraan | | 111780001 | stuk | 135,00 | 329 | 1 | Douchewanden |
| montage-element H112 | | | | | | | | |
| 0704032 | v. montage steunen, grepen en zitjes | | | 111790001 | stuk | 148,00 | 329 | Toebehoren & afvoeren |
| 1 | | | | | | | | |







| | | | | | | | | |
|----------------------------------|---|--|-----------|------|-------|-----|---|---------------------------------|
| Geberit Duofix Toebehoren | | | | | | | | |
| 0705570 | wandclosetbocht | | 366061161 | stuk | 18,25 | 329 | 1 | Spoel- & installatiesystemen |
| 0700689 | systeemrail 30cm | | 111878001 | stuk | 38,50 | 329 | 1 | |
| 0700682 | bevestigingsset voorzetwand | | 111844001 | stuk | 24,50 | 329 | 1 | |
| 0700683 | staander H82-130 voor voorzetwand | | 111830001 | stuk | 61,50 | 329 | 1 | |
| 0700684 | staander ruimtehoog 220-280cm | | 111831001 | stuk | 61,50 | 329 | 1 | |
| 0700685 | staander ruimtehoog 260-320cm | | 111833001 | stuk | 61,50 | 329 | 1 | |
| 0700686 | staander ruimtehoog 330-360cm | | 111836001 | stuk | 70,00 | 329 | 1 | |
| 0710335 | railclip | | 240692001 | stuk | 2,42 | 328 | 1 | |
| 0704040 | bevestigingsset voor voorzetwandmontage | | 111804001 | stuk | 29,00 | 329 | 0 | |
| 0704059 | bevestigingsset voor hoekmontage | | 111835001 | stuk | 15,25 | 329 | 0 | |

| | | | | | | | | |
|-----------------------------------|--|-----------------|-----------|------|--------|-----|---|-----------------------------|
| Geberit Bolero afdekplaten | | | | | | | | |
| bedieningsplaat | | | | | | | | |
| 0710252 | | wit | 115777111 | stuk | 47,75 | 329 | 0 | Gootstenen en wastroggen |
| 0710254 | | glans chroom | 115777211 | stuk | 62,00 | 329 | 0 | |
| 0710255 | | matchroom | 115777461 | stuk | 62,00 | 329 | 0 | |
| 0710261 | | edelweiss | 115777DK1 | stuk | 77,50 | 329 | 1 | |
| 0710262 | | messaging | 115777DT1 | stuk | 335,00 | 329 | 1 | |
| 0710264 | | pergamon | 115777EP1 | stuk | 53,50 | 329 | 0 | |
| 0710270 | | starwhite | 115777FR1 | stuk | 53,50 | 329 | 1 | |
| 0710271 | | satinox | 115777GM1 | stuk | 217,00 | 329 | 1 | |
| 0710272 | | chrom/structuur | 115777KB1 | stuk | 112,00 | 329 | 1 | |

| | | | | | | | | |
|---------------------------|-------------|-----|-----------|------|-------|-----|---|--|
| Geberit afdekplaat | | | | | | | | |
| afdekplaat | | | | | | | | |
| 0703520 | 24.6x16.4cm | wit | 115765111 | stuk | 47,00 | 329 | 1 | |

| | | | | | | | | |
|---|--|-------------|-----------|------|-------|-----|---|---|
| Geberit Kappa afdekplaten | | | | | | | | |
| afdekplaat front-planchetbediening | | | | | | | | |
| 0703987 | | wit | 115228111 | stuk | 40,75 | 329 | 0 |  |
| 0703991 | | glanschroom | 115228211 | stuk | 53,00 | 329 | 0 | |
| 0703992 | | matchroom | 115228461 | stuk | 53,00 | 329 | 0 | |
| 0703993 | | pergamon | 115228EP1 | stuk | 41,25 | 329 | 0 | |

| | | | | | | | | |
|---|--|-----|-----------|------|-------|-----|---|--|
| 50 afdekplaat front-/planchetbediening | | | | | | | | |
| 0703995 | | RVS | 115258001 | stuk | 90,00 | 329 | 1 | |

| | Art.nr | Specificaties | Kleur | Lev.nr | Ehd | Prijs | Grp | CC | | |
|---|---|--|---|------------------------|---------------|-----------|--------|--------|-----|---|
| Sanitair producten | Geberit Mambo afdekplaten | | | | | | | | | |
| |  | afdekplaat frontbediening 0704482 | | RVS | 115751001 | stuk | 88,50 | 329 | 0 | |
| Baden / douchebakken / stoomcabines | | blindplaat 24.6x16.4cm 0704490 | | RVS | 115798001 | stuk | 80,50 | 329 | 1 | |
| | Kranen | | HyTronic wc-stuursysteem v. reservoir UP Powerflush 0700120 | excl. netspanningsdeel | RVS | 115892001 | stuk | 385,00 | 383 | 1 |
| Douchegarnituur | | Geberit Rumba afdekplaten | | | | | | | | |
| |  | afdekplaat 0703451 | spoel/stop | wit | 115750111 | stuk | 40,75 | 329 | 0 | |
| | | 0703478 | spoel/stop | pergamon | 115750EP1 | stuk | 41,25 | 329 | 0 | |
| | | 0703486 | spoel/stop | glans chroom | 115750211 | stuk | 53,00 | 329 | 0 | |
| | | 0703494 | spoel/stop | matchroom | 115750461 | stuk | 53,00 | 329 | 0 | |
| | | 0703877 | spoel/stop | klassiek wit | 115750FE1 | stuk | 41,25 | 329 | 1 | |
| Accessoires en spiegels | | 0703885 | spoel/stop | satinox | 115750GM1 | stuk | 167,00 | 329 | 1 | |
| | Douchewanden | Geberit Samba afdekplaten | | | | | | | | |
|  | | afdekplaat 0703532 | 2-knops | wit | 115770111 | stuk | 40,75 | 329 | 0 | |
| | | 0703540 | 2-knops | pergamon | 115770EP1 | stuk | 41,25 | 329 | 0 | |
| | | 0703559 | 2-knops | glans chroom | 115770211 | stuk | 53,00 | 329 | 0 | |
| | | 0703567 | 2-knops | matchroom | 115770461 | stuk | 53,00 | 329 | 0 | |
| Toebehoren & afvoeren | | | 0703915 | 2-knops | klassiek wit | 115770FE1 | stuk | 41,25 | 329 | 1 |
| | | | 0703923 | 2-knops | satinox | 115770GM1 | stuk | 167,00 | 329 | 0 |
| | | | 0703924 | 2-knops | glans/matchr. | 115770KB1 | stuk | 86,00 | 329 | 0 |
| | | | 0703930 | 2-knops | starwhite | 115770FR1 | stuk | 41,25 | 329 | 1 |
| Spoel- & installatiesystemen | | Geberit Tango afdekplaten | | | | | | | | |
| |  | afdekplaat 0703508 | spoel/stop | wit | 115760111 | stuk | 100,00 | 329 | 0 | |
| | | 0703510 | spoel/stop | pergamon | 115760EP1 | stuk | 100,00 | 329 | 1 | |
| | Badkamermeubelen en toiletkasten | | 0703524 | spoel/stop | matchroom | 115760461 | stuk | 100,00 | 329 | 0 |
| | | | 0703893 | spoel/stop | satinox | 115760GM1 | stuk | 221,00 | 329 | 1 |
| | | | 0703907 | spoel/stop | RVS-look | 115760HC1 | stuk | 221,00 | 329 | 0 |
| | | 0704105 | spoel/stop | glanschroom | 115760211 | stuk | 100,00 | 329 | 0 | |
| Gootstenen en wastroggen | Geberit Twist afdekplaten | | | | | | | | | |
| |  | afdekplaat 0703575 | 2-knops | wit | 115780111 | stuk | 100,00 | 329 | 0 | |
| | | 0703580 | 2-knops | pergamon | 115780EP1 | stuk | 100,00 | 329 | 0 | |
| | Utiliteit | | 0703591 | 2-knops | matchroom | 115780461 | stuk | 100,00 | 329 | 0 |
| | | | 0703958 | 2-knops | RVS-look | 115780HC1 | stuk | 221,00 | 329 | 0 |
| | | | 0703583 | 2-knops | glans chroom | 115780211 | stuk | 100,00 | 329 | 0 |
| | | 0703931 | 2-knops | satinox | 115780GM1 | stuk | 221,00 | 329 | 1 | |
| | 0703955 | 2-knops | chr./matchr. | 115780KA1 | stuk | 138,00 | 329 | 1 | | |
| | Geberit Artline afdekplaten | | | | | | | | | |
| |  | afdekplaat 0703192 | voor front-/planchetbediening | wit | 115666111 | stuk | 37,75 | 329 | 1 | |
| | | 0703206 | voor front-/planchetbediening | pergamon | 115666EP1 | stuk | 38,25 | 329 | 1 | |
| | | 0703214 | voor front-/planchetbediening | klassiek wit | 115666FE1 | stuk | 65,00 | 329 | 1 | |
| | | 0703230 | voor front-/planchetbediening | glans chroom | 115666211 | stuk | 65,00 | 329 | 1 | |
| | | 0703249 | voor front-/planchetbediening | matchroom | 115666461 | stuk | 47,75 | 329 | 1 | |
| Geberit Toebehoren afdekplaten | | | | | | | | | | |
| | 0704067 | onderbrekingshevel | | 240933001 | stuk | 1,65 | 329 | 1 | | |
| | 0704075 | stelschroef per paar | | 240936001 | stuk | 4,95 | 329 | 1 | | |
| | 0704083 | verlengset bedieningsplaat | | 240938001 | stuk | 17,50 | 329 | 0 | | |
| | 0704091 | adapterset v. ombouw bedieningsplaat Artline front v. 24x18cm n. 21.2x13cm | | | 240962001 | stuk | 44,25 | 329 | 0 | |
| | 0703989 | ombouwset van Kappa naar Artline afdekplaat | | 240633001 | stuk | 30,75 | 329 | 0 | | |

| Art.nr | Specificaties | Kleur | Lev.nr | Ehd | Prijs | Grp | CC |
|--------|---------------|-------|--------|-----|-------|-----|----|
|--------|---------------|-------|--------|-----|-------|-----|----|

Geberit Samba urinoirbediening

UR20 afbouwset urinoir pneumatische bediening

| | | | | | | | |
|---------|--|-----------|-----------|------|--------|-----|---|
| 0701808 | | wit | 115819111 | stuk | 122,00 | 329 | 0 |
| 0701809 | | chroom | 115819211 | stuk | 122,00 | 329 | 0 |
| 0701810 | | matchroom | 115819461 | stuk | 122,00 | 329 | 0 |
| 0701811 | | pergamon | 115819EP1 | stuk | 140,00 | 329 | 0 |

afdekplaat voor urinoir pneumatische bediening

| | | | | | | | |
|---------|--|-----------|-----------|------|-------|-----|---|
| 0701812 | | wit | 241319111 | stuk | 61,50 | 329 | 1 |
| 0701813 | | chroom | 241319211 | stuk | 61,50 | 329 | 1 |
| 0701814 | | matchroom | 241319461 | stuk | 61,50 | 329 | 1 |
| 0701815 | | pergamon | 241319EP1 | stuk | 64,50 | 329 | 1 |

Geberit urinoirbediening

UR20 pneumatisch afbouwset urinoir handbediening

| | | | | | | | |
|---------|--|-----|-----------|------|--------|-----|---|
| 0700038 | | wit | 115808111 | stuk | 122,00 | 329 | 0 |
|---------|--|-----|-----------|------|--------|-----|---|

UR50 afbouwset voor urinoir 230V

| | | | | | | | |
|---------|--|-----------|-----------|------|--------|-----|---|
| 0701830 | | matchroom | 115817461 | stuk | 284,00 | 383 | 1 |
| 0701835 | | wit | 115817111 | stuk | 284,00 | 383 | 1 |

UR20 pneumatisch afbouwset urinoir handbediening

| | | | | | | | |
|---------|--|----------|-----------|------|--------|-----|---|
| 0701816 | | chroom | 115808211 | stuk | 122,00 | 329 | 1 |
| 0701817 | | pergamon | 115808EP1 | stuk | 140,00 | 329 | 1 |
| 0700934 | | edelmat | 115808461 | stuk | 122,00 | 329 | 1 |

UR21 pneumatisch afbouwset urinoir voetbediening

| | | | | | | | |
|---------|--|--|-----------|------|--------|-----|---|
| 0700013 | | | 115809111 | stuk | 163,00 | 329 | 1 |
|---------|--|--|-----------|------|--------|-----|---|

Mambo UR22 afbouwset urinoir pneumatische bediening

| | | | | | | | |
|---------|--|-----|-----------|------|--------|-----|---|
| 0700054 | | RVS | 115828001 | stuk | 122,00 | 329 | 0 |
|---------|--|-----|-----------|------|--------|-----|---|

Mambo UR61 infrarood afbouwset urinoir 230V

| | | | | | | | |
|---------|--|--|-----------|------|--------|-----|---|
| 0700051 | | | 115825001 | stuk | 298,00 | 383 | 1 |
|---------|--|--|-----------|------|--------|-----|---|

Mambo UR61 infrarood afbouwset urinoir 9V batterij

| | | | | | | | |
|---------|--|-----|-----------|------|--------|-----|---|
| 0700052 | | RVS | 115826001 | stuk | 298,00 | 383 | 1 |
|---------|--|-----|-----------|------|--------|-----|---|

infrarood wastafelkraan m. temperatuurregeling

| | | | | | | | |
|---------|--|-----------|-----------|------|--------|-----|---|
| 0700049 | | chroom | 115723211 | stuk | 324,00 | 383 | 1 |
| 0700081 | | palladium | 115712HC1 | stuk | 366,00 | 383 | 1 |

infrarood wastafelkraan z. draaiknop 230V

| | | | | | | | |
|---------|--|--------|-----------|------|--------|-----|---|
| 0700085 | | chroom | 115724211 | stuk | 318,00 | 383 | 1 |
|---------|--|--------|-----------|------|--------|-----|---|

infrarood wastafelkraan z. draaiknop

| | | | | | | | |
|---------|--|--------|-----------|------|--------|-----|---|
| 0700050 | | chroom | 115725211 | stuk | 300,00 | 383 | 1 |
|---------|--|--------|-----------|------|--------|-----|---|

Geberit pneumatische bediening

pneumatisch handdrukker wandopbouw

| | | | | | | | |
|---------|--|-----|-----------|------|-------|-----|---|
| 0700908 | | wit | 115940111 | stuk | 39,50 | 328 | 0 |
|---------|--|-----|-----------|------|-------|-----|---|



pneumatisch handdrukker bevestiging op armsteunen

| | | | | | | | |
|---------|--|-----|-----------|------|-------|-----|---|
| 0704385 | | RVS | 115914001 | stuk | 95,50 | 328 | 1 |
|---------|--|-----|-----------|------|-------|-----|---|

inbouw handdrukker pneumatisch

| | | | | | | | |
|---------|--|--------|-----------|------|-------|-----|---|
| 0700910 | | wit | 115941111 | stuk | 48,75 | 328 | 1 |
| 0700909 | | chroom | 115941KA1 | stuk | 57,00 | 328 | 1 |

Geberit elektrische bediening reservoirs

WC61 infrarood stuursysteem m. bedieningsplaat Mambo

| | | | | | | | |
|---------|--|-----|-----------|------|--------|-----|---|
| 0710275 | | RVS | 115890001 | stuk | 385,00 | 383 | 1 |
|---------|--|-----|-----------|------|--------|-----|---|

WC61B infrarood stuursysteem m. bedieningsplaat Mambo m. batterij

| | | | | | | | |
|---------|--|-----|-----------|------|--------|-----|---|
| 0710276 | | RVS | 115891001 | stuk | 385,00 | 383 | 1 |
|---------|--|-----|-----------|------|--------|-----|---|

ruwbouwset wc-sturing m. adapter

| | | | | | | | |
|---------|--|--|-----------|------|-------|-----|---|
| 0704050 | | | 115861001 | stuk | 39,75 | 329 | 1 |
|---------|--|--|-----------|------|-------|-----|---|

Geberit reservoir Onderdelen

| | | | | | | | |
|---------|----------------|--|-----------|------|--------|-----|---|
| 0703235 | electromagneet | | 115497001 | stuk | 244,00 | 353 | 1 |
|---------|----------------|--|-----------|------|--------|-----|---|

| | Art.nr | Specificaties | Kleur | Lev.nr | Ehd | Prijs | Grp | CC |
|---|-------------------------------------|--|-------|-----------|------|-------|-----|----|
| | Geberit reservoir Onderdelen | | | | | | | |
| Sanitair producten | 0710873 | gummimanchet inlaatgarnituur 152489 | | 119678111 | stuk | 6,80 | 328 | 1 |
| | 0710954 | doorstroombegrenzer voor valpijp | | 214055001 | stuk | 4,59 | 328 | 1 |
| | 0710156 | bodemventielhouder compleet | | 215026111 | stuk | 18,25 | 328 | 1 |
| Baden / douchebakken / stoomcabines | 0711055 | deksel voor reservoir 125001/125080 wit | | 215275111 | stuk | 46,00 | 328 | 1 |
| | 0712175 | druktoets chrom | | 215362001 | stuk | 6,30 | 328 | 1 |
| | 0710245 | flotteurkraan compact | | 215419001 | stuk | 30,00 | 328 | 0 |
| | 0710000 | deksel voor 127.xxx wit | | 215430111 | stuk | 28,00 | 328 | 1 |
| | 0711001 | afdekrozet wit | | 217713111 | stuk | 4,49 | 328 | 1 |
| Kranen | 0711002 | afdekrozet verchromd | | 217713461 | stuk | 4,49 | 328 | 1 |
| | 0705549 | verbindingsstuk wit | | 218536111 | stuk | 4,41 | 328 | 1 |
| | 0710330 | ombouwset voor middenachteraansluiting | | 240017001 | stuk | 13,50 | 328 | 1 |
| | 0700033 | stopje voor bodemventiel | | 240031001 | stuk | 1,31 | 329 | 1 |
| | 0705557 | afstandhouder voor inbouwreservoir | | 240067001 | stuk | 1,43 | 328 | 0 |
| Douchegarnituur | 0711483 | stelschroef voor inbouwreservoir | | 240074001 | stuk | 1,98 | 328 | 0 |
| | 0711583 | houder compleet enkel voor bediening | | 240076001 | stuk | 7,90 | 329 | 1 |
| | 0711586 | flotteurkraan | | 240077001 | stuk | 64,00 | 328 | 1 |
| | 0717184 | bodemventiel universeel | | 240113001 | stuk | 36,00 | 328 | 1 |
| Accessoires en spiegels | 0717183 | bodemventiel voor inbouwreservoir | | 240114001 | stuk | 40,25 | 328 | 1 |
| | 0711488 | afdichting voor reservoir 123xxx / 130xxx | | 240139001 | stuk | 2,62 | 328 | 0 |
| | 0711460 | deksel voor 123105 wit | | 240151111 | stuk | 25,50 | 328 | 1 |
| | 0711485 | dichtset voor flotteurkraan 215419 | | 240182001 | stuk | 8,90 | 328 | 1 |
| | 0714580 | bedieningshendel 130xxx | | 240246001 | stuk | 1,97 | 328 | 1 |
| Douchewanden | 0701489 | middenachter aansluiting voor 1403xx | | 240297001 | stuk | 18,50 | 329 | 1 |
| | 0700106 | valpijpmoer + dichting voor 1403xx | | 240431111 | stuk | 4,59 | 328 | 1 |
| | 0700111 | ombouwset pneumatische bediening | | 240475001 | stuk | 24,75 | 328 | 1 |
| | 0703334 | beschermplaat voor Twinline | | 240512001 | stuk | 11,75 | 329 | 1 |
| Toebehoren & afvoeren | 0702861 | ombouwset voor Twico | | 240515001 | stuk | 51,00 | 329 | 1 |
| | 0520214 | pneumatisch hefmechanisme | | 240573001 | stuk | 13,75 | 328 | 1 |
| | 0710331 | verbindingsbuis voor montage inbouwreservoir | | 240710001 | stuk | 13,50 | 328 | 1 |
| | 0710329 | excentrische aansluiting voor flotteur | | 240711001 | stuk | 5,70 | 328 | 0 |
| | 0710328 | flotteurkraan Unifill | | 240714001 | stuk | 21,50 | 328 | 0 |
| Spoel- & installatiesystemen | 0710246 | druktoets voor Twico binnenwerk | | 261200001 | stuk | 4,11 | 328 | 1 |
| | 0702865 | afdichtingrubber per stuk | | 292878001 | stuk | 1,31 | 329 | 0 |
| | 0701805 | badonderstelplaten 20x30cm | | 350065001 | stuk | 12,00 | 467 | 1 |
| | 0711573 | bedieningshendel voor 127007 | | 813759111 | stuk | 1,97 | 328 | 1 |
| Badkamermeubelen en toiletkasten | 0711144 | afdichtrubber | | 816179001 | stuk | 1,65 | 328 | 0 |
| | 0711578 | afdichtingsrubber per stuk | | 816418001 | stuk | 1,65 | 328 | 0 |
| | 0710229 | bedieningsgarnituur | | 816768001 | stuk | 6,80 | 328 | 1 |
| | 0711480 | Twico bodemventiel compleet | | 240501001 | stuk | 43,40 | 329 | 1 |
| | 0710233 | bodemventiel voor 125920 | | 816969001 | stuk | 43,50 | 328 | 1 |
| Gootstenen en wastroggen | 0710004 | bodemventiel voor 130xxx | | 890095001 | stuk | 36,00 | 328 | 1 |
| | 0711802 | bodemventiel afdekrubber per stuk | | 891015001 | stuk | 1,65 | 328 | 0 |
| | 0710955 | membraanrubber 57mm | | 891113001 | stuk | 6,20 | 328 | 1 |
| Utiliteit | | | | | | | | |

| Art.nr | Specificaties | Kleur | Lev.nr | Ehd | Prijs | Grp | CC | | |
|---|--|-------|-----------|------|--------|-----|----|---|--|
| Geberit Gis-easy toiletmodule | | | | | | | | | |
| WC-element m. reservoir UP300 frontbediening | | | | | | | | | |
| 2200603 | 120x60-95cm | | 442020001 | stuk | 312,00 | 467 | 0 | Sanitair producten | |
| WC-element m. reservoir UP200 frontbediening | | | | | | | | | |
| 2200621 | 90x60-95cm | | 442000001 | stuk | 348,00 | 467 | 1 | | |
| WC-element v. Balena 8000 toiletcombinatie | | | | | | | | | |
| 2200601 | 120x60-95cm | | 442024001 | stuk | 305,00 | 467 | 1 | Baden / douchebakken / stoomcabines | |
| WC-element m. reservoir UP300 frontbediening v. armsteunen | | | | | | | | | |
| 2200612 | 120x85cm | | 442025001 | stuk | 414,00 | 467 | 1 | Kranen | |
| 2200613 | 120x100cm | | 442026001 | stuk | 491,00 | 467 | 1 | | |
| 2200605 | 120x115cm | | 442027001 | stuk | 509,00 | 467 | 1 | | |
| Geberit Gis-easy hoek toiletmodule | | | | | | | | | |
| WC-hoekelement m. reservoir UP300 frontbediening | | | | | | | | | |
| 2200604 | 120x60cm | | 442029001 | stuk | 312,00 | 467 | 1 | Douchegarnituur | |
| Geberit Gis-easy urinoirmodule | | | | | | | | | |
| urinoirmodule v. urinoirsturing | | | | | | | | | |
| 2200616 | 120x60-95cm | | 442140001 | stuk | 343,00 | 467 | 1 | Accessoires en spiegels | |
| urinoirmodule v. urinoirsturing v. urinoir Joly/Visit | | | | | | | | | |
| 2200615 | 120x60cm | | 442145001 | stuk | 323,00 | 467 | 1 | | |
| Geberit Gis-easy bidetmodule | | | | | | | | | |
| bidetmodule | | | | | | | | | |
| 2200614 | 120x65-95cm | | 442120001 | stuk | 268,00 | 467 | 1 | Douchewanden | |
| Geberit Gis-easy wastafelmodule | | | | | | | | | |
| wastafelmodule | | | | | | | | | |
| 2200602 | 100x60-95cm | | 442060001 | stuk | 158,00 | 467 | 1 | Toebehoren & afvoeren | |
| Geberit Gis-easy badmodule | | | | | | | | | |
| badombouw recht | | | | | | | | | |
| 2200607 | 50x57cm | | 442321001 | stuk | 130,00 | 467 | 1 | Spoel- & installatiesystemen | |
| 2200608 | 50x67cm | | 442322001 | stuk | 137,00 | 467 | 1 | | |
| 2200609 | 50x77cm | | 442323001 | stuk | 145,00 | 467 | 1 | | |
| 2200610 | 50x87cm | | 442324001 | stuk | 152,00 | 467 | 1 | | |
| 2200611 | 50x97cm | | 442325001 | stuk | 159,00 | 467 | 1 | | |
| Geberit Gis-easy douchescheidingswand | | | | | | | | | |
| douche scheidingswand | | | | | | | | | |
| 2200606 | 220-280x35-100cm | | 442212001 | stuk | 189,00 | 467 | 1 | Badkamermeubelen en toiletkasten | |
| Geberit Gis-easy toebehoren | | | | | | | | | |
| 2200617 | zijkantafsluiting m. gipskartonstrook 120x20cm | | 442268001 | stuk | 35,75 | 467 | 0 | Gootstenen en wastroggen | |
| 2200618 | gipskartonplaten voor toiletmodule m. reservoir UP200 planchetbediening | | 442332001 | stuk | 41,50 | 467 | 1 | | |
| 2200622 | gipskartonplaten voor toiletmodule m. reservoir UP300 frontbediening (2 platen 120x60cm) | | 442331001 | stuk | 32,50 | 467 | 0 | | |
| Geberit Gis constructie toebehoren | | | | | | | | | |
| 2200120 | profiel verzinkt per meter 3.2x3.2cm (lengte = 5 meter) | | 461000251 | mtr | 6,50 | 467 | 0 | Utiliteit | |
| 2200147 | profielverbinder per stuk | | 461200001 | stuk | 1,33 | 467 | 0 | | |
| 2200155 | montage hoeksteun M8 7.5x5cm | | 461002001 | stuk | 3,20 | 467 | 0 | | |
| 2200775 | geluidsisolatie voor montagehoeksteun 7x5cm | | 461014001 | stuk | 0,73 | 467 | 1 | | |
| 2200198 | verbindingstrip per stuk | | 461022001 | stuk | 3,20 | 467 | 1 | | |
| 2200767 | hamerkopbout M8 per stuk | | 461006001 | stuk | 1,59 | 467 | 1 | | |
| 2200171 | profielbevestigingsclip M10 per stuk | | 461004001 | stuk | 1,86 | 467 | 1 | | |
| 2200201 | versterkingsset voor vrijstaande wand | | 461660001 | stuk | 37,75 | 467 | 1 | | |
| 2200783 | transportbeveiliging | | 461089001 | stuk | 3,05 | 467 | 1 | | |
| 2200228 | spreidplug voor gipskartonplaat per stuk M6 | | 465029001 | stuk | 0,89 | 467 | 1 | | |
| Geberit Gis montage-elementen | | | | | | | | | |
| wc-element H114 frontbediening m. afvoerbocht | | | | | | | | | |
| 0704229 | | | 461309001 | stuk | 183,00 | 467 | 1 | | |
| wc-element H114 voor Balena douche-wc | | | | | | | | | |
| 0700078 | | | 461313001 | stuk | 195,00 | 467 | 1 | | |

| | Art.nr | Specificaties | Kleur | Lev.nr | Ehd | Prijs | Grp | CC |
|---|--------------------------------------|---|-------|-----------|------|--------|-----|----|
| | Geberit Gis montage-elementen | | | | | | | |
| Sanitair producten | | wc-element m. reservoir UP Powerflush frontbediening 2200010 | | 461165001 | stuk | 461,00 | 467 | 0 |
| | | WC-element H98 m. reservoir UP200 planchet- en frontbediening 0700114 | | 461247001 | stuk | 217,00 | 329 | 1 |
| Baden / douchebakken / stoomcabines | | WC-element H86 m. reservoir UP200 planchet- en frontbediening 0700115 | | 461242001 | stuk | 217,00 | 329 | 1 |
| Kranen | | urinoir element H114-132 0710274 | | 461685001 | stuk | 199,00 | 328 | 1 |
| | | urinoir element H120 voor urinoir Keramag Joly/Visit 0700079 | | 461657001 | stuk | 199,00 | 467 | 1 |
| Douchegarnituur | | montage-element voor bidet 2200031 | | 461550001 | stuk | 133,00 | 467 | 1 |
| Accessoires en spiegels | | montage-element voor wastafel 2200813 | | 461039001 | stuk | 55,50 | 467 | 1 |
| Douchewanden | | montage-element voor opbouwkraan HOH=153mm 2200805 | | 461038001 | stuk | 27,75 | 467 | 1 |
| | | montage-element voor inbouwkransen universeel 2200821 | | 461173001 | stuk | 30,50 | 467 | 1 |
| Toebehoren & afvoeren | | Geberit Gis installatie toebehoren | | | | | | |
| | 0710277 | montageconsole voor enkele muurplaat aansluiting 1/2" | | 461742001 | stuk | 23,25 | 467 | 1 |
| | 0710243 | armaturen aansluitset m. sifon wit | | 461440001 | stuk | 46,75 | 467 | 1 |
| Spoel- & installatiesystemen | 2200112 | buisclip voor waterleidingbuis per stuk 16-40mm | | 461070001 | stuk | 1,33 | 467 | 1 |
| | 2200279 | beugelclip v. afvoerleidingen 50-56mm | | 363050001 | stuk | 5,20 | 467 | 1 |
| | 2200260 | beugelclip v. afvoerleidingen 90mm | | 366050001 | stuk | 4,31 | 467 | 1 |
| | 2200562 | beugelclip v. afvoerleidingen 110mm | | 367050001 | stuk | 4,95 | 467 | 1 |
| Badkamermeubelen en toiletkasten | 2200244 | gipskartonplaat 130x60cm | | 461025001 | stuk | 11,75 | 467 | 0 |
| | 0704012 | gipskartonplaat voor wc-element | | 111855001 | stuk | 28,75 | 329 | 1 |
| | 2200236 | plamuur voor gipsplaat 5-kilo | | 464015001 | stuk | 31,00 | 467 | 1 |
| | 2200252 | paneelschroeven doos 200 stuks | | 461030001 | stuk | 8,00 | 467 | 1 |
| Gootstenen en wastroggen | | | | | | | | |
| Utiliteit | | | | | | | | |

| Art.nr | Specificaties | Kleur | Lev.nr | Ehd | Prijs | Grp | CC |
|--------|---------------|-------|--------|-----|-------|-----|----|
|--------|---------------|-------|--------|-----|-------|-----|----|

Grohedal Rapid-SL wc-elementen

wc-element vrijstaand
0102522

38584000 stuk 335,00 353 1



Sanitair producten

wc-element vrijstaand laag 80cm
0102523

38587000 stuk 377,00 353 1

Baden /
douchebakken /
stoomcabines

Kranen

wc-element 100cm
0729101

38525000 stuk 291,00 333 0



Douchegarnituur

Accessoires en
spiegels

wc-element 82cm
0729102

38526000 stuk 291,00 333 0



Douchewanden

Toebehoren &
afvoeren

wc-element z. wandbevestiging
0729103

38528000 stuk 231,00 333 0

Spoel- &
installatiesystemen

wc-element m. wandbevestiging m. isolatiemat
0729104

38539000 stuk 258,00 333 0

Badkamermeubelen
en toiletkastenGootstenen en
wastroggen

wc-element mindervalide 42cm
0729105

38675000 stuk 310,00 333 0



Utiliteit

wc-element m. drukspoeler
0729110

38519000 stuk 372,00 333 1



wc-element z. frame
0102513

38661000 stuk 136,00 333 1

| | Art.nr | Specificaties | Kleur | Lev.nr | Ehd | Prijs | Grp | CC |
|---|---|------------------------------------|-----------|----------|------|--------|-----|----|
| Sanitair producten | Grohedal Rapid-SL urinoirelementen | | | | | | | |
| | | radar electronica | | | | | | |
| | 0729111 | | | 38386000 | stuk | 564,00 | 333 | 1 |
| Baden / douchebakken / stoomcabines | inbouwset voor radar electronica 38386 | | | | | | | |
| | 0729112 | | | 38387000 | stuk | 82,00 | 333 | 1 |
| Kranen | urinoir drukspoeler radar | | | | | | | |
| | 0729113 | | | 38511000 | stuk | 259,00 | 333 | 0 |
| Douchegarnituur | urinoir drukspoeler Joly/Visit | | | | | | | |
| | 0729114 | | | 38515000 | stuk | 338,00 | 333 | 1 |
| Accessoires en spiegels | urinoir drukspoeler IR | | | | | | | |
| | 0729115 | | | 38521000 | stuk | 259,00 | 333 | 1 |
| Douchewanden | urinoir drukspoeler | | | | | | | |
| | 0729116 | | | 38523000 | stuk | 318,00 | 333 | 0 |
| Toebehoren & afvoeren | Grohedal Rapid-SL bidetelement | | | | | | | |
| | | bidet-element laag 80cm | | | | | | |
| | 0729118 | | | 38543000 | stuk | 251,00 | 333 | 1 |
| Badkamermeubelen en toiletkasten | bidet-element | | | | | | | |
| | 0729119 | | | 38553000 | stuk | 220,00 | 333 | 0 |
| Gootstenen en wastroggen | Grohedal Uniset elementen | | | | | | | |
| | | Uniset wc-element laag 80cm | | | | | | |
| | 0729108 | | | 38415000 | stuk | 228,00 | 333 | 1 |
| Utiliteit | Uniset wc-element | | | | | | | |
| | 0729109 | | | 38643000 | stuk | 180,00 | 333 | 0 |
| | Grohedal Atrio afdekplaten | | | | | | | |
| | | bedieningsplaat Rapid SL | | | | | | |
| | 0729140 | | chroom | 38670000 | stuk | 63,00 | 333 | 1 |
| | Grohedal Surf afdekplaten | | | | | | | |
| | | afdekplaat dual flush | | | | | | |
| | 0721263 | m. ecotoets | chroom | 37376000 | stuk | 44,75 | 333 | 0 |
| | 0442860 | m. ecotoets | alpinewit | 37376SH0 | stuk | 38,50 | 333 | 0 |
| | 0442852 | m. ecotoets | pergamon | 37376SPO | stuk | 38,50 | 333 | 1 |

| Art.nr | Specificaties | Kleur | Lev.nr | Ehd | Prijs | Grp | CC |
|--------|---------------|-------|--------|-----|-------|-----|----|
|--------|---------------|-------|--------|-----|-------|-----|----|

Grohedal Surf afdekplaten

bedieningsplaat Rapid SL

| | | | | | | | |
|---------|--|-----------|----------|------|-------|-----|---|
| 0729136 | | chroom | 38574000 | stuk | 50,50 | 333 | 0 |
| 0729137 | | matchroom | 38574P00 | stuk | 50,50 | 333 | 0 |
| 0729138 | | wit | 38574SH0 | stuk | 43,50 | 333 | 0 |



Sanitair producten

Baden /
douchebakken /
stoomcabines

afdekplaat m. drukknop inbouw

| | | | | | | | |
|---------|--|--------|----------|------|-------|-----|---|
| 0720534 | | chroom | 37069000 | stuk | 80,00 | 333 | 1 |
|---------|--|--------|----------|------|-------|-----|---|



Kranen

Douchegarnituur

Grohedal Skate afdekplaten

bedieningsplaat Rapid SL

| | | | | | | | |
|---------|--|-----------|----------|------|-------|-----|---|
| 0729132 | | chroom | 38573000 | stuk | 50,50 | 333 | 0 |
| 0729133 | | matchroom | 38573P00 | stuk | 50,50 | 333 | 0 |
| 0729134 | | wit | 38573SH0 | stuk | 43,50 | 333 | 0 |
| 0729141 | | RVS | 38672SD0 | stuk | 76,00 | 333 | 0 |

Accessoires en
spiegels

Douchewanden

Grohedal SL bedieningsplaten

bedieningsplaat Rapid SL dual flush

| | | | | | | | |
|---------|-------------|-----------|----------|------|-------|-----|---|
| 0729120 | verticaal | chroom | 38505000 | stuk | 50,00 | 333 | 0 |
| 0729121 | verticaal | matchroom | 38505P00 | stuk | 50,50 | 333 | 0 |
| 0729122 | verticaal | wit | 38505SH0 | stuk | 43,50 | 333 | 0 |
| 0729123 | verticaal | pergamon | 38505SP0 | stuk | 43,50 | 333 | 0 |
| 0729124 | horizontaal | chroom | 38506000 | stuk | 50,50 | 333 | 0 |
| 0729125 | horizontaal | matchroom | 38506P00 | stuk | 50,50 | 333 | 0 |
| 0729126 | horizontaal | wit | 38506SH0 | stuk | 43,50 | 333 | 0 |
| 0729127 | horizontaal | pergamon | 38506SP0 | stuk | 43,50 | 333 | 0 |

Toebehoren &
afvoerenSpoel- &
installatiesystemenBadkamermeubelen
en toiletkasten

Grohedal SL Ergo bedieningsplaten

bedieningsplaat Rapid SL

| | | | | | | | |
|---------|--|-----------|----------|------|-------|-----|---|
| 0729128 | | chroom | 38564000 | stuk | 50,50 | 333 | 0 |
| 0729129 | | matchroom | 38564P00 | stuk | 50,50 | 333 | 0 |
| 0729130 | | wit | 38564SH0 | stuk | 43,50 | 333 | 0 |

Gootstenen en
wastroggen

Grohedal beplating

beplating 120cm z. uitsparingen

| | | | | | | | |
|---------|--|--|----------|------|-------|-----|---|
| 0729154 | | | 38630000 | stuk | 36,75 | 333 | 1 |
|---------|--|--|----------|------|-------|-----|---|



Utiliteit

beplating 120cm v. zijkant 25cm

| | | | | | | | |
|---------|--|--|----------|------|-------|-----|---|
| 0729156 | | | 38633000 | stuk | 20,75 | 333 | 1 |
|---------|--|--|----------|------|-------|-----|---|



wc-beplating 120cm

| | | | | | | | |
|---------|--|--|----------|------|-------|-----|---|
| 0729157 | | | 38636000 | stuk | 39,00 | 333 | 0 |
|---------|--|--|----------|------|-------|-----|---|



| | Art.nr | Specificaties | Kleur | Lev.nr | Ehd | Prijs | Grp | CC | |
|---|---|---|-------|----------|------|--------|-----|----|--|
| Sanitair producten | Grohedal beplating | | | | | | | | |
| | | hoekmontageset | | | | | | | |
| | 0729163 | | | 38562000 | stuk | 143,00 | 333 | 1 | |
| Baden / douchebakken / stoomcabines |  | wc-beplating laag 100cm | | | | | | | |
| | | 0729158 | | 38637000 | stuk | 39,00 | 333 | 0 | |
| Kranen | Grohedal reservoir Toebehoren | | | | | | | | |
| Douchegarnituur | 0720968 | verlengset 50mm v. reservoir 37050 | | 37128000 | stuk | 10,75 | 333 | 0 | |
| | 0720941 | verlengset 300mm v. spoelpijp inbouwreservoir | | 37105K00 | stuk | 12,75 | 333 | 1 | |
| | 0720860 | draagsteunen voor wc-bidet element | | 37304000 | stuk | 22,75 | 333 | 1 | |
| | 0729160 | wandbevestiging 2-stuks | | 3855800M | stuk | 18,25 | 333 | 0 | |
| | 0729161 | bevestigingselement v. mindervaliden armsteun | | 38559000 | stuk | 145,00 | 333 | 1 | |
| | 0729162 | verlengset muurbevestiging | | 38563000 | stuk | 23,50 | 333 | 0 | |
| Accessoires en spiegels | Grohedal reservoir Onderdelen | | | | | | | | |
| Douchewanden | 0106402 | bevestigingsset voor V&B-reservoir | | 43500000 | stuk | 8,70 | 353 | 0 | |
| | 0106291 | servo flotteur voor zijaansluiting | | 37092000 | stuk | 26,25 | 353 | 0 | |
| Toebehoren & afvoeren | | | | | | | | | |
| Spoel- & installatiesystemen | | | | | | | | | |
| Badkamermeubelen en toiletkasten | | | | | | | | | |
| Gootstenen en wastroggen | | | | | | | | | |
| Utiliteit | | | | | | | | | |

| Art.nr | Specificaties | Kleur | Lev.nr | Ehd | Prijs | Grp | CC |
|--------|---------------|-------|--------|-----|-------|-----|----|
|--------|---------------|-------|--------|-----|-------|-----|----|

Pagette Ecotop

laaghangend reservoir
0750031

wit

794870102

stuk

50,50

344

1

Sanitair producten

Baden /
douchebakken /
stoomcabines

Kranen

Douchegarnituur

Accessoires en
spiegels

Douchewanden

Toebehoren &
afvoerenSpoel- &
installatiesystemenBadkamermeubelen
en toiletkastenGootstenen en
wastroggen

Utiliteit

| | Art.nr | Specificaties | Kleur | Lev.nr | Ehd | Prijs | Grp | CC |
|---|--|----------------------|----------|---------|------|--------|-----|----|
| Sanitair producten | Plieger Brussel laaghangend reservoir | | | | | | | |
| | laaghangend reservoir | | | | | | | |
| | 0704580 | | wit | 0704580 | stuk | 51,50 | 333 | 0 |
| | 0704585 | | pergamon | 0704585 | stuk | 58,00 | 333 | 0 |
| Baden / douchebakken / stoomcabines | Plieger Lech hooghangend reservoir | | | | | | | |
| | hooghangend reservoir | | | | | | | |
| | 0700792 | 6-9 liter instelbaar | wit | 0700792 | stuk | 38,00 | 333 | 0 |
| Kranen | Plieger Weser laaghangend reservoir | | | | | | | |
| | laaghangend reservoir dualflush | | | | | | | |
| | 0700040 | 3-6/9 liter | wit | 0700040 | stuk | 41,00 | 333 | 0 |
| | 0700041 | 3-6/9 liter | pergamon | 0700041 | stuk | 50,00 | 333 | 0 |
| Douchegarnituur | Plieger hoekbouwreservoir | | | | | | | |
| | hoekbouwreservoir 86x47cm voor Geberit afdekplaten | | | | | | | |
| | 0704235 | | | 0704235 | stuk | 496,00 | 333 | 0 |
| Accessoires en spiegels | | | | | | | | |
| Douchewanden | hoekbouwreservoir 108x40cm voor Geberit afdekplaten | | | | | | | |
| | 0704245 | | | 0704245 | stuk | 492,00 | 333 | 0 |
| Toebehoren & afvoeren | | | | | | | | |
| Spoel- & installatiesystemen | | | | | | | | |
| Badkamermeubelen en toiletkasten | | | | | | | | |
| Gootstenen en wastroggen | | | | | | | | |
| Utiliteit | | | | | | | | |



Innovatieve techniek, modern design



Reservoirs

Spoelwater 6 en 9 liter
Dubbele spoeltechniek of start-/stop techniek
Vul- en afvoergarnituur
Verbindingselementen



Closetzittingen

Uitgebreid programma Thermoplast en Duroplast
Diversiteit in modern design
Speciale scharniertechnieken



Voorwandsystemen

Nieuwe spoeltechniek d.m.v. kabeltechniek voor
kleine inspectieluiken
Compleet programma voor urinoirtechniek
Pneumatische spoelers
Oplossingen voor mindervaliden/gehandicapten
Modern vormgegeven afdekplaten



Afvoergarnituren

Afvoeren
Sifons
Afvoergarnituur voor reservoirs
Afvoergarnituur voor baden en douchebakken



| Art.nr | Specificaties | Kleur | Lev.nr | Ehd | Prijs | Grp | CC |
|--------|---------------|-------|--------|-----|-------|-----|----|
|--------|---------------|-------|--------|-----|-------|-----|----|

Plieger Liberty inbouwreservoir

| | | | | | | | |
|---------|---|--|---------|------|--------|-----|---|
| 0703397 | inbouwreservoir frontbediening dubbele spoeltechniek zelfdragend | | 0703397 | stuk | 249,00 | 333 | 0 |
|---------|---|--|---------|------|--------|-----|---|

hoekinbouwreservoir zelfdragend dubbele spoeling

| | | | | | | | |
|---------|---|--|---------|------|--------|-----|---|
| 0703450 | | | 0703450 | stuk | 255,00 | 333 | 0 |
| 0703400 | afdekplaat frontbediening dubbele spoeltechniek wit | | 0703400 | stuk | 36,50 | 333 | 0 |
| 0703401 | afdekplaat frontbediening dubbele spoeltechniek RVS | | 0703401 | stuk | 77,00 | 333 | 0 |
| 0703402 | afdekplaat frontbediening vandaalbestendig RVS | | 0703402 | stuk | 81,00 | 333 | 1 |
| 0703419 | afdekplaat frontbediening dubbele spoeltechniek matchroom | | 0703419 | stuk | 41,25 | 333 | 0 |
| 0703427 | afdekplaat frontbediening dubbele spoeltechniek pergamon | | 0703427 | stuk | 36,50 | 333 | 0 |
| 0704202 | afdekplaat frontbediening dubbele spoeltechniek chroom | | 0704202 | stuk | 41,50 | 333 | 0 |

Sanitair producten

Baden /
douchebakken /
stoomcabines

Kranen

Douchegarnituur

Accessoires en
spiegels

Douchewanden

Toebehoren &
afvoeren

Spoel- &
installatiesystemen

Badkamermeubelen
en toiletkasten

Gootstenen en
wastroggen

Utiliteit



- **Ruimtebesparend**
- Frontbediening
- **Direct te betegelen**
- Breedte vanaf 40cm,
Diepte vanaf 22cm
Hoogte 86 of 108cm
- Binnenwerk van **Geberit**
- Te combineren met afdekplaten **Geberit**
- Spoeling instelbaar (6/9L)
- **Met bevestigingsmateriaal**

| Art.nr | Specificaties | Kleur | Lev.nr | Ehd | Prijs | Grp | CC |
|--------|---------------|-------|--------|-----|-------|-----|----|
|--------|---------------|-------|--------|-----|-------|-----|----|



Plieger Spring inbouwreservoir
inbouwreservoir frontbediening dubbele spoeltechniek zelfdragend z. afdekplaat
 0703098

| | | | | | | | |
|---------|--|--|---------|------|--------|-----|---|
| 0703098 | | | 0703098 | stuk | 237,00 | 333 | 0 |
|---------|--|--|---------|------|--------|-----|---|

Sanitair producten

Baden /
douchebakken /
stoomcabines



Plieger Liberty afdekplaten

afdekplaat frontbediening

| | | | | | | | |
|---------|-----------------------|-----------|---------|------|-------|-----|---|
| 0703400 | dubbele spoeltechniek | wit | 0703400 | stuk | 36,50 | 333 | 0 |
| 0703427 | dubbele spoeltechniek | pergamon | 0703427 | stuk | 36,50 | 333 | 0 |
| 0704202 | dubbele spoeltechniek | chroom | 0704202 | stuk | 41,50 | 333 | 0 |
| 0703419 | dubbele spoeltechniek | matchroom | 0703419 | stuk | 41,25 | 333 | 0 |
| 0703401 | dubbele spoeltechniek | RVS | 0703401 | stuk | 77,00 | 333 | 0 |
| 0703402 | vandaalbestendig | RVS | 0703402 | stuk | 81,00 | 333 | 1 |

Kranen

Douchegarnituur



Plieger Spring afdekplaten

afdekplaat frontbediening

| | | | | | | | |
|---------|-----------------------|--------------|---------|------|-------|-----|---|
| 0703111 | dubbele spoeltechniek | wit | 0703111 | stuk | 35,50 | 333 | 0 |
| 0703121 | dubbele spoeltechniek | pergamon | 0703121 | stuk | 35,50 | 333 | 0 |
| 0703127 | dubbele spoeltechniek | matchroom | 0703127 | stuk | 41,25 | 333 | 0 |
| 0704261 | dubbele spoeltechniek | hooggl. chr. | 0704261 | stuk | 41,25 | 333 | 0 |
| 0703187 | m. spoelonderbreking | RVS-chroom | 0703187 | stuk | 75,50 | 333 | 0 |

Accessoires en
spiegels

Douchewanden

Plieger reservoir Onderdelen

| | | | | | | | |
|---------|--|--|---------|------|-------|-----|---|
| 0702042 | O-ring voor spoelbocht inbouwreservoir | | 0702042 | stuk | 1,19 | 353 | 0 |
| 0702040 | spoelbocht Sanit 90° t.b.v. inbouwreservoir | | 0702040 | stuk | 3,82 | 353 | 0 |
| 0770614 | flotteur compleet 3/8" | | 0770614 | stuk | 7,60 | 353 | 0 |
| 0703428 | aansluitkabel voor inbouwreservoir | | 0703428 | stuk | 3,32 | 333 | 1 |
| 0703430 | aansluitkabelklem voor inbouwreservoir | | 0703430 | stuk | 1,15 | 333 | 0 |
| 0703420 | bodemventiel voor inbouwreservoir | | 0703420 | stuk | 21,50 | 333 | 0 |
| 0703424 | snelspan Schroef voor inbouwreservoir per paar | | 0703424 | stuk | 3,84 | 333 | 0 |
| 0703321 | binnenwerk voor duoblok | | 0703321 | stuk | 66,00 | 328 | 0 |

Toebehoren &
afvoeren

Spoel- &
installatiesystemen

Badkamermeubelen
en toiletkasten

Gootstenen en
wastroggen

Utiliteit

| Art.nr | Specificaties | Kleur | Lev.nr | Ehd | Prijs | Grp | CC |
|--------|---------------|-------|--------|-----|-------|-----|----|
|--------|---------------|-------|--------|-----|-------|-----|----|

Rezi BB4321 hooghangend reservoir

| | | | | | | | |
|------------------------------|-----------|-----|--------|------|-------|-----|---|
| hooghangend reservoir | | | | | | | |
| 0700002 | trekmodel | wit | BB4321 | stuk | 77,50 | 328 | 0 |



Sanitair producten

Rezi BB4330 laaghangend reservoir

| | | | | | | | |
|------------------------------|---------------|-----|--------|------|-------|-----|---|
| hooghangend reservoir | | | | | | | |
| 0700045 | druknop model | wit | BB4330 | stuk | 70,50 | 328 | 0 |

Baden /
douchebakken /
stoomcabines

Kranen

Rezi BB4700 laaghangend reservoir

| | | | | | | | |
|------------------------------|--|-----------|--------|------|-------|-----|---|
| laaghangend reservoir | | | | | | | |
| 0700436 | | wit | BB4700 | stuk | 56,50 | 328 | 0 |
| 0700444 | | beige | BB4700 | stuk | 67,00 | 328 | 1 |
| 0700495 | | manhattan | BB4700 | stuk | 67,00 | 328 | 1 |



Douchegarnituur

Accessoires en
spiegels

Rezi BB4800 laaghangend reservoir

| | | | | | | | |
|------------------------------|--|-----------|--------|------|-------|-----|---|
| laaghangend reservoir | | | | | | | |
| 0701394 | | wit | BB4800 | stuk | 69,50 | 328 | 1 |
| 0701416 | | pergamon | BB4800 | stuk | 84,00 | 328 | 1 |
| 0701424 | | manhattan | BB4800 | stuk | 84,00 | 328 | 1 |



Douchewanden

Rezi BB4850 laaghangend reservoir

| | | | | | | | |
|------------------------------|--|-----------|--------|------|-------|-----|---|
| laaghangend reservoir | | | | | | | |
| 0701254 | | wit | BB4850 | stuk | 55,00 | 328 | 0 |
| 0701270 | | pergamon | BB4850 | stuk | 65,50 | 328 | 1 |
| 0701289 | | manhattan | BB4850 | stuk | 65,50 | 328 | 1 |

Toebehoren &
afvoerenSpoel- &
installatiesystemen

Rezi reservoir Onderdelen

| | | | | | | | |
|---------|------------------------------------|--|---------|------|-------|-----|---|
| 0711322 | brugstuk m. rubber dopje | | BB4333 | stuk | 6,00 | 328 | 1 |
| 0710393 | druknop z. pijpje | | BB4341 | stuk | 18,00 | 328 | 0 |
| 0710490 | plastic drukknooppipje | | PDRP012 | stuk | 5,10 | 328 | 0 |
| 0710369 | set drukstift m. kap | | BB4347 | stuk | 9,30 | 328 | 1 |
| 0711314 | geleidepijpje compleet | | BB4332 | stuk | 4,16 | 328 | 1 |
| 0711284 | kniehevel m. moer | | BB4343 | stuk | 17,00 | 328 | 1 |
| 0711241 | ophangbeugel z. schroef | | BB4339 | stuk | 1,92 | 328 | 1 |
| 0711306 | ring voor drukknooppipje | | BB4346 | stuk | 1,04 | 328 | 1 |
| 0711268 | sputmondje compleet | | BB4342 | stuk | 4,16 | 328 | 1 |
| 0711292 | valpijpmoer m. rubber ring | | BB4335 | stuk | 2,96 | 328 | 1 |
| 0710695 | rubberbal voor drukknoopinrichting | | BB4345 | stuk | 2,50 | 328 | 0 |
| 0710148 | flotteurkraan geruisarm | | BB5500 | stuk | 25,25 | 328 | 0 |

Badkamermeubelen
en toiletkastenGootstenen en
wastroggen

Utiliteit

| | Art.nr | Specificaties | Kleur | Lev.nr | Ehd | Prijs | Grp | CC |
|---|--|---------------|-----------|-----------|------|-------|-----|----|
| Sanitair producten | Schwab Saninorm laaghangend reservoir | | | | | | | |
| | laaghangend reservoir 6-9liter | | | | | | | |
| | 0297427 | Saninorm | wit | 1600201KI | stuk | 49,50 | 333 | 1 |
| Baden / douchebakken / stoomcabines | Schwab 4000 laaghangend reservoir | | | | | | | |
| | laaghangend reservoir 6-9liter | | | | | | | |
| | 0297428 | | wit | 1400201KI | stuk | 53,00 | 333 | 1 |
| | 0297430 | | pergamon | 14002P3KI | stuk | 62,50 | 333 | 1 |
| | 0297436 | | manhattan | 14002M2KI | stuk | 62,50 | 333 | 1 |
| Kranen | | | | | | | | |
| Douchegarnituur | | | | | | | | |
| Accessoires en spiegels | | | | | | | | |
| Douchewanden | | | | | | | | |
| Toebehoren & afvoeren | | | | | | | | |
| Spoel- & installatiesystemen | | | | | | | | |
| Badkamermeubelen en toiletkasten | | | | | | | | |
| Gootstenen en wastroggen | | | | | | | | |
| Utiliteit | | | | | | | | |

XS

WISA introduceert een heel nieuwe generatie inbouwsystemen: WISA XS. Met een breedte van slechts 38 cm méér mogelijkheden èn handzaamheid voor de installateur!

Het WISA XS frame is meer dan een smal inbouwsysteem. De bekende WISA spoeltechniek is geoptimaliseerd volgens de laatste trends en ontwikkelingen. Gerealiseerd op basis van de praktijkervaring die u als vakman met ons deelt.

WISA XS is verkrijgbaar in maar liefst elf varianten; frames voor droge en natte afwerking, hoekplaatsing en een frame dat na afwerking nog in hoogte verstelbaar is! Ook frames voor wastafel en urinoir behoren tot het XS assortiment. En natuurlijk een bijpassende serie bedieningspanelen. Van rustig rond tot strak en vierkant. Uiteraard ook XS en verkrijgbaar in verschillende kleuren.

Voor uw gemak zijn de inbouwsystemen uiterst eenvoudig te installeren en af te stellen. De voordelen zijn dus eindeloos. Als vakman mag u dat van ons verwachten!

Eén van de vele grote voordelen van de nieuwe WISA XS inbouwsystemen



| Art.nr | Specificaties | Kleur | Lev.nr | Ehd | Prijs | Grp | CC |
|--------|---------------|-------|--------|-----|-------|-----|----|
|--------|---------------|-------|--------|-----|-------|-----|----|

Sanitair producten



Wisa 285 hooghangend reservoir

hooghangend reservoir 285

| | | | | | | | |
|---------|------------|-----|------------|------|-------|-----|---|
| 0701505 | z. valpijp | wit | 8050421500 | stuk | 85,50 | 333 | 0 |
|---------|------------|-----|------------|------|-------|-----|---|

Baden /
douchebakken /
stoomcabines



Wisa 300 laaghangend reservoir

laaghangend reservoir 300

| | | | | | | | |
|---------|---------|----------|------------|------|-------|-----|---|
| 0701500 | project | wit | 8050427701 | stuk | 65,50 | 333 | 0 |
| 0701510 | project | pergamon | 8050427714 | stuk | 89,00 | 333 | 1 |

Kranen

Douchegarnituur

Wisa 336 laaghangend reservoir

laaghangend reservoir dualflux 3/6liter

| | | | | | | | |
|---------|--|----------|------------|------|-------|-----|---|
| 0701550 | | wit | 8050430701 | stuk | 70,00 | 333 | 1 |
| 0701552 | | pergamon | 8050430714 | stuk | 95,50 | 333 | 1 |

Accessoires en
spiegels

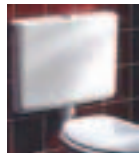

Wisa 500 laaghangend reservoir

laaghangend reservoir 500

| | | | | | | | |
|---------|--|-----------|------------|------|--------|-----|---|
| 0701017 | | manhattan | 8050422689 | stuk | 119,00 | 333 | 1 |
| 0701068 | | wit | 8050422670 | stuk | 97,50 | 333 | 0 |
| 0701018 | | pergamon | 8050422697 | stuk | 119,00 | 333 | 0 |

Douchewanden

Toebehoren &
afvoeren



Wisa 790 laaghangend reservoir

laaghangend reservoir 790

| | | | | | | | |
|---------|------------------------|-----------|------------|------|--------|-----|---|
| 0701556 | | wit | 8050426000 | stuk | 69,50 | 333 | 0 |
| 0701637 | | pergamon | 8050426007 | stuk | 94,50 | 333 | 0 |
| 0701645 | | manhattan | 8050426019 | stuk | 94,50 | 333 | 1 |
| 0701557 | | beige | 8050426002 | stuk | 94,50 | 333 | 1 |
| 0701639 | m. dekselvergrendeling | wit | 8050426050 | stuk | 107,00 | 333 | 1 |

Spoel- &
installatiesystemen

Badkamermeubelen
en toiletkasten



Wisa 1000 laaghangend reservoir

laaghangend reservoir 1000

| | | | | | | | |
|---------|--|-----------|------------|------|--------|-----|---|
| 0700134 | | wit | 8050424000 | stuk | 88,00 | 333 | 0 |
| 0700266 | | pergamon | 8050424007 | stuk | 104,00 | 333 | 1 |
| 0700215 | | manhattan | 8050424019 | stuk | 104,00 | 333 | 1 |

Gootstenen en
wastroggen

Utiliteit



Wisa Duoflux laaghangend reservoir

laaghangend reservoir Duoflux 1036DF

| | | | | | | | |
|---------|--|----------|------------|------|--------|-----|---|
| 0702890 | | wit | 8050423800 | stuk | 90,00 | 333 | 0 |
| 0700000 | | pergamon | 8050423807 | stuk | 106,00 | 333 | 1 |



Wisa 1040 laaghangend reservoir

laaghangend reservoir 1040

| | | | | | | | |
|---------|---------|-----|------------|------|-------|-----|---|
| 0700017 | 4-liter | wit | 8050428601 | stuk | 93,50 | 333 | 1 |
|---------|---------|-----|------------|------|-------|-----|---|



Wisa 444 hoekreservoir

hoekreservoir 444

| | | | | | | | |
|---------|--|-----------|------------|------|--------|-----|---|
| 0701777 | | wit | 8050428501 | stuk | 159,00 | 333 | 0 |
| 0701778 | | beige | 8050428503 | stuk | 216,00 | 333 | 1 |
| 0082012 | | pergamon | 8050428514 | stuk | 216,00 | 333 | 1 |
| 0701780 | | manhattan | 8050428510 | stuk | 216,00 | 333 | 1 |

Wisa reservoir Toebehoren

| | | | | | | | |
|---------|-----------------------------|--|------------|------|------|-----|---|
| 0710598 | valpijpsok wit | | 1409985438 | stuk | 2,52 | 353 | 0 |
| 0710907 | valpijpmanchet | | 8050880349 | stuk | 2,54 | 353 | 0 |
| 0730432 | valpijpsok 1" kunststof wit | | 7240770500 | stuk | 2,05 | 353 | 0 |

| Art.nr | Specificaties | Kleur | Lev.nr | Ehd | Prijs | Grp | CC |
|--------|---------------|-------|--------|-----|-------|-----|----|
|--------|---------------|-------|--------|-----|-------|-----|----|

Wisa reservoir Toebehoren

| | | | | | | | |
|---------|---|--|------------|------|-------|-----|---|
| 0710520 | valpijpbocht kunststof z. trekvalpijp | | 1409986030 | stuk | 6,80 | 353 | 0 |
| 0711136 | valpijp kunststof halfhoog wit | | 1409985540 | stuk | 26,75 | 353 | 1 |
| 0710326 | reducerestuk voor halfhoge valpijp | | 8035882383 | stuk | 2,64 | 353 | 0 |
| 0711128 | valpijp z. bocht z. kraag sprong 6cm voor reservoir | | 1409986000 | stuk | 18,75 | 353 | 0 |

Sanitair producten

Wisa Mont inbouwreservoirs

| | | | | | | | |
|--|----------------------------|--|------------|------|--------|-----|---|
| 2101 inbouwreservoir frontbediening | | | | | | | |
| 0701996 | m. stopkraan z. afdekplaat | | 8050421388 | stuk | 190,00 | 333 | 1 |

Baden /
douchebakken /
stoomcabines

Kranen

| | | | | | | | |
|---|----------------------------|--|------------|------|--------|-----|---|
| 2103 inbouwreservoir planchetbediening | | | | | | | |
| 0701998 | m. stopkraan z. afdekplaat | | 8050421390 | stuk | 217,00 | 333 | 1 |



Douchegarnituur

Accessoires en
spiegels

| | | | | | | | |
|--|--|--|------------|------|--------|-----|---|
| 2136DF inbouwreservoir frontbediening 1/2"x12mm | | | | | | | |
| 0704423 | | | 8050452109 | stuk | 289,00 | 333 | 1 |

| | | | | | | | |
|--|--|--|------------|------|--------|-----|---|
| Quadro inbouwreservoir frontbediening | | | | | | | |
| 0704865 | | | 8050452139 | stuk | 179,00 | 333 | 1 |

Douchewanden

Wisa Toebehoren

| | | | | | | | |
|---------|--|--|------------|------|-------|-----|---|
| 0700586 | set poten voor inbouwreservoir 2101/2103/2136/2140 | | 8050421358 | paar | 29,50 | 333 | 1 |
|---------|--|--|------------|------|-------|-----|---|

Toebehoren &
afvoeren

Wisa Excellent inbouwreservoirs

| | | | | | | | |
|--|--|--|------------|------|--------|-----|---|
| 2901 Excellent inbouwreservoir frontbediening 1/2"x12mm | | | | | | | |
| 0704407 | | | 8050452901 | stuk | 283,00 | 333 | 1 |

| | | | | | | | |
|---|---------------------------|--|------------|------|--------|-----|---|
| 2901P Excellent inbouwreservoir frontbediening 1/2"x12mm | | | | | | | |
| 0711986 | m. pneumatische bediening | | 8050452905 | stuk | 299,00 | 333 | 1 |

Spoel- &
installatiesystemen

| | | | | | | | |
|--|--|--|------------|------|--------|-----|---|
| 2936DF inbouwreservoir frontbediening 1/2"x12mm | | | | | | | |
| 0704415 | | | 8050452909 | stuk | 331,00 | 333 | 1 |

Badkamermeubelen
en toiletkasten

| | | | | | | | |
|---|--|--|------------|------|--------|-----|---|
| Quadro wc element frontbediening | | | | | | | |
| 0704857 | | | 8050452939 | stuk | 270,00 | 333 | 0 |

Gootstenen en
wastroggen

| | | | | | | | |
|---|--|--|------------|------|--------|-----|---|
| Excellent XS wc-element frontbediening | | | | | | | |
| 0704408 | | | 8050452701 | stuk | 245,00 | 333 | 1 |

Utiliteit

| | | | | | | | |
|--------------------------------|--|--|------------|------|-------|-----|---|
| hoekbeugelset a 2 stuks | | | | | | | |
| 0704432 | | | 8050452972 | stuk | 18,75 | 333 | 1 |

Wisa Jan des Bouvrie afdekplaten

| | | | | | | | |
|-------------------------|--|--------------|------------|------|-------|-----|---|
| bedieningspaneel | | | | | | | |
| 0712392 | | zwart | 8050414838 | stuk | 59,50 | 333 | 1 |
| 0712393 | | rood | 8050414826 | stuk | 59,50 | 333 | 1 |
| 0712394 | | blauw | 8050414832 | stuk | 59,50 | 333 | 1 |
| 0712395 | | groen | 8050414841 | stuk | 59,50 | 333 | 1 |
| 0712397 | | geel | 8050414823 | stuk | 59,50 | 333 | 1 |
| 0712398 | | wit | 8050414801 | stuk | 53,50 | 333 | 1 |
| 0712399 | | glans chroom | 8050414851 | stuk | 70,50 | 333 | 1 |
| 0712400 | | mat chroom | 8050414831 | stuk | 59,50 | 333 | 1 |

Wisa 2121 afdekplaten

| | | | | | | | |
|-------------------------|--------------|-----------|-----------|------|-------|-----|---|
| bedieningspaneel | | | | | | | |
| 0701682 | dualflush DF | wit | WISA-2121 | stuk | 45,75 | 333 | 1 |
| 0701684 | dualflush DF | pergamon | WISA-2121 | stuk | 48,75 | 333 | 1 |
| 0701686 | dualflush DF | matchroom | WISA-2121 | stuk | 68,00 | 333 | 1 |
| 0701688 | dualflush DF | chroom | WISA-2121 | stuk | 68,00 | 333 | 1 |



| | Art.nr | Specificaties | Kleur | Lev.nr | Ehd | Prijs | Grp | CC |
|--|--|--------------------------------|--------------|------------|-------|-------|-----|----|
| Sanitair producten | Wisa 2101 afdekplaten | | | | | | | |
| | bedieningspaneel | | | | | | | |
| | 0702005 | voor inbouwreservoir 2101 | wit | 8050420600 | stuk | 39,50 | 333 | 0 |
| | 0702013 | voor inbouwreservoir 2101 | pergamon | 8050420607 | stuk | 45,75 | 333 | 1 |
| | 0702021 | voor inbouwreservoir 2101 | chroom | 8050420629 | stuk | 61,50 | 333 | 1 |
| Baden / douchebakken / stoomcabines | Wisa 2103 afdekplaten | | | | | | | |
| | bedieningspaneel | | | | | | | |
| | 0702048 | voor inbouwreservoir 2102/2103 | wit | 8050420800 | stuk | 39,75 | 333 | 1 |
| | 0702064 | voor inbouwreservoir 2102/2103 | pergamon | 8050420807 | stuk | 45,75 | 333 | 1 |
| | 0702072 | voor inbouwreservoir 2102/2103 | chroom | 8050420829 | stuk | 61,50 | 333 | 1 |
| Kranen | Wisa Argos afdekplaten | | | | | | | |
| | afdekplaat dualflush | | | | | | | |
| | 0704409 | | wit | 8050414601 | stuk | 41,00 | 333 | 1 |
| | 0704410 | | pergamon | 8050414614 | stuk | 41,00 | 333 | 1 |
| Douchegarnituur | 0704411 | | matchroom | 8050414631 | stuk | 63,00 | 333 | 1 |
| | 0704412 | | glans chroom | 8050414651 | stuk | 63,00 | 333 | 1 |
| | Wisa Delos afdekplaten | | | | | | | |
| | afdekplaat dualflush vierkant | | | | | | | |
| Accessoires en spiegels | 0704436 | | wit | 8050414001 | stuk | 55,00 | 333 | 1 |
| | 0704437 | | glans chroom | 8050414051 | stuk | 70,00 | 333 | 1 |
| | 0704438 | | matchroom | 8050414031 | stuk | 70,00 | 333 | 1 |
| Douchewanden | Wisa Enyo afdekplaten | | | | | | | |
| | bedieningspaneel | | | | | | | |
| | 0712353 | dualflush DF | wit | 8050416701 | stuk | 42,75 | 333 | 1 |
| | 0712388 | dualflush DF | pergamon | 8050416714 | stuk | 42,75 | 333 | 1 |
| Toebehoren & afvoeren | 0712418 | dualflush DF | matchroom | 8050416731 | stuk | 54,50 | 333 | 1 |
| | 0712434 | dualflush DF | glanschroom | 8050416751 | stuk | 54,50 | 333 | 1 |
| | bedieningspaneel spoelonderbreking SO | | | | | | | |
| | 0712345 | | wit | 8050416801 | stuk | 42,75 | 333 | 1 |
| Spoel- & installatiesystemen | 0712361 | | pergamon | 8050416814 | stuk | 42,75 | 333 | 1 |
| | 0712396 | | matchroom | 8050416831 | stuk | 54,50 | 333 | 1 |
| | 0712426 | | glanschroom | 8050416851 | stuk | 54,50 | 333 | 1 |
| | Wisa Gaia afdekplaten | | | | | | | |
| bedieningspaneel | | | | | | | | |
| Badkamermeubelen en toiletkasten | 0712272 | dualflush DF | wit | 8050417001 | stuk | 42,75 | 333 | 0 |
| | 0712299 | dualflush DF | pergamon | 8050417014 | stuk | 42,75 | 333 | 1 |
| | 0712310 | dualflush DF | matchroom | 8050417031 | stuk | 54,50 | 333 | 0 |
| | 0712337 | dualflush DF | glanschroom | 8050417051 | stuk | 54,50 | 333 | 0 |
| Gootstenen en wastroggen | bedieningspaneel spoelonderbreking SO | | | | | | | |
| | 0712264 | | wit | 8050417101 | stuk | 42,75 | 333 | 0 |
| | 0712280 | | pergamon | 8050417114 | stuk | 42,75 | 333 | 1 |
| | 0712302 | | matchroom | 8050417131 | stuk | 54,50 | 333 | 1 |
| Utiliteit | 0712329 | | glanschroom | 8050417151 | stuk | 54,50 | 333 | 0 |
| | Wisa Hera afdekplaten | | | | | | | |
| | bedieningspaneel | | | | | | | |
| | 0711985 | dualflush DF | wit | 8050417301 | stuk | 55,50 | 333 | 1 |
| 0712167 | dualflush DF | pergamon | 8050417314 | stuk | 55,50 | 333 | 1 | |
| 0712256 | dualflush DF | klassiek wit | 8050417337 | stuk | 60,50 | 333 | 1 | |
| bedieningspaneel spoelonderbreking SO | | | | | | | | |
| 0711845 | | wit | 8050417401 | stuk | 55,50 | 333 | 1 | |
| 0712159 | | pergamon | 8050417414 | stuk | 55,50 | 333 | 1 | |
| 0712191 | | klassiek wit | 8050417437 | stuk | 60,50 | 333 | 1 | |
| Wisa Maro afdekplaten | | | | | | | | |
| afdekplaat dualflush universeel | | | | | | | | |
| 0704433 | | wit | 8050414401 | stuk | 41,00 | 333 | 1 | |
| 0704434 | | glans chroom | 8050414451 | stuk | 63,00 | 333 | 1 | |
| 0704435 | | matchroom | 8050414431 | stuk | 63,00 | 333 | 1 | |
| Wisa Taras afdekplaten | | | | | | | | |
| afdekplaat dualflush rond | | | | | | | | |
| 0704439 | | wit | 8050414201 | stuk | 75,00 | 333 | 1 | |
| 0704440 | | glans chroom | 8050414251 | stuk | 85,00 | 333 | 1 | |
| 0704441 | | matchroom | 8050414231 | stuk | 85,00 | 333 | 1 | |
| Wisa reservoir Onderdelen | | | | | | | | |
| 0711810 | afdichtring voor valpijp | | | 8050882450 | stuk | 0,91 | 353 | 0 |
| 0711902 | afvoerpijp recht 80/100x230mm | | | 1409985894 | stuk | 19,50 | 353 | 1 |

| Art.nr | Specificaties | Kleur | Lev.nr | Ehd | Prijs | Grp | CC |
|----------------------------------|---|-------|------------|------|-------|-----|----|
| Wisa reservoir Onderdelen | | | | | | | |
| 0711918 | bevestigingsset universeel in zakje | | 8050800078 | stuk | 5,20 | 353 | 0 |
| 0711071 | bodemklep voor 500/750 oud 65mm | | 121010025 | stuk | 0,60 | 353 | 0 |
| 0711098 | bodemklep voor 200/201 69mm | | 121030025 | stuk | 0,65 | 353 | 0 |
| 0710903 | bodemklep voor 250/500/790/1000 | | 121050025 | stuk | 0,70 | 353 | 0 |
| 0770329 | 301A closetbocht 110mm lengte=180mm | | 7010120220 | stuk | 9,40 | 353 | 0 |
| 0770280 | 303C closetbocht 110mm lengte=180mm m. spie 90° wit | | 7010121440 | stuk | 11,00 | 353 | 0 |
| 0712078 | deksel voor 250 nieuw wit | | 8050882630 | stuk | 15,00 | 353 | 1 |
| 0710902 | deksel m/druktoets voor 350 wit | | 8050410201 | stuk | 24,75 | 353 | 0 |
| 0711942 | deksel m/druktoets voor 500 wit | | 8050411201 | stuk | 24,75 | 353 | 1 |
| 0711950 | deksel m/druktoets voor 500 pergamon | | 8050411214 | stuk | 24,75 | 353 | 1 |
| 0711888 | deksel voor 750 wit | | 8050410501 | stuk | 36,00 | 353 | 1 |
| 0711896 | deksel voor 750 pergamon | | 8050410514 | stuk | 36,00 | 353 | 1 |
| 0710901 | zakje draadstiften | | 8050800041 | stuk | 9,10 | 353 | 0 |
| 0712136 | drukpen voor 500 | | 8050885403 | stuk | 0,53 | 353 | 0 |
| 0710555 | druktoets m. gat m. spoelonderbreker pergamon | | 8050428027 | stuk | 8,30 | 353 | 1 |
| 0710563 | druktoets m. gat m. spoelonderbreker manhattan | | 8050428029 | stuk | 8,30 | 353 | 1 |
| 0710970 | druktoets m. gat m. spoelonderbreker wit | | 8050428020 | stuk | 8,30 | 353 | 0 |
| 0711853 | druktoets voor 250/500/750 wit | | 8050885500 | stuk | 3,03 | 353 | 0 |
| 0710008 | druktoets voor 200/201 chroom | | 8050885203 | stuk | 6,60 | 353 | 0 |
| 0710121 | druktoets voor 250/500/750 zwart | | 8050885400 | stuk | 4,06 | 353 | 0 |
| 0712134 | drukveer voor 500/750 | | 1401980441 | stuk | 0,53 | 353 | 0 |
| 0710906 | haak voor 2000 | | 8050883265 | stuk | 2,52 | 353 | 1 |
| 0710905 | hefboom servicelruik | | 8050883263 | stuk | 2,77 | 353 | 0 |
| 0712108 | hefboom voor 250 | | 8050885213 | stuk | 1,98 | 353 | 1 |
| 0711934 | hefboom voor 250/500 | | 8050885402 | stuk | 1,98 | 353 | 1 |
| 0712140 | kleprubber voor floteurkraan PS+MS | | 1411988470 | stuk | 2,11 | 353 | 1 |
| 0710407 | klok voor nieuw Aqualux model | | 8050885118 | stuk | 4,13 | 353 | 1 |
| 0711799 | membraam en steunplaat tbv. floteur | | 8050800311 | stuk | 3,12 | 353 | 0 |
| 0712043 | moer M60 inwendig voor 200/201/250 oud | | 8050885161 | stuk | 2,69 | 353 | 1 |
| 0711900 | set montagepennen lange uitvoering | | 8050390077 | stuk | 23,25 | 353 | 0 |
| 0710964 | 2121 Dualflux stelpen m. kop | | 8050390105 | stuk | 10,75 | 353 | 1 |
| 0710966 | 2121 pennen voor bedieningspaneel | | 8050390089 | stuk | 23,25 | 353 | 1 |
| 0701513 | ombouwset voor Aqualux | | 8050800070 | stuk | 9,80 | 333 | 1 |
| 0710908 | rioolverlengbuis 110mm | | 1409985880 | stuk | 15,00 | 353 | 0 |
| 0710180 | rubber balg voor Aqualux | | 1411988407 | stuk | 8,00 | 353 | 0 |
| 0712094 | samengesteld brugstuk voor 250 oud | | 8050800235 | stuk | 4,51 | 353 | 1 |
| 0711977 | samengesteld brugstuk voor 500 | | 8050800198 | stuk | 4,39 | 353 | 1 |
| 0711969 | samengesteld brugstuk voor 790 nieuw | | 8050800237 | stuk | 4,39 | 353 | 1 |
| 0710792 | schotelklep voor 200/201 117mm | | 8050988431 | stuk | 4,06 | 353 | 0 |
| 0710822 | schotelklep voor 250 oud 78mm | | 1411988438 | stuk | 2,86 | 353 | 0 |
| 0710975 | spoelonderbreker set voor W500/750 wit | | 8050428000 | stuk | 8,90 | 353 | 0 |
| 0710934 | hefboom | | 0710934 | stuk | 1,98 | 353 | 0 |
| 0710830 | uitstroommechanisme voor 500/790 nieuw | | 8050800504 | stuk | 22,00 | 353 | 0 |
| 0710962 | uitstroommechanisme | | 8050801523 | stuk | 33,00 | 353 | 0 |
| 0711829 | valpijpmoer universeel wit | | 8050882430 | stuk | 2,39 | 353 | 0 |
| 0711837 | valpijpmoer universeel beige | | 8050882432 | stuk | 3,18 | 353 | 1 |
| 0710984 | floteurkraan universeel | | 8035432783 | stuk | 30,25 | 353 | 0 |

Sanitair producten

Baden /
douchebakken /
stoomcabines

Kranen

Douchegarnituur

Accessoires en
spiegels

Douchewanden

Toebehoren &
afvoerenSpoel- &
installatiesystemenBadkamermeubelen
en toiletkastenGootstenen en
wastroggen

Utiliteit

| | Art.nr | Specificaties | Kleur | Lev.nr | Ehd | Prijs | Grp | CC |
|---|--|---|-------|--------|------|--------|-----|----|
| Sanitair producten | Burda Santro2000 WC-module | | | | | | | |
| | 0701130 | inbouwreservoir m. Geberit reservoir | | 401045 | stuk | 203,00 | 329 | 0 |
| Baden / douchebakken / stoomcabines | Surf wc-module frontbediening z. bedieningsplaat | | | | | | | |
| | 0702782 | | | 611082 | stuk | 286,00 | 487 | 1 |
| Kranen | Artline wc-module planchetbediening z. bedieningsplaat | | | | | | | |
| | 0702781 | | | 611175 | stuk | 410,00 | 487 | 1 |
| Douchegarnituur | Geberit-nieuw wc-module frontbediening z. bedieningsplaat | | | | | | | |
| | 0704121 | | | 611250 | stuk | 342,00 | 487 | 0 |
| Accessoires en spiegels | Geberit-nieuw wc-module frontbediening | | | | | | | |
| | 0702760 | | | 611113 | stuk | 336,00 | 487 | 1 |
| Douchewanden | Surf wc-module frontbediening z. bedieningsplaat | | | | | | | |
| | 0700027 | | | 611273 | stuk | 330,00 | 487 | 1 |
| Toebehoren & afvoeren | Artline wc-module planchetbediening z. bedieningsplaat | | | | | | | |
| | 0700005 | | | 611281 | stuk | 463,00 | 487 | 1 |
| Spoel- & installatiesystemen | Geberit-nieuw wc-module voor sanibroyeur | | | | | | | |
| | 0704148 | | | 611311 | stuk | 460,00 | 487 | 1 |
| Badkamermeubelen en toiletkasten | Sanibroyeur wc-module scharnier rechts | | | | | | | |
| | 0620030 | | | 140002 | stuk | 755,00 | 487 | 1 |
| Gootstenen en wastroggen | Sanibroyeur wc-module scharnier links | | | | | | | |
| | 0628850 | | | 140001 | stuk | 755,00 | 487 | 1 |
| Utiliteit | Burda Santro2000 wastafelmodule | | | | | | | |
| | 0702803 | WT wastafel-module | | 621258 | stuk | 183,00 | 487 | 1 |
| | 0702804 | WTS wastafel-module | | 621210 | stuk | 183,00 | 487 | 1 |
| | Burda Santro2000 bidetmodule | | | | | | | |
| | 0702811 | BA bidet-module 1080mm | | 631578 | stuk | 225,00 | 487 | 1 |
| | 0700003 | BU bidet-module 825mm | | 631608 | stuk | 217,00 | 487 | 1 |
| | Burda Santro2000 Toebehoren | | | | | | | |
| | 0702838 | 190-S135 schachtelement | | 677057 | stuk | 165,00 | 487 | 1 |
| | 0702871 | tussendrager 1080mm D=190-220mm | | 667409 | stuk | 27,75 | 487 | 1 |
| | 0702874 | tussendrager 1080mm D=135-165mm | | 667430 | stuk | 27,75 | 487 | 1 |
| | 0702846 | A armaturenplaat v. opbouwkraan 1/2" | | 681658 | stuk | 47,00 | 487 | 1 |
| | 0702307 | hoekmontageset 45° | | 679150 | stuk | 87,50 | 487 | 0 |
| | 0704156 | stabilisatieset voor vrijstaande montage | | 679143 | stuk | 92,00 | 487 | 1 |
| | 0702854 | gipsplaat 1080x624x12,5mm | | 697024 | stuk | 17,75 | 487 | 0 |
| | 0702309 | zelfborende schroef per 100stuks | | 697338 | stuk | 5,80 | 487 | 1 |
| | Burda BS+ WC-module | | | | | | | |
| | 0704164 | Geberit-nieuw wc-module frontbediening | | 211089 | stuk | 221,00 | 487 | 1 |
| | Burda Combisets | | | | | | | |
| | 0702722 | wc-combiset Twico standaard compleet | | 511109 | stuk | 181,00 | 487 | 1 |
| | 0702730 | per pallet 12stuks | | 511016 | stuk | 185,00 | 487 | 1 |

| Art.nr | Specificaties | Kleur | Lev.nr | Ehd | Prijs | Grp | CC | |
|---|--|-------|--------|------|--------|-----|----|---|
| Viegaswift elementen | | | | | | | | |
| 8000/6 | wc-element 6-9liter hoogte 1130mm | | | | | | | |
| 0702323 | | | 456016 | stuk | 288,00 | 471 | 1 | Sanitair producten |
| afbouwpakket voor inbouwreservoir | | | | | | | | |
| 0704369 | | | 406851 | stuk | 396,00 | 471 | 1 | |
| Mono wc-installatie element | | | | | | | | |
| 0704483 | | | 382186 | stuk | 178,00 | 471 | 1 | Baden / douchebakken / stoomcabines |
| 8113 wastafel-element voor 1-gatskraan 1130mm | | | | | | | | |
| 0702374 | | | 315993 | stuk | 125,00 | 471 | 1 | Kranen |
| 8115 basiselement voor inbouw van modules | | | | | | | | |
| 0702404 | | | 331580 | stuk | 102,00 | 471 | 1 | |
| wc-afbouwpakket voor Geberit Nieuw | | | | | | | | |
| 0500941 | | | 338091 | stuk | 387,00 | 471 | 1 | Douchegarnituur |
| Viegaswift bouwsegmenten | | | | | | | | |
| 8001 montagerail 3000mm m. bevestigingsmateriaal | | | | | | | | |
| 0702315 | | | 283872 | stuk | 21,00 | 471 | 1 | Accessoires en spiegels |
| 8111/6 montagerail 530mm 2stuks | | | | | | | | |
| 0702359 | | | 331573 | stuk | 13,25 | 471 | 1 | Douchewanden |
| 8055/79 vloerbevestigingsset voor systeemwand | | | | | | | | |
| 0702337 | | | 331702 | stuk | 13,75 | 471 | 1 | |
| 8026 tussenconsole 1130x140/200mm | | | | | | | | |
| 0702447 | | | 284091 | stuk | 28,75 | 471 | 1 | Toebehoren & afvoeren |
| 8026 tussenconsole 980x140/200mm | | | | | | | | |
| 0702455 | | | 405755 | stuk | 34,75 | 471 | 1 | Spoel- & installatiesystemen |
| 8027 eindconsole links-rechts 1130x140/200mm | | | | | | | | |
| 0702498 | | | 284107 | stuk | 43,50 | 471 | 1 | Badkamermeubelen en toiletkasten |
| 8027 eindconsole links-rechts 980x140/200mm | | | | | | | | |
| 0702501 | | | 405762 | stuk | 43,50 | 471 | 1 | |
| 8076/1 eindprofiel 37x1250mm | | | | | | | | |
| 0702538 | | | 331658 | stuk | 11,50 | 471 | 1 | Gootstenen en wastroggen |
| 8056 hoekmontageset m. bevestigingsmateriaal 600x440mm | | | | | | | | |
| 0702528 | | | 284299 | stuk | 101,00 | 471 | 1 | Utiliteit |
| 8076 wandaansluitprofiel 90° 3000x40x40mm | | | | | | | | |
| 0702544 | | | 284459 | stuk | 24,25 | 471 | 1 | |
| 8077 hoekprofiel 45° 1120x50x30mm | | | | | | | | |
| 0702536 | | | 284466 | stuk | 13,25 | 471 | 1 | |
| 8118 inbouwframe voor systeemwand | | | | | | | | |
| 0702335 | | | 331740 | stuk | 30,00 | 471 | 1 | |
| Viegaswift modules | | | | | | | | |
| 8130 inbouwmodule voor wandbidet | | | | | | | | |
| 0702545 | | | 331733 | stuk | 98,50 | 471 | 1 | |
| 8063/0 montageplaat 43x40x7cm voor inbouwkransen | | | | | | | | |
| 0702440 | | | 297787 | stuk | 43,75 | 471 | 1 | |
| 8068 montageplaat voor wasmachine-aansluiting | | | | | | | | |
| 0080027 | | | 284381 | stuk | 49,75 | 471 | 1 | |
| 8096 houtplaat 400x200x22mm voor accessoires | | | | | | | | |
| 0702595 | | | 285319 | stuk | 20,25 | 471 | 1 | |

| | Art.nr | Specificaties | Kleur | Lev.nr | Ehd | Prijs | Grp | CC |
|---|------------------------------------|--|----------------|--------|------|-------|-----|----|
| | Viegaswift bedieningsplaten | | | | | | | |
| | afdekplaat frontbediening | | | | | | | |
| Sanitair producten | 0704377 | | wit | 407452 | stuk | 39,50 | 471 | 1 |
| | 0704458 | | pergamon | 427320 | stuk | 45,25 | 471 | 1 |
| | 0704466 | | chroom | 406912 | stuk | 51,50 | 471 | 1 |
| | 0704474 | | chr./edelmess. | 396220 | stuk | 51,00 | 471 | 1 |
| Baden / douchebakken / stoomcabines | Viegaswift Toebehoren | | | | | | | |
| | 0702388 | 8090/1 sprongstuk 120mm | | 340780 | stuk | 26,00 | 471 | 0 |
| | 0702390 | 8090 sprongstuk 180mm | | 294885 | stuk | 26,00 | 471 | 0 |
| | 0702560 | 8084 adaptor naar persverbinding 15mm | | 285401 | stuk | 5,50 | 471 | 1 |
| Kranen | 0702579 | 8082 adaptor naar 1/2" binnendraad | | 285364 | stuk | 3,03 | 471 | 1 |
| | 0702587 | 8083 adaptor naar soldeer 15mm | | 285388 | stuk | 2,47 | 471 | 1 |
| | 0702331 | 8029/8 GKFI-gipsplaat voor wc-element 1130mm | | 458430 | stuk | 19,00 | 471 | 1 |
| | 0702382 | 8029/2 GKFI-gipsplaat voor wastafel-element 1130mm | | 285227 | stuk | 19,25 | 471 | 1 |
| | 0702381 | 8029/4 GKFI-gipsplaat uni 1130x480mm | | 285241 | stuk | 16,75 | 471 | 1 |
| Douchegarnituur | 0702392 | 8099 gipsplaatschroef 3,5x25mm | | 284510 | stuk | 0,07 | 471 | 1 |
| Accessoires en spiegels | | | | | | | | |
| Douchewanden | | | | | | | | |
| Toebehoren & afvoeren | | | | | | | | |
| Spoel- & installatiesystemen | | | | | | | | |
| Badkamermeubelen en toiletkasten | | | | | | | | |
| Gootstenen en wastroggen | | | | | | | | |
| Utiliteit | | | | | | | | |

Elegant ontwerp en perfecte kwaliteit



Het attractieve en discrete ontwerp van de Grundfos Sololift+ opvoerinstallaties past bij elk interieurontwerp. Door de zachte en vloeiende lijnen van de Sololift+ is het eenvoudig om deze opvoerinstallaties toe te passen in zowel nieuwe als bestaande faciliteiten. De nieuwe Sololift+ ziet er niet alleen goed uit, maar werkt ook goed. Elk onderdeel van de nieuwe Sololift+ range is door en door getest om u van een betrouwbare prestatie, laag geluidsniveau en een lange levensduur te garanderen. Kijk voor meer informatie op grundfos.nl.

| | Art.nr | Specificaties | Kleur | Lev.nr | Ehd | Prijs | Grp | CC |
|---|----------------------------|---------------|-------|----------|------|--------|-----|----|
| Sanitair producten | Grundfos Lifaway-C | | | | | | | |
| | 405x275x340 | | | 96003985 | stuk | 239,00 | 806 | 1 |
| Baden / douchebakken / stoomcabines | Grundfos Liftaway-B | | | | | | | |
| | voor KP | | | 96003974 | stuk | 838,00 | 806 | 1 |
| Kranen | | | | | | | | |
| Douchegarnituur | | | | | | | | |
| Accessoires en spiegels | | | | | | | | |
| Douchewanden | | | | | | | | |
| Toebehoren & afvoeren | | | | | | | | |
| Spoel- & installatiesystemen | | | | | | | | |
| Badkamermeubelen en toiletkasten | | | | | | | | |
| Gootstenen en wastroggen | | | | | | | | |
| Utiliteit | | | | | | | | |

Achter elke deur een **SANIBROYEUR**[®]



*Wij willen graag een
wastafel in
ons tuinhuisje...*



*Wij willen graag een
wasmachine in de kelder...*



*Wij willen graag
een extra toilet...*

Het kan allemaal!



*Dankzij de nieuwste generatie
vuilwaterpompen en fecaliënvermalers
van **SANIBROYEUR**[®]*



www.sanibroyeur.nl

Met de vuilwaterpompen en fecaliënvermalers van SANIBROYEUR[®] kunt u sanitair installeren op elke gewenste plek! Door het uitgebreide assortiment is er voor elk sanitair-vraagstuk een oplossing. De eigentijdse producten van SANIBROYEUR[®] zijn bovendien stil, krachtig, compact en hebben een mooi design. Fabrikant SFA staat al 50 jaar garant voor kwaliteit en innovatie. De eigen servicedienst staat geheel tot uw beschikking!

SANIBROYEUR[®]
vuilwaterpompen en fecaliënvermalers

SFA Benelux BV • Voltaweg 4 6101 XK Echt (NL) • Postbus 160 6100 AD Echt (NL)
Tel: +31 475 487 100 fax: +31 475 486 515 sales@sfabeneluxbv.nl www.sfabeneluxbv.nl

SFA
BENELUX

Faecaliënvermalers

| | Art.nr | Specificaties | Kleur | Lev.nr | Ehd | Prijs | Grp | CC |
|---|--|---------------|----------|--------|------|---------|-----|----|
| Sanitair producten | Sanibroyeur X2 | | | | | | | |
| | faecaliënvermaler | | | | | | | |
| | 0620033 | | wit | 05010 | stuk | 510,00 | 377 | 0 |
| Baden / douchebakken / stoomcabines | Sanibroyeur de Luxe | | | | | | | |
| | faecaliënvermaler | | | | | | | |
| | 0620092 | | wit | 05098 | stuk | 441,00 | 377 | 0 |
| Kranen | Sanibroyeur Sanicom | | | | | | | |
| | faecaliënvermaler | | | | | | | |
| | 0620098 | | wit | 05201 | stuk | 830,00 | 377 | 1 |
| Douchegarnituur | Sanibroyeur Sanicompact C43 | | | | | | | |
| | faecaliënvermaler | | | | | | | |
| | 0620009 | | wit | 06097 | stuk | 758,00 | 377 | 0 |
| Accessoires en spiegels | Sanibroyeur Sanicompact C48 | | | | | | | |
| | faecaliënvermaler | | | | | | | |
| | 0620149 | | wit | 06096 | stuk | 758,00 | 377 | 0 |
| | 0620150 | | pergamon | 06089 | stuk | 758,00 | 377 | 1 |
| Douchewanden | Sanibroyeur Sanicompact Elite | | | | | | | |
| | faecaliënvermaler | | | | | | | |
| | 0620101 | | wit | 06049 | stuk | 906,00 | 377 | 1 |
| Toebehoren & afvoeren | Sanibroyeur Sanicompact Luxe | | | | | | | |
| | faecaliënvermaler | | | | | | | |
| | 0620068 | | wit | 06050 | stuk | 827,00 | 377 | 0 |
| | 0620070 | | pergamon | 06091 | stuk | 827,00 | 377 | 1 |
| Spoel- & installatiesystemen | Sanibroyeur Sanicompact Star | | | | | | | |
| | faecaliënvermaler | | | | | | | |
| | 0620165 | m. zitting | wit | 06120 | stuk | 944,00 | 377 | 0 |
| | 0620173 | m. zitting | pergamon | 06120 | stuk | 944,00 | 377 | 1 |
| Badkamermeubelen en toiletkasten | Sanibroyeur Sanicondens | | | | | | | |
| | faecaliënvermaler | | | | | | | |
| | 0620096 | | wit | 05082 | stuk | 128,00 | 377 | 1 |
| Gootstenen en wastroggen | Sanibroyeur Sanicubic | | | | | | | |
| | faecaliënvermaler | | | | | | | |
| | 0620099 | | wit | 05202 | stuk | 1932,00 | 377 | 1 |
| Utiliteit | Sanibroyeur Sanibest | | | | | | | |
| | vermaler voor meerdere toestellen | | | | | | | |
| | 0620181 | | | 05070 | stuk | 903,00 | 377 | 1 |
| | Sanibroyeur Sanidouche | | | | | | | |
| | faecaliënvermaler | | | | | | | |
| | 0620095 | | wit | 05079 | stuk | 441,00 | 377 | 1 |
| | Sanibroyeur Saniplus | | | | | | | |
| | faecaliënvermaler | | | | | | | |
| | 0620114 | | wit | 05047 | stuk | 729,00 | 377 | 0 |
| | Sanibroyeur Sanipack | | | | | | | |
| | faecaliënvermaler | | | | | | | |
| | 0620004 | | wit | 05050 | stuk | 667,00 | 377 | 1 |
| | Sanibroyeur Sanipro | | | | | | | |
| | faecaliënvermaler | | | | | | | |
| | 0620093 | | wit | 05046 | stuk | 666,00 | 377 | 1 |
| | Sanibroyeur Sanispeed | | | | | | | |
| | faecaliënvermaler | | | | | | | |
| | 0620097 | | wit | 05200 | stuk | 641,00 | 377 | 1 |

| Art.nr | Specificaties | Kleur | Lev.nr | Ehd | Prijs | Grp | CC |
|-------------------------------------|---|-------|----------|------|--------|-----|----|
| Sanibroyeur Sanitop | | | | | | | |
| faecaliënvermaler 0620106 | | wit | 05037 | stuk | 572,00 | 377 | 0 |
| Sanibroyeur Sanivite | | | | | | | |
| vuilwaterpomp 0620157 | | wit | 05096 | stuk | 595,00 | 377 | 0 |
| Sanibroyeur Toebehoren | | | | | | | |
| 0620130 | rubber afvoermanchet voor faecaliënvermaler | | AU010121 | stuk | 32,50 | 377 | 1 |
| 0620103 | speciaal ontkalker 5 liter | | 05007 | stuk | 27,00 | 377 | 0 |



- Sanitair producten
- Baden /
douchebakken /
stoomcabines
- Kranen
- Douchegarnituur
- Accessoires en
spiegels
- Douchewanden
- Toebehoren &
afvoeren
- Spoel- &
installatiesystemen**
- Badkamermeubelen
en toiletkasten
- Gootstenen en
wastroggen
- Utiliteit

| | Art.nr | Specificaties | Kleur | Lev.nr | Ehd | Prijs | Grp | CC | |
|---|-----------------------------|--|---|-----------|---------------|--------|-------|-----|---|
| Sanitair producten | Aqua closetspoelers | | | | | | | | |
| | | Aqualine closetspoeler 3/4" opbouw | | | | | | | |
| | 0720429 | | chrom | 26280032 | stuk | 108,00 | 383 | 0 | |
| Baden / douchebakken / stoomcabines | | Aqualine closetspoeler 3/4" opbouw vandaalbestendig | | | | | | | |
| | 0721417 | | chrom | 26280033 | stuk | 123,00 | 383 | 1 | |
| Kranen | | Aquarex closetspoeler 3/4" | | | | | | | |
| | 0720405 | | chrom | 26220132 | stuk | 176,00 | 383 | 1 | |
| Douchegarnituur | Aqua urinoirspoelers | | | | | | | | |
| | | Aqualine urinoirspoeler 1/2" opbouw | | | | | | | |
| | 0720410 | | chrom | 25210222 | stuk | 112,00 | 383 | 0 | |
| | | Aqualine urinoirspoeler 1/2" opbouw vandaalbestendig | | | | | | | |
| | 0721409 | | chrom | 25210223 | stuk | 124,00 | 383 | 1 | |
| Accessoires en spiegels | | Protronic urinoirspoeler opbouw opto-elektronisch gestuurd 1/2" | | | | | | | |
| | 0720414 | | chrom | 55780023 | stuk | 367,00 | 383 | 1 | |
| Douchewanden | | inbouwset voor opto-elektronisch bestuurd urinoirspoeler 1/2" | | | | | | | |
| | 0720451 | | | 55260124R | stuk | 386,00 | 383 | 1 | |
| Toebehoren & afvoeren | | IR urinoirplaat 230V | | | | | | | |
| | 0720456 | | | 55260124F | stuk | 386,00 | 383 | 1 | |
| | | IR urinoirplaat 6V | | | | | | | |
| | 0720459 | | | 55260024F | stuk | 413,00 | 383 | 1 | |
| Spoel- & installatiesystemen | Aqua Onderdelen | | | | | | | | |
| | | 0720380 | bovendeel voor urinoirspoeler 1/2" chrom | | 25000322 | stuk | 85,00 | 383 | 1 |
| | | 0720216 | bovendeel voor closetspoeler 3/4" | | 26002032 | stuk | 96,50 | 383 | 1 |
| | | 0720240 | rubber sok voor urinoirspoeler 1/2" | | 8202401001VPE | stuk | 2,73 | 383 | 0 |
| | | 0720259 | rubber sok voor closetspoeler 3/4" | | 8202401002VPE | stuk | 3,31 | 383 | 0 |
| | | 0730211 | spoelerpijp 1/2" voor urinoir sprong 2,5 cm chrom | | CUSP149 | stuk | 32,25 | 353 | 0 |
| Gootstenen en wastroggen | | | | | | | | | |
| Utiliteit | | | | | | | | | |

| Art.nr | Specificaties | Kleur | Lev.nr | Ehd | Prijs | Grp | CC |
|---|---------------|-----------|-----------|------|--------|-----|----|
| Geberit Electronic | | | | | | | |
| inbouwkast voor urinoirspoeler | | | | | | | |
| 0700929 | | | 115801001 | stuk | 75,50 | 329 | 0 |
| electronic afbouwset urinoir | | | | | | | |
| 2200708 | | edelmat | 115802461 | stuk | 408,00 | 467 | 1 |
| 0705539 | | wit | 115802111 | stuk | 408,00 | 467 | 1 |
| UR60 afbouwset voor urinoir batterij | | | | | | | |
| 0701820 | | wit | 115804111 | stuk | 408,00 | 329 | 1 |
| 0701825 | | matchroom | 115804461 | stuk | 408,00 | 329 | 1 |

Sanitair producten

Baden /
douchebakken /
stoomcabines

Kranen

Doucheapparatuur

Accessoires en
spiegels

Douchewanden









Toebehoren &
afvoeren

Spoel- &
installatiesystemen

Badkamermeubelen
en toiletkasten

Gootstenen en
wastroggen

Utiliteit

| | Art.nr | Specificaties | Kleur | Lev.nr | Ehd | Prijs | Grp | CC |
|---|---|--|-----------|----------|----------|--------|-------|-------|
| Sanitair producten | cloetspoelers Grohedal | | | | | | | |
| | cloetspoeler 3/4" | | | | | | | |
| | | 0720127 | | chrom | 37139000 | stuk | 60,00 | 353 0 |
| | | 0720305 | | chrom | 37141000 | stuk | 74,00 | 353 0 |
| | 0720399 | | chrom | 371451K0 | stuk | 138,00 | 353 1 | |
| Baden / douchebakken / stoomcabines |  | | | | | | | |
| Kranen |  | | | | | | | |
| Douchegarnituur |  | cloetspoeler 3/4" inbouw z. afdekplaat 0720526 | | 37153000 | stuk | 207,00 | 353 1 | |
| Accessoires en spiegels |  | | | | | | | |
| Douchewanden |  | urinoirspoelers Grohedal urinoirspoeler 1/2" opbouw z. stopkraan m. pijpje 0720119 | chrom | 37025000 | stuk | 60,00 | 353 0 | |
| Toebehoren & afvoeren |  | urinoirspoeler 1/2" opbouw vandaal bestendig m. pijpje 0720461 | chrom | 37024000 | stuk | 97,00 | 353 0 | |
| Spoel- & installatiesystemen |  | urinoirspoeler 1/2" opbouw m. pijpje 0720372 | | 37021000 | stuk | 84,50 | 353 0 | |
| Badkamermeubelen en toiletkasten |  | Tectron urinoirspoeler infrarood 0721663 | chrom | 37713000 | stuk | 302,00 | 383 1 | |
| Gootstenen en wastroggen |  | urinoirspoeler 1/2" inbouw z. afdekplaat 0720348 | | 37017000 | stuk | 96,50 | 353 0 | |
| Utiliteit | | Skate afdekplaat v.urinoirspoeler 0721654 m.transformator | chrom | 37749000 | stuk | 406,00 | 383 1 | |
| | | 0721662 m.transformator | RVS | 37749SD0 | stuk | 406,00 | 383 1 | |
| | | afdekplaten Grohedal Surf afdekplaat voor inbouwspoeler urinoir 0733257 | chrom | 37018000 | stuk | 50,50 | 353 0 | |
| | | 0720356 | mat chrom | 37018P00 | stuk | 50,50 | 353 0 | |
| | | 0720402 | wit | 37018SH0 | stuk | 50,50 | 353 0 | |
| | | 0720404 | pergamon | 37018SP0 | stuk | 50,50 | 353 0 | |

| Art.nr | Specificaties | Kleur | Lev.nr | Ehd | Prijs | Grp | CC |
|--------|---------------|-------|--------|-----|-------|-----|----|
|--------|---------------|-------|--------|-----|-------|-----|----|

afdekplaten Grohedal

Skate afdekplaat voor urinoir

| | | | | | | | |
|---------|--|-----------|----------|------|-------|-----|---|
| 0102524 | | chroom | 38595000 | stuk | 50,50 | 353 | 1 |
| 0102525 | | matchroom | 38595P00 | stuk | 50,50 | 353 | 1 |
| 0102526 | | wit | 38595SH0 | stuk | 50,50 | 353 | 1 |



Sanitair producten

Baden /
douchebakken /
stoomcabines

Surf afdekplaat wandbediening

| | | | | | | | |
|---------|--|-----|----------|------|-------|-----|---|
| 0720550 | | RVS | 37019000 | stuk | 77,50 | 353 | 0 |
|---------|--|-----|----------|------|-------|-----|---|



Kranen

Douchegarnituur

Onderdelen Grohedal

| | | | | | | | |
|---------|--|--------|----------|------|--------|-----|---|
| 0730459 | spoelerpijp 1/2" m. sprong 2cm m. O-ring | chroom | 37037000 | stuk | 16,50 | 353 | 0 |
| 0730364 | spoelerpijp 1/2" m. sprong 3cm | chroom | 37038000 | stuk | 18,25 | 353 | 0 |
| 0730408 | spoelerpijp 1/2" recht m. O-ring | chroom | 37035000 | stuk | 9,20 | 353 | 1 |
| 0720011 | inlaatgarnituur achterinlaat | | 37044000 | stuk | 12,50 | 353 | 0 |
| 0730491 | valpijp voor slophopper | | 37111000 | stuk | 44,25 | 353 | 1 |
| 0720194 | bedieningsknop voor 570 | | 43416000 | stuk | 18,50 | 353 | 1 |
| 0102466 | kolfje compleet | | 43544000 | stuk | 7,70 | 353 | 0 |
| 0720283 | set dichtingen voor closetspoeler 3/4" 620 | | 43706000 | stuk | 8,50 | 353 | 1 |
| 0720291 | set dichtingen voor closetspoeler 3/4" 622 | | 43707000 | stuk | 9,00 | 353 | 1 |
| 0720496 | inbouwset 192x95x240mm Surf voor infrarood elektronica 37005 | | 37006000 | stuk | 94,50 | 353 | 1 |
| 0720197 | zuiger | | 43450000 | stuk | 14,75 | 353 | 0 |
| 0720489 | urinoirspoeler ombouw (opbouw) | | 37640000 | stuk | 224,00 | 383 | 0 |
| 0720500 | deksel voor urinoirspoeler | | 43102000 | stuk | 32,75 | 353 | 0 |
| 0436272 | valpijpbevestiging compleet | | 43304000 | stuk | 8,70 | 353 | 1 |
| 0720156 | binnenwerk compleet | | 43812000 | stuk | 40,75 | 333 | 1 |
| 0720292 | dichtingsset compleet | | 43719000 | stuk | 12,75 | 353 | 1 |
| 0730366 | urinoir spoelerpijp verlengstuk 20cm | | 37042000 | stuk | 13,00 | 353 | 1 |

Accessoires en
spiegels

Douchewanden

Toebehoren &
afvoeren

Spoel- &
installatiesystemen

Badkamermeubelen
en toiletkasten

Gootstenen en
wastroggen

Utiliteit

| | Art.nr | Specificaties | Kleur | Lev.nr | Ehd | Prijs | Grp | CC | |
|---|---|--|------------|-----------|------|--------|-----|----|--|
| | cloetspoelers Schell | | | | | | | | |
| | cloetspoeler 3/4" opbouw | | | | | | | | |
| Sanitair producten | 0440202 | | chroom | 022470699 | stuk | 147,00 | 353 | 1 | |
| | Verona bedieningsplaat m. drukknop voor inbouwcloetspoeler | | | | | | | | |
| | 0440078 | | chroom | 032040699 | stuk | 117,00 | 210 | 1 | |
| Baden / douchebakken / stoomcabines | 0440079 | | alpine wit | 032041599 | stuk | 162,00 | 210 | 1 | |
| | 0440081 | | matchroom | 032046499 | stuk | 117,00 | 210 | 1 | |
| | 0440080 | vandaalbestendig | RVS | 032042899 | stuk | 180,00 | 210 | 1 | |
| | Verona Edition bedieningsplaat voor inbouwcloetspoeler | | | | | | | | |
| | 0440076 | | chroom | 032360699 | stuk | 290,00 | 210 | 1 | |
| Kranen | | Verona Eco bedieningsplaat m. Eco drukknop voor inbouwcloetspoeler | | | | | | | |
| | 0440082 | | chroom | 032220699 | stuk | 182,00 | 210 | 1 | |
| Douchegarnituur | | wc-montageframe voor wandcloset | | | | | | | |
| | 0440092 | | | 032300099 | stuk | 504,00 | 210 | 1 | |
| | wandhouder voor montageframe | | | | | | | | |
| | 0440069 | | | 032330099 | stuk | 23,50 | 210 | 1 | |
| Accessoires en spiegels | | Compact bedieningspaneel voor closetinbouwspoeler | | | | | | | |
| | 0440084 | | chroom | 032340699 | stuk | 96,50 | 210 | 1 | |
| | 0440085 | | alpine wit | 032341599 | stuk | 158,00 | 210 | 1 | |
| Douchewanden | 0440090 | | RVS | 032342899 | stuk | 125,00 | 210 | 1 | |
| | 0440091 | | matchroom | 032346499 | stuk | 125,00 | 210 | 1 | |
| | Compact Edition bedieningspaneel voor closetinbouwspoeler | | | | | | | | |
| | 0440083 | | chroom | 011610699 | stuk | 257,00 | 210 | 1 | |
| Toebehoren & afvoeren | urinoirspoelers Schell | | | | | | | | |
| | urinoirspoeler 1/2" opbouw m. pijpje z. stopkraan | | | | | | | | |
| | 0440201 | | chroom | 024830699 | stuk | 137,00 | 353 | 0 | |
| Spoel- & installatiesystemen | | urinoirspoeler 1/2" opbouw m. pijpje m. stopkraan | | | | | | | |
| | 0440200 | | chroom | 024840699 | stuk | 136,00 | 353 | 1 | |
| Badkamermeubelen en toiletkasten | | inbouw urinoirsturing 230V m. sensor | | | | | | | |
| | 0440215 | | | 011650099 | stuk | 996,00 | 210 | 1 | |
| | inbouw urinoirsturing batterijvoeding 6x1.5V m. sensor | | | | | | | | |
| | 0440216 | | | 011660099 | stuk | 996,00 | 210 | 1 | |
| Gootstenen en wastroggen | | urinoirspoeler 1/2" opbouw infrarood batterijgestuurd m.pijpje m. stopkraan | | | | | | | |
| | 0720887 | | chroom | 011150699 | stuk | 408,00 | 369 | 1 | |
| Utiliteit |  | | | | | | | | |
| | Onderdelen Schell | | | | | | | | |
| | 0720836 | Schellomat zuiger compleet | | 293120099 | stuk | 18,00 | 353 | 1 | |

Badkamermeubelen en toiletkasten

| | |
|-------------------------------|------|
| Meubelen Burg | 1220 |
| Meubelen Dansani | 1223 |
| Meubelen Detremmerie | 1224 |
| Meubelen Duravit | 1249 |
| Meubelen + spiegelkasten Emco | 1259 |
| Meubelen Inda | 1261 |
| Meubelen Plieger | 1263 |
| Meubelen Riho | 1266 |
| Meubelen SaniJura | 1272 |
| Meubelen Schock | 1274 |
| Spiegelkasten Keuco | 1282 |
| Spiegelkasten Schock | 1284 |
| Spiegelkasten Schneider | 1287 |
| Spiegelkasten Plieger | 1291 |
| Spiegelkasten Villeroy & Boch | 1292 |

Badkamermeubelen en
toiletkasten

| | Art.nr | Specificaties | Kleur | Lev.nr | Ehd | Prijs | Grp | CC | |
|--|---|----------------|-----------------|-----------------|--------------|---------|---------|-----|---|
| Burg Crono meubelen | | | | | | | | | |
| wastafel | | | | | | | | | |
| Sanitair producten | 0990096 | 81x50cm | glans wit | 1MES8065 | stuk | 765,00 | 320 | 1 | |
| | 0990097 | 81x50cm | glans pergamon | 9MES8065 | stuk | 765,00 | 320 | 1 | |
| | 0990098 | 121x50cm links | glans wit | 1MES1265L | stuk | 914,00 | 320 | 1 | |
| | 0990099 | 121x50cm links | glans pergamon | 9MES1265L | stuk | 914,00 | 320 | 1 | |
| | Baden / douchebakken / stoomcabines | 0990101 | 121x50cm rechts | glans wit | 1MES1265R | stuk | 914,00 | 320 | 1 |
| | | 0990103 | 121x50cm rechts | glans pergamon | 9MES1265R | stuk | 914,00 | 320 | 1 |
| | | 0990105 | 161x50cm | glans wit | 1MES1665 | stuk | 1073,00 | 320 | 1 |
| 0990107 | 161x50cm | glans pergamon | 9MES1665 | stuk | 1073,00 | 320 | 1 | | |
| wastafel dubbel | | | | | | | | | |
| Kranen | 0990110 | 201cm | glans wit | 1MDS2065 | stuk | 1443,00 | 320 | 1 | |
| | 0990117 | 201cm | glans pergamon | 9MDS2065 | stuk | 1443,00 | 320 | 1 | |
| wastafelonderbouw m. gedeeld front m. 1 lade | | | | | | | | | |
| Douchegarnituur | 0990135 | 80cm | chroom/glanswit | 1020WTS8060 | stuk | 817,00 | 320 | 1 | |
| | 0990139 | 80cm | matchroom/tabak | 1032WTS8060 | stuk | 817,00 | 320 | 1 | |
| | 0990141 | 120cm links | chroom/glanswit | 1020WTS1260L | stuk | 985,00 | 320 | 1 | |
| | 0990142 | 120cm links | matchroom/tabak | 1032WTS1260L | stuk | 985,00 | 320 | 1 | |
| | Accessoires en spiegels | 0990143 | 120cm rechts | chroom/glanswit | 1020WTS1260R | stuk | 985,00 | 320 | 1 |
| | | 0990144 | 120cm rechts | matchroom/tabak | 1032WTS1260R | stuk | 985,00 | 320 | 1 |
| wastafelonderbouw m. gedeeld front m. 2 laden | | | | | | | | | |
| | 0990145 | 160cm | chroom/glanswit | 1020WTS1661 | stuk | 1876,00 | 320 | 1 | |
| | 0990146 | 160cm | matchroom/tabak | 1032WTS1661 | stuk | 1876,00 | 320 | 1 | |
| wastafelonderbouw m. gedeeld front m. 3 laden | | | | | | | | | |
| Douchewanden | 0990147 | 200cm | chroom/glanswit | 1020WTS2066 | stuk | 2484,00 | 320 | 1 | |
| | 0990148 | 200cm | matchroom/tabak | 1032WTS2066 | stuk | 2484,00 | 320 | 1 | |
| wastafelonderbouw m. 1 lade | | | | | | | | | |
| Toebehoren & afvoeren | 0990118 | 80cm | chroom/glanswit | 1020WTS8064 | stuk | 711,00 | 320 | 1 | |
| | 0990119 | 80cm | matchroom/tabak | 1032WTS8064 | stuk | 711,00 | 320 | 1 | |
| | 0990120 | 120cm links | chroom/glanswit | 1020WTS1264L | stuk | 851,00 | 320 | 1 | |
| | 0990121 | 120cm links | matchroom/tabak | 1032WTS1264L | stuk | 851,00 | 320 | 1 | |
| | Spoel- & installatiesystemen | 0990122 | 120cm rechts | chroom/glanswit | 1020WTS1264R | stuk | 851,00 | 320 | 1 |
| 0990123 | | 120cm rechts | matchroom/tabak | 1032WTS1264R | stuk | 851,00 | 320 | 1 | |
| wastafelonderbouw m. 2 laden | | | | | | | | | |
| | 0990125 | 160cm | chroom/glanswit | 1020WTS1665 | stuk | 1650,00 | 320 | 1 | |
| | 0990126 | 160cm | matchroom/tabak | 1032WTS1665 | stuk | 1650,00 | 320 | 1 | |
| wastafelonderbouw m. 3 laden | | | | | | | | | |
| Badkamermeubelen en toiletkasten | 0990133 | 200cm | chroom/glanswit | 1020WTS2068 | stuk | 1986,00 | 320 | 1 | |
| | 0990134 | 200cm | matchroom/tabak | 1032WTS2068 | stuk | 1986,00 | 320 | 1 | |
| meubelset | | | | | | | | | |
| Gootstenen en wastroggen | 0990149 | 120cm links | chroom/glanswit | 1020MGK2410L1 | stuk | 3513,00 | 320 | 1 | |
| | 0990151 | 120cm links | matchroom/tabak | 1032MGK2410L1 | stuk | 3513,00 | 320 | 1 | |
| | 0990152 | 120cm rechts | chroom/glanswit | 1020MGK2410R1 | stuk | 3513,00 | 320 | 1 | |
| | 0990153 | 120cm rechts | matchroom/tabak | 1032MGK2410R1 | stuk | 3513,00 | 320 | 1 | |
| Utiliteit | 0990154 | 160cm | chroom/glanswit | 1020MGK24121 | stuk | 4936,00 | 320 | 1 | |
| | 0990155 | 160cm | matchroom/tabak | 1032MGK24121 | stuk | 4936,00 | 320 | 1 | |
| | 0990156 | 200cm | chroom/glanswit | 1020MGK24141 | stuk | 6196,00 | 320 | 1 | |
| | 0990157 | 200cm | matchroom/tabak | 1032MGK24141 | stuk | 6196,00 | 320 | 1 | |
| meubelset m. lichttherapie | | | | | | | | | |
| | 0990158 | 120cm links | chroom/glanswit | 1020MGK2411L1 | stuk | 4066,00 | 320 | 1 | |
| | 0990160 | 120cm links | matchroom/tabak | 1032MGK2411L1 | stuk | 4066,00 | 320 | 1 | |
| | 0990161 | 120cm rechts | chroom/glanswit | 1020MGK2411R1 | stuk | 4066,00 | 320 | 1 | |
| | 0990162 | 120cm rechts | matchroom/tabak | 1032MGK2411R1 | stuk | 4066,00 | 320 | 1 | |
| | 0990164 | 160cm | chroom/glanswit | 1020MGK24131 | stuk | 5487,00 | 320 | 1 | |
| | 0990165 | 160cm | matchroom/tabak | 1032MGK24131 | stuk | 5487,00 | 320 | 1 | |
| | 0990166 | 200cm | chroom/glanswit | 1020MGK24151 | stuk | 6749,00 | 320 | 1 | |
| | 0990168 | 200cm | matchroom/tabak | 1032MGK24151 | stuk | 6749,00 | 320 | 1 | |
| | spiegelkast | | | | | | | | |
| | | 0990169 | 80cm | glans wit | 1020SLF8060 | stuk | 1474,00 | 320 | 1 |
| 0990170 | | 80cm | tabak | 1032SLF8060 | stuk | 1474,00 | 320 | 1 | |
| 0990171 | | 120cm links | glans wit | 1020SLF1260L | stuk | 1749,00 | 320 | 1 | |
| 0990172 | | 120cm links | tabak | 1032SLF1260L | stuk | 1749,00 | 320 | 1 | |
| 0990173 | | 120cm rechts | glans wit | 1020SLF1260R | stuk | 1749,00 | 320 | 1 | |
| 0990174 | | 120cm rechts | tabak | 1032SLF1260R | stuk | 1749,00 | 320 | 1 | |
| 0990176 | | 160cm | glans wit | 1020SLF1660 | stuk | 1988,00 | 320 | 1 | |
| 0990177 | | 160cm | tabak | 1032SLF1660 | stuk | 1988,00 | 320 | 1 | |
| 0990178 | | 200cm | glans wit | 1020SLF2060 | stuk | 2271,00 | 320 | 1 | |
| 0990179 | | 200cm | tabak | 1032SLF2060 | stuk | 2271,00 | 320 | 1 | |

| Art.nr | Specificaties | Kleur | Lev.nr | Ehd | Prijs | Grp | CC |
|---|---------------|-----------|--------------|------|---------|-----|----|
| Burg Crono meubelen | | | | | | | |
| spiegelkast m. lichttherapie | | | | | | | |
| 0990180 | 80cm | glans wit | 1020SLF8065 | stuk | 2027,00 | 320 | 1 |
| 0990181 | 80cm | tabak | 1032SLF8065 | stuk | 2027,00 | 320 | 1 |
| 0990182 | 120cm links | glans wit | 1020SLF1265L | stuk | 2302,00 | 320 | 1 |
| 0990187 | 120cm links | tabak | 1032SLF1265L | stuk | 2302,00 | 320 | 1 |
| 0990188 | 120cm rechts | glans wit | 1020SLF1265R | stuk | 2302,00 | 320 | 1 |
| 0990189 | 120cm rechts | tabak | 1032SLF1265R | stuk | 2302,00 | 320 | 1 |
| 0990190 | 160cm | glans wit | 1020SLF1665 | stuk | 2540,00 | 320 | 1 |
| 0990192 | 160cm | tabak | 1032SLF1665 | stuk | 2540,00 | 320 | 1 |
| 0990193 | 200cm | glans wit | 1020SLF2065 | stuk | 2823,00 | 320 | 1 |
| 0990194 | 200cm | tabak | 1032SLF2065 | stuk | 2823,00 | 320 | 1 |
| halfhoge kast m. 6 laden | | | | | | | |
| 0990203 | 40cm | glans wit | 1020UHP4060 | stuk | 1804,00 | 320 | 1 |
| 0990204 | 40cm | tabak | 1032UHP4060 | stuk | 1804,00 | 320 | 1 |
| halfhoge kast m. 1 deur m. 2 laden | | | | | | | |
| 0990199 | 40cm links | glans wit | 1020UHP4062L | stuk | 1150,00 | 320 | 1 |
| 0990200 | 40cm links | tabak | 1032UHP4062L | stuk | 1150,00 | 320 | 1 |
| 0990201 | 40cm rechts | wit | 1020UHP4062R | stuk | 1150,00 | 320 | 1 |
| 0990202 | 40cm rechts | tabak | 1032UHP4062R | stuk | 1150,00 | 320 | 1 |
| halfhoge kast m. 1 deur | | | | | | | |
| 0990195 | 40cm links | wit | 1020UHP4066L | stuk | 584,00 | 320 | 1 |
| 0990196 | 40cm links | tabak | 1032UHP4066L | stuk | 584,00 | 320 | 1 |
| 0990197 | 40cm rechts | wit | 1020UHP4066R | stuk | 584,00 | 320 | 1 |
| 0990198 | 40cm rechts | tabak | 1032UHP4066R | stuk | 584,00 | 320 | 1 |
| schappenwand | | | | | | | |
| 0990208 | 40.5cm | wit | 1020WA4065 | stuk | 122,00 | 320 | 1 |
| 0990209 | 40.5cm | tabak | 1032WA4065 | stuk | 122,00 | 320 | 1 |

Sanitair producten

Baden /
douchebakken /
stoomcabines

Kranen

Douchegarnituur

Accessoires en
spiegels

Douchewanden

Toebehoren &
afvoerenSpoel- &
installatiesystemenBadkamermeubelen
en toiletkastenGootstenen en
wastroggen

Utiliteit

Crono 1.0



drie dimensies badkamers. **burg**

grano



schock
Het origineel in uw badkamer.

| Art.nr | Specificaties | Kleur | Lev.nr | Ehd | Prijs | Grp | CC | | |
|---------|--|---------|-----------|------|---------|-----|----|---|---|
| | | | | | | | | Dansani Geysir | |
| 0992291 | meubelset 95cm hoge kast links of rechts | wit/wit | G700034 | stuk | 1378,00 | 311 | 1 |  | Sanitair producten |
| 0992461 | meubelset m. spots 120cm | wit/wit | G030034 | stuk | 1964,00 | 311 | 1 |  | Baden / douchebakken / stoomcabines |
| 0992380 | meubelset 135cm hoge kast links of rechts | wit/wit | G040034 | stuk | 1355,00 | 311 | 1 |  | Kranen |
| 0992526 | hoge kast m. lade links | wit/wit | G9300 | stuk | 360,00 | 311 | 1 |  | Douchegarnituur |
| 0992607 | handdoekhouder | chroom | 189601243 | stuk | 59,00 | 311 | 1 | | Accessoires en spiegels |

Badkamermeubelen
en toiletkasten

Gootstenen en
wastroggen

Utiliteit

| | Art.nr | Specificaties | Kleur | Lev.nr | Ehd | Prijs | Grp | CC |
|---|-------------------------------|---|-----------|----------------|------|--------|-----|----|
| Sanitair producten | Detremmerie Wastafels | | | | | | | |
| | | Epsilon wastafel rechthoekig 0957607 59.5x50x16cm | wit | 99940103000000 | stuk | 430,00 | 301 | 1 |
| Baden / douchebakken / stoomcabines | | Omega wastafel 0956619 Ø49cm | wit | 99940106000000 | stuk | 321,00 | 301 | 1 |
| Kranen | | Iota wastafel 0956627 59.5x50x8cm | wit | 99940103000001 | stuk | 430,00 | 301 | 1 |
| Douchegarnituur | | Alpha waskom 0954755 40cm | wit | 99940100100000 | stuk | 278,00 | 301 | 1 |
| Accessoires en spiegels | | MU wastafel m. kraangat 0954760 70.5x46cm | wit | 99940108000000 | stuk | 660,00 | 301 | 1 |
| Douchewanden | | MU wastafel z. kraangat 0954762 70.5x46cm | wit | 99940108000100 | stuk | 660,00 | 301 | 1 |
| Toebehoren & afvoeren | | PSI wastafel 0954765 75x50cm | wit | 99940411907500 | stuk | 397,00 | 301 | 1 |
| Spoel- & installatiesystemen | | 0954766 75x50cm | pergamon | 99940411907501 | stuk | 397,00 | 301 | 1 |
| Badkamermeubelen en toiletkasten | | sifon voor waskom z. overloop 0152040 | | DSTA | stuk | 66,00 | 301 | 1 |
| Gootstenen en wastroggen | | sifon voor waskom m. overloop 0152042 | | DSTB | stuk | 12,00 | 301 | 1 |
| Utiliteit | | afsluitbare designplug met sifon 0152043 | chroom | DSTC | stuk | 152,00 | 301 | 1 |
| | Detremmerie Universeel | | | | | | | |
| | | handdoekhouder 45cm 0956604 | matchroom | 5039860000 | stuk | 36,00 | 301 | 1 |

| Art.nr | Specificaties | Kleur | Lev.nr | Ehd | Prijs | Grp | CC |
|--------|---------------|-------|--------|-----|-------|-----|----|
|--------|---------------|-------|--------|-----|-------|-----|----|

Detremmerie Atlantic Beach

kolomkast m. kruiskader

| | | | | | | | |
|---------|--------------------|-------------|-----------------|------|---------|-----|---|
| 0954663 | 165x40x30cm links | wit | 074221177040101 | stuk | 1256,00 | 301 | 1 |
| 0954664 | 165x40x30cm links | kiezelgrijs | 074221177040102 | stuk | 1256,00 | 301 | 1 |
| 0954665 | 165x40x30cm rechts | wit | 074221177040201 | stuk | 1256,00 | 301 | 1 |
| 0954666 | 165x40x30cm rechts | kiezelgrijs | 074221177040202 | stuk | 1256,00 | 301 | 1 |



Sanitair producten

Baden /
douchebakken /
stoomcabines**kolomkast**

| | | | | | | | |
|---------|--------------------|-------------|-----------------|------|---------|-----|---|
| 0954668 | 165x40x30cm links | wit | 074221178040101 | stuk | 1212,00 | 301 | 1 |
| 0954669 | 165x40x30cm links | kiezelgrijs | 074221178040102 | stuk | 1212,00 | 301 | 1 |
| 0954670 | 165x40x30cm rechts | wit | 074221178040201 | stuk | 1212,00 | 301 | 1 |
| 0954671 | 165x40x30cm rechts | kiezelgrijs | 074221178040202 | stuk | 1212,00 | 301 | 1 |



Kranen

spiegel m. verlichting

| | | | | | | | |
|---------|------------|-------------|-----------------|------|--------|-----|---|
| 0954693 | 75x73.5cm | wit | 074245738075001 | stuk | 525,00 | 301 | 1 |
| 0954694 | 75x73.5cm | kiezelgrijs | 074245738075002 | stuk | 525,00 | 301 | 1 |
| 0954695 | 150x73.5cm | wit | 074245738150001 | stuk | 731,00 | 301 | 1 |
| 0954696 | 150x73.5cm | kiezelgrijs | 074245738150002 | stuk | 731,00 | 301 | 1 |



Douchegarnituur

Accessoires en
spiegels

Douchewanden

spiegelkast m. draaideur m. verlichting

| | | | | | | | |
|---------|------------------|-------------|-----------------|------|---------|-----|---|
| 0954688 | 75x73.5cm links | wit | 074242873075101 | stuk | 1015,00 | 301 | 1 |
| 0954689 | 75x73.5cm links | kiezelgrijs | 074242873075102 | stuk | 1015,00 | 301 | 1 |
| 0954690 | 75x73.5cm rechts | wit | 074242873075201 | stuk | 1015,00 | 301 | 1 |
| 0954692 | 75x73.5cm rechts | kiezelgrijs | 074242873075202 | stuk | 1015,00 | 301 | 1 |

Toebehoren &
afvoerenSpoel- &
installatiesystemen**spiegelkast m. draaideuren m. verlichting**

| | | | | | | | |
|---------|------------|-------------|-----------------|------|---------|-----|---|
| 0954686 | 150x73.5cm | wit | 074242873150001 | stuk | 1520,00 | 301 | 1 |
| 0954687 | 150x73.5cm | kiezelgrijs | 074242873150002 | stuk | 1520,00 | 301 | 1 |

Badkamermeubelen
en toiletkastenGootstenen en
wastroggen**meubelset m. spiegel 75cm**

| | | | | | | | |
|---------|-----------------|-------------|-----------|------|---------|-----|---|
| 0953696 | z. kraangat | wit | 074075PZ1 | stuk | 2051,00 | 301 | 1 |
| 0953697 | z. kraangat | kiezelgrijs | 074075PZ2 | stuk | 2051,00 | 301 | 1 |
| 0953698 | m. 1 kraangat | wit | 074075P11 | stuk | 2051,00 | 301 | 1 |
| 0953699 | m. 1 kraangat | kiezelgrijs | 074075P12 | stuk | 2051,00 | 301 | 1 |
| 0953700 | m. 3 kraangaten | wit | 074075P31 | stuk | 2082,00 | 301 | 1 |
| 0953701 | m. 3 kraangaten | kiezelgrijs | 074075P32 | stuk | 2082,00 | 301 | 1 |



Utiliteit

meubelset m. spiegel 150cm

| | | | | | | | |
|---------|-------------|-----|-----------|------|---------|-----|---|
| 0953702 | z. kraangat | wit | 074150PZ1 | stuk | 3466,00 | 301 | 1 |
|---------|-------------|-----|-----------|------|---------|-----|---|

**spiegelpaneel los**

| | | | | | | | |
|---------|----------|-----|-----------------|------|--------|-----|---|
| 0954661 | 200x60cm | wit | 074245736060001 | stuk | 450,00 | 301 | 1 |
|---------|----------|-----|-----------------|------|--------|-----|---|

meubelset m. spiegel 150cm

| | | | | | | | |
|---------|-----------------|-------------|-----------|------|---------|-----|---|
| 0953703 | z. kraangat | kiezelgrijs | 074150PZ2 | stuk | 3466,00 | 301 | 1 |
| 0953704 | m. 2 kraangaten | wit | 074150P21 | stuk | 3466,00 | 301 | 1 |

spiegelpaneel los

| | | | | | | | |
|---------|----------|-------------|-----------------|------|--------|-----|---|
| 0954662 | 200x60cm | kiezelgrijs | 074245736060002 | stuk | 450,00 | 301 | 1 |
|---------|----------|-------------|-----------------|------|--------|-----|---|

| | Art.nr | Specificaties | Kleur | Lev.nr | Ehd | Prijs | Grp | CC |
|---|------------------------|------------------------|-------------|------------|---------|---------|-----|----|
| Detremmerie Atlantic Beach | | | | | | | | |
| meubelset m. spiegel 150cm | | | | | | | | |
| Sanitair producten | 0953705 | m. 2 kraangaten | kiezelgrijs | 074150P22 | stuk | 3466,00 | 301 | 1 |
| | 0953706 | m. 6 kraangaten | wit | 074150P61 | stuk | 3497,00 | 301 | 1 |
| | 0953707 | m. 6 kraangaten | kiezelgrijs | 074150P62 | stuk | 3497,00 | 301 | 1 |
| meubelset m. spiegelkast 75cm | | | | | | | | |
| Baden / douchebakken / stoomcabines | 0953708 | links z. kraangat | wit | 074075KLZ1 | stuk | 2541,00 | 301 | 1 |
| | 0953710 | links z. kraangat | kiezelgrijs | 074075KLZ2 | stuk | 2541,00 | 301 | 1 |
| | 0953709 | rechts z. kraangat | wit | 074075KRZ1 | stuk | 2541,00 | 301 | 1 |
| Kranen | 0953711 | rechts z. kraangat | kiezelgrijs | 074075KRZ2 | stuk | 2541,00 | 301 | 1 |
| | 0953712 | links m. 1 kraangat | wit | 074075KL11 | stuk | 2541,00 | 301 | 1 |
| | 0953714 | links m. 1 kraangat | kiezelgrijs | 074075KL12 | stuk | 2541,00 | 301 | 1 |
| Douchegarnituur | 0953713 | rechts m. 1 kraangat | wit | 074075KR11 | stuk | 2541,00 | 301 | 1 |
| | 0953715 | rechts m. 1 kraangat | kiezelgrijs | 074075KR12 | stuk | 2541,00 | 301 | 1 |
| | 0953716 | links m. 3 kraangat | wit | 074075KL31 | stuk | 2572,00 | 301 | 1 |
| | 0953718 | links m. 3 kraangaten | kiezelgrijs | 074075KL32 | stuk | 2572,00 | 301 | 1 |
| | 0953717 | rechts m. 3 kraangaten | wit | 074075KR31 | stuk | 2572,00 | 301 | 1 |
| 0953719 | rechts m. 3 kraangaten | kiezelgrijs | 074075KR32 | stuk | 2572,00 | 301 | 1 | |
| meubelset m. spiegelkast 150cm | | | | | | | | |
| Accessoires en spiegels | 0953720 | z. kraangat | wit | 074150KZ1 | stuk | 4255,00 | 301 | 1 |
| | 0953721 | z. kraangat | kiezelgrijs | 074150KZ2 | stuk | 4255,00 | 301 | 1 |
| Douchewanden | 0953722 | m. 2 kraangaten | wit | 074150K21 | stuk | 4255,00 | 301 | 1 |
| | 0953723 | m. 2 kraangaten | kiezelgrijs | 074150K22 | stuk | 4255,00 | 301 | 1 |
| | 0953724 | m. 6 kraangaten | wit | 074150K61 | stuk | 4286,00 | 301 | 1 |
| | 0953725 | m. 6 kraangaten | kiezelgrijs | 074150K62 | stuk | 4286,00 | 301 | 1 |
| | Detremmerie Bo | | | | | | | |
| meubelset 90cm m. lade m. spiegel | | | | | | | | |
| Toebehoren & afvoeren | 0950307 | | wit/wit | 078090P5 | stuk | 1414,00 | 301 | 1 |
| | 0950308 | | wit/eiken | 078090P7 | stuk | 1457,00 | 301 | 1 |
| | 0950309 | | wit/grijs | 078090P6 | stuk | 1457,00 | 301 | 1 |
| meubelset 90cm m. lade m. spiegelkast | | | | | | | | |
| Spool- & installatiesystemen | 0950313 | | wit/wit | 078090K5 | stuk | 1537,00 | 301 | 1 |
| | 0950314 | | wit/eiken | 078090K7 | stuk | 1623,00 | 301 | 1 |
| | 0950315 | | wit/grijs | 078090K6 | stuk | 1623,00 | 301 | 1 |
| meubelset 120cm m. lade m. spiegel | | | | | | | | |
| Badkamermeubelen en toiletkasten | 0950310 | | wit/wit | 078120P5 | stuk | 1542,00 | 301 | 1 |
| | 0950311 | | wit/eiken | 078120P7 | stuk | 1596,00 | 301 | 1 |
| | 0950312 | | wit/grijs | 078120P6 | stuk | 1596,00 | 301 | 1 |
| meubelset 120cm m. lade m. spiegelkast | | | | | | | | |
| Gootstenen en wastroggen | 0950316 | | wit/wit | 078120K5 | stuk | 1895,00 | 301 | 1 |
| | 0950317 | | wit/eiken | 078120K7 | stuk | 2008,00 | 301 | 1 |
| | 0950318 | | wit/grijs | 078120K6 | stuk | 2008,00 | 301 | 1 |
| halfhoge kast | | | | | | | | |
| Utiliteit | 0950295 | 122x35x30cm links | wit | 078HHL1 | stuk | 273,00 | 301 | 1 |
| | 0950296 | 122x35x30cm links | eiken | 078HHL3 | stuk | 348,00 | 301 | 1 |
| | 0950297 | 122x35x30cm links | grijs | 078HHL2 | stuk | 348,00 | 301 | 1 |
| | 0950298 | 122x35x30cm rechts | wit | 078HHR1 | stuk | 273,00 | 301 | 1 |
| | 0950299 | 122x35x30cm rechts | eiken | 078HHR3 | stuk | 348,00 | 301 | 1 |
| | 0950300 | 122x35x30cm rechts | grijs | 078HHR2 | stuk | 348,00 | 301 | 1 |

Art.nr Specificaties Kleur Lev.nr Ehd Prijs Grp CC

Detremmerie Bo

hoge kast

| | | | | | | | | |
|---------|----------------------|-------|--------|------|--------|-----|---|---|
| 0950301 | 169.7x35x30cm links | wit | 078HL1 | stuk | 289,00 | 301 | 1 |  |
| 0950302 | 169.7x35x30cm links | eiken | 078HL3 | stuk | 391,00 | 301 | 1 | |
| 0950303 | 169.7x35x30cm links | grijs | 078HL2 | stuk | 391,00 | 301 | 1 | |
| 0950304 | 169.7x35x30cm rechts | wit | 078HR1 | stuk | 289,00 | 301 | 1 | |
| 0950305 | 169.7x35x30cm rechts | eiken | 078HR3 | stuk | 391,00 | 301 | 1 | |
| 0950306 | 169.7x35x30cm rechts | grijs | 078HR2 | stuk | 391,00 | 301 | 1 | |

Sanitair producten

Baden /
douchebakken /
stoomcabines

spiegel op paneel

| | | | | | | | | |
|---------|----------|-------|----------|------|--------|-----|---|---|
| 0950319 | 90x70cm | wit | 078P0901 | stuk | 594,00 | 301 | 1 |  |
| 0950320 | 90x70cm | eiken | 078P0903 | stuk | 605,00 | 301 | 1 | |
| 0950321 | 90x70cm | grijs | 078P0902 | stuk | 605,00 | 301 | 1 | |
| 0950322 | 120x70cm | wit | 078P1201 | stuk | 621,00 | 301 | 1 | |
| 0950323 | 120x70cm | eiken | 078P1203 | stuk | 632,00 | 301 | 1 | |
| 0950324 | 120x70cm | grijs | 078P1202 | stuk | 632,00 | 301 | 1 | |

Kranen

Douchegarnituur

spiegelkast

| | | | | | | | | |
|---------|------------|-------|----------|------|---------|-----|---|---|
| 0950325 | 90x72.4cm | wit | 078K0901 | stuk | 717,00 | 301 | 1 |  |
| 0950326 | 90x72.4cm | eiken | 078K0903 | stuk | 771,00 | 301 | 1 | |
| 0950327 | 90x72.4cm | grijs | 078K0902 | stuk | 771,00 | 301 | 1 | |
| 0950328 | 120x72.4cm | wit | 078K1201 | stuk | 974,00 | 301 | 1 | |
| 0950329 | 120x72.4cm | eiken | 078K1203 | stuk | 1044,00 | 301 | 1 | |
| 0950330 | 120x72.4cm | grijs | 078K1202 | stuk | 1044,00 | 301 | 1 | |

Accessoires en
spiegels

Douchewanden

lade indeling

| | | | | | | | | |
|---------|---------|--|----------------|------|--------|-----|---|---|
| 0950331 | 48x43cm | | 99986015000000 | stuk | 190,00 | 301 | 1 |  |
|---------|---------|--|----------------|------|--------|-----|---|---|

Toebehoren &
afvoeren

Detremmerie Bolero 4003

meubelset 75cm m. spiegel

| | | | | | | | | |
|---------|--|----------|-----------|------|---------|-----|---|---|
| 0958077 | | wit | 009600113 | stuk | 1754,00 | 301 | 1 |  |
| 0958085 | | pergamon | 009600223 | stuk | 1754,00 | 301 | 1 | |
| 0958093 | | wit | 009601113 | stuk | 1832,00 | 301 | 1 | |
| 0958107 | | pergamon | 009601223 | stuk | 1832,00 | 301 | 1 | |

Spoel- &
installatiesystemen

Badkamermeubelen
en toiletkasten

Gootstenen en
wastroggen

meubelset 75cm m. spiegelpaneel

| | | | | | | | | |
|---------|--|-------------|-----------|------|---------|-----|---|---|
| 0958115 | | wit/appel | 009603113 | stuk | 1665,00 | 301 | 1 |  |
| 0958123 | | perg./appel | 009603223 | stuk | 1665,00 | 301 | 1 | |

Utiliteit

meubelset 105cm m. spiegel m. luifel

| | | | | | | | | |
|---------|--------|-------------|------------|------|---------|-----|---|---|
| 0958131 | rechts | wit/appel | 009903R113 | stuk | 2469,00 | 301 | 1 |  |
| 0958158 | rechts | perg./appel | 009903R223 | stuk | 2469,00 | 301 | 1 | |
| 0958166 | links | wit/appel | 009903L113 | stuk | 2469,00 | 301 | 1 | |
| 0958174 | links | perg./appel | 009903L223 | stuk | 2469,00 | 301 | 1 | |

| Art.nr | Specificaties | Kleur | Lev.nr | Ehd | Prijs | Grp | CC |
|--------|---------------|-------|--------|-----|-------|-----|----|
|--------|---------------|-------|--------|-----|-------|-----|----|

Detremmerie Bolero 4003

meubelset 105cm m. spiegelkast

| | | | | | | | |
|---------|--------|-------------|------------|------|---------|-----|---|
| 0958182 | rechts | wit/appel | 009905R113 | stuk | 2965,00 | 301 | 1 |
| 0958190 | rechts | perg./appel | 009905R223 | stuk | 2965,00 | 301 | 1 |
| 0958204 | links | wit/appel | 009905L113 | stuk | 2965,00 | 301 | 1 |
| 0958212 | links | perg./appel | 009905L223 | stuk | 2965,00 | 301 | 1 |



Sanitair producten

Baden /
douchebakken /
stoomcabines

Kranen



Douchegarnituur

meubelset 105cm m. spiegelkast m. schap

| | | | | | | | |
|---------|--------|-------------|------------|------|---------|-----|---|
| 0958220 | rechts | wit/manh. | 009907R116 | stuk | 3036,00 | 301 | 1 |
| 0958239 | rechts | wit/appel | 009907R113 | stuk | 3036,00 | 301 | 1 |
| 0958247 | rechts | perg./appel | 009907R223 | stuk | 3036,00 | 301 | 1 |
| 0958255 | links | wit/manh. | 009907L116 | stuk | 3036,00 | 301 | 1 |
| 0958263 | links | wit/appel | 009907L113 | stuk | 3036,00 | 301 | 1 |
| 0958271 | links | perg./appel | 009907L223 | stuk | 3036,00 | 301 | 1 |



Accessoires en
spiegels

Douchewanden



Toebehoren &
afvoeren

meubelset 105cm m. losse spiegel m. verlichting

| | | | | | | | |
|---------|--------|-------------|------------|------|---------|-----|---|
| 0958298 | rechts | wit/appel | 009911R113 | stuk | 2288,00 | 301 | 1 |
| 0958301 | rechts | perg./appel | 009911R223 | stuk | 2288,00 | 301 | 1 |
| 0958328 | links | wit/appel | 009911L113 | stuk | 2288,00 | 301 | 1 |
| 0958336 | links | perg./appel | 009911L223 | stuk | 2288,00 | 301 | 1 |



Spoel- &
installatiesystemen

Badkamermeubelen
en toiletkasten



Gootstenen en
wastroggen

meubelset dubbel 165cm m. spiegel

| | | | | | | | |
|---------|--|-------------|------------|------|---------|-----|---|
| 0958344 | | wit/appel | 091501113 | stuk | 3565,00 | 301 | 1 |
| 0958352 | | perg./appel | 0091501223 | stuk | 3565,00 | 301 | 1 |

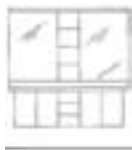

meubelset dubbel 165cm m. spiegelkast

| | | | | | | | |
|---------|--|-------------|------------|------|---------|-----|---|
| 0958360 | | wit/appel | 0091503113 | stuk | 4316,00 | 301 | 1 |
| 0958379 | | perg./appel | 0091503223 | stuk | 4316,00 | 301 | 1 |
| 0958507 | | perg./beuk | 0091503224 | stuk | 4316,00 | 301 | 1 |



meubelset dubbel 165cm m. spiegel

| | | | | | | | |
|---------|--|-------------|------------|------|---------|-----|---|
| 0958387 | | wit/appel | 0091511113 | stuk | 3457,00 | 301 | 1 |
| 0958395 | | perg./appel | 0091511223 | stuk | 3457,00 | 301 | 1 |



Art.nr Specificaties Kleur Lev.nr Ehd Prijs Grp CC

Detremmerie Bolero 4003

halfhoge kast 35cm

| | | | | | | | |
|---------|--------|----------|-----------------|------|--------|-----|---|
| 0958409 | links | wit | 009221670035101 | stuk | 271,00 | 301 | 1 |
| 0958417 | links | pergamon | 009221670035102 | stuk | 271,00 | 301 | 1 |
| 0958425 | rechts | wit | 009221670035201 | stuk | 271,00 | 301 | 1 |
| 0958433 | rechts | pergamon | 009221670035202 | stuk | 271,00 | 301 | 1 |



Sanitair producten

Baden /
douchebakken /
stoomcabines

halfhoge kast 35cm m. lade

| | | | | | | | |
|---------|--------|-------------|------------------|------|--------|-----|---|
| 0958441 | links | wit/appel | 0092216940351013 | stuk | 442,00 | 301 | 1 |
| 0958468 | links | perg./appel | 0092216940351023 | stuk | 442,00 | 301 | 1 |
| 0958476 | rechts | wit/appel | 0092216940352013 | stuk | 442,00 | 301 | 1 |
| 0958492 | rechts | perg./appel | 0092216940352023 | stuk | 442,00 | 301 | 1 |



Kranen

Douchegarnituur

halfhoge kast 35cm m. korf

| | | | | | | | |
|---------|--|-------------|------------------|------|--------|-----|---|
| 0958506 | | wit/appel | 0092216950350013 | stuk | 529,00 | 301 | 1 |
| 0958514 | | perg./appel | 0092216950350023 | stuk | 529,00 | 301 | 1 |



Accessoires en
spiegels

tablet voor halfhoge kast 35cm

| | | | | | | | |
|---------|--|----------|-----------------|------|--------|-----|---|
| 0958522 | | wit | 009201309035001 | stuk | 128,00 | 301 | 1 |
| 0958530 | | pergamon | 009201309035002 | stuk | 128,00 | 301 | 1 |
| 0958549 | | appelaar | 009201309035003 | stuk | 128,00 | 301 | 1 |
| 0958557 | | metallic | 009201309035006 | stuk | 128,00 | 301 | 1 |
| 0958508 | | beuken | 009201309035004 | stuk | 128,00 | 301 | 1 |



Douchewanden

Toebehoren &
afvoeren

hogekast

| | | | | | | | | |
|---------|------------|--------|----------|-----------------|------|--------|-----|---|
| 0958565 | 167,7x35cm | links | wit | 009221660035101 | stuk | 379,00 | 301 | 1 |
| 0958573 | 167,7x35cm | links | pergamon | 009221660035102 | stuk | 379,00 | 301 | 1 |
| 0958581 | 167,7x35cm | rechts | wit | 009221660035201 | stuk | 379,00 | 301 | 1 |
| 0958603 | 167,7x35cm | rechts | pergamon | 009221660035202 | stuk | 379,00 | 301 | 1 |



Spoel- &
installatiesystemen

Badkamermeubelen
en toiletkasten

hogekast m. lade

| | | | | | | | | |
|---------|------------|--------|-------------|------------------|------|--------|-----|---|
| 0958611 | 167,7x35cm | links | wit/appel | 0092216580351013 | stuk | 527,00 | 301 | 1 |
| 0958638 | 167,7x35cm | links | perg./appel | 0092216580351023 | stuk | 527,00 | 301 | 1 |
| 0958646 | 167,7x35cm | rechts | wit/appel | 0092216580352013 | stuk | 527,00 | 301 | 1 |
| 0958654 | 167,7x35cm | rechts | perg./appel | 0092216580352023 | stuk | 527,00 | 301 | 1 |



Gootstenen en
wastroggen

Detremmerie Charon

halfhoge kast links

| | | | | | | | | |
|---------|------|--|-----------|----------|------|--------|-----|---|
| 0954706 | 35cm | | wit/wit | 070HHL10 | stuk | 912,00 | 301 | 1 |
| 0954707 | 35cm | | grijs/wit | 070HHL11 | stuk | 912,00 | 301 | 1 |



Utiliteit





halfhoge kast rechts









| | | | | | | | | |
|---------|------|--|-----------|----------|------|--------|-----|---|
| 0954709 | 35cm | | wit/wit | 070HHR10 | stuk | 912,00 | 301 | 1 |
| 0954710 | 35cm | | grijs/wit | 070HHR11 | stuk | 912,00 | 301 | 1 |

halfhoge kast

| | | | | | | | | |
|---------|------|--|-----------|---------|------|---------|-----|---|
| 0954712 | 70cm | | wit/wit | 070HH10 | stuk | 1741,00 | 301 | 1 |
| 0954714 | 70cm | | grijs/wit | 070HH11 | stuk | 1741,00 | 301 | 1 |



| | Art.nr | Specificaties | Kleur | Lev.nr | Ehd | Prijs | Grp | CC |
|---|---|---------------|-------------|-----------------|------|---------|-----|----|
| | Detremmerie Charon | | | | | | | |
| Sanitair producten | kolomkast links | | | | | | | |
| | 0954716 | 181.6x30.4cm | wit | 070221175030101 | stuk | 1117,00 | 301 | 1 |
| | 0954717 | 181.6x30.4cm | grijs | 070221175030102 | stuk | 1117,00 | 301 | 1 |
| Baden / douchebakken / stoomcabines |  | | | | | | | |
| Kranen | kolomkast rechts | | | | | | | |
| | 0954719 | 181.6x30.4cm | wit | 070221175030201 | stuk | 1117,00 | 301 | 1 |
| | 0954720 | 181.6x30.4cm | grijs | 070221175030202 | stuk | 1117,00 | 301 | 1 |
| Douchegarnituur | kolomkast m. uittreksysteem | | | | | | | |
| | 0954723 | 181.6x30cm | wit | 070221176030001 | stuk | 1698,00 | 301 | 1 |
| | 0954724 | 181.6x30cm | grijs | 070221176030002 | stuk | 1698,00 | 301 | 1 |
| Accessoires en spiegels | kolomkast links | | | | | | | |
| | 0954726 | 181.6x35cm | wit | 070221175035101 | stuk | 1141,00 | 301 | 1 |
| | 0954727 | 181.6x35cm | grijs | 070221175035102 | stuk | 1141,00 | 301 | 1 |
| Douchewanden | kolomkast rechts | | | | | | | |
| | 0954729 | 181.6x35cm | wit | 070221175035201 | stuk | 1141,00 | 301 | 1 |
| | 0954730 | 181.6x35cm | grijs | 070221175035202 | stuk | 1141,00 | 301 | 1 |
| Toebehoren & afvoeren | meubelset enkel m. spiegelpaneel | | | | | | | |
| | 0954732 | 75cm | wit/wit | 070075P10 | stuk | 2313,00 | 301 | 1 |
| | 0954733 | 75cm | grijs/wit | 070075P11 | stuk | 2313,00 | 301 | 1 |
| Spoel- & installatiesystemen | meubelset dubbel m. spiegelpaneel | | | | | | | |
| | 0954735 | 150cm | wit/wit | 070150P10 | stuk | 4377,00 | 301 | 1 |
| | 0954736 | 150cm | grijs/wit | 070150P11 | stuk | 4377,00 | 301 | 1 |
| Badkamermeubelen en toiletkasten | meubelset enkel m. spiegelkast | | | | | | | |
| | 0954738 | 75cm | wit/wit | 070075K10 | stuk | 2792,00 | 301 | 1 |
| | 0954739 | 75cm | grijs/wit | 070075K11 | stuk | 2792,00 | 301 | 1 |
| Gootstenen en wastroggen |  | | | | | | | |
| Utiliteit | meubelset dubbel m. spiegelkast | | | | | | | |
| | 0954741 | 150cm | wit/wit | 070150K10 | stuk | 5024,00 | 301 | 1 |
| | 0954742 | 150cm | grijs/wit | 070150K11 | stuk | 5024,00 | 301 | 1 |
| |  | | | | | | | |
| | schap m. ingewerkte T5-verlichting | | | | | | | |
| | 0954744 | 50cm | chroom/glas | 99998550905023 | stuk | 431,00 | 301 | 1 |
| |  | | | | | | | |
| | spiegelpaneel m. ingewerkte T5 verlichting | | | | | | | |
| | 0954745 | 50cm | | 07024573505000 | stuk | 580,00 | 301 | 1 |
| |  | | | | | | | |

| Art.nr | Specificaties | Kleur | Lev.nr | Ehd | Prijs | Grp | CC | |
|---|---------------|-----------|-----------|------|---------|-----|----|---|
| | | | | | | | | Detremmerie Charon |
| spiegelkast 75cm m. ingewerkte T5 verlichting | | | | | | | |  |
| 0954746 | | | 070075KSK | stuk | 1059,00 | 301 | 1 | |
| spiegelkast 150cm m. ingewerkte T5 verlichting | | | | | | | |  |
| 0954747 | | | 070150KSK | stuk | 1807,00 | 301 | 1 | |
| | | | | | | | | Detremmerie Charon Due |
| meubelset m. spiegelkast m. klapdeur | | | | | | | |  |
| 0950287 | 75cm | wit/wit | 072075K10 | stuk | 2403,00 | 301 | 1 | |
| 0950288 | 75cm | grijs/wit | 072075K11 | stuk | 2403,00 | 301 | 1 | |
| meubelset m. spiegelpaneel | | | | | | | |  |
| 0950271 | 75cm | wit/wit | 072075P10 | stuk | 1924,00 | 301 | 1 | |
| 0950274 | 75cm | grijs/wit | 072075P11 | stuk | 1924,00 | 301 | 1 | |
| meubelset m. spiegelkast m. klapdeur | | | | | | | |  |
| 0950289 | 150cm | wit/wit | 072150K10 | stuk | 4430,00 | 301 | 1 | |
| 0950290 | 150cm | grijs/wit | 072150K11 | stuk | 4430,00 | 301 | 1 | |
| meubelset m. spiegelpaneel | | | | | | | |  |
| 0950281 | 150cm | wit/wit | 072150P10 | stuk | 3783,00 | 301 | 1 | |
| 0950285 | 150cm | grijs/wit | 072150P11 | stuk | 3783,00 | 301 | 1 | |
| kolomkast m. uittrekbaar systeem | | | | | | | |  |
| 0950243 | 181.6x30cm | wit | 072H30U1 | stuk | 1248,00 | 301 | 1 | |
| 0950244 | 181.6x30cm | grijs | 072H30U2 | stuk | 1248,00 | 301 | 1 | |
| kolomkast links | | | | | | | |  |
| 0950239 | 181.6x30.4cm | wit | 072H30L1 | stuk | 636,00 | 301 | 1 | |
| 0950240 | 181.6x30.4cm | grijs | 072H30L2 | stuk | 636,00 | 301 | 1 | |
| 0950245 | 181.6x35cm | wit | 072H35L1 | stuk | 660,00 | 301 | 1 | |
| 0950246 | 181.6x35cm | grijs | 072H35L2 | stuk | 660,00 | 301 | 1 | |
| kolomkast rechts | | | | | | | |  |
| 0950241 | 181.6x30.4cm | wit | 072H30R1 | stuk | 636,00 | 301 | 1 | |
| 0950242 | 181.6x30.4cm | grijs | 072H30R2 | stuk | 636,00 | 301 | 1 | |
| 0950262 | 181.6x35cm | wit | 072H35R1 | stuk | 660,00 | 301 | 1 | |
| 0950267 | 181.6x35cm | grijs | 072H35R2 | stuk | 660,00 | 301 | 1 | |

Sanitair producten

Baden /
douchebakken /
stoomcabines

Kranen

Douchegarnituur

Accessoires en
spiegels

Douchewanden













Toebehoren &
afvoeren

Spoel- &
installatiesystemen

Badkamermeubelen
en toiletkasten

Gootstenen en
wastroggen

Utiliteit

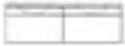
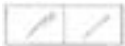
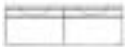
| | Art.nr | Specificaties | Kleur | Lev.nr | Ehd | Prijs | Grp | CC |
|---|--|---------------|------------|----------|------|---------|-----|----|
| | Detremmerie Charon Due | | | | | | | |
| Sanitair producten | halfhoge kast links | | | | | | | |
| | 0950233 | 35cm | wit/wit | 072HHL10 | stuk | 619,00 | 301 | 1 |
| | 0950234 | 35cm | grijs/wit | 072HHL11 | stuk | 619,00 | 301 | 1 |
| Baden / douchebakken / stoomcabines |  | | | | | | | |
| | halfhoge kast rechts | | | | | | | |
| Kranen | 0950235 | 35cm | wit/wit | 072HHR10 | stuk | 619,00 | 301 | 1 |
| | 0950236 | 35cm | grijs/wit | 072HHR11 | stuk | 619,00 | 301 | 1 |
| Douchegarnituur |  | | | | | | | |
| | halfhoge kast | | | | | | | |
| Accessoires en spiegels | 0950237 | 70cm | wit/wit | 072HH10 | stuk | 1159,00 | 301 | 1 |
| | 0950238 | 70cm | grijs/wit | 072HH11 | stuk | 1159,00 | 301 | 1 |
| Douchewanden |  | | | | | | | |
| | Detremmerie Chiara | | | | | | | |
| Toebehoren & afvoeren | meubelset m. deuren m. spiegel m. ingewerkte verlichting | | | | | | | |
| | 0957291 | 80cm | wit/marmer | 0570802 | stuk | 1685,00 | 301 | 1 |
| Spoel- & installatiesystemen |   | | | | | | | |
| Badkamermeubelen en toiletkasten | meubelset m. laden m. spiegel m. ingewerkte verlichting | | | | | | | |
| | 0957305 | 80cm | wit/marmer | 0570803 | stuk | 1621,00 | 301 | 1 |
| Gootstenen en wastroggen |   | | | | | | | |
| Utiliteit | meubelset m. deuren m. spiegelkast m. ingewerkte verlichting | | | | | | | |
| | 0959251 | 80cm | wit/marmer | 0570802S | stuk | 2163,00 | 301 | 1 |
| |   | | | | | | | |
| | meubelset m. laden m. spiegelkast m. ingewerkte verlichting | | | | | | | |
| | 0959278 | 80cm | wit/marmer | 0570803S | stuk | 2099,00 | 301 | 1 |
| |   | | | | | | | |
| | meubelset dubbel m. laden m. ingewerkte verlichting | | | | | | | |
| | 0957437 | 160cm | wit/marmer | 0571603 | stuk | 2712,00 | 301 | 1 |
| |   | | | | | | | |
| | meubelset dubbel m. laden m. spiegelkast m. ingewerkte verlichting | | | | | | | |
| | 0959332 | 160cm | wit/marmer | 0571603S | stuk | 3661,00 | 301 | 1 |
| |   | | | | | | | |

| Art.nr | Specificaties | Kleur | Lev.nr | Ehd | Prijs | Grp | CC |
|--------|---------------|-------|--------|-----|-------|-----|----|
|--------|---------------|-------|--------|-----|-------|-----|----|

Detremmerie Chiara

kolomkast links

| | | | | | | | |
|---------|----------|-----|----------------|------|--------|-----|---|
| 0957267 | 40x160cm | wit | 05722113304010 | stuk | 428,00 | 301 | 1 |
|---------|----------|-----|----------------|------|--------|-----|---|



Sanitair producten

Baden /
douchebakken /
stoomcabines

kolomkast rechts

| | | | | | | | |
|---------|----------|-----|----------------|------|--------|-----|---|
| 0957275 | 40x160cm | wit | 05722113304020 | stuk | 428,00 | 301 | 1 |
|---------|----------|-----|----------------|------|--------|-----|---|

Kranen

Detremmerie Elle

meubelset

| | | | | | | | | |
|---------|----------|----------------------------|-------------|------------|------|---------|-----|---|
| 0951703 | 140x55cm | bak links m. spiegelpaneel | wit/wit | 079L140P1 | stuk | 3938,00 | 301 | 1 |
| 0951704 | 140x55cm | bak links m. spiegelpaneel | zwart/zwart | 079L140P6 | stuk | 4700,00 | 301 | 1 |
| 0951708 | 140x55cm | 2 bakken m. spiegelpaneel | wit/wit | 079LR140P1 | stuk | 4217,00 | 301 | 1 |
| 0951709 | 140x55cm | 2 bakken m. spiegelpaneel | zwart/zwart | 079LR140P6 | stuk | 5150,00 | 301 | 1 |
| 0951710 | 140x55cm | bak links m. spiegelkast | wit/wit | 079L140K1 | stuk | 4831,00 | 301 | 1 |
| 0951711 | 140x55cm | bak links m. spiegelkast | zwart/zwart | 079L140K6 | stuk | 5593,00 | 301 | 1 |
| 0951715 | 140x55cm | 2 bakken m. spiegelkast | wit/wit | 079LR140K1 | stuk | 5110,00 | 301 | 1 |
| 0951717 | 140x55cm | 2 bakken m. spiegelkast | zwart/zwart | 079LR140K6 | stuk | 6043,00 | 301 | 1 |

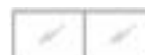
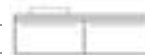

Douchegarnituur

Accessoires en
spiegels

Douchewanden

Toebehoren &
afvoeren

Spoel- &
installatiesystemen

Badkamermeubelen
en toiletkasten

kolomkast

| | | | | | | | | |
|---------|----------|--------|-------|---------|------|---------|-----|---|
| 0951699 | 150x45cm | links | wit | 079HL13 | stuk | 1373,00 | 301 | 1 |
| 0951700 | 150x45cm | links | zwart | 079HL15 | stuk | 1373,00 | 301 | 1 |
| 0951701 | 150x45cm | rechts | wit | 079HR13 | stuk | 1373,00 | 301 | 1 |
| 0951702 | 150x45cm | rechts | zwart | 079HR15 | stuk | 1373,00 | 301 | 1 |



Gootstenen en
wastroggen

Utiliteit

Detremmerie Fabian

kolomkast links

| | | | | | | | |
|---------|----------|-----------|-----------------|------|---------|-----|---|
| 0151084 | 182x30cm | wit | 064221137030101 | stuk | 1135,00 | 301 | 1 |
| 0151130 | 182x30cm | pergamon | 064221137030103 | stuk | 1135,00 | 301 | 1 |
| 0151025 | 182x30cm | grijs | 064221137030102 | stuk | 1135,00 | 301 | 1 |
| 0151181 | 182x30cm | aubergine | 064221137030104 | stuk | 1135,00 | 301 | 1 |



kolomkast rechts





| | | | | | | | |
|---------|----------|-----------|-----------------|------|---------|-----|---|
| 0151092 | 182x30cm | wit | 064221137030201 | stuk | 1135,00 | 301 | 1 |
| 0151149 | 182x30cm | pergamon | 064221137030203 | stuk | 1135,00 | 301 | 1 |
| 0151033 | 182x30cm | grijs | 064221137030202 | stuk | 1135,00 | 301 | 1 |
| 0151203 | 182x30cm | aubergine | 064221137030204 | stuk | 1135,00 | 301 | 1 |







kolomkast links

| | | | | | | | |
|---------|----------|-----------|-----------------|------|---------|-----|---|
| 0151114 | 182x35cm | wit | 064221137035101 | stuk | 1157,00 | 301 | 1 |
| 0151165 | 182x35cm | pergamon | 064221137035103 | stuk | 1157,00 | 301 | 1 |
| 0151068 | 182x35cm | grijs | 064221137035102 | stuk | 1157,00 | 301 | 1 |
| 0151238 | 182x35cm | aubergine | 064221137035104 | stuk | 1157,00 | 301 | 1 |

kolomkast rechts

| | | | | | | | |
|---------|----------|-----------|-----------------|------|---------|-----|---|
| 0151122 | 182x35cm | wit | 064221137035201 | stuk | 1157,00 | 301 | 1 |
| 0151173 | 182x35cm | pergamon | 064221137035203 | stuk | 1157,00 | 301 | 1 |
| 0151076 | 182x35cm | grijs | 064221137035202 | stuk | 1157,00 | 301 | 1 |
| 0151246 | 182x35cm | aubergine | 064221137035204 | stuk | 1157,00 | 301 | 1 |

| | Art.nr | Specificaties | Kleur | Lev.nr | Ehd | Prijs | Grp | CC |
|---|---|---------------|-----------------|-----------------|------|---------|-----|----|
| Detremmerie Fabian | | | | | | | | |
| kolomkast m. uittreksysteem | | | | | | | | |
| Sanitair producten | 0151106 | 182x30cm | wit | 064221138030001 | stuk | 1642,00 | 301 | 1 |
| | 0151157 | | pergamon | 064221138030003 | stuk | 1642,00 | 301 | 1 |
| | 0151041 | | grijs | 064221138030002 | stuk | 1642,00 | 301 | 1 |
| | 0151211 | | aubergine | 064221138030004 | stuk | 1642,00 | 301 | 1 |
| meubelset m. spiegelpaneel | | | | | | | | |
| Baden / douchebakken / stoomcabines | 0151319 | 90cm | wit/wit | 064090P10 | stuk | 2706,00 | 301 | 1 |
| | 0151386 | 90cm | perg./perg. | 064090P22 | stuk | 2706,00 | 301 | 1 |
| | 0151254 | 90cm | grijs/grijs/wit | 064090P11 | stuk | 2706,00 | 301 | 1 |
| | 0151440 | 90cm | aubergine/wit | 064090P13 | stuk | 2706,00 | 301 | 1 |
| Kranen |  | | | | | | | |
| meubelset m. spiegelkast | | | | | | | | |
| Douchegarnituur | 0151343 | 90cm | wit/wit | 064090S10 | stuk | 3577,00 | 301 | 1 |
| | 0151416 | 90cm | perg./perg. | 064090S22 | stuk | 3577,00 | 301 | 1 |
| | 0151289 | 90cm | grijs/wit | 064090S11 | stuk | 3577,00 | 301 | 1 |
| | 0151475 | 90cm | aubergine/wit | 064090S13 | stuk | 3577,00 | 301 | 1 |
| Accessoires en spiegels |  | | | | | | | |
| meubelset m. spiegelpaneel | | | | | | | | |
| Douchewanden | 0151327 | 120cm | wit/wit | 064120P10 | stuk | 3435,00 | 301 | 1 |
| | 0151394 | 120cm | perg./perg. | 064120P22 | stuk | 3435,00 | 301 | 1 |
| | 0151262 | 120cm | grijs/wit | 064120P11 | stuk | 3435,00 | 301 | 1 |
| | 0151459 | 120cm | aubergine/wit | 064120P13 | stuk | 3435,00 | 301 | 1 |
| Toebehoren & afvoeren |  | | | | | | | |
| meubelset m. spiegelkast | | | | | | | | |
| Spoel- & installatiesystemen | 0151351 | 120cm | wit/wit | 064120S10 | stuk | 4290,00 | 301 | 1 |
| | 0151424 | 120cm | perg./perg. | 064120S22 | stuk | 4290,00 | 301 | 1 |
| | 0151297 | 120cm | grijs/wit | 064120S11 | stuk | 4290,00 | 301 | 1 |
| | 0151483 | 120cm | aubergine/wit | 064120S13 | stuk | 4290,00 | 301 | 1 |
| Badkamermeubelen en toiletkasten |  | | | | | | | |
| meubelset m. spiegelpaneel | | | | | | | | |
| Gootstenen en wastroggen | 0151335 | 140cm | wit/wit | 064140P10 | stuk | 3544,00 | 301 | 1 |
| | 0151408 | 140cm | perg./perg. | 064140P22 | stuk | 3544,00 | 301 | 1 |
| | 0151270 | 140cm | grijs/wit | 064140P11 | stuk | 3544,00 | 301 | 1 |
| | 0151467 | 140cm | aubergine/wit | 064140P13 | stuk | 3544,00 | 301 | 1 |
| Utiliteit |  | | | | | | | |
| meubelset m. spiegelkast | | | | | | | | |
| Utiliteit | 0151378 | 140cm | wit/wit | 064140S10 | stuk | 4433,00 | 301 | 1 |
| | 0151432 | 140cm | perg./perg. | 064140S22 | stuk | 4433,00 | 301 | 1 |
| | 0151300 | 140cm | grijs/wit | 064140S11 | stuk | 4433,00 | 301 | 1 |
| | 0151491 | 140cm | aubergine/wit | 064140S13 | stuk | 4433,00 | 301 | 1 |
| Detremmerie Fabian Due | | | | | | | | |
| meubelset m. spiegelpaneel | | | | | | | | |
| Utiliteit | 0950227 | 90cm | wit/wit | 071090P10 | stuk | 1953,00 | 301 | 1 |
| | 0950220 | 90cm | grijs/wit | 071090P11 | stuk | 1953,00 | 301 | 1 |
| meubelset m. spiegelkast | | | | | | | | |
| Utiliteit | 0950230 | 90cm | wit/wit | 071090K10 | stuk | 2558,00 | 301 | 1 |
| | 0950223 | 90cm | grijs/wit | 071090K11 | stuk | 2558,00 | 301 | 1 |

| Art.nr | Specificaties | Kleur | Lev.nr | Ehd | Prijs | Grp | CC | | |
|-----------------------------------|---------------|-----------|-----------|------|---------|-----|----|---|---|
| | | | | | | | | Detremmerie Fabian Due | |
| meubelset m. spiegelpaneel | | | | | | | | | |
| 0950228 | 120cm | wit/wit | 071120P10 | stuk | 2671,00 | 301 | 1 |  | Sanitair producten |
| 0950221 | 120cm | grijs/wit | 071120P11 | stuk | 2671,00 | 301 | 1 | | |
| meubelset m. spiegelkast | | | | | | | | | |
| 0950231 | 120cm | wit/wit | 071120K10 | stuk | 3328,00 | 301 | 1 |  | Baden / douchebakken / stoomcabines |
| 0950224 | 120cm | grijs/wit | 071120K11 | stuk | 3328,00 | 301 | 1 | | |
| meubelset m. spiegelkast | | | | | | | | | |
| 0950229 | 140cm | wit/wit | 071140P10 | stuk | 2786,00 | 301 | 1 |  | Kranen |
| 0950222 | 140cm | grijs/wit | 071140P11 | stuk | 2786,00 | 301 | 1 | | |
| meubelset m. spiegelpaneel | | | | | | | | | |
| 0950229 | 140cm | wit/wit | 071140P10 | stuk | 2786,00 | 301 | 1 |  | Douchegarnituur |
| 0950222 | 140cm | grijs/wit | 071140P11 | stuk | 2786,00 | 301 | 1 | | |
| meubelset m. spiegelkast | | | | | | | | | |
| 0950232 | 140cm | wit/wit | 071140K10 | stuk | 3451,00 | 301 | 1 |  | Accessoires en spiegels |
| 0950226 | 140cm | grijs/wit | 071140K11 | stuk | 3451,00 | 301 | 1 | | |
| meubelset m. spiegelkast | | | | | | | | | |
| 0950232 | 140cm | wit/wit | 071140K10 | stuk | 3451,00 | 301 | 1 |  | Douchewanden |
| 0950226 | 140cm | grijs/wit | 071140K11 | stuk | 3451,00 | 301 | 1 | | |
| kolomkast links | | | | | | | | | |
| 0950204 | 182x30cm | wit | 071H30L1 | stuk | 475,00 | 301 | 1 |  | Toebehoren & afvoeren |
| 0950196 | 182x30cm | grijs | 071H30L2 | stuk | 475,00 | 301 | 1 | | |
| kolomkast rechts | | | | | | | | | |
| 0950207 | 182x30cm | wit | 071H30R1 | stuk | 475,00 | 301 | 1 | | Spoel- & installatiesystemen |
| 0950197 | 182x30cm | grijs | 071H30R2 | stuk | 475,00 | 301 | 1 | | |
| kolomkast uittrekbaar | | | | | | | | | |
| 0950208 | 182x30cm | wit | 071H30U1 | stuk | 1087,00 | 301 | 1 | | Badkamermeubelen en toiletkasten |
| 0950198 | 182x30cm | grijs | 071H30U2 | stuk | 1087,00 | 301 | 1 | | |
| kolomkast links | | | | | | | | | |
| 0950209 | 182x35cm | wit | 071H35L1 | stuk | 498,00 | 301 | 1 | | Gootstenen en wastroggen |
| 0950199 | 182x35cm | grijs | 071H35L2 | stuk | 498,00 | 301 | 1 | | |
| kolomkast rechts | | | | | | | | | |
| 0950219 | 182x35cm | wit | 071H35R1 | stuk | 498,00 | 301 | 1 | | Utiliteit |
| 0950202 | 182x35cm | grijs | 071H35R2 | stuk | 498,00 | 301 | 1 | | |

| Art.nr | Specificaties | Kleur | Lev.nr | Ehd | Prijs | Grp | CC |
|--------|---------------|-------|--------|-----|-------|-----|----|
|--------|---------------|-------|--------|-----|-------|-----|----|

Detremmerie Gaelle

meubelset

| | | | | | | | | |
|---------|----------|---------------------------|---------|-----------|------|---------|-----|---|
| 0951723 | 90x49cm | m. spiegelpaneel | wit/wit | 083090P10 | stuk | 1971,00 | 301 | 1 |
| 0951725 | 160x54cm | 2 bakken m. spiegelpaneel | wit/wit | 083160P10 | stuk | 3602,00 | 301 | 1 |
| 0951727 | 160x54cm | 2 bakken m. spiegelkast | wit/wit | 083160K10 | stuk | 4620,00 | 301 | 1 |



kolomkast

| | | | | | | | | |
|---------|----------|--------|-----|---------|------|--------|-----|---|
| 0951718 | 170x40cm | links | wit | 083HL41 | stuk | 783,00 | 301 | 1 |
| 0951720 | 170x40cm | rechts | wit | 083HR1 | stuk | 783,00 | 301 | 1 |



Detremmerie Globe 3001

meubelset m. spiegel

| | | | | | | | | |
|---------|------|--|-------------|-----------|------|---------|-----|---|
| 0955027 | 90cm | | wit/wit | 041090P10 | stuk | 1447,00 | 301 | 1 |
| 0955035 | 90cm | | perg./perg. | 041090P21 | stuk | 1447,00 | 301 | 1 |
| 0956635 | 90cm | | peren/wit | 041090P12 | stuk | 1447,00 | 301 | 1 |
| 0956643 | 90cm | | peren/perg. | 041090P22 | stuk | 1447,00 | 301 | 1 |



meubelset m. spiegelkast

| | | | | | | | | |
|---------|------|--|-------------|-----------|------|---------|-----|---|
| 0955043 | 90cm | | wit/wit | 041090K10 | stuk | 1860,00 | 301 | 1 |
| 0955051 | 90cm | | perg./perg. | 041090K21 | stuk | 1860,00 | 301 | 1 |
| 0956686 | 90cm | | peren/wit | 041090K12 | stuk | 1860,00 | 301 | 1 |
| 0956694 | 90cm | | peren/perg. | 041090K22 | stuk | 1860,00 | 301 | 1 |



meubelset m. spiegel

| | | | | | | | | |
|---------|-------|--|-------------|-----------|------|---------|-----|---|
| 0956651 | 140cm | | peren/wit | 041140P12 | stuk | 2289,00 | 301 | 1 |
| 0956678 | 140cm | | peren/perg. | 041140P22 | stuk | 2289,00 | 301 | 1 |



meubelset m. spiegelkast

| | | | | | | | | |
|---------|-------|--|-----------|-----------|------|---------|-----|---|
| 0956708 | 140cm | | peren/wit | 041140K12 | stuk | 2584,00 | 301 | 1 |
|---------|-------|--|-----------|-----------|------|---------|-----|---|



halfhoge kast

| | | | | | | | | |
|---------|---------|--------|----------|---------|------|--------|-----|---|
| 0955094 | 92x35cm | rechts | wit | 041HHR1 | stuk | 300,00 | 301 | 1 |
| 0955108 | 92x35cm | rechts | pergamon | 041HHR2 | stuk | 300,00 | 301 | 1 |
| 0956724 | 92x35cm | rechts | peren | 041HHR3 | stuk | 300,00 | 301 | 1 |
| 0955078 | 92x35cm | links | wit | 041HHL1 | stuk | 300,00 | 301 | 1 |
| 0955086 | 92x35cm | links | pergamon | 041HHL2 | stuk | 300,00 | 301 | 1 |
| 0956716 | 92x35cm | links | peren | 041HHL3 | stuk | 300,00 | 301 | 1 |



| Art.nr | Specificaties | Kleur | Lev.nr | Ehd | Prijs | Grp | CC |
|--------|---------------|-------|--------|-----|-------|-----|----|
|--------|---------------|-------|--------|-----|-------|-----|----|

Detremmerie Globe 3001

hoge kast links

| | | | | | | | |
|---------|------------|----------|--------|------|--------|-----|---|
| 0957933 | 169,7x35cm | wit | 041HL1 | stuk | 379,00 | 301 | 1 |
| 0957941 | 169,7x35cm | pergamon | 041HL2 | stuk | 379,00 | 301 | 1 |
| 0957968 | 169,7x35cm | peren | 041HL3 | stuk | 379,00 | 301 | 1 |

Sanitair producten

hoge kast rechts

| | | | | | | | |
|---------|------------|----------|--------|------|--------|-----|---|
| 0957976 | 169,7x35cm | wit | 041HR1 | stuk | 379,00 | 301 | 1 |
| 0957984 | 169,7x35cm | pergamon | 041HR2 | stuk | 379,00 | 301 | 1 |
| 0957992 | 169,7x35cm | peren | 041HR3 | stuk | 379,00 | 301 | 1 |

Baden /
douchebakken /
stoomcabines

Detremmerie Havana

meubelset

| | | | | | | | | |
|---------|----------|---------------------------------|-----------------|-----------|------|---------|-----|---|
| 0951733 | 75x50cm | m. spiegelpaneel | wit/wit | 082070P1 | stuk | 1502,00 | 301 | 1 |
| 0951734 | 75x50cm | m. spiegelpaneel | wit/granada oak | 082070P2 | stuk | 1502,00 | 301 | 1 |
| 0951735 | 75x50cm | m. spiegelpaneel | wit/negro oak | 082070P3 | stuk | 1502,00 | 301 | 1 |
| 0951736 | 125x50cm | 2 bakken m. spiegelpaneel | wit/wit | 082120P1 | stuk | 1956,00 | 301 | 1 |
| 0951737 | 125x50cm | 2 bakken m. spiegelpaneel | wit/granada oak | 082120P2 | stuk | 1956,00 | 301 | 1 |
| 0951738 | 125x50cm | 2 bakken m. spiegelpaneel | wit/negro oak | 082120P3 | stuk | 1956,00 | 301 | 1 |
| 0951739 | 75x50cm | m. spiegelkast scharnier links | wit/wit | 082070KL1 | stuk | 1577,00 | 301 | 1 |
| 0951740 | 75x50cm | m. spiegelkast scharnier links | wit/granada oak | 082070KL2 | stuk | 1577,00 | 301 | 1 |
| 0951741 | 75x50cm | m. spiegelkast scharnier links | wit/negro oak | 082070KL3 | stuk | 1577,00 | 301 | 1 |
| 0951742 | 75x50cm | m. spiegelkast scharnier rechts | wit/wit | 082070KR1 | stuk | 1577,00 | 301 | 1 |
| 0951743 | 75x50cm | m. spiegelkast scharnier rechts | wit/granada oak | 082070KR2 | stuk | 1577,00 | 301 | 1 |
| 0951744 | 75x50cm | m. spiegelkast scharnier rechts | wit/negro oak | 082070KR3 | stuk | 1577,00 | 301 | 1 |
| 0951745 | 125x50cm | 2 bakken m. spiegelkast | wit/wit | 082120K1 | stuk | 2289,00 | 301 | 1 |
| 0951746 | 125x50cm | 2 bakken m. spiegelkast | wit/granada oak | 082120K2 | stuk | 2289,00 | 301 | 1 |
| 0951747 | 125x50cm | 2 bakken m. spiegelkast | wit/negro oak | 082120K3 | stuk | 2289,00 | 301 | 1 |



Kranen



Douchegarnituur



Accessoires en
spiegels



Douchewanden



Toebehoren &
afvoeren



Spoel- &
installatiesystemen



Badkamermeubelen
en toiletkasten

kolomkast

| | | | | | | | | |
|---------|----------|------------------|-------------|--------|------|--------|-----|---|
| 0951729 | 160x35cm | scharnier links | wit | 082HL1 | stuk | 318,00 | 301 | 1 |
| 0951731 | 160x35cm | scharnier links | granada oak | 082HL2 | stuk | 318,00 | 301 | 1 |
| 0951732 | 160x35cm | scharnier links | negro oak | 082HL3 | stuk | 318,00 | 301 | 1 |
| 0951769 | 160x35cm | scharnier rechts | granada oak | 082HR2 | stuk | 318,00 | 301 | 1 |
| 0951770 | 160x35cm | scharnier rechts | negro oak | 082HR3 | stuk | 318,00 | 301 | 1 |











Gootstenen en
wastroggen

Utiliteit



 Detremmerie

MASTERS IN PRODUCING BATHROOM FURNITURE

| Art.nr | Specificaties | Kleur | Lev.nr | Ehd | Prijs | Grp | CC | | | |
|---------------------------------------|---------------|---------|----------|---------|---------|--------|-----|---|---|-----------------------------|
| | | | | | | | | Detremmerie Hip | | |
| meubelset 90cm m. spiegel | | | | | | | | | | |
| 0952624 | | wit | 088090P1 | stuk | 1585,00 | 301 | 1 |  | Sanitair producten | |
| 0952625 | | lineart | 088090P2 | stuk | 1585,00 | 301 | 1 | | | |
| 0952626 | | zebrano | 088090P3 | stuk | 1585,00 | 301 | 1 | | | |
| meubelset 120cm m. spiegel | | | | | | | | | | |
| 0952627 | | wit | 088120P1 | stuk | 1970,00 | 301 | 1 |  | Baden / douchebakken / stoomcabines | |
| 0952628 | | lineart | 088120P2 | stuk | 1970,00 | 301 | 1 | | | |
| 0952629 | | zebrano | 088120P3 | stuk | 1970,00 | 301 | 1 | | | |
| meubelset 90cm m. spiegelkast | | | | | | | | | | |
| 0952630 | | wit | 088090K1 | stuk | 2152,00 | 301 | 1 |  | Douchegarnituur | |
| 0952631 | | lineart | 088090K2 | stuk | 2152,00 | 301 | 1 | | | |
| 0952632 | | zebrano | 088090K3 | stuk | 2152,00 | 301 | 1 | | | |
| meubelset 120cm m. spiegelkast | | | | | | | | | | |
| 0952633 | | wit | 088120K1 | stuk | 2624,00 | 301 | 1 |  | Douchewanden | |
| 0952634 | | lineart | 088120K2 | stuk | 2624,00 | 301 | 1 | | | |
| 0952635 | | zebrano | 088120K3 | stuk | 2624,00 | 301 | 1 | | | |
| spiegel m. verlichting | | | | | | | | | | |
| 0952636 | 90x61cm | wit | 088P0901 | stuk | 496,00 | 301 | 1 |  | Spool- & installatiesystemen | |
| 0952637 | 90x61cm | lineart | 088P0902 | stuk | 496,00 | 301 | 1 | | | |
| 0952638 | 90x61cm | zebrano | 088P0903 | stuk | 496,00 | 301 | 1 | | | |
| 0952639 | 120x61cm | wit | 088P1201 | stuk | 699,00 | 301 | 1 | | | |
| 0952640 | 120x61cm | lineart | 088P1202 | stuk | 699,00 | 301 | 1 | | | |
| 0952641 | 120x61cm | zebrano | 088P1203 | stuk | 699,00 | 301 | 1 | | | |
| spiegelkast m. verlichting | | | | | | | | | | |
| 0952642 | 90x61cm | wit | 088K0901 | stuk | 1063,00 | 301 | 1 |  | Badkamermeubelen en toiletkasten | |
| 0952643 | 90x61cm | lineart | 088K0902 | stuk | 1063,00 | 301 | 1 | | | |
| 0952644 | 90x61cm | zebrano | 088K0903 | stuk | 1063,00 | 301 | 1 | | | |
| 0952645 | 120x61cm | wit | 088K1201 | stuk | 1353,00 | 301 | 1 | | | |
| 0952646 | 120x61cm | lineart | 088K1202 | stuk | 1353,00 | 301 | 1 | | | |
| 0952647 | 120x61cm | zebrano | 088K1203 | stuk | 1353,00 | 301 | 1 | | | |
| halfhoge kast | | | | | | | | | | |
| 0952610 | 103x30x40cm | links | wit | 088HHL1 | stuk | 525,00 | 301 | 1 |  | Gootstenen en wastroggen |
| 0952611 | 103x30x40cm | links | lineart | 088HHL2 | stuk | 525,00 | 301 | 1 | | |
| 0952612 | 103x30x40cm | links | zebrano | 088HHL3 | stuk | 525,00 | 301 | 1 | | |
| 0952614 | 103x30x40cm | rechts | wit | 088HHR1 | stuk | 525,00 | 301 | 1 | | |
| 0952615 | 103x30x40cm | rechts | lineart | 088HHR2 | stuk | 525,00 | 301 | 1 | | |
| 0952616 | 103x30x40cm | rechts | zebrano | 088HHR3 | stuk | 525,00 | 301 | 1 | | |
| hoge kast | | | | | | | | | | |
| 0952617 | 155x30x40cm | links | wit | 088HL1 | stuk | 631,00 | 301 | 1 |  | Utiliteit |
| 0952618 | 155x30x40cm | links | lineart | 088HL2 | stuk | 631,00 | 301 | 1 | | |
| 0952619 | 155x30x40cm | links | zebrano | 088HL3 | stuk | 631,00 | 301 | 1 | | |
| 0952620 | 155x30x40cm | rechts | wit | 088HR1 | stuk | 631,00 | 301 | 1 | | |
| 0952622 | 155x30x40cm | rechts | lineart | 088HR2 | stuk | 631,00 | 301 | 1 | | |
| 0952623 | 155x30x40cm | rechts | zebrano | 088HR3 | stuk | 631,00 | 301 | 1 | | |
| wandbidet | | | | | | | | | | |
| 0952649 | | zwart | 99930333 | stuk | 460,00 | 301 | 1 |  | | |

| Art.nr | Specificaties | Kleur | Lev.nr | Ehd | Prijs | Grp | CC |
|--------|---------------|-------|--------|-----|-------|-----|----|
|--------|---------------|-------|--------|-----|-------|-----|----|

Detremmerie Hip

wandclosetpot diepspoel

| | | | | | | | |
|---------|--|-------|----------|------|--------|-----|---|
| 0952650 | | zwart | 99930334 | stuk | 750,00 | 301 | 1 |
|---------|--|-------|----------|------|--------|-----|---|



Sanitair producten

Baden /
douchebakken /
stoomcabines

Detremmerie at Long Island

kolomkast

| | | | | | | | | |
|---------|-------------|--------|-------------|-----------------|------|--------|-----|---|
| 0954633 | 168x40x30cm | links | wit | 073221149040101 | stuk | 861,00 | 301 | 1 |
| 0954634 | 168x40x30cm | links | kiezelgrijs | 073221149040102 | stuk | 861,00 | 301 | 1 |
| 0954635 | 168x40x30cm | rechts | wit | 073221149040201 | stuk | 861,00 | 301 | 1 |
| 0954636 | 168x40x30cm | rechts | kiezelgrijs | 073221149040202 | stuk | 861,00 | 301 | 1 |



Kranen

Douchegarnituur

spiegel m. verlichting

| | | | | | | | | |
|---------|------------|--|-------------|-----------------|------|--------|-----|---|
| 0954650 | 75x73.5cm | | wit | 073245738075001 | stuk | 525,00 | 301 | 1 |
| 0954651 | 75x73.5cm | | kiezelgrijs | 073245738075002 | stuk | 525,00 | 301 | 1 |
| 0954652 | 150x73.5cm | | wit | 073245738150001 | stuk | 731,00 | 301 | 1 |
| 0954653 | 150x73.5cm | | kiezelgrijs | 073245738150002 | stuk | 731,00 | 301 | 1 |



Accessoires en
spiegels

Douchewanden



Toebehoren &
afvoeren

spiegelkast m. draaieur m. verlichting

| | | | | | | | | |
|---------|-----------|--------|-------------|-----------------|------|--------|-----|---|
| 0954654 | 75x73.5cm | links | wit | 073242872075101 | stuk | 880,00 | 301 | 1 |
| 0954655 | 75x73.5cm | links | kiezelgrijs | 073242872075102 | stuk | 880,00 | 301 | 1 |
| 0954656 | 75x73.5cm | rechts | wit | 073242872075201 | stuk | 880,00 | 301 | 1 |
| 0954657 | 75x73.5cm | rechts | kiezelgrijs | 073242872075202 | stuk | 880,00 | 301 | 1 |



Spoel- &
installatiesystemen

Badkamermeubelen
en toiletkasten

spiegelkast m. draaideuren m. verlichting

| | | | | | | | | |
|---------|------------|--|-------------|-----------------|------|---------|-----|---|
| 0954658 | 150x73.5cm | | wit | 073242872150001 | stuk | 1547,00 | 301 | 1 |
| 0954660 | 150x73.5cm | | kiezelgrijs | 073242872150002 | stuk | 1547,00 | 301 | 1 |



Gootstenen en
wastroggen

Utiliteit

spiegelpaneel los

| | | | | | | | | |
|---------|----------|--|-----|-----------------|------|--------|-----|---|
| 0954661 | 200x60cm | | wit | 074245736060001 | stuk | 450,00 | 301 | 1 |
|---------|----------|--|-----|-----------------|------|--------|-----|---|

meubelset m. spiegel 75cm

| | | | | | | | | |
|---------|--|-------------|-------------|-----------|------|---------|-----|---|
| 0953726 | | z. kraangat | wit | 073075P21 | stuk | 2040,00 | 301 | 1 |
| 0953727 | | z. kraangat | kiezelgrijs | 073075P22 | stuk | 2040,00 | 301 | 1 |





spiegelpaneel los

| | | | | | | | | |
|---------|----------|--|-------------|-----------------|------|--------|-----|---|
| 0954662 | 200x60cm | | kiezelgrijs | 074245736060002 | stuk | 450,00 | 301 | 1 |
|---------|----------|--|-------------|-----------------|------|--------|-----|---|

meubelset m. spiegel 75cm

| | | | | | | | | |
|---------|--|-----------------|-------------|-----------|------|---------|-----|---|
| 0953728 | | m. 1 kraangat | wit | 073075P11 | stuk | 2040,00 | 301 | 1 |
| 0953729 | | m. 1 kraangat | kiezelgrijs | 073075P12 | stuk | 2040,00 | 301 | 1 |
| 0953730 | | m. 3 kraangaten | wit | 073075P31 | stuk | 2071,00 | 301 | 1 |
| 0953731 | | m. 3 kraangaten | kiezelgrijs | 073075P32 | stuk | 2071,00 | 301 | 1 |

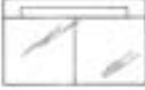
| Art.nr | Specificaties | Kleur | Lev.nr | Ehd | Prijs | Grp | CC | | | | |
|---|------------------------|-------------|------------|------|---------|-----|----|--|---|--|--------|
| Detremmerie at Long Island | | | | | | | | | | | |
| meubelset m. spiegel 150cm | | | | | | | | | | | |
| 0953732 | z. kraangat | wit | 073150PZ1 | stuk | 3552,00 | 301 | 1 | | Sanitair producten | | |
| 0953733 | z. kraangat | kiezelgrijs | 073150PZ2 | stuk | 3552,00 | 301 | 1 | | | | |
| 0953734 | m. 2 kraangaten | wit | 073150P21 | stuk | 3552,00 | 301 | 1 | | Baden / douchebakken / stoomcabines | | |
| 0953735 | m. 2 kraangaten | kiezelgrijs | 073150P22 | stuk | 3552,00 | 301 | 1 | | | | |
| 0953736 | m. 6 kraangaten | wit | 073150P61 | stuk | 3583,00 | 301 | 1 | | | | |
| 0953737 | m. 6 kraangaten | kiezelgrijs | 073150P62 | stuk | 3583,00 | 301 | 1 | | | | |
| meubelset m. spiegelkast 75cm | | | | | | | | | | | |
| 0953738 | links z. kraangat | wit | 073075KLZ1 | stuk | 2395,00 | 301 | 1 | | | | Kranen |
| 0953740 | links z. kraangat | kiezelgrijs | 073075KLZ2 | stuk | 2395,00 | 301 | 1 | | | | |
| 0953739 | rechts z. kraangat | wit | 073075KRZ1 | stuk | 2395,00 | 301 | 1 | | Douchegarnituur | | |
| 0953741 | rechts z. kraangat | kiezelgrijs | 073075KRZ2 | stuk | 2395,00 | 301 | 1 | | | | |
| 0953742 | links m. 1 kraangat | wit | 073075KL11 | stuk | 2395,00 | 301 | 1 | | | | |
| 0953744 | links m. 1 kraangat | kiezelgrijs | 073075KL12 | stuk | 2395,00 | 301 | 1 | | | | |
| 0953743 | rechts m. 1 kraangat | wit | 073075KR11 | stuk | 2395,00 | 301 | 1 | | | | |
| 0953745 | rechts m. 1 kraangat | kiezelgrijs | 073075LR12 | stuk | 2395,00 | 301 | 1 | | | | |
| 0953746 | links m. 3 kraangaten | wit | 073075KL31 | stuk | 2426,00 | 301 | 1 | | | | |
| 0953748 | links m. 3 kraangaten | kiezelgrijs | 073075KL32 | stuk | 2426,00 | 301 | 1 | | | | |
| 0953747 | rechts m. 3 kraangaten | wit | 073075KR31 | stuk | 2426,00 | 301 | 1 | | | | |
| 0953749 | rechts m. 3 kraangaten | kiezelgrijs | 073075KR32 | stuk | 2426,00 | 301 | 1 | | | | |
| meubelset m. spiegelkast 150cm | | | | | | | | | | | |
| 0953750 | z. kraangat | wit | 073150KZ1 | stuk | 4368,00 | 301 | 1 | | Douchewanden | | |
| 0953751 | z. kraangat | kiezelgrijs | 073150KZ2 | stuk | 4368,00 | 301 | 1 | | | | |
| 0953752 | m. 2 kraangaten | wit | 073150K31 | stuk | 4368,00 | 301 | 1 | | Toebehoren & afvoeren | | |
| 0953753 | m. 2 kraangaten | kiezelgrijs | 073150K32 | stuk | 4368,00 | 301 | 1 | | | | |
| 0953754 | m. 6 kraangaten | wit | 073150K61 | stuk | 4399,00 | 301 | 1 | | | | |
| 0953755 | m. 6 kraangaten | kiezelgrijs | 073150K62 | stuk | 4399,00 | 301 | 1 | | | | |
| Detremmerie Maite | | | | | | | | | | | |
| meubelset 113cm m. 1 kraangat m. spiegelpaneel | | | | | | | | | | | |
| 0151505 | m. marmer wastafelblad | wit/wit | 0661131P20 | stuk | 2562,00 | 301 | 1 | | Spoel- & installatiesystemen | | |
| 0151599 | m. marmer wastafelblad | grijs/wit | 0661131P32 | stuk | 2562,00 | 301 | 1 | | | | |
| 0151688 | m. marmer wastafelblad | perg./perg. | 0661131P41 | stuk | 2562,00 | 301 | 1 | | | | |
| meubelset 113cm m. 2 kraangaten m. spiegelpaneel | | | | | | | | | | | |
| 0151513 | m. marmer wastafelblad | wit/wit | 0661132P20 | stuk | 2562,00 | 301 | 1 | | Badkamermeubelen en toiletkasten | | |
| 0151602 | m. marmer wastafelblad | grijs/wit | 0661132P32 | stuk | 2562,00 | 301 | 1 | | | | |
| 0151696 | m. marmer wastafelblad | perg./perg. | 0661132P41 | stuk | 2562,00 | 301 | 1 | | | | |
| meubelset 113cm m. 1 kraangat m. spiegelkast | | | | | | | | | | | |
| 0151556 | m. marmer wastafelblad | wit/wit | 661131S20 | stuk | 3054,00 | 301 | 1 | | Gootstenen en wastroggen | | |
| 0151637 | m. marmer wastafelblad | grijs/wit | 0661131S32 | stuk | 3054,00 | 301 | 1 | | | | |
| 0151734 | m. marmer wastafelblad | perg./perg. | 0441131S41 | stuk | 3054,00 | 301 | 1 | | | | |
| meubelset 113cm m. 2 kraangaten m. spiegelkast | | | | | | | | | | | |
| 0151564 | m. marmer wastafelblad | wit/wit | 0661132S20 | stuk | 3054,00 | 301 | 1 | | Utiliteit | | |
| 0151645 | m. marmer wastafelblad | grijs/wit | 0661132S32 | stuk | 3054,00 | 301 | 1 | | | | |
| 0151742 | m. marmer wastafelblad | perg./perg. | 0661132S41 | stuk | 3054,00 | 301 | 1 | | | | |
| meubelset 113cm m. 2 kraangaten m. spiegelpaneel | | | | | | | | | | | |
| 0151506 | m. marmer wastafelblad | mat wit/wit | 0661142P20 | stuk | 2583,00 | 301 | 1 | | | | |
| 0958510 | m. marmer wastafelblad | grijs/wit | 0661142P32 | stuk | 2583,00 | 301 | 1 | | | | |
| 0958511 | m. marmer wastafelblad | perg./perg. | 0661142P41 | stuk | 2583,00 | 301 | 1 | | | | |
| meubelset 113cm m. 2 kraangaten m. spiegelkast | | | | | | | | | | | |
| 0151507 | m. marmer wastafelblad | mat wit/wit | 0661142S20 | stuk | 3075,00 | 301 | 1 | | | | |
| 0958513 | m. marmer wastafelblad | grijs/wit | 0661142S32 | stuk | 3075,00 | 301 | 1 | | | | |
| 0958515 | m. marmer wastafelblad | perg./perg. | 0661142S41 | stuk | 3075,00 | 301 | 1 | | | | |

| | Art.nr | Specificaties | Kleur | Lev.nr | Ehd | Prijs | Grp | CC |
|---|---|---------------|----------------|-----------------|------|---------|-----|----|
| | Detremmerie Maite | | | | | | | |
| Sanitair producten | kolomkast links | | | | | | | |
| | 0151777 | 170x40cm | wit | 066221139040105 | stuk | 721,00 | 301 | 1 |
| | 0151793 | 170x40cm | grijs | 066221139040117 | stuk | 721,00 | 301 | 1 |
| | 0151815 | 170x40cm | pergamon | 066221139040111 | stuk | 721,00 | 301 | 1 |
| Baden / douchebakken / stoomcabines |  | | | | | | | |
| Kranen | kolomkast rechts | | | | | | | |
| | 0151785 | 170x40cm | wit | 066221139040205 | stuk | 721,00 | 301 | 1 |
| | 0151807 | 170x40cm | grijs | 066221139040217 | stuk | 721,00 | 301 | 1 |
| | 0151823 | 170x40cm | pergamon | 066221139040211 | stuk | 721,00 | 301 | 1 |
| Douchegarnituur | spiegelpaneel m. TL-verlichting | | | | | | | |
| | 0151831 | 113x70cm | wit | 066245729113001 | stuk | 584,00 | 301 | 1 |
| Accessoires en spiegels | spiegelkast 2-delig m. TL-verlichting | | | | | | | |
| | 0151858 | 113x70cm | | 066242865113001 | stuk | 1076,00 | 301 | 1 |
| Douchewanden |  | | | | | | | |
| Toebehoren & afvoeren | Detremmerie Massimo 5007 | | | | | | | |
| | meubelset m. spiegel | | | | | | | |
| | 0956791 | 110cm | wit | 043110P11 | stuk | 3348,00 | 301 | 1 |
| | 0956805 | 110cm | grijs/blad=wit | 043110P12 | stuk | 3348,00 | 301 | 1 |
| Spoel- & installatiesystemen | meubelset m. spiegelkast | | | | | | | |
| | 0956848 | 110cm | wit | 043110S11 | stuk | 3879,00 | 301 | 1 |
| | 0956856 | 110cm | grijs/blad=wit | 043110S12 | stuk | 3879,00 | 301 | 1 |
| Badkamermeubelen en toiletkasten |  | | | | | | | |
| | meubelset m. spiegel | | | | | | | |
| Gootstenen en wastroggen | 0956813 | 165cm | wit | 043165P11 | stuk | 4740,00 | 301 | 1 |
| | 0956821 | 165cm | grijs/blad=wit | 043165P12 | stuk | 4740,00 | 301 | 1 |
| Utiliteit |  | | | | | | | |
| | meubelset m. spiegelkast | | | | | | | |
| | 0956864 | 165cm | wit | 043165S11 | stuk | 5374,00 | 301 | 1 |
| | 0956872 | 165cm | grijs/blad=wit | 043165S12 | stuk | 5374,00 | 301 | 1 |
| | halfhogekast links | | | | | | | |
| | 0956880 | 132x55cm | wit | 043221121055101 | stuk | 517,00 | 301 | 1 |
| | 0956902 | 132x55cm | grijs | 043221121055103 | stuk | 517,00 | 301 | 1 |
| | halfhogekast rechts | | | | | | | |
| | 0956899 | 132x55cm | wit | 043221121055201 | stuk | 517,00 | 301 | 1 |
| | 0956910 | 132x55cm | grijs | 043221121055203 | stuk | 517,00 | 301 | 1 |
| | tablet folie voor halfhogekast | | | | | | | |
| | 0956929 | | wit | 043201201055001 | stuk | 97,00 | 301 | 1 |

| Art.nr | Specificaties | Kleur | Lev.nr | Ehd | Prijs | Grp | CC |
|--|---------------|-----------------|------------------|------|---------|-----|----|
| Detremmerie Massimo 5007 | | | | | | | |
| tablet kunstmarmer voor halfhogekast | | | | | | | |
| 0957798 | | pergamon | 04340410805501 | stuk | 250,00 | 301 | 1 |
| 0958050 | | wit | 04340410805500 | stuk | 250,00 | 301 | 1 |
| Detremmerie Maxim 5006 | | | | | | | |
| meubelset 100cm m. spiegel m. kraangat | | | | | | | |
| 0958018 | | wit/blad=wit | 042100P30 | stuk | 1771,00 | 301 | 1 |
| 0958026 | | grijs/blad=wit | 042100P48 | stuk | 1771,00 | 301 | 1 |
| 0959413 | | peer/blad=wit | 042100P42 | stuk | 1771,00 | 301 | 1 |
| 0959421 | | peer/blad=perg. | 042100P62 | stuk | 1771,00 | 301 | 1 |
| meubelset 100cm m. spiegel m. greep m. kraangat | | | | | | | |
| 0959464 | | wit/blad=wit | 042100PT30 | stuk | 1771,00 | 301 | 1 |
| 0959472 | | peer/blad=wit | 042100PT42 | stuk | 1771,00 | 301 | 1 |
| 0959480 | | peer/blad=perg. | 042100PT62 | stuk | 1771,00 | 301 | 1 |
| meubelset 100cm m. spiegel m. 2 kraangaten | | | | | | | |
| 0956945 | | wit/blad=wit | 042101P30 | stuk | 1771,00 | 301 | 1 |
| 0956953 | | grijs/blad=wit | 042101P33 | stuk | 1771,00 | 301 | 1 |
| 0959448 | | peer/blad=wit | 042101P42 | stuk | 1771,00 | 301 | 1 |
| 0959456 | | peer/blad=perg. | 042101P62 | stuk | 1771,00 | 301 | 1 |
| meubelset 100cm m. spiegel m. greep m. 2 kraangaten | | | | | | | |
| 0959499 | | wit/blad=wit | 042101PT30 | stuk | 1771,00 | 301 | 1 |
| 0934705 | | grijs/blad=wit | 042101PT43 | stuk | 1771,00 | 301 | 1 |
| 0959510 | | peer/blad=wit | 042101PT42 | stuk | 1771,00 | 301 | 1 |
| 0959529 | | peer/blad=perg. | 042101PT62 | stuk | 1771,00 | 301 | 1 |
| meubelset 100cm m. spiegelkast m. kraangat | | | | | | | |
| 0956961 | | wit/blad=wit | 042100S30 | stuk | 2240,00 | 301 | 1 |
| 0956988 | | grijs/blad=wit | 042100S33 | stuk | 2240,00 | 301 | 1 |
| meubelset 100cm m. spiegelkast m. greep m. kraangat | | | | | | | |
| 0934691 | | grijs/blad=wit | 042100ST43 | stuk | 2240,00 | 301 | 1 |
| meubelset 100cm m. spiegelkast m. 2 kraangaten | | | | | | | |
| 0958034 | | wit | 042101S30 | stuk | 2240,00 | 301 | 1 |
| 0958042 | | grijs | 042101S48 | stuk | 2240,00 | 301 | 1 |
| meubelset 100cm m. spiegelkast m. greep m. 2 kraangaten | | | | | | | |
| 0934683 | | grijs/blad=wit | 042101ST43 | stuk | 2240,00 | 301 | 1 |
| meubelset 100cm m. spiegel m. laden m. kraangat | | | | | | | |
| 0959162 | | wit | 042200P30 | stuk | 2144,00 | 301 | 1 |
| 0959170 | | grijs/blad=wit | 042200P48 | stuk | 2144,00 | 301 | 1 |
| meubelset 100cm m. spiegel m. laden m. 2 kraangaten | | | | | | | |
| 0959197 | | wit | 042201P30 | stuk | 2144,00 | 301 | 1 |
| 0959200 | | grijs/blad=wit | 042201P48 | stuk | 2144,00 | 301 | 1 |
| meubelset 100cm m. spiegelkast m. laden m. kraangat | | | | | | | |
| 0959219 | | wit | 042200S30 | stuk | 2613,00 | 301 | 1 |
| 0959227 | | grijs/blad=wit | 042200S48 | stuk | 2613,00 | 301 | 1 |
| meubelset 100cm m. spiegelkast m. greep m. kraangat | | | | | | | |
| 0959537 | | wit | 042200ST30 | stuk | 2613,00 | 301 | 1 |
| meubelset 100cm m. spiegelkast m. laden m. 2 kraangaten | | | | | | | |
| 0959235 | | wit | 042201S30 | stuk | 2613,00 | 301 | 1 |
| 0959243 | | grijs/blad=wit | 042201S48 | stuk | 2613,00 | 301 | 1 |
| meubelset 100cm m. spiegelkast m. greep m. 2 kraangaten | | | | | | | |
| 0959545 | | wit | 042201ST30 | stuk | 2613,00 | 301 | 1 |
| halfhoge kast m. ingewerkte greep links | | | | | | | |
| 0956996 | 92x50cm | wit | 0422211220501010 | stuk | 397,00 | 301 | 1 |
| 0957011 | 92x50cm | grijs | 0422211220501028 | stuk | 397,00 | 301 | 1 |
| 0959359 | 92x50cm | peren | 0422211220501022 | stuk | 397,00 | 301 | 1 |

Sanitair producten

Baden /
douchebakken /
stoomcabines

Kranen

Douchegarnituur

Accessoires en
spiegels

Douchewanden

Toebehoren &
afvoeren

Spoel- &
installatiesystemen

Badkamermeubelen
en toiletkasten

Gootstenen en
wastroggen

Utiliteit



| | Art.nr | Specificaties | Kleur | Lev.nr | Ehd | Prijs | Grp | CC |
|---|---|---------------|-------------------|------------------|------|---------|-----|----|
| Detremmerie Maxim 5006 | | | | | | | | |
| Sanitair producten | halfhoge kast m. ingewerkte greep rechts | | | | | | | |
| | 0957003 | 92x50cm | wit | 0422211220502010 | stuk | 397,00 | 301 | 1 |
| | 0957038 | 92x50cm | grijs | 0422211220502028 | stuk | 397,00 | 301 | 1 |
| | 0959367 | 92x50cm | peren | 0422211220502022 | stuk | 397,00 | 301 | 1 |
| Baden / douchebakken / stoomcabines | halfhoge kast m. stanggreep links | | | | | | | |
| | 0959375 | 92x50cm | wit | 0422211240501010 | stuk | 397,00 | 301 | 1 |
| | 0959383 | 92x50cm | peren | 0422211240501022 | stuk | 397,00 | 301 | 1 |
| | 0934740 | 92x50cm | grijs | 0422211240501028 | stuk | 397,00 | 301 | 1 |
| Kranen | halfhoge kast m. stanggreep rechts | | | | | | | |
| | 0959391 | 92x50cm | wit | 0422211240502010 | stuk | 397,00 | 301 | 1 |
| | 0959405 | 92x50cm | peren | 0422211240502022 | stuk | 397,00 | 301 | 1 |
| | 0934721 | 92x50cm | grijs | 0422211240502028 | stuk | 397,00 | 301 | 1 |
| Douchegarnituur | glasplateau m. inox houders | | | | | | | |
| | 0957062 | 50x20cm | | 4215505002000 | stuk | 134,00 | 301 | 1 |
| Accessoires en spiegels | tablet voor halfhoge kast | | | | | | | |
| | 0957046 | | wit | 042201207050001 | stuk | 97,00 | 301 | 1 |
| | 0957054 | | grijs | 042201207050 | stuk | 90,00 | 301 | 1 |
| Detremmerie Micro 6000 | | | | | | | | |
| Douchewanden | meubelset | | | | | | | |
| | 0955612 | | wit/wit/wit | 285430 | stuk | 1092,00 | 301 | 1 |
| | 0955620 | | wit/grijs/wit | 285434 | stuk | 1092,00 | 301 | 1 |
| | 0955647 | | jasm./jasm./perg. | 285451 | stuk | 1092,00 | 301 | 1 |
| | 0955639 | | grijs/kersen/wit | 285443 | stuk | 1092,00 | 301 | 1 |
| Toebehoren & afvoeren | kolomkast | | | | | | | |
| | 0955868 | rechts | jasmijn/jasmijn | 0282211250252016 | stuk | 373,00 | 301 | 1 |
| Spoel- & installatiesystemen | 0955833 | rechts | grijs/kersen | 0282211250252023 | stuk | 373,00 | 301 | 1 |
| | 0955795 | rechts | wit/wit | 0282211250252010 | stuk | 373,00 | 301 | 1 |
| | 0955841 | links | jasmijn/jasmijn | 0282211250251016 | stuk | 373,00 | 301 | 1 |
| | 0955825 | links | grijs/kersen | 0282211250251023 | stuk | 373,00 | 301 | 1 |
| | 0955809 | links | wit/grijs | 0282211250251014 | stuk | 373,00 | 301 | 1 |
| Badkamermeubelen en toiletkasten | 0955787 | links | wit/wit | 0282211250251010 | stuk | 373,00 | 301 | 1 |
| | open sierrek m. deur | | | | | | | |
| Gootstenen en wastroggen | 0955779 | rechts | jasmijn/jasmijn | 0282211200252016 | stuk | 290,00 | 301 | 1 |
| | 0955752 | rechts | grijs/kersen | 0282211200252023 | stuk | 290,00 | 301 | 1 |
| | 0955736 | rechts | wit/grijs | 0282211200252014 | stuk | 290,00 | 301 | 1 |
| | 0955701 | rechts | wit/wit | 0282211200252010 | stuk | 290,00 | 301 | 1 |
| | 0955760 | links | jasmijn/jasmijn | 0282211200251016 | stuk | 290,00 | 301 | 1 |
| Utiliteit | 0955744 | links | grijs/kersen | 0282211200251023 | stuk | 290,00 | 301 | 1 |
| | 0955728 | links | wit/grijs | 0282211200251014 | stuk | 290,00 | 301 | 1 |
| | 0955698 | links | wit/wit | 0282211200251010 | stuk | 290,00 | 301 | 1 |
| open sierrek m. glasplaten | | | | | | | | |
| | 0955655 | | wit | 028253618025001 | stuk | 271,00 | 301 | 1 |
| | 0955663 | | grijs | 028253618025003 | stuk | 271,00 | 301 | 1 |
| | 0955671 | | jasmijn | 028253618025002 | stuk | 271,00 | 301 | 1 |
| Detremmerie Micro Corner 6001 | | | | | | | | |
| | meubelset | | | | | | | |
| | 0955876 | | wit/wit/wit | 029130 | stuk | 1211,00 | 301 | 1 |
| | 0955884 | | wit/grijs/wit | 029134 | stuk | 1211,00 | 301 | 1 |
| | 0955892 | | grijs/kers/wit | 029143 | stuk | 1211,00 | 301 | 1 |

| Art.nr | Specificaties | Kleur | Lev.nr | Ehd | Prijs | Grp | CC |
|--------|---------------|-------|--------|-----|-------|-----|----|
|--------|---------------|-------|--------|-----|-------|-----|----|

Detremmerie Micro Corner 6001

open sierrek m. glasplaten

| | | | | | | | |
|---------|--------|-----------------|------------------|------|--------|-----|---|
| 0955914 | | wit | 029253618025001 | stuk | 271,00 | 301 | 1 |
| 0955922 | | grijs | 029253618025003 | stuk | 271,00 | 301 | 1 |
| 0955930 | | jasmijn | 029253618025002 | stuk | 271,00 | 301 | 1 |
| 0955949 | links | wit/wit | 0292211200251010 | stuk | 290,00 | 301 | 1 |
| 0955965 | links | wit/grijs | 0292211200251014 | stuk | 290,00 | 301 | 1 |
| 0955981 | links | grijs/kersen | 0292211200251023 | stuk | 290,00 | 301 | 1 |
| 0956015 | links | jasmijn/jasmijn | 0292211200251016 | stuk | 290,00 | 301 | 1 |
| 0955957 | rechts | wit/wit | 0292211200252010 | stuk | 290,00 | 301 | 1 |
| 0955973 | rechts | wit/grijs | 0292211200252014 | stuk | 290,00 | 301 | 1 |
| 0956007 | rechts | grijs/kersen | 0292211200252023 | stuk | 290,00 | 301 | 1 |
| 0956023 | rechts | jasmijn/jasmijn | 0292211200252016 | stuk | 290,00 | 301 | 1 |

hoge kast

| | | | | | | | |
|---------|--------|-----------------|------------------|------|--------|-----|---|
| 0956031 | links | wit/wit | 0292211200251010 | stuk | 373,00 | 301 | 1 |
| 0956066 | links | wit/grijs | 0292211200251014 | stuk | 373,00 | 301 | 1 |
| 0956082 | links | grijs/kersen | 0292211200251023 | stuk | 373,00 | 301 | 1 |
| 0956104 | links | jasmijn/jasmijn | 0292211250251016 | stuk | 373,00 | 301 | 1 |
| 0956090 | rechts | grijs/kersen | 0292211250252023 | stuk | 373,00 | 301 | 1 |
| 0956074 | rechts | wit/grijs | 0292211250252014 | stuk | 373,00 | 301 | 1 |
| 0956058 | rechts | wit/wit | 0292211250252010 | stuk | 373,00 | 301 | 1 |
| 0956112 | rechts | jasmijn/jasmijn | 0292211250252016 | stuk | 373,00 | 301 | 1 |

Detremmerie Orphee 2002

meubelset 70cm m. opbouwastafel m. spiegelkast

| | | | | | | | |
|---------|--------|--------------|------------|------|---------|-----|---|
| 0954934 | links | beuk/wit/wit | 03570LLS40 | stuk | 1827,00 | 301 | 1 |
| 0954942 | rechts | beuk/wit/wit | 03570RLS40 | stuk | 1827,00 | 301 | 1 |

meubelset 100cm m. opbouwastafel m. spiegelkast

| | | | | | | | |
|---------|--------|--------------|-------------|------|---------|-----|---|
| 0954969 | links | beuk/wit/wit | 035100LLS40 | stuk | 1977,00 | 301 | 1 |
| 0954977 | rechts | beuk/wit/wit | 035100RLS40 | stuk | 1977,00 | 301 | 1 |

| Art.nr | Specificaties | Kleur | Lev.nr | Ehd | Prijs | Grp | CC |
|--------|---------------|-------|--------|-----|-------|-----|----|
|--------|---------------|-------|--------|-----|-------|-----|----|

Detremmerie Orphee 2002

meubelset 165cm m. opbouw wastafel m. spiegelkast

| | | | | | | | |
|---------|--|--------------|------------|------|---------|-----|---|
| 0954950 | | beuk/wit/wit | 035165LS40 | stuk | 3279,00 | 301 | 1 |
|---------|--|--------------|------------|------|---------|-----|---|

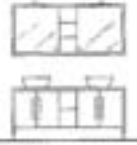

meubelset 70cm m. inbouw wastafel m. spiegelkast

| | | | | | | | |
|---------|-------|--------------|------------|------|---------|-----|---|
| 0954985 | links | beuk/wit/wit | 03570LHS40 | stuk | 1837,00 | 301 | 1 |
|---------|-------|--------------|------------|------|---------|-----|---|

| | | | | | | | |
|---------|--------|--------------|------------|------|---------|-----|---|
| 0954993 | rechts | beuk/wit/wit | 03570RHS40 | stuk | 1837,00 | 301 | 1 |
|---------|--------|--------------|------------|------|---------|-----|---|



meubelset 100cm m. inbouw wastafel m. spiegelkast

| | | | | | | | |
|---------|-------|--------------|-------------|------|---------|-----|---|
| 0954918 | links | beuk/wit/wit | 035100LHS40 | stuk | 1988,00 | 301 | 1 |
|---------|-------|--------------|-------------|------|---------|-----|---|

| | | | | | | | |
|---------|--------|--------------|-------------|------|---------|-----|---|
| 0954926 | rechts | beuk/wit/wit | 035100RHS40 | stuk | 1988,00 | 301 | 1 |
|---------|--------|--------------|-------------|------|---------|-----|---|



meubelset 165cm m. inbouw wastafel m. spiegelkast

| | | | | | | | |
|---------|--|------------|------------|------|---------|-----|---|
| 0954896 | | beuken/wit | 035165HS40 | stuk | 3310,00 | 301 | 1 |
|---------|--|------------|------------|------|---------|-----|---|

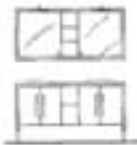

meubelset m. inbouw wastafel m. spiegel op paneel m. deco verlichting

| | | | | | | | |
|---------|-------|------------|------------|------|---------|-----|---|
| 0959553 | 165cm | beuken/wit | 035165HP40 | stuk | 3046,00 | 301 | 1 |
|---------|-------|------------|------------|------|---------|-----|---|

kolomkast

| | | | | | | | | |
|---------|----------|-------|------------|------------------|------|--------|-----|---|
| 0957852 | 160x40cm | links | beuken/wit | 0352211660401020 | stuk | 491,00 | 301 | 1 |
|---------|----------|-------|------------|------------------|------|--------|-----|---|

| | | | | | | | | |
|---------|----------|--------|------------|------------------|------|--------|-----|---|
| 0957860 | 160x40cm | rechts | beuken/wit | 0352211660402020 | stuk | 491,00 | 301 | 1 |
|---------|----------|--------|------------|------------------|------|--------|-----|---|

| | | | | | | | | |
|---------|------------|-------|------------|------------------|------|--------|-----|---|
| 0957879 | 164,5x40cm | links | beuken/wit | 0352211670401020 | stuk | 508,00 | 301 | 1 |
|---------|------------|-------|------------|------------------|------|--------|-----|---|

| | | | | | | | | |
|---------|------------|--------|------------|------------------|------|--------|-----|---|
| 0957587 | 164,5x40cm | rechts | beuken/wit | 0352211670402020 | stuk | 508,00 | 301 | 1 |
|---------|------------|--------|------------|------------------|------|--------|-----|---|

| | | | | | | | | |
|---------|----------|-------|-------------|-----------------|------|--------|-----|---|
| 0957895 | 160x40cm | links | beuken/glas | 035221160040103 | stuk | 712,00 | 301 | 1 |
|---------|----------|-------|-------------|-----------------|------|--------|-----|---|

| | | | | | | | | |
|---------|----------|--------|-------------|-----------------|------|--------|-----|---|
| 0957909 | 160x40cm | rechts | beuken/glas | 035221160040203 | stuk | 712,00 | 301 | 1 |
|---------|----------|--------|-------------|-----------------|------|--------|-----|---|

| | | | | | | | | |
|---------|------------|-------|-------------|-----------------|------|--------|-----|---|
| 0957917 | 164,5x40cm | links | beuken/glas | 035221161040103 | stuk | 728,00 | 301 | 1 |
|---------|------------|-------|-------------|-----------------|------|--------|-----|---|

| | | | | | | | | |
|---------|------------|--------|-------------|-----------------|------|--------|-----|---|
| 0957925 | 164,5x40cm | rechts | beuken/glas | 035221161040203 | stuk | 728,00 | 301 | 1 |
|---------|------------|--------|-------------|-----------------|------|--------|-----|---|



rieten mand

| | | | | | | | |
|---------|------------|--|----------------|------|-------|-----|---|
| 0955019 | 50x25x21cm | | 99982006900002 | stuk | 79,00 | 301 | 1 |
|---------|------------|--|----------------|------|-------|-----|---|



handdoekhouder 49cm

| | | | | | | | |
|---------|--|-----------|----------------|------|-------|-----|---|
| 0955000 | | matchroom | 99984539900001 | stuk | 33,00 | 301 | 1 |
|---------|--|-----------|----------------|------|-------|-----|---|

Detremmerie Quinto 4002

meubelset









| | | | | | | | | |
|---------|------|-------|------------|----------|------|---------|-----|---|
| 0958700 | 75cm | links | kersen/wit | 01075L15 | stuk | 1696,00 | 301 | 1 |
|---------|------|-------|------------|----------|------|---------|-----|---|

| | | | | | | | | |
|---------|------|-------|--------------|----------|------|---------|-----|---|
| 0958727 | 75cm | links | kersen/perg. | 01075L25 | stuk | 1696,00 | 301 | 1 |
|---------|------|-------|--------------|----------|------|---------|-----|---|

| | | | | | | | | |
|---------|------|--------|------------|----------|------|---------|-----|---|
| 0958719 | 75cm | rechts | kersen/wit | 01075R15 | stuk | 1696,00 | 301 | 1 |
|---------|------|--------|------------|----------|------|---------|-----|---|

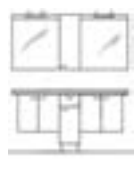
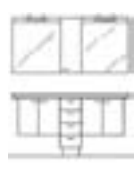
| | | | | | | | | |
|---------|------|--------|--------------|----------|------|---------|-----|---|
| 0958735 | 75cm | rechts | kersen/perg. | 01075R25 | stuk | 1696,00 | 301 | 1 |
|---------|------|--------|--------------|----------|------|---------|-----|---|



| Art.nr | Specificaties | Kleur | Lev.nr | Ehd | Prijs | Grp | CC | | | |
|--|---------------|---------------|-----------------|-----------------|---------|--------|-----|---|---|--------------------------|
| Detremmerie Quinto 4002 | | | | | | | | | | |
| meubelset links m. draaideur | | | | | | | | | | |
| 0958743 | 105cm | kersen/wit | 010105L156 | stuk | 2689,00 | 301 | 1 |  | Sanitair producten | |
| 0958794 | 105cm | kersen/perg. | 010105L256 | stuk | 2689,00 | 301 | 1 | | | |
| 0958778 | 105cm | beuken/wit | 010105L146 | stuk | 2689,00 | 301 | 1 | | | |
| 0958816 | 105cm | beuken/perg. | 010105L246 | stuk | 2689,00 | 301 | 1 | | | |
| 0959561 | 105cm | wit/wit | 010105L111 | stuk | 2689,00 | 301 | 1 | | | |
| 0959588 | 105cm | jasmijn/perg. | 010105L222 | stuk | 2689,00 | 301 | 1 | | | |
| meubelset rechts m. draaideur | | | | | | | | | | |
| 0958751 | 105cm | kersen/wit | 010105R156 | stuk | 2689,00 | 301 | 1 |  | Kranen | |
| 0958808 | 105cm | kersen/perg. | 010105R256 | stuk | 2689,00 | 301 | 1 | | | |
| 0958786 | 105cm | beuken/wit | 010105R146 | stuk | 2689,00 | 301 | 1 | | | |
| 0958824 | 105cm | beuken/perg. | 010105R246 | stuk | 2689,00 | 301 | 1 | | | |
| 0959626 | 105cm | wit/wit | 010105R111 | stuk | 2689,00 | 301 | 1 | | | |
| 0959634 | 105cm | jasmijn/perg. | 010105R222 | stuk | 2689,00 | 301 | 1 | | | |
| meubelset links m. laden | | | | | | | | | | |
| 0958832 | 105cm | kersen/wit | 0101052L156 | stuk | 2953,00 | 301 | 1 |  | Accessoires en spiegels | |
| 0958875 | 105cm | kersen/perg. | 0101052L256 | stuk | 2953,00 | 301 | 1 | | | |
| 0958859 | 105cm | beuken/wit | 0101052L146 | stuk | 2953,00 | 301 | 1 | | | |
| 0958891 | 105cm | beuken/perg. | 0101052L246 | stuk | 2953,00 | 301 | 1 | | | |
| 0959596 | 105cm | wit/wit | 0101052L111 | stuk | 2953,00 | 301 | 1 | | | |
| 0959618 | 105cm | jasmijn/perg. | 0101052L222 | stuk | 2953,00 | 301 | 1 | | | |
| meubelset rechts m. laden | | | | | | | | | | |
| 0958840 | 105cm | kersen/wit | 0101052R156 | stuk | 2953,00 | 301 | 1 |  | Douchewanden | |
| 0958883 | 105cm | kersen/perg. | 0101052R256 | stuk | 2953,00 | 301 | 1 | | | |
| 0958867 | 105cm | beuken/wit | 0101052R146 | stuk | 2953,00 | 301 | 1 | | | |
| 0958905 | 105cm | beuken/perg. | 0101052R246 | stuk | 2953,00 | 301 | 1 | | | |
| 0959642 | 105cm | wit/wit | 0101052R111 | stuk | 2953,00 | 301 | 1 | | | |
| 0959650 | 105cm | jasmijn/perg. | 0101052R222 | stuk | 2953,00 | 301 | 1 | | | |
| meubelset dubbel m. draaideur | | | | | | | | | | |
| 0958913 | 165cm | kersen/wit | 010165156 | stuk | 3721,00 | 301 | 1 |  | Spool- & installatiesystemen | |
| 0958921 | 165cm | kersen/perg. | 010165256 | stuk | 3721,00 | 301 | 1 | | | |
| 0958948 | 165cm | beuken/wit | 010165146 | stuk | 3721,00 | 301 | 1 | | | |
| 0958956 | 165cm | beuken/perg. | 010165246 | stuk | 3721,00 | 301 | 1 | | | |
| 0959669 | 165cm | wit/wit | 010165111 | stuk | 3721,00 | 301 | 1 | | | |
| 0959677 | 165cm | jasmijn/perg. | 010165222 | stuk | 3721,00 | 301 | 1 | | | |
| meubelset dubbel m. laden | | | | | | | | | | |
| 0958964 | 165cm | kersen/wit | 0101652156 | stuk | 3985,00 | 301 | 1 |  | Badkamermeubelen en toiletkasten | |
| 0958972 | 165cm | kersen/perg. | 0101652256 | stuk | 3985,00 | 301 | 1 | | | |
| 0958980 | 165cm | beuken/wit | 0101652146 | stuk | 3985,00 | 301 | 1 | | | |
| 0958999 | 165cm | beuken/perg. | 0101652246 | stuk | 3985,00 | 301 | 1 | | | |
| 0959685 | 165cm | wit/wit | 0101652111 | stuk | 3985,00 | 301 | 1 | | | |
| 0959693 | 165cm | jasmijn/perg. | 0101652222 | stuk | 3985,00 | 301 | 1 | | | |
| halfhoge kast m. poten | | | | | | | | | | |
| 0959006 | 35cm | links | kersen | 01022187103515 | stuk | 436,00 | 301 | 1 |  | Gootstenen en wastroggen |
| 0959014 | 35cm | links | beuken | 01022187103514 | stuk | 436,00 | 301 | 1 | | |
| 0959707 | 35cm | links | wit | 01022187103511 | stuk | 436,00 | 301 | 1 | | |
| 0959715 | 35cm | links | jasmijn | 01022187103512 | stuk | 436,00 | 301 | 1 | | |
| 0959022 | 35cm | rechts | kersen | 01022187103525 | stuk | 436,00 | 301 | 1 | | |
| 0959030 | 35cm | rechts | beuken | 01022187103524 | stuk | 436,00 | 301 | 1 | | |
| 0959758 | 35cm | rechts | wit | 01022187103521 | stuk | 436,00 | 301 | 1 | | |
| 0959766 | 35cm | rechts | jasmijn | 01022187103522 | stuk | 436,00 | 301 | 1 | | |
| halfhoge kast m. poten m. lade | | | | | | | | | | |
| 0959049 | 35cm | links | kersen/metallic | 010221874035156 | stuk | 708,00 | 301 | 1 |  | Utiliteit |
| 0959057 | 35cm | links | beuken/metallic | 010221874035146 | stuk | 708,00 | 301 | 1 | | |
| 0959723 | 35cm | links | wit | 010221871035111 | stuk | 708,00 | 301 | 1 | | |
| 0959731 | 35cm | links | jasmijn | 010221871035122 | stuk | 708,00 | 301 | 1 | | |
| 0959065 | 35cm | rechts | kersen/metallic | 010221874035256 | stuk | 708,00 | 301 | 1 | | |
| 0959073 | 35cm | rechts | beuken/metallic | 010221874035246 | stuk | 708,00 | 301 | 1 | | |
| 0959774 | 35cm | rechts | wit | 010221871035211 | stuk | 708,00 | 301 | 1 | | |
| 0959782 | 35cm | rechts | jasmijn | 010221871035222 | stuk | 708,00 | 301 | 1 | | |
| tablet voor halfhoge kast kunststof | | | | | | | | | | |
| 0959081 | 35cm | | kersen | 0102013170355 | stuk | 131,00 | 301 | 1 |  | |
| 0959103 | 35cm | | beuken | 0102013170354 | stuk | 131,00 | 301 | 1 | | |
| 0959111 | 35cm | | wit | 0102013170351 | stuk | 131,00 | 301 | 1 | | |
| 0959138 | 35cm | | pergamon | 0102013170352 | stuk | 131,00 | 301 | 1 | | |

| | Art.nr | Specificaties | Kleur | Lev.nr | Ehd | Prijs | Grp | CC |
|---|---|---------------------|----------|----------------|------|--------|-----|----|
| Sanitair producten | Detremmerie Quinto 4002 | | | | | | | |
| | tablet voor halfhoge kast marmer | | | | | | | |
| | 0959146 | 35cm | wit | 9994045170351 | stuk | 177,00 | 301 | 1 |
| | 0959154 | 35cm | pergamon | 9994045170352 | stuk | 177,00 | 301 | 1 |
| Baden / douchebakken / stoomcabines | Detremmerie Toebehoren | | | | | | | |
| | 0954749 | handdoekhouder 43cm | chroom | 99925039861000 | stuk | 91,00 | 301 | 1 |
| Kranen | | | | | | | | |
| Douchegarnituur | | | | | | | | |
| Accessoires en spiegels | | | | | | | | |
| Douchewanden | | | | | | | | |
| Toebehoren & afvoeren | | | | | | | | |
| Spoel- & installatiesystemen | | | | | | | | |
| Badkamermeubelen en toiletkasten | | | | | | | | |
| Gootstenen en wastroggen | | | | | | | | |
| Utiliteit | | | | | | | | |

| Art.nr | Specificaties | Kleur | Lev.nr | Ehd | Prijs | Grp | CC |
|-------------------------------|----------------------|--------|----------|------|--------|-----|----|
| Duravit 4x9 | | | | | | | |
| spiegel m. verlichting | | | | | | | |
| 0291363 | 52.9x87.6cm | wit | 968406 | stuk | 498,00 | 304 | 1 |
| 0291365 | 65.6x87.6cm | wit | 968506 | stuk | 528,00 | 304 | 1 |
| 0291366 | 65.6x87.6cm | zilver | 968537 | stuk | 528,00 | 304 | 1 |
| 0291367 | 72.8x87.6cm | wit | 968606 | stuk | 545,00 | 304 | 1 |
| 0291368 | 72.8x87.6cm | zilver | 968637 | stuk | 545,00 | 304 | 1 |
| 0291369 | 52.9x87.6cm m. laden | wit | 96870617 | stuk | 773,00 | 304 | 1 |
| 0291370 | 52.9x87.6cm m. laden | zilver | 96873737 | stuk | 773,00 | 304 | 1 |
| 0291371 | 65.6x87.6cm m. laden | wit | 96880617 | stuk | 791,00 | 304 | 1 |
| 0291372 | 65.6x87.6cm m. laden | zilver | 96883737 | stuk | 791,00 | 304 | 1 |
| 0291373 | 78.3x87.6cm m. laden | wit | 96890617 | stuk | 814,00 | 304 | 1 |
| 0291374 | 78.3x87.6cm m. laden | zilver | 96893737 | stuk | 814,00 | 304 | 1 |

Sanitair producten

Baden /
douchebakken /
stoomcabines

Kranen

Douchegarnituur

Accessoires en
spiegels

Douchewanden

Toebehoren &
afvoeren

Spoel- &
installatiesystemen

Badkamermeubelen
en toiletkasten

Gootstenen en
wastroggen

Utiliteit

| | | | | | | | |
|---|-----------------|--|-------|------|---------|-----|---|
| Duravit Change | | | | | | | |
| spiegel m. verlichting | | | | | | | |
| 0317403 | 70x80cm | | 9600 | stuk | 827,00 | 304 | 1 |
| 0317411 | 100x80cm | | 9602 | stuk | 860,00 | 304 | 1 |
| 0317438 | 120x80cm | | 9603 | stuk | 878,00 | 304 | 1 |
| spiegelkast m. verlichting m. 1 deur | | | | | | | |
| 0290059 | 70x80cm links | | 9610 | stuk | 1081,00 | 304 | 1 |
| 0315502 | 70x80cm rechts | | 9610R | stuk | 1081,00 | 304 | 1 |
| spiegelkast m. verlichting m. 3 deuren | | | | | | | |
| 0290065 | 100x80cm links | | 9612L | stuk | 1370,00 | 304 | 1 |
| 0315503 | 100x80cm rechts | | 9612R | stuk | 1370,00 | 304 | 1 |
| 0290153 | 120x80cm links | | 9613L | stuk | 1442,00 | 304 | 1 |
| 0315504 | 120x80cm rechts | | 9613R | stuk | 1442,00 | 304 | 1 |







| | | | | | | | |
|--------------------------------------|------------|-------|--------|------|--------|-----|---|
| Duravit Fogo | | | | | | | |
| wastafelonderbouw uittrekbaar | | | | | | | |
| 0291375 | 45x44.5cm | noten | 955313 | stuk | 534,00 | 304 | 1 |
| 0291376 | 55x44.5cm | noten | 955413 | stuk | 554,00 | 304 | 1 |
| 0291377 | 75x44.5cm | noten | 955513 | stuk | 648,00 | 304 | 1 |
| 0291378 | 95x44.5cm | noten | 955613 | stuk | 712,00 | 304 | 1 |
| 0291379 | 80x44.5cm | noten | 957213 | stuk | 648,00 | 304 | 1 |
| 0291380 | 100x44.5cm | noten | 957313 | stuk | 712,00 | 304 | 1 |
| 0291381 | 120x44.5cm | noten | 957413 | stuk | 845,00 | 304 | 1 |











| | | | | | | | |
|-------------------------------|---------------------|---------|--------|------|--------|-----|---|
| spiegel m. verlichting | | | | | | | |
| 0290154 | 59.7x79.7cm | esdoorn | 961455 | stuk | 345,00 | 304 | 1 |
| 0290155 | 79.7x79.7cm | esdoorn | 961555 | stuk | 366,00 | 304 | 1 |
| 0290156 | 99.7x79.7cm | esdoorn | 961655 | stuk | 386,00 | 304 | 1 |
| 0290157 | 119.7x79.7cm links | esdoorn | 961755 | stuk | 407,00 | 304 | 1 |
| 0290158 | 119.7x79.7cm midden | esdoorn | 961855 | stuk | 407,00 | 304 | 1 |
| 0290159 | 119.7x79.7cm rechts | esdoorn | 961955 | stuk | 407,00 | 304 | 1 |

| | | | | | | | |
|-----------------------------------|----------------|---------------|-----------|------|--------|-----|---|
| Duravit In the mood | | | | | | | |
| wastafelonderbouw z. poten | | | | | | | |
| 0309524 | 35x35cm links | wit/aluminium | 61353837L | stuk | 426,00 | 304 | 1 |
| 0309532 | 35x35cm rechts | wit/aluminium | 61353837R | stuk | 426,00 | 304 | 1 |
| 0309540 | 70x35cm | wit/aluminium | 61403837 | stuk | 606,00 | 304 | 1 |
| 0309567 | 105x35cm | wit/aluminium | 61453837 | stuk | 677,00 | 304 | 1 |

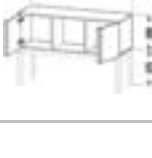

| | Art.nr | Specificaties | Kleur | Lev.nr | Ehd | Prijs | Grp | CC |
|---|---|-----------------|---------------|-----------|------|---------|-----|----|
| Duravit In the mood | | | | | | | | |
| Sanitair producten | hoge kast m. poten | | | | | | | |
| | 0309257 | 35x160cm links | wit/aluminium | 92223837L | stuk | 815,00 | 304 | 1 |
| | 0309265 | 35x160cm rechts | wit/aluminium | 92223837R | stuk | 815,00 | 304 | 1 |
| Baden / douchebakken / stoomcabines |  | | | | | | | |
| Kranen | hoge kast m. wasmand m. poten | | | | | | | |
| | 0309273 | 35x160cm links | wit/aluminium | 92263837L | stuk | 918,00 | 304 | 1 |
| | 0309281 | 35x160cm rechts | wit/aluminium | 92263837R | stuk | 918,00 | 304 | 1 |
| Douchegarnituur |  | | | | | | | |
| Accessoires en spiegels | hoge kast m. lade m. poten | | | | | | | |
| | 0309303 | 35x160cm links | wit/aluminium | 92273837L | stuk | 1187,00 | 304 | 1 |
| | 0309311 | 35x160cm rechts | wit/aluminium | 92273837R | stuk | 1187,00 | 304 | 1 |
| Douchewanden |  | | | | | | | |
| Toebehoren & afvoeren | hoge kast m. poten | | | | | | | |
| | 0309338 | 70x160cm | wit/aluminium | 92293837 | stuk | 1144,00 | 304 | 1 |
| |  | | | | | | | |
| Spoel- & installatiesystemen | hoge kast m. laden m. dubbele deuren | | | | | | | |
| | 0309346 | 70x160cm | wit/aluminium | 92333837 | stuk | 1639,00 | 304 | 1 |
| |  | | | | | | | |
| Badkamermeubelen en toiletkasten | hoge kast m. laden m. dubbele deuren m. verlichting | | | | | | | |
| | 0293214 | 70x160cm | wit/aluminium | 92343738 | stuk | 1759,00 | 304 | 1 |
| Gootstenen en wastroggen |  | | | | | | | |
| Utiliteit | lage kast m. poten m. wasmand | | | | | | | |
| | 0309354 | 35x90cm links | wit/aluminium | 93573837L | stuk | 647,00 | 304 | 1 |
| | 0309362 | 35x90cm rechts | wit/aluminium | 93573837R | stuk | 647,00 | 304 | 1 |
| |  | | | | | | | |
| | lage kast m. poten m. laden m. deur | | | | | | | |
| | 0309370 | 35x90cm links | wit/aluminium | 93583837L | stuk | 906,00 | 304 | 1 |
| | 0309389 | 35x90cm rechts | wit/aluminium | 93583837R | stuk | 906,00 | 304 | 1 |
| |  | | | | | | | |
| | lage kast m. poten m. dubbele deuren | | | | | | | |
| | 0309397 | 70x70cm | wit/aluminium | 93613837 | stuk | 817,00 | 304 | 1 |
| |  | | | | | | | |

| Art.nr | Specificaties | Kleur | Lev.nr | Ehd | Prijs | Grp | CC | | |
|--|---------------|---------------|---------------|-----------|---------|--------|-----|---|---|
| Duravit In the mood | | | | | | | | | |
| lage kast m. poten m. dubbele deuren m. laden | | | | | | | | | |
| 0309400 | 70x70cm | wit/aluminium | 93633837 | stuk | 1160,00 | 304 | 1 |  | |
| trolley m. deur m. lade | | | | | | | | | |
| 0309419 | 35x70cm | links | wit/aluminium | 93663837L | stuk | 649,00 | 304 | 1 |  |
| 0309427 | 35x70cm | rechts | wit/aluminium | 93663837R | stuk | 649,00 | 304 | 1 | |
| trolley m. dubbele deuren m. laden | | | | | | | | | |
| 0309435 | 70x70cm | links | wit/aluminium | 93683837L | stuk | 865,00 | 304 | 1 |  |
| 0309443 | 70x70cm | rechts | wit/aluminium | 93683837R | stuk | 865,00 | 304 | 1 | |
| lage kast m. laden z. poten | | | | | | | | | |
| 0309486 | 70x35cm | wit/aluminium | 93753837 | stuk | 668,00 | 304 | 1 |  | |
| lage kast m. dubbele deuren z. poten | | | | | | | | | |
| 0309494 | 105x35cm | wit/aluminium | 93773837 | stuk | 549,00 | 304 | 1 |  | |
| spiegelkast | | | | | | | | | |
| 0309508 | 70x70cm | aluminium | 97913937 | stuk | 697,00 | 304 | 1 |  | |
| 0309516 | 105x70cm | wit/aluminium | 9792383937 | stuk | 1270,00 | 304 | 1 | | |
| spiegel m. verlichting m. planchet | | | | | | | | | |
| 0309451 | 70x70cm | | 979439 | stuk | 590,00 | 304 | 1 |  | |
| 0309478 | 105x70cm | | 979539 | stuk | 644,00 | 304 | 1 | | |
| | | | | | | | |  | |

Sanitair producten

Baden /
douchebakken /
stoomcabines

Kranen

Douchegarnituur

Accessoires en
spiegels

Douchewanden

Toebehoren &
afvoeren

Spoel- &
installatiesystemen

Badkamermeubelen
en toiletkasten

Gootstenen en
wastroggen

Utiliteit

| | Art.nr | Specificaties | Kleur | Lev.nr | Ehd | Prijs | Grp | CC | |
|---|---|------------------|----------------|----------------|---------------|-----------|--------|--------|-----|
| Sanitair producten | Duravit Multibox | | | | | | | | |
| | spiegelkast m. 2xdeuren m. verlichting | | | | | | | | |
| | 0317446 | 60x66cm | aluminium | 978537 | stuk | 735,00 | 304 | 1 | |
| | 0293205 | 60x66cm | esdoorn | 978534 | stuk | 735,00 | 304 | 1 | |
| Baden / douchebakken / stoomcabines | spiegelkast m. 1xdeur m. verlichting | | | | | | | | |
| | 0317454 | 44.2x66cm | aluminium | 979737 | stuk | 605,00 | 304 | 1 | |
| Kranen | 0305338 | 44.2x66cm | esdoorn | 979734 | stuk | 605,00 | 304 | 1 | |
| | spiegelkast m. 3xdeuren m. verlichting | | | | | | | | |
| Douchegarnituur | 0317462 | 100x66cm | aluminium | 979937 | stuk | 817,00 | 304 | 1 | |
| | 0305339 | 100x66cm | esdoorn | 979934 | stuk | 817,00 | 304 | 1 | |
| Accessoires en spiegels | | | | | | | | | |
| Douchewanden | lijst voor spiegelkast | | | | | | | | |
| | 0317470 | 49.7x71.5cm | aluminium | 980037 | stuk | 128,00 | 304 | 1 | |
| | 0317489 | 71.7x71.5cm | aluminium | 980137 | stuk | 132,00 | 304 | 1 | |
| | 0317497 | 89.7x71.5cm | aluminium | 980237 | stuk | 138,00 | 304 | 1 | |
| | 0317500 | 85.8x71.5cm | aluminium | 980437 | stuk | 136,00 | 304 | 1 | |
| | 0317519 | 105.5x71.5cm | aluminium | 980537 | stuk | 140,00 | 304 | 1 | |
| | 0317527 | 101.3x71.5cm | aluminium | 980637 | stuk | 140,00 | 304 | 1 | |
| Toebehoren & afvoeren | 0317535 | 121.3x71.5cm | aluminium | 980737 | stuk | 144,00 | 304 | 1 | |
| | 0317543 | 141.3x71.5cm | aluminium | 9808 | stuk | 148,00 | 304 | 1 | |
| | rek m. 2x planchets | | | | | | | | |
| Spoel- & installatiesystemen | 0293207 | | esdoorn | 941234 | stuk | 268,00 | 304 | 1 | |
| Badkamermeubelen en toiletkasten | accessoiresstang m. spiegel | | | | | | | | |
| | 0293206 | | chrom | 9975 | stuk | 403,00 | 304 | 1 | |
| Gootstenen en wastroggen | Duravit Starck | | | | | | | | |
| | wastafelonderbouw | | | | | | | | |
| | 0291384 | 65x47.9cm | front=wit/wit | 61080606 | stuk | 404,00 | 304 | 1 | |
| | 0291385 | 65x47.9cm | front=alu./wit | 61081606 | stuk | 404,00 | 304 | 1 | |
| | 0317373 | 80x40.8cm | front=wit/wit | 61300606 | stuk | 340,00 | 304 | 1 | |
| | 0317381 | 80x40.8cm | front=alu./wit | 61300616 | stuk | 340,00 | 304 | 0 | |
| | 0291382 | 120x47.9cm | front=wit/wit | 61070606 | stuk | 685,00 | 304 | 1 | |
| | 0291383 | 120x47.9cm | front=alu./wit | 61071606 | stuk | 685,00 | 304 | 1 | |
| | Utiliteit | hoge kast | | | | | | | |
| | | 0316865 | 40x160cm | links | front=wit/wit | 9236L0606 | stuk | 430,00 | 304 |
| 0316873 | | 40x160cm | links | front=alu./wit | 9236L0616 | stuk | 430,00 | 304 | 1 |
| 0316989 | | 40x160cm | rechts | front=wit/wit | 9236R0606 | stuk | 430,00 | 304 | 1 |
| 0316997 | 40x160cm | rechts | front=alu./wit | 9236R0616 | stuk | 430,00 | 304 | 1 | |
| | hoge kast m. 2xladen | | | | | | | | |
| | 0316881 | 40x160cm | links | front=wit/wit | 9237L0606 | stuk | 589,00 | 304 | 1 |
| | 0316903 | 40x160cm | links | front=alu./wit | 9237L0616 | stuk | 589,00 | 304 | 1 |
| | 0317004 | 40x160cm | rechts | front=wit/wit | 9237R0606 | stuk | 589,00 | 304 | 1 |
| 0317012 | 40x160cm | rechts | front=alu./wit | 9237R0616 | stuk | 589,00 | 304 | 1 | |
| | lage kast | | | | | | | | |
| | 0316962 | 40x44.4cm | links | front=wit/wit | 9333L0606 | stuk | 276,00 | 304 | 1 |
| | 0316970 | 40x44.4cm | links | front=alu./wit | 9333L0616 | stuk | 276,00 | 304 | 1 |
| | 0317063 | 40x44.4cm | rechts | front=wit/wit | 9333R0606 | stuk | 276,00 | 304 | 1 |
| 0317071 | 40x44.4cm | rechts | front=alu./wit | 9333R0616 | stuk | 276,00 | 304 | 1 | |

| Art.nr | Specificaties | Kleur | Lev.nr | Ehd | Prijs | Grp | CC |
|--------|---------------|-------|--------|-----|-------|-----|----|
|--------|---------------|-------|--------|-----|-------|-----|----|

Duravit Starck

halfhoge kast

| | | | | | | | |
|---------|-----------|--------|----------------|-----------|------|--------|-------|
| 0316911 | 40x84.4cm | links | front=wit/wit | 9334L0606 | stuk | 308,00 | 304 1 |
| 0316938 | 40x84.4cm | links | front=alu./wit | 9334L0616 | stuk | 308,00 | 304 1 |
| 0317020 | 40x84.4cm | rechts | front=wit/wit | 9334R0606 | stuk | 308,00 | 304 1 |
| 0317039 | 40x84.4cm | rechts | front=alu./wit | 9334R0616 | stuk | 308,00 | 304 1 |



Sanitair producten

Baden /
douchebakken /
stoomcabines

halfhoge kast m. 2xladen

| | | | | | | | |
|---------|-----------|--------|----------------|-----------|------|--------|-------|
| 0316946 | 40x84.4cm | links | front=wit/wit | 9335L0606 | stuk | 467,00 | 304 1 |
| 0316954 | 40x84.4cm | links | front=alu./wit | 9335L0616 | stuk | 467,00 | 304 1 |
| 0317047 | 40x84.4cm | rechts | front=wit/wit | 9335R0606 | stuk | 467,00 | 304 1 |
| 0317055 | 40x84.4cm | rechts | front=alu./wit | 9335R0616 | stuk | 467,00 | 304 1 |



Kranen

Douchegarnituur

rolwagen

| | | | | | | | |
|---------|-----------|--------|----------------|-----------|------|--------|-------|
| 0317098 | 40x92.9cm | links | front=wit/wit | 9337L0606 | stuk | 334,00 | 304 1 |
| 0317101 | 40x92.9cm | links | front=alu./wit | 9337L0616 | stuk | 334,00 | 304 1 |
| 0317225 | 40x92.9cm | rechts | front=wit/wit | 9337R0606 | stuk | 334,00 | 304 1 |
| 0317233 | 40x92.9cm | rechts | front=alu./wit | 9337R0616 | stuk | 334,00 | 304 1 |



Accessoires en
spiegels

bovenkast

| | | | | | | | |
|---------|---------|--------|----------------|-----------|------|--------|-------|
| 0317128 | 40x40cm | links | front=wit/wit | 9403L0606 | stuk | 222,00 | 304 1 |
| 0317136 | 40x40cm | links | front=alu./wit | 9403L0616 | stuk | 222,00 | 304 1 |
| 0317241 | 40x40cm | rechts | front=wit/wit | 9403R0606 | stuk | 222,00 | 304 1 |
| 0317268 | 40x40cm | rechts | front=alu./wit | 9403R0616 | stuk | 222,00 | 304 1 |
| 0317144 | 40x80cm | links | front=wit/wit | 9404L0606 | stuk | 276,00 | 304 1 |
| 0317152 | 40x80cm | links | front=alu./wit | 9404L0616 | stuk | 276,00 | 304 1 |
| 0317276 | 40x80cm | rechts | front=wit/wit | 9404R0606 | stuk | 276,00 | 304 1 |
| 0317284 | 40x80cm | rechts | front=alu./wit | 9404R0616 | stuk | 276,00 | 304 1 |



Douchewanden

Toebehoren &
afvoeren

spiegel

| | | | | | | | |
|---------|-------------|--|-----------|--------|------|--------|-------|
| 0317330 | 39.7x79.7cm | | rand=wit | 960506 | stuk | 217,00 | 304 1 |
| 0317292 | 39.7x79.7cm | | rand=alu. | 960516 | stuk | 217,00 | 304 1 |
| 0317349 | 78x79.7cm | | rand=wit | 960606 | stuk | 313,00 | 304 1 |
| 0317306 | 78x79.7cm | | rand=alu. | 960616 | stuk | 313,00 | 304 1 |



Spoel- &
installatiesystemen

Badkamermeubelen
en toiletkasten



Gootstenen en
wastroggen

Utiliteit

spiegel m. verlichting

| | | | | | | | |
|---------|-------------|--|-----------|--------|------|--------|-------|
| 0317357 | 39.7x79.7cm | | rand=wit | 960806 | stuk | 387,00 | 304 1 |
| 0317314 | 39.7x79.7cm | | rand=alu. | 960818 | stuk | 387,00 | 304 1 |
| 0317365 | 78x79.7cm | | rand=wit | 960906 | stuk | 504,00 | 304 1 |
| 0317322 | 78x79.7cm | | rand=alu. | 960916 | stuk | 504,00 | 304 0 |



| Art.nr | Specificaties | Kleur | Lev.nr | Ehd | Prijs | Grp | CC |
|--------|---------------|-------|--------|-----|-------|-----|----|
|--------|---------------|-------|--------|-----|-------|-----|----|

Duravit Starck

spiegelkast



| | | | | | | | | |
|---------|---------|--------|---------------|-----------|------|--------|-----|---|
| 0317160 | 40x80cm | links | rand=wit/wit | 9778L0606 | stuk | 594,00 | 304 | 1 |
| 0317179 | 40x80cm | links | rand=alu./wit | 9778L0616 | stuk | 594,00 | 304 | 1 |
| 0317187 | 40x80cm | rechts | rand=wit/wit | 9778R0606 | stuk | 594,00 | 304 | 1 |
| 0317195 | 40x80cm | rechts | rand=alu./wit | 9778R0616 | stuk | 594,00 | 304 | 1 |
| 0317209 | 80x80cm | | rand=wit/wit | 97790606 | stuk | 787,00 | 304 | 1 |
| 0317217 | 80x80cm | | rand=alu./wit | 97790616 | stuk | 787,00 | 304 | 1 |



Sanitair producten

Baden /
douchebakken /
stoomcabines

Kranen

Douchegarnituur



Duravit X-large

rolwagen Economy

| | | | | | | | | |
|---------|------|--------|--------------|-------------|------|--------|-----|---|
| 0291582 | 78cm | links | glanswit | 2700L222220 | stuk | 672,00 | 304 | 1 |
| 0291583 | 78cm | links | eiken | 2700L838320 | stuk | 728,00 | 304 | 1 |
| 0304743 | 78cm | links | helsinkiberk | 2700L303020 | stuk | 565,00 | 304 | 1 |
| 0304727 | 78cm | links | esdoorn | 2700L343420 | stuk | 565,00 | 304 | 1 |
| 0291584 | 78cm | rechts | glanswit | 2700R222220 | stuk | 672,00 | 304 | 1 |
| 0291585 | 78cm | rechts | eiken | 2700R838320 | stuk | 728,00 | 304 | 1 |
| 0291396 | 78cm | rechts | helsinkiberk | 2700R303020 | stuk | 565,00 | 304 | 1 |
| 0291397 | 78cm | rechts | esdoorn | 2700R343420 | stuk | 565,00 | 304 | 1 |

Accessoires en
spiegels

Douchewanden



rolwagen kunststof box

| | | | | | | | | |
|---------|------|--------|--------------|-------------|------|--------|-----|---|
| 0291586 | 78cm | links | glanswit | 2701L222220 | stuk | 853,00 | 304 | 1 |
| 0291587 | 78cm | links | eiken | 2701L838320 | stuk | 924,00 | 304 | 1 |
| 0304735 | 78cm | links | helsinkiberk | 2701L303020 | stuk | 708,00 | 304 | 1 |
| 0304810 | 78cm | links | esdoorn | 2701L343420 | stuk | 708,00 | 304 | 1 |
| 0291588 | 78cm | rechts | glanswit | 2701R222220 | stuk | 853,00 | 304 | 1 |
| 0291589 | 78cm | rechts | eiken | 2701R838320 | stuk | 924,00 | 304 | 1 |
| 0291399 | 78cm | rechts | helsinkiberk | 2701R303020 | stuk | 708,00 | 304 | 1 |
| 0291400 | 78cm | rechts | esdoorn | 2701R343420 | stuk | 708,00 | 304 | 1 |

Toebehoren &
afvoeren

Spoel- &
installatiesystemen

Badkamermeubelen
en toiletkasten

Gootstenen en
wastroggen

Utiliteit

| Art.nr | Specificaties | Kleur | Lev.nr | Ehd | Prijs | Grp | CC |
|--------------------------|----------------------------|------------------|-------------|------|--------|-----|----|
| Duravit X-large | | | | | | | |
| wastafelonderbouw | | | | | | | |
| 0291590 | 60x44x56cm 1 lade | glanswit | 6720222220 | stuk | 658,00 | 304 | 1 |
| 0291575 | 60x44x56cm 1 lade | eiken | 6720838320 | stuk | 712,00 | 304 | 1 |
| 0291387 | 60x44x56cm 1 lade | helsinkiberk | 6720303020 | stuk | 558,00 | 304 | 1 |
| 0291386 | 60x44x56cm 1 lade | esdoorn | 6720343420 | stuk | 558,00 | 304 | 1 |
| 0291576 | 40x44x54.5cm m. 2 laden | glanswit | 6722222220 | stuk | 560,00 | 304 | 1 |
| 0291577 | 40x44x54.5cm m. 2 laden | eiken | 6722838320 | stuk | 607,00 | 304 | 1 |
| 0291389 | 40x44x54.5cm m. 2 laden | helsinkiberk/chr | 6722303020 | stuk | 436,00 | 304 | 1 |
| 0291388 | 40x44x54.5cm m. 2 laden | esdoorn | 6722343420 | stuk | 436,00 | 304 | 1 |
| 0291578 | 45x88x45cm m. poten links | glanswit | 65261222220 | stuk | 498,00 | 304 | 1 |
| 0291579 | 45x88x45cm m. poten links | eiken | 65261838320 | stuk | 498,00 | 304 | 1 |
| 0291391 | 45x88x45cm m. poten links | helsinkiberk | 65261303020 | stuk | 474,00 | 304 | 1 |
| 0293216 | 45x88x45cm m. poten links | esdoorn/chroom | 65261343420 | stuk | 474,00 | 304 | 1 |
| 0291580 | 45x88x45cm m. poten rechts | glanswit | 6526R222220 | stuk | 498,00 | 304 | 1 |
| 0291581 | 45x88x45cm m. poten rechts | eiken | 6526R838320 | stuk | 498,00 | 304 | 1 |
| 0291393 | 45x88x45cm m. poten rechts | helsinkiberk/chr | 6526R303020 | stuk | 474,00 | 304 | 1 |
| 0291394 | 45x88x45cm m. poten rechts | esdoorn/chroom | 6526R343420 | stuk | 474,00 | 304 | 1 |
| 0291415 | 45x45x44.5cm uittrekbaar | helsinkiberk | 6043303020 | stuk | 450,00 | 304 | 1 |
| 0291416 | 45x45x44.5cm uittrekbaar | esdoorn | 6043343420 | stuk | 450,00 | 304 | 1 |
| 0291417 | 45x45x44.5cm uittrekbaar | glanswit | 6043222220 | stuk | 488,00 | 304 | 1 |
| 0291418 | 45x45x44.5cm uittrekbaar | eiken | 6043838320 | stuk | 529,00 | 304 | 1 |
| 0291420 | 45x45x44.5cm uittrekbaar | helsinkiberk | 6044303020 | stuk | 424,00 | 304 | 1 |
| 0291421 | 55x45x44.5cm uittrekbaar | esdoorn | 6044343420 | stuk | 424,00 | 304 | 1 |
| 0291422 | 55x45x44.5cm uittrekbaar | glanswit | 6044222220 | stuk | 509,00 | 304 | 1 |
| 0291423 | 55x45x44.5cm uittrekbaar | eiken | 6044838320 | stuk | 551,00 | 304 | 1 |
| 0291425 | 75x45x44.5cm uittrekbaar | helsinkiberk | 6045303020 | stuk | 492,00 | 304 | 1 |
| 0291426 | 75x45x44.5cm uittrekbaar | esdoorn | 6045343420 | stuk | 492,00 | 304 | 1 |
| 0291427 | 75x45x44.5cm uittrekbaar | glanswit | 6045222220 | stuk | 590,00 | 304 | 1 |
| 0291428 | 75x45x44.5cm uittrekbaar | eiken | 6045838320 | stuk | 640,00 | 304 | 1 |
| 0291430 | 95x45x44.5cm uittrekbaar | helsinkiberk | 6046303020 | stuk | 551,00 | 304 | 1 |
| 0291431 | 95x45x44.5cm uittrekbaar | esdoorn | 6046343420 | stuk | 551,00 | 304 | 1 |
| 0291432 | 95x45x44.5cm uittrekbaar | glanswit | 6046222220 | stuk | 661,00 | 304 | 1 |
| 0291433 | 95x45x44.5cm uittrekbaar | eiken | 6046838320 | stuk | 716,00 | 304 | 1 |
| 0291435 | 80x45x47cm uittrekbaar | helsinkiberk | 6052303020 | stuk | 492,00 | 304 | 1 |
| 0291436 | 80x45x47cm uittrekbaar | esdoorn | 6052343420 | stuk | 492,00 | 304 | 1 |
| 0291437 | 80x45x47cm uittrekbaar | glanswit | 6052222220 | stuk | 590,00 | 304 | 1 |
| 0291438 | 80x45x47cm uittrekbaar | eiken | 6052838320 | stuk | 640,00 | 304 | 1 |
| 0291440 | 100x45x47cm uittrekbaar | helsinkiberk | 6053303020 | stuk | 551,00 | 304 | 1 |
| 0291441 | 100x45x47cm uittrekbaar | esdoorn | 6053343420 | stuk | 551,00 | 304 | 1 |
| 0291442 | 100x45x47cm uittrekbaar | glanswit | 6053222220 | stuk | 661,00 | 304 | 1 |
| 0291443 | 100x45x47cm uittrekbaar | eiken | 6053838320 | stuk | 716,00 | 304 | 1 |
| 0291445 | 120x45x47cm uittrekbaar | helsinkiberk | 6054303020 | stuk | 626,00 | 304 | 1 |
| 0291446 | 120x45x47cm uittrekbaar | esdoorn | 6054343420 | stuk | 626,00 | 304 | 1 |
| 0291447 | 120x45x47cm uittrekbaar | glanswit | 6054222220 | stuk | 751,00 | 304 | 1 |
| 0291448 | 120x45x47cm uittrekbaar | eiken | 6054838320 | stuk | 814,00 | 304 | 1 |
| 0291450 | 120x45x47cm m. 3 deuren | helsinkiberk | 6067303020 | stuk | 630,00 | 304 | 1 |
| 0291451 | 120x45x47cm m. 3 deuren | esdoorn | 6067343420 | stuk | 630,00 | 304 | 1 |
| 0291452 | 120x45x47cm m. 3 deuren | glanswit | 6067222220 | stuk | 756,00 | 304 | 1 |
| 0291453 | 120x45x47cm m. 3 deuren | eiken | 6067838320 | stuk | 819,00 | 304 | 1 |
| 0291455 | 120x66x47cm m. 3 deuren | helsinkiberk | 6068303020 | stuk | 675,00 | 304 | 1 |
| 0291456 | 120x66x47cm m. 3 deuren | esdoorn | 6068343420 | stuk | 675,00 | 304 | 1 |
| 0291457 | 120x66x47cm m. 3 deuren | glanswit | 6068222220 | stuk | 810,00 | 304 | 1 |
| 0291458 | 120x66x47cm m. 3 deuren | eiken | 6068838320 | stuk | 878,00 | 304 | 1 |



Sanitair producten



Baden /
douchebakken /
stoomcabines



Kranen



Douchegarnituur



Accessoires en
spiegels



Douchewanden



Toebehoren &
afvoeren



Spoel- &
installatiesystemen

Badkamermeubelen
en toiletkasten



Gootstenen en
wastroggen

Utiliteit

| | Art.nr | Specificaties | Kleur | Lev.nr | Ehd | Prijs | Grp | CC |
|---|-------------|---------------|------------------------|--------------|-------------|---------|---------|-------|
| Duravit X-large | | | | | | | | |
| hogekast | | | | | | | | |
| Sanitair producten | 0291598 | 176x30x36cm | 2 deuren 1 lade links | glanswit | 1128L222220 | stuk | 856,00 | 304 1 |
| | 0291599 | 176x30x36cm | 2 deuren 1 lade links | eiken | 1128L838320 | stuk | 927,00 | 304 1 |
| | 0291409 | 176x30x36cm | 2 deuren 1 lade links | helsinkiberk | 1128L303020 | stuk | 746,00 | 304 1 |
| Baden / douchebakken / stoomcabines | 0291410 | 176x30x36cm | 2 deuren 1 lade links | esdoorn | 1128L343420 | stuk | 746,00 | 304 1 |
| | 0291600 | 176x30x36cm | 2 deuren 1 lade rechts | glanswit | 1128R222220 | stuk | 856,00 | 304 1 |
| | 0291601 | 176x30x36cm | 2 deuren 1 lade rechts | eiken | 1128R838320 | stuk | 927,00 | 304 1 |
| | 0291412 | 176x30x36cm | 2 deuren 1 lade rechts | helsinkiberk | 1128R303020 | stuk | 746,00 | 304 1 |
| | 0291413 | 176x30x36cm | 2 deuren 1 lade rechts | esdoorn | 1128R343420 | stuk | 746,00 | 304 1 |
| Kranen | 0291510 | 176x30x36cm | 1 deur links | helsinkiberk | 1135L303020 | stuk | 518,00 | 304 1 |
| | 0291511 | 176x30x36cm | 1 deur links | esdoorn | 1135L343420 | stuk | 518,00 | 304 1 |
| | 0291512 | 176x30x36cm | 1 deur links | glanswit | 1135L222220 | stuk | 622,00 | 304 1 |
| | 0291513 | 176x30x36cm | 1 deur links | eiken | 1135L838320 | stuk | 637,00 | 304 1 |
| Douchegarnituur | 0291515 | 176x30x36cm | 1 deur rechts | helsinkiberk | 1135R303020 | stuk | 518,00 | 304 1 |
| | 0291516 | 176x30x36cm | 1 deur rechts | esdoorn | 1135R343420 | stuk | 518,00 | 304 1 |
| | 0291517 | 176x30x36cm | 1 deur rechts | glanswit | 1135R222220 | stuk | 622,00 | 304 1 |
| | 0291518 | 176x30x36cm | 1 deur rechts | eiken | 1135R838320 | stuk | 637,00 | 304 1 |
| | 0291520 | 176x40x36cm | 1 deur links | helsinkiberk | 1136L303020 | stuk | 543,00 | 304 1 |
| Accessoires en spiegels | 0291521 | 176x40x36cm | 1 deur links | esdoorn | 1136L343420 | stuk | 543,00 | 304 1 |
| | 0291522 | 176x40x36cm | 1 deur links | glanswit | 1136L222220 | stuk | 652,00 | 304 1 |
| | 0291523 | 176x40x36cm | 1 deur links | eiken | 1136L838320 | stuk | 706,00 | 304 1 |
| | 0291525 | 176x40x36cm | 1 deur rechts | helsinkiberk | 1136R303020 | stuk | 543,00 | 304 1 |
| Douchewanden | 0291526 | 176x40x36cm | 1 deur rechts | esdoorn | 1136R343420 | stuk | 543,00 | 304 1 |
| | 0291527 | 176x40x36cm | 1 deur rechts | glanswit | 1136R222220 | stuk | 652,00 | 304 1 |
| | 0291528 | 176x40x36cm | 1 deur rechts | eiken | 1136R838320 | stuk | 706,00 | 304 1 |
| | 0291530 | 176x50x36cm | 1 deur links | helsinkiberk | 1137L303020 | stuk | 572,00 | 304 1 |
| | 0291531 | 176x50x36cm | 1 deur links | esdoorn | 1137L343420 | stuk | 572,00 | 304 1 |
| | 0291532 | 176x50x36cm | 1 deur links | glanswit | 1137L222220 | stuk | 686,00 | 304 1 |
| Toebehoren & afvoeren | 0291533 | 176x50x36cm | 1 deur links | eiken | 1137L838320 | stuk | 744,00 | 304 1 |
| | 0291535 | 176x50x36cm | 1 deur rechts | helsinkiberk | 1137R303020 | stuk | 572,00 | 304 1 |
| | 0291536 | 176x50x36cm | 1 deur rechts | esdoorn | 1137R343420 | stuk | 572,00 | 304 1 |
| | 0291537 | 176x50x36cm | 1 deur rechts | glanswit | 1137R222220 | stuk | 686,00 | 304 1 |
| Spoel- & installatiesystemen | 0291538 | 176x50x36cm | 1 deur rechts | eiken | 1137R838320 | stuk | 744,00 | 304 1 |
| | 0291540 | 176x30x36cm | 1 glasdeur links | helsinkiberk | 1139L303020 | stuk | 754,00 | 304 1 |
| | 0291541 | 176x30x36cm | 1 glasdeur links | esdoorn | 1139L343420 | stuk | 754,00 | 304 1 |
| | 0291542 | 176x30x36cm | 1 glasdeur links | glanswit | 1139L222220 | stuk | 905,00 | 304 1 |
| Badkamermeubelen en toiletkasten | 0291543 | 176x30x36cm | 1 glasdeur links | eiken | 1139L838320 | stuk | 980,00 | 304 1 |
| | 0291545 | 176x30x36cm | 1 glasdeur rechts | helsinkiberk | 1139R303020 | stuk | 754,00 | 304 1 |
| | 0291546 | 176x30x36cm | 1 glasdeur rechts | esdoorn | 1139R343420 | stuk | 754,00 | 304 1 |
| | 0291547 | 176x30x36cm | 1 glasdeur rechts | glanswit | 1139R222220 | stuk | 905,00 | 304 1 |
| Gootstenen en wastroggen | 0291548 | 176x30x36cm | 1 glasdeur rechts | eiken | 1139R838320 | stuk | 980,00 | 304 1 |
| | 0291550 | 176x40x36cm | 1 glasdeur links | helsinkiberk | 1140L303020 | stuk | 823,00 | 304 1 |
| | 0291551 | 176x40x36cm | 1 glasdeur links | esdoorn | 1140L343420 | stuk | 823,00 | 304 1 |
| | 0291552 | 176x40x36cm | 1 glasdeur links | glanswit | 1140L222220 | stuk | 988,00 | 304 1 |
| | 0291553 | 176x40x36cm | 1 glasdeur links | eiken | 1140L838320 | stuk | 1070,00 | 304 1 |
| Utiliteit | 0291555 | 176x40x36cm | 1 glasdeur rechts | helsinkiberk | 1140R303020 | stuk | 823,00 | 304 1 |
| | 0291556 | 176x40x36cm | 1 glasdeur rechts | esdoorn | 1140R343420 | stuk | 823,00 | 304 1 |
| | 0291557 | 176x40x36cm | 1 glasdeur rechts | glanswit | 1140R222220 | stuk | 988,00 | 304 1 |
| | 0291558 | 176x40x36cm | 1 glasdeur rechts | eiken | 1140R838320 | stuk | 1070,00 | 304 1 |
| | 0291561 | 176x50x36cm | 1 glasdeur links | helsinkiberk | 1141L303020 | stuk | 891,00 | 304 1 |
| | 0291562 | 176x50x36cm | 1 glasdeur links | esdoorn | 1141L343420 | stuk | 891,00 | 304 1 |
| | 0291563 | 176x50x36cm | 1 glasdeur links | glanswit | 1141L222220 | stuk | 1069,00 | 304 1 |
| | 0291564 | 176x50x36cm | 1 glasdeur links | eiken | 1141L838320 | stuk | 1158,00 | 304 1 |
| | 0291567 | 176x50x36cm | 1 glasdeur rechts | esdoorn | 1141R343420 | stuk | 891,00 | 304 1 |
| | 0291568 | 176x50x36cm | 1 glasdeur rechts | glanswit | 1141R222220 | stuk | 1069,00 | 304 1 |
| | 0291569 | 176x50x36cm | 1 glasdeur rechts | eiken | 1141R838320 | stuk | 1158,00 | 304 1 |
| | 0291571 | 176x60x36cm | 2 glasdeuren | helsinkiberk | 1142303020 | stuk | 1030,00 | 304 1 |
| | 0291572 | 176x60x36cm | 2 glasdeuren | esdoorn | 1142343420 | stuk | 1030,00 | 304 1 |
| | 0291573 | 176x60x36cm | 2 glasdeuren | glanswit | 1142222220 | stuk | 1236,00 | 304 1 |
| 0291574 | 176x60x36cm | 2 glasdeuren | eiken | 1142838320 | stuk | 1339,00 | 304 1 | |

| Art.nr | Specificaties | Kleur | Lev.nr | Ehd | Prijs | Grp | CC |
|----------------------------|-------------------------|--------------|--------|------|--------|-----|----|
| Duravit X-large | | | | | | | |
| spiegel m. planchet | | | | | | | |
| 0291460 | 46x80cm | helsinkiberk | 773030 | stuk | 255,00 | 304 | 1 |
| 0291461 | 46x80cm | esdoorn | 773034 | stuk | 255,00 | 304 | 1 |
| 0291462 | 46x80cm | glanswit | 773022 | stuk | 306,00 | 304 | 1 |
| 0291468 | 60x80cm | eiken | 773183 | stuk | 351,00 | 304 | 1 |
| 0291465 | 60x80cm | helsinkiberk | 773130 | stuk | 270,00 | 304 | 1 |
| 0291466 | 60x80cm | esdoorn | 773134 | stuk | 270,00 | 304 | 1 |
| 0291467 | 60x80cm | glanswit | 773122 | stuk | 324,00 | 304 | 1 |
| 0291470 | 80x80cm | helsinkiberk | 773230 | stuk | 280,00 | 304 | 1 |
| 0291471 | 80x80cm | esdoorn | 773234 | stuk | 280,00 | 304 | 1 |
| 0291472 | 80x80cm | glanswit | 773222 | stuk | 336,00 | 304 | 1 |
| 0291473 | 80x80cm | eiken | 773283 | stuk | 364,00 | 304 | 1 |
| 0291475 | 100x80cm | helsinkiberk | 773330 | stuk | 297,00 | 304 | 1 |
| 0291476 | 100x80cm | esdoorn | 773334 | stuk | 297,00 | 304 | 1 |
| 0291477 | 100x80cm | glanswit | 773322 | stuk | 356,00 | 304 | 1 |
| 0291478 | 100x80cm | eiken | 773383 | stuk | 386,00 | 304 | 1 |
| 0291480 | 120x80cm | helsinkiberk | 773430 | stuk | 314,00 | 304 | 1 |
| 0291481 | 120x80cm | esdoorn | 773434 | stuk | 314,00 | 304 | 1 |
| 0291482 | 120x80cm | glanswit | 773422 | stuk | 377,00 | 304 | 1 |
| 0291483 | 120x80cm | eiken | 773483 | stuk | 408,00 | 304 | 1 |
| 0291485 | 46x80cm m. verlichting | helsinkiberk | 721030 | stuk | 613,00 | 304 | 1 |
| 0291486 | 46x80cm m. verlichting | esdoorn | 721034 | stuk | 613,00 | 304 | 1 |
| 0291487 | 46x80cm m. verlichting | glanswit | 721022 | stuk | 736,00 | 304 | 1 |
| 0291488 | 46x80cm m. verlichting | eiken | 721083 | stuk | 797,00 | 304 | 1 |
| 0291490 | 60x80cm m. verlichting | helsinkiberk | 721130 | stuk | 630,00 | 304 | 1 |
| 0291491 | 60x80cm m. verlichting | esdoorn | 721134 | stuk | 630,00 | 304 | 1 |
| 0291492 | 60x80cm m. verlichting | glanswit | 721122 | stuk | 756,00 | 304 | 1 |
| 0291493 | 60x80cm m. verlichting | eiken | 721183 | stuk | 819,00 | 304 | 1 |
| 0291495 | 80x80cm m. verlichting | helsinkiberk | 721230 | stuk | 670,00 | 304 | 1 |
| 0291496 | 80x80cm m. verlichting | esdoorn | 721234 | stuk | 670,00 | 304 | 1 |
| 0291497 | 80x80cm m. verlichting | glanswit | 721222 | stuk | 804,00 | 304 | 1 |
| 0291498 | 80x80cm m. verlichting | eiken | 721283 | stuk | 871,00 | 304 | 1 |
| 0291500 | 100x80cm m. verlichting | helsinkiberk | 721330 | stuk | 693,00 | 304 | 1 |
| 0291501 | 100x80cm m. verlichting | esdoorn | 721334 | stuk | 693,00 | 304 | 1 |
| 0291502 | 100x80cm m. verlichting | glanswit | 721322 | stuk | 832,00 | 304 | 1 |
| 0291503 | 100x80cm m. verlichting | eiken | 721383 | stuk | 901,00 | 304 | 1 |
| 0291505 | 120x80cm m. verlichting | helsinkiberk | 721430 | stuk | 730,00 | 304 | 1 |
| 0291506 | 120x80cm m. verlichting | esdoorn | 721434 | stuk | 730,00 | 304 | 1 |
| 0291507 | 120x80cm m. verlichting | glanswit | 721422 | stuk | 876,00 | 304 | 1 |
| 0291508 | 120x80cm m. verlichting | eiken | 721483 | stuk | 949,00 | 304 | 1 |

Sanitair producten

Baden /
douchebakken /
stoomcabines

Kranen

Douchegarnituur

Accessoires en
spiegels

Douchewanden

Toebehoren &
afvoerenSpoel- &
installatiesystemenBadkamermeubelen
en toiletkastenGootstenen en
wastroggen

Utiliteit

INNOVATIE DOOR INTEGRATIE



emco ΔSIS

| Art.nr | Specificaties | Kleur | Lev.nr | Ehd | Prijs | Grp | CC |
|--------|---------------|-------|--------|-----|-------|-----|----|
|--------|---------------|-------|--------|-----|-------|-----|----|

Emco Asis

spiegelkast m. verlichting

| | | | | | | | |
|---------|-------------|----------|-----------|------|---------|-----|---|
| 0631818 | 50cm links | alu/glas | 979705000 | stuk | 1021,00 | 323 | 1 |
| 0631819 | 50cm rechts | alu/glas | 979705010 | stuk | 1021,00 | 323 | 1 |



Sanitair producten

Baden /
douchebakken /
stoomcabines

Kranen

spiegelkast m. dubbele verlichting

| | | | | | | | |
|---------|-------|----------|-----------|------|---------|-----|---|
| 0631822 | 80cm | alu/glas | 979705020 | stuk | 1391,00 | 323 | 1 |
| 0631823 | 100cm | alu/glas | 979705030 | stuk | 1682,00 | 323 | 1 |
| 0631824 | 120cm | alu/glas | 979705040 | stuk | 1916,00 | 323 | 1 |



Douchegarnituur

Accessoires en
spiegels

Douchewanden

toiletmodule opbouw

| | | | | | | | |
|---------|------------------------|----------|-----------|------|--------|-----|---|
| 0630242 | 78.7x16.8x15.6 | alu/glas | 975127350 | stuk | 661,00 | 323 | 1 |
| 0630244 | 94.2x16.8x15.3 z. slot | alu/glas | 976127364 | stuk | 796,00 | 323 | 1 |
| 0630246 | 94.2x16.8x15.3 m. slot | alu/glas | 976127360 | stuk | 796,00 | 323 | 1 |
| 0630248 | 94.2x16.8x15.6 z. slot | alu/glas | 976127365 | stuk | 759,00 | 323 | 1 |
| 0630250 | 94.2x16.8x15.6 m. slot | alu/glas | 976127361 | stuk | 759,00 | 323 | 1 |



Toebehoren &
afvoeren

Spoel- &
installatiesystemen

Badkamermeubelen
en toiletkasten

Gootstenen en
wastroggen

Utiliteit

toiletmodule m. verlichting opbouw

| | | | | | | | |
|---------|-------------------------|----------|-----------|------|---------|-----|---|
| 0630252 | 156.2x16.8x15.6 z. slot | alu/glas | 971127314 | stuk | 1226,00 | 323 | 1 |
| 0630254 | 156.2x16.8x15.6 m. slot | alu/glas | 971127310 | stuk | 1226,00 | 323 | 1 |



toiletmodule m. verlichting m. sensor opbouw

| | | | | | | | |
|---------|-------------------------|----------|-----------|------|---------|-----|---|
| 0630273 | 156.2x16.8x15.6 z. slot | alu/glas | 971127315 | stuk | 1335,00 | 323 | 1 |
| 0630275 | 156.2x16.8x15.6 m. slot | alu/glas | 971127312 | stuk | 1335,00 | 323 | 1 |

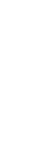

| | Art.nr | Specificaties | Kleur | Lev.nr | Ehd | Prijs | Grp | CC |
|---|---|-------------------------|----------|-----------|------|---------|-----|----|
| | Emco Asis | | | | | | | |
| | wastafelmodule opbouw | | | | | | | |
| Sanitair producten | 0630256 | 78.7x16.8x15.6 z. slot | alu/glas | 975127352 | stuk | 683,00 | 323 | 1 |
| | 0630258 | 78.7x16.8x15.6 m. slot | alu/glas | 975127351 | stuk | 683,00 | 323 | 1 |
| Baden / douchebakken / stoomcabines | 0630260 | 94.2x16.8x15.6 z. slot | alu/glas | 976127366 | stuk | 809,00 | 323 | 1 |
| | 0630262 | 94.2x16.8x15.6 m. slot | alu/glas | 976127362 | stuk | 809,00 | 323 | 1 |
| | 0630264 | 94.2x16.8x15.6 z. slot | alu/glas | 976127367 | stuk | 797,00 | 323 | 1 |
| | 0630266 | 94.2x16.8x15.6 m. slot | alu/glas | 976127363 | stuk | 797,00 | 323 | 1 |
| Kranen | | | | | | | | |
| Douchegarnituur | | | | | | | | |
| Accessoires en spiegels | | | | | | | | |
| | wastafelmodule m. verlichting opbouw | | | | | | | |
| Douchewanden | 0630269 | 156.2x16.8x15.6 z. slot | alu/glas | 971127316 | stuk | 1312,00 | 323 | 1 |
| | 0630271 | 156.2x16.8x15.6 m. slot | alu/glas | 971127311 | stuk | 1312,00 | 323 | 1 |
| Toebehoren & afvoeren | | | | | | | | |
| | wastafelmodule m. verlichting m. sensor opbouw | | | | | | | |
| Spoel- & installatiesystemen | 0630286 | 156.2x16.8x15.6 z. slot | alu/glas | 971127317 | stuk | 1421,00 | 323 | 1 |
| | 0630288 | 156.2x16.8x15.6 m. slot | alu/glas | 971127313 | stuk | 1421,00 | 323 | 1 |
| Badkamermeubelen en toiletkasten | | | | | | | | |
| Gootstenen en wastroggen | | | | | | | | |
| Utiliteit | | | | | | | | |

| Art.nr | Specificaties | Kleur | Lev.nr | Ehd | Prijs | Grp | CC |
|--------|---------------|-------|--------|-----|-------|-----|----|
|--------|---------------|-------|--------|-----|-------|-----|----|

Inda Alessi

hoge kast 170cm m. spiegel

| | | | | | | | |
|---------|-------------|--------|------|-----------|------|---------|-------|
| 0084082 | 37.5x16.5cm | rechts | hout | M5320A XQ | stuk | 1217,00 | 235 1 |
| 0084083 | 37.5x16.5cm | links | hout | M5320B XQ | stuk | 1217,00 | 235 1 |
| 0084084 | 37.5x35cm | rechts | hout | M5320DXQ | stuk | 1583,00 | 235 1 |
| 0084086 | 37.5x35cm | links | hout | M5320E XQ | stuk | 1583,00 | 235 1 |



Sanitair producten

Baden /
douchebakken /
stoomcabines

Kranen

**hoge kast m. spiegel uitschuifbaar**

| | | | | | | | |
|---------|----------|--|------|-----------|------|---------|-------|
| 0084081 | 195x57cm | | hout | M53280 XQ | stuk | 2800,00 | 235 1 |
|---------|----------|--|------|-----------|------|---------|-------|



Douchegarnituur

Accessoires en
spiegels**onderkast hangend 1xlade**

| | | | | | | | |
|---------|-----------|--|------|-----------|------|--------|-------|
| 0084072 | 37.5x35cm | | hout | M5334A XQ | stuk | 536,00 | 235 1 |
| 0084074 | 75x35cm | | hout | M5334C XQ | stuk | 609,00 | 235 1 |



Douchewanden

onderkast hangend 2xladen

| | | | | | | | |
|---------|-----------|--|------|-----------|------|---------|-------|
| 0084076 | 37.5x35cm | | hout | M5334E XQ | stuk | 914,00 | 235 1 |
| 0084079 | 75x35cm | | hout | M5334G XQ | stuk | 1035,00 | 235 1 |

Toebehoren &
afvoeren**onderkast hangend 1xlade**

| | | | | | | | |
|---------|-----------|--|------|-----------|------|--------|-------|
| 0084073 | 37.5x57cm | | hout | M5334H XQ | stuk | 609,00 | 235 1 |
| 0084075 | 75x57cm | | hout | M5334L XQ | stuk | 682,00 | 235 1 |

Spoel- &
installatiesystemen**onderkast hangend 2xladen**

| | | | | | | | |
|---------|-----------|--|------|-----------|------|---------|-------|
| 0084078 | 37.5x57cm | | hout | M5334N XQ | stuk | 1035,00 | 235 1 |
| 0084080 | 75x57cm | | hout | M5334P XQ | stuk | 1205,00 | 235 1 |

Gootstenen en
wastroggen**spiegelkast uitschuifbaar**

| | | | | | | | |
|---------|---------|--------|------|-----------|------|---------|-------|
| 0084091 | 65x65cm | rechts | hout | M5353A XQ | stuk | 1339,00 | 235 1 |
| 0084092 | 65x65cm | links | hout | M5353B XQ | stuk | 1339,00 | 235 1 |



Utiliteit

spiegelkast m. spiegeldeur

| | | | | | | | |
|---------|---------|--------|--|-----------|------|--------|-------|
| 0084094 | 65x65cm | rechts | | M5354A XQ | stuk | 730,00 | 235 1 |
| 0084095 | 65x65cm | links | | M5354B XQ | stuk | 730,00 | 235 1 |

**wastafelmeubel 1xladen**

| | | | | | | | |
|---------|--|--|------|-----------|------|--------|-------|
| 0084113 | | | hout | M5364A XQ | stuk | 816,00 | 235 1 |
|---------|--|--|------|-----------|------|--------|-------|



| | Art.nr | Specificaties | Kleur | Lev.nr | Ehd | Prijs | Grp | CC |
|---|---|----------------|-------------|-----------|------|---------|-----|----|
| Sanitair producten | Inda Alessi | | | | | | | |
| | wastafelmeubel 2xladen | | | | | | | |
| | 0084114 | | hout | M5364B XQ | stuk | 1400,00 | 235 | 1 |
| Baden / douchebakken / stoomcabines | wastafelblad m. uitsparing | | | | | | | |
| | 0084057 | 75.4cm | corian | M5386AQF | stuk | 730,00 | 235 | 1 |
| Kranen | 0084058 | 75.4cm | kunstmarmer | M5386AQA | stuk | 548,00 | 235 | 1 |
| | 0084063 | 112.9cm rechts | corian | M5386CQF | stuk | 1096,00 | 235 | 1 |
| | 0084064 | 112.9cm rechts | kunstmarmer | M5386CQA | stuk | 780,00 | 235 | 1 |
| | 0084061 | 112.9cm links | corian | M5386DQF | stuk | 1096,00 | 235 | 1 |
| | 0084062 | 112.9cm links | kunstmarmer | M5386DQA | stuk | 780,00 | 235 | 1 |
| Douchegarnituur | 0084059 | 150.4cm | corian | M5386EQF | stuk | 1339,00 | 235 | 1 |
| | 0084060 | 150.4cm | kunstmarmer | M5386EQA | stuk | 926,00 | 235 | 1 |
| | 0084067 | 150.4cm rechts | corian | M5386FQF | stuk | 1339,00 | 235 | 1 |
| | 0084068 | 150.4cm rechts | kunstmarmer | M5386FQA | stuk | 926,00 | 235 | 1 |
| Accessoires en spiegels | 0084065 | 150.4cm links | corian | M5386GQF | stuk | 1339,00 | 235 | 1 |
| | 0084066 | 150.4cm links | kunstmarmer | M5386GQA | stuk | 926,00 | 235 | 1 |
| Douchewanden | wastafelblad m. dubbele uitsparing | | | | | | | |
| | 0084070 | 150.4cm | corian | M5386HQF | stuk | 1522,00 | 235 | 1 |
| | 0084071 | 150.4cm | kunstmarmer | M5386HQA | stuk | 1023,00 | 235 | 1 |
| Toebehoren & afvoeren | | | | | | | | |
| Spoel- & installatiesystemen | | | | | | | | |
| Badkamermeubelen en toiletkasten | | | | | | | | |
| Gootstenen en wastroggen | | | | | | | | |
| Utiliteit | | | | | | | | |

| Art.nr | Specificaties | Kleur | Lev.nr | Ehd | Prijs | Grp | CC |
|-----------------------------------|---------------|----------|---------|------|--------|-----|----|
| Plieger Liberty | | | | | | | |
| onderbouwkast 40cm | | | | | | | |
| 0957208 | links | wit/inox | 0957208 | stuk | 228,00 | 394 | 0 |
| 0958670 | rechts | wit/inox | 0958670 | stuk | 228,00 | 394 | 0 |
| kolomkast 177x40cm | | | | | | | |
| 0957186 | links | wit/inox | 0957186 | stuk | 442,00 | 394 | 0 |
| 0957240 | rechts | wit/inox | 0957240 | stuk | 442,00 | 394 | 0 |
| trolley 40cm | | | | | | | |
| 0957194 | links | wit/inox | 0957194 | stuk | 299,00 | 394 | 0 |
| trolley 40cm | | | | | | | |
| 0958662 | rechts | wit/inox | 0958662 | stuk | 299,00 | 394 | 0 |
| Plieger Ron_D | | | | | | | |
| wastafelblad | | | | | | | |
| 0958801 | 100cm | wit | 0958801 | stuk | 350,00 | 296 | 0 |
| wastafelonderbouw | | | | | | | |
| 0958802 | 100cm | wit | 0958802 | stuk | 650,00 | 296 | 0 |
| spiegel en verlichting | | | | | | | |
| 0958803 | 100cm | wit | 0958803 | stuk | 450,00 | 296 | 0 |
| planchet | | | | | | | |
| 0958804 | 100cm | wit | 0958804 | stuk | 85,00 | 296 | 0 |
| spiegelkast m. verlichting | | | | | | | |
| 0958805 | 100cm | wit | 0958805 | stuk | 840,00 | 296 | 0 |
| hogekast m. 1 deur | | | | | | | |
| 0958806 | | wit | 0958806 | stuk | 475,00 | 296 | 0 |



Sanitair producten

Baden /
douchebakken /
stoomcabines

Kranen

Douchegarnituur

Accessoires en
spiegels

Douchewanden

Toebehoren &
afvoerenSpoel- &
installatiesystemenBadkamermeubelen
en toiletkastenGootstenen en
wastroggen

Utiliteit



Trend_TrendDuo



| Art.nr | Specificaties | Kleur | Lev.nr | Ehd | Prijs | Grp | CC |
|---|---------------------------------|-------|---------|------|---------|-----|----|
| Plieger Trend | | | | | | | |
| meubelset m. spiegel m. verlichting | | | | | | | |
| 0957750 | 60cm | wit | 0957750 | stuk | 672,00 | 296 | 0 |
| meubelset dubbel m. spiegel m. verlichting | | | | | | | |
| 0957755 | 120cm | wit | 0957755 | stuk | 1200,00 | 296 | 0 |
| meubelset m. spiegelkast m. verlichting | | | | | | | |
| 0957760 | 60cm | wit | 0957760 | stuk | 753,00 | 296 | 0 |
| meubelset dubbel m. spiegelkast m. verlichting | | | | | | | |
| 0957765 | 120cm | wit | 0957765 | stuk | 1464,00 | 296 | 0 |
| spiegelkast m. verlichting 60cm | | | | | | | |
| 0957733 | | | 0957733 | stuk | 266,00 | 296 | 0 |
| Plieger Trend onderdelen | | | | | | | |
| 0957727 | losse deur links wit | | 0957727 | stuk | 32,50 | 296 | 1 |
| 0957728 | losse deur rechts wit | | 0957728 | stuk | 32,50 | 296 | 1 |
| 0957720 | losse greep chroom | | 0957720 | stuk | 8,00 | 296 | 1 |
| 0957721 | scharnier voor meubelset chroom | | 0957721 | stuk | 1,96 | 296 | 1 |
| 0957722 | verlichting los voor 60cm | | 0957722 | stuk | 101,00 | 296 | 0 |
| 0957723 | verlichting los voor 120cm | | 0957723 | stuk | 131,00 | 296 | 0 |
| 0957724 | trafo los voor meubelset | | 0957724 | stuk | 40,25 | 296 | 1 |
| 0957725 | plankdrager los voor meubelset | | 0957725 | stuk | 0,11 | 296 | 1 |
| 0957735 | wastafelblad 60cm wit | | 0957735 | stuk | 189,00 | 296 | 0 |
| 0957736 | wastafelblad 120cm wit | | 0957736 | stuk | 336,00 | 296 | 0 |
| 0957737 | wastafelonderbouw 60cm wit | | 0957737 | stuk | 298,00 | 296 | 0 |
| 0957739 | spiegelpaneel 60cm wit | | 0957739 | stuk | 85,00 | 296 | 0 |
| 0957738 | spiegelpaneel 120cm wit | | 0957738 | stuk | 138,00 | 296 | 0 |



Sanitair producten

Baden /
douchebakken /
stoomcabines

Kranen

Douchegarnituur

Accessoires en
spiegels

Douchewanden

Toebehoren &
afvoeren

Spoel- &
installatiesystemen

Badkamermeubelen
en toiletkasten

Gootstenen en
wastroggen

Utiliteit

| | Art.nr | Specificaties | Kleur | Lev.nr | Ehd | Prijs | Grp | CC | |
|---|---------------------------------|---------------|------------|-----------------|-------------------|---------|---------|-----|---|
| Sanitair producten | Riho Bologna | | | | | | | | |
| | meubelset m. spiegel | | | | | | | | |
| | 0310149 | 60cm | wit/wit | B0060K00K00S01 | stuk | 1579,00 | 308 | 1 | |
| | 0310150 | 60cm | perg/wit | B0060K01K01S01 | stuk | 1579,00 | 308 | 1 | |
| Baden / douchebakken / stoomcabines | 0310151 | 60cm | berken/wit | B0060DBEDBES01 | stuk | 1579,00 | 308 | 1 | |
| | 0310152 | 60cm | noten/wit | B0060DNC DNCS01 | stuk | 1579,00 | 308 | 1 | |
| Kranen | meubelset m. spiegelkast | | | | | | | | |
| | 0310153 | 60cm | links | wit/wit | B0060K00K00S02L | stuk | 1640,00 | 308 | 1 |
| | 0310154 | 60cm | links | perg/wit | B0060K01K01S02L | stuk | 1640,00 | 308 | 1 |
| | 0310155 | 60cm | links | berken/wit | B0060DBEDBES02L | stuk | 1640,00 | 308 | 1 |
| | 0310156 | 60cm | links | noten/wit | B0060DNC DNCS02L | stuk | 1640,00 | 308 | 1 |
| | 0310157 | 60cm | rechts | wit/wit | B0060K00K00S02R | stuk | 1640,00 | 308 | 1 |
| | 0310158 | 60cm | rechts | perg/wit | B0060K01K01S02R | stuk | 1640,00 | 308 | 1 |
| Douchegarnituur | 0310159 | 60cm | rechts | berken/wit | B0060DBEDBES02R | stuk | 1640,00 | 308 | 1 |
| | 0310160 | 60cm | rechts | noten/wit | B0060DNC DNCS02R | stuk | 1640,00 | 308 | 1 |
| | meubelset m. spiegel | | | | | | | | |
| Accessoires en spiegels | 0310161 | 100cm | wit/wit | B0100K00K00S03 | stuk | 2021,00 | 308 | 1 | |
| | 0310178 | 100cm | perg/wit | B0100K01K01S03 | stuk | 2021,00 | 308 | 1 | |
| | 0310179 | 100cm | berken/wit | B0100DBEDBES03 | stuk | 2021,00 | 308 | 1 | |
| | 0310180 | 100cm | noten/wit | B0100DNC DNCS03 | stuk | 2021,00 | 308 | 1 | |
| Douchewanden | meubelset m. spiegelkast | | | | | | | | |
| | 0310181 | 100cm | wit/wit | B0100K00K00S04 | stuk | 2196,00 | 308 | 1 | |
| | 0310182 | 100cm | perg/wit | B0100K01K01S04 | stuk | 2196,00 | 308 | 1 | |
| | 0310183 | 100cm | berken/wit | B0100DBEDBES04 | stuk | 2196,00 | 308 | 1 | |
| Toebehoren & afvoeren | 0310184 | 100cm | noten/wit | B0100DNC DNCS04 | stuk | 2196,00 | 308 | 1 | |
| | 0310185 | 120cm | wit/wit | B0120K00K00S08 | stuk | 2482,00 | 308 | 1 | |
| | 0310186 | 120cm | perg/wit | B0120K01K01S08 | stuk | 2482,00 | 308 | 1 | |
| | 0310187 | 120cm | berken/wit | B0120DBEDBES08 | stuk | 2482,00 | 308 | 1 | |
| Spoel- & installatiesystemen | 0310188 | 120cm | noten/wit | B0120DNC DNCS08 | stuk | 2482,00 | 308 | 1 | |
| | meubelset m. spiegel | | | | | | | | |
| Badkamermeubelen en toiletkasten | 0310189 | 120cm | wit/wit | B0120K00K00S09 | stuk | 2301,00 | 308 | 1 | |
| | 0310190 | 120cm | perg/wit | B0120K01K01S09 | stuk | 2301,00 | 308 | 1 | |
| | 0310191 | 120cm | berken/wit | B0120DBEDBES09 | stuk | 2301,00 | 308 | 1 | |
| | 0310192 | 120cm | noten/wit | B0120DNC DNCS09 | stuk | 2301,00 | 308 | 1 | |
| Gootstenen en wastroggen | Riho Doppio | | | | | | | | |
| | meubelset m. spiegel | | | | | | | | |
| Utiliteit | 0310344 | 80cm | links | wit/wit | D0080K00K0001S01L | stuk | 1499,00 | 308 | 1 |
| | 0310345 | 80cm | links | perg/wit | D0080K01K0101S01L | stuk | 1499,00 | 308 | 1 |
| | 0310346 | 80cm | links | cremona/wit | D0080DECDEC01S01L | stuk | 1499,00 | 308 | 1 |
| | 0310347 | 80cm | links | chateau/wit | D0080DCADCA01S01L | stuk | 1499,00 | 308 | 1 |
| | 0310224 | 80cm | links | alu/alu | D0080ALUALUS01L | stuk | 1495,00 | 308 | 1 |
| | 0310348 | 80cm | rechts | wit/wit | D0080K00K0002S01R | stuk | 1499,00 | 308 | 1 |
| | 0310349 | 80cm | rechts | perg/wit | D0080K01K0102S01R | stuk | 1499,00 | 308 | 1 |
| | 0310350 | 80cm | rechts | cremona/wit | D0080DECDEC02S01R | stuk | 1499,00 | 308 | 1 |
| | 0310351 | 80cm | rechts | chateau/wit | D0080DCADCA02S01R | stuk | 1499,00 | 308 | 1 |
| | 0310313 | 80cm | rechts | alu/alu | D0080ALUALUS01R | stuk | 1495,00 | 308 | 1 |

| Art.nr | Specificaties | Kleur | Lev.nr | Ehd | Prijs | Grp | CC |
|--------|---------------|-------|--------|-----|-------|-----|----|
|--------|---------------|-------|--------|-----|-------|-----|----|

Riho Doppio

meubelset m. spiegel m. halfhoge kast

| | | | | | | | |
|---------|-------------------|-------------|-------------------|------|---------|-----|---|
| 0310352 | 80cm+50cm links | wit/wit | D0080K00K0001S02L | stuk | 2051,00 | 308 | 1 |
| 0310353 | 80cm+50cm links | perg/wit | D0080K01K0101S02L | stuk | 2051,00 | 308 | 1 |
| 0310354 | 80cm+50cm links | cremona/wit | D0080DECDEC01S02L | stuk | 2051,00 | 308 | 1 |
| 0310355 | 80cm+50cm links | chateau/wit | D0080DCADCA01S02L | stuk | 2051,00 | 308 | 1 |
| 0310315 | 80cm +50cm links | alu/alu | D0080ALUALUS02L | stuk | 2045,00 | 308 | 1 |
| 0310356 | 80cm+50cm rechts | wit/wit | D0080K00K0002S02R | stuk | 2051,00 | 308 | 1 |
| 0310357 | 80cm+50cm rechts | perg/wit | D0080K01K0102S02R | stuk | 2051,00 | 308 | 1 |
| 0310358 | 80cm+50cm rechts | cremona/wit | D0080DECDEC02S02R | stuk | 2051,00 | 308 | 1 |
| 0310359 | 80cm+50cm rechts | chateau/wit | D0080DCADCA02S02R | stuk | 2051,00 | 308 | 1 |
| 0310317 | 80cm +50cm rechts | alu/alu | D0080ALUALUS02R | stuk | 2045,00 | 308 | 1 |



Sanitair producten

Baden /
douchebakken /
stoomcabines

Kranen

Douchegarnituur

Accessoires en
spiegels

Douchewanden

Toebehoren &
afvoeren

Spoel- &
installatiesystemen

Badkamermeubelen
en toiletkasten

Gootstenen en
wastroggen

Utiliteit

meubelset m. spiegelkast

| | | | | | | | |
|---------|-------------|-------------|-------------------|------|---------|-----|---|
| 0310360 | 80cm rechts | wit/wit | D0080K00K0001S03L | stuk | 1830,00 | 308 | 1 |
| 0310361 | 80cm links | perg/wit | D0080K01K0101S03L | stuk | 1830,00 | 308 | 1 |
| 0310362 | 80cm links | cremona/wit | D0080DECDEC01S03L | stuk | 1830,00 | 308 | 1 |
| 0310363 | 80cm links | chateau/wit | D0080DCADCA01S03L | stuk | 1830,00 | 308 | 1 |
| 0310319 | 80cm links | alu/alu | D0080ALUALUS03L | stuk | 1825,00 | 308 | 1 |
| 0310364 | 80cm rechts | wit/wit | D0080K00K0002S03R | stuk | 1830,00 | 308 | 1 |
| 0310365 | 80cm rechts | perg/wit | D0080K01K0102S03R | stuk | 1830,00 | 308 | 1 |
| 0310366 | 80cm rechts | cremona/wit | D0080DECDEC02S03R | stuk | 1830,00 | 308 | 1 |
| 0310367 | 80cm rechts | chateau/wit | D0080DCADCA02S03R | stuk | 1830,00 | 308 | 1 |
| 0310321 | 80cm rechts | alu/alu | D0080ALUALUS03R | stuk | 1825,00 | 308 | 1 |

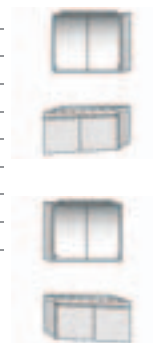

meubelset m. spiegelkast m. halfhoge kast

| | | | | | | | |
|---------|-------------------|-------------|-------------------|------|---------|-----|---|
| 0310368 | 80cm+50cm links | wit/wit | D0080K00K0001S04L | stuk | 2381,00 | 308 | 1 |
| 0310369 | 80cm+50cm links | perg/wit | D0080K01K0101S04L | stuk | 2381,00 | 308 | 1 |
| 0310370 | 80cm+50cm links | cremona/wit | D0080DECDEC01S04L | stuk | 2381,00 | 308 | 1 |
| 0310371 | 80cm+50cm links | chateau/wit | D0080DCADCA0AS04L | stuk | 2381,00 | 308 | 1 |
| 0310322 | 80cm +50cm links | alu/alu | D0080ALUALUS04L | stuk | 2375,00 | 308 | 1 |
| 0310372 | 80cm+50cm rechts | wit/wit | D0080K00K0002S04R | stuk | 2381,00 | 308 | 1 |
| 0310376 | 80cm+50cm rechts | perg/wit | D0080K01K0102S04R | stuk | 2381,00 | 308 | 1 |
| 0310378 | 80cm+50cm rechts | cremona/wit | D0080DECDEC02S04R | stuk | 2381,00 | 308 | 1 |
| 0310380 | 80cm+50cm rechts | chateau/wit | D0080DCADCA02S04R | stuk | 2381,00 | 308 | 1 |
| 0310323 | 80cm +50cm rechts | alu/alu | D0080ALUALUS04R | stuk | 2375,00 | 308 | 1 |



Riho Garda

meubelset m. spiegel

| | | | | | | | |
|---------|--------------|-----------|-----------------|------|---------|-----|---|
| 0310308 | 105cm rechts | wit/wit | GA105KK4000S01R | stuk | 1675,00 | 308 | 1 |
| 0310309 | 105cm rechts | perg/perg | GA105KK4100S01R | stuk | 1675,00 | 308 | 1 |
| 0310332 | 105cm links | wit/wit | GA105KK4000S01L | stuk | 1675,00 | 308 | 1 |
| 0310333 | 105cm links | perg/perg | GA105KK4100S01L | stuk | 1675,00 | 308 | 1 |
| 0310334 | 140cm | wit/wit | GA140KK4000S02 | stuk | 2026,00 | 308 | 1 |
| 0310335 | 140cm | perg/perg | GA140KK4100S02 | stuk | 2026,00 | 308 | 1 |



Art.nr Specificaties Kleur Lev.nr Ehd Prijs Grp CC

Riho Garda

meubelset m. spiegel m. dubbele wastafel

| | | | | | | | | |
|---------|-------|--|-----------|----------------|------|---------|-----|---|
| 0310336 | 140cm | | wit/wit | GA140KK4000S03 | stuk | 2156,00 | 308 | 1 |
| 0310337 | 140cm | | perg/perg | GA140KK4100S03 | stuk | 2156,00 | 308 | 1 |



Sanitair producten

Baden /
douchebakken /
stoomcabines

meubelset m. spiegel m. hoge kast

| | | | | | | | | |
|---------|-------|--------|-----------|-----------------|------|---------|-----|---|
| 0310340 | 140cm | rechts | wit/wit | GA140KK4000S04R | stuk | 2016,00 | 308 | 1 |
| 0310341 | 140cm | rechts | perg/perg | GA140KK4100S04R | stuk | 2016,00 | 308 | 1 |
| 0310342 | 140cm | links | wit/wit | GA140KK4000S04L | stuk | 2016,00 | 308 | 1 |
| 0310343 | 140cm | links | perg/perg | GA140KK4100S04L | stuk | 2016,00 | 308 | 1 |



Kranen

Douchegarnituur



Accessoires en
spiegels

Riho Imola

set 1 badkamermeubel

| | | | | | | | | |
|---------|-------------|--------|-------------------|-----------------|------|---------|-----|---|
| 0312003 | 180,5x105cm | links | wit/wit/wit | IM105K00K00401L | stuk | 1274,00 | 308 | 1 |
| 0312004 | 180,5x105cm | links | perg/perg./perg. | IM105K01K01411L | stuk | 1274,00 | 308 | 1 |
| 0312005 | 180,5x105cm | links | crem./wit/wit | IM105DECK00401L | stuk | 1274,00 | 308 | 1 |
| 0312006 | 180,5x105cm | links | crem./perg./perg. | IM105DECK01411L | stuk | 1274,00 | 308 | 1 |
| 0312007 | 180,5x105cm | rechts | wit/wit/wit | IM105K00K00401R | stuk | 1274,00 | 308 | 1 |
| 0312008 | 180,5x105cm | rechts | perg/perg./perg. | IM105K01K01411R | stuk | 1274,00 | 308 | 1 |
| 0312009 | 180,5x105cm | rechts | crem./wit/wit | IM105DECK00401R | stuk | 1274,00 | 308 | 1 |
| 0312012 | 180,5x105cm | rechts | crem./perg./perg. | IM105DECK01411R | stuk | 1274,00 | 308 | 1 |



Douchewanden

Toebehoren &
afvoeren

Spoel- &
installatiesystemen

set 2 badkamermeubel

| | | | | | | | | |
|---------|-------------|--------|-------------------|-----------------|------|---------|-----|---|
| 0312013 | 180,5x105cm | links | wit/wit/wit | IM105K00K00402L | stuk | 1494,00 | 308 | 1 |
| 0312014 | 180,5x105cm | links | perg./perg./perg. | IM105K01K01412L | stuk | 1494,00 | 308 | 1 |
| 0312017 | 180,5x105cm | links | crem./wit/wit | IM105DECK00402L | stuk | 1494,00 | 308 | 1 |
| 0312019 | 180,5x105cm | links | crem./perg./perg. | IM105DECK01412L | stuk | 1494,00 | 308 | 1 |
| 0312021 | 180,5x105cm | rechts | wit/wit/wit | IM105K00K00402R | stuk | 1494,00 | 308 | 1 |
| 0312023 | 180,5x105cm | rechts | perg./perg./perg. | IM105K01K01412R | stuk | 1494,00 | 308 | 1 |
| 0312024 | 180,5x105cm | rechts | crem./wit/wit | IM105DECK00402R | stuk | 1494,00 | 308 | 1 |
| 0312027 | 180,5x105cm | rechts | crem./perg./perg. | IM105DECK01412R | stuk | 1494,00 | 308 | 1 |

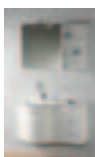

Badkamermeubelen
en toiletkasten

Gootstenen en
wastroggen

set 3 badkamermeubel

| | | | | | | | | |
|---------|-------------|--------|-------------------|-----------------|------|---------|-----|---|
| 0312028 | 180,5x140cm | links | wit/wit/wit | IM140K00K00403L | stuk | 1594,00 | 308 | 1 |
| 0312030 | 180,5x140cm | links | perg./perg./perg. | IM140K01K01413L | stuk | 1594,00 | 308 | 1 |
| 0312031 | 180,5x140cm | links | crem./wit/wit | IM140DECK00403L | stuk | 1594,00 | 308 | 1 |
| 0312032 | 180,5x140cm | links | crem./perg./perg. | IM140DECK01413L | stuk | 1594,00 | 308 | 1 |
| 0312033 | 180,5x140cm | rechts | wit/wit/wit | IM140K00K00403R | stuk | 1594,00 | 308 | 1 |
| 0312034 | 180,5x140cm | rechts | perg./perg./perg. | IM140K01K01413R | stuk | 1594,00 | 308 | 1 |
| 0312035 | 180,5x140cm | rechts | crem./wit/wit | IM140DECK00403R | stuk | 1594,00 | 308 | 1 |
| 0312036 | 180,5x140cm | rechts | crem./perg./perg. | IM140DECK01413R | stuk | 1594,00 | 308 | 1 |

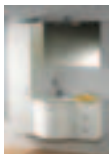

Utiliteit

set 4 badkamermeubel

| | | | | | | | | |
|---------|-------------|--|-------------------|-----------------|------|---------|-----|---|
| 0312041 | 180,5x140cm | | wit/wit/wit | IM140K00K00404L | stuk | 1925,00 | 308 | 1 |
| 0312042 | 180,5x140cm | | perg./perg./perg. | IM140K00K01414L | stuk | 1925,00 | 308 | 1 |
| 0312043 | 180,5x140cm | | crem./wit/wit | IM140DECK00404L | stuk | 1925,00 | 308 | 1 |
| 0312044 | 180,5x140cm | | crem./perg./perg. | IM140DECK01414L | stuk | 1925,00 | 308 | 1 |



Riho Lucca

meubelset 40cm m. spiegel

| | | | | | | | | |
|---------|--|--------|-------------|-----------------|------|--------|-----|---|
| 0310091 | | links | wit/wit | LUC40K00K00S01L | stuk | 697,00 | 308 | 1 |
| 0310093 | | links | cremo/wit | LUC40DECDECS01L | stuk | 697,00 | 308 | 1 |
| 0310095 | | links | perg./perg. | LUC41K01K01S01L | stuk | 697,00 | 308 | 1 |
| 0310097 | | links | cremo/perg | LUC41DECDECS01L | stuk | 697,00 | 308 | 1 |
| 0310090 | | rechts | wit/wit | LUC40K00K00S01R | stuk | 697,00 | 308 | 1 |
| 0310092 | | rechts | cremo/wit | LUC40DECDECS01R | stuk | 697,00 | 308 | 1 |
| 0310094 | | rechts | perg./perg. | LUC41K01K01S01R | stuk | 697,00 | 308 | 1 |
| 0310096 | | rechts | cremo/perg | LUC41DECDECS01R | stuk | 697,00 | 308 | 1 |

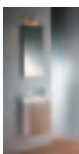

| Art.nr | Specificaties | Kleur | Lev.nr | Ehd | Prijs | Grp | CC |
|--------|---------------|-------|--------|-----|-------|-----|----|
|--------|---------------|-------|--------|-----|-------|-----|----|

Riho Lusso

meubelset m. spiegelkast m. halfhoge kast

| | | | | | | | |
|---------|------------------|---------------|-----------------|------|---------|-----|---|
| 0310258 | 80cm+41cm links | wit/wit/wit | LS080K00K00S02L | stuk | 2046,00 | 308 | 1 |
| 0310259 | 80cm+41cm links | perg/perg/wit | LS080K01K01S02L | stuk | 2046,00 | 308 | 1 |
| 0310260 | 80cm+41cm links | berk/wit/wit | LS080DBEK00S02L | stuk | 2046,00 | 308 | 1 |
| 0310261 | 80cm+41cm links | noot/wit/wit | LS080DNCK00S02L | stuk | 2046,00 | 308 | 1 |
| 0310262 | 80cm+41cm rechts | wit/wit/wit | LS080K00K00S02R | stuk | 2046,00 | 308 | 1 |
| 0310263 | 80cm+41cm rechts | perg/perg/wit | LS080K01K01S02R | stuk | 2046,00 | 308 | 1 |
| 0310264 | 80cm+41cm rechts | berk/wit/wit | LS080DBEDBES02R | stuk | 2046,00 | 308 | 1 |
| 0310265 | 80cm+41cm rechts | noot/wit/wit | LS080DNCDNCS02R | stuk | 2046,00 | 308 | 1 |



Sanitair producten

Baden /
douchebakken /
stoomcabines

Kranen

meubelset m. spiegel m. halfhoge kast

| | | | | | | | |
|---------|------------------|---------------|-----------------|------|---------|-----|---|
| 0310266 | 80cm+41cm links | wit/wit/wit | LS080K00K00S03L | stuk | 1835,00 | 308 | 1 |
| 0310267 | 80cm+41cm links | perg/perg/wit | LS080K01K01S03L | stuk | 1835,00 | 308 | 1 |
| 0310268 | 80cm+41cm links | berk/wit/wit | LS080DBEK00S03L | stuk | 1835,00 | 308 | 1 |
| 0310269 | 80cm+41cm links | noot/wit/wit | LS080DNCK00S03L | stuk | 1835,00 | 308 | 1 |
| 0310243 | 80cm+41cm rechts | wit/wit/wit | LS080K00K00S03R | stuk | 1835,00 | 308 | 1 |
| 0310244 | 80cm+41cm rechts | perg/perg/wit | LS080K01K01S03R | stuk | 1835,00 | 308 | 1 |
| 0310246 | 80cm+41cm rechts | berk/wit/wit | LS080DBEK00S03R | stuk | 1835,00 | 308 | 1 |
| 0310311 | 80cm+41cm rechts | noot/wit/wit | LS080DNCK00S03R | stuk | 1835,00 | 308 | 1 |



Douchegarnituur

Accessoires en
spiegels

Douchewanden

meubelset m. 2 spiegels m. dubbele wastafel

| | | | | | | | |
|---------|-------|---------------|----------------|------|---------|-----|---|
| 0310254 | 130cm | wit/wit/wit | LS130K00K00S01 | stuk | 1915,00 | 308 | 1 |
| 0310255 | 130cm | perg/perg/wit | LS130K01K01S01 | stuk | 1915,00 | 308 | 1 |
| 0310256 | 130cm | berk/wit/wit | LS130DBEK00S01 | stuk | 1915,00 | 308 | 1 |
| 0310257 | 130cm | noot/wit/wit | LS130DNCK00S01 | stuk | 1915,00 | 308 | 1 |



Toebehoren &
afvoeren

Spoel- &
installatiesystemen

meubelset m. spiegelkast m. dubbele wastafel

| | | | | | | | |
|---------|-------|---------------|----------------|------|---------|-----|---|
| 0310270 | 130cm | wit/wit/wit | LS130K00K00S04 | stuk | 2331,00 | 308 | 1 |
| 0310271 | 130cm | perg/perg/wit | LS130K01K01S04 | stuk | 2331,00 | 308 | 1 |
| 0310272 | 130cm | berk/wit/wit | LS130DBEK00S04 | stuk | 2331,00 | 308 | 1 |
| 0310273 | 130cm | noot/wit/wit | LS130DNCK00S04 | stuk | 2331,00 | 308 | 1 |

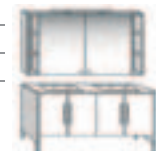

Badkamermeubelen
en toiletkasten

Gootstenen en
wastroggen

Riho Pronto

hoekmeubel m. spiegel

| | | | | | | | |
|---------|--------|----------|-----------------|------|---------|-----|---|
| 0311190 | links | wit | PR100K00K00S01L | stuk | 2271,00 | 308 | 1 |
| 0311201 | links | pergamon | PR100K01K01S01L | stuk | 2271,00 | 308 | 1 |
| 0311191 | rechts | wit | PR100K00K00S01R | stuk | 2271,00 | 308 | 1 |
| 0311202 | rechts | pergamon | PR100K01K01S01R | stuk | 2271,00 | 308 | 1 |



Utiliteit

hoekmeubel m. spiegelkast

| | | | | | | | |
|---------|--------|----------|-----------------|------|---------|-----|---|
| 0311203 | links | wit | PR100K00K00S02L | stuk | 2607,00 | 308 | 1 |
| 0311207 | links | pergamon | PR100K01K01S02L | stuk | 2607,00 | 308 | 1 |
| 0311204 | rechts | wit | PR100K00K00S02R | stuk | 2607,00 | 308 | 1 |
| 0311208 | rechts | pergamon | PR100K01K01S02R | stuk | 2607,00 | 308 | 1 |



Riho Rimini

set 5 badkamermeubel

| | | | | | | | |
|---------|-----------|----------------|----------------|------|---------|-----|---|
| 0312047 | 170x100cm | wit/wit/wit | RM100K00K00S05 | stuk | 1203,00 | 308 | 1 |
| 0312049 | 170x100cm | cremo./wit/wit | RM100DECECS05 | stuk | 1203,00 | 308 | 1 |

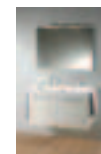

| Art.nr | Specificaties | Kleur | Lev.nr | Ehd | Prijs | Grp | CC |
|--------|---------------|-------|--------|-----|-------|-----|----|
|--------|---------------|-------|--------|-----|-------|-----|----|

Riho Rimini

set 6 badkamermeubel

| | | | | | | | |
|---------|-----------|-----------------|-----------------|------|---------|-----|---|
| 0312051 | 170x150cm | wit/wit/wit | RM160K00K00S06 | stuk | 1604,00 | 308 | 1 |
| 0312057 | 170x150cm | cremano/wit/wit | RM160DECEDECS06 | stuk | 1604,00 | 308 | 1 |



Sanitair producten

Baden /
douchebakken /
stoomcabines

Riho Tiamo1

meubelset m. spiegel

| | | | | | | | |
|---------|------|---------------|----------------|------|---------|-----|---|
| 0310193 | 80cm | wit/wit/wit | T1080K00K00S01 | stuk | 1539,00 | 308 | 1 |
| 0310194 | 80cm | perg/perg/wit | T1080K01K01S01 | stuk | 1539,00 | 308 | 1 |
| 0310195 | 80cm | berk/wit/wit | T1080DBEK00S01 | stuk | 1539,00 | 308 | 1 |
| 0310196 | 80cm | noot/wit/wit | T1080DNCK00S01 | stuk | 1539,00 | 308 | 1 |



Kranen

Douchegarnituur

meubelset m. spiegelkast

| | | | | | | | |
|---------|------|---------------|----------------|------|---------|-----|---|
| 0310197 | 80cm | wit/wit/wit | T1080K00K00S02 | stuk | 1770,00 | 308 | 1 |
| 0310198 | 80cm | perg/perg/wit | T1080K01K01S02 | stuk | 1770,00 | 308 | 1 |
| 0310199 | 80cm | berk/wit/wit | T1080DBEK00S02 | stuk | 1770,00 | 308 | 1 |
| 0310200 | 80cm | noot/wit/wit | T1080DNCK00S02 | stuk | 1770,00 | 308 | 1 |



Accessoires en
spiegels

Douchewanden

meubelset m. spiegel m. hoge kast

| | | | | | | | | |
|---------|-------|--------|---------------|-----------------|------|---------|-----|---|
| 0310201 | 120cm | links | wit/wit/wit | T1120K00K00S03L | stuk | 2116,00 | 308 | 1 |
| 0310203 | 120cm | links | perg/perg/wit | T1120K01K01S03L | stuk | 2116,00 | 308 | 1 |
| 0310204 | 120cm | links | berk/wit/wit | T1120DBEK00S03L | stuk | 2116,00 | 308 | 1 |
| 0310205 | 120cm | links | noot/wit/wit | T1120DNCK00S03L | stuk | 2116,00 | 308 | 1 |
| 0310396 | 120cm | rechts | wit/wit/wit | T1120K00K00S03R | stuk | 2116,00 | 308 | 1 |
| 0310397 | 120cm | rechts | perg/perg/wit | T1120K01K01S03R | stuk | 2116,00 | 308 | 1 |
| 0310398 | 120cm | rechts | berk/wit/wit | T1120DBEK00S03R | stuk | 2116,00 | 308 | 1 |
| 0310399 | 120cm | rechts | noot/wit/wit | T1120DNCK00S03R | stuk | 2116,00 | 308 | 1 |



Toebehoren &
afvoeren

Spoel- &
installatiesystemen

meubelset m. spiegel m. lage kast

| | | | | | | | | |
|---------|-------|--------|---------------|-----------------|------|---------|-----|---|
| 0310206 | 120cm | links | wit/wit/wit | T1120K00K00S04L | stuk | 2346,00 | 308 | 1 |
| 0310207 | 120cm | links | perg/perg/wit | T1120K01K01S04L | stuk | 2346,00 | 308 | 1 |
| 0310208 | 120cm | links | berk/wit/wit | T1120DBDK00S04L | stuk | 2346,00 | 308 | 1 |
| 0310209 | 120cm | links | noot/wit/wit | T1120DNCK00S04L | stuk | 2346,00 | 308 | 1 |
| 0310400 | 120cm | rechts | wit/wit/wit | T1120K00K00S04R | stuk | 2346,00 | 308 | 1 |
| 0310401 | 120cm | rechts | perg/perg/wit | T1120K01K01S04R | stuk | 2346,00 | 308 | 1 |
| 0310402 | 120cm | rechts | berk/wit/wit | T1120DBDK00S04R | stuk | 2346,00 | 308 | 1 |
| 0310403 | 120cm | rechts | noot/wit/wit | T1120DNCK00S04R | stuk | 2346,00 | 308 | 1 |



Gootstenen en
wastroggen

Utiliteit

Riho Tiamo2

meubelset m. spiegel

| | | | | | | | |
|---------|------|---------------|----------------|------|---------|-----|---|
| 0310210 | 80cm | wit/wit/wit | T1080K00K00S09 | stuk | 1750,00 | 308 | 1 |
| 0310211 | 80cm | perg/perg/wit | T1080K01K01S09 | stuk | 1750,00 | 308 | 1 |
| 0310212 | 80cm | berk/wit/wit | T1080DBEK00S09 | stuk | 1750,00 | 308 | 1 |
| 0310213 | 80cm | noot/wit/wit | T1080DNCK00S09 | stuk | 1750,00 | 308 | 1 |



meubelset m. spiegelkast

| | | | | | | | |
|---------|------|---------------|----------------|------|---------|-----|---|
| 0310214 | 80cm | wit/wit/wit | T1080K00K00S10 | stuk | 1980,00 | 308 | 1 |
| 0310215 | 80cm | perg/perg/wit | T1080K01K01S10 | stuk | 1980,00 | 308 | 1 |
| 0310216 | 80cm | berk/wit/wit | T1080DBEK00S10 | stuk | 1980,00 | 308 | 1 |
| 0310217 | 80cm | noot/wit/wit | T1080DNCK00S10 | stuk | 1980,00 | 308 | 1 |



| Art.nr | Specificaties | Kleur | Lev.nr | Ehd | Prijs | Grp | CC |
|--------|---------------|-------|--------|-----|-------|-----|----|
|--------|---------------|-------|--------|-----|-------|-----|----|

Riho Tiamo2

meubelset m. spiegel m. hoge kast

| | | | | | | | | |
|---------|-------|--------|---------------|-----------------|------|---------|-----|---|
| 0310218 | 120cm | links | wit/wit/wit | TI20K00K00S11L | stuk | 2326,00 | 308 | 1 |
| 0310219 | 120cm | links | perg/perg/wit | TI120K01K01S11L | stuk | 2326,00 | 308 | 1 |
| 0310248 | 120cm | links | berk/wit/wit | TI120DBEK00S11L | stuk | 2326,00 | 308 | 1 |
| 0310249 | 120cm | links | noot/wit/wit | TI120DNCK00S11L | stuk | 2326,00 | 308 | 1 |
| 0310404 | 120cm | rechts | wit/wit/wit | TI20K00K00S11R | stuk | 2326,00 | 308 | 1 |
| 0310405 | 120cm | rechts | perg/perg/wit | TI120K01K01S11R | stuk | 2326,00 | 308 | 1 |
| 0310406 | 120cm | rechts | berk/wit/wit | TI120DBEK00S11R | stuk | 2326,00 | 308 | 1 |
| 0310407 | 120cm | rechts | noot/wit/wit | TI120DNCK00S11R | stuk | 2326,00 | 308 | 1 |



Sanitair producten

Baden /
douchebakken /
stoomcabines

Kranen

Douchegarnituur

Accessoires en
spiegels

Douchewanden

Toebehoren &
afvoeren

meubelset m. spiegel m. lage kast

| | | | | | | | | |
|---------|-------|--------|---------------|-----------------|------|---------|-----|---|
| 0310250 | 120cm | links | wit/wit/wit | TI120K00K00S12L | stuk | 2557,00 | 308 | 1 |
| 0310251 | 120cm | links | perg/perg/wit | TI120K01K01S12L | stuk | 2557,00 | 308 | 1 |
| 0310252 | 120cm | links | berk/wit/wit | TI120DBEK00S12L | stuk | 2557,00 | 308 | 1 |
| 0310253 | 120cm | links | noot/wit/wit | TI120DNCK00S12L | stuk | 2557,00 | 308 | 1 |
| 0310408 | 120cm | rechts | wit/wit/wit | TI120K00K00S12R | stuk | 2557,00 | 308 | 1 |
| 0310409 | 120cm | rechts | perg/perg/wit | TI120K01K01S12R | stuk | 2557,00 | 308 | 1 |
| 0310410 | 120cm | rechts | berk/wit/wit | TI120DBEK00S12R | stuk | 2557,00 | 308 | 1 |
| 0310411 | 120cm | rechts | noot/wit/wit | TI120DNCK00S12R | stuk | 2557,00 | 308 | 1 |



Riho Tivoli

meubelset m. spiegel

| | | | | | | | | |
|---------|-------|--------|----------|-----------------|------|---------|-----|---|
| 0310274 | 105cm | rechts | wit/wit | TV105K00K00S01R | stuk | 1625,00 | 308 | 1 |
| 0310275 | 105cm | rechts | perg/wit | TV105K01K01S01R | stuk | 1625,00 | 308 | 1 |
| 0310276 | 105cm | links | wit/wit | TV105K00K00S01L | stuk | 1625,00 | 308 | 1 |
| 0310277 | 105cm | links | perg/wit | TV105K01K01S01L | stuk | 1625,00 | 308 | 1 |



Spoel- &
installatiesystemen

Badkamermeubelen
en toiletkasten

Gootstenen en
wastroggen

meubelset m. spiegel m. hoge kast

| | | | | | | | | |
|---------|-------|--------|----------|-----------------|------|---------|-----|---|
| 0310278 | 137cm | rechts | wit/wit | TV137K00K00S03R | stuk | 2386,00 | 308 | 1 |
| 0310279 | 137cm | rechts | perg/wit | TV137K01K01S03R | stuk | 2386,00 | 308 | 1 |
| 0310282 | 137cm | links | wit/wit | TV137K00K00S03L | stuk | 2386,00 | 308 | 1 |
| 0310283 | 137cm | links | perg/wit | TV137K01K01S03L | stuk | 2386,00 | 308 | 1 |



Utiliteit

Riho Toebehoren

| | | | | | | | | |
|---------|-------------|-----|--|-------|------|-------|-----|---|
| 0310071 | meubelgreep | RVS | | 1BG80 | stuk | 10,50 | 308 | 1 |
|---------|-------------|-----|--|-------|------|-------|-----|---|

| | Art.nr | Specificaties | Kleur | Lev.nr | Ehd | Prijs | Grp | CC |
|---|--|------------------|----------|-----------|------|---------|-----|----|
| | SaniJura Dolfijn | | | | | | | |
| Sanitair producten | wastafelblad hout m. kom links 110cm | | | | | | | |
| | 0315273 | | wit | 310361-01 | stuk | 1108,00 | 311 | 1 |
| | 0315281 | | pergamon | 310361 | stuk | 1108,00 | 311 | 1 |
| Baden / douchebakken / stoomcabines | wastafelblad hout m. kom rechts 110cm | | | | | | | |
| | 0315303 | | wit | 310362-01 | stuk | 1108,00 | 311 | 1 |
| | 0315311 | | pergamon | 310362 | stuk | 1108,00 | 311 | 1 |
| Kranen | wastafelblad integraal m. kom links 110cm | | | | | | | |
| | 0315338 | | wit | 550003-01 | stuk | 549,00 | 311 | 1 |
| | 0315346 | | pergamon | 550003 | stuk | 549,00 | 311 | 1 |
| Douchegarnituur | wastafelblad integraal m. kom rechts 110cm | | | | | | | |
| | 0315354 | | wit | 550004-01 | stuk | 549,00 | 311 | 1 |
| | 0315362 | | pergamon | 550004 | stuk | 549,00 | 311 | 1 |
| Douchegarnituur | wastafelonderbouw 110cm z. wastafelblad | | | | | | | |
| | 0310603 | rechts | gelakt | 310047 | stuk | 1142,00 | 311 | 1 |
| | 0310611 | links | gelakt | 310048 | stuk | 1142,00 | 311 | 1 |
| Accessoires en spiegels | spiegel 110cm m. lichtbalk m. kast | | | | | | | |
| | 0310662 | rechts | gelakt | 391148 | stuk | 946,00 | 311 | 1 |
| | 0310654 | links | gelakt | 391147 | stuk | 946,00 | 311 | 1 |
| Douchewanden | | | | | | | | |
| Toebehoren & afvoeren | hoge kast 2xdeuren 2xladen | | | | | | | |
| | 0310700 | 167x35cm rechts | gelakt | 312712 | stuk | 496,00 | 311 | 1 |
| | 0310697 | 167x35cm links | gelakt | 312711 | stuk | 496,00 | 311 | 1 |
| Spool- & installatiesystemen | | | | | | | | |
| Badkamermeubelen en toiletkasten | lage kast 1x deur 2x laden | | | | | | | |
| | 0310743 | 77.7x35cm rechts | gelakt | 312816 | stuk | 371,00 | 311 | 1 |
| | 0310735 | 77.7x35cm links | gelakt | 312815 | stuk | 371,00 | 311 | 1 |
| Gootstenen en wastroggen | | | | | | | | |
| Utiliteit | afdekplaat | | | | | | | |
| | 0310786 | 35cm | gelakt | 923050 | stuk | 73,00 | 311 | 1 |
| | 0310794 | 70cm | gelakt | 923052 | stuk | 130,00 | 311 | 1 |
| | 0310808 | 105cm | gelakt | 923055 | stuk | 171,00 | 311 | 1 |
| | SaniJura Twin | | | | | | | |
| | wastafelblad m. kom 80cm | | | | | | | |
| | 0311650 | rechts | wit | 550008 | stuk | 350,00 | 311 | 1 |
| | 0311669 | rechts | jasmijn | 550008R | stuk | 350,00 | 311 | 1 |
| | 0311634 | links | wit | 550007 | stuk | 350,00 | 311 | 1 |
| | 0311642 | links | jasmijn | 550007L | stuk | 350,00 | 311 | 1 |
| | wastafelonderbouw 3x deur 1x lade m. handdoekhouder | | | | | | | |
| | 0311782 | 75x59.1cm rechts | wit | 795011 | stuk | 370,00 | 311 | 1 |
| | 0311790 | 75x59.1cm rechts | jasmijn | 795011R | stuk | 370,00 | 311 | 1 |
| | 0311766 | 75x59.1cm links | wit | 795010 | stuk | 370,00 | 311 | 1 |
| | 0311774 | 75x59.1cm links | jasmijn | 795010L | stuk | 370,00 | 311 | 1 |
| | spiegel m. spot m. sierrek | | | | | | | |
| | 0311588 | 78x105cm rechts | wit | 791001 | stuk | 379,00 | 311 | 1 |
| | 0311596 | 78x105cm rechts | jasmijn | 791001L | stuk | 379,00 | 311 | 1 |
| | 0311618 | 78x105cm links | wit | 791002 | stuk | 379,00 | 311 | 1 |
| | 0311626 | 78x105cm links | jasmijn | 791002R | stuk | 379,00 | 311 | 1 |

| Art.nr | Specificaties | Kleur | Lev.nr | Ehd | Prijs | Grp | CC |
|--------|---------------|-------|--------|-----|-------|-----|----|
|--------|---------------|-------|--------|-----|-------|-----|----|

SaniJura Twin

toiletkast m. spot m. sierrek

| | | | | | | | |
|---------|----------|--------|---------|---------|------|--------|-------|
| 0311731 | 78x105cm | rechts | wit | 791012 | stuk | 482,00 | 311 1 |
| 0311758 | 78x105cm | rechts | jasmijn | 791012R | stuk | 482,00 | 311 1 |
| 0311715 | 78x105cm | links | wit | 791011 | stuk | 482,00 | 311 1 |
| 0311723 | 78x105cm | links | jasmijn | 791011L | stuk | 482,00 | 311 1 |



Sanitair producten

Baden /
douchebakken /
stoomcabines

halfhoge kast

| | | | | | | | |
|---------|----------|--------|---------|---------|------|--------|-------|
| 0311693 | 30x105cm | rechts | wit | 040200 | stuk | 190,00 | 311 1 |
| 0311707 | 30x105cm | rechts | jasmijn | 792012R | stuk | 215,00 | 311 1 |
| 0311677 | 30x105cm | links | wit | 792011 | stuk | 215,00 | 311 1 |
| 0311685 | 30x105cm | links | jasmijn | 792011L | stuk | 215,00 | 311 1 |



Kranen

Douchegarnituur

afdekplaat voor halfhoge kast

| | | | | | | | |
|---------|--|--|---------|--------|------|-------|-------|
| 0311804 | | | wit | 793030 | stuk | 62,00 | 311 1 |
| 0311812 | | | jasmijn | 793030 | stuk | 62,00 | 311 1 |

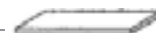
Accessoires en
spiegels

SaniJura Universeel



toiletkast m. halogeenspots

| | | | | | | | |
|---------|-------|------------|----------|--------|------|--------|-------|
| 0311820 | 60cm | | wit | 914800 | stuk | 348,00 | 311 1 |
| 0311839 | 60cm | | pergamon | 914820 | stuk | 402,00 | 311 1 |
| 0311847 | 70cm | | wit | 914801 | stuk | 454,00 | 311 1 |
| 0311855 | 70cm | | pergamon | 914821 | stuk | 527,00 | 311 1 |
| 0311863 | 90cm | | wit | 914804 | stuk | 536,00 | 311 1 |
| 0311871 | 90cm | | pergamon | 914824 | stuk | 619,00 | 311 1 |
| 0311898 | 90cm | m. sierrek | wit | 914805 | stuk | 533,00 | 311 1 |
| 0311901 | 90cm | m. sierrek | pergamon | 914825 | stuk | 616,00 | 311 1 |
| 0311928 | 105cm | | wit | 914806 | stuk | 546,00 | 311 1 |
| 0311936 | 105cm | | pergamon | 914826 | stuk | 628,00 | 311 1 |

Douchewanden

Toebehoren &
afvoerenSpoel- &
installatiesystemenBadkamermeubelen
en toiletkastenGootstenen en
wastroggen

Utiliteit

| | Art.nr | Specificaties | Kleur | Lev.nr | Ehd | Prijs | Grp | CC |
|---|---------|---------------|-----------------|------------------|------|---------|-----|----|
| Schock Cona | | | | | | | | |
| meubelset 1 | | | | | | | | |
| Sanitair producten | 0990381 | links | perg./perg. | 974485660L | stuk | 4298,00 | 320 | 1 |
| Schock Dart | | | | | | | | |
| meubelset 105cm | | | | | | | | |
| Baden / douchebakken / stoomcabines | 0933899 | | glanswit | SDA10DART0115140 | stuk | 2244,00 | 320 | 1 |
| | 0933902 | | glanspergamon | SDA12DART0195140 | stuk | 2244,00 | 320 | 1 |
| | 0933910 | | mat wit | SDA20DART0115140 | stuk | 2244,00 | 320 | 1 |
| | 0933929 | | mat pergamon | SDA22DART0195140 | stuk | 2244,00 | 320 | 1 |
| meubelset 105cm m. lade | | | | | | | | |
| Kranen | 0933912 | | glanswit | SDA10DART0215140 | stuk | 2435,00 | 320 | 1 |
| | 0933914 | | glanspergamon | SDA12DART0295140 | stuk | 2435,00 | 320 | 1 |
| | 0933916 | | matwit | SDA20DART0215140 | stuk | 2435,00 | 320 | 1 |
| Douchegarnituur | 0933918 | | matpergamon | SDA22DART0295140 | stuk | 2435,00 | 320 | 1 |
| wastafel m. onderbouw 105cm | | | | | | | | |
| Accessoires en spiegels | 0933937 | | glanswit | SDA10DARTW115140 | stuk | 1521,00 | 320 | 1 |
| | 0933945 | | glanspergamon | SDA12DARTW195140 | stuk | 1521,00 | 320 | 1 |
| | 0933953 | | mat wit | SDA20DARTW115140 | stuk | 1521,00 | 320 | 1 |
| | 0933961 | | mat pergamon | SDA22DARTW195140 | stuk | 1521,00 | 320 | 1 |
| wastafel m. onderbouw 105cm m. lade | | | | | | | | |
| Douchewanden | 0933911 | | glanswit | SDA10DARTW215140 | stuk | 1708,00 | 320 | 1 |
| | 0933913 | | glanspergamon | SDA12DARTW295140 | stuk | 1708,00 | 320 | 1 |
| | 0933915 | | matwit | SDA20DARTW215140 | stuk | 1708,00 | 320 | 1 |
| | 0933917 | | matpergamon | SDA22DARTW295140 | stuk | 1708,00 | 320 | 1 |
| spiegelkast 100cm | | | | | | | | |
| Toebehoren & afvoeren | 0933988 | | glanswit | SDA10SLD1050 | stuk | 857,00 | 320 | 1 |
| | 0933996 | | glanspergamon | SDA12SLD1050 | stuk | 857,00 | 320 | 1 |
| | 0934003 | | mat wit | SDA20SLD1050 | stuk | 857,00 | 320 | 1 |
| | 0934011 | | mat pergamon | SDA22SLD1050 | stuk | 857,00 | 320 | 1 |
| hoge kast 35cm | | | | | | | | |
| Badkamermeubelen en toiletkasten | 0934038 | links | glanswit | SDA10HS3583L5140 | stuk | 562,00 | 320 | 1 |
| | 0934046 | links | glanspergamon | SDA12HS3583L5140 | stuk | 562,00 | 320 | 1 |
| | 0934054 | links | mat wit | SDA20HS3583L5140 | stuk | 562,00 | 320 | 1 |
| | 0934062 | links | mat pergamon | SDA22HS3583L5140 | stuk | 562,00 | 320 | 1 |
| | 0934070 | rechts | glanswit | SDA10HS3583R5140 | stuk | 562,00 | 320 | 1 |
| | 0934089 | rechts | glanspergamon | SDA12HS3583R5140 | stuk | 562,00 | 320 | 1 |
| | 0934097 | rechts | mat wit | SDA20HS3583R5140 | stuk | 562,00 | 320 | 1 |
| | 0934100 | rechts | mat pergamon | SDA22HS3583R5140 | stuk | 562,00 | 320 | 1 |
| halfhoge kast 35cm | | | | | | | | |
| Gootstenen en wastroggen | 0934119 | links | glanswit | SDA10UH3542L5140 | stuk | 655,00 | 320 | 1 |
| | 0934127 | links | glanspergamon | SDA12UH3542L5140 | stuk | 655,00 | 320 | 1 |
| | 0934135 | links | mat wit | SDA20UH3542L5140 | stuk | 655,00 | 320 | 1 |
| | 0934143 | links | mat pergamon | SDA22UH3542L5140 | stuk | 655,00 | 320 | 1 |
| | 0934151 | rechts | glanswit | SDA10UH3542R5140 | stuk | 655,00 | 320 | 1 |
| | 0934178 | rechts | glanspergamon | SDA12UH3542R5140 | stuk | 655,00 | 320 | 1 |
| | 0934186 | rechts | mat wit | SDA20UH3542R5140 | stuk | 655,00 | 320 | 1 |
| | 0934194 | rechts | mat pergamon | SDA22UH3542R5140 | stuk | 655,00 | 320 | 1 |
| handdoekhouder enkel | | | | | | | | |
|  | 0934208 | | chroom | HHW115028 | stuk | 105,00 | 320 | 1 |
| | 0934216 | | matchroom | HHW115012 | stuk | 105,00 | 320 | 1 |
| handdoekhouder dubbel | | | | | | | | |
|  | 0934224 | | chroom | HHD165028 | stuk | 113,00 | 320 | 1 |
| | 0934232 | | matchroom | HHD165012 | stuk | 113,00 | 320 | 1 |
| Schock De Luxe | | | | | | | | |
| meubelset 160cm m. dubbele spiegel | | | | | | | | |
| | 0992772 | | glanswit/chr. | SDX03DXGK4114340 | stuk | 7916,00 | 320 | 1 |
| | 0992773 | | glansperg./chr. | SDX04DXGK4194340 | stuk | 7916,00 | 320 | 1 |

| Art.nr | Specificaties | Kleur | Lev.nr | Ehd | Prijs | Grp | CC |
|---|---------------|------------------|------------------|------|---------|-----|----|
| Schock De Luxe | | | | | | | |
| meubelset 160cm m. dubbele spiegelkast | | | | | | | |
| 1000076 | | glanswit/chr. | SDX03DXGS4114340 | stuk | 8795,00 | 320 | 1 |
| 1000077 | | glansperg./chr. | SDX04DXGS4194340 | stuk | 8795,00 | 320 | 1 |
| Schock Sepa | | | | | | | |
| meubelset 70cm m. spiegel | | | | | | | |
| 1000021 | | m-wit/m-wit/chr. | SD01DOR011 | stuk | 1551,00 | 320 | 1 |
| 1000022 | | matwit/alu./chr. | SD01UDOR011 | stuk | 1551,00 | 320 | 1 |
| 1000023 | | perg./perg./chr. | SD09DOR019 | stuk | 1551,00 | 320 | 1 |
| 1000024 | | perg./kers/chr. | SD09KDOR019 | stuk | 1551,00 | 320 | 1 |
| meubelset 70cm m. spiegelkast | | | | | | | |
| 1000025 | | m-wit/m-wit/chr. | SD01DOR021 | stuk | 1793,00 | 320 | 1 |
| 1000026 | | matwit/alu./chr. | SD01UDOR021 | stuk | 1793,00 | 320 | 1 |
| 1000027 | | perg./perg./chr. | SD09DOR029 | stuk | 1793,00 | 320 | 1 |
| 1000028 | | perg./kers/chr. | SD09KDOR029 | stuk | 1793,00 | 320 | 1 |
| 1000030 | | m-wit/m-wit/chr. | SD01DOR03L1 | stuk | 1894,00 | 320 | 1 |
| meubelset 70 + 35cm m. spiegel | | | | | | | |
| 1000032 | links | matwit/alu./chr. | SD01UDOR03L1 | stuk | 1894,00 | 320 | 1 |
| 1000034 | links | perg./perg./chr. | SD09DOR03L9 | stuk | 1894,00 | 320 | 1 |
| 1000036 | links | perg./kers/chr. | SD09KDOR03L9 | stuk | 1894,00 | 320 | 1 |
| 1000029 | rechts | m-wit/m-wit/chr. | SD01DOR03R1 | stuk | 1894,00 | 320 | 1 |
| 1000031 | rechts | matwit/alu./chr. | SD01UDOR03R1 | stuk | 1894,00 | 320 | 1 |
| 1000033 | rechts | perg./perg./chr. | SD09DOR03R9 | stuk | 1894,00 | 320 | 1 |
| 1000035 | rechts | perg./kers/chr. | SD09KDOR03R9 | stuk | 1894,00 | 320 | 1 |
| meubelset 70 + 35cm m. spiegelkast | | | | | | | |
| 1000038 | links | m-wit/m-wit/chr. | SD01DOR04L1 | stuk | 2278,00 | 320 | 1 |
| 1000041 | links | matwit/alu./chr. | SD01UDOR04L1 | stuk | 2278,00 | 320 | 1 |
| 1000043 | links | perg./perg./chr. | SD09DOR04L9 | stuk | 2278,00 | 320 | 1 |
| 1000045 | links | perg./kers/chr. | SD09KDOR04L9 | stuk | 2278,00 | 320 | 1 |
| 1000037 | rechts | m-wit/m-wit/chr. | SD01DOR04R1 | stuk | 2278,00 | 320 | 1 |
| 1000040 | rechts | matwit/alu./chr. | SD01UDOR04R1 | stuk | 2278,00 | 320 | 1 |
| 1000042 | rechts | perg./perg./chr. | SD09DOR04R9 | stuk | 2278,00 | 320 | 1 |
| 1000044 | rechts | perg./kers/chr. | SD09KDOR04R9 | stuk | 2278,00 | 320 | 1 |
| meubelset 120cm m. spiegelkast | | | | | | | |
| 1000046 | | m-wit/m-wit/chr. | SD01DOR061 | stuk | 2042,00 | 320 | 1 |
| 1000048 | | matwit/alu./chr. | SD01UDOR061 | stuk | 2042,00 | 320 | 1 |
| meubelset 120cm m. spiegel | | | | | | | |
| 1000049 | | perg./perg./chr. | SD09DOR069 | stuk | 2042,00 | 320 | 1 |
| 1000050 | | perg./kers/chr. | SD09KDOR069 | stuk | 2042,00 | 320 | 1 |
| meubelset 120cm m. spiegelkast | | | | | | | |
| 1000051 | | m-wit/m-wit/chr. | SD01DOR071 | stuk | 2406,00 | 320 | 1 |
| 1000052 | | matwit/alu./chr. | SD01UDOR071 | stuk | 2406,00 | 320 | 1 |
| 1000053 | | perg./perg./chr. | SD09DOR079 | stuk | 2406,00 | 320 | 1 |
| 1000054 | | perg./kers/chr. | SD09KDOR079 | stuk | 2406,00 | 320 | 1 |
| meubelset 120 + 35cm m. spiegel | | | | | | | |
| 1000057 | links | m-wit/m-wit/chr. | SD01DOR08L1 | stuk | 2527,00 | 320 | 1 |
| 1000059 | links | matwit/alu./chr. | SD01UDOR08L1 | stuk | 2527,00 | 320 | 1 |
| 1000061 | links | perg./perg./chr. | SD09DOR08L9 | stuk | 2527,00 | 320 | 1 |
| 1000064 | links | perg./kers/chr. | SD09KDOR08L9 | stuk | 2527,00 | 320 | 1 |
| 1000056 | rechts | m-wit/m-wit/chr. | SD01DOR08R1 | stuk | 2527,00 | 320 | 1 |
| 1000058 | rechts | matwit/alu./chr. | SD01UDOR08R1 | stuk | 2527,00 | 320 | 1 |
| 1000060 | rechts | perg./perg./chr. | SD09DOR08R9 | stuk | 2527,00 | 320 | 1 |
| 1000062 | rechts | perg./kers/chr. | SD09KDOR08R9 | stuk | 2527,00 | 320 | 1 |
| meubelset 120 + 35cm m. spiegelkast | | | | | | | |
| 1000066 | links | m-wit/m-wit/chr. | SD01DOR09L1 | stuk | 2891,00 | 320 | 1 |
| 1000068 | links | matwit/alu./chr. | SD01UDOR09L1 | stuk | 2891,00 | 320 | 1 |
| 1000070 | links | perg./perg./chr. | SD09DOR09L9 | stuk | 2891,00 | 320 | 1 |
| 1000073 | links | perg./kers/chr. | SD09KDOR09L9 | stuk | 2891,00 | 320 | 1 |
| 1000065 | rechts | m-wit/m-wit/chr. | SD01DOR09R1 | stuk | 2891,00 | 320 | 1 |
| 1000067 | rechts | matwit/alu./chr. | SD01UDOR09R1 | stuk | 2891,00 | 320 | 1 |
| 1000069 | rechts | perg./perg./chr. | SD09DOR09R9 | stuk | 2891,00 | 320 | 1 |
| 1000072 | rechts | perg./kers/chr. | SD09KDOR09R9 | stuk | 2891,00 | 320 | 1 |
| spiegelkast 70cm m. 2 spots | | | | | | | |
| 1000074 | | chroom | SD01SD00701 | stuk | 766,00 | 320 | 1 |
| spiegelkast 120cm m. 3 spots | | | | | | | |
| 1000075 | | chroom | SD01SD01201 | stuk | 1041,00 | 320 | 1 |

Sanitair producten

Baden /
douchebakken /
stoomcabines

Kranen

Douchegarnituur

Accessoires en
spiegels

Douchewanden

Toebehoren &
afvoeren

Spoel- &
installatiesystemen

Badkamermeubelen
en toiletkasten

Gootstenen en
wastroggen

Utiliteit

| Art.nr | Specificaties | Kleur | Lev.nr | Ehd | Prijs | Grp | CC |
|--------|---------------|-------|--------|-----|-------|-----|----|
|--------|---------------|-------|--------|-----|-------|-----|----|

Schock Siro

meubelset 80cm m. greep m. spiegel

| | | | | | | | |
|---------|----------|----------|-------------|------|---------|-----|---|
| 1001051 | m. laden | wit/alu. | SS11ASIR071 | stuk | 1742,00 | 320 | 1 |
|---------|----------|----------|-------------|------|---------|-----|---|



meubelset 80cm m. greep m. spiegelkast

| | | | | | | | |
|---------|----------|----------|-------------|------|---------|-----|---|
| 1001078 | m. laden | wit/alu. | SS11ASIR081 | stuk | 2039,00 | 320 | 1 |
|---------|----------|----------|-------------|------|---------|-----|---|



meubelset 150cm m. greep m. spiegel

| | | | | | | | |
|---------|----------------|----------|--------------|------|---------|-----|---|
| 1000888 | rechts m. deur | wit/alu. | SS11ASIR03R1 | stuk | 2370,00 | 320 | 1 |
|---------|----------------|----------|--------------|------|---------|-----|---|

| | | | | | | | |
|---------|-----------------|----------|--------------|------|---------|-----|---|
| 1001086 | rechts m. laden | wit/alu. | SS11ASIR09R1 | stuk | 2545,00 | 320 | 1 |
|---------|-----------------|----------|--------------|------|---------|-----|---|

| | | | | | | | |
|---------|---------------|----------|--------------|------|---------|-----|---|
| 1000918 | links m. deur | wit/alu. | SS11ASIR03L1 | stuk | 2370,00 | 320 | 1 |
|---------|---------------|----------|--------------|------|---------|-----|---|

| | | | | | | | |
|---------|----------------|----------|--------------|------|---------|-----|---|
| 1001108 | links m. laden | wit/alu. | SS11ASIR09L1 | stuk | 2545,00 | 320 | 1 |
|---------|----------------|----------|--------------|------|---------|-----|---|



meubelset 150cm m. greep m. spiegelkast

| | | | | | | | |
|---------|----------------|----------|--------------|------|---------|-----|---|
| 1000896 | rechts m. deur | wit/alu. | SS11ASIR04R1 | stuk | 2644,00 | 320 | 1 |
|---------|----------------|----------|--------------|------|---------|-----|---|

| | | | | | | | |
|---------|-----------------|----------|--------------|------|---------|-----|---|
| 1001094 | rechts m. laden | wit/alu. | SS11ASIR10R1 | stuk | 2819,00 | 320 | 1 |
|---------|-----------------|----------|--------------|------|---------|-----|---|

| | | | | | | | |
|---------|---------------|----------|--------------|------|---------|-----|---|
| 1000926 | links m. deur | wit/alu. | SS11ASIR04L1 | stuk | 2644,00 | 320 | 1 |
|---------|---------------|----------|--------------|------|---------|-----|---|

| | | | | | | | |
|---------|----------------|----------|--------------|------|---------|-----|---|
| 1001116 | links m. laden | wit/alu. | SS11ASIR10L1 | stuk | 2819,00 | 320 | 1 |
|---------|----------------|----------|--------------|------|---------|-----|---|



meubelset 100cm m. greep m. spiegel

| | | | | | | | |
|---------|---------|----------|-------------|------|---------|-----|---|
| 1000934 | m. deur | wit/alu. | SS11ASIR131 | stuk | 1730,00 | 320 | 1 |
|---------|---------|----------|-------------|------|---------|-----|---|

| | | | | | | | |
|---------|----------|----------|-------------|------|---------|-----|---|
| 1001124 | m. laden | wit/alu. | SS11ASIR191 | stuk | 1882,00 | 320 | 1 |
|---------|----------|----------|-------------|------|---------|-----|---|



meubelset 100cm m. greep m. spiegelkast

| | | | | | | | |
|---------|---------|----------|-------------|------|---------|-----|---|
| 1000942 | m. deur | wit/alu. | SS11ASIR141 | stuk | 2029,00 | 320 | 1 |
|---------|---------|----------|-------------|------|---------|-----|---|

| | | | | | | | |
|---------|----------|----------|-------------|------|---------|-----|---|
| 1001132 | m. laden | wit/alu. | SS11ASIR201 | stuk | 2180,00 | 320 | 1 |
|---------|----------|----------|-------------|------|---------|-----|---|



meubelset 170cm m. greep m. spiegel

| | | | | | | | |
|---------|---------------|----------|--------------|------|---------|-----|---|
| 1000969 | links m. deur | wit/alu. | SS11ASIR15L1 | stuk | 2755,00 | 320 | 1 |
|---------|---------------|----------|--------------|------|---------|-----|---|

| | | | | | | | |
|---------|----------------|----------|--------------|------|---------|-----|---|
| 1001159 | links m. laden | wit/alu. | SS11ASIR21L1 | stuk | 2906,00 | 320 | 1 |
|---------|----------------|----------|--------------|------|---------|-----|---|

| | | | | | | | |
|---------|----------------|----------|--------------|------|---------|-----|---|
| 1000950 | rechts m. deur | wit/alu. | SS11ASIR15R1 | stuk | 2755,00 | 320 | 1 |
|---------|----------------|----------|--------------|------|---------|-----|---|

| | | | | | | | |
|---------|-----------------|----------|--------------|------|---------|-----|---|
| 1001140 | rechts m. laden | wit/alu. | SS11ASIR21R1 | stuk | 2906,00 | 320 | 1 |
|---------|-----------------|----------|--------------|------|---------|-----|---|



meubelset 170cm m. greep m. spiegelkast

| | | | | | | | |
|---------|---------------|----------|--------------|------|---------|-----|---|
| 1000985 | links m. deur | wit/alu. | SS11ASIR16L1 | stuk | 3054,00 | 320 | 1 |
|---------|---------------|----------|--------------|------|---------|-----|---|

| | | | | | | | |
|---------|----------------|----------|--------------|------|---------|-----|---|
| 1001175 | links m. laden | wit/alu. | SS11ASIR22L1 | stuk | 3205,00 | 320 | 1 |
|---------|----------------|----------|--------------|------|---------|-----|---|

| | | | | | | | |
|---------|----------------|----------|--------------|------|---------|-----|---|
| 1000977 | rechts m. deur | wit/alu. | SS11ASIR16R1 | stuk | 3054,00 | 320 | 1 |
|---------|----------------|----------|--------------|------|---------|-----|---|

| | | | | | | | |
|---------|-----------------|----------|--------------|------|---------|-----|---|
| 1001167 | rechts m. laden | wit/alu. | SS11ASIR22R1 | stuk | 3205,00 | 320 | 1 |
|---------|-----------------|----------|--------------|------|---------|-----|---|



meubelset 130cm m. greep m. spiegel

| | | | | | | | |
|---------|---------|----------|-------------|------|---------|-----|---|
| 1000993 | m. deur | wit/alu. | SS11ASIR251 | stuk | 2109,00 | 320 | 1 |
|---------|---------|----------|-------------|------|---------|-----|---|

| | | | | | | | |
|---------|----------|----------|-------------|------|---------|-----|---|
| 1001183 | m. laden | wit/alu. | SS11ASIR311 | stuk | 2371,00 | 320 | 1 |
|---------|----------|----------|-------------|------|---------|-----|---|



| Art.nr | Specificaties | Kleur | Lev.nr | Ehd | Prijs | Grp | CC |
|--------|---------------|-------|--------|-----|-------|-----|----|
|--------|---------------|-------|--------|-----|-------|-----|----|

Schock Siro

meubelset 130cm m. greep m. spiegelkast

| | | | | | | | |
|---------|----------|----------|-------------|------|---------|-----|---|
| 1001000 | m. deur | wit/alu. | SSI1ASIR261 | stuk | 2616,00 | 320 | 1 |
| 1001191 | m. laden | wit/alu. | SSI1ASIR321 | stuk | 2879,00 | 320 | 1 |



Sanitair producten

Baden /
douchebakken /
stoomcabines

meubelset 200cm m. greep m. spiegel

| | | | | | | | |
|---------|-----------------|----------|--------------|------|---------|-----|---|
| 1001019 | rechts m. deur | wit/alu. | SSI1ASIR27R1 | stuk | 3134,00 | 320 | 1 |
| 1001205 | rechts m. laden | wit/alu. | SSI1ASIR33R1 | stuk | 3396,00 | 320 | 1 |
| 1001027 | links m. deur | wit/alu. | SSI1ASIR27L1 | stuk | 3134,00 | 320 | 1 |
| 1001213 | links m. laden | wit/alu. | SSI1ASIR33L1 | stuk | 3396,00 | 320 | 1 |



Kranen

Douchegarnituur

meubelset 200cm m. greep m. spiegelkast

| | | | | | | | |
|---------|-----------------|----------|--------------|------|---------|-----|---|
| 1001035 | rechts m. deur | wit/alu. | SSI1ASIR28R1 | stuk | 3641,00 | 320 | 1 |
| 1001221 | rechts m. laden | wit/alu. | SSI1ASIR34R1 | stuk | 3903,00 | 320 | 1 |
| 1001043 | links m. deur | wit/alu. | SSI1ASIR28L1 | stuk | 3641,00 | 320 | 1 |
| 1001248 | links m. laden | wit/alu. | SSI1ASIR34L1 | stuk | 3903,00 | 320 | 1 |



Accessoires en
spiegels

Schock Viva

meubelset 80cm m. spiegel

| | | | | | | | |
|---------|--|------------|---------------|------|---------|-----|---|
| 0992774 | | wit/chroom | SV01WVIV1939 | stuk | 1674,00 | 320 | 1 |
| 0992775 | | perg./chr. | SV02PVIV19974 | stuk | 1674,00 | 320 | 1 |

Douchewanden

meubelset 80cm m. spiegelkast

| | | | | | | | |
|---------|--|------------|---------------|------|---------|-----|---|
| 0992776 | | wit/chroom | SV01WVIV2039 | stuk | 1909,00 | 320 | 1 |
| 0992777 | | perg./chr. | SV02PVIV20974 | stuk | 1909,00 | 320 | 1 |

Toebehoren &
afvoeren

meubelset 100cm m. spiegel

| | | | | | | | |
|---------|--|------------|---------------|------|---------|-----|---|
| 0992778 | | wit/chroom | SV01WVIV2139 | stuk | 2028,00 | 320 | 1 |
| 0992779 | | perg./chr. | SV02PVIV21974 | stuk | 2028,00 | 320 | 1 |

Spoel- &
installatiesystemen

meubelset 100cm m. spiegelkast

| | | | | | | | |
|---------|--|------------|---------------|------|---------|-----|---|
| 0992780 | | wit/chroom | SV01WVIV2239 | stuk | 2351,00 | 320 | 1 |
| 0992781 | | perg./chr. | SV02PVIV22974 | stuk | 2351,00 | 320 | 1 |

Badkamermeubelen
en toiletkasten

meubelset 130cm m. spiegel

| | | | | | | | |
|---------|--|------------|---------------|------|---------|-----|---|
| 0992782 | | wit/chroom | SV01WVIV2439 | stuk | 2524,00 | 320 | 1 |
| 0992783 | | perg./chr. | SV02PVIV24974 | stuk | 2524,00 | 320 | 1 |

meubelset 130cm m. spiegelkast

| | | | | | | | |
|---------|--|------------|---------------|------|---------|-----|---|
| 0992784 | | wit/chroom | SV01WVIV2539 | stuk | 2886,00 | 320 | 1 |
| 0992785 | | perg./chr. | SV02PVIV25974 | stuk | 2886,00 | 320 | 1 |

Gootstenen en
wastroggen

meubelset 152cm m. spiegel

| | | | | | | | |
|---------|--------|------------|----------------|------|---------|-----|---|
| 0992786 | links | wit/chroom | SV01WVIV23L39 | stuk | 2865,00 | 320 | 1 |
| 0992787 | links | perg./chr. | SV02PVIV23L974 | stuk | 2865,00 | 320 | 1 |
| 0992788 | rechts | wit/chroom | SV01WVIV23R39 | stuk | 2865,00 | 320 | 1 |
| 0992789 | rechts | perg./chr. | SV02PVIV23R974 | stuk | 2865,00 | 320 | 1 |

Utiliteit

meubelset 150cm

| | | | | | | | |
|---------|--------|----------------|----------------|------|---------|-----|---|
| 0992658 | links | mat-wit/chr. | SV01WVIV01L39 | stuk | 2693,00 | 320 | 1 |
| 0992623 | links | mat-perg./chr. | SV02PVIV01L974 | stuk | 2693,00 | 320 | 1 |
| 0992666 | rechts | mat-wit/chr. | SV01WVIV01R39 | stuk | 2693,00 | 320 | 1 |
| 0992631 | rechts | mat-perg./chr. | SV02PVIV01R974 | stuk | 2693,00 | 320 | 1 |
| 0992682 | links | mat-wit/chr. | SV01WVIV16L39 | stuk | 2959,00 | 320 | 1 |
| 0992704 | links | mat-perg./chr. | SV02PVIV16L974 | stuk | 2959,00 | 320 | 1 |
| 0992674 | rechts | mat-wit/chr. | SV01WVIV16R39 | stuk | 2959,00 | 320 | 1 |
| 0992690 | rechts | mat-perg./chr. | SV02PVIV16R974 | stuk | 2959,00 | 320 | 1 |



| Art.nr | Specificaties | Kleur | Lev.nr | Ehd | Prijs | Grp | CC |
|--------|---------------|-------|--------|-----|-------|-----|----|
|--------|---------------|-------|--------|-----|-------|-----|----|

Schock Viva

meubelset 170cm



| | | | | | | | |
|---------|--------|----------------|----------------|------|---------|-----|---|
| 0992720 | links | mat-wit/chr. | SV01WVIV06L39 | stuk | 3032,00 | 320 | 1 |
| 0992712 | links | mat-perg./chr. | SV02PVIV06L974 | stuk | 3032,00 | 320 | 1 |
| 0992747 | rechts | mat-wit/chr. | SV01WVIV06R39 | stuk | 3032,00 | 320 | 1 |
| 0992739 | rechts | mat-perg./chr. | SV02PVIV06R974 | stuk | 3032,00 | 320 | 1 |
| 0992763 | links | mat-wit/chr. | SV01WVIV17L39 | stuk | 3385,00 | 320 | 1 |
| 0992755 | links | mat-perg./chr. | SV02PVIV17L974 | stuk | 3385,00 | 320 | 1 |
| 0992798 | rechts | mat-wit/chr. | SV01WVIV17R39 | stuk | 3385,00 | 320 | 1 |
| 0992771 | rechts | mat-perg./chr. | SV02PVIV17R974 | stuk | 3385,00 | 320 | 1 |

Schock Vivo

hoekmeubel

| | | | | | | | | |
|---------|------|--------|--------|--------------------|------|--------|-----|---|
| 0990287 | 45cm | links | wit | K550/500SET45VIL39 | stuk | 921,00 | 320 | 1 |
| 0990289 | 45cm | links | essen | 45VIL52 | stuk | 921,00 | 320 | 1 |
| 0990291 | 45cm | links | ahorn | K557/407SET45VIL39 | stuk | 921,00 | 320 | 1 |
| 0990293 | 45cm | links | peren | K558/408SET45VIL39 | stuk | 921,00 | 320 | 1 |
| 0990295 | 45cm | links | kersen | K559/499SET45VIL39 | stuk | 921,00 | 320 | 1 |
| 0990288 | 45cm | rechts | wit | K550/500SET45VIR39 | stuk | 921,00 | 320 | 1 |
| 0990290 | 45cm | rechts | essen | 45VIR52 | stuk | 921,00 | 320 | 1 |
| 0990292 | 45cm | rechts | ahorn | K557/407SET45VIR39 | stuk | 921,00 | 320 | 1 |
| 0990294 | 45cm | rechts | peren | K558/408SET45VIR39 | stuk | 921,00 | 320 | 1 |
| 0990296 | 45cm | rechts | kersen | K559/499SET45VIR39 | stuk | 921,00 | 320 | 1 |

hoge kast

| | | | | | | | | |
|---------|----------|--------|-----------|-----------------|------|--------|-----|---|
| 0990321 | 20cm | links | ahorn | K557/407HS2099L | stuk | 305,00 | 320 | 1 |
| 0990306 | 20cm | links | essen | 52HS2099L | stuk | 305,00 | 320 | 1 |
| 0990375 | 20cm | links | kersen | K559/499HS2099L | stuk | 305,00 | 320 | 1 |
| 0990327 | 20cm | links | peren | K558/408HS2099L | stuk | 305,00 | 320 | 1 |
| 0990297 | 20cm | links | wit | K550/500HS2099L | stuk | 305,00 | 320 | 1 |
| 0990405 | 176x20cm | links | aluminium | HS2099L | stuk | 305,00 | 320 | 1 |
| 0990322 | 20cm | rechts | ahorn | K557/407HS2099R | stuk | 305,00 | 320 | 1 |
| 0990307 | 20cm | rechts | essen | 52HS2099R | stuk | 305,00 | 320 | 1 |
| 0990376 | 20cm | rechts | kersen | K559/499HS2099R | stuk | 305,00 | 320 | 1 |
| 0990328 | 20cm | rechts | peren | K558/408HS2099R | stuk | 305,00 | 320 | 1 |
| 0990298 | 20cm | rechts | wit | K550/500HS2099R | stuk | 305,00 | 320 | 1 |
| 0990406 | 176x20cm | rechts | aluminium | HS2099R | stuk | 305,00 | 320 | 1 |
| 0990323 | 30cm | links | ahorn | K557/407HS3099L | stuk | 321,00 | 320 | 1 |
| 0990308 | 30cm | links | essen | 52HS3099L | stuk | 321,00 | 320 | 1 |
| 0990377 | 30cm | links | kersen | K559/499HS3099L | stuk | 321,00 | 320 | 1 |
| 0990330 | 30cm | links | peren | K558/408HS3099L | stuk | 321,00 | 320 | 1 |
| 0990300 | 30cm | links | wit | K550/500HS3099L | stuk | 321,00 | 320 | 1 |
| 0990407 | 176x30cm | links | aluminium | HS3099L | stuk | 321,00 | 320 | 1 |
| 0990324 | 30cm | rechts | ahorn | K557/407HS3099R | stuk | 321,00 | 320 | 1 |
| 0990309 | 30cm | rechts | essen | 52HS3099R | stuk | 321,00 | 320 | 1 |
| 0990378 | 30cm | rechts | kersen | K559/499HS3099R | stuk | 321,00 | 320 | 1 |
| 0990331 | 30cm | rechts | peren | K558/408HS3099R | stuk | 321,00 | 320 | 1 |
| 0990301 | 30cm | rechts | wit | K550/500HS3099R | stuk | 321,00 | 320 | 1 |
| 0990408 | 176x30cm | rechts | aluminium | HS3099R | stuk | 321,00 | 320 | 1 |
| 0990325 | 40cm | links | ahorn | K557/407HS4099L | stuk | 336,00 | 320 | 1 |
| 0990319 | 40cm | links | essen | 52HS4099L | stuk | 336,00 | 320 | 1 |
| 0990379 | 40cm | links | kersen | K559/499HS4099L | stuk | 336,00 | 320 | 1 |
| 0990332 | 40cm | links | peren | K558/408HS4099L | stuk | 336,00 | 320 | 1 |
| 0990304 | 40cm | links | wit | K550/500HS4099L | stuk | 336,00 | 320 | 1 |
| 0990409 | 176x40cm | links | aluminium | HS4099L | stuk | 336,00 | 320 | 1 |
| 0990326 | 40cm | rechts | ahorn | K557/407HS4099R | stuk | 336,00 | 320 | 1 |
| 0990320 | 40cm | rechts | essen | 52HS4099R | stuk | 336,00 | 320 | 1 |
| 0990380 | 40cm | rechts | kersen | K559/499HS4099R | stuk | 336,00 | 320 | 1 |
| 0990373 | 40cm | rechts | peren | K558/408HS4099R | stuk | 336,00 | 320 | 1 |
| 0990305 | 40cm | rechts | wit | K550/500HS4099R | stuk | 336,00 | 320 | 1 |
| 0990410 | 176x40cm | rechts | aluminium | HS4099R | stuk | 336,00 | 320 | 1 |

| Art.nr | Specificaties | Kleur | Lev.nr | Ehd | Prijs | Grp | CC |
|------------------------------|---------------|------------------|------------------|------|---------|-----|----|
| Schock Chico | | | | | | | |
| halfhoge kast | | | | | | | |
| 0934416 | 35cm links | wit | C20500UH3586L | stuk | 626,00 | 320 | 1 |
| 0934417 | 35cm links | wit/alu. | C30500UH3586L | stuk | 626,00 | 320 | 1 |
| 0934418 | 35cm links | pergamon | C21560UH3586L | stuk | 626,00 | 320 | 1 |
| 0934419 | 35cm links | perg./alu. | C31560UH3586L | stuk | 626,00 | 320 | 1 |
| 0934420 | 35cm links | peren | C24408UH3586L | stuk | 626,00 | 320 | 1 |
| 0934421 | 35cm links | peren/alu. | C34408UH3586L | stuk | 626,00 | 320 | 1 |
| 0934422 | 35cm rechts | wit | C20500UH3586R | stuk | 626,00 | 320 | 1 |
| 0934423 | 35cm rechts | wit/alu. | C30500UH3586R | stuk | 626,00 | 320 | 1 |
| 0934424 | 35cm rechts | pergamon | C21560UH3586R | stuk | 626,00 | 320 | 1 |
| 0934425 | 35cm rechts | perg./alu. | C31560UH3586R | stuk | 626,00 | 320 | 1 |
| 0934426 | 35cm rechts | peren | C24408UH3586R | stuk | 626,00 | 320 | 1 |
| 0934427 | 35cm rechts | peren/alu. | C34408UH3586R | stuk | 626,00 | 320 | 1 |
| 0990254 | 50cm links | wit/wit | C20500MHS5080L | stuk | 456,00 | 320 | 1 |
| 0990267 | 50cm links | perg/perg | C21560MHS5080L | stuk | 456,00 | 320 | 1 |
| 0990271 | 50cm links | peren/peren | C24408MHS5080L | stuk | 456,00 | 320 | 1 |
| 0990265 | 50cm links | wit/alu | C30500MHS5080L | stuk | 456,00 | 320 | 1 |
| 0990269 | 50cm links | perg/alu | C31560MHS5080L | stuk | 456,00 | 320 | 1 |
| 0990274 | 50cm links | peren/alu | C34408MHS5080L | stuk | 456,00 | 320 | 1 |
| 0990255 | 50cm rechts | wit/wit | C20500MHS5080R | stuk | 456,00 | 320 | 1 |
| 0990268 | 50cm rechts | perg/perg | C21560MHS5080R | stuk | 456,00 | 320 | 1 |
| 0990273 | 50cm rechts | peren/peren | C24408MHS5080R | stuk | 456,00 | 320 | 1 |
| 0990266 | 50cm rechts | wit/alu | C30500MHS5080R | stuk | 456,00 | 320 | 1 |
| 0990270 | 50cm rechts | perg/alu | C31560MHS5080R | stuk | 456,00 | 320 | 1 |
| 0990275 | 50cm rechts | peren/alu | C34408MHS5080R | stuk | 456,00 | 320 | 1 |
| hoge kast | | | | | | | |
| 0934403 | 35cm links | wit | C20500HS3532L | stuk | 669,00 | 320 | 1 |
| 0934404 | 35cm links | wit/alu. | C30500HS3532L | stuk | 669,00 | 320 | 1 |
| 0934405 | 35cm links | pergamon | C21560HS3532L | stuk | 669,00 | 320 | 1 |
| 0934406 | 35cm links | perg./alu. | C31560HS3532L | stuk | 669,00 | 320 | 1 |
| 0934407 | 35cm links | peren | C24408HS3532L | stuk | 669,00 | 320 | 1 |
| 0934408 | 35cm links | peren/alu. | C34408HS3532L | stuk | 669,00 | 320 | 1 |
| 0934409 | 35cm rechts | wit | C20500HS3532R | stuk | 669,00 | 320 | 1 |
| 0934411 | 35cm rechts | wit/alu. | C30500HS3532R | stuk | 669,00 | 320 | 1 |
| 0934412 | 35cm rechts | pergamon | C21560HS3532R | stuk | 669,00 | 320 | 1 |
| 0934413 | 35cm rechts | perg./alu. | C31560HS3532R | stuk | 669,00 | 320 | 1 |
| 0934414 | 35cm rechts | peren | C24408HS3532R | stuk | 669,00 | 320 | 1 |
| 0934415 | 35cm rechts | peren/alu. | C34408HS3532R | stuk | 669,00 | 320 | 1 |
| wastafel m. onderbouw | | | | | | | |
| 0934240 | 100cm | wit | C20500WUR102039 | stuk | 1133,00 | 320 | 1 |
| 0934259 | 100cm | alu./wit | C30500WUR102039 | stuk | 1133,00 | 320 | 1 |
| 0934267 | 100cm | pergamon | C21560WUR1020974 | stuk | 1133,00 | 320 | 1 |
| 0934275 | 100cm | alu./perg. | C31560WUR1020974 | stuk | 1133,00 | 320 | 1 |
| 0934283 | 100cm | perelaar/wit | C24408WUR102039 | stuk | 1133,00 | 320 | 1 |
| 0934755 | 100cm | perelaar/perg. | C24408WUR1020974 | stuk | 1133,00 | 320 | 1 |
| 0934291 | 100cm | alu./pere./wit | C34408WUR102039 | stuk | 1133,00 | 320 | 1 |
| 0934747 | 100cm | alu./pere./perg. | C34408WUR1020974 | stuk | 1133,00 | 320 | 1 |
| 0934305 | 120cm | wit | C20500WUR122039 | stuk | 1583,00 | 320 | 1 |
| 0934313 | 120cm | alu./wit | C30500WUR122039 | stuk | 1583,00 | 320 | 1 |
| 0934321 | 120cm | pergamon | C21560WUR1220974 | stuk | 1583,00 | 320 | 1 |
| 0934348 | 120cm | alu./perg. | C31560WUR1220974 | stuk | 1583,00 | 320 | 1 |
| 0934739 | 120cm | perelaar/wit | C24408WUR122039 | stuk | 1583,00 | 320 | 1 |
| 0934356 | 120cm | perelaar/perg. | C24408WUR1220974 | stuk | 1583,00 | 320 | 1 |
| 0934720 | 120cm | alu./pere./wit | C34408WUR122039 | stuk | 1583,00 | 320 | 1 |
| 0934364 | 120cm | alu./pere./perg. | C34408WUR1220974 | stuk | 1583,00 | 320 | 1 |
| spiegelkast 100cm | | | | | | | |
| 0934372 | | wit | C20500SPS100B | stuk | 1083,00 | 320 | 1 |
| 0934380 | | alu./wit | C30500SPS100B | stuk | 1083,00 | 320 | 1 |
| 0934399 | | pergamon | C21560SPS100B | stuk | 1083,00 | 320 | 1 |
| 0934402 | | alu./perg. | C31560SPS100B | stuk | 1083,00 | 320 | 1 |
| 0934410 | | perelaar | C24408SPS100B | stuk | 1083,00 | 320 | 1 |
| 0934429 | | alu./perelaar | C34408SPS100B | stuk | 1083,00 | 320 | 1 |
| spiegelkast 120cm | | | | | | | |
| 0934437 | | wit | C20500SPS120B | stuk | 1366,00 | 320 | 1 |
| 0934445 | | alu./wit | C30500SPS120B | stuk | 1366,00 | 320 | 1 |
| 0934453 | | pergamon | C21560SPS120B | stuk | 1366,00 | 320 | 1 |
| 0934461 | | alu./perg. | C31560SPS120B | stuk | 1366,00 | 320 | 1 |
| 0934488 | | perelaar | C24408SPS120B | stuk | 1366,00 | 320 | 1 |
| 0934496 | | alu./perelaar | C34408SPS120B | stuk | 1366,00 | 320 | 1 |

Sanitair producten

Baden /
douchebakken /
stoomcabines

Kranen

Douchegarnituur

Accessoires en
spiegels

Douchewanden

Toebehoren &
afvoeren

Spoel- &
installatiesystemen

Badkamermeubelen
en toiletkasten

Gootstenen en
wastroggen

Utiliteit



| | Art.nr | Specificaties | Kleur | Lev.nr | Ehd | Prijs | Grp | CC | |
|---|--|--|-------------------|-------------------|-------------------|---------|---------|-----|---|
| Schock Chico | | | | | | | | | |
| meubelset 100cm | | | | | | | | | |
| Sanitair producten | 0934518 | | wit | C20500GRC100B39 | stuk | 2216,00 | 320 | 1 | |
| | 0934526 | | alu./wit | C30500GRC100B39 | stuk | 2216,00 | 320 | 1 | |
| | 0934534 | | pergamon | C21560GRC100B974 | stuk | 2216,00 | 320 | 1 | |
| | 0934542 | | alu./perg. | C31560GRC100B974 | stuk | 2216,00 | 320 | 1 | |
| | 0934712 | | perelaar/wit | C24408GRC100B39 | stuk | 2216,00 | 320 | 1 | |
| | 0934550 | | perelaar/perg. | C24408GRC100B974 | stuk | 2216,00 | 320 | 1 | |
| | 0934704 | | alu./pere./wit | C34408GRC100B39 | stuk | 2216,00 | 320 | 1 | |
| Baden / douchebakken / stoomcabines | 0934569 | | alu./pere./perg. | C34408GRC100B974 | stuk | 2216,00 | 320 | 1 | |
| | meubelset 120cm | | | | | | | | |
| | Kranen | 0934577 | | wit | C20500GRC120B39 | stuk | 2948,00 | 320 | 1 |
| | | 0934585 | | alu./wit | C30500GRC120B39 | stuk | 2948,00 | 320 | 1 |
| | | 0934593 | | pergamon | C21560GRC120B974 | stuk | 2948,00 | 320 | 1 |
| | | 0934607 | | alu./perg. | C31560GRC120B974 | stuk | 2948,00 | 320 | 1 |
| | | 0934690 | | perelaar/wit | C24408GRC120B39 | stuk | 2948,00 | 320 | 1 |
| 0934615 | | | perelaar/perg. | C24408GRC120B974 | stuk | 2948,00 | 320 | 1 | |
| 0934623 | | | alu./pere./wit | C34408GRC120B39 | stuk | 2948,00 | 320 | 1 | |
| Douchegarnituur | 0934682 | | alu./pere./perg. | C34408GRC120B974 | stuk | 2948,00 | 320 | 1 | |
| | handdoekhouder | | | | | | | | |
| | Accessoires en spiegels | 0934631 | rechts | chrom | HHC1020R28 | stuk | 68,00 | 320 | 1 |
| | | 0934666 | rechts | matchroom | HHC1020R12 | stuk | 74,00 | 320 | 1 |
| | | 0934658 | links | chrom | HHC1020L28 | stuk | 68,00 | 320 | 1 |
| | | 0934674 | links | matchroom | HHC1020L12 | stuk | 74,00 | 320 | 1 |
| | Douchewanden | Schock Quant | | | | | | | |
| meubelset 120cm m. spiegel | | | | | | | | | |
| Toebehoren & afvoeren | | 0993360 | | wit/peren/chr. | N391GQL120E39Q41 | stuk | 2723,00 | 320 | 1 |
| | | 0993379 | | alu./peren/chr. | N396GQL120E39Q41 | stuk | 2723,00 | 320 | 1 |
| | | 0998451 | | perg./peren/chr. | N392GQL120E974Q41 | stuk | 2723,00 | 320 | 1 |
| | | 0998419 | | wit/kersen/chr. | N491GQL120E39Q41 | stuk | 2723,00 | 320 | 1 |
| | | 0998427 | | alu./kersen/chr. | N496GQL120E39Q41 | stuk | 2723,00 | 320 | 1 |
| | 0998478 | | perg./kersen/chr. | N492GQL120E974Q41 | stuk | 2723,00 | 320 | 1 | |
| | Spoel- & installatiesystemen | meubelset 120cm m. spiegelkast | | | | | | | |
| 0993387 | | | wit/peren/chr. | N391GQS120E39Q41 | stuk | 3244,00 | 320 | 1 | |
| 0993395 | | | alu./peren/chr. | N396GQS120E39Q41 | stuk | 3244,00 | 320 | 1 | |
| 0998486 | | | perg./peren/chr. | N392GQS120E974Q41 | stuk | 3244,00 | 320 | 1 | |
| 0998435 | | | wit/kersen/chr. | N491GQS120E39Q41 | stuk | 3244,00 | 320 | 1 | |
| 0998494 | | | perg./kersen/chr. | N492GQS120E974Q41 | stuk | 3244,00 | 320 | 1 | |
| 0998443 | | | alu./kersen/chr. | N496GQS120E39Q41 | stuk | 3244,00 | 320 | 1 | |
| Badkamermeubelen en toiletkasten | meubelset 160cm dubbel m. spiegel | | | | | | | | |
| | Gootstenen en wastroggen | 0993409 | | wit/peren/chr. | N391GQL160E39Q41 | stuk | 2977,00 | 320 | 1 |
| | | 0993417 | | alu./peren/chr. | N396GQL160E39Q41 | stuk | 2977,00 | 320 | 1 |
| | | 0998532 | | perg./peren/chr. | N392GQL160E974Q41 | stuk | 2977,00 | 320 | 1 |
| | | 0998508 | | wit/kersen/chr. | N491GQL160E39Q41 | stuk | 2977,00 | 320 | 1 |
| | | 0998540 | | perg./kersen/chr. | N492GQL160E974Q41 | stuk | 2977,00 | 320 | 1 |
| | | 0998516 | | alu./kersen/chr. | N496GQL160E39Q41 | stuk | 2977,00 | 320 | 1 |
| Utiliteit | | meubelset 160cm dubbel m. spiegelkast | | | | | | | |
| | 0993425 | | wit/peren/chr. | N391GQS160E39Q41 | stuk | 3536,00 | 320 | 1 | |
| | 0993433 | | alu./peren/chr. | N396GQS160E39Q41 | stuk | 3536,00 | 320 | 1 | |
| | 0998559 | | perg./peren/chr. | N392GQS160E974Q41 | stuk | 3536,00 | 320 | 1 | |
| | 0998567 | | wit/kersen/chr. | N491GQS160E39Q41 | stuk | 3536,00 | 320 | 1 | |
| | 0998575 | | perg./kersen/chr. | N492GQS160E974Q41 | stuk | 3536,00 | 320 | 1 | |
| | 0998524 | | alu./kersen/chr. | N496GQS160E39Q41 | stuk | 3536,00 | 320 | 1 | |
| halfhoge kast | | | | | | | | | |
|  | 0993441 | links | wit/peren | N391UHE3099L | stuk | 311,00 | 320 | 1 | |
| | 0993476 | links | aluminium/peren | N396UHE3099L | stuk | 311,00 | 320 | 1 | |
| | 0998583 | links | pergamon/peren | N392UHE3099L | stuk | 311,00 | 320 | 1 | |
| | 0998621 | links | wit/kersen | N491UHE3099L | stuk | 311,00 | 320 | 1 | |
| | 0998605 | links | pergamon/kersen | N492UHE3099L | stuk | 311,00 | 320 | 1 | |
| | 0998656 | links | aluminium/kersen | N496UHE3099L | stuk | 311,00 | 320 | 1 | |
| | 0993468 | rechts | wit/peren | N391UHE3099R | stuk | 311,00 | 320 | 1 | |
| | 0993484 | rechts | aluminium/peren | N396UHE3099R | stuk | 311,00 | 320 | 1 | |
| | 0998591 | rechts | pergamon/peren | N392UHE3099R | stuk | 311,00 | 320 | 1 | |
| | 0998648 | rechts | wit/kersen | N491UHE3099R | stuk | 311,00 | 320 | 1 | |
| | 0998613 | rechts | pergamon/kersen | N492UHE3099R | stuk | 311,00 | 320 | 1 | |
| | 0998664 | rechts | aluminium/kersen | N496UHE3099R | stuk | 311,00 | 320 | 1 | |

| Art.nr | Specificaties | Kleur | Lev.nr | Ehd | Prijs | Grp | CC |
|-----------------------|---------------|------------------|--------------|------|--------|-----|----|
| Schock Quant | | | | | | | |
| lage kast | | | | | | | |
| 0993492 | links | wit/peren | N391UE3099L | stuk | 246,00 | 320 | 1 |
| 0993514 | links | aluminium/peren | N396UE3099L | stuk | 246,00 | 320 | 1 |
| 0998672 | links | pergamon/peren | N392UE3099L | stuk | 246,00 | 320 | 1 |
| 0998710 | links | wit/kersen | N491UE3099L | stuk | 246,00 | 320 | 1 |
| 0998699 | links | pergamon/kersen | N492UE3099L | stuk | 246,00 | 320 | 1 |
| 0998737 | links | aluminium/kersen | N496UE3099L | stuk | 246,00 | 320 | 1 |
| 0993506 | rechts | wit/peren | N391UE3099R | stuk | 246,00 | 320 | 1 |
| 0993522 | rechts | aluminium/peren | N396UE3099R | stuk | 246,00 | 320 | 1 |
| 0998680 | rechts | pergamon/peren | N392UE3099R | stuk | 246,00 | 320 | 1 |
| 0998729 | rechts | wit/kersen | N491UE3099R | stuk | 246,00 | 320 | 1 |
| 0998702 | rechts | pergamon/kersen | N492UE3099R | stuk | 246,00 | 320 | 1 |
| 0998745 | rechts | wit/peren | N496UE3099R | stuk | 246,00 | 320 | 1 |
| hangkast | | | | | | | |
| 0993530 | links | wit/peren | N391HME3099L | stuk | 260,00 | 320 | 1 |
| 0993557 | links | aluminium/peren | N396HME3099L | stuk | 260,00 | 320 | 1 |
| 0998753 | links | pergamon/peren | N392HME3099L | stuk | 260,00 | 320 | 1 |
| 0998818 | links | wit/kersen | N491HME3099L | stuk | 260,00 | 320 | 1 |
| 0998788 | links | pergamon/kersen | N492HME3099L | stuk | 260,00 | 320 | 1 |
| 0998834 | links | aluminium/kersen | N496HME3099L | stuk | 260,00 | 320 | 1 |
| 0993549 | rechts | wit/peren | N391HME3099R | stuk | 260,00 | 320 | 1 |
| 0993565 | rechts | aluminium/peren | N396HME3099R | stuk | 260,00 | 320 | 1 |
| 0998761 | rechts | pergamon/peren | N392HME3099R | stuk | 260,00 | 320 | 1 |
| 0998826 | rechts | wit/kersen | N491HME3099R | stuk | 260,00 | 320 | 1 |
| 0998796 | rechts | pergamon/kersen | N492HME3099R | stuk | 260,00 | 320 | 1 |
| 0998842 | rechts | aluminium/kersen | N496HME3099R | stuk | 260,00 | 320 | 1 |
| handdoekhouder | | | | | | | |
| 0999229 | links | chroom | HHQ0500L28 | stuk | 121,00 | 320 | 1 |
| 0999237 | rechts | chroom | HHQ0500R28 | stuk | 121,00 | 320 | 1 |

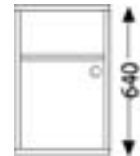

Sanitair producten

Baden /
douchebakken /
stoomcabines

Kranen

Douchegarnituur









Accessoires en
spiegels

Douchewanden

Toebehoren &
afvoerenSpoel- &
installatiesystemenBadkamermeubelen
en toiletkastenGootstenen en
wastroggen

Utiliteit

Spiegelkasten Keuco

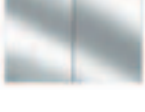
| | Art.nr | Specificaties | Kleur | Lev.nr | Ehd | Prijs | Grp | CC |
|---|---|--|---------------|-------------|------|---------|-----|----|
| Sanitair producten | Keuco Royal | | | | | | | |
| |  | Akari spiegelkast 100cm 0682348 | elox/chroom | 6301421200 | stuk | 2314,00 | 229 | 1 |
| Baden / douchebakken / stoomcabines | | Akari cosmeticaspiegel voor toiletkast 0682349 | | 6381170000 | stuk | 46,25 | 229 | 1 |
| Kranen |  | Atlanta hoekspiegelkast m. verlichting 0686077 44x99cm | zilver/zilver | 06402171201 | stuk | 1241,00 | 229 | 1 |
| Douchegarnituur | | | | | | | | |
| Accessoires en spiegels |  | Atlanta hoekspiegelkast z. verlichting 0686085 44x160cm | zilver/zilver | 06401172000 | stuk | 1263,00 | 229 | 1 |
| Douchewanden | | | | | | | | |
| Toebehoren & afvoeren |  | 10 spiegelkast m. verlichting m. 2 deuren 0680384 60cm | zilver/elox | 5402171301 | stuk | 691,00 | 229 | 1 |
| Spoel- & installatiesystemen | | | | | | | | |
| Badkamermeubelen en toiletkasten |  | 10 spiegelkast m. verlichting m. 3 deuren 0680386 90cm | zilver/elox | 5403171301 | stuk | 1002,00 | 229 | 1 |
| Gootstenen en wastroggen | | | | | | | | |
| Utiliteit |  | 20 spiegelkast 0682347 51.8x81.5cm rechts | zilver | 5501171101 | stuk | 653,00 | 229 | 1 |
| | | 0684016 51.8x81.5cm links | wit | 5501171201 | stuk | 653,00 | 229 | 1 |
| |  | 20 spiegelkast m. 2 draaideuren m. verlichting 0686093 60x85cm | zilver | 05502171301 | stuk | 808,00 | 229 | 1 |
| | | | | | | | | |
| |  | 30 spiegelkast 2xdeuren 60cm 0680002 | elox/matwit | 5601171301 | stuk | 862,00 | 229 | 0 |
| | | | | | | | | |
| |  | 30 spiegelkast 2xdeuren 80cm 0680421 | elox/matwit | 5602171301 | stuk | 862,00 | 229 | 0 |
| | | | | | | | | |

| Art.nr | Specificaties | Kleur | Lev.nr | Ehd | Prijs | Grp | CC | | |
|--|---------------|--------------|-------------|------|---------|-----|----|---|---|
| | | | | | | | | Keuco Royal | |
| 30 spiegelkast 3xdeuren 100cm 0685909 | | elox/mat wit | 05603171301 | stuk | 1239,00 | 229 | 1 |  | Sanitair producten |
| 30 spiegelkast 3xdeuren 130cm 0685917 | | elox/mat wit | 05604171301 | stuk | 1394,00 | 229 | 0 |  | Baden / douchebakken / stoomcabines |
| 30 aanbouwkast 35x160cm 0685925 | | | 5610171000 | stuk | 699,00 | 229 | 1 |  | Kranen |
| Plus spiegelkast m. verlichting 60x91cm 0685933 | | | 15001171301 | stuk | 895,00 | 229 | 1 |  | Douchegarnituur |
| Plus spiegelkast m. verlichting 60x81cm 0686115 | | zilver | 15011171301 | stuk | 888,00 | 229 | 1 |  | Accessoires en spiegels |
| Plus spiegelkast m. verlichting 80x71cm 0685941 | | | 15002171301 | stuk | 895,00 | 229 | 1 |  | Douchewanden |
| Plus spiegelkast m. verlichting 80x81cm 0686123 | | zilver | 15012171301 | stuk | 902,00 | 229 | 1 |  | Toebehoren & afvoeren |
| Plus spiegelkast m. verlichting 100x81cm 0685968 | | | 15003171301 | stuk | 1289,00 | 229 | 1 |  | Spoel- & installatiesystemen |
| Plus spiegelkast m. verlichting 130x81cm 0685976 | | | 15004171301 | stuk | 1443,00 | 229 | 1 |  | Badkamermeubelen en toiletkasten |
| T3 spiegelkast 90cm | | | | | | | | | |
| 0680024 | z. lade | | 13901171301 | stuk | 2119,00 | 229 | 1 | | |
| 0680025 | m. lade | | 13901171302 | stuk | 2256,00 | 229 | 1 | | |
| T3 spiegelkast 110cm | | | | | | | | | |
| 0680026 | z. lade | | 13902171301 | stuk | 2232,00 | 229 | 1 | | |
| 0680027 | m. lade | | 13902171302 | stuk | 2369,00 | 229 | 1 | | |

| |
|---|
| Sanitair producten |
| Baden / douchebakken / stoomcabines |
| Kranen |
| Douchegarnituur |
| Accessoires en spiegels |
| Douchewanden |
| Toebehoren & afvoeren |
| Spoel- & installatiesystemen |
| Badkamermeubelen en toiletkasten |
| Gootstenen en wastroggen |
| Utiliteit |

| | Art.nr | Specificaties | Kleur | Lev.nr | Ehd | Prijs | Grp | CC | |
|---|---|---------------|-----------------|--------------|-------------|---------|---------|-----|---|
| Schock Arcos | | | | | | | | | |
| Sanitair producten | spiegelkast 60cm m. verlichting | | | | | | | | |
| | 0990233 | | wit/chroom | 500SAF601028 | stuk | 414,00 | 320 | 1 | |
| | 0990234 | | perg.mat/chroom | 560SAF601028 | stuk | 414,00 | 320 | 1 | |
| | 0990235 | | alu/chroom | 401SAF601028 | stuk | 414,00 | 320 | 1 | |
| | 0990236 | | beuken/chroom | 410SAF601028 | stuk | 414,00 | 320 | 1 | |
| Baden / douchebakken / stoomcabines | spiegelkast 70cm m. verlichting | | | | | | | | |
| | 0990237 | | wit/chroom | 500SAF701028 | stuk | 496,00 | 320 | 1 | |
| | 0990238 | | perg.mat/chroom | 560SAF701028 | stuk | 496,00 | 320 | 1 | |
| | 0990239 | | alu/chroom | 401SAF701028 | stuk | 496,00 | 320 | 1 | |
| | 0990240 | | beuken/chroom | 410SAF701028 | stuk | 496,00 | 320 | 1 | |
| Kranen | spiegelkast 80cm m. 2spots | | | | | | | | |
| | 0998192 | | wit | 500SAF801028 | stuk | 515,00 | 320 | 1 | |
| Douchegarnituur | 0998206 | | pergamon | 560SAF801028 | stuk | 515,00 | 320 | 1 | |
| |  | | | | | | | | |
| Accessoires en spiegels | spiegelkast 90cm m. 2spots | | | | | | | | |
| | 0998214 | | wit | 500SAF901028 | stuk | 550,00 | 320 | 1 | |
| | 0998222 | | pergamon | 560SAF901028 | stuk | 550,00 | 320 | 1 | |
| Schock Aura | | | | | | | | | |
| Douchewanden | B hoge kast z. verlichting | | | | | | | | |
| | 0114464 | 40x180cm | rechts | aluminium | 401SHS4041R | stuk | 690,00 | 320 | 1 |
| | 0114480 | 40x180cm | rechts | verspiegeld | SHS4043R | stuk | 833,00 | 320 | 1 |
| | 0114472 | 40x180cm | links | aluminium | 401SHS4041L | stuk | 690,00 | 320 | 1 |
| | 0114499 | 40x180cm | links | verspiegeld | SHS4043L | stuk | 833,00 | 320 | 1 |
| Toebehoren & afvoeren | B spiegelkast m. verlichting | | | | | | | | |
| | 0114804 | 50cm | links | aluminium | 401SAF5040L | stuk | 671,00 | 320 | 1 |
| Spoel- & installatiesystemen | 0114812 | 50cm | rechts | aluminium | 401SAF5040R | stuk | 671,00 | 320 | 1 |
| | 0114820 | 60cm | links | aluminium | 401SAF6040L | stuk | 696,00 | 320 | 1 |
| | 0114839 | 60cm | rechts | aluminium | 401SAF6040R | stuk | 696,00 | 320 | 1 |
| | 0114847 | 80cm | | aluminium | 401SAF8040 | stuk | 919,00 | 320 | 1 |
| | 0114855 | 90cm | | aluminium | 401SAF9040 | stuk | 979,00 | 320 | 1 |
| | 0114863 | 100cm | | aluminium | 401SAF1040 | stuk | 1045,00 | 320 | 1 |
| Badkamermeubelen en toiletkasten | 0114871 | 130cm | | aluminium | 401SAF1340 | stuk | 1161,00 | 320 | 1 |
| | L hoge kast z. verlichting | | | | | | | | |
| | 0114448 | 40x180cm | rechts | aluminium | 401SHS4031R | stuk | 630,00 | 320 | 1 |
| | 0114456 | 40x180cm | links | aluminium | 401SHS4031L | stuk | 630,00 | 320 | 1 |
| Gootstenen en wastroggen | L spiegelkast m. verlichting | | | | | | | | |
| | 0114707 | 50cm | links | aluminium | 401SAF5030L | stuk | 616,00 | 320 | 1 |
| | 0114715 | 50cm | rechts | aluminium | 401SAF5030R | stuk | 616,00 | 320 | 1 |
| | 0114731 | 60cm | links | aluminium | 401SAF6030L | stuk | 636,00 | 320 | 1 |
| | 0114758 | 60cm | rechts | aluminium | 401SAF6030R | stuk | 636,00 | 320 | 1 |
| Utiliteit | 0114766 | 80cm | | aluminium | 401SAF8030 | stuk | 860,00 | 320 | 1 |
| | 0114782 | 90cm | | aluminium | 401SAF9030 | stuk | 921,00 | 320 | 1 |
| | 0114790 | 100cm | | aluminium | 401SAF1030 | stuk | 987,00 | 320 | 1 |
| | L spiegelkast m. verlichting nieuw | | | | | | | | |
| | 1000078 | 50cm | links | aluminium | 401SAF5070L | stuk | 616,00 | 320 | 1 |
| 1000079 | 50cm | rechts | aluminium | 401SAF5070R | stuk | 616,00 | 320 | 1 | |
| 1000080 | 60cm | links | aluminium | 401SAF6070L | stuk | 636,00 | 320 | 1 | |
| 1000081 | 60cm | rechts | aluminium | 401SAF6070R | stuk | 636,00 | 320 | 1 | |
| 1000082 | 80cm | | aluminium | 401SAF8070 | stuk | 860,00 | 320 | 1 | |
| 1000083 | 90cm | | aluminium | 401SAF9070 | stuk | 921,00 | 320 | 1 | |
| 1000084 | 100cm | | aluminium | 401SAF1070 | stuk | 987,00 | 320 | 1 | |
| B spiegelkast m. verlichting nieuw | | | | | | | | | |
| 1000085 | 50cm | links | aluminium | 401SAF5060L | stuk | 671,00 | 320 | 1 | |
| 1000086 | 50cm | rechts | aluminium | 401SAF5060R | stuk | 671,00 | 320 | 1 | |
| 1000087 | 60cm | links | aluminium | 401SAF6060L | stuk | 696,00 | 320 | 1 | |
| 1000088 | 60cm | rechts | aluminium | 401SAF6060R | stuk | 696,00 | 320 | 1 | |
| 1000089 | 80cm | | aluminium | 401SAF8060 | stuk | 919,00 | 320 | 1 | |
| 1000090 | 90cm | | aluminium | 401SAF9060 | stuk | 979,00 | 320 | 1 | |
| 1000091 | 100cm | | aluminium | 401SAF1060 | stuk | 1045,00 | 320 | 1 | |
| 1000092 | 130cm | | aluminium | 401SAF1360 | stuk | 1161,00 | 320 | 1 | |

| Art.nr | Specificaties | Kleur | Lev.nr | Ehd | Prijs | Grp | CC |
|--------|---------------|-------|--------|-----|-------|-----|----|
|--------|---------------|-------|--------|-----|-------|-----|----|

Schock Capri

spiegelkast 70cm m. 2spots

| | | | | | | | |
|---------|--|----------|------------|------|--------|-----|---|
| 0998230 | | wit | 500SCF7001 | stuk | 645,00 | 320 | 1 |
| 0998249 | | pergamon | 560SCF7001 | stuk | 645,00 | 320 | 1 |



Sanitair producten

Baden /
douchebakken /
stoomcabines

spiegelkast 100cm m. 2spots

| | | | | | | | |
|---------|--|----------|------------|------|--------|-----|---|
| 0998257 | | wit | 500SCF1001 | stuk | 807,00 | 320 | 1 |
| 0998265 | | pergamon | 560SCF1001 | stuk | 807,00 | 320 | 1 |

S spiegelkast 80cm m. 2spots

| | | | | | | | |
|---------|--|----------|------------|------|--------|-----|---|
| 0998273 | | wit | 500SCF8051 | stuk | 917,00 | 320 | 1 |
| 0998281 | | pergamon | 560SCF8051 | stuk | 917,00 | 320 | 1 |



Kranen

Douchegarnituur

S spiegelkast 100cm m. 2spots

| | | | | | | | |
|---------|--|----------|------------|------|---------|-----|---|
| 0998303 | | wit | 500SCF1051 | stuk | 1056,00 | 320 | 1 |
| 0998311 | | pergamon | 560SCF1051 | stuk | 1056,00 | 320 | 1 |



Accessoires en
spiegels

Douchewanden

Schock Luna

spiegelkast 60cm m. staaf

| | | | | | | | |
|---------|--|----------|--------------|------|--------|-----|---|
| 0998125 | | wit | 500SLF601028 | stuk | 349,00 | 320 | 0 |
| 0998133 | | pergamon | 560SLF601028 | stuk | 349,00 | 320 | 1 |



Toebehoren &
afvoeren

Spoel- &
installatiesystemen

spiegelkast 70cm m. verlichting

| | | | | | | | |
|---------|--|-----------------|--------------|------|--------|-----|---|
| 0990229 | | wit/chroom | 500SLF701028 | stuk | 469,00 | 320 | 1 |
| 0990230 | | perg.mat/chroom | 560SLF701028 | stuk | 469,00 | 320 | 1 |
| 0990231 | | alu/chroom | 401SLF701028 | stuk | 469,00 | 320 | 1 |
| 0990232 | | beuken/chroom | 410SLF701028 | stuk | 469,00 | 320 | 1 |

spiegelkast 80cm m. staaf

| | | | | | | | |
|---------|--|----------|--------------|------|--------|-----|---|
| 0998141 | | wit | 500SLF801028 | stuk | 493,00 | 320 | 1 |
| 0998168 | | pergamon | 560SLF801028 | stuk | 493,00 | 320 | 1 |



Badkamermeubelen
en toiletkasten

Gootstenen en
wastroggen

spiegelkast 90cm m. staaf

| | | | | | | | |
|---------|--|----------|--------------|------|--------|-----|---|
| 0998176 | | wit | 500SLF901028 | stuk | 518,00 | 320 | 1 |
| 0998184 | | pergamon | 560SLF901028 | stuk | 518,00 | 320 | 1 |

Utiliteit

Schock Nice

spiegelkast m. lichtbord

| | | | | | | | |
|---------|------------------|-----|---------|------|---------|-----|---|
| 0990243 | 60cm | alu | SPSNB06 | stuk | 966,00 | 320 | 1 |
| 0990244 | 80cm m. 2 deuren | alu | SPSNB08 | stuk | 1074,00 | 320 | 1 |
| 0990245 | 80cm m. 3 deuren | alu | SPSNB38 | stuk | 1291,00 | 320 | 1 |
| 0990246 | 120cm | alu | SPSNB12 | stuk | 1616,00 | 320 | 1 |

spiegelkast m. TL verlichting

| | | | | | | | |
|---------|------------------|-----|---------|------|---------|-----|---|
| 0990247 | 60cm | alu | SPSNL06 | stuk | 966,00 | 320 | 1 |
| 0990397 | 80cm m. 2 deuren | alu | SPSNL08 | stuk | 1074,00 | 320 | 1 |
| 0990398 | 80cm m. 3 deuren | alu | SPSNL38 | stuk | 1291,00 | 320 | 1 |
| 0990399 | 120cm | alu | SPSNL12 | stuk | 1616,00 | 320 | 1 |

spiegelkast m. aluminium spots

| | | | | | | | |
|---------|------------------|-----|---------|------|---------|-----|---|
| 0990400 | 60cm | alu | SPSNS06 | stuk | 966,00 | 320 | 1 |
| 0990401 | 80cm m. 2 deuren | alu | SPSNS08 | stuk | 1074,00 | 320 | 1 |
| 0990402 | 80cm m. 3 deuren | alu | SPSNS38 | stuk | 1291,00 | 320 | 1 |
| 0990403 | 120cm | alu | SPSNS12 | stuk | 1616,00 | 320 | 1 |

radio voor aluminium spiegelkast

| | | | | | | | |
|---------|--|--|---------|------|--------|-----|---|
| 0990404 | | | RAD0092 | stuk | 159,00 | 320 | 1 |
|---------|--|--|---------|------|--------|-----|---|

Spiegelkasten Schock

| | Art.nr | Specificaties | Kleur | Lev.nr | Ehd | Prijs | Grp | CC |
|---|---|---------------|----------------|----------------|------|---------|-----|----|
| | Schock Nice | | | | | | | |
| | hoge kast | | | | | | | |
| Sanitair producten | 0990241 | 176cm links | aluminium | HSN0400L | stuk | 748,00 | 320 | 1 |
| | 0990242 | 176cm rechts | aluminium | HSN0400R | stuk | 748,00 | 320 | 1 |
| | Schock Rigo | | | | | | | |
| | spiegelkast | | | | | | | |
| Baden / douchebakken / stoomcabines | 0991450 | 40cm rechts | aluminium | 401SRF0400R | stuk | 274,00 | 320 | 1 |
| | 0991451 | 40cm links | aluminium | 401SRF0400L | stuk | 274,00 | 320 | 1 |
| | 0991452 | 50cm rechts | aluminium | 401SRF0500R | stuk | 285,00 | 320 | 1 |
| | 0991453 | 50cm links | aluminium | 401SRF0500L | stuk | 285,00 | 320 | 1 |
| Kranen | 0991454 | 60cm | aluminium | 401SRF0600 | stuk | 328,00 | 320 | 1 |
| | 0991455 | 70cm | aluminium | 401SRF0700 | stuk | 392,00 | 320 | 1 |
| | 0991456 | 80cm | aluminium | 401SRF0800 | stuk | 433,00 | 320 | 1 |
| | Schock Siro | | | | | | | |
| | spiegelkast m. verlichting edelmat | | | | | | | |
| Douchegarnituur | 1000829 | 80x60cm | wit/alu. | SS11ASPF806012 | stuk | 849,00 | 320 | 1 |
| | 1000837 | 100x60cm | wit/alu. | SS11ASPF106012 | stuk | 874,00 | 320 | 1 |
| | 1000845 | 130x60cm | wit/alu. | SS11ASPF136012 | stuk | 1216,00 | 320 | 1 |
| | spiegelkast m. verlichting | | | | | | | |
| Accessoires en spiegels | 0114502 | 100cm | chromium/wit | K10SPF106028 | stuk | 874,00 | 320 | 1 |
| | 0114510 | 100cm | chromium/perg. | K12SPF106028 | stuk | 874,00 | 320 | 1 |
| | 0114529 | 130cm | chromium/wit | K10SPF136028 | stuk | 1216,00 | 320 | 1 |
| | 0114537 | 130cm | chromium/perg. | K12SPF136028 | stuk | 1216,00 | 320 | 1 |
| | Schock Verto | | | | | | | |
| | spiegelkast | | | | | | | |
| | 0991458 | 60cm | aluminium | 401SVF0600 | stuk | 543,00 | 320 | 1 |
| | 0991459 | 70cm | aluminium | 401SVF0700 | stuk | 582,00 | 320 | 1 |
| Toebehoren & afvoeren | 0991460 | 80cm | aluminium | 401SVF0800 | stuk | 689,00 | 320 | 1 |
| | 0991461 | 90cm | aluminium | 401SVF0900 | stuk | 744,00 | 320 | 1 |
| | 0991462 | 100cm | aluminium | 401SVF1000 | stuk | 784,00 | 320 | 1 |
| Spoel- & installatiesystemen | | | | | | | | |
| Badkamermeubelen en toiletkasten | | | | | | | | |
| Gootstenen en wastroggen | | | | | | | | |
| Utiliteit | | | | | | | | |

| Art.nr | Specificaties | Kleur | Lev.nr | Ehd | Prijs | Grp | CC |
|--------|---------------|-------|--------|-----|-------|-----|----|
|--------|---------------|-------|--------|-----|-------|-----|----|

Schneider ClassicPlus

HSPplus/UP spiegel voor inbouw in nis

| | | | | | | | |
|---------|------------------------|-----------|--------|------|--------|-----|---|
| 2000165 | 60x90cm m. 2 TL buizen | aluminium | 121430 | stuk | 598,00 | 311 | 1 |
| 2000166 | 75x90cm m. 2 TL buizen | aluminium | 121431 | stuk | 611,00 | 311 | 1 |
| 2000167 | 90x90cm m. 2 TL buizen | aluminium | 121432 | stuk | 649,00 | 311 | 1 |

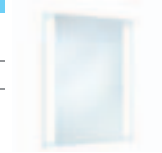

Sanitair producten

Baden /
douchebakken /
stoomcabines

Kranen

Douchegarnituur

Accessoires en
spiegels**HSPplus/GM zijkast m. deur matglas**

| | | | | | | | |
|---------|--------|-----------|--------|------|--------|-----|---|
| 2000168 | links | aluminium | 121410 | stuk | 353,00 | 311 | 1 |
| 2000169 | rechts | aluminium | 121411 | stuk | 353,00 | 311 | 1 |



Douchewanden

Toebehoren &
afvoerenSpoel- &
installatiesystemenBadkamermeubelen
en toiletkastenGootstenen en
wastroggen

Utiliteit

Schneider Flexline

FLS/HS 35 hoge kast m. 1 deur

| | | | | | | | |
|---------|----------|-----------|--------|------|--------|-----|---|
| 2000138 | 160x35cm | aluminium | 114035 | stuk | 594,00 | 311 | 1 |
|---------|----------|-----------|--------|------|--------|-----|---|



Schneider HipLine

HIP 60/2/HAL spiegelkast 2-deurs m. halogeenverlichting

| | | | | | | | |
|---------|---------|-----------|--------|------|--------|-----|---|
| 2000114 | 60x78cm | aluminium | 117161 | stuk | 728,00 | 311 | 1 |
|---------|---------|-----------|--------|------|--------|-----|---|

**HIP 80/HAL spiegelkast 2-deurs m. halogeenverlichting**

| | | | | | | | |
|---------|---------|-----------|--------|------|--------|-----|---|
| 2000115 | 80x78cm | aluminium | 117180 | stuk | 836,00 | 311 | 1 |
|---------|---------|-----------|--------|------|--------|-----|---|

**HIP 100/HAL spiegelkast 3-deurs m. halogeenverlichting**

| | | | | | | | |
|---------|----------|-----------|--------|------|---------|-----|---|
| 2000116 | 100x78cm | aluminium | 117200 | stuk | 1006,00 | 311 | 1 |
|---------|----------|-----------|--------|------|---------|-----|---|



**HIP 120/3/HAL spiegelkast 3-deurs m. halogeenverlichting**

| | | | | | | | |
|---------|----------|-----------|--------|------|---------|-----|---|
| 2000117 | 120x78cm | aluminium | 117221 | stuk | 1064,00 | 311 | 1 |
|---------|----------|-----------|--------|------|---------|-----|---|

**HIP 130/HAL spiegelkast 3-deurs m. halogeenverlichting**

| | | | | | | | |
|---------|----------|-----------|--------|------|---------|-----|---|
| 2000118 | 130x78cm | aluminium | 117230 | stuk | 1126,00 | 311 | 1 |
|---------|----------|-----------|--------|------|---------|-----|---|



| | Art.nr | Specificaties | Kleur | Lev.nr | Ehd | Prijs | Grp | CC |
|---|---|---|-----------|--------|------|--------|-----|----|
| Sanitair producten | Schneider Peakline | | | | | | | |
| |  | PKS 50/HAL spiegelkast m. halogeen verlichting 2000119 50x80cm | aluminium | 104050 | stuk | 709,00 | 311 | 1 |
| Baden / douchebakken / stoomcabines |  | PKS 50/0 spiegelkast z. verlichting 2000120 50x80cm | aluminium | 104150 | stuk | 594,00 | 311 | 1 |
| Kranen |  | PKS 50/FL spiegelkast m. TL verlichting 2000121 50x80cm | aluminium | 104250 | stuk | 709,00 | 311 | 1 |
| Douchegarnituur |  | PKS 50/FL spiegelkast m. TL verlichting 2000121 50x80cm | aluminium | 104250 | stuk | 709,00 | 311 | 1 |
| Accessoires en spiegels |  | PKS 50/FL spiegelkast m. TL verlichting 2000121 50x80cm | aluminium | 104250 | stuk | 709,00 | 311 | 1 |
| Douchewanden | Schneider Proline | | | | | | | |
| |  | PRO 60/F-2/FL 2-deurs spiegelkast m. TL verlichting 2000162 60x71.5cm | wit | 110065 | stuk | 322,00 | 311 | 1 |
| Toebehoren & afvoeren |  | PRO 60/F-1/FL 1-deurs spiegelkast m. TL verlichting 2000163 60x71.5cm | wit | 110165 | stuk | 272,00 | 311 | 1 |
| Spoel- & installatiesystemen |  | PRO 60/HAL 2-deurs spiegelkast m. halogeenverlichting 2000164 | wit | 110260 | stuk | 439,00 | 311 | 1 |
| Badkamermeubelen en toiletkasten |  | PRO 60/HAL 2-deurs spiegelkast m. halogeenverlichting 2000164 | wit | 110260 | stuk | 439,00 | 311 | 1 |
| Gootstenen en wastroggen |  | PRO 60/HAL 2-deurs spiegelkast m. halogeenverlichting 2000164 | wit | 110260 | stuk | 439,00 | 311 | 1 |
| Utiliteit | Schneider QuadraLine | | | | | | | |
| |  | spiegelkast 55cm m. halogeenverlichting 2000105 links | aluminium | 111055 | stuk | 579,00 | 311 | 1 |
| | | 2000106 rechts | aluminium | 111056 | stuk | 579,00 | 311 | 1 |
| | Schneider RonLine | | | | | | | |
| |  | RON/E 45/HAL hoekspiegelkast m. halogeenverlichting 2000109 45x79cm links | alu/wit | 118645 | stuk | 682,00 | 311 | 1 |
| | | 2000110 45x79cm rechts | alu/wit | 118646 | stuk | 682,00 | 311 | 1 |
| |  | RON/E 45/FL hoekspiegelkast m. TL verlichting 2000146 45x79cm links | alu/wit | 118545 | stuk | 612,00 | 311 | 1 |
| | | 2000147 45x79cm rechts | alu/wit | 118546 | stuk | 612,00 | 311 | 1 |

| Art.nr | Specificaties | Kleur | Lev.nr | Ehd | Prijs | Grp | CC |
|--------|---------------|-------|--------|-----|-------|-----|----|
|--------|---------------|-------|--------|-----|-------|-----|----|

Schneider RonLine

RON/E 45/0 hoekspiegelkast z. verlichting

| | | | | | | | |
|---------|----------------|---------|--------|------|--------|-----|---|
| 2000148 | 45x79cm links | alu/wit | 118745 | stuk | 478,00 | 311 | 1 |
| 2000149 | 45x79cm rechts | alu/wit | 118746 | stuk | 478,00 | 311 | 1 |



Sanitair producten

Baden /
douchebakken /
stoomcabines

Schneider RonPlus

RONplus 60/2/FL spiegelkast 60cm 2-deurs m. TL-verlichting

| | | | | | | | |
|---------|--|-----|--------|------|--------|-----|---|
| 2000111 | | wit | 118902 | stuk | 451,00 | 311 | 1 |
|---------|--|-----|--------|------|--------|-----|---|



Kranen

Douchegarnituur

RONplus 60/2/HAL spiegelkast 2-deurs m. halogeenverlichting

| | | | | | | | |
|---------|---------|-----|--------|------|--------|-----|---|
| 2000112 | 60x78cm | wit | 118952 | stuk | 506,00 | 311 | 1 |
|---------|---------|-----|--------|------|--------|-----|---|



Accessoires en
spiegels

Douchewanden

RONplus 60/2 AS/FL 2-deurs spiegelkast m. TL verlichting

| | | | | | | | |
|---------|------------------|-----|--------|------|--------|-----|---|
| 2000154 | 60x79.5cm links | wit | 118903 | stuk | 451,00 | 311 | 1 |
| 2000155 | 60x79.5cm rechts | wit | 118904 | stuk | 451,00 | 311 | 1 |



Toebehoren &
afvoeren

RONplus 60/2 AS/0 2-deurs spiegelkast z. verlichting

| | | | | | | | |
|---------|------------------|-----|--------|------|--------|-----|---|
| 2000157 | 60x79.5cm rechts | wit | 118934 | stuk | 396,00 | 311 | 1 |
|---------|------------------|-----|--------|------|--------|-----|---|



Spoel- &
installatiesystemen

Badkamermeubelen
en toiletkasten

Schneider SplashLine

SPL 60 1-deurs spiegelkast

| | | | | | | | |
|---------|---------------------------|-----------|--------|------|--------|-----|---|
| 2000122 | 60x69cm m. TL verlichting | aluminium | 103060 | stuk | 713,00 | 311 | 1 |
| 2000123 | 60x90cm m. TL verlichting | aluminium | 103065 | stuk | 788,00 | 311 | 1 |



Gootstenen en
wastroggen

Utiliteit

SPL 80/2/FL 2-deurs spiegelkast m. TL verlichting

| | | | | | | | |
|---------|---------|-----------|--------|------|--------|-----|---|
| 2000124 | 80x69cm | aluminium | 103080 | stuk | 809,00 | 311 | 1 |
|---------|---------|-----------|--------|------|--------|-----|---|



SPL 2-deurs spiegelkast m. TL verlichting

| | | | | | | | |
|---------|----------|-----------|--------|------|--------|-----|---|
| 2000125 | 100x69cm | aluminium | 103100 | stuk | 905,00 | 311 | 1 |
| 2000126 | 120x69cm | aluminium | 103120 | stuk | 956,00 | 311 | 1 |
| 2000127 | 130x69cm | aluminium | 103130 | stuk | 994,00 | 311 | 1 |



SPL/GS 30 glazen planchets m. houder 3 stuks

| | | | | | | | |
|---------|--|--|--------|------|--------|-----|---|
| 2000128 | | | 103230 | stuk | 166,00 | 311 | 1 |
|---------|--|--|--------|------|--------|-----|---|



| | Art.nr | Specificaties | Kleur | Lev.nr | Ehd | Prijs | Grp | CC |
|---|---|---------------|------------|--------|-------|--------|-----|----|
| Sanitair producten |  | | | | | | | |
| | 2000172 | 40x90cm | m. TL-buis | 129040 | chrom | 449,00 | 311 | 1 |
| Baden / douchebakken / stoomcabines | | | | | | | | |
| Kranen | | | | | | | | |
| Douchegarnituur | | | | | | | | |
| Accessoires en spiegels | | | | | | | | |
| Douchewanden | | | | | | | | |
| Toebehoren & afvoeren | | | | | | | | |
| Spoel- & installatiesystemen | | | | | | | | |
| Badkamermeubelen en toiletkasten | | | | | | | | |
| Gootstenen en wastroggen | | | | | | | | |
| Utiliteit | | | | | | | | |

| Art.nr | Specificaties | Kleur | Lev.nr | Ehd | Prijs | Grp | CC |
|---------|--------------------------------------|-------|---------|------|-------|-----|----|
| 0703403 | magneetstop | | 0703403 | stuk | 1,01 | 384 | 0 |
| 0703404 | sluitingsmagneet | | 0703404 | stuk | 6,10 | 384 | 0 |
| 0959985 | losse lamp compleet voor spiegelkast | | 0959985 | stuk | 32,75 | 384 | 0 |
| 0703406 | demper | | 0703406 | stuk | 1,51 | 384 | 0 |
| 0703407 | set ophanghaken | | 0703407 | stuk | 8,10 | 384 | 0 |
| 0703408 | glazen planchet los | | 0703408 | stuk | 12,25 | 384 | 1 |
| 0703409 | scharnier | | 0703409 | stuk | 4,01 | 384 | 0 |
| 0703410 | spiegeldeur los | | 0703410 | stuk | 90,50 | 384 | 1 |
| 0959983 | transformator voor spiegelkast | | 0959983 | stuk | 9,60 | 384 | 0 |

Sanitair producten

Baden /
douchebakken /
stoomcabines

Kranen









Douchegarnituur

Accessoires en
spiegels

Douchewanden

Toebehoren &
afvoerenSpoel- &
installatiesystemenBadkamermeubelen
en toiletkastenGootstenen en
wastroggen

Utiliteit

| | Art.nr | Specificaties | Kleur | Lev.nr | Ehd | Prijs | Grp | CC |
|---|---|---------------|------------|----------|------|---------|-----|----|
| Sanitair producten | Villeroy & Boch Capacity | | | | | | | |
| | spiegelkast | | | | | | | |
| | 0100651 | 40x72.5x10cm | alu-zilver | 97864000 | stuk | 1286,00 | 053 | 1 |
| | 0100686 | 80x72.5x10cm | alu-zilver | 97868000 | stuk | 1976,00 | 053 | 1 |
| Baden / douchebakken / stoomcabines |  | | | | | | | |
| Kranen |  | | | | | | | |
| Douchegarnituur | bevestigingsstang | | | | | | | |
| | 0100468 | | verchromd | 97871000 | stuk | 13,00 | 053 | 1 |
| Accessoires en spiegels |  | | | | | | | |
| Douchewanden | tandenborstelhouder | | | | | | | |
| | 0100357 | 12.5cm | acrylglas | 97873000 | stuk | 25,00 | 053 | 1 |
| Toebehoren & afvoeren |  | | | | | | | |
| Spoel- & installatiesystemen | acrylschaal | | | | | | | |
| | 0100560 | 10x6x8cm | acrylglas | 97874000 | stuk | 34,00 | 053 | 1 |
| |  | | | | | | | |
| Badkamermeubelen en toiletkasten | acryl box hoog | | | | | | | |
| | 0100540 | 5x8.5x5cm | acrylglas | 97875000 | stuk | 34,00 | 053 | 1 |
| |  | | | | | | | |
| Gootstenen en wastroggen | acryl box lang | | | | | | | |
| | 0100550 | 36x3x4.5cm | acrylglas | 97872000 | stuk | 36,00 | 053 | 1 |
| |  | | | | | | | |
| Utiliteit | vergrotingspiegel | | | | | | | |
| | 0100397 | 16cm | | 97876000 | stuk | 21,00 | 053 | 1 |
| |  | | | | | | | |

Gootstenen en wastroggen

| | |
|-----------------------------------|------|
| Gootstenen ABU | 1294 |
| Gootstenen Alape | 1295 |
| Gootstenen Plieger | 1296 |
| Gootstenen Franke | 1298 |
| Gootstenen Keramag | 1299 |
| Wastroggen en -fonteinen Intersan | 1301 |
| Gootstenen Kuhfuss | 1302 |
| Gootstenen Sphinx | 1303 |
| Gootstenen Villeroy & Boch | 1304 |

Gootstenen en wastroggen

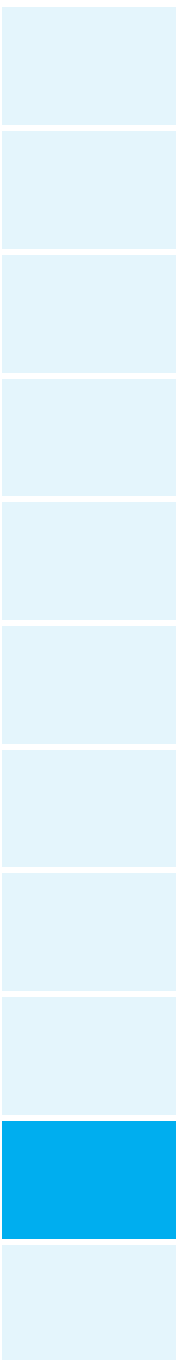

| | Art.nr | Specificaties | Kleur | Lev.nr | Ehd | Prijs | Grp | CC |
|---|--|-------------------------|-----------|--------|------|-------|-----|----|
| Sanitair producten | ABU gootstenen | | | | | | | |
| | 0970069 | 50x35cm z. emmerrooster | wit | 700301 | stuk | 55,50 | 359 | 0 |
| Baden / douchebakken / stoomcabines | emmerrooster voor gootsteen kunststof | | | | | | | |
| | 0970123 | | kunststof | 700698 | stuk | 12,75 | 359 | 0 |
| Kranen | | | | | | | | |
| Douchegarnituur | | | | | | | | |
| Accessoires en spiegels | | | | | | | | |
| Douchewanden | | | | | | | | |
| Toebehoren & afvoeren | | | | | | | | |
| Spoel- & installatiesystemen | | | | | | | | |
| Badkamermeubelen en toiletkasten | | | | | | | | |
| Gootstenen en wastroggen | | | | | | | | |
| Utiliteit | | | | | | | | |

| Art.nr | Specificaties | Kleur | Lev.nr | Ehd | Prijs | Grp | CC |
|---|---------------|-----------|------------|------|--------|-----|----|
| Alape gootstenen | | | | | | | |
| Stahlform 412 uitstortgootsteen m. grijze rand 0930010 41x27cm | | wit | 1000000000 | stuk | 85,00 | 359 | 1 |
| Stahlform 505 uitstortgootsteen m. blauwe rand 0934681 50x33cm | | wit | 1100000000 | stuk | 93,50 | 359 | 0 |
| Stahlform 510U uitstortgootsteen m. blauwe rand en overloop 0930008 51x36cm | | wit | 1200000000 | stuk | 115,00 | 359 | 0 |
| emmerrooster 0930059 | | aluminium | 8901000722 | stuk | 17,00 | 359 | 0 |
| Edelstahl 505 uitstortgootsteen m. grijze rand 0930016 51x43cm | | RVS | 1400000000 | stuk | 272,00 | 359 | 1 |



Sanitair producten

Baden /
douchebakken /
stoomcabines

Kranen

Douchegarnituur

Accessoires en
spiegels

Douchewanden

Toebehoren &
afvoerenSpoel- &
installatiesystemenBadkamermeubelen
en toiletkastenGootstenen en
wastroggen

Utiliteit

| | Art.nr | Specificaties | Kleur | Lev.nr | Ehd | Prijs | Grp | CC |
|---|--|---------------|-------|---------|------|-------|-----|----|
| Sanitair producten | Plieger gootstenen uitstortgootsteen plaatstaal | | | | | | | |
| | 0970005 | 50.3x33cm | wit | 0970005 | stuk | 37,00 | 359 | 0 |
| Baden / douchebakken / stoomcabines | emmerrooster metaal tbv plaatstalen uitstortgootsteen 0970027 | | | | | | | |
| | | | zwart | 0970027 | stuk | 7,10 | 359 | 0 |
| Kranen | | | | | | | | |
| Douchegarnituur | | | | | | | | |
| Accessoires en spiegels | | | | | | | | |
| Douchewanden | | | | | | | | |
| Toebehoren & afvoeren | | | | | | | | |
| Spoel- & installatiesystemen | | | | | | | | |
| Badkamermeubelen en toiletkasten | | | | | | | | |
| Gootstenen en wastroggen | | | | | | | | |
| Utiliteit | | | | | | | | |

Vraag naar de uitgebreide Sanitair-catalogus met meer dan 500 verschillende RVS-producten



Franke Roestvrijstaal
Nederland B.V.
Postbus 157
5700 AD Helmond
www.franke.nl

Adres: Lage Dijk 13
5705 BX Helmond
Tel.: 0492 58 51 11
Fax: 0492 58 52 00
E-mail: verkoop-wss@franke.com

| | Art.nr | Specificaties | Kleur | Lev.nr | Ehd | Prijs | Grp | CC |
|---|--|---------------------------|-------|--------|------|--------|-----|----|
| Sanitair producten | Franke gootstenen | | | | | | | |
| | RVS uitstortbak m. spatplaat | | | | | | | |
| | 0910678 | 44x31cm m. emmerrooster | | WB440C | stuk | 182,00 | 369 | 0 |
| Baden / douchebakken / stoomcabines | RVS uitstortbak | | | | | | | |
| | 0910102 | 44.8x40cm z. emmerrooster | | BS301 | stuk | 268,00 | 369 | 1 |
| Kranen | 0910103 | 44.8x40cm m. emmerrooster | | BS300 | stuk | 325,00 | 369 | 1 |
| | 0910694 | 50x40cm z. emmerrooster | | BS303 | stuk | 315,00 | 369 | 1 |
| | 0910686 | 50x40cm m. emmerrooster | | BS302 | stuk | 328,00 | 369 | 1 |
| | RVS wasgoot m. kranenbank afvoer links | | | | | | | |
| Douchegarnituur | 0910104 | 60x40cm | | ECN6L | stuk | 378,00 | 369 | 1 |
| | 0910112 | 120x40cm | | ECN12L | stuk | 438,00 | 369 | 1 |
| | 0910120 | 180x40cm | | ECN18L | stuk | 541,00 | 369 | 1 |
| | 0910279 | 240x40cm | | ECN24L | stuk | 658,00 | 369 | 1 |
| | 0910287 | 300x40cm | | ECN30L | stuk | 768,00 | 369 | 1 |
| Accessoires en spiegels | RVS console voor wastrog | | | | | | | |
| | 0910368 | | | 530RVS | stuk | 108,00 | 369 | 1 |
| Douchewanden | RVS wastrog afvoer rechts m. standpijp en vuilrooster | | | | | | | |
| | 0910708 | 75x50cm m. bevestiging | | BS314 | stuk | 505,00 | 369 | 1 |
| Toebehoren & afvoeren | RVS wastrog dubbel m. standpijp en vuilrooster | | | | | | | |
| | 0910716 | 142x50cm m. bevestiging | | BS315 | stuk | 764,00 | 369 | 1 |
| Spoel- & installatiesystemen | RVS wasgoot afvoer links m. console m. plug | | | | | | | |
| Badkamermeubelen en toiletkasten | 0900109 | 120x40x14 | | BX120L | stuk | 474,00 | 369 | 1 |
| | 0900117 | 180x40x17 | | BX180L | stuk | 622,00 | 369 | 1 |
| Gootstenen en wastroggen | | | | | | | | |
| Utiliteit | | | | | | | | |

| Art.nr | Specificaties | Kleur | Lev.nr | Ehd | Prijs | Grp | CC |
|--|---------------|-------|-----------|------|--------|-----|----|
| Keramag gootstenen | | | | | | | |
| uitstortgootsteen 0082086 | 43x33.5cm | wit | 367200000 | stuk | 335,00 | 034 | 1 |
| <hr/> | | | | | | | |
| stootrand voor gootsteen 0082088 | | | 552003000 | stuk | 23,00 | 034 | 1 |
| <hr/> | | | | | | | |



Sanitair producten

Baden /
douchebakken /
stoomcabines

Kranen

Douchegarnituur

Accessoires en
spiegels

Douchewanden

Toebehoren &
afvoerenSpoel- &
installatiesystemenBadkamermeubelen
en toiletkasten**Gootstenen en
wastroggen**

Utiliteit

Douches



ISITUB



SEDONA



THERMOTUB



SONORA

Solid Surface

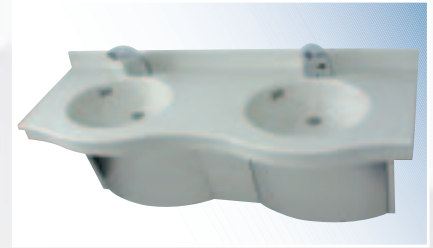

SOLIDWAVE



SANIWAVE



SANIFOUNT

Wastroggen



SANISPRAY

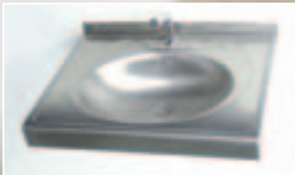

SANSET



SANILAV



WASTROGGEN

Elektronische kranen



SANTRONIC



WAVETRONIC



FLOTRONIC



ISTRONIC



SANTRONIC



ISI-SORP

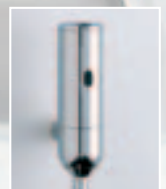

P-TRONIC



INTERSAN

Helvoirtseweg 9 NL-5261 CA Vught
 T +31 (0)73 684 14 90 F +31 (0)73 684 13 22
 W www.intersan.nl

| Art.nr | Specificaties | Kleur | Lev.nr | Ehd | Prijs | Grp | CC |
|---|-------------------|-------|----------|------|---------|-----|----|
| Intersan wastroggen en -fonteinen | | | | | | | |
| aluminium wastrog | | | | | | | |
| 0900273 | 120cm 2-persoons | | TM2A | stuk | 483,00 | 356 | 0 |
| 0900281 | 180cm 3-persoons | | TM3A | stuk | 645,00 | 356 | 0 |
| 0900303 | 240cm 4-persoons | | TM4A | stuk | 799,00 | 356 | 1 |
| 0900311 | 300cm 5-persoons | | TM5A | stuk | 955,00 | 356 | 1 |
| aluminium wastrog m. hartmengkraan | | | | | | | |
| 0900451 | 120cm 2-persoenen | | TM2AHR | stuk | 859,00 | 356 | 1 |
| 0900486 | 180cm 3-persoenen | | TM3AHR | stuk | 1196,00 | 356 | 1 |
| 0900494 | 240cm 4-persoenen | | TM4AHR | stuk | 1515,00 | 356 | 1 |
| 0900508 | 300cm 5-persoenen | | TM5AHR | stuk | 1837,00 | 356 | 1 |
| zijplaatjes aluminium voor muurwastrog | | | | | | | |
| 0900001 | per paar | | TZMA | paar | 28,00 | 356 | 0 |
| RVS wastrog | | | | | | | |
| 0900338 | 120cm 2-persoenen | | TM2C | stuk | 814,00 | 356 | 0 |
| 0900346 | 180cm 3-persoenen | | TM3C | stuk | 1059,00 | 356 | 0 |
| 0900354 | 240cm 4-persoenen | | TM4C | stuk | 1293,00 | 356 | 0 |
| 0900362 | 300cm 5-persoenen | | TM5C | stuk | 1529,00 | 356 | 1 |
| RVS wastrog m. hartmengkraan | | | | | | | |
| 0900516 | 120cm 2-persoenen | | TM2CHR | stuk | 1177,00 | 356 | 0 |
| 0900524 | 180cm 3-persoenen | | TM3CHR | stuk | 1593,00 | 356 | 0 |
| 0900532 | 240cm 4-persoenen | | TM4CHR | stuk | 1988,00 | 356 | 1 |
| 0900540 | 300cm 5-persoenen | | TM5CHR | stuk | 2387,00 | 356 | 1 |
| RVS zijplaatjes per paar | | | | | | | |
| 0900036 | voor muurwastrog | | TZMC | paar | 36,00 | 356 | 0 |
| wasfontein m. tapkranen z. poederzeepverdeler | | | | | | | |
| 0900613 | | RVS | IRH06S1T | stuk | 3269,00 | 356 | 1 |
| 0900621 | | RVS | IRH08S1T | stuk | 3443,00 | 356 | 1 |
| 0900648 | | RVS | IRH10S1T | stuk | 3667,00 | 356 | 1 |
| wasfontein m. hartmengkraan z. poederzeepverdeler | | | | | | | |
| 0900583 | | RVS | IMH06S2T | stuk | 4056,00 | 356 | 1 |
| 0900591 | | RVS | IMH08S2T | stuk | 4222,00 | 356 | 1 |
| 0900605 | | RVS | IMH10S2T | stuk | 4439,00 | 356 | 1 |
| wasfontein sproeibek m. drukknop z. poederzeepverdeler | | | | | | | |
| 0900559 | | RVS | INH06S1P | stuk | 4782,00 | 356 | 1 |
| 0900567 | | RVS | INH08S1P | stuk | 5482,00 | 356 | 1 |
| 0900575 | | RVS | INH10S1P | stuk | 5708,00 | 356 | 1 |



Sanitair producten

Baden /
douchebakken /
stoomcabines

Kranen

Douchegarnituur

Accessoires en
spiegels

Douchewanden

Toebehoren &
afvoeren

Spoel- &
installatiesystemen

Badkamermeubelen
en toiletkasten

Gootstenen en
wastroggen

Utiliteit

| Art.nr | Specificaties | Kleur | Lev.nr | Ehd | Prijs | Grp | CC |
|--------|---------------|-------|--------|-----|-------|-----|----|
|--------|---------------|-------|--------|-----|-------|-----|----|

Kuhfuss gootstenen

RVS emmerrooster voor gootsteen

| | | | | | | | |
|---------|--|--|--------|------|-------|-----|---|
| 0900052 | | | 234017 | stuk | 41,25 | 369 | 0 |
|---------|--|--|--------|------|-------|-----|---|

Sanitair producten

Baden /
douchebakken /
stoomcabines

Kranen

Douchegarnituur

Accessoires en
spiegels

Douchewanden

Toebehoren &
afvoeren

Spoel- &
installatiesystemen

Badkamermeubelen
en toiletkasten

**Gootstenen en
wastroggen**

Utiliteit

| Art.nr | Specificaties | Kleur | Lev.nr | Ehd | Prijs | Grp | CC |
|--|---------------|-------|-------------|------|--------|-----|----|
| Sphinx gootstenen | | | | | | | |
| emmerrooster voor Arnhem | | | | | | | |
| 0830151 | 46cm | | 1100 | stuk | 46,50 | 362 | 0 |
| 0830178 | 61cm | | 1200 | stuk | 55,00 | 362 | 0 |
| gootsteenconsoles wit gemoffeld | | | | | | | |
| 0830127 | 33cm | | 0830127 | stuk | 12,45 | 362 | 0 |
| uitstortgootsteen m. stootrand | | | | | | | |
| 0240092 | 61x45cm | wit | S8A00200000 | stuk | 369,00 | 044 | 0 |
| paar gootsteen/wastafelconsoles geplastificeerd | | | | | | | |
| 0830526 | 26cm | | 0830526 | paar | 17,00 | 362 | 0 |
| uitstortgootsteen m. stootrand | | | | | | | |
| 0240090 | 46x36cm | wit | S8A00100000 | stuk | 271,00 | 044 | 0 |
| paar gootsteen/wastafelconsoles geplastificeerd | | | | | | | |
| 0830488 | 34.5cm | | 0830488 | paar | 19,50 | 362 | 0 |

Sanitair producten

Baden /
douchebakken /
stoomcabines

Kranen

Douchegarnituur

Accessoires en
spiegels

Douchewanden

Toebehoren &
afvoerenSpoel- &
installatiesystemenBadkamermeubelen
en toiletkastenGootstenen en
wastroggen

Utiliteit

| | Art.nr | Specificaties | Kleur | Lev.nr | Ehd | Prijs | Grp | CC |
|--|--|---------------|------------------|----------|----------|-------|--------|-------|
| Sanitair producten | Villeroy & Boch Omnia Pro uitstortgootsteen | | | | | | | |
| | uitstortgootsteen | | | | | | | |
| | 0140414 | 45x35cm | zonder stootrand | wit | 69120001 | stuk | 302,00 | 053 1 |
| | 0140415 | 45x35cm | met stootrand | wit | 69120101 | stuk | 319,00 | 053 1 |
| Baden / douchebakken / stoomcabines | emmerrooster v. uitstortgootsteen | | | | | | | |
| | 0140430 | | | 96830000 | stuk | 72,00 | 053 | 1 |
| Kranen | Villeroy & Boch Omnia gootstenen enkel | | | | | | | |
| | gootsteen m. overloop | | | | | | | |
| Douchegarnituur | 0140150 | 50x40x17cm | | wit | 63210001 | stuk | 181,00 | 053 0 |
| | 0140151 | 50x40x17cm | | pergamon | 63210009 | stuk | 217,00 | 053 1 |
| | 0140183 | 50x40x17cm | ceramic+ | wit | 632100R1 | stuk | 244,00 | 053 1 |
| | 0108405 | 50x40x17cm | ceramic+ | pergamon | 632100R3 | stuk | 280,00 | 053 1 |
| | 0140155 | 60x50x20cm | | wit | 63220001 | stuk | 234,00 | 053 0 |
| | 0140180 | 60x50x20cm | | pergamon | 63220009 | stuk | 281,00 | 053 1 |
| Accessoires en spiegels | 0140185 | 60x50x20cm | ceramic+ | wit | 632200R1 | stuk | 297,00 | 053 1 |
| | 0108413 | 60x50x20cm | ceramic+ | pergamon | 632200R3 | stuk | 344,00 | 053 1 |
| | 0140157 | 70x50x20cm | | wit | 63270001 | stuk | 355,00 | 053 1 |
| Douchewanden | 0140181 | 70x50x20cm | | pergamon | 63270009 | stuk | 428,00 | 053 1 |
| | 0140187 | 70x50x20cm | ceramic+ | wit | 632700R1 | stuk | 418,00 | 053 1 |
| | 0108421 | 70x50x20cm | ceramic+ | pergamon | 632700R3 | stuk | 491,00 | 053 1 |
| | overloopgarnituur voor gootsteen | | | | | | | |
| | 0140163 | | | 94281061 | stuk | 29,00 | 053 | 0 |
| Toebehoren & afvoeren | Villeroy & Boch Omnia gootstenen dubbel | | | | | | | |
| | gootsteen dubbel | | | | | | | |
| Spoel- & installatiesystemen | 0140160 | 80x50cm | | wit | 63310001 | stuk | 409,00 | 053 0 |
| | 0140189 | 80x50cm | | pergamon | 63310009 | stuk | 490,00 | 053 1 |
| | 0140193 | 80x50cm | ceramic+ | wit | 633100R1 | stuk | 472,00 | 053 1 |
| | 0108448 | 80x50cm | ceramic+ | pergamon | 633100R3 | stuk | 553,00 | 053 1 |
| | 0140159 | 90x55cm | | wit | 63320001 | stuk | 593,00 | 053 1 |
| | 0140162 | 90x55cm | | pergamon | 63320009 | stuk | 713,00 | 053 1 |
| Badkamermeubelen en toiletkasten | 0140191 | 90x55cm | ceramic+ | wit | 633200R1 | stuk | 656,00 | 053 1 |
| | 0108456 | 90x55cm | ceramic+ | pergamon | 633200R3 | stuk | 776,00 | 053 1 |
| overloopgarnituur voor gootsteen dubbel | | | | | | | | |
| | 0140165 | | | 94290061 | stuk | 40,00 | 053 | 0 |
| Gootstenen en wastroggen | | | | | | | | |
| Utiliteit | | | | | | | | |

Utiliteit

| | |
|--|------|
| ABU | 1306 |
| Duscholux | 1307 |
| Emco | 1308 |
| Hewi | 1309 |
| Plieger | 1311 |
| Linido | 1312 |
| Pressalit Multi | 1316 |
| Pressalit Rehab | 1317 |
| Revato | 1318 |
| Riho | 1320 |
| Aqua besturingen | 1321 |
| VSH zeepdispenser | 1323 |
| Franke RVS sanitair | 1324 |
| CWS papier- en zeepautomaten | 1328 |
| Water Saving System | 1329 |
| de Melker Rada douchekoppen Kiwa gekeurd | 1330 |
| de Melker Rada douchekoppen en douchecombinaties | 1331 |
| de Melker Presto Zelfsluitende systemen voor wastafels | 1332 |
| de Melker Zelfsluitende systemen voor douches | 1333 |
| de Melker Meltronic M-net | 1334 |
| de Melker Zelfsluitende systemen voor urinoirs | 1335 |
| de Melker Zelfsluitende systemen voor toiletten | 1336 |
| de Melker Rada thermoscopische mengapparatuur | 1337 |
| de Melker Rada elektronische mengapparatuur | 1338 |
| de Melker Accessoires voor mengapparatuur | 1339 |
| de Melker Rada mengkranen | 1340 |
| de Melker Mora thermostatische mengkranen | 1341 |
| de Melker Mora RH-serie voor toepassingen in de gezondheidszorg | 1342 |
| de Melker Mora vaatdouches en vorstvrije gevelkranen | 1343 |
| de Melker Broen laboratoriumkranen water | 1344 |
| de Melker Docmix eenhendelmengkraan | 1345 |
| de Melker Broen Laboratoriumkranen Aardgas | 1346 |
| de Melker Broen laboratorium Naaldafsluiters | 1347 |
| de Melker Broen laboratoriumkranen van zuivere gassen | 1348 |
| de Melker Broen Redline nood- en oogdouches | 1349 |
| Onthardingszout | 1350 |

Utiliteit

| Art.nr | Specificaties | Kleur | Lev.nr | Ehd | Prijs | Grp | CC |
|-------------------------------|---------------|----------|--------|------|--------|-----|----|
| ABU douchezitje | | | | | | | |
| douchezitje opklapbaar | | | | | | | |
| 0750008 | | wit | 659001 | stuk | 119,00 | 366 | 1 |
| 0751536 | | pergamon | 659005 | stuk | 119,00 | 366 | 1 |

Sanitair producten

Baden /
douchebakken /
stoomcabines

Kranen

Douchegarnituur

Accessoires en
spiegels

Douchewanden

Toebehoren &
afvoeren

Spoel- &
installatiesystemen

Badkamermeubelen
en toiletkasten

Gootstenen en
wastroggen

Utiliteit

| Art.nr | Specificaties | Kleur | Lev.nr | Ehd | Prijs | Grp | CC |
|-------------------------------------|---------------|-----------|--------------|----------------------------|--------|-----|----|
| | | | | Duscholux Duschoboy | | | |
| opbergkastje m. 2 legplanken | | | | | | | |
| 0985996 | 70cm | zilver | 950817000071 | stuk | 213,00 | 276 | 1 |
| 0986003 | 70cm | wit | 950817000001 | stuk | 249,00 | 276 | 1 |
| | | | | Duscholux klapzitje | | | |
| douchezitje opklapbaar | | | | | | | |
| 0986020 | | wit | 195005000001 | stuk | 360,00 | 276 | 1 |
| 0986021 | | antraciet | 195005000151 | stuk | 360,00 | 276 | 1 |



Sanitair producten

Baden /
douchebakken /
stoomcabines

Kranen

Douchegarnituur

Accessoires en
spiegels

Douchewanden

Toebehoren &
afvoerenSpoel- &
installatiesystemenBadkamermeubelen
en toiletkastenGootstenen en
wastroggen

Utiliteit

| Art.nr | Specificaties | Kleur | Lev.nr | Ehd | Prijs | Grp | CC |
|-------------------------|-------------------------|-----------|-----------|------|--------|-----|----|
| Emco douchezitje | | | | | | | |
| douchezitje | | | | | | | |
| 0630440 | m. rugleuning v. reling | chrom/wit | 575121501 | stuk | 928,00 | 323 | 1 |
| 0630449 | m. rugleuning v. reling | chrom/wit | 575121503 | stuk | 307,00 | 323 | 1 |
| 0630450 | z. rugleuning | chrom/wit | 575121502 | stuk | 243,00 | 323 | 1 |
| 0630404 | | wit | 575113900 | stuk | 95,00 | 232 | 1 |



Sanitair producten

Baden /
douchebakken /
stoomcabines

Kranen

Douchegarnituur

Accessoires en
spiegels

Douchewanden

Toebehoren &
afvoerenSpoel- &
installatiesystemenBadkamermeubelen
en toiletkastenGootstenen en
wastroggen

Utiliteit

| Art.nr | Specificaties | Kleur | Lev.nr | Ehd | Prijs | Grp | CC |
|--------|---------------|-------|--------|-----|-------|-----|----|
|--------|---------------|-------|--------|-----|-------|-----|----|

Hewi utiliteit producten

opklapbaar douchezitje z. bevestiging

| | | | | | | | |
|---------|--------|-----|------------|------|--------|-----|---|
| 0090190 | 34.5cm | wit | 8015120099 | stuk | 389,00 | 241 | 1 |
| 0090204 | 44.8cm | wit | 8015121099 | stuk | 449,00 | 241 | 1 |



Sanitair producten

bevestiging voor douchezitje

| | | | | | | | |
|---------|--|--|---------|------|-------|-----|---|
| 0090212 | | | BA80120 | stuk | 20,25 | 241 | 1 |
| 0090220 | | | BA80124 | stuk | 29,75 | 241 | 1 |
| 0090239 | | | BA80121 | stuk | 29,75 | 241 | 1 |
| 0090247 | | | BA80122 | stuk | 23,25 | 241 | 1 |

Baden /
douchebakken /
stoomcabines**opklapbare toiletsteun**

| | | | | | | | |
|---------|--------|------------------|------------|------|--------|-----|---|
| 0090123 | 83.5cm | wit | 8015022099 | stuk | 366,00 | 241 | 1 |
| 0090107 | 83.5cm | m. vergrendeling | 8015012099 | stuk | 414,00 | 241 | 1 |

Kranen

bevestiging voor opklapbare steun

| | | | | | | | |
|---------|--|--|---------|------|-------|-----|---|
| 0090158 | | | BA80110 | stuk | 10,25 | 241 | 1 |
| 0090174 | | | BA80111 | stuk | 15,00 | 241 | 1 |
| 0090182 | | | BA80112 | stuk | 11,75 | 241 | 1 |

Douchegarnituur

deursymbool wit

| | | | | | | | |
|---------|--|-------|------------|------|-------|-----|---|
| 0090085 | | man | 4779102099 | stuk | 10,00 | 241 | 1 |
| 0090077 | | vrouw | 4779101099 | stuk | 10,00 | 241 | 1 |

Accessoires en
spiegels

Douchewanden

Toebehoren &
afvoeren**glijstang 80cm**

| | | | | | | | |
|---------|--------------|-----|------------|------|--------|-----|---|
| 0090255 | m. opsteeker | wit | 8013311099 | stuk | 165,00 | 241 | 1 |
|---------|--------------|-----|------------|------|--------|-----|---|

Spoel- &
installatiesystemenBadkamermeubelen
en toiletkastenGootstenen en
wastroggen

Utiliteit

Nieuw

Opklapbaar douchezitje
met rugleuning



douchezit

antibacterieel

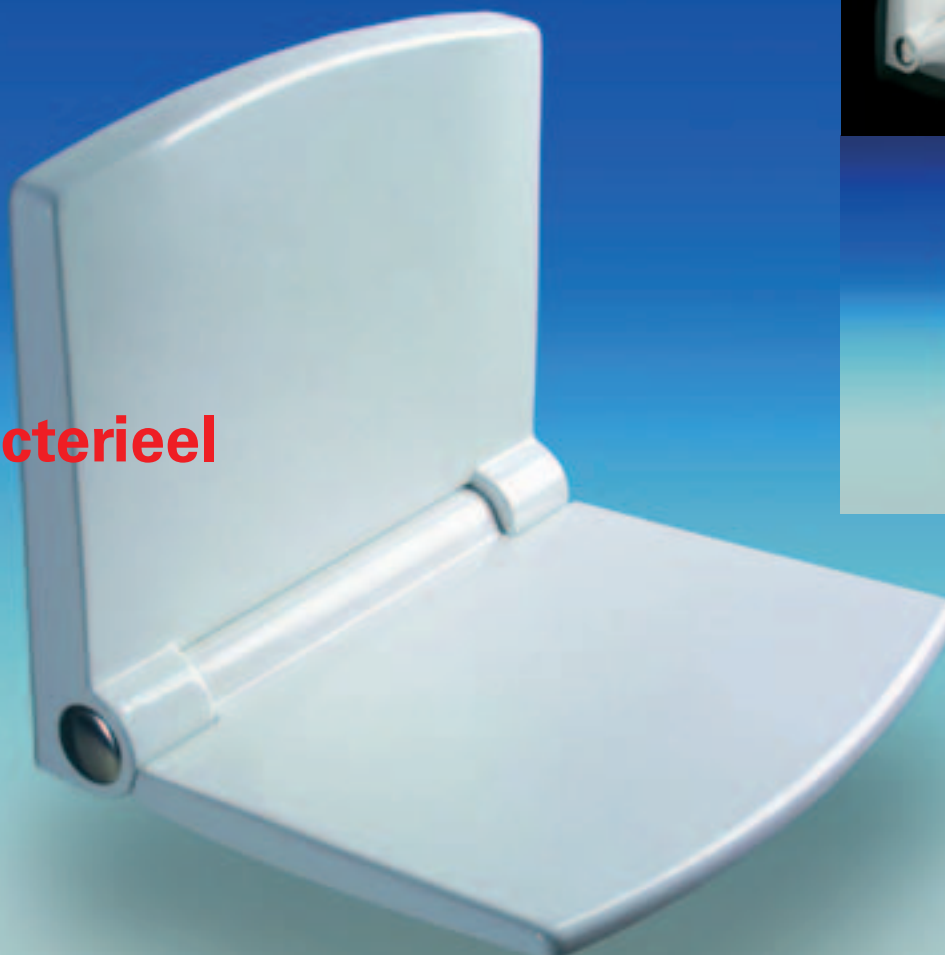

softclose

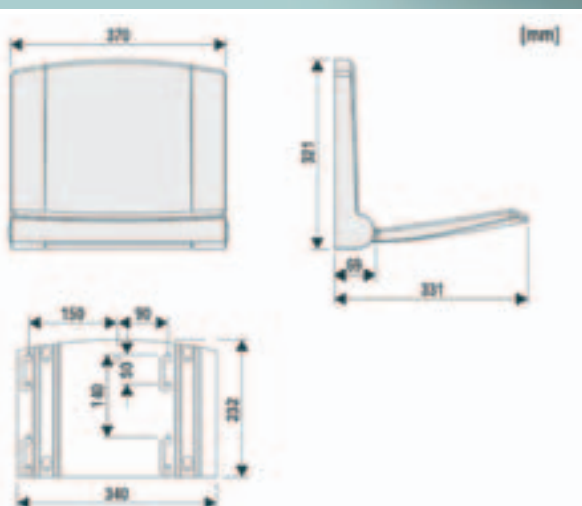

Gemaakt van thermoplast met een antibacteriële bovenlaag uitgevoerd met een softclose scharnier. Eenvoudig in hoogte verstelbaar (tot 50mm). Het royale en ergonomisch zitvlak (370x260mm) met rugsteun biedt comfortabele zekerheid. 4-punts RVS bevestiging voor een stabiele montage.

- 0750090 Plieger Lifestyle dubbele opklapbare douchezitje wit
- 0750091 Plieger Lifestyle dubbele opklapbare douchezitje pergamon

 **PLIEGER**

| Art.nr | Specificaties | Kleur | Lev.nr | Ehd | Prijs | Grp | CC |
|--------------------------------------|---------------|----------|---------|------|--------|-----|----|
| Plieger douchezitje Lifestyle | | | | | | | |
| douchezitje, opklapbaar | | | | | | | |
| 0750090 | m. rugleuning | wit | 659401 | stuk | 196,00 | 241 | 0 |
| 0750091 | m. rugleuning | pergamon | 0750091 | stuk | 245,00 | 241 | 0 |

Sanitair producten

Baden /
douchebakken /
stoomcabines

Kranen

Douchegarnituur

Accessoires en
spiegels

Douchewanden

Toebehoren &
afvoerenSpoel- &
installatiesystemenBadkamermeubelen
en toiletkastenGootstenen en
wastroggen

Utiliteit

| | Art.nr | Specificaties | Kleur | Lev.nr | Ehd | Prijs | Grp | CC |
|---|---|-------------------------------------|---------|--------------|------|---------|-----|----|
| | Linido utiliteit producten | | | | | | | |
| | douchebrancard m. 4 zwenkwielen | | | | | | | |
| Sanitair producten | 0603740 | 190x70cm | RVS-304 | LI2503190200 | stuk | 1009,00 | 366 | 1 |
| | 0603724 | 190x70cm m. rugleuning m. opvangbak | RVS-304 | LI2508190200 | stuk | 1828,00 | 366 | 1 |
| | 0600326 | 190x70cm m. rugleuning m. opvangbak | grijs | LI2508190102 | stuk | 1163,00 | 366 | 1 |
| | doucheraam opklapbaar voor muurbevestiging m. inklapbare poten | | | | | | | |
| Baden / douchebakken / stoomcabines | 0603708 | 190x70cm | RVS | LI2403190200 | stuk | 773,00 | 366 | 1 |
| | 0600296 | 190x70cm | grijs | LI2403190102 | stuk | 448,00 | 366 | 1 |
| | 0603716 | 190x70cm m. rugsteun m. opvangbak | RVS | LI2408190200 | stuk | 1565,00 | 366 | 1 |
| | 0600318 | 190x70cm m. rugsteun m. opvangbak | grijs | LI2408190102 | stuk | 992,00 | 366 | 1 |
| | douchetabouret m. HT-bekleding | | | | | | | |
| Accessoires en spiegels | 0603619 | | wit | LI2001000102 | stuk | 120,00 | 366 | 1 |
| | 0603627 | | RVS | LI2001000200 | stuk | 206,00 | 366 | 1 |
| | douchezitting opklapbaar voor muurbevestiging | | | | | | | |
| Douchewanden | 0606472 | | wit | LI2201200602 | stuk | 128,00 | 366 | 0 |
| | douchezitting opklapbaar m. rugleuning voor muurbevestiging | | | | | | | |
| Toebehoren & afvoeren | 0606480 | | wit | LI2202200602 | stuk | 210,00 | 366 | 0 |
| | douchezitting opklapbaar m. rugleuning en armleggers voor muurbevestiging | | | | | | | |
| Spoel- & installatiesystemen | 0606499 | | wit | LI2203200602 | stuk | 234,00 | 366 | 0 |
| | douchezitting opklapbaar m. rugleuning en armleggers m. vloerstatief | | | | | | | |
| Badkamermeubelen en toiletkasten | 0603651 | | wit | LI2244000102 | stuk | 480,00 | 366 | 1 |
| | 0603678 | | RVS | LI2244000200 | stuk | 667,00 | 366 | 1 |
| | douchezitting opklapbaar m. rugleuning m. armleggers m. verstelb. vloerstatief | | | | | | | |
| Gootstenen en wastroggen | 0603686 | | wit | LI2254000102 | stuk | 535,00 | 366 | 1 |
| | 0603694 | | RVS | LI2254000200 | stuk | 722,00 | 366 | 1 |
| | hulpvoetset dubbel voor douchezitting | | | | | | | |
| Utiliteit | 0606537 | | wit | LI2214201102 | stuk | 74,00 | 366 | 0 |

| Art.nr | Specificaties | Kleur | Lev.nr | Ehd | Prijs | Grp | CC |
|------------------------------------|---------------|---------|--------------|------|--------|-----|----|
| Linido utiliteit producten | | | | | | | |
| wandbeugel ergogrip | | | | | | | |
| 0602647 | 30cm | wit | LI2611030102 | stuk | 31,00 | 366 | 0 |
| 0600792 | 30cm | RVS | LI2611030200 | stuk | 57,00 | 366 | 0 |
| 0601195 | 30cm | grijs | LI2611030101 | stuk | 31,00 | 366 | 1 |
| 0600793 | 30cm | RVS-wit | LI2611030402 | stuk | 46,00 | 366 | 1 |
| 0602655 | 40cm | wit | LI2611040102 | stuk | 32,00 | 366 | 0 |
| 0603937 | 40cm | RVS | LI2611040200 | stuk | 59,00 | 366 | 1 |
| 0600725 | 40cm | grijs | LI2611040101 | stuk | 32,00 | 366 | 1 |
| 0603938 | 40cm | RVS-wit | LI2611040402 | stuk | 48,00 | 366 | 0 |
| 0602663 | 50cm | wit | LI2611050102 | stuk | 34,00 | 366 | 0 |
| 0603945 | 50cm | RVS | LI2611050200 | stuk | 62,00 | 366 | 1 |
| 0600881 | 50cm | grijs | LI2611050101 | stuk | 34,00 | 366 | 1 |
| 0603946 | 50cm | RVS-wit | LI2611050402 | stuk | 50,00 | 366 | 1 |
| 0602671 | 60cm | wit | LI2611060102 | stuk | 36,00 | 366 | 0 |
| 0603953 | 60cm | RVS | LI2611060200 | stuk | 64,00 | 366 | 1 |
| 0601209 | 60cm | grijs | LI2611060101 | stuk | 36,00 | 366 | 1 |
| 0603954 | 60cm | RVS-wit | LI2611060402 | stuk | 52,00 | 366 | 1 |
| 0603139 | 70cm | wit | LI2611070102 | stuk | 38,00 | 366 | 1 |
| 0603961 | 70cm | RVS | LI2611070200 | stuk | 67,00 | 366 | 1 |
| 0600962 | 70cm | grijs | LI2611070101 | stuk | 38,00 | 366 | 1 |
| 0603147 | 80cm | wit | LI2611080102 | stuk | 40,00 | 366 | 1 |
| 0603988 | 80cm | RVS | LI2611080200 | stuk | 70,00 | 366 | 1 |
| 0601004 | 80cm | grijs | LI2611080101 | stuk | 40,00 | 366 | 1 |
| 0603155 | 90cm | wit | LI2611090102 | stuk | 42,00 | 366 | 1 |
| 0603996 | 90cm | RVS | LI2611090200 | stuk | 74,00 | 366 | 1 |
| 0601063 | 90cm | grijs | LI2611090101 | stuk | 42,00 | 366 | 1 |
| 0603163 | 100cm | wit | LI2611100102 | stuk | 44,00 | 366 | 0 |
| 0604003 | 100cm | RVS | LI2611100200 | stuk | 77,00 | 366 | 1 |
| 0601071 | 100cm | grijs | LI2611100101 | stuk | 44,00 | 366 | 1 |
| 0604011 | 110cm | wit | LI2611110102 | stuk | 55,00 | 366 | 1 |
| 0604038 | 110cm | RVS | LI2611110200 | stuk | 92,00 | 366 | 1 |
| 0600644 | 110cm | grijs | LI2611110101 | stuk | 55,00 | 366 | 1 |
| 0604046 | 120cm | wit | LI2611120102 | stuk | 58,00 | 366 | 1 |
| 0604054 | 120cm | RVS | LI2611120200 | stuk | 96,00 | 366 | 1 |
| 0600652 | 120cm | grijs | LI2611120101 | stuk | 58,00 | 366 | 1 |
| 0604062 | 130cm | wit | LI2611130102 | stuk | 60,00 | 366 | 1 |
| 0604070 | 130cm | RVS | LI2611130200 | stuk | 102,00 | 366 | 1 |
| 0600660 | 130cm | grijs | LI2611130101 | stuk | 60,00 | 366 | 1 |
| 0604089 | 140cm | wit | LI2611140102 | stuk | 63,00 | 366 | 1 |
| 0604097 | 140cm | RVS | LI2611140200 | stuk | 108,00 | 366 | 1 |
| 0600687 | 140cm | grijs | LI2611140101 | stuk | 63,00 | 366 | 1 |
| 0604100 | 150cm | wit | LI2611150102 | stuk | 102,00 | 366 | 1 |
| 0604119 | 150cm | RVS | LI2611150200 | stuk | 146,00 | 366 | 1 |
| 0600733 | 150cm | grijs | LI2611150101 | stuk | 102,00 | 366 | 1 |
| 0604127 | 160cm | wit | LI2611160102 | stuk | 104,00 | 366 | 1 |
| 0604135 | 160cm | RVS | LI2611160200 | stuk | 152,00 | 366 | 1 |
| 0600741 | 160cm | grijs | LI2611160101 | stuk | 104,00 | 366 | 1 |
| 0604143 | 170cm | wit | LI2611170102 | stuk | 106,00 | 366 | 1 |
| 0604151 | 170cm | RVS | LI2611170200 | stuk | 157,00 | 366 | 1 |
| 0600768 | 170cm | grijs | LI2611170101 | stuk | 106,00 | 366 | 1 |
| 0604178 | 180cm | wit | LI2611180102 | stuk | 108,00 | 366 | 1 |
| 0604186 | 180cm | RVS | LI2611180200 | stuk | 164,00 | 366 | 1 |
| 0600776 | 180cm | grijs | LI2611180101 | stuk | 108,00 | 366 | 1 |
| 0604194 | 190cm | wit | LI2611190102 | stuk | 110,00 | 366 | 1 |
| 0604208 | 190cm | RVS | LI2611190200 | stuk | 171,00 | 366 | 1 |
| 0600784 | 190cm | grijs | LI2611190101 | stuk | 110,00 | 366 | 1 |
| 0604216 | 200cm | wit | LI2611200102 | stuk | 112,00 | 366 | 1 |
| 0604224 | 200cm | RVS | LI2611200200 | stuk | 176,00 | 366 | 1 |
| 0600806 | 200cm | grijs | LI2611200101 | stuk | 112,00 | 366 | 1 |
| hoekwandbeugel voor 2 muren | | | | | | | |
| 0604232 | 65x50x100 | wit | LI2611016102 | stuk | 130,00 | 366 | 1 |
| 0604240 | 65x50x100 | RVS | LI2611016200 | stuk | 215,00 | 366 | 1 |
| 0600601 | 65x50x100 | grijs | LI2611016101 | stuk | 130,00 | 366 | 1 |
| wandbeugel links/rechts 45° | | | | | | | |
| 0606456 | 200x200 | wit | LI2611007102 | stuk | 47,00 | 366 | 1 |
| 0606464 | 400x400 | wit | LI2611008102 | stuk | 49,00 | 366 | 1 |

Sanitair producten

Baden /
douchebakken /
stoomcabines

Kranen

Douchegarnituur

Accessoires en
spiegels

Douchewanden

Toebehoren &
afvoerenSpoel- &
installatiesystemenBadkamermeubelen
en toiletkastenGootstenen en
wastroggen

Utiliteit

Linido utiliteit producten

wandbeugel 90°

| | | | | | | | |
|---------|----------|-----------|--------------|------|-------|-----|---|
| 0600907 | 500x1000 | creme-wit | LI2611003108 | stuk | 71,00 | 366 | 1 |
|---------|----------|-----------|--------------|------|-------|-----|---|



Sanitair producten

Baden /
douchebakken /
stoomcabines**contraplaat wandbeugel**

| | | | | | | | |
|---------|--|---------|--------------|------|-------|-----|---|
| 0606028 | | RVS-wit | LI0126503402 | stuk | 14,00 | 366 | 1 |
|---------|--|---------|--------------|------|-------|-----|---|



Kranen

toiletbeugel vast

| | | | | | | | |
|---------|------|-----|--------------|------|-------|-----|---|
| 0603767 | 60cm | wit | LI2601060102 | stuk | 65,00 | 366 | 1 |
|---------|------|-----|--------------|------|-------|-----|---|



Douchegarnituur

| | | | | | | | |
|---------|------|-----|--------------|------|--------|-----|---|
| 0603775 | 60cm | RVS | LI2601060200 | stuk | 111,00 | 366 | 1 |
|---------|------|-----|--------------|------|--------|-----|---|

| | | | | | | | |
|---------|------|-------|--------------|------|-------|-----|---|
| 0600997 | 60cm | grijs | LI2601060101 | stuk | 65,00 | 366 | 1 |
|---------|------|-------|--------------|------|-------|-----|---|

| | | | | | | | |
|---------|------|-----|--------------|------|-------|-----|---|
| 0603783 | 70cm | wit | LI2601070102 | stuk | 67,00 | 366 | 1 |
|---------|------|-----|--------------|------|-------|-----|---|

| | | | | | | | |
|---------|------|-----|--------------|------|--------|-----|---|
| 0603791 | 70cm | RVS | LI2601070200 | stuk | 117,00 | 366 | 1 |
|---------|------|-----|--------------|------|--------|-----|---|

Accessoires en
spiegels

| | | | | | | | |
|---------|------|-------|--------------|------|-------|-----|---|
| 0600385 | 70cm | grijs | LI2601070101 | stuk | 67,00 | 366 | 1 |
|---------|------|-------|--------------|------|-------|-----|---|

| | | | | | | | |
|---------|------|-----|--------------|------|-------|-----|---|
| 0603805 | 80cm | wit | LI2601080102 | stuk | 69,00 | 366 | 1 |
|---------|------|-----|--------------|------|-------|-----|---|

| | | | | | | | |
|---------|------|-----|--------------|------|--------|-----|---|
| 0603813 | 80cm | RVS | LI2601080200 | stuk | 122,00 | 366 | 1 |
|---------|------|-----|--------------|------|--------|-----|---|

Douchewanden

| | | | | | | | |
|---------|------|-------|--------------|------|-------|-----|---|
| 0600415 | 80cm | grijs | LI2601080101 | stuk | 69,00 | 366 | 1 |
|---------|------|-------|--------------|------|-------|-----|---|

| | | | | | | | |
|---------|------|-----|--------------|------|-------|-----|---|
| 0603821 | 90cm | wit | LI2601090102 | stuk | 71,00 | 366 | 1 |
|---------|------|-----|--------------|------|-------|-----|---|

| | | | | | | | |
|---------|------|-----|--------------|------|--------|-----|---|
| 0603848 | 90cm | RVS | LI2601090200 | stuk | 129,00 | 366 | 1 |
|---------|------|-----|--------------|------|--------|-----|---|

| | | | | | | | |
|---------|------|-------|--------------|------|-------|-----|---|
| 0600423 | 90cm | grijs | LI2601090101 | stuk | 71,00 | 366 | 1 |
|---------|------|-------|--------------|------|-------|-----|---|

toiletbeugel opklapbaar

| | | | | | | | |
|---------|------|-----|--------------|------|-------|-----|---|
| 0606006 | 60cm | wit | LI2603260102 | stuk | 84,00 | 366 | 0 |
|---------|------|-----|--------------|------|-------|-----|---|

Toebehoren &
afvoeren

| | | | | | | | |
|---------|------|-----|--------------|------|--------|-----|---|
| 0606081 | 60cm | RVS | LI2603260202 | stuk | 135,00 | 366 | 0 |
|---------|------|-----|--------------|------|--------|-----|---|

| | | | | | | | |
|---------|------|---------|--------------|------|--------|-----|---|
| 0606049 | 60cm | RVS-wit | LI2603260402 | stuk | 110,00 | 366 | 1 |
|---------|------|---------|--------------|------|--------|-----|---|

| | | | | | | | |
|---------|------|-----|--------------|------|-------|-----|---|
| 0606014 | 70cm | wit | LI2603270102 | stuk | 86,00 | 366 | 0 |
|---------|------|-----|--------------|------|-------|-----|---|

Spoel- &
installatiesystemen

| | | | | | | | |
|---------|------|-----|--------------|------|--------|-----|---|
| 0606103 | 70cm | RVS | LI2603270202 | stuk | 140,00 | 366 | 0 |
|---------|------|-----|--------------|------|--------|-----|---|

| | | | | | | | |
|---------|------|---------|--------------|------|--------|-----|---|
| 0606057 | 70cm | RVS-wit | LI2603270402 | stuk | 112,00 | 366 | 1 |
|---------|------|---------|--------------|------|--------|-----|---|

| | | | | | | | |
|---------|------|-----|--------------|------|-------|-----|---|
| 0606019 | 80cm | wit | LI2603280102 | stuk | 88,00 | 366 | 0 |
|---------|------|-----|--------------|------|-------|-----|---|

| | | | | | | | |
|---------|------|---------|--------------|------|--------|-----|---|
| 0606065 | 80cm | RVS-wit | LI2603280402 | stuk | 114,00 | 366 | 0 |
|---------|------|---------|--------------|------|--------|-----|---|

Badkamermeubelen
en toiletkasten

| | | | | | | | |
|---------|------|-----|--------------|------|--------|-----|---|
| 0606111 | 80cm | RVS | LI2603280202 | stuk | 145,00 | 366 | 0 |
|---------|------|-----|--------------|------|--------|-----|---|

| | | | | | | | |
|---------|------|-----|--------------|------|-------|-----|---|
| 0606035 | 90cm | wit | LI2603290102 | stuk | 90,00 | 366 | 0 |
|---------|------|-----|--------------|------|-------|-----|---|

| | | | | | | | |
|---------|------|-----|--------------|------|--------|-----|---|
| 0606138 | 90cm | RVS | LI2603290202 | stuk | 150,00 | 366 | 0 |
|---------|------|-----|--------------|------|--------|-----|---|

| | | | | | | | |
|---------|------|---------|--------------|------|--------|-----|---|
| 0606073 | 90cm | RVS-wit | LI2603290402 | stuk | 116,00 | 366 | 0 |
|---------|------|---------|--------------|------|--------|-----|---|

bevestigingsset voor beugelmontage 45°

| | | | | | | | |
|---------|--|-----|--------------|------|-------|-----|---|
| 0603899 | | wit | LI2607000102 | stuk | 95,00 | 366 | 1 |
|---------|--|-----|--------------|------|-------|-----|---|

Gootstenen en
wastroggen

| | | | | | | | |
|---------|--|-----|--------------|------|--------|-----|---|
| 0603902 | | RVS | LI2607000200 | stuk | 150,00 | 366 | 1 |
|---------|--|-----|--------------|------|--------|-----|---|

| | | | | | | | |
|---------|--|-------|--------------|------|-------|-----|---|
| 0600431 | | grijs | LI2607000101 | stuk | 95,00 | 366 | 1 |
|---------|--|-------|--------------|------|-------|-----|---|

vloerstatief voor opklapbare toiletbeugel

| | | | | | | | |
|---------|--|-----|--------------|------|-------|-----|---|
| 0602574 | | wit | LI2608000102 | stuk | 87,00 | 366 | 0 |
|---------|--|-----|--------------|------|-------|-----|---|



| | | | | | | | |
|---------|--|-----|--------------|------|--------|-----|---|
| 0603929 | | RVS | LI2608000202 | stuk | 146,00 | 366 | 1 |
|---------|--|-----|--------------|------|--------|-----|---|

| | | | | | | | |
|---------|--|-------|--------------|------|-------|-----|---|
| 0601020 | | grijs | LI2608000101 | stuk | 87,00 | 366 | 1 |
|---------|--|-------|--------------|------|-------|-----|---|

hulpvoet voor opklapbare beugel

| | | | | | | | |
|---------|--|-----|--------------|------|-------|-----|---|
| 0606146 | | wit | LI2614200102 | stuk | 43,00 | 366 | 0 |
|---------|--|-----|--------------|------|-------|-----|---|



| | | | | | | | |
|---------|--|-----|--------------|------|-------|-----|---|
| 0606162 | | RVS | LI2614200200 | stuk | 70,00 | 366 | 1 |
|---------|--|-----|--------------|------|-------|-----|---|

| | | | | | | | |
|---------|--|---------|--------------|------|-------|-----|---|
| 0606154 | | RVS-wit | LI2614200402 | stuk | 58,00 | 366 | 0 |
|---------|--|---------|--------------|------|-------|-----|---|

armlegger met lijmset

| | | | | | | | |
|---------|--|--------------|--------------|------|-------|-----|---|
| 0600563 | | zwart-schuim | LI2610001000 | stuk | 32,00 | 366 | 0 |
|---------|--|--------------|--------------|------|-------|-----|---|



| Art.nr | Specificaties | Kleur | Lev.nr | Ehd | Prijs | Grp | CC |
|---|---------------|-------|--------------|------|--------|-----|----|
| Linido utiliteit producten | | | | | | | |
| papegaai wegzwenkbaar voor muurbevestiging | | | | | | | |
| 0604313 | | wit | LI2613000102 | stuk | 152,00 | 366 | 1 |
| 0604321 | | RVS | LI2613000200 | stuk | 242,00 | 366 | 1 |
| 0601225 | | grijs | LI2613000101 | stuk | 152,00 | 366 | 1 |
| triangel voor plafondbevestiging | | | | | | | |
| 0604380 | | wit | LI2612000102 | stuk | 63,00 | 366 | 1 |
| 0604399 | | RVS | LI2612000200 | stuk | 85,00 | 366 | 1 |
| 0601217 | | grijs | LI2612000101 | stuk | 63,00 | 366 | 1 |
| rugleuning voor muurbevestiging | | | | | | | |
| 0606421 | 210-275mm | | LI2701200402 | stuk | 165,00 | 366 | 1 |
| 0606448 | 290-435mm | | LI2703200402 | stuk | 175,00 | 366 | 1 |
| closetrolhouder verstelbaar | | | | | | | |
| 0601012 | | RVS | LI2617000203 | stuk | 16,00 | 366 | 0 |
| wastafelmodule voor muurmontage verstelbaar: hoogte 25cm en diepte 8.6cm | | | | | | | |
| 0600849 | | wit | LI3012000402 | stuk | 840,00 | 366 | 1 |
| isolatieset wit | | | | | | | |
| 0601128 | M8x4 | | LI2880000602 | stuk | 3,00 | 366 | 1 |
| 0600180 | M6x4 | | LI2860000000 | stuk | 3,00 | 366 | 1 |
| 0601129 | M8x5 | | LI2881000602 | stuk | 6,00 | 366 | 1 |



Sanitair producten

Baden /
douchebakken /
stoomcabines

Kranen

Douchegarnituur

Accessoires en
spiegels

Douchewanden

Toebehoren &
afvoerenSpoel- &
installatiesystemenBadkamermeubelen
en toiletkastenGootstenen en
wastroggen

Utiliteit

| | Art.nr | Specificaties | Kleur | Lev.nr | Ehd | Prijs | Grp | CC |
|---|--|--------------------|--------------|----------|------|---------|-----|----|
| Sanitair producten | Pressalit Multi | | | | | | | |
| | douchestoel verstelbaar | | | | | | | |
| | 0604704 | | wit | R7142000 | stuk | 888,00 | 384 | 1 |
| | 0604720 | | rood | R7142035 | stuk | 888,00 | 384 | 1 |
| | 0604739 | | blauw | R7142108 | stuk | 888,00 | 384 | 1 |
| Baden / douchebakken / stoomcabines | douchestoel m. rugleuning en verstelbare armleggers | | | | | | | |
| | 0604747 | | wit | R7166000 | stuk | 1509,00 | 384 | 1 |
| | 0604763 | | rood | R7166035 | stuk | 1509,00 | 384 | 1 |
| | 0604771 | | blauw | R7166108 | stuk | 1509,00 | 384 | 1 |
| Douchegarnituur | douchezitje opklapbaar | | | | | | | |
| | 0604666 | | wit | R5010000 | stuk | 254,00 | 384 | 1 |
| | 0604682 | | rood | R5010035 | stuk | 254,00 | 384 | 1 |
| | 0604690 | | blauw | R5010108 | stuk | 254,00 | 384 | 1 |
| Accessoires en spiegels | multizitje verstelbaar | | | | | | | |
| | 0604495 | 250mm | wit | R5145000 | stuk | 420,00 | 384 | 1 |
| | wandbeugel | | | | | | | |
| | 0604798 | 30cm | wit | RT100000 | stuk | 65,00 | 384 | 1 |
| Douchewanden | 0604828 | 30cm | rood | RT100035 | stuk | 65,00 | 384 | 1 |
| | 0604836 | 30cm | blauw | RT100108 | stuk | 65,00 | 384 | 1 |
| | 0604844 | 45cm | wit | RT101000 | stuk | 70,00 | 384 | 1 |
| | 0604860 | 45cm | rood | RT101035 | stuk | 70,00 | 384 | 1 |
| | 0604879 | 45cm | blauw | RT101108 | stuk | 70,00 | 384 | 1 |
| | 0604887 | 60cm | wit | RT102000 | stuk | 81,50 | 384 | 1 |
| | 0604909 | 60cm | rood | RT102035 | stuk | 81,50 | 384 | 1 |
| | 0604917 | 60cm | blauw | RT102108 | stuk | 81,50 | 384 | 1 |
| Toebehoren & afvoeren | toiletsteun 85cm | | | | | | | |
| | 0604569 | opklapbaar z. veer | wit | R3018000 | stuk | 270,00 | 384 | 1 |
| | 0604585 | opklapbaar z. veer | rood | R3018035 | stuk | 270,00 | 384 | 1 |
| | 0604593 | opklapbaar z. veer | blauw | R3018108 | stuk | 270,00 | 384 | 1 |
| | 0604607 | opklapbaar m. veer | wit | RF018000 | stuk | 341,00 | 384 | 1 |
| | 0604623 | opklapbaar m. veer | rood | RF018035 | stuk | 341,00 | 384 | 1 |
| Badkamermeubelen en toiletkasten | closetrolhouder voor toiletsteun | | | | | | | |
| | 0604658 | | aluminium | R9320 | stuk | 29,25 | 384 | 1 |
| Gootstenen en wastroggen | wandrail aluminium horizontaal | | | | | | | |
| | 0604496 | 60cm | | R9901 | stuk | 81,50 | 384 | 1 |
| | 0604518 | 90cm | | R9902 | stuk | 107,00 | 384 | 1 |
| | 0604526 | 120cm | | R9903 | stuk | 127,00 | 384 | 1 |
| Utiliteit | wandrail aluminium verticaal | | | | | | | |
| | 0604534 | 60cm | | R9915 | stuk | 75,50 | 384 | 1 |
| | bevestigingsset voor wandrail | | | | | | | |
| | 0604542 | 60cm | m. 6 bouten | LA8801 | stuk | 14,25 | 384 | 1 |
| | 0604550 | 90cm/120cm | m. 10 bouten | LA8802 | stuk | 18,75 | 384 | 1 |

| Art.nr | Specificaties | Kleur | Lev.nr | Ehd | Prijs | Grp | CC |
|--------|---------------|-------|--------|-----|-------|-----|----|
|--------|---------------|-------|--------|-----|-------|-----|----|

Pressalit Rehab

wastafelrame m. gasveer hoog/laag
0604925

R1210000

stuk

769,00

384

1



Sanitair producten

consoles verstelbaar per set
0604933 34cm

R1214000

stuk

172,00

384

1



Baden /
douchebakken /
stoomcabines

Kranen

flexibele aansluitset
0604941

R2061

stuk

93,50

384

1



Douchegarnituur

Accessoires en
spiegels

Douchewanden









Toebehoren &
afvoeren

Spoel- &
installatiesystemen

Badkamermeubelen
en toiletkasten

Gootstenen en
wastroggen

Utiliteit

| | Art.nr | Specificaties | Kleur | Lev.nr | Ehd | Prijs | Grp | CC | |
|---|---|---|---------------|----------------|--------|--------|-----|----|--|
| Sanitair producten | Revato assortiment | | | | | | | | |
| |  | doucheraam opklapbaar m. wegklapbare poten 0604410 70x190cm | wit | R7728/190 | stuk | 618,00 | 366 | 1 | |
| Baden / douchebakken / stoomcabines | Futura douchezitting opklapbaar m. rugleuning 0602460 | | | | | | | | |
| | | | wit | R8803 | stuk | 208,00 | 366 | 1 | |
| Kranen | Futura douchezitting opklapbaar m. rugleuning m. armleggers 0602456 | | | | | | | | |
| | | | wit | R8804 | stuk | 237,00 | 366 | 1 | |
| Douchegarnituur | Futura douchezitting opklapbaar m. rugleuning m. armleggers m. steunpoten 0602462 | | | | | | | | |
| | | | wit | R880460 | stuk | 319,00 | 366 | 0 | |
| Douchestoel | douchestoel 52cm m. opklapbare armleuningen m. antisliplaag 0602465 | | | | | | | | |
| | | | wit | R7708073524545 | stuk | 313,00 | 366 | 1 | |
| Accessoires en spiegels | handgreep wit | | | | | | | | |
| |  | 0602469 40cm | | R7738S/40 | stuk | 35,00 | 366 | 0 | |
| Douchewanden | | 0605670 30cm m. kap wit | | R7760/30WHITE | stuk | 31,00 | 366 | 0 | |
| | | 0605662 30cm m. kap zwart | | R7760/30BLACK | stuk | 31,00 | 366 | 1 | |
| | | 0605689 30cm m. kap blauw | | R7760/30BLUE | stuk | 31,00 | 366 | 1 | |
| | | 0605700 40cm m. kap wit | | R7760/40WHITE | stuk | 33,00 | 366 | 0 | |
| | | 0605697 40cm m. kap zwart | | R7760/40BLACK | stuk | 33,00 | 366 | 1 | |
| | | 0605719 40cm m. kap blauw | | R7760/40BLUE | stuk | 33,00 | 366 | 1 | |
| | | 0605735 50cm m. kap wit | | R7760/50WHITE | stuk | 34,00 | 366 | 1 | |
| | | 0605727 50cm m. kap zwart | | R7760/50BLACK | stuk | 34,00 | 366 | 1 | |
| | | 0605743 50cm m. kap blauw | | R7760/50BLUE | stuk | 34,00 | 366 | 1 | |
| | | 0602578 60cm m. kap wit | | R7760/60WHITE | stuk | 38,00 | 366 | 1 | |
| Toebehoren & afvoeren | | 0602576 60cm m. kap zwart | | R7760/60BLACK | stuk | 38,00 | 366 | 1 | |
| | | 0602580 60cm m. kap blauw | | R7760/60BLUE | stuk | 38,00 | 366 | 1 | |
| Spoel- & installatiesystemen |  | | | | | | | | |
| |  | | | | | | | | |
| Badkamermeubelen en toiletkasten |  | | | | | | | | |
| |  | | | | | | | | |
| Gootstenen en wastroggen |  | | | | | | | | |
| |  | | | | | | | | |
| Utiliteit | kozijn handgreep wit 0602490 30cm | | | | | | | | |
| | | | | R7738S/30 | stuk | 34,00 | 366 | 0 | |
| | wastafelbeugel 0602480 60x46cm | | | | | | | | |
| | | | wit | A7739 | stuk | 216,00 | 366 | 1 | |
|  | toiletbeugel opklapbaar | | | | | | | | |
| | | 0605786 70cm | wit/wit | R7762/70WHITE | stuk | 85,00 | 366 | 0 | |
| | | 0605778 70cm | wit/zwart | R7762/70BLACK | stuk | 85,00 | 366 | 1 | |
| | | 0605794 70cm | wit/blauw | R7762/70BLUE | stuk | 85,00 | 366 | 1 | |
| | | 0605816 80cm | wit/wit | R7762/80WHITE | stuk | 90,00 | 366 | 0 | |
| | | 0605808 80cm | wit/zwart | R7762/80BLACK | stuk | 90,00 | 366 | 1 | |
| | | 0605824 80cm | wit/blauw | R7762/80BLUE | stuk | 90,00 | 366 | 1 | |
| | | 0605867 90cm | wit/wit | R7762/90WHITE | stuk | 93,00 | 366 | 1 | |
| | | 0605859 90cm | wit/zwart | R7762/90BLACK | stuk | 93,00 | 366 | 1 | |
| | | 0605875 90cm | wit/blauw | R7762/90BLUE | stuk | 93,00 | 366 | 1 | |
| | | toiletbeugel m. rol m. steun | | | | | | | |
| | | 0602582 60cm | wit/wit | R7773/60WHITE | stuk | 138,00 | 366 | 1 | |
| | 0602584 70cm | wit/wit | R7773/70WHITE | stuk | 140,00 | 366 | 1 | | |
| | 0602586 80cm | wit/wit | R7773/80WHITE | stuk | 142,00 | 366 | 1 | | |

| Art.nr | Specificaties | Kleur | Lev.nr | Ehd | Prijs | Grp | CC |
|---|-------------------|-------|------------|------|---------|-----|----|
| Revato assortiment | | | | | | | |
| toiletverhoger instelbaar z. armsteunen | | | | | | | |
| 0602892 | 6-10-14cm | wit | H430/1 | stuk | 127,00 | 366 | 1 |
| toiletverhoger instelbaar m. opklapbare armsteunen | | | | | | | |
| 0602906 | 6-10-14cm | wit | H430A/2 | stuk | 200,00 | 366 | 1 |
| toiletrolhouder | | | | | | | |
| 0605891 | m. afdekkap wit | wit | R7765WHITE | stuk | 15,00 | 366 | 0 |
| 0605913 | m. afdekkap zwart | wit | R7765BLACK | stuk | 15,00 | 366 | 1 |
| 0605905 | m. afdekkap blauw | wit | R7765BLUE | stuk | 15,00 | 366 | 1 |
| muurbevestigingsset compleet | | | | | | | |
| 0602523 | | RVS | R6600 | stuk | 7,00 | 366 | 0 |
| vloerbevestigingsset compleet | | | | | | | |
| 0602515 | | RVS | R6610 | stuk | 28,00 | 366 | 1 |
| kunststof sierstuk | | | | | | | |
| 0605964 | | blauw | R7767BLUE | stuk | 6,00 | 366 | 1 |
| 0605948 | | zwart | R7767BLACK | stuk | 6,00 | 366 | 1 |
| 0605956 | | wit | R7767WHITE | stuk | 6,00 | 366 | 1 |
| armlegger per stuk | | | | | | | |
| 0605921 | | | R7766 | stuk | 38,00 | 366 | 1 |
| bevestigingsset los | | | | | | | |
| 0605751 | voor handgreep | | R6660 | stuk | 10,00 | 366 | 1 |
| 0605883 | voor toiletbeugel | | R6670 | stuk | 6,00 | 366 | 1 |
| verstelbaar wastafelsysteem | | | | | | | |
| 0602504 | | | HL1 | stuk | 1540,00 | 366 | 1 |
| 0602505 | | | HS2 | stuk | 1700,00 | 366 | 1 |



Sanitair producten

Baden /
douchebakken /
stoomcabines

Kranen

Douchegarnituur

Accessoires en
spiegels

Douchewanden

Toebehoren &
afvoerenSpoel- &
installatiesystemenBadkamermeubelen
en toiletkastenGootstenen en
wastroggen

Utiliteit

| Art.nr | Specificaties | Kleur | Lev.nr | Ehd | Prijs | Grp | CC |
|--------------------------------|---------------|--------------|---------|------|--------|-----|----|
| Riho douchezitje | | | | | | | |
| douchezitje, opklapbaar | | | | | | | |
| 0310450 | | wit | AS01105 | stuk | 100,00 | 134 | 1 |
| 0310451 | | zwart/chroom | AS02111 | stuk | 285,00 | 134 | 1 |

Sanitair producten

Baden /
douchebakken /
stoomcabines

Kranen

Douchegarnituur

Accessoires en
spiegels

Douchewanden

Toebehoren &
afvoeren

Spoel- &
installatiesystemen

Badkamermeubelen
en toiletkasten

Gootstenen en
wastroggen

Utiliteit

| Art.nr | Specificaties | Kleur | Lev.nr | Ehd | Prijs | Grp | CC |
|--|---------------|-------|---------------------|------|---------|-----|----|
| Aqua zelfsluitende kranen | | | | | | | |
| Aqualine zelfsluitende douchekraan 1/2" inbouw 0720430 | | chrom | 23381023 | stuk | 130,00 | 383 | 1 |
| Aqualine zelfsluitende douchekraan 1/2" binnendraad opbouw 0720406 | | chrom | 23012023 | stuk | 125,00 | 383 | 1 |
| Aqualine zelfsluitende wastafelkraan 1/2" voor wasinrichtingen 0720450 | | chrom | 21801023 | stuk | 132,00 | 383 | 1 |
| zelfsluitende knie-afsluiter 1/2" voor wasinstallatie 0720407 | | chrom | 21060823 | stuk | 425,00 | 383 | 1 |
| zelfsluitende knie-afsluiter 1/2" voor wasinstallatie inbouw 0720408 | | | 21120823 | stuk | 530,00 | 383 | 1 |
| Aqua douchekoppen | | | | | | | |
| douchekop 1/2" m. antikalk straalbodem voor wandaansluiting inbouw 0720409 | | | 13516123 | stuk | 92,00 | 383 | 1 |
| douchekop 1/2" m. antikalk straalbodem voor opbouwleidingen opbouw 0720411 | | | 13506523 | stuk | 152,00 | 383 | 1 |
| Aqua opto elektronische wastafelkranen | | | | | | | |
| Protronic infrarood wastafelkraan 0720412 | | chrom | 51800023 | stuk | 411,00 | 383 | 1 |
| 0720413 | | chrom | 51810023 | stuk | 366,00 | 383 | 1 |
| Aqua elektronische besturingen | | | | | | | |
| 3000 centrale sanitairbesturing m. bedieningsdisplay 0720415 | | | 4244000000904 | stuk | 1045,00 | 383 | 1 |
| Aquamat infrarood wastafelkraan 1/2" 0720416 | | chrom | 51441823 | stuk | 920,00 | 383 | 1 |
| 0720417 | | chrom | 51451823 | stuk | 783,00 | 383 | 1 |
| Aquamat elektronische wastafelarmatuur 0720418 | | | 5148082402 | stuk | 616,00 | 383 | 1 |
| Aquatimer elektronische douchearmatuur inbouw compleet 0720419 | | | 40560824R+40560824F | stuk | 443,00 | 383 | 1 |
| Aquatimer elektronische thermostaatkraan 1/2" inbouw compleet 0720420 | | | 40572824R+40572824F | stuk | 799,00 | 383 | 1 |
| Aquatimer elektronische douchearmatuur 0720421 | | | 40710824 | stuk | 290,00 | 383 | 1 |
| Aquatimer elektronische douchearmatuur vandaalbestendig 0720422 | | | 40700824 | stuk | 688,00 | 383 | 1 |
| magneetventiel 24V 0720423 1/2" | | | 40040421 | stuk | 367,00 | 383 | 1 |
| 0720424 3/4" | | | 40040431 | stuk | 387,00 | 383 | 1 |
| 0720425 1" | | | 40040441 | stuk | 436,00 | 383 | 1 |
| Aquatimer douchecombinatie 1/2" 0720426 | | | 40680824 | stuk | 910,00 | 383 | 1 |
| Aquatimer douchethermostaat combinatie 1/2" 0720427 | | | 40691824 | stuk | 1539,00 | 383 | 1 |
| Protronic urinoirplaat 24V 0720452 | | | 55260824F | stuk | 548,00 | 383 | 1 |
| Aquatimer elektronische wc-besturing 0720428 | | | 40650824 | stuk | 654,00 | 383 | 1 |
| Aquamat elektronische wc-besturing contactloos 0720431 | | | 56140824 | stuk | 684,00 | 383 | 1 |

Sanitair producten

Baden /
douchebakken /
stoomcabines

Kranen

Douchegarnituur

Accessoires en
spiegels

Douchewanden

Toebehoren &
afvoerenSpoel- &
installatiesystemenBadkamermeubelen
en toiletkastenGootstenen en
wastroggen

Utiliteit

| | Art.nr | Specificaties | Kleur | Lev.nr | Ehd | Prijs | Grp | CC |
|---|------------------------|------------------------------------|-------|------------|------|--------|-----|----|
| | Aqua Toebehoren | | | | | | | |
| Sanitair producten | 0720432 | 3000 stroomvoorziening 230V | | 48411000 | stuk | 222,00 | 383 | 1 |
| | 0720433 | Aquanet service aansluitdoos | | 48560800 | stuk | 226,00 | 383 | 1 |
| | 0720434 | Aquanet organizer m. display | | 8403201244 | stuk | 704,00 | 383 | 1 |
| | 0720435 | Aqua elektronische tijdschakelklok | | 48123100 | stuk | 194,00 | 383 | 1 |
| Baden / douchebakken / stoomcabines | 0720437 | Aquanet veldbuskabel 10meter | | 8403212184 | stuk | 31,50 | 383 | 1 |
| | 0720438 | Aquanet veldbuskabel 25meter | | 8403212185 | stuk | 73,50 | 383 | 1 |
| | 0720436 | Aquanet veldbuskabel 100meter | | 8403212186 | stuk | 249,00 | 383 | 1 |
| | 0720439 | Aquanet adapterkabel Type A | | 8410007852 | stuk | 99,50 | 383 | 1 |
| Kranen | 0720440 | Aquanet adapterkabel Type B | | 10007853 | stuk | 156,00 | 383 | 1 |
| | 0720441 | Aquanet interfaceconvector | | 03201246 | stuk | 492,00 | 383 | 1 |
| | 0720449 | thermostaatvoeler AT90 | | 8803201277 | stuk | 167,00 | 383 | 1 |
| | | | | | | | | |
| Douchegarnituur | | | | | | | | |
| Accessoires en spiegels | | | | | | | | |
| Douchewanden | | | | | | | | |
| Toebehoren & afvoeren | | | | | | | | |
| Spoel- & installatiesystemen | | | | | | | | |
| Badkamermeubelen en toiletkasten | | | | | | | | |
| Gootstenen en wastroggen | | | | | | | | |
| Utiliteit | | | | | | | | |

| Art.nr | Specificaties | Kleur | Lev.nr | Ehd | Prijs | Grp | CC |
|--------|---------------|-------|--------|-----|-------|-----|----|
|--------|---------------|-------|--------|-----|-------|-----|----|

| | | | | | | | |
|-------------------------------------|--|--|--|--|--|--|--|
| VSH zeepdispenser Little Joe | | | | | | | |
|-------------------------------------|--|--|--|--|--|--|--|

| | | | | | | | |
|----------------------|-----------------|--------|---------|------|-------|-----|---|
| zeepdispenser | | | | | | | |
| 0620076 | m. uitloop 70mm | chroom | 4202000 | stuk | 67,00 | 247 | 1 |



Sanitair producten

Baden /
douchebakken /
stoomcabines

Kranen









Douchegarnituur











Accessoires en
spiegels

Douchewanden

Toebehoren &
afvoerenSpoel- &
installatiesystemenBadkamermeubelen
en toiletkastenGootstenen en
wastroggen

Utiliteit

| | Art.nr | Specificaties | Kleur | Lev.nr | Ehd | Prijs | Grp | CC | |
|---|---|--|--------------------------|--------|---------|--------|--------|--------|-------|
| Sanitair producten | Franke RVS | | | | | | | | |
| |  | douchebak 90x90cm 0910724 | | RVS | BS401 | stuk | 292,00 | 373 1 | |
| Baden / douchebakken / stoomcabines | babybad inleg m. overloop 0910848 | | | | | | | | |
| | | | | RVS | BS431 | stuk | 598,00 | 369 1 | |
| Kranen |  | wastafel 55x45cm 0910015 | m. plug 6/4" z. overloop | RVS | BS204 | stuk | 360,00 | 369 1 | |
| | | 0910023 | m. plug 6/4" m. overloop | RVS | BS205 | stuk | 379,00 | 369 1 | |
| Douchegarnituur |  | sifonkap voor wastafel nr.BS204 en BS205 0910066 | | RVS | BS206 | stuk | 260,00 | 369 1 | |
| Accessoires en spiegels | | | | | | | | | |
| Douchewanden |  | planchet RVS | | | | | | | |
| | | 0910392 | 60x14cm m. bevestiging | | BXSV6 | stuk | 88,50 | 369 1 | |
| | | 0910619 | 120x14cm m. bevestiging | | BXSV12 | stuk | 134,00 | 369 1 | |
| | | 0910643 | m. bevestiging | | BXSV18 | stuk | 172,00 | 369 1 | |
| Toebehoren & afvoeren | spoelbak Belrondo 0910091 | | | | | | | | |
| | | 33/28x160mm | | RVS | BR2800U | stuk | 218,00 | 373 1 | |
| Spoel- & installatiesystemen | spiegel 50x40cm 0910044 | | | | | | | | |
| | | m. onderlijming | | RVS | M500R | stuk | 108,00 | 369 1 | |
| | spiegel 60x50cm | | | | | | | | |
| | 0910806 | m. onderlijming | | RVS | M600R | stuk | 130,00 | 369 1 | |
| | 0910076 | m. blinde bevestiging | | RVS | M600HD | stuk | 208,00 | 369 1 | |
| Badkamermeubelen en toiletkasten |  | zeepbakje | | | | | | | |
| | | 0910759 | z. bodemgaatjes | | RVS | BS647 | stuk | 19,00 | 369 1 |
| | | 0910740 | m. bodemgaatjes | | RVS | BS646 | stuk | 21,50 | 369 1 |
| Gootstenen en wastroggen | zeepdispenser 0910779 | | | | | | | | |
| | | 13x12.7x30cm | | RVS | SD300 | stuk | 456,00 | 369 1 | |
| Utiliteit | closetborstelhouder 0910785 | | | | | | | | |
| | | | | RVS | STRX687 | stuk | 108,00 | 369 1 | |
| |  | jashaak | | | | | | | |
| | | 0910783 | enkel | | RVS | BS690 | stuk | 26,50 | 369 1 |
| | | 0910791 | dubbel | | RVS | BS691 | stuk | 30,25 | 369 1 |
| |  | wandasbak 0910732 | | | RVS | BS640 | stuk | 49,25 | 369 1 |
| |  | papierhanddoekhouder 0910805 | | | RVS | BS600P | stuk | 171,00 | 369 1 |

| Art.nr | Specificaties | Kleur | Lev.nr | Ehd | Prijs | Grp | CC | |
|---|-----------------------|-------|---------------|------|---------|-----|----|---|
| Franke RVS | | | | | | | | |
| afvalbak | | | | | | | | |
| 0910813 | met klapdeksel | RVS | BS603S | stuk | 218,00 | 369 | 1 |  |
| 0910814 | m. slot 36x46x17.5cm | RVS | BS605 | stuk | 218,00 | 369 | 1 | |
| 0910778 | Belrondo 41x20.5x38cm | RVS | BS609 | stuk | 341,00 | 369 | 1 | |
| closetrolhouder opbouw | | | | | | | | |
| 0910776 | voor 2 rollen | RVS | CHRX672BS671 | stuk | 157,00 | 369 | 1 | |
| closetrolhouder inbouw | | | | | | | | |
| 0910028 | voor 2 rollen | RVS | CHRX672EBS672 | stuk | 182,00 | 369 | 1 | |
| console voor aanrecht 70cm | | | | | | | | |
| 0910105 | | RVS | 680RVS | stuk | 116,00 | 369 | 1 | |
| Franke Xinox | | | | | | | | |
| wastafel m. afdruipegedeelte rechts | | | | | | | | |
| 0910039 | | RVS | XINH200 | stuk | 2172,00 | 369 | 1 |  |
| wastafel m. afdruipegedeelte links | | | | | | | | |
| 0910040 | | RVS | XINH201 | stuk | 2172,00 | 369 | 1 |  |
| sifon voor wastafel XINH 200/201 | | | | | | | | |
| 0910041 | | RVS | XINX140 | stuk | 109,00 | 369 | 1 |  |
| planchet m. verlaagd gedeelte rechts | | | | | | | | |
| 0910042 | | RVS | XINH600 | stuk | 1371,00 | 369 | 1 |  |
| planchet m. verlaagd gedeelte links | | | | | | | | |
| 0910045 | | RVS | XINH601 | stuk | 1371,00 | 369 | 1 |  |
| wandclosetpot diepspoel z. closetzitting | | | | | | | | |
| 0910048 | | RVS | XINH519 | stuk | 1648,00 | 373 | 1 |  |
| wandclosetpot diepspoel m. acrylglas closetzitting | | | | | | | | |
| 0910049 | | RVS | XINH521 | stuk | 1920,00 | 373 | 1 |  |
| wandurinoir vandaalbestendig | | | | | | | | |
| 0910050 | | RVS | XINX530 | stuk | 1318,00 | 369 | 1 |  |
| wandbidet m. horizontale uitlaat | | | | | | | | |
| 0910047 | | RVS | XINH570 | stuk | 1098,00 | 373 | 1 |  |

Sanitair producten

Baden /
douchebakken /
stoomcabines

Kranen

Douchegarnituur

Accessoires en
spiegels

Douchewanden

Toebehoren &
afvoeren



Spoel- &
installatiesystemen

Badkamermeubelen
en toiletkasten

Gootstenen en
wastroggen

Utiliteit

| | Art.nr | Specificaties | Kleur | Lev.nr | Ehd | Prijs | Grp | CC |
|---|---------------------|---|-------------|---------|------|--------|-----|----|
| Sanitair producten | Franke Xinox | | | | | | | |
| | | schaamschot 47x151cm | | | | | | |
| | 0910051 | | matglas/RVS | XINV701 | stuk | 989,00 | 369 | 1 |
| Baden / douchebakken / stoomcabines | | spiegel m. RVS bevestiging 60x60cm | | | | | | |
| | 0910052 | | | XINV600 | stuk | 294,00 | 369 | 1 |
| Kranen | | spiegel m. RVS bevestiging 85x60cm | | | | | | |
| | 0910053 | | | XINV603 | stuk | 328,00 | 369 | 1 |
| Douchegarnituur | | spiegel m. RVS bevestiging 110x50cm | | | | | | |
| | 0910054 | | | XINV604 | stuk | 361,00 | 369 | 1 |
| Accessoires en spiegels | | handdoekdispenser m. slot | | | | | | |
| | 0910056 | | RVS | XINX600 | stuk | 328,00 | 369 | 1 |
| Toebehoren & afvoeren | | afvalbak 26.8x47cm inhoud 30liter | | | | | | |
| | 0910057 | | RVS | XINX606 | stuk | 548,00 | 369 | 1 |
| Spoel- & installatiesystemen | | afvalbak 26.8x14.5x40cm inhoud 20liter | | | | | | |
| | 0910059 | | RVS | XINX607 | stuk | 548,00 | 369 | 1 |
| Badkamermeubelen en toiletkasten | | afvalbak 34x67cm inhoud 60liter | | | | | | |
| | 0910058 | | RVS | XINX608 | stuk | 768,00 | 369 | 1 |
| Gootstenen en wastroggen | | hygiene zakjes dispenser | | | | | | |
| | 0910061 | | RVS | XINX615 | stuk | 190,00 | 369 | 1 |
| Utiliteit | | zeepdispenser voor vloeibare zeep | | | | | | |
| | 0910060 | | RVS | XINX617 | stuk | 328,00 | 369 | 1 |

| Art.nr | Specificaties | Kleur | Lev.nr | Ehd | Prijs | Grp | CC | |
|---|---------------|-------|---------|------|--------|-----|----|---|
| | | | | | | | | Franke Xinox |
| closetrolhouder m. slot voor 2 rollen 0910063 | | RVS | XINX672 | stuk | 328,00 | 369 | 1 |  |
| closetrolhouder 0910062 | | RVS | XINX677 | stuk | 218,00 | 369 | 1 |  |
| closetborstelgarnituur 0910064 | | RVS | XINX687 | stuk | 274,00 | 369 | 1 |  |
| kruk m. 4 vloerdoppen rubber 0910046 | | RVS | XINX800 | stuk | 768,00 | 369 | 1 |  |

- Sanitair producten
- Baden /
douchebakken /
stoomcabines
- Kranen
- Douche­garnituur
- Accessoires en
spiegels
- Douchewanden
- Toebehoren &
afvoeren
- Spoel- &
installatiesystemen
- Badkamermeubelen
en toiletkasten
- Gootstenen en
wastroggen
- Utiliteit

| | Art.nr | Specificaties | Kleur | Lev.nr | Ehd | Prijs | Grp | CC |
|---|--|--------------------|-------|---------|------|-------|-----|----|
| | CWS papier- en zeepautomaten | | | | | | | |
| Sanitair producten | BestPaper Slim servethouder (300 st) | | | | | | | |
| | 0590010 | kunststof | wit | 5612000 | stuk | 55,00 | 369 | 1 |
| | BestPaper Universal servethouder (500 st) | | | | | | | |
| | 0590002 | kunststof | wit | 5601000 | stuk | 87,00 | 369 | 1 |
| Baden / douchebakken / stoomcabines | Dual toiletpapierautomaat v. 2 rollen | | | | | | | |
| | 0590053 | kunststof | wit | 5604000 | stuk | 88,50 | 369 | 1 |
| Kranen | BestCream Universal zeepdispenser | | | | | | | |
| | 0590088 | 1liter kunststof | wit | 5001000 | stuk | 97,50 | 369 | 1 |
| Douchegarnituur | BestCream zeepdispenser | | | | | | | |
| | 0590061 | 0.5liter kunststof | wit | 5002000 | stuk | 71,00 | 369 | 1 |
| Accessoires en spiegels | | | | | | | | |
| Douchewanden | | | | | | | | |
| Toebehoren & afvoeren | | | | | | | | |
| Spoel- & installatiesystemen | | | | | | | | |
| Badkamermeubelen en toiletkasten | | | | | | | | |
| Gootstenen en wastroggen | | | | | | | | |
| Utiliteit | | | | | | | | |

| Art.nr | Specificaties | Kleur | Lev.nr | Ehd | Prijs | Grp | CC |
|--|---------------|-------|------------|------|-------|-----|----|
| Wisa water saving system | | | | | | | |
| bedieningspaneel voor inbouwreservoir 2136/2936 | | | | | | | |
| 0702943 | | wit | 8050420730 | stuk | 50,50 | 333 | 1 |
| 0702951 | | chrom | 8050420759 | stuk | 50,50 | 333 | 1 |



Sanitair producten

Baden /
douchebakken /
stoomcabines

Kranen

Douchegarnituur

Accessoires en
spiegels

Douchewanden

Toebehoren &
afvoerenSpoel- &
installatiesystemenBadkamermeubelen
en toiletkastenGootstenen en
wastroggen

Utiliteit

| | | | | | | | |
|---|------------------------|---------|------------|------|--------|-----|---|
| Sphinx Duoflux water saving system | | | | | | | |
| stroomvergroter | | | | | | | |
| 0160040 | geschikt voor laagbouw | 14liter | 9100902050 | stuk | 202,00 | 333 | 1 |

| | Art.nr | Specificaties | Kleur | Lev.nr | Ehd | Prijs | Grp | CC |
|--|--|---|-------|----------|------|--------|-----|----|
| Sanitair producten | Rada douchekoppen vandaalbestendig | | | | | | | |
| | douchekop vandaalbestendig | | | | | | | |
| | 0480126 | inbouw 6 l/min | chrom | VR106 | stuk | 89,50 | 369 | 0 |
| | 0480129 | opbouw onderaansluiting | | VR145 | stuk | 146,00 | 369 | 1 |
| | 7286138 | opbouw bovenaansluiting | | VR125 | stuk | 146,00 | 369 | 1 |
| Baden / douchebakken / stoomcabines | Rada accessoires | | | | | | | |
| | 7286140 | stijgpijp verchromd RVS 74cm | | 10177 | stuk | 15,75 | 369 | 1 |
| | 0480124 | stijgpijp verchromd RVS 122cm | | 10148 | stuk | 25,50 | 369 | 1 |
| | 0480127 | klemkoppeling 1/2"x15mm chrom | | 99980 | stuk | 13,25 | 369 | 1 |
| Kranen | 0480070 | knelkoppeling 3/4"x15mm chrom | | 27388 | stuk | 6,80 | 369 | 0 |
| | Douchegarnituur | Rada straaldouchekoppen vandaalbestendig | | | | | | |
| straaldouchekop vandaalbestendig 1/2" | | | | | | | | |
| | 0480045 | inbouw | chrom | VR12 | stuk | 106,00 | 369 | 1 |
| Accessoires en spiegels | straaldouchekop vandaalbestendig m. remstukje | | | | | | | |
| | 0480047 | inbouw | | VR1210 | stuk | 110,00 | 369 | 1 |
| Douchewanden | Rada accessoires | | | | | | | |
| | 0480049 | verstevigingsset voor VR-serie | | 93694 | stuk | 28,00 | 369 | 1 |
| Toebehoren & afvoeren | Rada straaldouchekoppen | | | | | | | |
| | straaldouchekop 1/2" | | | | | | | |
| | 0480061 | m. knie en rozet | chrom | SH1760 | stuk | 73,00 | 369 | 1 |
| Spoel- & installatiesystemen | straaldouchekop m. aansluitbocht m. rozet m. remplaatje | | | | | | | |
| | 0480046 | | | SH171060 | stuk | 77,50 | 369 | 1 |
| Badkamermeubelen en toiletkasten | straaldouchekop 1/2" | | | | | | | |
| | 0480053 | binnendraad | chrom | SH17 | stuk | 53,00 | 369 | 1 |
| Gootstenen en wastroggen | Rada douchekopset | | | | | | | |
| | douchekopset 1/2" | | | | | | | |
| | 0480304 | voor inbouw m. knie en rozet | chrom | 87420 | stuk | 56,00 | 369 | 1 |
| Utiliteit | Rada douchekoppen | | | | | | | |
| | douchekop 1/2" | | | | | | | |
| | 0480282 | m. kogelgewricht bi. | chrom | 87201 | stuk | 41,50 | 369 | 0 |
| | 0480290 | m. kogelgewricht bu. | chrom | 872 | stuk | 31,25 | 369 | 0 |
| | 0480002 | vast buitendraad | chrom | 92701 | stuk | 41,50 | 369 | 1 |
| | 0480010 | vast buitendraad | chrom | 927 | stuk | 31,25 | 369 | 0 |

| Art.nr | Specificaties | Kleur | Lev.nr | Ehd | Prijs | Grp | CC |
|---|-----------------------------------|-------|--------|------|-------|-----|----|
| Rada response | | | | | | | |
| handdouche m. antikalk kiwa | | | | | | | |
| 0480128 | | wit | RF1 | stuk | 33,00 | 369 | 1 |
| Rada diverse doorstroombegrenzers + Onderdelen | | | | | | | |
| 0480094 | doorstroombegrenzer 6 l/min grijs | | 85734 | stuk | 11,00 | 369 | 1 |
| 0480088 | remstukje 2.5mm wit | | 008 | stuk | 1,10 | 369 | 0 |
| 0480096 | remstukje 3mm zwart | | 009 | stuk | 1,10 | 369 | 1 |
| 0480097 | remstukje 10 l/min blauw | | 010 | stuk | 4,30 | 369 | 1 |
| 0480039 | sproeiplateetset SH17/VR12 | | 032 | stuk | 5,90 | 369 | 1 |
| 0480040 | sproeiplateetset VR1020 zwart | | 93587 | stuk | 12,25 | 369 | 1 |
| 0400098 | sproeiplateetset VR10/VR14 grijs | | 93695 | stuk | 10,50 | 369 | 1 |
| 0480015 | sproeiplateet VR105/VR106 grijs | | 93722 | stuk | 11,00 | 369 | 1 |
| Rada vasa douchekoppen m. kogelgewricht en Flowfix | | | | | | | |
| Vasa douchekop 9 l/min oranje | | | | | | | |
| 0480001 | | | 0823 | stuk | 40,25 | 369 | 1 |

Sanitair producten

Baden /
douchebakken /
stoomcabines

Kranen

Douchegarnituur

Accessoires en
spiegels

Douchewanden

Toebehoren &
afvoerenSpoel- &
installatiesystemenBadkamermeubelen
en toiletkastenGootstenen en
wastroggen

Utiliteit

| | Art.nr | Specificaties | Kleur | Lev.nr | Ehd | Prijs | Grp | CC |
|--|--|---------------|--------|--------|--------|--------|-----|----|
| Sanitair producten | Presto mechanische zelfsluitende tapkranen | | | | | | | |
| | zelfsluitende tapkraan 1/2" | | | | | | | |
| | 0480673 | koud 2010 | chroom | 20100 | stuk | 112,00 | 369 | 1 |
| | 0480681 | warm 2010 | chroom | 20102 | stuk | 112,00 | 369 | 1 |
| | 0480649 | koud 504 | chroom | 63000 | stuk | 56,50 | 369 | 1 |
| Baden / douchebakken / stoomcabines | 0480657 | warm 504 | chroom | 63020 | stuk | 56,50 | 369 | 1 |
| | zelfsluitende tapkraan koud/warm 1/2" | | | | | | | |
| | 0480658 | | | 63200 | stuk | 56,50 | 369 | 1 |
| Kranen | Presto mechanische zelfsluitende wastafelkranen | | | | | | | |
| | zelfsluitende toiletkraan 1/2" | | | | | | | |
| | 0480703 | koud 2000 | chroom | 20000 | stuk | 118,00 | 369 | 1 |
| Douchegarnituur | 0480665 | koud 605 | chroom | 64602 | stuk | 75,50 | 369 | 1 |
| | Presto knie en voetbediende kranen | | | | | | | |
| Accessoires en spiegels | kniebedieningskraan 1/2" | | | | | | | |
| | 0480705 | | chroom | 31681 | stuk | 105,00 | 369 | 1 |
| Douchewanden | voetbedieningskraan 10mm | | | | | | | |
| | 0480121 | | chroom | 23100 | stuk | 109,00 | 369 | 1 |
| Toebehoren & afvoeren | Presto uitlopen | | | | | | | |
| | wanduitloop kort binnendraad 1/2" | | | | | | | |
| | 0481022 | | | 30903 | stuk | 38,00 | 369 | 1 |
| | wastafeluitloop vast 1/2" | | | | | | | |
| | 0480710 | | | 60302 | stuk | 73,50 | 369 | 1 |
| Spoel- & installatiesystemen | Presto mechanische zelfsluitende tapkranen S-serie | | | | | | | |
| | zelfsluitende tapkraan 1/2" | | | | | | | |
| | 0480738 | warm 504S | chroom | 63120 | stuk | 70,00 | 369 | 1 |
| | 0480754 | koud 2010S | chroom | 20101 | stuk | 129,00 | 369 | 1 |
| Badkamermeubelen en toiletkasten | 0480762 | warm 2010S | chroom | 20103 | stuk | 129,00 | 369 | 1 |
| | Presto mechanische zelfsluitende wastafelkranen S-serie | | | | | | | |
| | zelfsluitende toiletkraan 1/2" | | | | | | | |
| | 0480770 | koud 2000S | chroom | 20001 | stuk | 135,00 | 369 | 1 |
| Gootstenen en wastroggen | Meltronic elektronische zelfsluitende systemen voor wastafels | | | | | | | |
| | zelfsluitend systeem voor wastafel inbouw SA142WBC | | | | | | | |
| Utiliteit | 0480576 | | | 277240 | stuk | 500,00 | 369 | 1 |
| | pulse systeem 120 wandmontage | | | | | | | |
| | 0480992 | | | 277973 | stuk | 216,00 | 369 | 0 |
| | zelfsluitend systeem voor wastafel inbouw SA142WBC | | | | | | | |
| | 0480584 | | | 277718 | stuk | 366,00 | 369 | 1 |
| | pulse centrale besturingskast | | | | | | | |
| | 0480993 | | | 277350 | stuk | 729,00 | 369 | 0 |
| Pulse programeerset voor besturingskast | | | | | | | | |
| 0480526 | | | 277351 | stuk | 191,00 | 369 | 1 | |

| Art.nr | Specificaties | Kleur | Lev.nr | Ehd | Prijs | Grp | CC |
|--|-------------------------|-------|--------|------|--------|-----|----|
| Presto mechanische zelfsluitende systemen voor douches | | | | | | | |
| inbouw douchekraan 1/2" buitendraad 500SB | | | | | | | |
| 0481084 | | | 38340 | stuk | 177,00 | 369 | 0 |
| revisieset voor Presto-50/50B | | | | | | | |
| 0720014 | | | 90104 | stuk | 13,00 | 369 | 1 |
| rozet RVS 50B | | | | | | | |
| 0480012 | | | 90126 | stuk | 47,50 | 369 | 1 |
| aansluitbocht 90 gr. 1/2"bu x 3/4" | | | | | | | |
| 7286106 | | | 06216 | stuk | 26,50 | 369 | 1 |
| douchekraan Alpa paneel inbouw 3/4"buitendraad | | | | | | | |
| 0480119 | | | 35936 | stuk | 324,00 | 369 | 1 |
| Presto doucheset DL serie | | | | | | | |
| Presto doucheset DL 400S 3/4"buitendraad opbouw 6 l/min | | | | | | | |
| 7286092 | | | 27130 | stuk | 216,00 | 369 | 1 |
| Meltronic elektronische zelfsluitende systemen voor douches | | | | | | | |
| infrarood gestuurde sensor | | | | | | | |
| 0480606 | standalone 900 | | 277945 | stuk | 350,00 | 369 | 1 |
| transformator | | | | | | | |
| 0480614 | max. 8 besturingen 308 | | 277414 | stuk | 373,00 | 369 | 1 |
| 0480622 | max. 16 besturingen 316 | | 277415 | stuk | 481,00 | 369 | 1 |
| netadapter | | | | | | | |
| 0480630 | | | 277197 | stuk | 83,50 | 369 | 1 |



Sanitair producten

Baden /
douchebakken /
stoomcabines

Kranen

Douchegarnituur

Accessoires en
spiegels

Douchewanden

Toebehoren &
afvoerenSpoel- &
installatiesystemenBadkamermeubelen
en toiletkastenGootstenen en
wastroggen

Utiliteit

| | Art.nr | Specificaties | Kleur | Lev.nr | Ehd | Prijs | Grp | CC |
|---|---|---------------|-------|---------|------|---------|-----|----|
| Sanitair producten | Meltronic Automatisch beheer- en besturingssysteem voor sanitaire installatie centrale computer z. beeldscherm | | | | | | | |
| | 0480601 | | | 2001001 | stuk | 1995,00 | 369 | 1 |
| Baden / douchebakken / stoomcabines | Mono 200 tapbeheer & besturingssysteem | | | | | | | |
| | 0480602 | | | 2001201 | stuk | 245,00 | 369 | 1 |
| Kranen | Mono 200 module en temperatuursensor | | | | | | | |
| | 0480603 | | | 2001211 | stuk | 147,00 | 369 | 1 |
| Douchegarnituur | Mono 300 temperatuur meetstelsel m. sensor | | | | | | | |
| | 0480604 | | | 2001301 | stuk | 133,00 | 369 | 1 |
| Accessoires en spiegels | data-/voedingskabel per meter | | | | | | | |
| | 0480605 | | | 2001401 | stuk | 0,90 | 369 | 1 |
| Douchewanden | Mono 500 elektronisch gestuurde 3-wegklep 1" | | | | | | | |
| | 0480607 | | | 2001501 | stuk | 467,00 | 369 | 1 |
| Toebehoren & afvoeren | Mono 500 elektronisch gestuurde 3-wegklep 3/4" | | | | | | | |
| | 0480608 | | | 2001503 | stuk | 428,00 | 369 | 1 |
| Spoel- & installatiesystemen | | | | | | | | |
| Badkamermeubelen en toiletkasten | | | | | | | | |
| Gootstenen en wastroggen | | | | | | | | |
| Utiliteit | | | | | | | | |

| Art.nr | Specificaties | Kleur | Lev.nr | Ehd | Prijs | Grp | CC |
|--|------------------------|--------|--------|------|--------|-----|----|
| Presto mechanische urinoirspoelers | | | | | | | |
| urinoirspoeler 1/2" recht 0720458 | | chroom | 31001 | stuk | 59,00 | 369 | 1 |
| urinoirspoeler 1/2" haaks 0720465 | | chroom | 31701 | stuk | 69,00 | 369 | 1 |
| urinoirspoeler inbouw 3/4" 0720455 | | | 15200 | stuk | 119,00 | 369 | 1 |
| Meltronic individuele sturing | | | | | | | |
| urinoirspoeler infrarood 0720879 | inbouw SA963UC | | 277371 | stuk | 637,00 | 369 | 1 |
| zelfsluitend systeem 0480525 | urinoir inbouw SA152UC | | 277356 | stuk | 500,00 | 369 | 1 |
| 0480533 | urinoir inbouw 152C | | 277719 | stuk | 373,00 | 369 | 1 |



Sanitair producten

Baden /
douchebakken /
stoomcabines

Kranen

Douchegarnituur

Accessoires en
spiegels

Douchewanden

Toebehoren &
afvoerenSpoel- &
installatiesystemenBadkamermeubelen
en toiletkastenGootstenen en
wastroggen

Utiliteit

| | Art.nr | Specificaties | Kleur | Lev.nr | Ehd | Prijs | Grp | CC |
|---|--|--|-------|--------|------|-------|-----|----|
| Sanitair producten | Presto mechanische toiletspoelers | | | | | | | |
| | | closetspoeler zelfsluitend 3/4" | | | | | | |
| | 0720015 | | | 14109 | stuk | 79,50 | 369 | 1 |
| Baden / douchebakken / stoomcabines | | | | | | | | |
| Kranen | | | | | | | | |
| Douchegarnituur | | | | | | | | |
| Accessoires en spiegels | | | | | | | | |
| Douchewanden | | | | | | | | |
| Toebehoren & afvoeren | | | | | | | | |
| Spoel- & installatiesystemen | | | | | | | | |
| Badkamermeubelen en toiletkasten | | | | | | | | |
| Gootstenen en wastroggen | | | | | | | | |
| Utiliteit | | | | | | | | |

| Art.nr | Specificaties | Kleur | Lev.nr | Ehd | Prijs | Grp | CC |
|--|--------------------------------|-------|--------|------|---------|-----|----|
| Rada 215, centraal thermostaat 1/2" | | | | | | | |
| 215 centraalthermostaat 1/2" opbouw | | | | | | | |
| 0480895 | | | 136050 | stuk | 645,00 | 369 | 1 |
| 215DK centraalthermostaat 1/2" m. temperatuurblokkeerinrichting | | | | | | | |
| 0480024 | | | 136042 | stuk | 485,00 | 369 | 0 |
| pakkingset voor thermostaat 215 | | | | | | | |
| 0480035 | | | 40892 | stuk | 21,25 | 369 | 1 |
| Rada 320, centraal thermostaat 3/4" | | | | | | | |
| centraal thermostaat 3/4" opbouw | | | | | | | |
| 0480892 | m. keerkleppen 320CX | | 137050 | stuk | 1159,00 | 369 | 0 |
| 0480900 | m. keerkleppen m. kopp. 320CXZ | | 137052 | stuk | 1231,00 | 369 | 1 |
| 0480896 | z. keerkleppen 320CF | | 137055 | stuk | 870,00 | 369 | 1 |
| 0480905 | m. keerkleppen 320OEM | | 137060 | stuk | 953,00 | 369 | 1 |
| Rada 425, centraal thermostaat 1" | | | | | | | |
| 425 centraalthermostaat 1" opbouw m. haakse keerkleppen | | | | | | | |
| 7286128 | | | 138050 | stuk | 2292,00 | 369 | 1 |

Sanitair producten

Baden /
douchebakken /
stoomcabines

Kranen

Douchegarnituur

Accessoires en
spiegels

Douchewanden

Toebehoren &
afvoerenSpoel- &
installatiesystemenBadkamermeubelen
en toiletkastenGootstenen en
wastroggen

Utiliteit

| | Art.nr | Specificaties | Kleur | Lev.nr | Ehd | Prijs | Grp | CC |
|---|---|-----------------------|-------|--------|------|---------|-----|----|
| Sanitair producten |  Rada 32RMX 5/4" centraal thermostaat 0480924 | 5/4" opbouw 12V 32RMX | | 136544 | stuk | 4303,00 | 369 | 1 |
| | | | | | | | | |
| Baden / douchebakken / stoomcabines | Thermometer E65 7286134 | | | 012 | stuk | 106,00 | 369 | 0 |
| Kranen | | | | | | | | |
| Douchegarnituur | | | | | | | | |
| Accessoires en spiegels | | | | | | | | |
| Douchewanden | | | | | | | | |
| Toebehoren & afvoeren | | | | | | | | |
| Spoel- & installatiesystemen | | | | | | | | |
| Badkamermeubelen en toiletkasten | | | | | | | | |
| Gootstenen en wastroggen | | | | | | | | |
| Utiliteit | | | | | | | | |

| Art.nr | Specificaties | Kleur | Lev.nr | Ehd | Prijs | Grp | CC |
|--|---------------|-------|--------|------|--------|-----|----|
| Meltronic hoog/laag regelingen | | | | | | | |
| meltronic 850 hoog/laag regelaar 7286130 | | | 275395 | stuk | 957,00 | 369 | 1 |
| driewegklep elektronisch 1" 24V 7286132 | | | 555551 | stuk | 278,00 | 369 | 1 |
| electronische 3-weg klep 0480527 | | | 555553 | stuk | 261,00 | 369 | 1 |

Sanitair producten

Baden /
douchebakken /
stoomcabines

Kranen

Douchegarnituur

Accessoires en
spiegels

Douchewanden

Toebehoren &
afvoerenSpoel- &
installatiesystemenBadkamermeubelen
en toiletkastenGootstenen en
wastroggen

Utiliteit

| | Art.nr | Specificaties | Kleur | Lev.nr | Ehd | Prijs | Grp | CC |
|---|---|--|-----------|--------|--------|-------|--------|-------|
| Sanitair producten | Rada Thermotap | | | | | | | |
| |  | 1-gats wastafelmengkraan 0480932 | Thermotap | chrom | 24B | stuk | 343,00 | 369 1 |
| Baden / douchebakken / stoomcabines | Rada 415 | | | | | | | |
| | | 415BC douchekraan inbouw 0480941 | | | 126605 | stuk | 263,00 | 369 1 |
| Kranen | | | | | | | | |
| Douchegarnituur | | | | | | | | |
| Accessoires en spiegels | | | | | | | | |
| Douchewanden | | | | | | | | |
| Toebehoren & afvoeren | | | | | | | | |
| Spoel- & installatiesystemen | | | | | | | | |
| Badkamermeubelen en toiletkasten | | | | | | | | |
| Gootstenen en wastroggen | | | | | | | | |
| Utiliteit | | | | | | | | |

| Art.nr | Specificaties | Kleur | Lev.nr | Ehd | Prijs | Grp | CC |
|--|---------------|--------|----------|------|--------|-----|----|
| Moratherm | | | | | | | |
| douchethermostaat m. koppelingen m. knop 0480033 | | chroom | 70161500 | stuk | 190,00 | 369 | 1 |
| douchethermostaat m. koppelingen 0480025 | | chroom | 70163000 | stuk | 211,00 | 369 | 1 |
| centraal thermostaat HOH=40mm 0480003 | | | 70050000 | stuk | 204,00 | 369 | 1 |
| 1-gats wastafelthermostaat 0480031 | | chroom | 70163400 | stuk | 277,00 | 369 | 1 |
| Moramini thermostaat kraan 0480999 | | | 43010000 | stuk | 118,00 | 369 | 1 |

Sanitair producten

Baden /
douchebakken /
stoomcabines

Kranen

Douchegarnituur

Accessoires en
spiegels

Douchewanden

Toebehoren &
afvoerenSpoel- &
installatiesystemenBadkamermeubelen
en toiletkastenGootstenen en
wastroggen

Utiliteit

de Melker Mora RH-serie voor toepassingen in de gezondheidszorg

| | Art.nr | Specificaties | Kleur | Lev.nr | Ehd | Prijs | Grp | CC |
|---|-----------------------|--|-------|----------|------|--------|-----|----|
| Sanitair producten | Mora RH kranen | | | | | | | |
| | | badthermostaat m. omstel m. uitloop vast 0480995 | | 71000300 | stuk | 315,00 | 369 | 1 |
| | | douchethermostaat m. onderaansluiting 1/2" 0480996 | | 71004500 | stuk | 265,00 | 369 | 1 |
| Baden / douchebakken / stoomcabines | | RH 1-gats wastafelthermostaat m. kettingoog 0480997 | | 70163800 | stuk | 280,00 | 369 | 1 |
| Kranen | | 1-gats keukenkraan 0481016 | chrom | 70175400 | stuk | 151,00 | 369 | 1 |
| Douchegarnituur | | RH 1-gats wastafelthermostaat m. draaibare uitloop 0481026 | | 70172900 | stuk | 197,00 | 369 | 1 |
| Accessoires en spiegels | | | | | | | | |
| Douchewanden | | | | | | | | |
| Toebehoren & afvoeren | | | | | | | | |
| Spoel- & installatiesystemen | | | | | | | | |
| Badkamermeubelen en toiletkasten | | | | | | | | |
| Gootstenen en wastroggen | | | | | | | | |
| Utiliteit | | | | | | | | |

| Art.nr | Specificaties | Kleur | Lev.nr | Ehd | Prijs | Grp | CC |
|------------------------------------|---|-------|----------|------|-------|-----|----|
| Mora vorstvrije gevelkranen | | | | | | | |
| 0480990 | vorstvrije gevelkraan l=320mm 130-320mm m. sleutelbediening | | 70094600 | stuk | 66,50 | 369 | 1 |
| 0480980 | vorstvrije gevelkraan l=450mm 260-450mm m. sleutelbediening | | 70094700 | stuk | 66,50 | 369 | 1 |

Sanitair producten

Baden /
douchebakken /
stoomcabines

Kranen

Douchegarnituur

Accessoires en
spiegels

Douchewanden

Toebehoren &
afvoerenSpoel- &
installatiesystemenBadkamermeubelen
en toiletkastenGootstenen en
wastroggen

Utiliteit

| | Art.nr | Specificaties | Kleur | Lev.nr | Ehd | Prijs | Grp | CC |
|---|--|--|-------|---------|------|--------|-----|----|
| Sanitair producten | Broen laboratoriumkranen water | | | | | | | |
| | | enkele wandkraan water 1/2" | | | | | | |
| | 0480020 | | | 15509 | stuk | 72,50 | 369 | 1 |
| Baden / douchebakken / stoomcabines | laboratoriumkraan water m. bovenuitloop 2x1/2"buitendraad | | | | | | | |
| | 0480831 | | | 17829 | stuk | 203,00 | 369 | 1 |
| Kranen | 1-gats laboratoriumkraan m. U-uitloop | | | | | | | |
| | 0480820 | | | 17889 | stuk | 165,00 | 369 | 1 |
| Douchegarnituur | binnenwerk keramisch z. handy knop | | | | | | | |
| | 0480067 | | | B0006 | stuk | 19,75 | 369 | 1 |
| Accessoires en spiegels | Broen laboratoriumkranen demi-water | | | | | | | |
| | | wandkraan demi-water RVS uitvoering | | | | | | |
| | 0480826 | | | 1595NM9 | stuk | 163,00 | 369 | 1 |
| Douchewanden | afsluiter los demi-water RVS | | | | | | | |
| | 0480828 | | | 1760NM9 | stuk | 97,50 | 369 | 1 |
| Toebehoren & afvoeren | | | | | | | | |
| Spoel- & installatiesystemen | | | | | | | | |
| Badkamermeubelen en toiletkasten | | | | | | | | |
| Gootstenen en wastroggen | | | | | | | | |
| Utiliteit | | | | | | | | |

| Art.nr | Specificaties | Kleur | Lev.nr | Ehd | Prijs | Grp | CC |
|---|---------------------------|-------|--------|------|--------|-----|----|
| Docmix lang model | | | | | | | |
| wandkraan | | | | | | | |
| 0480940 | m. vaste uitloop z. kopp. | chrom | 1003 | stuk | 341,00 | 369 | 1 |
| 0480959 | m. vaste uitloop m. kopp. | chrom | 1013 | stuk | 366,00 | 369 | 1 |
| Docmix kort model | | | | | | | |
| wandkraan m. afsluitbare koppeling | | | | | | | |
| 0480960 | | | 2013 | stuk | 349,00 | 369 | 1 |

Sanitair producten

Baden /
douchebakken /
stoomcabines

Kranen

Douchegarnituur

Accessoires en
spiegels

Douchewanden

Toebehoren &
afvoerenSpoel- &
installatiesystemenBadkamermeubelen
en toiletkastenGootstenen en
wastroggen

Utiliteit

| Art.nr | Specificaties | Kleur | Lev.nr | Ehd | Prijs | Grp | CC |
|--------|---------------|-------|--------|-----|-------|-----|----|
|--------|---------------|-------|--------|-----|-------|-----|----|

Broen Gaskogelkranen

gaskogelkraan 1/2" m. rechte tuit RVS

0480008

17719

stuk

61,50

369

1

Sanitair producten

Baden /
douchebakken /
stoomcabines

Kranen

Douchegarnituur

Accessoires en
spiegels

Douchewanden

Toebehoren &
afvoeren

Spoel- &
installatiesystemen

Badkamermeubelen
en toiletkasten

Gootstenen en
wastroggen

Utiliteit

| Art.nr | Specificaties | Kleur | Lev.nr | Ehd | Prijs | Grp | CC |
|--------|---------------|-------|--------|-----|-------|-----|----|
|--------|---------------|-------|--------|-----|-------|-----|----|

Broen Naaldafsluiters

| | | | | | | | |
|---------------------------------|--|--|-------|------|-------|-----|---|
| naaldafsluiter binnendraad 1/2" | | | | | | | |
| 0480823 | | | 17330 | stuk | 73,00 | 369 | 1 |

Sanitair producten

Baden /
douchebakken /
stoomcabines

Kranen

Douchegarnituur

Accessoires en
spiegels

Douchewanden

Toebehoren &
afvoerenSpoel- &
installatiesystemenBadkamermeubelen
en toiletkastenGootstenen en
wastroggen

Utiliteit

| | Art.nr | Specificaties | Kleur | Lev.nr | Ehd | Prijs | Grp | CC |
|---|------------------------------|-------------------------------------|-------|--------|------|-------|-----|----|
| Sanitair producten | Broen Naaldafsluiters | | | | | | | |
| | | naaldafsluiter 3/8" zuurstof | | | | | | |
| | 0480005 | | | 153589 | stuk | 84,00 | 369 | 1 |
| Baden / douchebakken / stoomcabines | | | | | | | | |
| Kranen | | | | | | | | |
| Douchegarnituur | | | | | | | | |
| Accessoires en spiegels | | | | | | | | |
| Douchewanden | | | | | | | | |
| Toebehoren & afvoeren | | | | | | | | |
| Spoel- & installatiesystemen | | | | | | | | |
| Badkamermeubelen en toiletkasten | | | | | | | | |
| Gootstenen en wastroggen | | | | | | | | |
| Utiliteit | | | | | | | | |

| Art.nr | Specificaties | Kleur | Lev.nr | Ehd | Prijs | Grp | CC |
|---|-------------------------------|--------|----------|------|--------|-----|----|
| Broen Nooddouche-combinaties m. vaste douchekoppen | | | | | | | |
| nooddouchecombinatie | | | | | | | |
| 0481068 | S-boveninlaat | 1-kops | 17080009 | stuk | 323,00 | 369 | 1 |
| 0481041 | zijinlaat | 4-kops | 17081009 | stuk | 300,00 | 369 | 1 |
| 0481033 | voor wandmontage | 4-kops | 17082009 | stuk | 358,00 | 369 | 1 |
| Broen Oog en gelaatsdouches | | | | | | | |
| oogdouche | | | | | | | |
| 0480983 | voor wand-montage | | 17250009 | stuk | 433,00 | 369 | 0 |
| 0480975 | voor blad-montage | | 17200009 | stuk | 398,00 | 369 | 1 |
| 0480991 | m. opvangbak voor wandmontage | | 17928009 | stuk | 795,00 | 369 | 0 |
| Broen Handdouches | | | | | | | |
| knijp-oogdouche | | | | | | | |
| 0480967 | m. ophangbeugel | | 17712000 | stuk | 300,00 | 369 | 1 |
| knijp-ogendouche voor wandmontage | | | | | | | |
| 0481019 | | | 17715000 | stuk | 393,00 | 369 | 1 |



Sanitair producten

Baden /
douchebakken /
stoomcabines

Kranen

Douchegarnituur

Accessoires en
spiegels

Douchewanden

Toebehoren &
afvoerenSpoel- &
installatiesystemenBadkamermeubelen
en toiletkastenGootstenen en
wastroggen

Utiliteit

| Art.nr | Specificaties | Kleur | Lev.nr | Ehd | Prijs | Grp | CC |
|--------|---------------|-------|--------|-----|-------|-----|----|
|--------|---------------|-------|--------|-----|-------|-----|----|

Onthardingszout

onthardingszout

0780022 per kilo

EURO-SEL

kilo

0,38

356

1

Sanitair producten

Baden /
douchebakken /
stoomcabines

Kranen

Douchegarnituur

Accessoires en
spiegels

Douchewanden

Toebehoren &
afvoeren

Spoel- &
installatiesystemen

Badkamermeubelen
en toiletkasten

Gootstenen en
wastroggen

Utiliteit

| | | | | |
|-------------------------------------|----------|--|--------------|------|
| A | | | | |
| Aansluitmateriaal Mulet | 1160 | Bette LaBette | 255 | |
| Aansluitmateriaal Viega | 1159 | Bette Linea | 253 | |
| Aansluitmateriaal Villeroy & Boch | 1160 | Bette Model diep 28cm | 256 | |
| ABU City | 1164 | Bette Model vlak 15cm | 256 | |
| ABU Delta hoekreservoir | 1179 | Bette Morrison | 253 | |
| ABU gootstenen | 1294 | Bette Point | 257 | |
| ABU Onderdelen reservoirs | 1179 | Bette Point Rond | 257 | |
| ABU Primus laaghangend reservoir | 1179 | Bette Pool | 253 | |
| ABU Starlet laaghangend reservoir | 1179 | Bette Pur | 253 | |
| Accessoires Colombo | 802 | Bette Roma | 254 | |
| Accessoires D-Line | 848 | Bette Schmidem | 254 | |
| Accessoires Dornbracht | 834 | Bette Set | 254 | |
| Accessoires Duravit | 846 | Bette Sign | 254 | |
| Accessoires Emco | 851 | Bette Starlet | 254 | |
| Accessoires en spiegels | 802 | Bette Super vlak 3,5cm | 257 | |
| Accessoires Geesa | 897 | Bette Toebehoren | 255, 257 | |
| Accessoires Gessi | 922 | Bette Trend | 254 | |
| Accessoires Grohe | 890 | Bette Voetzitbad | 255 | |
| Accessoires Haceka | 939 | BetteForm Nova | 250 | |
| Accessoires Hansa | 951 | Bevestigingen | 1156 | |
| Accessoires Hansgrohe | 956 | Bevestigingen Viega | 1156 | |
| Accessoires Hewi | 971 | bevestigingssets | 1032 | |
| Accessoires Jado | 976 | Bevestigingssets Duravit | 1156 | |
| Accessoires Keuco | 979 | Bevestigingssets Keramag | 1156, 1159 | |
| Accessoires Kludi | 1007 | Bevestigingssets Plieger | 1161 | |
| Accessoires Othello | 889 | Bevestigingssets Viega | 1156 | |
| Accessoires Plieger | 1009 | Bevestigingssets Villeroy & Boch | 1159, 1161 | |
| Accessoires Sphinx | 1016 | Bidetbekersifons Viega | 1130 | |
| Accessoires Villeroy & Boch | 1019 | Bidetbuissifons Duravit | 1130 | |
| afdekplaten Grohedal | 1216 | Bidetbuissifons Hansgrohe | 1130 | |
| Afvoeren bad | 1136 | Bidetbuissifons Viega | 1130 | |
| Afvoeren douchebak | 1141 | Bidetsifon Gessi | 1161 | |
| Afvoergoten Easy Drain | 1144 | Buissifons Dornbracht | 1129 | |
| Alape gootstenen | 1295 | Buissifons McALPINE | 1129 | |
| Alape inbouwwaskommen EB | 233 | Buissifons Viega | 1129 | |
| Alape inbouwwaskommen ED | 235 | Burda BS+ WC-module | 1206 | |
| Alape metalen meubelen | 240 | Burda Combisets | 1206 | |
| Alape opbouwwaskommen SB | 235 | Burda Santro2000 bidetmodule | 1206 | |
| Alape spiegelkasten/spiegels | 239 | Burda Santro2000 Toebehoren | 1206 | |
| Alape Toebehoren | 235 | Burda Santro2000 wastafelmodule | 1206 | |
| Alape wastafelmeubelen WP | 239 | Burda Santro2000 WC-module | 1206 | |
| Alape wastafels WT | 235 | Burg Crono meubelen | 1220 | |
| Aqua closetspoelers | 1214 | C | | |
| Aqua Onderdelen | 1214 | Cararra & Matta Nord | 1165 | |
| Aqua urinoirspoelers | 1214 | Cararra & Matta Rimini | 1165 | |
| B | | | Celmac Annan | 1166 |
| Baddragers en tegelramen de Beer | 1134 | Celmac bevestigingsgarnituur | 1166 | |
| Baddragers en tegelramen Illbruck | 1134 | Celmac zitting 25 | 1166 | |
| Baden / douchebakken / stoomcabines | 250 | Celmac zitting 38 | 1166 | |
| Badkamermeubelen en toiletkasten | 1220 | Celmac zitting 42 | 1166 | |
| Badoverloopcombinatie Hansgrohe | 1136 | Celmac zitting 170 | 1166 | |
| Badoverloopcombinatie Plieger | 1136 | Celmac zitting LWF | 1166 | |
| Badoverloopcombinatie Viega | 1136 | Centrisch duplex sifoncombinaties McAlpine | 1131 | |
| Badsifons McALPINE | 1140 | Closetafvoeren ABU | 1156 | |
| Badsifons Viega | 1140 | Closetafvoeren de Beer | 1157 | |
| Badwaste Dornbracht | 1136 | Closetafvoeren Keramag | 1157 | |
| Badwaste Duravit | 1136 | Closetafvoeren NKS | 1157 | |
| Badwaste Geberit | 1136 | Closetafvoeren Plieger | 1157 | |
| Badwaste Gessi | 1137 | Closetafvoeren Sphinx | 1157 | |
| Badwaste Grohe | 1137 | Closetafvoeren Viega | 1158 | |
| Badwaste Hansgrohe | 1137 | Closetafvoeren Villeroy & Boch | 1157 | |
| Badwaste Hoesch | 1138 | Closetafvoeren Wisa | 1158 | |
| Badwaste Kludi | 1139 | closetspoelers Grohedal | 1216 | |
| Badwaste McALPINE | 1136 | closetspoelers Schell | 1218 | |
| Badwaste Onderdelen | 1140 | Closetzittingen ABU | 1164 | |
| Badwaste Viega | 1139 | Closetzittingen Cararra & Matta | 1165 | |
| Ballofix kraan Toebehoren | 700 | Closetzittingen Celmac | 1166 | |
| Ballofix kranen | 700 | Closetzittingen Haro | 1168 | |
| Bekersifons Kludi | 1126 | Closetzittingen Pagette | 1169 | |
| Bekersifons Viega | 1127 | Closetzittingen Plieger | 1171 | |
| Best Saver handdouche | 714 | Closetzittingen Pressalit | 1173 | |
| Bette Bambino | 250 | Closetzittingen Rezi | 1176 | |
| Bette Caro | 257 | Colombo Bart | 802 | |
| Bette Cora | 250 | Colombo Bart onderdelen | 804 | |
| Bette Cora Ronda | 251 | Colombo Gallery | 805 | |
| Bette Corner | 257 | Colombo Gipsy | 830 | |
| Bette Darling | 253, 257 | Colombo Isole | 810 | |
| Bette Duett | 253 | Colombo Khala | 808 | |
| Bette Duo | 253 | Colombo Khala onderdelen | 809 | |
| Bette Extra vlak 6,5cm | 256 | Colombo Land | 811 | |
| Bette Form | 250 | Colombo Link | 814 | |
| | | Colombo Link onderdelen | 816 | |

| | | | |
|-------------------------------|---------------|-------------------------------------|--------------------|
| Colombo Look | 818 | Dornbracht Madison | 378, 660, 718 |
| Colombo Look onderdelen | 819 | Dornbracht Madison Flair | 381 |
| Colombo Luna | 820 | Dornbracht Maro | 660 |
| Colombo Luna onderdelen | 821 | Dornbracht Mem | 382, 718, 841 |
| Colombo Melo | 821 | Dornbracht Meta | 719 |
| Colombo Melo onderdelen | 823 | Dornbracht Meta Luce | 386 |
| Colombo Universeel | 831 | Dornbracht Meta Pur | 386 |
| Colombo Viva | 823 | Dornbracht Meta Tec | 387 |
| Colombo Viva onderdelen | 825 | Dornbracht Meta.02 | 388, 660, 720, 842 |
| Colombo Wishwash Plus | 825 | Dornbracht Onderdelen | 410 |
| Colombo Wishwash Time | 828 | Dornbracht RainSky | 720 |
| Colombo Yoga | 829 | Dornbracht Tara | 392, 661, 720 |
| Colombo Yoga onderdelen | 830 | Dornbracht Tara Classic | 396, 721 |
| | | Dornbracht Tara Logic | 401 |
| | | Dornbracht Tara-Classic | 661 |
| D | | Dornbracht Universeel | 406, 662, 721, 845 |
| D-Line RVS | 848 | Dornbracht Yota | 402 |
| Damixa Arc | 358, 655 | Douche WC | 1177 |
| Damixa Eclipse | 358, 655 | Douche WC Geberit | 1177 |
| Damixa G Type V3.0 | 359, 655 | Douche-/Stoomcabines Huppe | 351 |
| Damixa Gala | 360, 655 | Douche-/Stoomcabines Ucosan | 355 |
| Damixa Jupiter | 361, 656 | Douchebakdragers en -poten Illbruck | 1152 |
| Damixa Kafe | 656 | Douchebakdragers en -poten Mepa | 1152 |
| Damixa kranen | 358 | Douchebakdragers en -poten Plieger | 1152 |
| Damixa Luna | 362, 656 | Douchecabines Intersan | 352 |
| Damixa Merkur | 363, 656 | Douchegarnituur | 714 |
| Damixa Object | 364, 657 | Douchepanelen Grohe | 797 |
| Damixa Saturn | 365, 657 | Douchepanelen Hansa | 798 |
| Damixa Space | 366, 658 | Douchepanelen Kludi | 799 |
| Damixa Superstar | 366, 658 | Douchepanelen Pharo | 800 |
| Damixa Titan | 367, 658 | Douchepluggen Geberit | 1141 |
| Damixa Tradition | 367, 658 | Douchepluggen Hansgrohe | 1141 |
| Damixa Universeel | 370 | Douchepluggen Kludi | 1141 |
| Damixa Venus | 369, 659 | Douchepluggen Viega | 1142 |
| Dansani Geysir | 1223 | Doucheprogramma Best Saver | 714 |
| De Beer kraan Toebehoren | 701 | Doucheprogramma Dornbracht | 716 |
| De Beer straalbrekers | 701 | Doucheprogramma Geesa | 725 |
| Designsifons Dornbracht | 1125 | Doucheprogramma Gessi | 726 |
| Designsifons Gessi | 1125 | Doucheprogramma Grohe | 736 |
| Designsifons Hansgrohe | 1125 | Doucheprogramma Haceka | 746 |
| Designsifons Kludi | 1126 | Doucheprogramma Hansa | 747 |
| Designsifons Plieger | 1126 | Doucheprogramma Hansgrohe | 756 |
| Designsifons Viega | 1126 | Doucheprogramma Ideal Standard | 772 |
| Detremmerie at Long Island | 1240 | Doucheprogramma Jado | 774 |
| Detremmerie Atlantic Beach | 1225 | Doucheprogramma Kludi | 776 |
| Detremmerie Bo | 1226 | Doucheprogramma KWC | 786 |
| Detremmerie Bolero 4003 | 1227 | Doucheprogramma Oras | 787 |
| Detremmerie Charon | 1229 | Doucheprogramma Pharo | 790 |
| Detremmerie Charon Due | 1231 | Doucheprogramma Plieger | 788 |
| Detremmerie Chiara | 1232 | Doucheprogramma Seppelfricke | 791 |
| Detremmerie Elle | 1233 | Doucheprogramma Sphinx | 792 |
| Detremmerie Fabian | 1233 | Doucheprogramma Venlo | 793 |
| Detremmerie Fabian Due | 1234 | Doucheprogramma Villeroy & Boch | 795 |
| Detremmerie Gaelle | 1236 | Douchewanden | 1036 |
| Detremmerie Globe 3001 | 1236 | Douchewanden Duscholux | 1036 |
| Detremmerie Havanna | 1237 | Douchewanden Hoesch | 1045 |
| Detremmerie Hip | 1239 | Douchewanden Huppe | 1046 |
| Detremmerie Maite | 1241 | Douchewanden Keramag JOOP! | 1062 |
| Detremmerie Massimo 5007 | 1242 | Douchewanden Kermi | 1063 |
| Detremmerie Maxim 5006 | 1243 | Douchewanden Novellini | 1098 |
| Detremmerie Micro 6000 | 1244 | Douchewanden Plieger | 1108 |
| Detremmerie Micro Corner 6001 | 1244 | Douchewanden Riho | 1110 |
| Detremmerie Orphee 2002 | 1245 | Douchewanden Sphinx | 1113 |
| Detremmerie Quinto 4002 | 1246 | Douchewanden Ucosan | 1116 |
| Detremmerie Toebehoren | 1248 | Douchewanden Villeroy & Boch | 1117 |
| Detremmerie Universeel | 1224 | Duravit 2nd floor | 31, 277, 281 |
| Detremmerie Wastafels | 1224 | Duravit 2x3 | 278 |
| Dimensie Apokalypse | 241 | Duravit 4x9 | 1249 |
| Dimensie Frattini | 241 | Duravit 1930 | 28, 846 |
| Dimensie Thema | 241 | Duravit Architec | 74 |
| Dornbracht 360 | 836 | Duravit Bacino | 76 |
| Dornbracht 480 | 834 | Duravit Bali | 77 |
| Dornbracht 890 | 837 | Duravit Bambi | 77 |
| Dornbracht Belle de Jour | 371, 716 | Duravit Ben | 80 |
| Dornbracht Domani | 371 | Duravit Bill | 80 |
| Dornbracht Dreamscape | 371, 716 | Duravit Bora | 77 |
| Dornbracht Dreamworks | 373 | Duravit Caro | 36 |
| Dornbracht eMote | 374 | Duravit Change | 1249 |
| Dornbracht eTech | 374 | Duravit Ciottolo | 77 |
| Dornbracht Giorno | 375, 716, 835 | Duravit Darling | 39 |
| Dornbracht Interiors | 405 | Duravit Daro | 278 |
| Dornbracht Licht in badkamer | 844 | Duravit Dellarco | 42 |
| Dornbracht Lot | 660 | Duravit Design Variations | 45 |
| Dornbracht Lulu | 376, 716, 839 | | |

| | | | |
|--|----------|--|----------|
| Duravit douchebak Toebehoren | 283 | Emco Logo | 871 |
| Duravit Duraplus | 48 | Emco New waves | 873 |
| Duravit Duraplus Compact | 50 | Emco Rondo | 874 |
| Duravit Duravital | 78 | Emco Rondo 2 | 876 |
| Duravit Fizz | 78 | Emco Singles | 877 |
| Duravit Fogo | 1249 | Emco spiegels | 885 |
| Duravit Foster | 51, 847 | Emco System 01 | 879 |
| Duravit Gamba | 78 | Emco Universeel | 888 |
| Duravit Happy-D | 52 | Emco verlichting | 887 |
| Duravit HappyD | 278, 281 | Excentrisch duplex sifoncombinaties McAlpine | 1131 |
| Duravit Hornberg | 78 | | |
| Duravit In the mood | 1249 | F | |
| Duravit Jim | 80 | F-Grohe Eggemann | 702 |
| Duravit Katja | 80 | F-Grohe kraan Toebehoren | 702 |
| Duravit McDry | 78 | Faecaliënvermalers | 1210 |
| Duravit Med | 79 | Fantini Copernico | 411 |
| Duravit Med-Compact | 79 | Fantini Stilo-Sfera | 411 |
| Duravit Minera | 79 | Fontein bevestigingssets Keramag | 1120 |
| Duravit Multibox | 1252 | Fontein bevestigingssets Plieger | 1120 |
| Duravit multifunctionele douchecabines | 348 | Franke gootstenen | 1298 |
| Duravit Ondina | 79 | | |
| Duravit packs | 232 | G | |
| Duravit Paiova | 278 | Geberit afdekplaat | 1183 |
| Duravit Philippe Starck | 279 | Geberit Artline afdekplaten | 1184 |
| Duravit Philippe Starck 3 | 279, 281 | Geberit Bolero afdekplaten | 1183 |
| Duravit Philippe Starck X | 279, 282 | Geberit Duofix elementen | 1182 |
| Duravit Santosa | 79 | Geberit Duofix Toebehoren | 1183 |
| Duravit Starck | 1252 | Geberit elektrische bediening reservoirs | 1185 |
| Duravit Starck 1 | 57 | Geberit Electronic | 1215 |
| Duravit Starck 2 | 61 | Geberit Gis constructie toebehoren | 1187 |
| Duravit Starck 3 | 64 | Geberit Gis installatie toebehoren | 1188 |
| Duravit Starck X | 72 | Geberit Gis montage-elementen | 1187 |
| Duravit Sudan | 79 | Geberit Gis-easy badmodule | 1187 |
| Duravit Toebehoren | 280 | Geberit Gis-easy bidetmodule | 1187 |
| Duravit Triberg | 79 | Geberit Gis-easy douchescheidingswand | 1187 |
| Duravit Utronic | 80 | Geberit Gis-easy hoek toiletmodule | 1187 |
| Duravit Varional | 80 | Geberit Gis-easy toebehoren | 1187 |
| Duravit X-large | 1254 | Geberit Gis-easy toiletmodule | 1187 |
| Duscholux Ancona | 285, 289 | Geberit Gis-easy urinoirmodule | 1187 |
| Duscholux Bella Vita | 1036 | Geberit Gis-easy wastafelmodule | 1187 |
| Duscholux Carat | 1037 | Geberit hooghangend reservoir | 1180 |
| Duscholux Cordoba | 285 | Geberit inbouwreservoir | 1180 |
| Duscholux Duschosmart | 1041 | Geberit Jadi | 1180 |
| Duscholux Duschostar | 1041 | Geberit Kappa afdekplaten | 1183 |
| Duscholux Holydoor Plus | 1042 | Geberit Kombifix inbouwreservoir | 1181 |
| Duscholux Magic Top | 1042 | Geberit Mambo afdekplaten | 1184 |
| Duscholux Malaga | 285 | Geberit pneumatische bediening | 1185 |
| Duscholux Malagaround | 289 | Geberit Project laaghangend reservoir | 1180 |
| Duscholux Portofino | 286 | Geberit reservoir Onderdelen | 1185 |
| Duscholux Smart-line | 287, 289 | Geberit Rumba afdekplaten | 1184 |
| Duscholux Toebehoren | 287 | Geberit Samba afdekplaten | 1184 |
| Duscholux Urban | 1044 | Geberit Samba urinoirbediening | 1185 |
| | | Geberit Sanbloc inbouwreservoir | 1181 |
| E | | Geberit Tango afdekplaten | 1184 |
| Easy Drain Class | 1144 | Geberit Toebehoren afdekplaten | 1184 |
| Easy Drain Class Move | 1146 | Geberit Toebehoren hangend reservoir | 1180 |
| Easy Drain Class Polished | 1146 | Geberit Toebehoren inbouwreservoir | 1182 |
| Easy Drain Class Wall | 1146 | Geberit Twico | 1180 |
| Easy Drain Class Zero | 1148 | Geberit Twist afdekplaten | 1184 |
| Easy Drain Delta Class | 1148 | Geberit urinoirbediening | 1185 |
| Easy Drain Delta Fixt | 1149 | Geesa 2000 | 899 |
| Easy Drain Fixt | 1144 | Geesa 5000 | 725, 899 |
| Easy Drain Fixt Polished | 1147 | Geesa 6000 | 902 |
| Easy Drain Fixt Zero | 1148 | Geesa 7000 | 903 |
| Easy Drain Flex | 1145 | Geesa Argos | 725, 904 |
| Easy Drain Flex Move | 1146 | Geesa Basket | 906 |
| Easy Drain Flex Wall | 1146 | Geesa Basket Wing | 906 |
| Easy Drain Pro | 1145 | Geesa Bloq | 909 |
| Easy Drain Round Class | 1149 | Geesa Circles | 725, 910 |
| Easy Drain toebehoren | 1149 | Geesa Escala | 912 |
| Easy Drain Trapezium Class | 1148 | Geesa Fun E | 898 |
| Emco Amphora | 851 | Geesa Luna | 913 |
| Emco Asis | 1259 | Geesa Montana | 915 |
| Emco Barolo | 852 | Geesa Montana Nova | 916 |
| Emco Classic | 854 | Geesa Nexx | 918 |
| Emco Contour | 855 | Geesa Rodano | 920 |
| Emco Dogma | 857 | Geesa Standaard | 897 |
| Emco Emotion | 858 | Gessi Eclix | 413, 728 |
| Emco Eposa | 860 | Gessi Energy | 663 |
| Emco Inspira | 863 | Gessi Font | 416, 728 |
| Emco Kido | 865 | Gessi Font5 | 420 |
| Emco Liaison | 866 | Gessi la Dolce Vita Mito | 413 |
| Emco Linea Arte | 869 | Gessi la Dolce Vito Mito | 728 |

| | | | |
|--|--------------------|------------------------------------|---------------|
| Gessi Mamilla | 423, 729 | Grohe Sentosa | 493, 674 |
| Gessi Mania | 426, 663, 922 | Grohe Silverflex | 743 |
| Gessi Minix | 924 | Grohe Sinfonia | 495, 743, 894 |
| Gessi Natura | 927 | Grohe Supra | 496, 674 |
| Gessi Onderdelen | 469 | Grohe Taron | 497, 895 |
| Gessi Onderdelen accessoires | 938 | Grohe Tempesta | 743 |
| Gessi Ovale | 428, 730, 928 | Grohe Tenso | 497, 895 |
| Gessi Ovale-T | 930 | Grohe Toebehoren | 501 |
| Gessi Oxygene | 432, 663 | Grohe Twin | 744 |
| Gessi Oxygene Hi Tech | 664 | Grohe Universeel | 499, 744 |
| Gessi Ozone | 432, 665, 731 | Grohe Zedra | 675 |
| Gessi P.Cingolo | 666 | Grohedal Atrio afdekplaten | 1190 |
| Gessi P.Godronato | 666 | Grohedal beplating | 1191 |
| Gessi P.Quadro | 667 | Grohedal Rapid-SL bidetelement | 1190 |
| Gessi Particolare Antica | 666 | Grohedal Rapid-SL urinoirelementen | 1190 |
| Gessi Particolare Soft | 665 | Grohedal Rapid-SL wc-elementen | 1189 |
| Gessi Profumi Luce | 436 | Grohedal reservoir Onderdelen | 1192 |
| Gessi Quadro | 437, 668, 732, 931 | Grohedal reservoir Toebehoren | 1192 |
| Gessi Quadro HiTech | 669 | Grohedal Skate afdekplaten | 1191 |
| Gessi Rettangolo | 441, 671, 733, 934 | Grohedal SL bedieningsplaten | 1191 |
| Gessi Rettangolo C | 446 | Grohedal SL Ergo bedieningsplaten | 1191 |
| Gessi Rettangolo J | 448 | Grohedal Surf afdekplaten | 1190 |
| Gessi Rettangolo P | 452 | Grohedal Uniset elementen | 1190 |
| Gessi Rettangolo T | 456 | Grundfos Lifaway-C | 1210 |
| Gessi Rettangolo XL | 461 | Grundfos Liftaway-B | 1210 |
| Gessi Ritrovata | 670 | | |
| Gessi Small | 463 | H | |
| Gessi Universeel | 464, 726 | Hüppe Purano | 303 |
| Gootsteen sifons Geberit | 1131 | Haceka Balance | 939 |
| Gootsteen- en wasmachineafvoeren Viega | 1131 | Haceka Fiji | 940 |
| Gootstenen ABU | 1294 | Haceka Iris | 942 |
| Gootstenen Alape | 1295 | Haceka Kosmos | 943 |
| Gootstenen en wastroggen | 1294 | Haceka Silence | 946 |
| Gootstenen Franke | 1298 | Haceka Standaard | 746, 948 |
| Gootstenen Keramag | 1299 | Haceka Thema | 948 |
| Gootstenen Kuhfuss | 1302 | Haceka Uniline | 950 |
| Gootstenen Plieger | 1296 | Hansa 2Day | 753 |
| Gootstenen Sphinx | 1303 | Hansa Canyon | 506 |
| Gootstenen Villeroy & Boch | 1304 | Hansa Designo | 507, 753, 951 |
| Grohe Alira | 672 | Hansa Disc | 508 |
| Grohe Allure | 471, 890 | Hansa HansaBasicJet programma | 750 |
| Grohe Amera | 797 | Hansa HansaEcoJet programma | 752 |
| Grohe Aquatimer | 797 | Hansa Hansajet programma | 747 |
| Grohe Aquatower 3000 | 797 | Hansa Hansajet XL | 749 |
| Grohe Atlanta | 473, 672 | Hansa Hansamix | 676 |
| Grohe Atrio | 672, 890 | Hansa Hansamotion | 509, 952 |
| Grohe Atrio-Jota | 476 | Hansa Hansamurano | 509 |
| Grohe Atrio-Ypsilon | 474 | Hansa Hansanova | 510, 676 |
| Grohe Chiara | 482, 891 | Hansa HansaNovaJet programma | 749 |
| Grohe Concetto | 478 | Hansa Hansapolo | 511, 676 |
| Grohe Contropress | 483 | Hansa Hansaprisma | 512 |
| Grohe Costa | 484, 672 | Hansa Hansaronda | 512 |
| Grohe Ectos | 892 | Hansa Hansaronda Style | 513 |
| Grohe Essence | 485, 673 | Hansa Hansasublime | 517 |
| Grohe Essentials | 893 | Hansa Hansatwist | 518, 676 |
| Grohe Eurodisc | 486, 673 | Hansa Hansatwister | 519 |
| Grohe Eurodisc SE | 487 | Hansa Hansavario | 520 |
| Grohe Eurodisc2 | 486 | Hansa Murano | 754, 953 |
| Grohe Euroeco | 488, 673 | Hansa Plan | 754 |
| Grohe Europlus | 488, 673 | Hansa Prado | 520, 676 |
| Grohe Europlus E | 490 | Hansa Rain | 755 |
| Grohe Europlus2 | 489 | Hansa Ronda Style | 954 |
| Grohe Eurosmart | 673 | Hansa Smartshower | 798 |
| Grohe Eurosmart2 | 490 | Hansa Star | 520 |
| Grohe Eurostyle | 491, 673 | Hansa Tempra | 521 |
| Grohe Eurostyle2 | 491 | Hansa Universeel | 523 |
| Grohe Freehander | 739 | Hansa Vantis | 522 |
| Grohe Grohtherm XL | 482 | Hansgrohe Atoll | 956 |
| Grohe Grohtherm-1000 | 479 | Hansgrohe AXOR Allegro | 524 |
| Grohe Grohtherm-2000 | 480 | Hansgrohe AXOR Arco | 524 |
| Grohe Grohtherm-3000 | 481 | Hansgrohe AXOR Carlton | 525 |
| Grohe Lineare | 492 | Hansgrohe AXOR Citterio | 528 |
| Grohe Minta | 674 | Hansgrohe AXOR Starck | 546 |
| Grohe Movario | 739 | Hansgrohe AXOR Starck X | 552, 769 |
| Grohe Onderdelen | 502, 745 | Hansgrohe AXOR Steel | 553 |
| Grohe Pulsomat | 493 | Hansgrohe AXOR Terrano | 559 |
| Grohe Rainshower | 741 | Hansgrohe AXOR Uno | 563 |
| Grohe Relexa | 736 | Hansgrohe AXOR Uno-2 | 566 |
| Grohe Relexa Cosmopolitan | 739 | Hansgrohe badsets | 762 |
| Grohe Relexa-Plus | 739 | Hansgrohe Carlton | 770, 957 |
| Grohe Relexa2 | 737 | Hansgrohe Citterio | 768, 958 |
| Grohe Relexaflex | 736 | Hansgrohe Comfort doucheslangen | 763 |
| Grohe Sena | 742 | Hansgrohe Comfort glijstangen | 759 |

| | | | |
|-----------------------------------|---------------------|-------------------------------------|-------------------|
| Hansgrohe Comfort glijstangsets | 760 | Hoesch Oriental | 295 |
| Hansgrohe Comfort handdouches | 756 | Hoesch Patras | 295 |
| Hansgrohe Comfort hoofddouches | 757 | Hoesch Philippe Starck | 296, 301 |
| Hansgrohe douche-armen | 758 | Hoesch Philippe Starck II | 296 |
| Hansgrohe Ecostat-1001SL | 534 | Hoesch Regatta | 296, 301 |
| Hansgrohe Ecostat-2001 | 534 | Hoesch Santee | 296 |
| Hansgrohe Ecostat-5001 | 534 | Hoesch Scelta | 297 |
| Hansgrohe Electronische kranen | 567 | Hoesch Spectra | 298 |
| Hansgrohe Elegance | 677 | Hoesch Thasos | 301 |
| Hansgrohe Flowstar hoekstopkranen | 569 | Hoesch Tilos | 301 |
| Hansgrohe Focus E | 677 | Hoesch Toebehoren | 299 |
| Hansgrohe Focus S | 677 | Hoesch Zero | 299 |
| Hansgrohe Focus-E | 535 | Huppe 501 Classic badklapwand | 1046 |
| Hansgrohe Focus-S | 535 | Huppe 501 Classic vierhoek | 1047 |
| Hansgrohe Joco handdouche | 757 | Huppe 501 Design | 1049 |
| Hansgrohe Logo | 959 | Huppe 501 Toebehoren | 1049 |
| Hansgrohe Massaud | 538, 961 | Huppe 1002 Jette Joop kwartrond | 1053 |
| Hansgrohe Medium doucheslangen | 763 | Huppe 1002 Jette Joop vierhoek | 1050 |
| Hansgrohe Medium glijstangen | 759 | Huppe 1002 Jette Joop vijfhoek | 1053 |
| Hansgrohe Medium glijstangsets | 760 | Huppe 2000 badklapwand | 1046 |
| Hansgrohe Medium handdouches | 756 | Huppe 2000A badklapwand | 1046 |
| Hansgrohe Medium hoofddouches | 757 | Huppe 2002 kwartrond | 1055 |
| Hansgrohe Metris-E | 539 | Huppe 2002 vierhoek | 1055 |
| Hansgrohe Metris-S | 540 | Huppe 2003JJ kwartrond | 1058, 1060 |
| Hansgrohe Metropol | 677 | Huppe 2003JJ vierhoek | 1056, 1058 |
| Hansgrohe Metropol-E | 541 | Huppe 2003JJ vierhoek Walk-In | 1059 |
| Hansgrohe Metropol-S | 542 | Huppe 2003JJ vijfhoek | 1057, 1059 |
| Hansgrohe Montreux | 543, 677, 768, 962 | Huppe 3000 badklapwand | 1046 |
| Hansgrohe Onderdelen | 771 | Huppe 3000 Magna | 1060 |
| Hansgrohe Philippe Starck | 768, 963 | Huppe Butler 2000 | 1046 |
| Hansgrohe Premium doucheslangen | 763 | Huppe Classique | 302 |
| Hansgrohe Premium glijstangsets | 760 | Huppe Entrada 2000 | 351 |
| Hansgrohe Premium handdouches | 756 | Huppe Entrada 5000 | 351 |
| Hansgrohe Premium hoofddouches | 757 | Huppe Jette Joop JJ3 kwartrond | 1055 |
| Hansgrohe Raindance | 763 | Huppe Jette Joop JJ3 vierhoek | 1054 |
| Hansgrohe sauna/fitness programma | 759 | Huppe Marano | 302 |
| Hansgrohe spiegels en verlichting | 969 | Huppe toebehoren | 1061 |
| Hansgrohe Starck | 677 | | |
| Hansgrohe Starck X | 677 | I | |
| Hansgrohe Steel | 678, 769, 965 | Ideal Standard Alfieri | 571, 772 |
| Hansgrohe Talis E2 | 557 | Ideal Standard Celia | 81, 571, 679, 772 |
| Hansgrohe Talis Elegance | 556 | Ideal Standard Ceramix | 572, 679 |
| Hansgrohe Talis S | 557, 678 | Ideal Standard Cerasprint | 679 |
| Hansgrohe Talis S2 | 558 | Ideal Standard CeraTherm 100 | 572 |
| Hansgrohe Terrano | 770, 966 | Ideal Standard CeraTherm 200 | 572 |
| Hansgrohe Toebehoren | 678 | Ideal Standard CeraTherm 300 | 573 |
| Hansgrohe Universeel | 567 | Ideal Standard CeraTherm Universeel | 573 |
| Hansgrohe Universeel regendouches | 758 | Ideal Standard Cerawell 100 | 772 |
| Hansgrohe Uno | 678, 770, 968 | Ideal Standard Cerawell 200 | 772 |
| Hansgrohe Variarc | 678 | Ideal Standard Cerawell 200S | 772 |
| Hansgrohe wandhouders | 761 | Ideal Standard Cerawell 300 | 772 |
| Hansgrohe zijdouches | 758 | Ideal Standard Cerawell 300S | 773 |
| Haro Costa | 1168 | Ideal Standard Cleartap | 679 |
| Haro Passat | 1168 | Ideal Standard Dualux | 574 |
| Haro Pool Aktiv | 1168 | Ideal Standard Esprit | 82 |
| Hewi serie | 972 | Ideal Standard I.Q. | 82 |
| Hewi serie 440 | 971 | Ideal Standard Marc Newson | 83, 773 |
| Hoekstopkranen Schell | 1158 | Ideal Standard onderdelen | 88 |
| Hoekstopkranen VSH | 1158 | Ideal Standard Oval | 83 |
| Hoesch 1930 | 291 | Ideal Standard Privo | 84 |
| Hoesch Abano Basic | 349 | Ideal Standard San Remo | 84 |
| Hoesch Abano Mini | 349 | Ideal Standard Sapho | 85 |
| Hoesch Abano Primo | 349 | Ideal Standard Small+ | 85 |
| Hoesch Abano Uno 1300 Nova | 349 | Ideal Standard Tonic | 86, 574, 773 |
| Hoesch Andree Putman | 291 | Ideal Standard Universeel | 88 |
| Hoesch Armada | 291 | Ideal Standard Venice | 574 |
| Hoesch Aviva | 291 | Ideal Standard Venice21 | 86 |
| Hoesch Avventura | 291 | Ideal Standard Washpoint | 88 |
| Hoesch Capri | 292 | Ideal Standard XL | 88 |
| Hoesch Chios | 300 | Imar inbouw wastafels | 246 |
| Hoesch Deltanova | 292 | Inbouw afvoerbuis RM&CO | 1125 |
| Hoesch Dreamscape | 292 | Inbouwsifons Viega | 1125 |
| Hoesch Foster | 292, 300, 349, 1045 | Inda Accessoires | 973 |
| Hoesch Giorno | 292, 300 | Inda Alessi | 973, 1261 |
| Hoesch Giorno Clever | 1045 | Inspectieluiken Alpro | 1134 |
| Hoesch HappyD | 293, 300 | Installatiesystemen Burda | 1206 |
| Hoesch Holland Line | 293, 300 | Installatiesystemen Geberit Gis | 1187 |
| Hoesch Lima | 301 | Installatiesystemen Viega | 1207 |
| Hoesch Medici | 295 | Intersan Isitub | 352 |
| Hoesch Midi Ovaal | 295 | Intersan Sonora | 352 |
| Hoesch Mini Nova | 350 | Intersan Thermotub | 352 |
| Hoesch Modula | 295 | Intersan wastroggen en -fonteinen | 1301 |
| Hoesch Nano | 301 | Isolatieset | 1156 |

| | | | |
|---------------------------------|--------------------|-------------------------------|---------------|
| J | | | |
| Jado Geometry | 576, 680, 774, 976 | Keramag Espital | 116 |
| Jado New Haven | 580, 977 | Keramag Eurotrend | 96 |
| Jado Universeel | 581, 774 | Keramag Felino | 97 |
| JOOP! baden / douchebakken | 304 | Keramag Fidelio | 98 |
| | | Keramag Flow | 98 |
| K | | Keramag Flurinal | 117 |
| Kaldewei Aquamarin | 259 | Keramag Fora | 101 |
| Kaldewei Aquamarinstar | 259 | Keramag gootstenen | 1299 |
| Kaldewei Belleza | 268 | Keramag Joly | 101 |
| Kaldewei Centro Duo | 259 | Keramag Joop | 102 |
| Kaldewei Classic Duo | 260 | Keramag JOOP! douchewanden | 1062 |
| Kaldewei Conoduo | 260 | Keramag Kind | 118 |
| Kaldewei Conoplan | 268 | Keramag Opus | 106 |
| Kaldewei Corpo Duo | 260 | Keramag Paracelsus | 118 |
| Kaldewei Corpo Duo Star | 260 | Keramag Plus4 | 106 |
| Kaldewei Duo Pool | 260 | Keramag Preciosa | 118 |
| Kaldewei Duschplan | 269 | Keramag Public Line | 106 |
| Kaldewei Dyna | 261 | Keramag Renova | 107 |
| Kaldewei Dyna Duo | 261 | Keramag Renova-Comprimo | 107 |
| Kaldewei Dyna Set | 261 | Keramag Renova-Plan | 108 |
| Kaldewei Dyna Set Star | 261 | Keramag Sensonal | 119 |
| Kaldewei Dyna Star | 261 | Keramag Separo | 119 |
| Kaldewei Dynaplan | 270 | Keramag Sinfo | 108 |
| Kaldewei Ergonova Duo | 261 | Keramag Virto | 108 |
| Kaldewei Fontana | 270 | Keramag Visit | 109 |
| Kaldewei Kusatsu Pool | 262 | Keramag Vitalis | 119 |
| Kaldewei Lacosta | 270 | Keramag Vitelle | 111 |
| Kaldewei Mega Duo | 262 | Keramag Vivano | 114 |
| Kaldewei Mega Duo 6 | 262 | Kermi Aska XP | 1063 |
| Kaldewei Megaplan | 270 | Kermi Atea | 1068-1070 |
| Kaldewei Novola | 262 | Kermi Atea accessoires | 1072 |
| Kaldewei Novola Duo 6 | 263 | Kermi Ibiza 2000 | 1072 |
| Kaldewei Novola Duo 6 Star | 263 | Kermi Ibiza 2000 accessoires | 1077 |
| Kaldewei Novola Duo Oval | 263 | Kermi Nova 2000 | 1078 |
| Kaldewei Novola Star / Duo Star | 262 | Kermi Rialto accessoires | 1084 |
| Kaldewei Novolaplan | 270 | Kermi Rialto XS | 1079 |
| Kaldewei Punta Duo 3 | 263 | Kermi Siesta | 1084 |
| Kaldewei Quinto | 270 | Kermi Toca-XP | 1086 |
| Kaldewei Retro | 263 | Kermi Vario 2000 | 1092 |
| Kaldewei Retro 6 | 263 | Kermi Walk-In | 1095 |
| Kaldewei Retro 8 | 263 | Keuco Alea | 979 |
| Kaldewei Retro 8 Star | 263 | Keuco Amaro | 980 |
| Kaldewei Retro Star | 263 | Keuco Apollo | 981 |
| Kaldewei Rondana | 270 | Keuco Astor | 981 |
| Kaldewei Rondezza | 271 | Keuco City.2 | 983 |
| Kaldewei Rondo | 264 | Keuco City.2 Onderdelen | 985 |
| Kaldewei Rondo 6 | 264 | Keuco Cleo | 985 |
| Kaldewei Rondo 8 | 264 | Keuco douchegordijn - stangen | 1004 |
| Kaldewei Rondostar | 264 | Keuco Edition 100 | 986 |
| Kaldewei Sanidusch | 268 | Keuco Edition 200 | 988 |
| Kaldewei Saniform Medium | 264 | Keuco Edition 300 | 989 |
| Kaldewei Saniform Plus | 264 | Keuco Edition 300 Onderdelen | 991 |
| Kaldewei Saniform Plus Star | 262 | Keuco Elegance | 991 |
| Kaldewei Sanilux | 264 | Keuco Futura | 994 |
| Kaldewei Saniluxstar | 264 | Keuco Joly | 582, 994 |
| Kaldewei Sento Star | 265 | Keuco lampen | 1005 |
| Kaldewei Studio | 265 | Keuco Plan | 584, 995 |
| Kaldewei Superplan | 271-272 | Keuco Royal | 1282 |
| Kaldewei systeemraam ESR | 273 | Keuco Smart | 997 |
| Kaldewei Toebehoren | 266, 274 | Keuco Smart Onderdelen | 999 |
| Kaldewei Twin Pool | 265 | Keuco Solo | 999 |
| Kaldewei Vaio | 266 | Keuco spiegels | 1004 |
| Kaldewei Vaio 6 | 266 | Keuco Trias | 1001 |
| Kaldewei Vaio 6 Star | 266 | Keuco Universeel | 1005 |
| Kaldewei Vaio Duo | 265 | Keuco Visit | 110, 1003 |
| Kaldewei Vaio Duo 3 | 265 | Keukenkranen Damixa | 655 |
| Kaldewei Vaio Duo 6 | 265 | Keukenkranen Dornbracht | 660 |
| Kaldewei Vaio Duo 8 | 266 | Keukenkranen Gessi | 663 |
| Kaldewei Vaio Duo Oval | 265 | Keukenkranen Grohe | 672 |
| Kaldewei Vaio Set | 266 | Keukenkranen Hansa | 676 |
| Kaldewei Vaio Set Star | 266 | Keukenkranen Hansgrohe | 677 |
| Kaldewei Vaio Star | 266 | Keukenkranen Ideal Standard | 679 |
| Kaldewei Zirkon | 273 | Keukenkranen Jado | 680 |
| Keramag Aller | 116 | Keukenkranen Kludi | 682 |
| Keramag Cassini | 90 | Keukenkranen KWC | 687 |
| Keramag Cavelle | 93 | Keukenkranen Nobili | 691 |
| Keramag Centauris | 116 | Keukenkranen Plieger | 692 |
| Keramag Citterio | 91 | Keukenkranen Sphinx | 693 |
| Keramag Cleo | 93 | Keukenkranen Venlo | 695 |
| Keramag Coppelia | 116 | Keukenkranen Villeroy & Boch | 699 |
| Keramag Cotta | 94 | Kludi Adlon | 586, 682 |
| Keramag Emani | 116 | Kludi Almera | 586, 682 |
| | | Kludi Amphora | 587, 682, 781 |

| | | | |
|--|----------|---|----------|
| Kludi Basis programma | 777 | Kunststof douchebakken Riho | 322 |
| Kludi Bingo | 682 | Kunststof douchebakken Sphinx | 328 |
| Kludi Bingo Star | 590 | Kunststof douchebakken Ucosan | 334 |
| Kludi Bingo-Tec | 682 | Kunststof douchebakken Villeroy & Boch | 344 |
| Kludi douchepanelen | 799 | Kunststof plugbekersifons Plieger | 1128 |
| Kludi Evita Classic | 591 | Kunststof plugbekersifons Viega | 1128 |
| Kludi Evita Design | 590 | KWC Disko | 613 |
| Kludi Freshline programma | 778 | KWC Domo | 687 |
| Kludi Joop | 592, 782 | KWC Eve | 687 |
| Kludi Joop! | 1007 | KWC Fit | 786 |
| Kludi Kido | 594, 782 | KWC Gastro | 687 |
| Kludi Komet | 682 | KWC Gastro Onderdelen | 688 |
| Kludi Logomix | 591, 683 | KWC Konos | 688 |
| Kludi Medi-Care | 596, 785 | KWC Luna | 689 |
| Kludi Medi-Mix | 683 | KWC Onderdelen | 613 |
| Kludi Medimix | 597 | KWC Orcino | 689 |
| Kludi Medium programma | 776 | KWC Star | 689 |
| Kludi Mix | 598, 683 | KWC Style | 690 |
| Kludi Mx | 598 | KWC Systema | 690 |
| Kludi New Waves | 601 | KWC Toebehoren | 613 |
| Kludi Newwaves | 684, 783 | KWC Universeel | 613 |
| Kludi Objekta Mix | 605 | KWC Zeepdispensers | 613 |
| Kludi Objekta Mix NEW | 605 | | |
| Kludi Onderdelen | 612 | L | |
| Kludi Quick-stop | 686 | Laufen Alessi | 121, 305 |
| Kludi Refixa programma | 780 | Laufen Alessi douchebakken | 306 |
| Kludi Sensora | 606 | Laufen Fiora | 122 |
| Kludi Sirene Care | 781 | Laufen Gallery | 122 |
| Kludi Standaard programma | 780 | Laufen Living | 125 |
| Kludi Standaard Terralux | 684 | Laufen Moderna | 127 |
| Kludi Standaard-Optima | 606, 684 | Laufen MyLife | 127 |
| Kludi Steel | 685 | Laufen Palace | 129 |
| Kludi Swingline | 684 | Laufen Palace Due | 129 |
| Kludi Tercio | 607, 685 | Laufen Palomba | 130 |
| Kludi Terralux-Standaard | 608 | Laufen Pro | 134 |
| Kludi Toebehoren | 612 | Laufen Pro A | 132 |
| Kludi Top programma | 776 | Laufen Pro B | 133 |
| Kludi Trendo | 685 | Laufen Pro C | 134 |
| Kludi Universeel | 610, 785 | Laufen Suprema | 136 |
| Kludi Zenta | 686, 784 | Laufen Talux | 136 |
| Kludi Zip | 686 | Laufen Toebehoren | 140 |
| Kranen | 358 | Laufen Vienna | 138 |
| Kranen Dornbracht | 371 | Laufen Vienna Comfort | 139 |
| Kranen Fantini | 411 | Luca vloerwisser | 1028 |
| Kranen Gessi | 413 | Luchtroosters | 1134 |
| Kranen Grohe | 471 | | |
| Kranen Hansa | 506 | M | |
| Kranen HansGrohe | 524 | Meubelen + spiegelkasten Emco | 1259 |
| Kranen Ideal Standard | 571 | Meubelen Burg | 1220 |
| Kranen Jado | 576 | Meubelen Dansani | 1223 |
| Kranen Keuco | 582 | Meubelen Detremmerie | 1224 |
| Kranen Kludi | 586 | Meubelen Duravit | 1249 |
| Kranen KWC | 613 | Meubelen Inda | 1261 |
| Kranen Nobili | 615 | Meubelen Plieger | 1263 |
| Kranen Oras | 617 | Meubelen Riho | 1266 |
| Kranen Plieger | 618 | Meubelen SaniJura | 1272 |
| Kranen Schell | 626 | Meubelen Schock | 1274 |
| Kranen Sphinx | 627 | Meubelsifons Viega | 1129 |
| Kranen Venlo | 631 | Multifunctionele douches Duravit | 348 |
| Kranen Villeroy & Boch | 647 | | |
| Kuhfuss gootstenen | 1302 | N | |
| Kunststof baden /douchebakken JOOP! | 304 | Neoperl kraan Toebehoren | 703 |
| Kunststof baden Duravit | 277 | Nil hoekstopkranen | 704 |
| Kunststof baden Duscholux | 285 | Nil kraan Toebehoren | 704 |
| Kunststof baden Hoesch | 291 | Nobili Dune | 615 |
| Kunststof baden Laufen | 305 | Nobili Palladio | 691 |
| Kunststof baden Plieger Design | 307 | Nobili Palladio (Designed by Pininfarina) | 615 |
| Kunststof baden Plieger Exclusief | 309 | Nobili Wishwash Plus | 615, 691 |
| Kunststof baden Riho | 315 | Novellini Aurora | 1098 |
| Kunststof baden Sphinx | 325 | Novellini Giada | 1100 |
| Kunststof baden Ucosan | 330 | Novellini Jolly 2 | 1101 |
| Kunststof baden Villeroy & Boch | 336 | Novellini King | 1101 |
| Kunststof bekersifons McALPINE | 1127 | Novellini Peter | 1102 |
| Kunststof bekersifons Viega | 1127 | Novellini Star | 1102 |
| Kunststof bekersifons Wisa | 1127 | Novellini Victory-A | 306 |
| Kunststof buissifons ABS | 1127 | Novellini Victory-B | 306 |
| Kunststof douchebakken Duravit | 281 | Novellini Victory-P1 | 306 |
| Kunststof douchebakken Duscholux | 289 | Novellini Young | 1104 |
| Kunststof douchebakken Hoesch | 300 | | |
| Kunststof douchebakken Huppe | 302 | O | |
| Kunststof douchebakken Novellini | 306 | Onderdelen de Beer | 1132 |
| Kunststof douchebakken Plieger Design | 312 | Onderdelen Duravit | 1132 |
| Kunststof douchebakken Plieger Exclusief | 313 | Onderdelen Grohedal | 1217 |

| | | | |
|---------------------------------------|-------------------------------------|--------------------------------------|--------------------------|
| Onderdelen Liberty | 1171 | Plieger Naxos | 308 |
| Onderdelen McALPINE | 1132 | Plieger Onderdelen | 623 |
| Onderdelen Plieger | 1132 | Plieger Paros | 308 |
| Onderdelen Plieger Softclose | 1171 | Plieger Pico | 623 |
| Onderdelen Schell | 1218 | Plieger Queen | 308 |
| Onderdelen Spring | 1171 | Plieger reservoir Onderdelen | 1198 |
| Onderdelen Viega | 1132 | Plieger Rimini | 244 |
| Oras Il Bagno Alessi | 617, 787 | Plieger Ron_D | 1263 |
| Othello glaswissers | 889 | Plieger Royal douchewanden | 1108 |
| | | Plieger Royalty | 308 |
| | | Plieger Samos | 308 |
| | | Plieger Savona | 244 |
| P | | Plieger Softclose | 1171 |
| Packs, complete sets in doos | 232 | Plieger spiegelkast onderdelen | 1291 |
| Pagette Athena | 1169 | Plieger Spring | 146, 309, 313, 788, 1011 |
| Pagette Ecotop | 1193 | Plieger Spring afdekplaten | 1198 |
| Pagette Exklusiv Highline | 1169 | Plieger Spring inbouwreservoir | 1198 |
| Pagette Kadett | 1169 | Plieger Spring New | 622, 692, 1011 |
| Pagette Kadett 300S | 1169 | Plieger Spring Project | 622, 692 |
| Pagette Maxime | 1169 | Plieger Square | 244 |
| Pagette Nordica | 1169 | Plieger Standaard | 275-276, 307 |
| Pagette Nova | 1169 | Plieger Teorema | 244 |
| Pagette Orenda | 1169 | Plieger Toebehoren | 308, 623 |
| Pagette Primat | 1170 | Plieger Trend | 1265 |
| Pagette VIP | 1170 | Plieger Trend onderdelen | 1265 |
| Pharo Comfort | 800 | Plieger Trento | 245 |
| Pharo douchezuil | 790 | Plieger Tuli | 245 |
| Pharo Helis | 800 | Plieger universeel | 789 |
| Pharo Lift II | 800 | Plieger verhoogde closetpotten | 147 |
| Pharo Moonlight | 800 | Plieger Verona | 245 |
| Pharo Prestige | 800 | Plieger Vicenza | 245 |
| Plaatstaal baden Bette | 250 | Plieger Weser laaghangend reservoir | 1194 |
| Plaatstaal baden Kaldewei | 259 | Plieger whirlpoolsysteem Hydro-2 | 311 |
| Plaatstaal baden Plieger | 275 | Plieger whirlpoolsysteem Spa-1 | 311 |
| Plaatstaal douchebakken Bette | 256 | Plieger whirlpoolsysteem Spa/Hydro-3 | 311 |
| Plaatstaal douchebakken Kaldewei | 268 | Plieger whirlpoolsysteem Toebehoren | 311 |
| Plaatstaal douchebakken Plieger | 276 | Plieger Winston | 147 |
| planchets | 1032-1033 | Plieger Zurich | 308 |
| planchets Carrara & Matta | 1033 | Plugbekersifons Plieger | 1128 |
| planchets Plieger | 1033 | Plugbekersifons Viega | 1128 |
| planchets Schwab | 1033 | Plugbuissifons Viega | 1130 |
| Plieger badklapwanden | 1109 | Pressalit 300 | 1173 |
| Plieger Basic | 307 | Pressalit 2000 | 1173 |
| Plieger Bergamo | 243 | Pressalit Amadea | 1173 |
| Plieger Bern | 307 | Pressalit bevestigingsgarnituur | 1175 |
| Plieger Boule | 243 | Pressalit Chess Uni | 1173 |
| Plieger Brussel | 275-276, 618, 692, 1171 | Pressalit Comprimo 2000 | 1173 |
| Plieger Brussel laaghangend reservoir | 1194 | Pressalit Dania | 1173 |
| Plieger Brussel New | 141, 788, 1009 | Pressalit Dania Rehab | 1173 |
| Plieger Cati | 243 | Pressalit Ergosit Rehab | 1173 |
| Plieger Charleston | 619, 692, 788 | Pressalit Evident | 1174 |
| Plieger Class douchewanden | 1108 | Pressalit Magnum | 1174 |
| Plieger Compact | 142 | Pressalit Objecta | 1174 |
| Plieger Cono | 243 | Pressalit Onderdelen | 1175 |
| Plieger Contour | 307 | Pressalit Privilege | 1174 |
| Plieger Corfu | 307 | Pressalit Projecta | 1174 |
| Plieger Cucina | 243 | Pressalit Raja | 1174 |
| Plieger Cyprus | 307 | Pressalit Scandinavia | 1174 |
| Plieger Douro | 307 | Pressalit Tivoli-2 | 1174 |
| Plieger Economy douchewanden | 1108 | Pressalit Uni Monsoon | 1175 |
| Plieger Gina | 243, 622 | Pressalit Viala | 1175 |
| Plieger Globe | 1013 | Pressalit wandafvallemmers | 1175 |
| Plieger gootstenen | 1296 | Pressalit Zaga | 1175 |
| Plieger Havanna | 1014 | Pressalit Zenit | 1175 |
| Plieger hoekinbouwreservoir | 1194 | | |
| Plieger hoekstopkranen | 707 | | |
| Plieger Imola | 243 | | |
| Plieger inbouwastafels | 243 | | |
| Plieger kraan Toebehoren | 706 | R | |
| Plieger kraanaansluitingen | 706 | Reservoir Onderdelen de Beer | 1154 |
| Plieger Kreta | 307 | Reservoir Onderdelen Fluidmaster | 1154 |
| Plieger Kusasi | 622 | Reservoir Onderdelen Sphinx | 1155 |
| Plieger Lech hooghangend reservoir | 1194 | Reservoir Onderdelen Venlo | 1155 |
| Plieger Liberty | 144, 309, 313, 619, 788, 1010, 1263 | Reservoir Onderdelen VSH | 1155 |
| Plieger Liberty afdekplaten | 1198 | Reservoirs ABU | 1179 |
| Plieger Liberty inbouwreservoir | 1196 | Reservoirs Geberit | 1180 |
| Plieger Liberty New | 1010 | Reservoirs Grohedal | 1189 |
| Plieger Liberty New Onderdelen | 1011 | Reservoirs Pagette | 1193 |
| Plieger Locarno | 243 | Reservoirs Plieger | 1194 |
| Plieger Lugano | 244 | Reservoirs Rezi | 1199 |
| Plieger Luna | 244 | Reservoirs Schwab | 1200 |
| Plieger Lupo | 623 | Reservoirs Wisla | 1202 |
| Plieger Luxury | 312 | Rezi BB4321 hooghangend reservoir | 1199 |
| Plieger Luzern | 307 | Rezi BB4330 laaghangend reservoir | 1199 |
| Plieger Milos | 308 | Rezi BB4700 laaghangend reservoir | 1199 |
| | | Rezi BB4800 laaghangend reservoir | 1199 |

| | | | |
|-----------------------------------|-----------|---------------------------------------|--|
| Rezi BB4850 laaghangend reservoir | | | |
| Rezi bevestigingsgarnituur | | | |
| Rezi Envoy | | | |
| Rezi Mercia | | | |
| Rezi Modernline | | | |
| Rezi Populair | | | |
| Rezi reservoir Onderdelen | | | |
| Rezi Variant | | | |
| Riho 201 | 1199 | Riho Sobek | 319 |
| Riho 202 | 1176 | Riho Taurus | 319 |
| Riho 207 | 1176 | Riho Tiamo1 | 1270 |
| Riho 209 | 1176 | Riho Tiamo2 | 1270 |
| Riho 210 | 1176 | Riho Tivoli | 1271 |
| Riho 211 | 1176 | Riho Toebehoren | 321, 1271 |
| Riho 212 | 1199 | Riho Tofield | 319 |
| Riho 213 | 1176 | Riho Verona-tech 1 | 353 |
| Riho 214 | 322 | Riho Verona-tech 2 | 353 |
| Riho 215 | 322 | Riho Virgo | 320 |
| Riho 224 | 322 | Riho Winnipeg | 320 |
| Riho 226 | 322 | Riho Yukon | 320 |
| Riho 228 | 322 | | |
| Riho 248 | 322 | S | |
| Riho 250 | 322 | Sanibroyeur de Luxe | 1212 |
| Riho 252 | 322 | Sanibroyeur Sanibest | 1212 |
| Riho 254 | 322 | Sanibroyeur Sanicom | 1212 |
| Riho 256 | 323 | Sanibroyeur Sanicomcompact C43 | 1212 |
| Riho 258 | 323 | Sanibroyeur Sanicomcompact C48 | 1212 |
| Riho 260 | 323 | Sanibroyeur Sanicomcompact Elite | 1212 |
| Riho 278 | 323 | Sanibroyeur Sanicomcompact Luxe | 1212 |
| Riho 279 | 323 | Sanibroyeur Sanicomcompact Star | 1212 |
| Riho 280 | 323 | Sanibroyeur Sanicondens | 1212 |
| Riho 281 | 323 | Sanibroyeur Sanicubic | 1212 |
| Riho 284 | 323 | Sanibroyeur Sanidouche | 1212 |
| Riho 285 | 323 | Sanibroyeur Sanipack | 1212 |
| Riho 288 | 323 | Sanibroyeur Saniplus | 1212 |
| Riho 289 | 323 | Sanibroyeur Sanipro | 1212 |
| Riho Alberta | 324 | Sanibroyeur Sanispeed | 1212 |
| Riho Apollo | 324 | Sanibroyeur Sanitop | 1213 |
| Riho Atlanta | 324 | Sanibroyeur Sanivite | 1213 |
| Riho Austin | 324 | Sanibroyeur Toebehoren | 1213 |
| Riho Bayline Milano | 315, 321 | Sanibroyeur X2 | 1212 |
| Riho Bayline Ortone | 315, 321 | SaniJura Dolfijn | 1272 |
| Riho Bayline Porto | 315, 321 | SaniJura Twin | 1272 |
| Riho Bayline Vicenza | 315, 321 | SaniJura Universeel | 1273 |
| Riho Bologna | 1266 | Sanishield | 1118 |
| Riho Calgary | 315 | Sanitair | 28, 250, 358, 714, 802, 1036, 1120, 1164, 1220, 1294 |
| Riho Carolina | 315 | Sanitair Duravit | 28 |
| Riho Colorado | 316 | Sanitair Ideal Standard | 80 |
| Riho Columbia | 316 | Sanitair Keramag | 90 |
| Riho Daytona | 316 | Sanitair Laufen | 121 |
| Riho Doppio | 316, 1266 | Sanitair Plieger | 141 |
| Riho Dorado | 316 | Sanitair producten | 28 |
| Riho Easypool Carolina | 321 | Sanitair Sphinx | 148 |
| Riho Easypool Tofield | 321 | Sanitair Venlo | 174 |
| Riho Future | 316 | Sanitair Villeroy & Boch | 176 |
| Riho Garda | 1267 | Schell hoekstopkranen | 708 |
| Riho Geta | 317 | Schell kraan Toebehoren | 708 |
| Riho Imola | 1268 | Schell Petit SC | 626 |
| Riho Lima | 317 | Schell Puris | 626 |
| Riho Lucca | 1268 | Schell Venus | 626 |
| Riho Lugano | 317 | Schneider ClassicPlus | 1287 |
| Riho Lusso | 317, 1269 | Schneider Flexline | 1287 |
| Riho Lyra | 318 | Schneider HipLine | 1287 |
| Riho Madison A | 353 | Schneider Peakline | 1288 |
| Riho Madison B | 353 | Schneider Proline | 1288 |
| Riho Majestic | 353 | Schneider QuadraLine | 1288 |
| Riho Memphis A | 353 | Schneider RonLine | 1288 |
| Riho Memphis B | 353 | Schneider RonPlus | 1289 |
| Riho Miami | 318 | Schneider SplashLine | 1289 |
| Riho Modena | 318 | Schneider TriLine | 1290 |
| Riho Montreal | 318 | Schock Arcos | 1284 |
| Riho Neo | 318 | Schock Aura | 1284 |
| Riho Nora | 319 | Schock Capri | 1285 |
| Riho Nordica | 1110 | Schock Chico | 1279 |
| Riho Orion | 319 | Schock Cona | 1274 |
| Riho Ottawa | 319 | Schock Dart | 1274 |
| Riho Pasadena | 319 | Schock De Luxe | 1274 |
| Riho Pegas | 319 | Schock Luna | 1285 |
| Riho Perth | 319 | Schock Nice | 1285 |
| Riho Pronto | 1269 | Schock Quant | 1280 |
| Riho Rimini | 1269 | Schock Rigo | 1286 |
| Riho Saturnus | 324 | Schock Ripo | 1275 |
| Riho Seth | 319 | Schock Sepa | 1276, 1286 |
| | | Schock Siro | 1286 |
| | | Schock Verto | 1286 |
| | | Schock Viva | 1277 |
| | | Schock Vivo | 1278 |
| | | Schwab 4000 laaghangend reservoir | 1200 |
| | | Schwab Saninorm laaghangend reservoir | 1200 |
| | | Seppelfricke doucheprogramma | 791 |
| | | Shower Collection | 1111 |
| | | Shower Collection Adelaide | 1111 |

| | | | |
|------------------------------------|----------------|---------------------------------------|---------------|
| Shower Collection Auckland | 1111 | Toebehoren Hansgrohe | 1034 |
| Shower Collection Brisbane | 1111 | Toebehoren Kipp | 1034 |
| Shower Collection Canberra | 1111 | Toebehoren Magnum | 1034 |
| Shower Collection Melbourne | 1111 | Toebehoren Plieger | 1034 |
| Shower Collection Portland | 1111 | Toebehoren reservoir | 1154 |
| Shower Collection Preston | 1112 | Toebehoren sifons Geberit | 1125 |
| Shower Collection Round Innovation | 1112 | Toebehoren Uridan | 1159 |
| Shower Collection Sydney | 1112 | Toebehoren urinoir | 1159 |
| Shower Collection Wellington | 1112 | Toebehoren wastafel | 1121 |
| Sifons Geberit | 1125 | Trento fonteinkbakjes | 247 |
| Sphinx 280 | 148 | | |
| Sphinx 300 | 325 | U | |
| Sphinx 300 [New Eurobase] | 167 | Ucosan Andromeda | 330 |
| Sphinx 330 | 150 | Ucosan Artica | 355 |
| Sphinx 340 | 151, 326, 1016 | Ucosan Cassandra | 330 |
| Sphinx 340 / 360 | 792, 1017 | Ucosan Cassandra Easy Collection | 333 |
| Sphinx 340/Linate 360/Flash | 328 | Ucosan Denia | 334 |
| Sphinx 360 | 153, 326, 627 | Ucosan Dodona | 330 |
| Sphinx 380 | 153, 325 | Ucosan Dodona Easy Collection | 333 |
| Sphinx 390 | 156 | Ucosan Nayobe | 331 |
| Sphinx 420 | 157, 1017 | Ucosan Nayobe Easy Collection | 333 |
| Sphinx 450 | 159, 325, 627 | Ucosan Omain | 332 |
| Sphinx 450/Atlantic | 792, 1016 | Ucosan Sensis | 334 |
| Sphinx Animo II | 161 | Ucosan Toebehoren | 332-333 |
| Sphinx Antibes | 325, 328 | Ucosan Vitoria | 1116 |
| Sphinx Atlanta | 1113 | Universeel sifons McALPINE | 1130 |
| Sphinx Atlantic | 162, 325, 628 | Universeel sifons Viega | 1131 |
| Sphinx Avant | 1113 | Urinoirschot Geberit | 1160 |
| Sphinx ClarissaPlus | 326 | Urinoirschot Geesa | 1160 |
| Sphinx Continental | 326 | Urinoirsifon Duravit | 1159 |
| Sphinx Dio | 163 | Urinoirsifon Geberit | 1159 |
| Sphinx douchebak toebehoren | 329 | Urinoirsifon Viega | 1159 |
| Sphinx Ergonomic | 164 | Urinoirsifon Villeroy & Boch | 1159 |
| Sphinx Eurobase | 171, 628, 693 | urinoirspoelers Grohedal | 1216 |
| Sphinx Euromed | 629, 693 | urinoirspoelers Schell | 1218 |
| Sphinx Forma | 629, 792 | Utiliteit Plieger | 1132 |
| Sphinx gootstenen | 1303 | Utiliteit Viega | 1132 |
| Sphinx Milano | 172, 326 | | |
| Sphinx Mycene | 172, 326, 328 | V | |
| Sphinx Normaline | 326 | v.d. Berg afvoergoten en designputten | 1151 |
| Sphinx Onderdelen | 630 | v.d. Berg design doucheputten | 1151 |
| Sphinx onderdelen closetzittingen | 173 | v.d. Berg douchegoten | 1151 |
| Sphinx packs | 232 | v.d. Berg exclusieve doucheputten | 1151 |
| Sphinx Plana | 328 | v.d. Berg tegelgoten | 1151 |
| Sphinx Progress | 327 | v.d. Berg tegelputten | 1151 |
| Sphinx Punto | 173 | Valpijp Plieger | 1154 |
| Sphinx Quadro | 173 | Valpijpbeugels de Beer | 1154 |
| Sphinx Supratop | 1113 | Valpijpbocht Plieger | 1154 |
| Sphinx Terra | 327, 329 | Valpijpsok de Beer | 1154 |
| Sphinx Terrashower | 1113 | Valpijpverbinders Mulet | 1154 |
| Sphinx Toebehoren | 327 | Valpijpverbinders NKS | 1154 |
| Sphinx Twiggytop | 1113 | Venlo Arax | 631 |
| Sphinx Uniq | 630 | Venlo Astro | 631, 695, 793 |
| Sphinx Universeel | 172, 630 | Venlo Axxel | 632 |
| Sphinx Vision-A | 1114 | Venlo Culinaire-1000 | 695 |
| Sphinx Wellness Pluvia | 354 | Venlo Culinaire-2000 | 695 |
| Spiegelkasten Keuco | 1282 | Venlo Easy | 633, 695 |
| Spiegelkasten Plieger | 1291 | Venlo Maas | 793 |
| Spiegelkasten Schneider | 1287 | Venlo Neomix | 633 |
| Spiegelkasten Schock | 1284 | Venlo Nimbus | 174 |
| Spiegelkasten Villeroy & Boch | 1292 | Venlo Nimbus Comfort Eco | 634 |
| Spiegels | 1029 | Venlo Nimbus Comfort Keramisch | 640 |
| Spiegels Raminex SilkLine | 1031 | Venlo Nimbus Eco | 696 |
| Spoel- & installatiesystemen | 1164 | Venlo Nimbus Eco Comfort | 695 |
| Spoelers Aquia | 1159 | Venlo Nimbus Eco Nostaligisch | 697 |
| Spoelers Geberit | 1214 | Venlo Nimbus Keramisch Comfort | 697 |
| Spoelers Grohedal | 1215 | Venlo Nimbus Keramisch Nostaligisch | 697 |
| Spoelers Schell | 1216 | Venlo Nimbus Medical | 633 |
| Stoomcabines Hoesch | 1218 | Venlo Nimbus Messing Eco | 635 |
| Stoomcabines Riho | 349 | Venlo Nimbus Messing Keramisch | 641 |
| Stoomcabines Sphinx | 353 | Venlo Nimbus Nostaligisch Eco | 638 |
| Stoomcabines Villeroy & Boch | 354 | Venlo Nimbus Nostaligisch Keramisch | 640 |
| | 356 | Venlo Nimbus Project Eco | 638 |
| | | Venlo Noxxa | 643, 697, 793 |
| T | | Venlo Onderdelen | 646 |
| Toebehoren & afvoeren | 1120 | Venlo Project | 642, 794 |
| Toebehoren accessoires en spiegels | 1034 | Venlo Tado | 644, 698 |
| Toebehoren bad | 1134 | Venlo Toebehoren | 645 |
| Toebehoren bidet | 1161 | Venlo Venlomis Medical | 645 |
| Toebehoren closet | 1156 | VenloTherm Project | 645 |
| Toebehoren de Beer | 1159 | Verlichting voor spiegels | 1031 |
| Toebehoren douchebak | 1152 | Viegaswift bedieningsplaten | 1208 |
| Toebehoren fontein | 1120 | Viegaswift bouwsegmenten | 1207 |

| | | | |
|---|----------------|-------------------------------------|--------------|
| Viegaswift elementen | 1207 | Villeroy & Boch Taurus | 342 |
| Viegaswift modules | 1207 | Villeroy & Boch Toebehoren | 231, 342-343 |
| Viegaswift Toebehoren | 1208 | Villeroy & Boch Transimage | 228 |
| Villeroy & Boch Amadea | 176, 336 | Villeroy & Boch Tucana | 342, 347 |
| Villeroy & Boch Amata | 336 | Villeroy & Boch Universo | 231 |
| Villeroy & Boch Arriba | 177 | Villeroy & Boch Velvet | 229 |
| Villeroy & Boch Avansis | 344 | Villeroy & Boch Viala | 228 |
| Villeroy & Boch Aveo | 178, 336 | Villeroy & Boch Virage | 229 |
| Villeroy & Boch Bellevue | 180, 336 | Vloerpluggen ABS | 1142 |
| Villeroy & Boch Capacity | 1292 | Vloerpluggen VSH | 1142 |
| Villeroy & Boch Century | 183, 336, 344 | Vloerwisser | 1028 |
| Villeroy & Boch Ceta | 336 | VSH kraan Toebehoren | 711 |
| Villeroy & Boch Cetus | 336 | VSH kraanaansluitingen | 711 |
| Villeroy & Boch Circle | 647, 795, 1019 | | |
| Villeroy & Boch Colorado | 337 | W | |
| Villeroy & Boch Cult | 647, 795, 1020 | Waskommen / Wastafels Alape | 233 |
| Villeroy & Boch Cumulus | 344 | Waskommen Plieger | 243 |
| Villeroy & Boch Editionals | 185 | Wastafel bevestigingssets Duravit | 1121 |
| Villeroy & Boch Epura | 186, 337 | Wastafel bevestigingssets Keramag | 1121 |
| Villeroy & Boch Evana | 230 | Wastafel bevestigingssets Plieger | 1121 |
| Villeroy & Boch Firbo | 699 | Wastafel consoles Plieger | 1121 |
| Villeroy & Boch Florine | 230 | Wastafel consoles Toebehoren | 1121 |
| Villeroy & Boch Futurion | 345 | Wastafel ophanghaken de Beer | 1121 |
| Villeroy & Boch Geos | 346 | Wastafel ophanghaken Plieger | 1121 |
| Villeroy & Boch Grangracia | 188 | Wastafel/fontein pluggen de Beer | 1121 |
| Villeroy & Boch Hommage | 189 | Wastafel/fontein pluggen Dornbracht | 1122 |
| Villeroy & Boch Hype | 648, 795, 1021 | Wastafel/fontein pluggen Duravit | 1122 |
| Villeroy & Boch Ingo | 337 | Wastafel/fontein pluggen Hansgrohe | 1122 |
| Villeroy & Boch Isar | 337 | Wastafel/fontein pluggen Keramag | 1122 |
| Villeroy & Boch Libra | 337 | Wastafel/fontein pluggen Kludi | 1123 |
| Villeroy & Boch Lonina | 230 | Wastafel/fontein pluggen Plieger | 1123 |
| Villeroy & Boch Look | 649, 795, 1024 | Wastafel/fontein pluggen Sphinx | 1123 |
| Villeroy & Boch Loop | 230 | Wastafel/fontein pluggen Viega | 1124 |
| Villeroy & Boch Loop & Friends | 191 | Wastafels Dimensione | 241 |
| Villeroy & Boch LuXXus | 338 | Wastafels Gijs Frankenhuis | 247 |
| Villeroy & Boch Magnum | 192, 338, 346 | Wastafels Imar | 246 |
| Villeroy & Boch Meander | 338 | Wastroggen en -fontein Intersan | 1301 |
| Villeroy & Boch Memento | 194 | Whirlpoolsystemen Plieger Exclusief | 311 |
| Villeroy & Boch Nagano | 195, 338 | Whirlpoolsystemen Riho | 321 |
| Villeroy & Boch New Haven | 195 | Whirlpoolsystemen Ucosan | 333 |
| Villeroy & Boch NewWave | 338 | Whirlpoolsystemen Villeroy & Boch | 343 |
| Villeroy & Boch Nexion | 339 | Wisa 285 hooghangend reservoir | 1202 |
| Villeroy & Boch Nexus | 339 | Wisa 300 laaghangend reservoir | 1202 |
| Villeroy & Boch Oberon | 339 | Wisa 306 laaghangend reservoir | 1202 |
| Villeroy & Boch Oblic | 197 | Wisa 444 hoekreservoir | 1202 |
| Villeroy & Boch Omnia Architect | 198 | Wisa 500 laaghangend reservoir | 1202 |
| Villeroy & Boch Omnia Architectura | 339 | Wisa 790 laaghangend reservoir | 1202 |
| Villeroy & Boch Omnia Classic | 199 | Wisa 1000 laaghangend reservoir | 1202 |
| Villeroy & Boch Omnia Compact | 201 | Wisa 1040 laaghangend reservoir | 1202 |
| Villeroy & Boch Omnia gootstenen dubbel | 1304 | Wisa 2101 afdekplaten | 1204 |
| Villeroy & Boch Omnia gootstenen enkel | 1304 | Wisa 2103 afdekplaten | 1204 |
| Villeroy & Boch Omnia Pro | 202 | Wisa 2121 afdekplaten | 1203 |
| Villeroy & Boch Omnia Pro uitstortgootsteen | 1304 | Wisa Argos afdekplaten | 1204 |
| Villeroy & Boch Omnia Vita | 201 | Wisa Delos afdekplaten | 1204 |
| Villeroy & Boch Onderdelen | 1027 | Wisa Duoflux laaghangend reservoir | 1202 |
| Villeroy & Boch Pantro | 699 | Wisa Enyo afdekplaten | 1204 |
| Villeroy & Boch Parana | 340 | Wisa Excellent inbouwreservoirs | 1203 |
| Villeroy & Boch Pavia | 339 | Wisa Gaia afdekplaten | 1204 |
| Villeroy & Boch Private Lounge | 203 | Wisa Hera afdekplaten | 1204 |
| Villeroy & Boch Pure Basic | 205 | Wisa Jan des Bouvrie afdekplaten | 1203 |
| Villeroy & Boch Pure Stone | 206 | Wisa Maro afdekplaten | 1204 |
| Villeroy & Boch Quafit | 1117 | Wisa Mont inbouwreservoirs | 1203 |
| Villeroy & Boch Riante | 340 | Wisa reservoir Onderdelen | 1204 |
| Villeroy & Boch Riogrande | 340 | Wisa reservoir Toebehoren | 1202 |
| Villeroy & Boch Royale Hommage | 341 | Wisa Taras afdekplaten | 1204 |
| Villeroy & Boch Saar | 341 | Wisa Toebehoren | 1203 |
| Villeroy & Boch Sagitta | 341 | | |
| Villeroy & Boch Sagrada | 341 | | |
| Villeroy & Boch Saval | 209 | | |
| Villeroy & Boch Seine | 341 | | |
| Villeroy & Boch Sentique | 212, 341 | | |
| Villeroy & Boch Soho | 216 | | |
| Villeroy & Boch Source | 650, 796, 1025 | | |
| Villeroy & Boch Spica | 341 | | |
| Villeroy & Boch Square | 652, 796, 1026 | | |
| Villeroy & Boch Squaro | 341 | | |
| Villeroy & Boch Steam Fit | 356 | | |
| Villeroy & Boch Stratos | 217 | | |
| Villeroy & Boch Subway | 218, 341 | | |
| Villeroy & Boch Sunberry | 223, 342 | | |
| Villeroy & Boch Sunny | 227 | | |
| Villeroy & Boch Tallo | 699 | | |
| Villeroy & Boch Targa | 231 | | |

ALGEMENE VERKOOPS- EN BETALINGSVOORWAARDEN PLIEGER B.V. EN VESTIGINGEN

Aanbiedingen, Orders

1. Onze aanbiedingen, prijscouranten en CD-Rom zijn vrijblijvend, tenzij wij uitdrukkelijk anders vermelden. Bestellingen zijn voor ons slechts bindend, indien zij schriftelijk door ons zijn bevestigd. Aanvullingen, wijzigingen of afspraken, ook met onze vertegenwoordigers zijn niet van kracht zonder onze schriftelijke bevestiging. Behoudens uitdrukkelijke afspraak leveren wij gewone handelskwaliteit. Eventueel verlangde bijzondere kwaliteiten dienen bij een bestelling uitdrukkelijk te worden vermeld. Afbeeldingen, beschrijvingen, maten en gewichten, voorkomend in onze catalogi, prijscouranten, CD-Rom en aanbiedingen, zijn voor ons niet bindend. Adviezen onzerzijds omtrent toepassing van het door ons geleverde zijn vrijblijvend en leiden niet tot aansprakelijkheid onzerzijds voor de (wijze van) toepassing van het geleverde.
2. Wij zijn steeds gerechtigd, ook na gedeeltelijke uitvoering, vóór verdere levering, van de koper en zekerheidsstelling voor de tijdige en algehele voldoening van zijn verplichtingen te vorderen.
3. Overeenkomsten die per e-mail of internet tot stand komen, worden geacht te zijn gesloten in Zaltbommel.

Prijzen

4. Al onze prijzen zijn in euro's en gelden, indien niet anders overeengekomen, exclusief verpakking, af magazijn, of bij koop of aanvoer, af fabriek. Alle vrachten, in- en uitvoerrechten, statio-, opslag-, bewakings- en inklaringskosten, belastingen of andere heffingen, die na sluiten van de koopovereenkomst worden ingevoerd of verhoofd, komen, evenals nadien ingetreden voor ons nadelige wijzigingen van de wisselkoers, ten laste van de koper. Emballage, voorzover deze niet in de koopprijs is begrepen, wordt tegen de kostprijs berekend; de emballage wordt door ons teruggenomen en 2/3e van de kostprijs vergoed, mits zij vrachtvrij en in goede staat aan ons is teruggezonden. Mocht franko-levering zijn overeengekomen, zo hebben wij nochtans het recht om, indien de factuurwaarde der geleverde goederen lager dan € 770,- blijkt te zijn, de vracht aan de koper in rekening te brengen.

Levertijd

5. De levertijd geldt bij benadering, overmacht en onvoorziene omstandigheden voorbehouden. Bij aanbrenging van een tussentijdse wijziging in de order, wordt de levertijd overeenkomstig verlengd. Overschrijding van de levertijd geeft geen recht op verandering van betalingsvoorwaarden, korting, schadevergoeding of schadeloosstelling, noch op intrekken van de order. In geval van overmacht en/of onvoorziene omstandigheden, wordt de uitvoering van de bestelling opgeschort tot na het eindigen daarvan, tenzij wij binnen 90 dagen na het zich voordoen van een dergelijk geval schriftelijk aan de koper berichten, dat wij de bestelling, voorzover niet uitgevoerd, annuleren, in welk geval wij evenmin tot enige schadevergoeding of schadeloosstelling verplicht zijn. Ook wanneer levering uit voorraad is overeengekomen, hebben wij steeds het recht op aanvoer van een of meer fabrieken te leveren.

Overmacht

6. Onder overmacht wordt onder meer verstaan: ziekte onder het personeel, bedrijfsstoornis, mate-riaalfouten, gebrek aan grondstoffen, transportmoeilijkheden, oproer, staking, uitsluiting, maatregelen voortvloeiende uit mobilisatie, oorlogsgevaar, oorlogsdaden, maatregelen van overheidswege, ook indien deze moeilijkheden zich voordoen bij de fabrikant of een derde bij wie wij onzerzijds de ons opgegeven bestelling hebben geplaatst. Indien onder dergelijke omstandigheden onze leveranciers door prijsstijgingen en/of loonsverhogingen genoodzaakt zijn de met ons overeengekomen prijzen en voorwaarden te wijzigen, dan zullen wij dezelfde bevoegdheid tegenover onze kopers hebben.

Garantie

7. Voor de deugdelijkheid van de door ons geleverde goederen gaat onze garantie en aansprakelijkheid niet verder dan waarvoor door onze leveranciers wordt ingestaan. Onze garantie omvat in dat geval slechts het gratis herleveren, of gratis door ons doen herstellen van die onderdelen, waaraan gedurende de garantietermijn door ondeugdelijkheid van materiaal of constructie enig gebrek mocht ontstaan, indien dit onverwijld te onze kennis wordt gebracht en het onderdeel vrachtvrij aan ons wordt toegezonden. Wij zijn niet aansprakelijk voor schade door te late levering, bedrijfsstilstand, montage of demontage, winstderving of anderszins. De koper heeft niet het recht betaling te weigeren op grond van het feit, dat goederen, waarop onze garantie betrekking heeft, nog niet zijn hersteld of vervangen. Van defecten, tengevolge van onoordeelkundige behandeling en andere buiten het geleverde liggende factoren en/of van buiten af op het geleverde inwerkende omstandigheden, alsmede voor die gevallen waarvan de oorzaak niet duidelijk door de koper kan worden aangetoond, en in geval de koper zelf reparaties en/of veranderingen aan het geleverde aanbrengt, vervalt de garantie en aanvaarden wij geen aansprakelijkheid. Op reparaties wordt geen garantie verstrekt; vervangen onderdelen worden ons eigendom.

Vrijwaring

8. Onze aansprakelijkheid is beperkt tot de factuurwaarde van het aan de koper geleverde produkt waarop ons aansprakelijkheid betrekking heeft. De koper vrijwaart ons en stelt ons schadeloos terzake van aanspraken op schadevergoeding welke derden ten laste van ons moeten maken in verband met de door ons aan hem, koper, geleverde artikelen.

Vervoer

9. Het vervoer geschiedt steeds voor rekening en risico van de koper. Behoudens bijzondere afspraak bepalen wij het vervoermiddel. De clausele "onvoldoende verpakt" op vrachtbrieven of cognossementen dient slechts ter voldoening aan vervoersvoorschriften en geeft de koper nimmer enig recht jegens ons.

Verzekering

10. Wij verzekeren het transport alleen dan, indien de koper zulks uitdrukkelijk heeft verzocht. De kosten der verzekering zijn voor rekening van de koper.

Aflevering

11. Wanneer een gedeelte van een bestelling gereed is, kunnen wij dit deel leveren of wachten totdat al het bestelde gereed is. In het eerste geval moeten onze facturen, betrekking hebbende op de gedeeltelijke levering, overeenkomstig de voor de gehele order geldende betalingsvoorwaarden worden voldaan. Onze kopers kunnen alle uit onze magazijnen te leveren goederen vóór de verzending bezichtigen. Onze aansprakelijkheid eindigt zodra de goederen ons magazijn verlaten. Eventuele kosten ontstaan door de bezichtiging zijn voor rekening van de koper.

Terugzending

12. Wanneer onze kopers goederen aan ons terugzenden of teruggeven en daarvoor door ons een ontvangstbevestiging wordt afgegeven, betekent dit niet dat wij deze goederen aanvaarden. Slechts uit een door ons afgegeven kredietnota kan blijken dat wij de terugzending of teruggave der goederen aanvaarden.

Eigendomsvoorbehoud

- 13.1 Plieger B.V. behoudt de eigendom voor van alle door haar aan de koper afgeleverde zaken totdat de koopprijs voor al deze zaken geheel is voldaan. Tevens geldt de voorbehouden eigendom voor de vorderingen die Plieger B.V. tegen de koper mocht verkrijgen wegens tekortschieten van de koper in een of meer van zijn verplichtingen jegens de verkoper.
- 13.2 Zolang de eigendom van de afgeleverde zaken niet op de koper is overgegaan, mag deze de zaken niet verpanden of aan een derde enig ander recht daarop verlenen, behoudens het bepaalde in lid 8 van dit artikel.
- 13.3 Op afgeleverde zaken die door betaling in eigendom van de koper zijn overgegaan en zich nog in handen van de koper bevinden, behoudt Plieger B.V. zich hierbij reeds nu voor alldan pandrechten voor als bedoeld in art. 3:237 BW tot meerdere zekerheid van vorderingen, anders dan de in art. 3:92 lid 2 BW opgenoemde, die Plieger B.V. dan uit welke hoofde dan ook nog tegen de koper mocht hebben.
- 13.4 Bij de verwerking tot of vermenging met andere zaken door de koper van de door Plieger B.V. onder eigendomsvoorbehoud geleverde goederen, wordt de koper verondersteld deze verwerking of vermenging als onze lasthebbert tot stand te hebben gebracht en worden wij eigenaar

van het nieuwe voorwerp.

- 13.5 Indien en voorzover de waarde van de door het eigendomsvoorbehoud omvatte goederen de vordering van Plieger B.V. met meer dan 30% overtreft, zijn wij verplicht op verzoek van de koper ten belope van dit meerdere deel de eigendom aan de koper over te dragen.
- 13.6 Indien de koper met de nakoming van zijn betalingsverplichtingen jegens Plieger B.V. tekort schiet of Plieger B.V. goede grond geeft te vrezen dat hij in die verplichtingen zal tekortschieten, is Plieger B.V. gerechtigd de onder eigendomsvoorbehoud afgeleverde zaken terug te nemen.
- 13.7 De koper is gehouden de onder eigendomsvoorbehoud afgeleverde zaken met de nodige zorgvuldigheid en als herkenbaar eigendom van Plieger B.V. te bewaren. De koper is verplicht, de zaken voor de duur van de voorbehouden eigendom tegen brand-, ontploffing- en waterschade alsmede tegen diefstal te verzekeren en de polis van deze verzekeringen aan Plieger B.V. op eerste aanzegging ter inzage te geven. Alle aanspraken van de koper op de verzekeraars van de zaken uit hoofde van genoemde verzekeringen zullen, zodra Plieger B.V. te kennen geeft dit te wensen, door de koper aan haar worden verpand op de wijze, aangegeven in art. 3:239 BW, tot meerdere zekerheid van de vorderingen van Plieger B.V. tegen de koper.
- 13.8 Het is de koper toegestaan, de onder eigendomsvoorbehoud afgeleverde zaken in het kader van de normale uitoefening van zijn bedrijf aan derden te verkopen en te verkopen en over te dragen.
- 13.9 De koper verbindt zich, vorderingen die hij tegen zijn afnemers verkrijgt niet aan derden te cederen of te verpanden zonder voorafgaande schriftelijke toestemming van Plieger B.V. De koper verbindt zich verder bedoelde vorderingen, zodra Plieger B.V. de wens daartoe te kennen geeft, aan haar te verpanden op de wijze aangegeven in art. 3:239 BW, tot meerdere zekerheid van haar vorderingen uit welke hoofde dan ook tegen de koper.

Opisbaarheid van vorderingen

14. In geval van nietbetaling van een opisbaar bedrag, schorsing van betaling, aanvraag tot surseance of faillissement, liquidatie van zaken van de koper, overlijden van de koper, liquidatie, ontbinding of beëindiging van de kopende vennootschap, alsmede indien koper niet voldoet aan de op grond van artikel 1 lid 2 gevorderde zekerheidsstelling, zullen wij het recht hebben de order of dat gedeelte daarvan dat nog moet worden geleverd, te annuleren en het geleverde als onze eigendom terug te vorderen, onder verrekening van het reeds aan ons betaalde, doch onverminderd onze rechten op vergoeding van verlies en schade; in de omschreven gevallen is elke vordering ineens en dadelijk opisbaar.

Reklames

15. Reklames dienen ons, vergezeld van onze pakbrieven, binnen 14 dagen na verzending van de goederen per aangetekend schrijven te bereiken. Het bewijs van tijdige reclame rust op de koper. Op de koper rust voorts de bewijslast, dat de goederen, waarvoor wordt gereklameerd, door ons geleverde goederen zijn en in dezelfde toestand verkeren als bij het verlaten van ons magazijn of de fabriek van onze leveranciers. Alleen goederen die ingevolge onze opdracht - na gegrond bevonden reclame - retourgezonden zijn, worden door ons gekrediteerd. De terugzending is voor rekening en risico van de koper. Bij een door de koper bewezen gegronde reclame kunnen wij te onze keuze de onderdelen of artikelen waarop de reclame betrekking heeft, vervangen of aan de koper vergoeden, met uitsluiting van elk (ander) recht van de koper op schadevergoeding. Niet afgehaalde of zich om enigerlei andere reden gedurende één maand in onze magazijnen bevindende verkochte goederen worden na afloop van deze maand bij onze voorraad gevoegd zonder dat terzake enig recht tegen ons geldend kan worden gemaakt. Reklames uitsluitend kenbaar gemaakt aan onze vertegenwoordigers of bij één onzer filialen, binden ons niet tenzij de koper binnen veertien dagen na melding van de klacht van ons de schriftelijke bevestiging heeft ontvangen dat wij de reclame in behandeling hebben genomen. Een reclame kan geen invloed uitoefenen op afdoening en betaling van de betreffende, reeds gedane of nog te geschieden leveringen.

Betaling

16. Behoudens andersluidende afspraak moet de betaling tegen aflevering der goederen geschieden zonder aftrek van enige korting of verzekering, tenzij schriftelijk anderszins overeengekomen. De koper zal in verzuim zijn het enkele verstrijken van de overeengekomen of op de faktuur vermelde betalingstermijn. In geen betalingstermijn vermeld, zo geldt een termijn van dertig dagen na faktuurdatum; ingebrekestelling is niet vereist. Kopers zijn aan ons verschuldigd de op elke faktuur vermelde kredietbeperkings toeslag, tenzij door ons binnen de op de faktuur hiervoor aangegeven termijn betaling van het faktuurbedrag is ontvangen. Als datum van betaling geldt de dag waarop de betaling in onze kas is gestort, resp. wij van de bank of girodienst de bevestiging van de ontvangst van de betaling hebben ontvangen. Het tijdstip van geven van de betalingsopdracht door de koper of van uitvoering door diens bank of girodienst is hiervoor niet bepalend. Bij betaling ná aflevering moet deze te onze kantore geschieden.

Rente en kosten

17. De debiteur, die in verzuim is, is vanaf de dag, waarop de betaling uiterlijk had moeten plaatsvinden, aan ons een rente verschuldigd van 1% per maand of een gedeelte van een maand. Alle kosten, zowel gerechtelijke als buitengerechtelijke, door ons te maken om tot inning van het faktuurbedrag te geraken, komen ten laste van de nalatige debiteur. Gerechtelijke kosten zijn de door de rechter te liquideren proceskosten. Buitengerechtelijke kosten zijn alle kosten die ons in rekening worden gebracht door onze advocaten, procureurs, deurwaarders en ieder ander van wie wij ons bedienen voor de invordering van een faktuurbedrag. Deze bedragen zijn door een debiteur verschuldigd tot de hoogte zoals door ons erkend. De buitengerechtelijke invorderingskosten worden berekend conform het incassotarief als geadviseerd door de Nederlandse Orde van Advocaten. Bij faillissementsaanvraag van de koper is deze ook bij betaling van hoofdsom, rente en invorderingskosten, de kosten der faillissementsaanvraag verschuldigd.

Bevoegde rechter

18. Op alle transacties zal het Nederlands recht van toepassing zijn. Alle geschillen (Kort Gedingen en verlot tot beslaglegging daaronder begrepen) welke tussen partijen mochten ontstaan, zullen bij uitsluiting bevoegd worden door de Arrondissementsrechtbank te Amsterdam, voor zover zij tot de competentie van de Rechtbank behoren en de Wet niet bij regels van dwingend recht een andere Rechtbank daarvoor bevoegd verklaard heeft.

Verbindendheid

- 19.1 Onze Algemene Verkoops- en Betalingsvoorwaarden gelden voor alle koopovereenkomsten. Door de bestelling wordt de koper geacht daarmee akkoord te gaan. Afwijkingen van deze voorwaarden zijn alleen bindend, wanneer ze schriftelijk door ons zijn geaccepteerd. Wanneer door ons aldus bijzondere voorwaarden zijn geaccepteerd, blijven voor het overige onze Algemene Verkoops- en Betalingsvoorwaarden hun geldigheid behouden. Eventuele (algemene) voorwaarden van onze koper, waarnaar door middel van opdruk of verwijzing in drukwerk en/of correspondentie wordt verwezen, verbinden ons desondanks alleen, indien de koper zich vóór totstandkoming der overeenkomst met ons uitdrukkelijk op zijn (algemene) voorwaarden heeft beroepen, en ook in dat geval alleen voor zover die voorwaarden ten opzichte van onze voorwaarden tegenstrijdige bepalingen bevatten. In alle andere gevallen gaan onze Algemene Verkoops- en Betalingsvoorwaarden voor.
- 19.2 Onze afnemers verplichten zich onze artikelen slechts onder de in dit artikel en de in artikel 17 en 18 genoemde voorwaarden door te verkopen en bij die doorverkoop als voorwaarde te stellen, dat elke volgende afnemer op zijn beurt verplicht zal worden en zijn, deze voorwaarden bij verdere leveringen te bedingen. Onze afnemers en elke volgende afnemer verplichten zich jegens ons deze voorwaarden nauwgezet na te leven.

Boete

20. Aan ons dient voor iedere door ons geconstateerde overtreding of niet strikte naleving van deze leveringsvoorwaarden een boete te worden betaald groot € 115,-, onverminderd ons recht daarnaast volledige vergoeding van onze schade te vorderen.

Deze algemene voorwaarden zijn laatstelijk gewijzigd en gedeponneerd op 1 april 1992.

ALGEMENE VERKOOP- EN LEVERINGSVOORWAARDEN VAN THERMONOORD BV

Algemeen

- 1.1. Waar hierna van "VERKOPER" wordt gesproken, wordt ThermoNoord BV verstaan, in welke hoedanigheid ook. Waar hierna van "KOPER" wordt gesproken, wordt hieronder verstaan de aspirant-koper, aspirant-opdrachtgever en in het algemeen de wederpartij van verkoper.
- 1.2. Deze voorwaarden zijn van toepassing op alle overeenkomsten van verkoper, waarbij verkoper zich verbindt zaken en/of diensten te leveren.
- 1.3. Eventuele inkoop- of andere voorwaarden, waarvan koper zich bedient, verbinden verkoper niet, dan indien en voorzover deze door verkoper uitdrukkelijk schriftelijk zijn aanvaard.
- 1.4. Handelstermen, gebruikt in offertes, orderbevestigingen of anderszins, dienen te worden uitgelegd overeenkomstig de Internationale Regelen voor de Uitleg van Handelstermen, vervaardigd door de Internationale Kamer van Koophandel (ICC Incoterms) zoals deze van kracht zijn ten tijde van het sluiten van de overeenkomst, een en ander voor zover daarvan bij onderhavige algemene voorwaarden niet is afgeweken.

Overeenkomst

- 2.1. Offertes, prijscouranten en overige mededelingen van verkoper binden verkoper niet. Overeenkomsten met koper komen eerst tot stand na schriftelijke bevestiging door verkoper daarvan.
- 2.2. Bij verschil tussen de bestelling van koper en de schriftelijke bevestiging van verkoper is uitsluitend verkopers bevestiging verbindend.
- 2.3. Indien mondeling (waaronder telefonisch) bij één van de medewerkers van verkoper besteld is, geldt de bestelling eerst dan als door verkoper aanvaard en komt de overeenkomst tot stand, indien verkoper koper niet binnen een na te melden termijn heeft doen weten de bestelling niet, of niet geheel conform de bestelling, te aanvaarden:
 - a. bij levering uit voorraad: binnen tien werkdagen na de bestelling ;
 - b. bij levering niet vallende onder a.: binnen vier weken na de bestelling.Handelstermen, gebruikt in offertes, orderbevestigingen of anderszins, dienen te worden uitgelegd overeenkomstig de Internationale Regelen voor de Uitleg van Handelstermen, vervaardigd door de Internationale Kamer van Koophandel (ICC Incoterms) zoals deze van kracht zijn ten tijde van het sluiten van de overeenkomst, een en ander voor zover daarvan bij onderhavige algemene voorwaarden niet is afgeweken.
- 2.4. Verkoper is bevoegd, indien naar zijn redelijk oordeel de financiële toestand van koper daartoe aanleiding geeft, vooruitbetaling of zekerheid te verlangen en in afwachting daarvan de gehele of gedeeltelijke uitvoering van de overeenkomst op te schorten. Indien voornoemde vooruitbetaling uitblijft of onvoldoende zekerheid wordt verschaft, is verkoper gerechtigd de overeenkomst door een enkele schriftelijke verklaring en zonder rechterlijke tussenkomst te ontbinden, onverminderd verkopers recht op schadevergoeding, indien daartoe termen zijn, en zonder dat koper enige aanspraak op schadevergoeding kan doen gelden.
- 2.5. Indien tengevolge van overmacht van verkoper redelijkerwijs niet verwacht kan worden dat hij zijn leveringsverplichting nakomt, is deze gerechtigd de levering op te schorten. Mocht de overmacht langer dan twee maanden duren, dan zijn beide partijen gerechtigd de overeenkomst met betrekking tot de zaken welke ingevolge voornoemde overmacht niet geleverd kunnen worden, door een enkele schriftelijke verklaring te ontbinden. Onder overmacht is steeds begrepen :
 - a. bedrijfsstoornis of bedrijfssonderbreking van welke aard dan ook en onverschillig op welke wijze ontstaan;
 - b. vertraagde of te late levering door een of meer leveranciers van verkoper;
 - c. vervoersmoeilijkheden of vervoersbelemmeringen van welke aard dan ook, waardoor het vervoer naar of van het bedrijf van verkoper wordt bemoeilijkt of belemmerd;
 - d. import- en exportbeperkingen van welke aard dan ook.
- 2.6. Alle aanvullingen, wijzigingen en nadere afspraken inzake de overeenkomst gelden alleen indien deze schriftelijk zijn overeengekomen.
- 2.7. De zaken worden verkocht en geleverd met inachtneming van de gangbare toleranties voor afmetingen, hoeveelheden en gewichten, tenzij uitdrukkelijk anders overeengekomen.
- 2.8. Voor fouten in afbeeldingen, maten, gewichten, kwaliteiten en/of prijs(couranten) is verkoper niet aansprakelijk.
- 2.9. Door verkoper opgegeven prijzen zijn richtprijzen en kunnen tot aan datum van levering gewijzigd worden ingevolge wijziging in fabrieksprijzen, wisselkoersen, invoerrechten en daarmee gelijk gestelde heffingen, verzekeringstarieven, vrachten, belastingen, margeregelingen en andere dergelijke factoren.

Levertijd

- 3.1. De overeengekomen levertijden zijn steeds benaderend
- 3.2. Onverminderd het bepaalde onder art. 2 sub 5 en ook buiten het geval van overmacht, geeft verschijding van voornoemde levertijd koper geen recht op ontbinding van de overeenkomst en/of schadevergoeding, tenzij koper opzet of grove schuld van verkoper bewijst.

Garantie, Reclame en Aansprakelijkheid

- 4.1. Koper dient dadelijk na levering te controleren of het geleverde afwijkt van hetgeen werd gekocht. Eventuele reclames moeten schriftelijk bij verkoper worden ingediend binnen tien werkdagen na leveringsdatum. Na het verstrijken van vorenbedoelde termijn geldt het geleverde als onherroepelijk en onvoorwaardelijk door koper aanvaard. Eventuele rechtsvorderingen dienen op straffe van verval uiterlijk één jaar na tijdige reclamemelding aanhangig te zijn gemaakt.
- 4.2. Kwaliteitseisen of kwaliteitsnormen van door verkoper te leveren zaken moeten uitdrukkelijk zijn overeengekomen. Deze voorwaarden zijn van toepassing op alle overeenkomsten van verkoper, waarbij verkoper zich verbindt zaken en/of diensten te leveren.
- 4.3. De garantieverplichting van verkoper strekt zich nimmer verder uit dan tot de uitdrukkelijk gemaakte kwaliteitsbedingen of uitdrukkelijk overeengekomen kwaliteitsnormen.
- 4.4. Indien de reclame van koper met inachtneming van het hierboven bepaalde, gegrond is, heeft koper de keuze tussen herlevering of - voor zover verkoper daarin ondanks deugdelijke schriftelijke ingebrekestelling van de koper toerekenbaar tekort schiet - gehele c.q. gedeeltelijke ontbinding van de overeenkomst. De koper dient de gebrekkige zaken ter beschikking van verkoper te houden.
- 4.5. De eventuele garantie van verkoper geldt niet, indien:
 - a. en zolang de koper jegens verkoper in verzuim is ;
 - b. de zaken aan abnormale omstandigheden zijn blootgesteld, dan wel onzorgvuldig of ondeskundig zijn behandeld;
 - c. de zaken langer dan normaal zijn opgeslagen en het aannemelijk is dat daardoor kwaliteitsverlies is opgetreden;
- 4.6. Verkoper garandeert niet en wordt nimmer geacht gegarandeerd te hebben of er voor in te staan dat het gekochte geschikt is voor het doel waarvoor koper het wenst te bewerken, verwerken, doen gebruiken of gebruiken. Monsters worden slechts bij wijze van aanduiding verstrekt.

- 4.7. Indien deze overeenkomst zaken betreft die verkoper van derden betreft of betrokken heeft, is verkopers verantwoordelijkheid en/of aansprakelijkheid beperkt tot datgene waarvoor verkopers leverancier jegens verkoper verantwoordelijk en/of aansprakelijk is. Deze bepaling vindt alleen toepassing voorzover die toepassing voor koper gunstiger is dan toepassing van het onder 4.4 en 4.6. bepaalde.
- 4.8. Behoudens wat betreft de in dit artikel bedoelde eventuele garantieverplichting, is resp. zijn verkoper, noch medewerker(s) van verkoper, noch door verkoper ingeschakelde derden, ooit, uit welke hoofde dan ook, aansprakelijk voor enige schade aan de koper of enige derde met betrekking tot enige leveringsverplichting, het afleveren van zaken, de geleverde zaken zelf of het gebruik daarvan, dan wel van enige eventuele werkzaamheden of adviezen.
- 4.9. Zaken kunnen slechts door koper worden geretourneerd nadat hierover met verkoper overeenstemming is bereikt. In geen ander geval zullen zaken retour worden genomen. Daarbij gelden overigens de volgende restricties en voorwaarden:
 - a. de zaken dienen zich in oorspronkelijke staat en in originele verpakking te bevinden;
 - b. na datum van a. evering mag niet meer dan 8 dagen zijn verstreken en
 - c. de zaken behoren tot het voorraad assortiment van verkoper, hetgeen betekent dat speciaal voor koper bestelde zaken in geen geval retour worden genomen.
- 4.10. Verkoper behoudt zich het recht voor om aan koper crediteringskosten door te belasten. Verkoper verleent garantie ingeval van gebreken en fabricagefouten in de door verkoper geleverde goederen en apparatuur, voor zover de betrokken fabrikant de garantie verleent aan verkoper, tenzij tussen koper en verkoper uitdrukkelijk schriftelijk anders is overeengekomen.
- 4.11. De garantie bestaat uitsluitend daarin dat verkoper kosteloos de vervangende onderdelen aan koper ter beschikking zal stellen. Het demonteren van defecte onderdelen en het vervangen daarvan door nieuwe onderdelen, inclusief de kosten van hulpmiddelen en inzet van derden, is voor rekening en risico van koper, tenzij uitdrukkelijk schriftelijk anders overeengekomen

Vervoer

- 5.1. Indien de zaken, ongeacht de overeengekomen wijze van vervoer, ter afname voor koper gereed staan en verkoper zulks aan koper heeft medegedeeld, is koper terstond tot afname verplicht. Niet nakoming van deze verplichting geeft verkoper het recht de zaken voor rekening en risico van koper op te slaan, respectievelijk opgeslagen te houden en aan koper te factureren zonder dat daarna betaling kan worden geweigerd omdat nog niet werd geleverd.
- 5.2. De koper is verplicht, zodra het vervoermiddel bij hem is aangekomen tot de snelst mogelijke lossing verplicht. Bij niet nakoming van deze verplichting is het onder 5.1. bepaalde van overeenkomstige toepassing.
- 5.3. Het vervoermiddel is ter keuze van verkoper, zonder dat de gemaakte keuze afbraak doet aan het bepaalde onder art. 2 sub 5
- 5.4. Door verkoper te leveren zaken reizen voor rekening en voor risico van verkoper, tenzij uitdrukkelijk anders is overeengekomen.
- 5.5. Verkoper behoudt zich het recht voor, na mededeling vooraf door verkoper om voor opdrachten voor levering van zaken met een door verkoper vast te stellen netto orderwaarde exclusief BTW vrachtkosten en/of eventuele administratieve kosten in rekening te brengen. Deze kosten worden niet berekend voor goederen die tegen contante betaling worden afgehaald.

Betaling

- 6.1. Elke betaling moet geschieden binnen dertig dagen na levering, netto contant en zonder dat koper recht heeft op enige niet uitdrukkelijk overeengekomen korting of verrekening. Afwijkende betalingsregelingen dienen schriftelijk te worden overeengekomen. De koper is verplicht, zodra het vervoermiddel bij hem is aangekomen tot de snelst mogelijke lossing verplicht. Bij niet nakoming van deze verplichting is het onder 5.1. bepaalde van overeenkomstige toepassing.
- 6.2. Koper wordt geacht in gebreke te zijn met de betaling zonder dat sommatie of ingebrekestelling vereist zal zijn, na het verstrijken van de sub 1 bedoelde termijn indien geen volledige betaling in die termijn heeft plaatsgevonden, dan wel indien voorlopige surséance van betaling of faillissement of (buitengerechtelijke-) schuldsaneringsregeling is aangevraagd c.q. is uitgesproken.
- 6.3. In het geval bedoeld in het voorgaande lid, is koper aan verkoper tot de dag der voldoening rente verschuldigd over hetgeen onbetaald is gebleven, naar een rentevoet van 3 % boven de in Nederland geldende wettelijke rente. Indien verkoper in verband met niet-tijdige betaling (buitengerechtelijke maatregelen dient te nemen, komen alle daaruit voortvloeiende kosten voor rekening van koper.
- 6.4. Verkoper is gerechtigd om - ongeacht afwijkende voorschriften of betalingen - alle betalingen in een door verkoper te kiezen volgorde in mindering te doen strekken op hetgeen koper uit hoofde van leveringen, rente en/of kosten aan verkoper verschuldigd is.

Eigendomsvoorbehoud

- 7.1. Alle geleverde zaken blijven bij uitsluiting eigendom van verkoper tot aan het moment waarop koper aan alle verplichtingen - voortvloeiende uit of samenhangend met overeenkomsten waarbij verkoper zich tot levering heeft verplicht - voldaan heeft. Tot dat tijdstip is koper gehouden de door verkoper geleverde zaken gescheiden van andere zaken en duidelijk geïdentificeerd als verkopers eigendom te bewaren. Het eigendomsvoorbehoud laat het recht van koper om binnen de normale uitoefening van zijn bedrijf de zaken aan afnemers te verkopen alsmede zijn recht om de zaken te verwerken, onverlet, zolang verkoper geen gebruik maakt van zijn recht deze rechten van koper op te zeggen wegens niet-nakoming door koper van zijn verplichtingen jegens verkoper.

Geschillen en geldigheid van de voorwaarden

- 8.1. Voor alle overeenkomsten van verkoper geldt het Nederlandse recht. Voor zover deze Algemene verkoop- en leveringsvoorwaarden ook zijn opgemaakt in een andere taal dan de Nederlandse, is de Nederlandse tekst bij geschillen steeds beslissend.
- 8.2. Alle geschillen welke tussen partijen mochten ontstaan, zullen bij uitsluiting berecht worden door de in Nederland bevoegde rechter binnen wiens rechtsgebied de vestigingsplaats van verkoper is gelegen tenzij de wet bij regels van dwingend recht een andere rechter bevoegd heeft verklaard.
- 8.3. De vernietiging en/ of de nietigheid van enige bepaling van deze voorwaarden laat de geldigheid van de overige bepalingen van deze voorwaarden onverlet.

Dagtekening

Gorredijk, 1 december 2001

Hiermee vervallen alle voorgaande Algemene verkoop- en leveringsvoorwaarden van Technische Groothandel ThermoNoord BV.